



AMSTERDAM, NEW YORK PUBLIC SAFETY BUILDING, BY FEIBES AND SCHMITT  
NATHAN MARSH PUSEY LIBRARY AT HARVARD, BY HUGH STUBBINS AND ASSOCIATES  
THREE INTERIORS BY GWATHMEY-SIEGEL  
STANLEY TIGERMAN'S EXPLORATION OF NEW SHAPES FOR SPACES  
BUILDING TYPES STUDY: PUBLIC ADMINISTRATION BUILDINGS  
FULL CONTENTS ON PAGES 10 AND 11

# ARCHITECTURAL RECORD



# When you want a ceiling system that gives your ingenuity full rein, come to the source. Armstrong.

More architects use Armstrong Luminaire Ceiling Systems because what they get is more than just a ceiling.

They get flexibility. Flexibility that translates into the kind of freedom they need to carry out their most innovative ideas. The kind of freedom that makes it relatively simple to design, specify, control, coordinate, and install a dramatic ceiling in any building. Like the four striking solutions shown on these pages.

What you get with Luminaire is truly a system. A system that combines lighting, air diffusion, fire protection, and acoustical control in one integrated assembly. But what you also get is versatility. Versatility that allows you to handle these functions



Midland College, Midland, Texas, Architect: Preston M. Geren Architect & Engineer and Associates, Fort Worth, Texas. Ceiling System: Armstrong Symmetry Luminaire

in many different ways.

There are five Luminaire Ceiling Systems: C-60/30, C-60/60, AW 3600, Symmetry and Pentaflex™. Each is basically scaled to a 5'-square module but is also available in custom variations to meet just about any requirement.

Each can offer you not only a choice of lighting patterns and a wide range of illumination but a flexibility of module, troffer and panel arrangement that



Datacenter/The Equitable Life Assurance Society of the United States, Easton, Pennsylvania, Architects: Kahn and Jacobs, New York City, Ceiling System: Armstrong C-60/60 Luminaire





National Bank, San Antonio, Texas, Architects: Environmental Professionals Corporation, San Antonio, Texas, Ceiling System: Armstrong AW 3600 Luminaire

results in almost unlimited design possibilities.

For instance, you can choose from three vaulted systems as well as two flat-type systems that provide either exposed or concealed grids. You can vault your entire ceiling or mix your vaults with flat types. You can light all the vaults or space your lighting to meet specific requirements of the job. Within a vaulted system like the C-60/60, you can even choose various light options — including square light fixtures 2' x 2', 2½' x 2½', 3' x 3', or rectangular fixtures 1' x 4' and 2' x 4'. All of which adds up to a freedom of choice you'd be hard put to match.

Also available from Armstrong, of course, is the Armstrong man — bringing you technical assistance that can help put your entire design into focus.

Add this kind of people support to the most advanced lighting materials available, and you can see why Armstrong Luminaire provides you with the aesthetic and performance characteristics you require in any building environment that bears your name and displays your talent.

To learn more, write: Armstrong, 4201 Rock St., Lancaster, Pa. 17604.

In Canada, write: Armstrong Cork Canada, P.O. Box 919, Montreal 101, Quebec.



Palmyra Area High School, Palmyra, Pennsylvania, Architects: Lawrie and Green, Harrisburg, Pennsylvania, Ceiling System: Armstrong C-60/30 Luminaire

For more data, circle 1 on inquiry card



**Introducing the Registron™ Series from Armstrong. Three beautifully sculptured ceilings designed to make the grid become part of the pattern.**



The standard lay-in ceiling has two things going for it...economy and accessibility in a suspended grid system. However, because the grid is exposed, the ceiling's design is interrupted and its aesthetic appeal diminished. Now, with the new Registron Series, Armstrong has come up with an ingenious solution.

Since there's no way to eliminate the grid, we've found a way to eliminate its visual impact. And the way we've done it is to purposely design the grid as part of the ceiling's surface pattern. So

when Registron's 2' x 4' mineral-fiber acoustical panels are installed, what you end up with is a ceiling in which the grid blends with the design to provide a virtually monolithic look.

There are three designs available in the Registron Series, all manufactured to carefully register the embossed designs and to beautifully conceal the acoustical perforations.

**Textured Squares** employs a 12" x 12" tilelike module and features embossed radiused



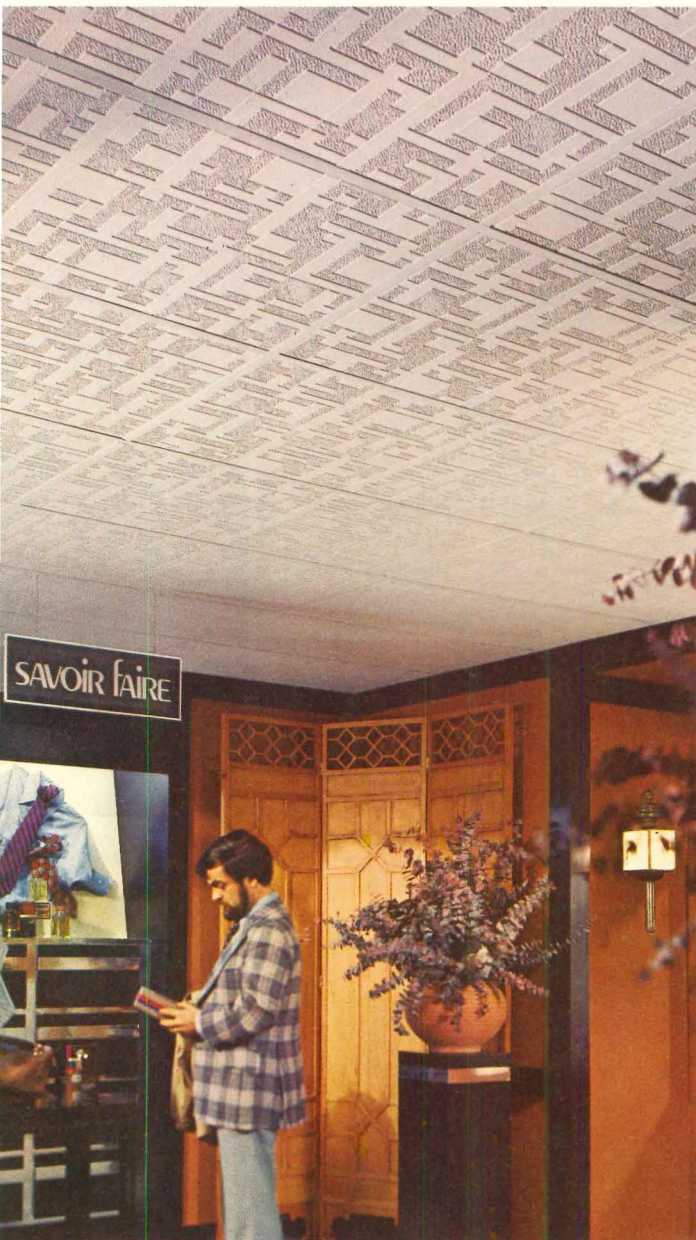

ners as well as one-inch-wide grid-shaped  
 ements incorporated into the surface design to  
 imize the impact of the grid system.

In the geometric design of **Grid Shapes**,  
 2' x 4' scale of the panel has been reduced to a  
 nt where there is no recognizable module left.  
 h its inch-wide grid shapes combined in an  
 rral weave pattern, the result is a sweeping flow  
 ure design.



**Circles 'n Squares** features eighteen circles within smooth-surfaced squares in each 2' x 4' ceiling panel. The one-inch-wide embossed border effectively blends in the grid and disguises sprinkler heads, lighting fixtures, and speakers.

If you're building or designing on a budget, we think you'll find that our new sculptured Registron Series offers you an uninterrupted low-cost lay-in ceiling without a low-cost look. Write Armstrong, 4206 Rock Street, Lancaster, Pennsylvania 17604.

*For more data, circle 2 on inquiry card*

FROM THE  INDOOR WORLD® OF  
**Armstrong**



## Letters to the editor

I heartily applaud your editorial in the July 1976 issue of ARCHITECTURAL RECORD concerning "family architects." This is a concept which rates an advertising campaign by the AIA at least equal in scope to the one mounted to make the business community more architect-aware. With so many architects in straitened circumstances and willing to earn money in ways they would not have considered a few years ago, now is an ideal time for the general public to be made aware that architects can be rented by the hour (usually at rates lower than those of lawyers and psychiatrists). A few hours of consultation with an imaginatively analytical architect can yield a variety of alternative avenues of approach to a problem, some of which can often lead to surprisingly non-architectural solutions. Architects should be geared to offering such consultation services for a fee instead of giving them free and utilizing the time to sell project services. If he is working on a consultation-fee basis, the professional-in-name is more likely to be a professional-in-fact so far as the quality and impartiality of his advice is concerned.

Andrew Alpern, AIA  
New York, New York

Your editorial in the July issue is realistic, refreshing, and regenerative. While I don't feel the title is quite right, it points out a need for greater exposure of our profession—that architecture should become a household word, and that all people should be made aware of all potential contributions by architects.

We are a small firm interested in, and enthusiastic about, the small stuff. We strongly feel this kind of market can be reopened to us through a commitment toward significant public relations and discretionary advertising by the profession. We hope you will continue this fine kind of editorial writing. Perhaps it would be timely for next year's AIA convention.

John J. Serke, AIA  
J/D Serke Associates  
Havertown, Pennsylvania

I enjoyed your editorial July "Family Architects." It is a fine reminder for young firms, as we have all gone through this stage. As a matter of fact, if a firm, no matter how large or well known, does not continue to offer this service, our profession is really not serving our clients as it should. I know our firm still does.

We just finished a design for an

"A" frame children's playhouse and recently completed an organic Texas ranch house in, of all places, Big Hill, in Central Texas near Groesbeck.

Fortunately we've recently been assigned sizable new commissions to augment our "family" practice!

Karl Kamrath, FAIA  
MacKie and Kamrath Architects  
Houston, Texas

I recently read your editorial on "Family Architects" and find that you have expressed several thoughts and ideas that I myself have felt.

Many architects ignore the type of service you speak about primarily because it does not pay enough and probably because it does not have enough glamour.

I have found that if the service performed is simplified into advice and sketches or drawings that fit the need of the client, then the fees (understandably low) that you can expect, will be close to what the work effort will be.

Architects by ignoring this type of work also then feed the cycle of potential clients not knowing what architects do nor why they could possibly have need of an architect's service. Architects' active participation in everyday community affairs and problems is essential to the community's well being in areas of planning, recreation, education, rehabilitation and new construction. In serving as a so-called "family architect" to a community, an architect becomes actively involved.

Thanks for your editorial. I hope more of us will heed the call.

John M. Scarlata, AIA  
Glen Grove, New York

Louis Sauer once said, as my memory recalls, "... as long as there are small buildings there must be small architects..." Lest we "littl'uns" fear the "big'uns" (SOM, CRS, TAC, etc.) we can all take notice of the fact that there are many garages in the world... If building costs continue to soar—the "garage remodel" must become a new wave of architecture...

Your "family architect" editorial seems to be good common sense with more impact than you realize—once people begin to trust you with designs for their old garages and understand you can solve problems that will help the lives of their dogs, cats, children, etc.—once they trust you at their home, then they will trust you with larger work which will ultimately produce a far stronger profession. Let's hear it for the small architect.

Joe Stubblefield, AIA  
San Antonio, Texas

## Calendar

### SEPTEMBER

**16-17** National Fire Protection Association (NFPA) Life Safety Code seminar, Philadelphia; Holiday Inn-Airport S., Essington, Pa. Contact: NFPA Seminar Registrar, 470 Atlantic Ave., Boston, Mass. 02210.

**20-24** 9th Annual National Conference of States on Building Codes and Standards, Cranston Hilton, 1150 Narragansett Blvd., Providence, R.I. Contact: Sandra A. Berry, 301/921-3146.

**14-October 22** Exhibit, a gift from the Italian government, *Palladio in America*, hosted by the University of Pennsylvania; First National Bank of the U.S., Philadelphia. Contact: Jane Wilson, 215/243-8721.

### OCTOBER

**1** Last day of submissions for Record Interiors. (For details, see page 198).

**1-3** Anglo-American preservation conference, "Looking Forward to the Past... while preserving for the future." Sponsored by The Royal Oak Foundation, Inc., and Preservation of Historic Winchester, Inc., with the National Trust of England, Wales and Northern Ireland and the National Trust for Historic Preservation, Winchester, Va. Contact: The Royal Oak Foundation, Inc., 41 E. 72 St., New York, N.Y. 10021.

**17-20** Prestressed Concrete Institute (PCI), annual convention. Americana Hotel, Miami Beach, Fla. Contact: Gale M. Spowers, Prestressed Concrete Institute, 20 N. Wacker Dr., Chicago, Ill. 60606.

**18-19** The Society for Marketing Professional Services advanced marketing seminar, Sheraton Denver Airport Hotel. Contact: Jon Amos, Baxter-Hodell-Donnelly-Preston, 3500 Red Bank Rd., Cincinnati, Ohio 45227.

**18-19** NFPCA conference, "The Dynamics of Fire Prevention." Hyatt House Hotel, International Airport, Los Angeles. Contact: Peg Maloy, 202/634-7663.

**20, 21, 22** Workshop conference, "Philosophy & Issues in the Design of Play Environments," the University of Wisconsin-Milwaukee, Department of Architecture and Department of Physical Education. Contact: Thomas Spellman, University of Wisconsin-Milwaukee, School of Architecture and Urban Planning, P.O. Box 413, Milwaukee, Wis. 54201, 414/963-5239.

**21-22** IAB International Board for Aquatic, Sports and Recreation Facilities Architectural Congress, Niagara Hilton Convention Center Hotel, and the International Convention Center, Niagara Falls, N.Y.

ARCHITECTURAL RECORD (Continued from page 136)  
with AMERICAN ARCHITECT, ARCHITECTURE and WESTERN ARCHITECTURE AND ENGINEER

September 1976, Vol. 160, No. 4.  
® reg. in U.S. Patent Office copyri  
1976 by McGraw-Hill, Inc. All right  
served. Copyright not claimed on  
cover and editorial four-color separa  
Indexed in Reader's Guide to Period  
Literature, Art Index, Applied Scienc  
Technology Index, Engineering Index  
The Architectural Index. Publ  
monthly except May, August, and  
tober when semi-monthly, by McG  
Hill, Inc.

Quotations on reprints of articles  
able. Every possible effort will be  
to return material submitted for po  
publication (if accompanied by star  
addressed envelope), but the editor  
the corporation will not be responsi  
loss or damage.

EXECUTIVE, EDITORIAL, CIRCULA  
AND ADVERTISING OFFICES: 1221  
eneue of the Americas, New York,  
10020. Other Editorial Offices: 425  
tery Street, San Francisco, Cal. 941  
PUBLICATION OFFICE: 1221 Aven  
the Americas, New York, New  
10020. Second-class postage paid at  
York, New York 10001 and at addi  
mailing offices.

OFFICERS OF MCGRAW-HILL PUB  
TIONS COMPANY: Gordon L. J  
president; Paul F. McPherson, ex  
vice president; Gene W. Simpson,  
vice president; senior vice presi  
Ralph Blackburn, circulation; Joh  
Hoglund, controller; Ralph R. Schul  
itorial; David G. Jensen, manufact  
vice presidents: James E. Boddorf,  
ning and development; Edward  
Schirmer, marketing administration.

CORPORATION OFFICERS: Harol  
McGraw, president, chief execu  
officer and chairman of the board; R  
N. Landes, senior vice president and  
retary, Ralph J. Webb, treasurer.

SUBSCRIPTIONS: Subscriptions sol  
only from architects and engineers.  
tion, firm connection, and type of  
must be indicated on subscription o  
Please allow 4-12 weeks for shipm  
CHANGE OF ADDRESS or shipment  
service letters should be forward  
Fulfillment Manager, ARCHITECT  
RECORD, P.O. Box 430, Hightstown  
08520. Provide old and new addr  
zip code or postal zone number. If  
ble, attach issue address label. A  
subscription prices: U.S., U.S. p  
sions: \$15.00 for architects, enginee  
other individuals in the fields se  
others \$24.00. Canada: \$17 for arch  
engineers and other individuals i  
fields served; others \$26.00. Other  
tries: \$30.00 to architects, engin  
others \$40.00. Single copies \$5.

GUARANTEE: Publisher agrees to r  
that part of subscription price apply  
unfilled part of subscription if serv  
unsatisfactory.

ASSOCIATED SERVICES/McGraw-H  
formation Systems Co.: Sweet's Ca  
Files (Architectural, Light Constr  
Interior Design, Industrial Constr  
Plant Engineering, Canadian  
struction), Dodge Building Cost Ser  
Dodge Reports and Bulle  
Dodge/SCAN Microfilm Systems, D  
Management Control Service, D  
Construction Statistics, Dodge reg  
construction newspapers (Chic  
Denver, Los Angeles, San Francisco

THIS ISSUE is published in nationa  
separate editions. Additional pag  
separate edition numbered or allow  
as follows: Western Section 32-1 th  
32-2. POSTMASTER: PLEASE S  
FORM 3579 TO Fulfillment Mar  
ARCHITECTURAL RECORD, P.O.  
430, Hightstown, N.J. 08520.





# New Highspire Travertone™ from Armstrong. What "first class" was always meant to look like.

It's the newest addition to top-of-the-line architectural ceilings from the manufacturer with the top-of-the-line reputation. Highspire Travertone. The non-combustible mineral-fiber ceiling tile from Armstrong that provides a whole new dictionary of meanings for words like "quality" and "elegance."

Produced by an exclusive process that endows it with a deeper, richer textured surface, Highspire

Travertone gives you the look of luxury any way you look at it. And it's available in 12" x 12" tiles as well as in 24" x 24" tegular-edged units that are installed in an exposed-grid system.

So when first class is the only way to go, Highspire Travertone could well be the only one you'll want to go with. To learn more, write Armstrong, 4207 Rock St., Lancaster, Pa. 17604.



FROM THE  INDOOR WORLD® OF

**Armstrong**



**There's  
a new  
way to  
look at  
Steel  
Pipe...**

**(Structurally)**



## Savings

“We were looking for a way to cut costs, and our studies indicated that steel pipe was the most efficient and economical construction material for the project. This space frame, designed by using the most recent Canadian specifications and standards, weighs 12.3 lbs. per sq. ft. compared to a conventional truss system weighing approximately 18”

— Regis Trudeau & Associates, Inc.

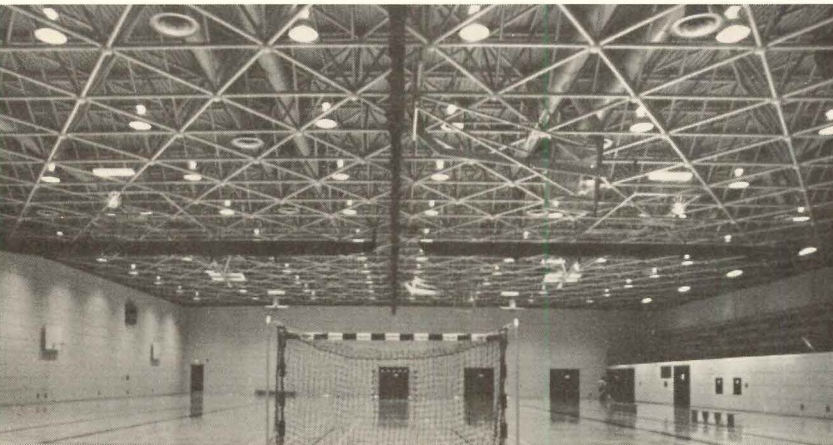

Le Cégep du Vieux, Montreal (College Gymnasium).  
Regis Trudeau & Associates of Montreal –  
Consulting Engineer

## Appeal

“We were looking for a way to create a unique design and, by going to a steel pipe truss system, we developed a trademark for the center. Not only did steel pipe provide a utilitarian solution to a major structural requirement, but it created a dynamic sculpture, representing both the grace and power inherent in the use of steel”

— Architectonics, Inc.



Crossroads Shopping Center, Oklahoma  
City. Architectonics of Dallas – Architects

## Versatility

“One thing we were looking for was a versatile material for the roof structure. In this project, steel pipe could efficiently handle the highly axial loads on the members, and it also enabled us to very simply detail the intersection of numerous components. The result was an economical as well as handsome roof structure, which contributed significantly to the quality of the interior space and the power of the exterior design.”

— Thompson, Ventulett & Stainback, Inc.

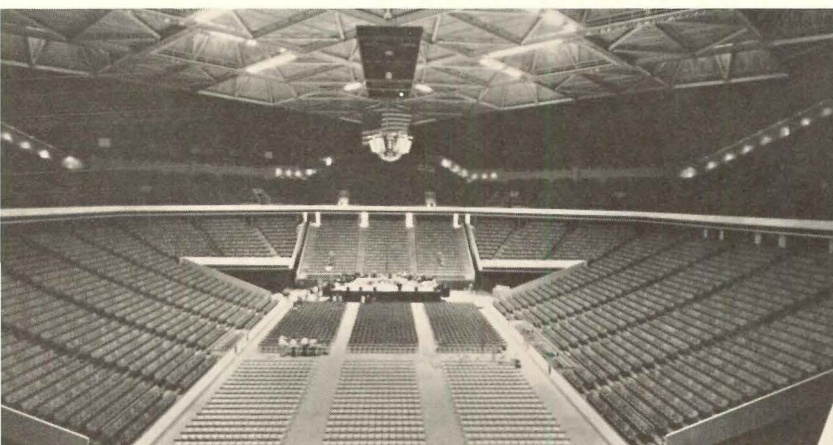

The Omni (Atlanta Arena). Thompson,  
Ventulett & Stainback, Inc. of Atlanta  
— Architects.

Now, we'd like you to take a more in-depth look at steel pipe in structures. Through our "Design Manual for Structural Tubing" (cost: \$2.50), we offer technical information to assist designers in selecting the best structural components for a given design problem. And, through our companion piece "Tentative Criteria for Structural Applications of Steel Tubing and Pipe" (cost: \$2.00), specific Criteria are given for the design of tubular sections used in tension, compression, bending or torsion members. For these important manuals, promptly enclose check and make payable to:



**The Committee of Steel Pipe Producers**  
American Iron and Steel Institute  
1000 16th Street, N.W.  
Washington, D.C. 20036



# Ask company president Karl Schurr...

## Our WATER BASE *Pitt-Glaze*<sup>®</sup> Acrylic-epoxy keeps his plant clean—at a practical cost

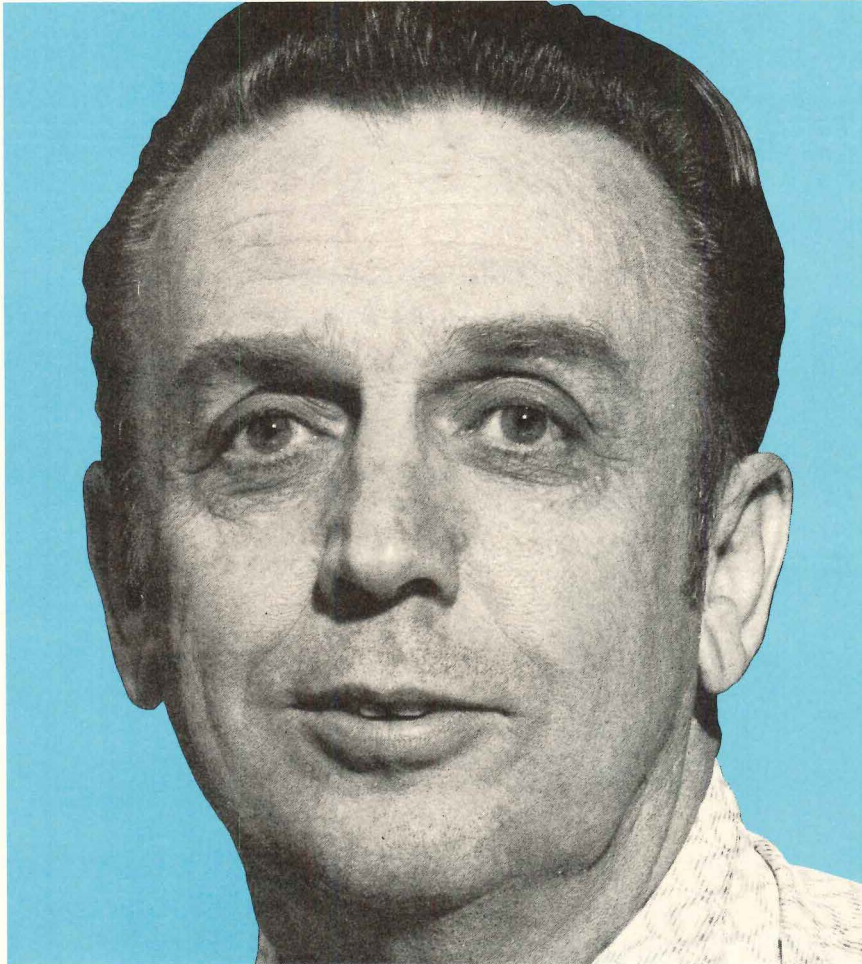

Karl Schurr, President, Minco Products, Inc.  
7300 Commerce Lane, Minneapolis, Minnesota 55432

At Minco Products, Inc., Minneapolis, Minnesota, a clean plant is a necessity for the quality control so vital to the manufacture of Thermofoil heaters, temperature detectors and similar precious metal, fine-wire products. So when Minco completed construction on a recent plant expansion, WATER BASE *Pitt-Glaze* Acrylic-epoxy Coating got the nod for use on all inner wall surfaces.

According to Karl Schurr, "We were looking for something that would give us an easy to keep clean plant at a practical cost. WATER BASE *Pitt-Glaze* Coatings met that requirement. *Pitt-Glaze* Acrylic-epoxy also is impervious to water — another important feature since we use so much water around the plant."

The WATER BASE *Pitt-Glaze* Coating System has other advantages, too. Like low odor during application; stain, acid and alkali resistance; soap and water clean-up. It's tough, durable. Is available in hundreds of colors.

WATER BASE *Pitt-Glaze* Acrylic-epoxy might just be the coating you're looking for, too. For more information write PPG Industries, Inc., One Gateway Center, 3W, Pittsburgh, Pa. 15222.

## PITTSBURGH<sup>®</sup> PAINTS

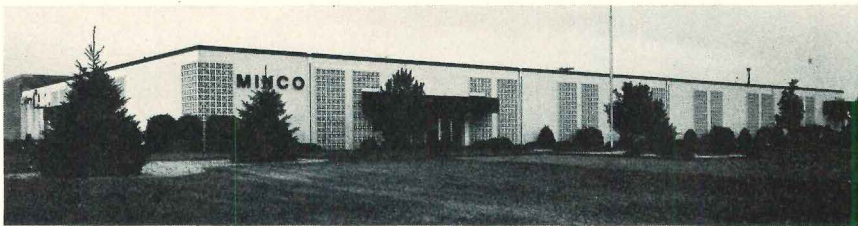

(Below) David and Karl Schurr examine *Pitt-Glaze* Finish with PPG sales representative Jim Olson



Airless spray application of *Pitt-Glaze* Acrylic-epoxy is quick and easy.

PPG: a Concern for the Future



For the name of your nearest PPG sales representative call 800/255-6880 Sweet's Buyline Service.

For more data, circle 5 on inquiry card



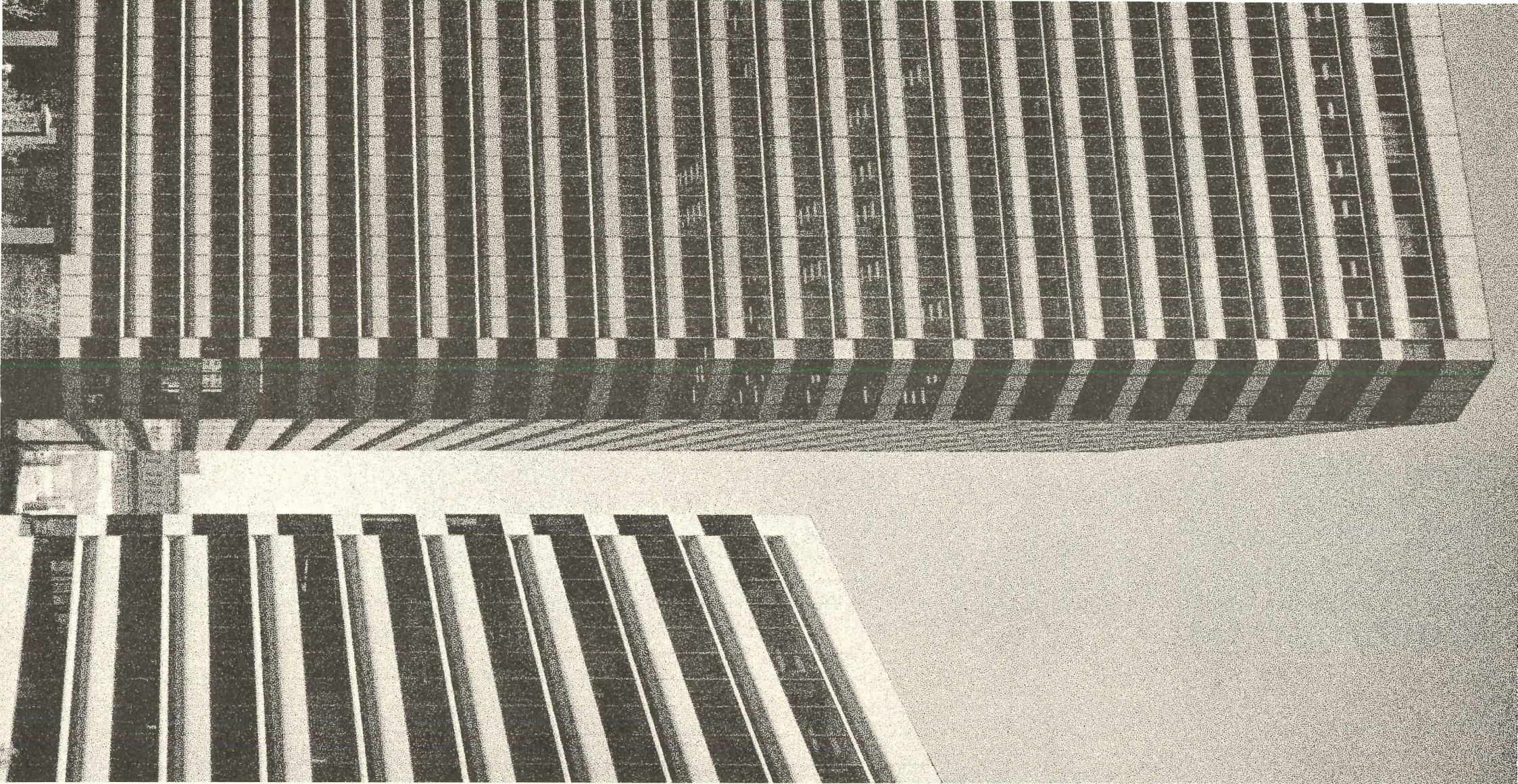

Imaginative building facades in hydroformed metal allow unlimited exploration of the functional and aesthetic potential of form. From small fascias to giant skyscrapers, from remodeling to innovative architectural concepts, the Warnel Metal Division of Forms & Surfaces offers standard panels or engineered systems to meet individual project requirements.

Hydroformed shapes and textures increase strength, reduce weight and cost.

A complete range of metals and finishes are available, including stainless steel, bronze, copper, weathering steel, aluminum and coated galvanized steel.

Forms & Surfaces/Metals 2112 North Chico South El Monte, CA 91733 (213) 283-7234

**FORMS + SURFACES**

Clorox National Headquarters Bldg.  
and Wells Fargo Bank Bldg.  
Oakland, California  
Architect: Gruen Associates



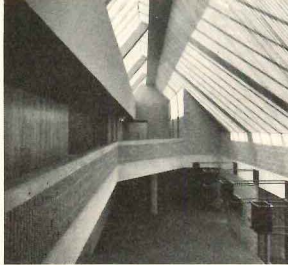

Cover: Amsterdam Public Safety Building  
Amsterdam, New York  
Architects: Feibes and Schmitt  
Photographer: James N. Boorn

EDITOR

WALTER F. WAGNER, JR., AIA

MANAGING EDITOR

HERBERT L. SMITH, JR., AIA

SENIOR EDITORS

ROBERT E. FISCHER  
MILDRED F. SCHMERTZ, AIA

ASSOCIATE EDITORS

GERALD ALLEN  
GRACE M. ANDERSON  
BARCLAY F. GORDON  
CHARLES E. HAMLIN  
CHARLES K. HOYT, AIA  
WILLIAM MARLIN

ASSISTANT EDITOR

JANET NAIRN

PRODUCTION EDITOR

ANNETTE K. NETBURN

DESIGN

ALEX H. STILLANO, Director  
ALBERTO BUCCHIANERI, Associate  
ANNA-MARIA EGGER, Assistant  
MURIEL CUTTRELL, Illustration  
J. DYCK FLEDDERUS, Illustration  
JAN WHITE, Consultant

EDITORIAL CONSULTANTS

EDWARD LARRABEE BARNES, FAIA  
JONATHAN BARNETT, AIA, Urban design  
GEORGE A. CHRISTIE, JR., Economics  
ERNEST MICKEL, Hon. AIA, Washington  
PAUL RUDOLPH, FAIA  
Foreign architecture:  
*L'Architecture d'Aujourd'hui*, Paris

McGRAW-HILL WORLD NEWS

RALPH R. SCHULZ, Director  
9 domestic and 10  
international news bureaus:  
Bonn, Brussels, Buenos Aires,  
London, Milan, Moscow, Paris,  
Singapore, Tokyo, Toronto.

SALES MANAGER

LOUIS F. KUTSCHER

CIRCULATION MANAGER

HUGH S. DONLAN

ASSISTANT TO THE PUBLISHER

ELIZABETH HAYMAN

PUBLISHER

BLAKE HUGHES

**THE RECORD REPORTS**

**13 Editorial**

Three cheers for the AIA for pushing so hard on the energy bill

**4 Letters/calendar**

**33 News in brief**

Short items of major national interest.

**34 News reports**

President Ford signs housing bill. Passage of jobs bill still in doubt. Pennsylvania Avenue project gets funds from Congress. Justice Department attempts to re-open antitrust case against ASCE. Chicago neighborhoods up for landmark status.

**35 Human settlements: world news**

**37 Buildings in the news**

Sesame Plaza, Taipei. Merchants Plaza complex, Indianapolis. Gettysburg College library, Gettysburg, Pennsylvania. Eastman Dental Center, Rochester, New York. Garden Court, National Bank Building, Minneapolis (shown below).



Thoen photography

**43 Required reading**

**198 Submission information for Record Houses and Apartments and Record Interiors for 1977**

**213 Office notes**

**ARCHITECTURAL BUSINESS**

**63 "How-to" books that belong in the A/E's management library**

*Current Techniques in Architectural Practice* and *How to Prepare Professional Design Brochures* are two of the latest—and best—books on the subjects, in the opinion of reviewer Bradford Perkins.

**65 Some pertinent reminders on contracts**

Attorney Charles D. Maurer, Jr., offers some good advice, including an often overlooked basic: always have a contract for design services, even on those small jobs.

**67 Building costs**

Dodge Building Costs Services' figures for September.

**69 Building activity  
The South: cooling off**

Jeanne A. Grifo, senior economist for McGraw-Hill information Systems Company, sees the fast growth of the South tapering into 1980.



**FEATURES**

**Nathan Marsh Pusey Library, Harvard  
Cambridge, Massachusetts**

By partially burying this three-level library underground and covering its roof with grass, architects Hugh Stubbins and Associates have added essential structure while preserving open space.

**Interiors by Gwathmey-Siegel**

- Pearl's Restaurant, New York City
- Vidal Sassoon, Costa Mesa, California
- Unger Apartment, New York City

**Exploration of new shapes for spaces**

A group of projects by Stanley Tigerman shows the ways in which he has been exploring rounded shapes to define new kinds of spaces:

- Private residence in Illinois
- Private residence in Indiana
- St. John's, University of Illinois
- Illinois Regional Library for the Blind and Physically Handicapped
- Ukrainian Institute of Modern Art
- "Zipper" housing, Evanston, Illinois

**Even small banks can express  
a regional vernacular**

- The Redwood Bank, Vallejo, California by architects Smith Barker, Hanssen
- The Bank of Suffolk County, New York by architects Michael Harris Spector and Associates
- Northpark National Bank, Dallas, Texas by architects Omniplan
- The branches of the First National Bank of Albuquerque, New Mexico by architect Antoine Predock

**Functional simplicity  
in design for earthquakes**

In accordance with the Field Act, which outlines the minimum design and construction of all California public schools for earthquake resistance, the Piedmont Junior High School by Chester Bowles replaces an older, outmoded complex.

**BUILDING TYPES STUDY 493**

**127 Public administration buildings**

How well are we designing for the public realm? The question of the quality and efficiency of our public architecture has become a subject of increasing concern to professional architects and to the governmental agencies who commission them and use them. Here is a portfolio of recent successes—focusing on medium-size buildings in medium-size towns, the kind the vast majority of architects are working on.

**128 Belmont Regional Center  
Charlotte, North Carolina  
Gantt/Huberman Associates, architects**

**132 Amsterdam Public Safety Building  
Amsterdam, New York  
Feibes and Schmitt, architects**



**136 Malden Government Center  
Malden, Massachusetts  
Doxiadis Associates, architects**

**139 United States Post Office  
Ahoskie, North Carolina  
Gantt/Huberman Associates, architects**

**140 United States Post Office  
Waughtown Station  
Winston-Salem, North Carolina  
Gantt/Huberman Associates, architects**

**ARCHITECTURAL ENGINEERING**

- 149 Product reports
- 151 Office literature
- 188 A/E update
- 212 Classified advertising
- 214 Advertising index
- 217 Reader service inquiry card

**NEXT MONTH IN RECORD**

**Building Types Study: Airports**

With the recent passage of Federal law 94-353, there can be no doubt that the activity in airport construction will quicken. That law will allow a much higher amount of Federal participation in local efforts—up to \$500 million this year alone. But what will the new construction be like? Most will not be on the very large all-new projects. In RECORD for October, a few of the probable alternatives will be discussed, and these will range from small new airports to alterations of existing facilities to the construction of new satellites around still-functioning older buildings.





**We've designed Tru-Therm®  
to save 2 of the  
scarcest things  
in today's world.  
Energy and money.**

We know the crunch affecting both is something you recognize all too well. We also want you to have a solution you can live with — aesthetically and economically — for years to come. That's why ASG Tru-Therm insulating glass units are built to provide outstanding efficiency, trouble-free performance and genuine durability. And they can do it right from the beginning, facilitating a reduced initial investment in heating and air conditioning equipment, along with a long-term cut in the consumption of costly fuel.

Thanks to Tru-Therm, it's feasible to increase the size of exterior openings to take maximum advantage of

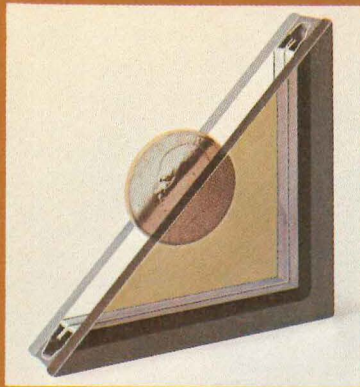

natural light, thereby minimizing the energy consumed by artificial lighting. Tru-Therm units are available in a wide variety of sizes with a choice of air spaces. What's more, they're adaptable to all the latest glazing techniques and all glass used in them can be tempered for extra strength and safety.

Tru-Therm shows its real beauty with an exterior lite of Bronze or Gray tinted twin-ground plate glass. Both are heat absorbing and glare reducing. Gray tinted glass blends with white, gray and black accented buildings. The Bronze harmonizes ideally with tinted glass spandrel and other earthtone materials, while giving a beautifully subdued reflective appearance. In fact, when you stop to think about it, we're going easy on three things. Energy, money and who knows how many eyes. For complete information, write ASG Industries, Inc., Dept. A, P.O. Box 929, Kingsport, Tennessee 37662.

 **ASG Industries Inc.**  
*The Glass Company*

*For more data, circle 10 on inquiry card*

**ASG**  
**the glass company**



## Three cheers for the AIA for pushing so hard on the energy bill. Now the real push starts. . .

The AIA's strongest effort in years at "going public" was launched on June 23rd with a full-page ad in *The Washington Post* encouraging quick affirmative action on the energy conservation bill. The ad read, in part: "The current and seemingly abundant supply of foreign oil must not blind us to the urgent need for [an energy policy]. . . . To do this we will obviously need more than legislation. Successful execution of a national policy will require the cooperation of that broad segment of the economy responsible for the built environment—financial institutions, developers, the building trades unions, engineers, the designers and manufacturers of building materials, and, of course, architects. It will also require the enthusiastic support of the Federal establishment, beginning with the White House. (The present Administration has been far too obsessed with the supply side of the energy crisis.) The cooperation of state and local government is essential. . . ."

To extend the impact of the ad, reprints were mailed with covering letter to all Senators and Representatives, all 50 governors, 30,000 city and county officials and agencies, and all AIA chapters for local follow-up. Articles were prepared for distribution to suburban papers, radio and television stations. Lou de Moll, president-elect Jack McGinty, and Energy Committee Chairman Carl Bradley provided background briefings for many major newspaper editorial boards; and Bradley presented a proposed energy plank to the Democratic platform committee, which was adopted at least in part. (A similar effort is underway at the Republican convention as this is written.)

That is some kind of effort at explaining to a not-too-excited public what this business of energy conservation is all about. And, as the headline of this piece suggests, I think three cheers are due the AIA.

### **The bill as passed is a start—and gives a big push towards standards**

The major thrust of the bill does seem primarily concerned (still!) with stimulating oil companies to increase domestic production by granting them higher prices. And I don't pretend to know whether that carrot will work this time.

There are also incentives, via grants and loan guarantees, to try to encourage homeowners and owners of some commercial build-

ings to "insulate" and "weatherize" their properties—and I'd be willing to bet that carrot *won't* work.

But most importantly, the bill *does* say: "Get on with the job of setting standards. . . ." The bill "directs" the Federal Energy Administration and HUD to establish energy conservation standards to be incorporated in state and municipal codes. And that does seem to me, at least, to be the only thing that will result in us getting on with the job of designing and building energy-efficient new buildings and retrofitting our old ones.

AS RECORD pointed out in its first Round Table on energy conservation—back in January 1972—there is just no doubt that architects and engineers know *how* to conserve vast amounts of energy. The problem is persuading owners and clients and mortgagers to accept the additional first costs that will be required in some (but by no means all) cases.

Our second Round Table on energy—published in our *Engineering for Architecture* issue last year (mid-August, 1975)—indicated that almost no one was against meaningful standards that spread the concerns and the costs even-handedly. Many owners at that Round Table agreed with a point of view I've held all along—standards are necessary because you can't ask responsible and concerned architects and engineers to do the extra study and research needed to design energy-efficient buildings; and you can't ask responsible and concerned owners to pay any extra first costs involved (even if your life-cycle costs look good) as long as there are "bad guys" down the street who will (by ignoring the desperate need for energy conservation) be able to "under-sell" you.

Good standards (and the right kind of standards are—as RECORD, AIA, the GSA, and most architects and engineers have been saying all along—performance standards) seem to me to be the only way to put everyone on the same footing and to get on with the job of conserving energy. The building industry *can* make a massive impact: for example, the AIA thinks we can reach savings on the order of 12.5 million barrels of petroleum equivalent per day by 1990. And *that's* 12.5 million barrels not wasted; 12.5 million barrels that we won't have to explore for, drill for, build refineries for . . . or pay for. —Walter F. Wagner Jr.





## THERE'S A NEW CHOICE IN LOW-GLARE LIGHTING...

Attractive appearance and energy efficiency have now been combined to create a new era of low-glare lighting.

General Electric's new low-glare luminaires cut off unwanted light above 90 degrees and put light on the task — where you want it. These new lighting systems have been specially engineered for HID

(high intensity discharge) light sources such as Lucalox<sup>®</sup>, so you don't lose good efficiency while you gain light control.

Choose between the Powr/Door<sup>®</sup> cut-off luminaire (upper left) or the Decashield<sup>®</sup> (lower left) for higher wattage applications. Both provide easy component accessibility for maintenance or upgrading. Or select

from the Decaflood<sup>®</sup> luminaire (lower right) with its unique set of area roadway optical systems . . . to the Spaceglow<sup>®</sup> with the attractive glow shield.

The choice is yours. If you'd like to start putting efficient light where you want it, write for more information to: General Electric Company, S





**THAT'S EASY ON YOUR EYES**

GE LIGHTING  
MAKES THE  
DIFFERENCE

GENERAL  ELECTRIC



# HOW MUCH WATER WOULD THE WATER SAVERS SAVE IF EVERY WATER CLOSET WERE AN EMBLEM WATERSAVER



## 1,752,000 gallons each year on 200 units

And, the Emblem is Eljer's regular production model water closet. No premium charges for watersaving. No special orders. Every Emblem uses less water per flush than some of the extra-cost "watersaving" closets.

The Emblem uses much less per flush than the 3.5 gallons stipulated by water conservation codes. And, savings over ordinary closets average a gallon and a half per flush.

So, in a 200 unit apartment building, assuming four residents per apartment and four flushes per day per resident, the Emblem can save 1,752,000 gallons of water every year. That's \$1,594



Emblem Model	Gallons Per Flush*		
	20 psi	40 psi	60 psi
Round	3.16	3.20	3.05
Elongated	3.05	3.12	3.16

savings\*\* per year on water and sewage bills. And, as costs go up . . . so will the savings.

You will conserve precious water, ease the demands on sewage systems and save on operating costs at no extra cost with the Emblem. Why would anyone buy any other water closet?

\*As tested by Dynamics Testing Laboratory, Toledo, O

\*\*Based on a 91¢ average cost per thousand gallons in 5 major cities.

**ELJER PLUMBINGWARE**  
Wallace Murray Corporation  
Dept. AR, 3 Gateway Center  
Pittsburgh, Pennsylvania 15222

**ELJER**

WallaceMu



# The GF Cube. It doubles your thinking power.



The new GF Cube offers twice as many desk and console configurations as our best competitors.

That has to start you thinking. Because, this great variety of confi-

gurations allows you to make better use of very expensive floor space.

The open office shown here gives you just a glimpse of the possibilities.

Ask your GF repre-

sentative to put the complete GF Cube story together for you. Or write us for literature.

GF Business Equipment, Inc., Youngstown, Ohio 44501. In Canada: Toronto, Ontario.

 **Office  
Furniture  
Systems**  
GF Business Equipment

For more data, circle 46 on inquiry card



# Before you cover you

**Consider the type of traffic that will pass by.**

Korolite wallcoverings are heavy enough to take a lot of punishment - they run from 15 ounces minimum to a maximum of 25 ounces. Most other type 1 materials go up to only 12 ounces. And because they're vinyl, they're long lasting, durable, and easily cleaned.



**Consider the type of people who will look at what you select.**

Korolite wallcoverings come in over 107 different choices. And in a wide range of patterns, colors and textures to satisfy any taste or personality. From modern to traditional.



# walls, cover all the angles.

Consider the size of wall you need to cover.

There is no wall too large or too small for B.F. Goodrich Korolite® wallcoverings. They come in 54 inch widths, and are ideal for home improvement or renovation, hotel-motel applications, all lightweight commercial uses, and residential.

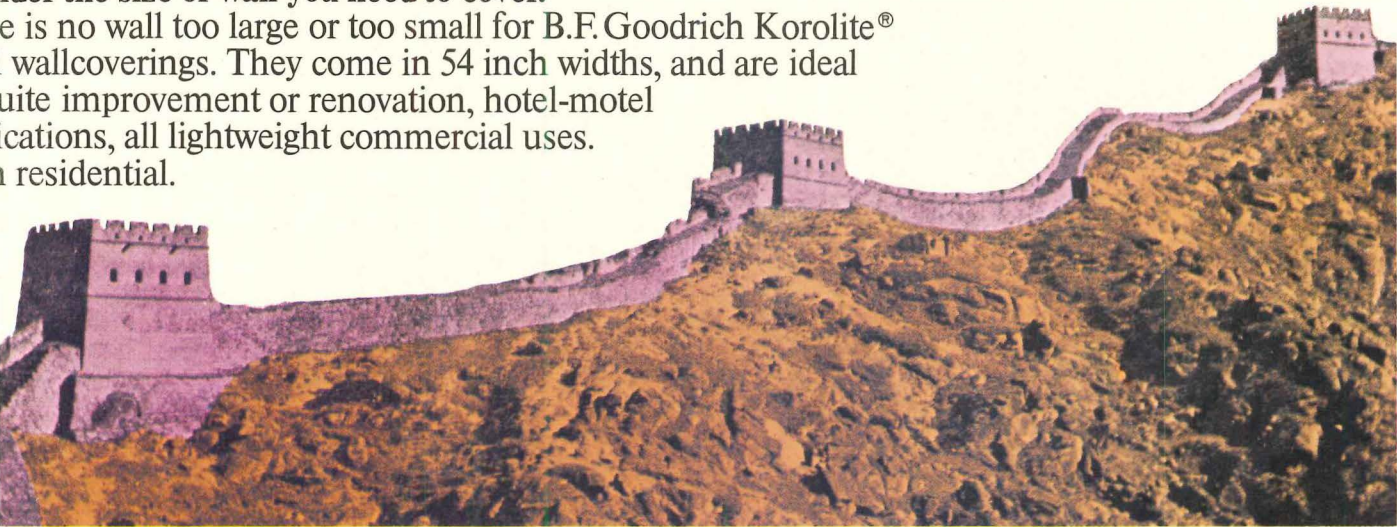

Consider the costs carefully.

Compare the expected life and durability of Korolite wallcoverings with the shorter life of other wallcoverings, and you'll see that BFG vinyl wallcoverings are an extremely economical approach.

B.F. Goodrich  
General Products Company,  
500 South Main Street,  
Akron, Ohio 44318.



**Koroseal Vinyl Wallcoverings**

After you've considered all the angles, you'll conclude that the right wallcovering for you can be selected right from this book.

Get a hold of one to see and feel our wallcoverings. Or consult your Koroseal® swatch book or Sweet's for your nearest BFG distributor.





# Presenting the new ESWA heating system

Most heating systems require an entire crew and a whole array of tools to install the many components.

All it takes to install ESWA is one man armed with a staple gun.

Sometimes it doesn't even require that.

Just unroll the ESWA elements and put them into place. Your heating unit is up in a fraction of the time it takes to install other systems requiring extensive labor.

That's because ESWA lets you eliminate furnaces, radiators, intricate wiring, blowers, ducts and pipes — and therefore much of the expense of putting in a heating system.

And ESWA gives you one of the most effective heating systems available today. It's custom designed to eliminate heat waste.

And for maximum comfort and efficiency, the temperature of each area can be controlled with its own thermostat.

Unlike other heating systems, ESWA is completely safe.

Should a nail or screw penetrate an element, the material actually insulates itself from the intruding object, providing safe and continuous operation. The ESWA Heating System provides clean, economical heating in any kind of building. That's the reason it's been in use in Europe for over 15 years.

Isn't it time you started installing your heating systems with a staple gun?

For more information, call or write Mr. Thomas J. Hoffman, ESWA, Elixir Industries, 17925 S. Broadway, Gardena, CA 90248 (213) 321-1191.

## and its installation tool.



U.S. Patent Nos. 3263307, 3336557

**EI** **ELIXIR  
INDUSTRIES**

17925 So. Broadway, Gardena, CA 90248  
(213) 321-1191



# TERNE ROOFING... FORM, COLOR, FUNCTION

## ***From the standpoint of form,***

Terne permits any visual roof area to become an integral part of the total design concept.

## ***From the standpoint of color,***

Terne provides the architect with a creative latitude as broad as the spectrum itself.

## ***From the standpoint of function,***

Terne's durability is measured in generations rather than years; it is easily installed, and when measured by the criteria of those to whom ultimate performance is no less significant than initial cost, it is relatively moderate in price.

## **FOLLANSBEE** FOLLANSBEE STEEL CORPORATION FOLLANSBEE, WEST VIRGINIA

Boulder Recreation Center, Boulder, Colorado  
Architects: Nixon-Brown-Brokaw-Bowen, Boulder, Colorado  
Roofer: Reliable Heating, Longmont, Colorado

*For more data, circle 16 on inquiry card*







# LEXAN<sup>®</sup> is SHEET guaranteed against breakage.

## What do you make of that?

Whatever you make of it will withstand the worst punishment possible. LEXAN sheet is guaranteed against breakage,\* even under the blows of a sledgehammer or the onslaught of a steamroller. That means lower replacement costs, more economy. LEXAN sheet is UL listed Burglar Resistant, compliant with the Safety Glazing A.N.S.I. (Z97.1) standard and OSHA requirements. And new F-2000 flame-retardant grade meets the highest standards for reduced flammability.

There's LEXGARD<sup>®</sup> bullet-resistant laminate which meets UL ballistic level ratings up to .44 Magnum (UL 752 standard).

For industrial glazing PROTECT-A-GLAZE<sup>™</sup> sheet offers an attractive, clear and tinted, translucent glazing for durability with economy.

And architects are finding more and more applications. LEXAN sheet is being used for lighting panels and lenses which are light weight and provide high light transmission.

### **Tough skylights.**

LEXAN sheet's high impact resistance, clarity, and weather resistance make it ideal for durable, attractive skylights.

Photo: Nashville House  
Nashville, TN  
Architect: Robert Lamb Hart/HKS

### **NOTICE:**

LEXAN<sup>®</sup> SHEET IS THE LEAST COMBUSTIBLE SAFETY GLAZING PLASTIC SHEET BUT WILL IGNITE WHEN EXPOSED TO AN IGNITION SOURCE IN EXCESS OF 800°F (426°C).

#### **FOR MAXIMUM SAFETY...**

- Advise local fire officials of LEXAN glazing installations.
- Consider sprinkler systems for additional safety.
- Check local codes for construction applications.
- Observe fire precautions similar to wood.
- Consider emergency access sash construction.



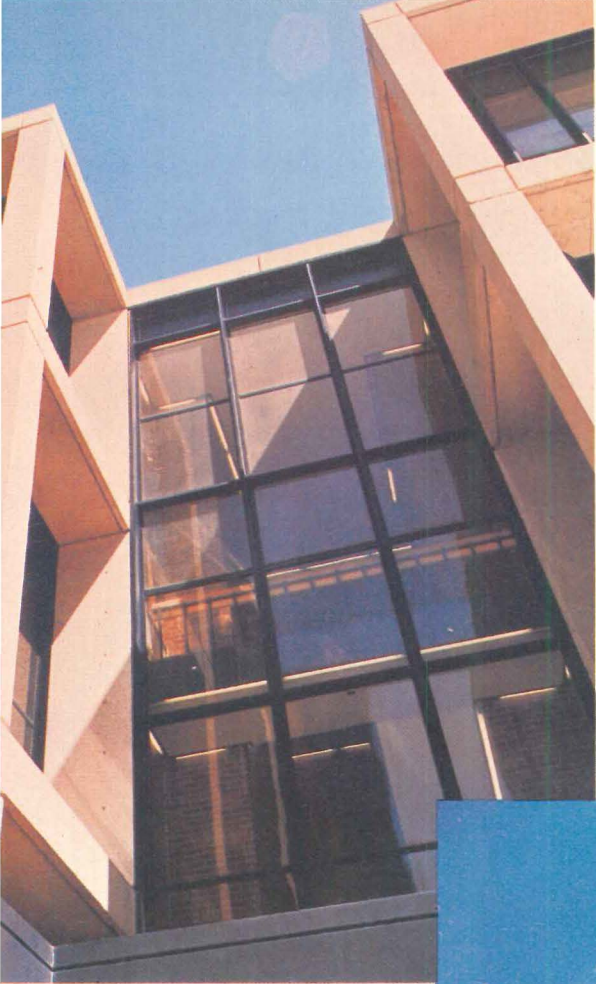

### Safe school windows.

In school systems throughout the USA, LEXAN sheet secures buildings against vandalism and theft, with LEXAN sheet providing up to 25% more insulation than comparable thicknesses in glass.

Photo: Walt Disney Magnet School  
Chicago, IL  
Architect: Perkins & Will



### Long lasting enclosed walkways.

Domes and enclosed walkways of LEXAN sheet are weather resistant, color stable, and offer high light transmission.

Photo: Provincial Court & Remand Centre  
Calgary, Alberta, CANADA  
Architects: Long Mayell & Associates

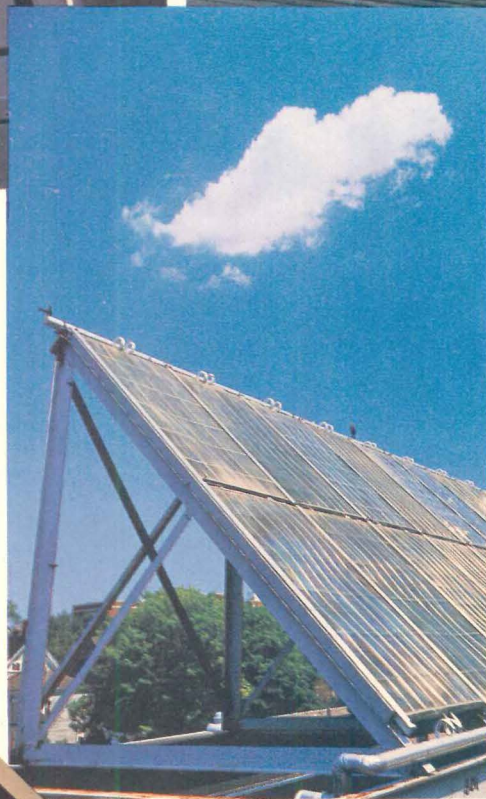

### Light weight solar collector panels.

LEXAN sheet .040 and .080 mils thick offers high light transmission, physical toughness, high heat stability, and environmental resistance.

Photo: Grover Cleveland Junior High School  
Dorchester, MA



### Strong passenger shelters.

Durable passenger shelters with LEXAN MR-4000 mar resistant panels protect passengers from the weather, and resist damage by vandals.

Photo: TRI-MET System  
Portland, OR  
Architect: Skidmore, Owings & Merrill

Whatever you design that needs to be transparent, tough, and attractive—and safe—there's a grade of LEXAN sheet to design it with.

# LEXAN<sup>®</sup> SHEET Get behind it.

GENERAL  ELECTRIC

General Electric Plastics: What the world is coming to.

See Sweet's Architectural Catalog Ref. 8.26/GE

® Registered Trademark of General Electric Company  
TM Trademark of General Electric Company

GENERAL ELECTRIC CO.  
Sheet Products Section  
1 Plastics Avenue  
Pittsfield, MA 01201

\*Guaranteed by General Electric against breakage. If at any time during a three-year period from date of purchase, LEXAN sheet when used for glazing is broken, General Electric, as its sole responsibility under this guarantee, will give the purchaser a new LEXAN sheet.



# Create seemingly seamless buildings. That's the beauty of designing with Dow Corning® 790 building sealant.

Now you can design the buildings of your dreams, with fewer, narrower joints — for endless expanses of wall.

While most sealants are designed to accommodate joint movement of  $\pm 12\frac{1}{2}\%$  to  $\pm 25\%$ , Dow Corning 790 sealant allows design freedom because of its  $\pm 50\%$  movement capability without affecting adhesion or cohesion. Use 790 on  $\pm 25\%$  joint designs, and rest easy. Its increased capabilities give you an extra margin of safety.

Buildings sealed with 790 remain weatherproof, watertight and maintenance free. For twenty years or more.

Application? Fast and easy. 790 is ready to use. Less material required, less time, labor and expense. No primer needed on most substrates, no job delays or costly callbacks. For design freedom, beauty and practicality, Dow Corning 790 sealant is a dream come true.

Start your dream today; write for more information to: Dow Corning, Dept. 6400A, Midland, Michigan 48640.



**DOW CORNING**

DOW CORNING

For more data, circle 18 on inquiry card



# Don't these German classrooms suggest a design idea to you?



First, let us give you a hint. Look for practicability as well as appearance. If you were to tour this entire project, you would discover that all classroom and corridor walls are constructed of porcelain-on-steel Rite-On, Wipe-Off panels... the new dust-less writing system by AllianceWall Corporation that is both vandal- and graffiti-proof.

Students and teachers use special dry-marker pens. Writing dries instantly and can be erased dry without leaving a speck of dust. Panels also double as projection screens for movies, slides and other types of audio-visual presentations, as well as magnetic bulletin boards. They come in 50 decorator colors and fit any partition system.

The writing surface is guaranteed for 50 years. And the cost-amazingly low when you consider the panels require no expensive maintenance.

Those are just a few of the ideas you may wish to consider. For complete information write:

**AllianceWall** CORPORATION  
BOX 247, ALLIANCE, OHIO 44601

Factories in Alliance, Ohio; Okmulgee, Oklahoma; Genk, Belgium; and Odense, Denmark.

Photos of Saint Augustin School Centre near Bonn, Germany.



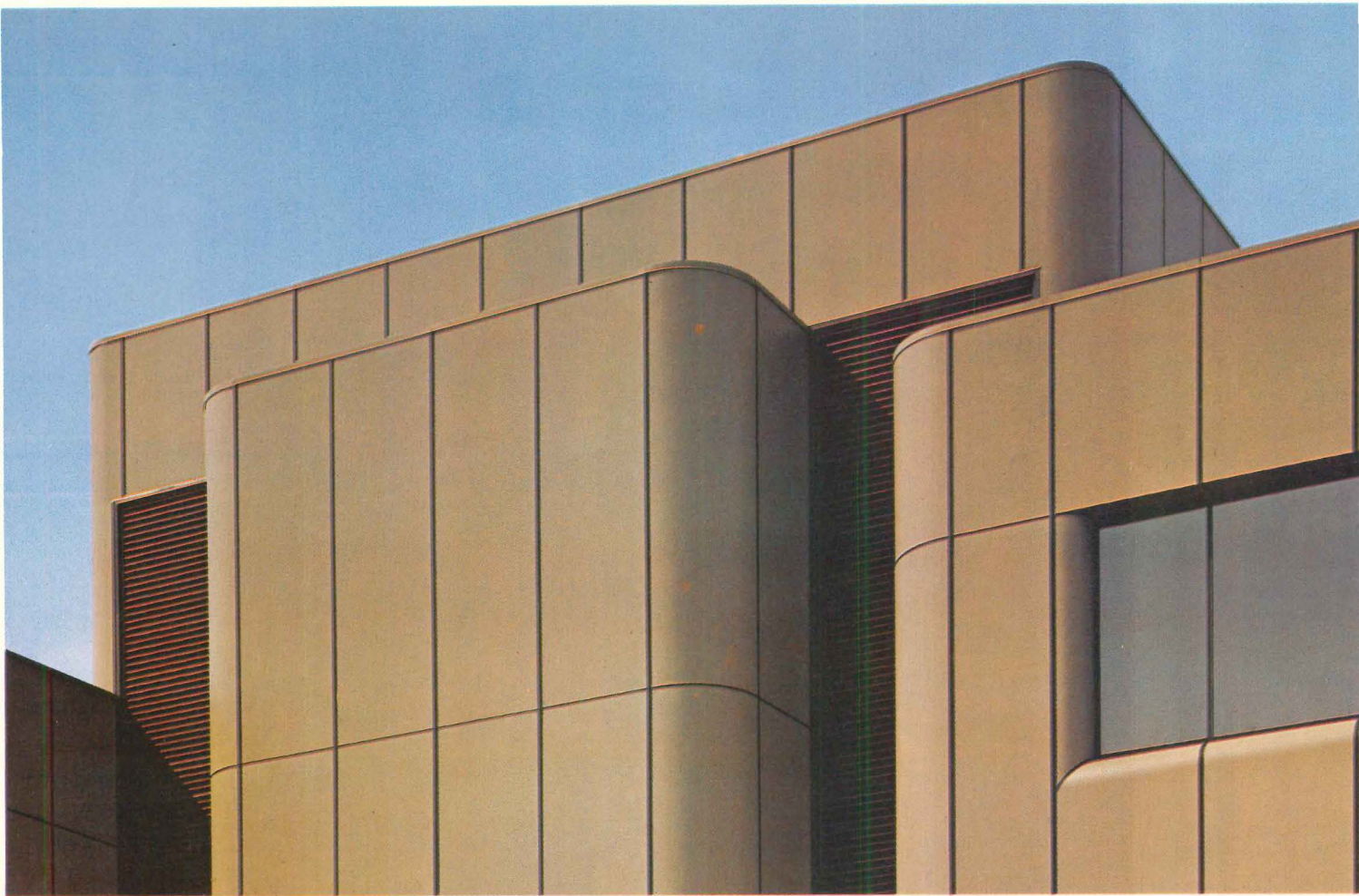

Project: Keen College Academic Building, Union, N. J. Architect: Robert Hillier, Princeton, N. J. Curtain Wall Erector: Whelan Mfg. Co., Trenton, N. J.

## Alcoa Alply Insulated Panels offer you custom design flexibility.

### Why settle for less?

If aesthetic freedom and energy conservation are important to you and your client, then we suggest you contact us for your nearest Alcoa Alply\* panel regional distributor, who offers you single-source responsibility — everything from engineering to the completed wall system, in place, with integral fenestration, interior and exterior finish and thermal insulation.

No other insulated modular wall offers all these choices for low- to middle-rise buildings:

Exterior and interior skins: aluminum, stainless steel, hardboard, plywood, cement-asbestos — you name it.

Finishes: four standard finishes and 18 colors, including Super Alumalure\* baked-on, factory-applied fluoropolymer enamels . . . Alumalure baked-on synthetic resin enamels . . . Alumilite† electrolytic coatings in natural aluminum . . . Duranodic‡ hard-coat finishes in three integral bronze shades and three new integral gray shades.

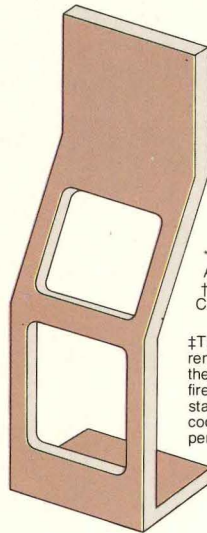

\*Registered Trademark of Aluminum Company of America  
†Trade Name of Aluminum Company of America

‡The use of polyurethane, polystyrene and isocyanurate cores in these applications may present a fire hazard under certain circumstances. Consultation with building code officials and insurance company personnel is recommended.

Panel cores: polystyrene, polyurethane, isocyanurate‡ or other materials, depending upon project requirements.

Wide range of panel sizes: up to 5 feet wide, 18 feet long.

Variety of shapes: panels can be shop-formed to almost any three-dimensional shape desired.

Choice of joining systems: Alcoa's patented Snug Seam\* caulking, splines, battens or frames.

Variety of cutouts possible: to accommodate windows, doors, sloping grade lines, walkways, difficult contours, parapets.

Whatever you're designing, let our regional Alcoa Alply panel distributors help. They know a great deal about wall systems, finishes, industrial roofing and siding and other low- and middle-rise construction problems. For further information, write: The Stolle Corporation, Aluminum Company of America, 1025-J Alcoa Building, Pittsburgh, PA 15219.

**The Stolle Corporation** A Subsidiary of Aluminum Company of America

For more data, circle 20 on inquiry card



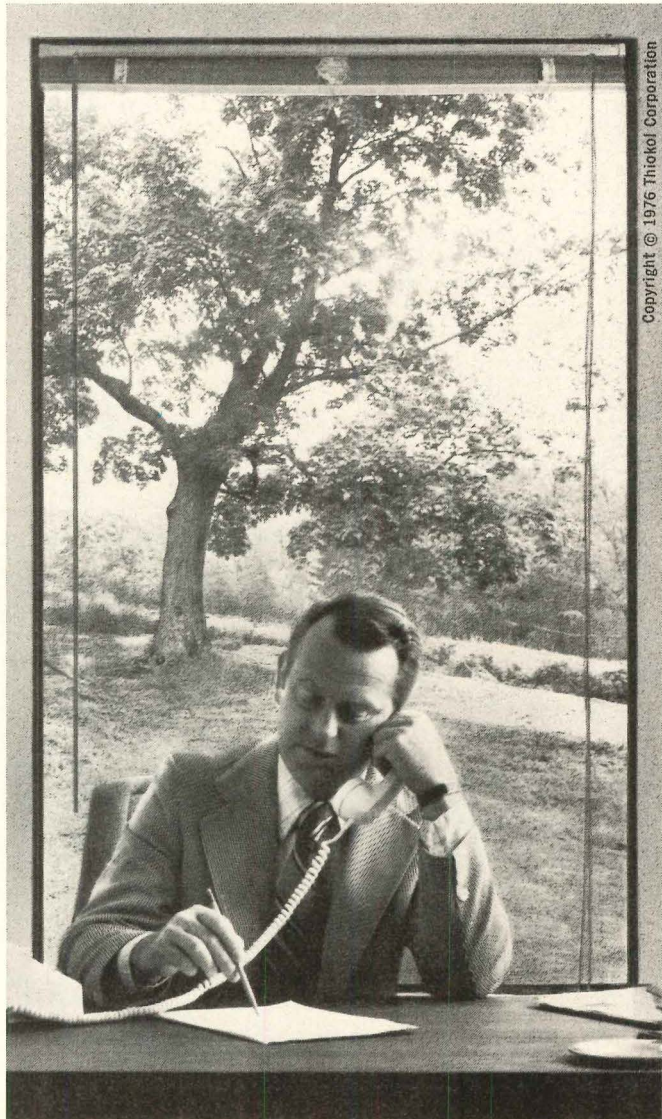
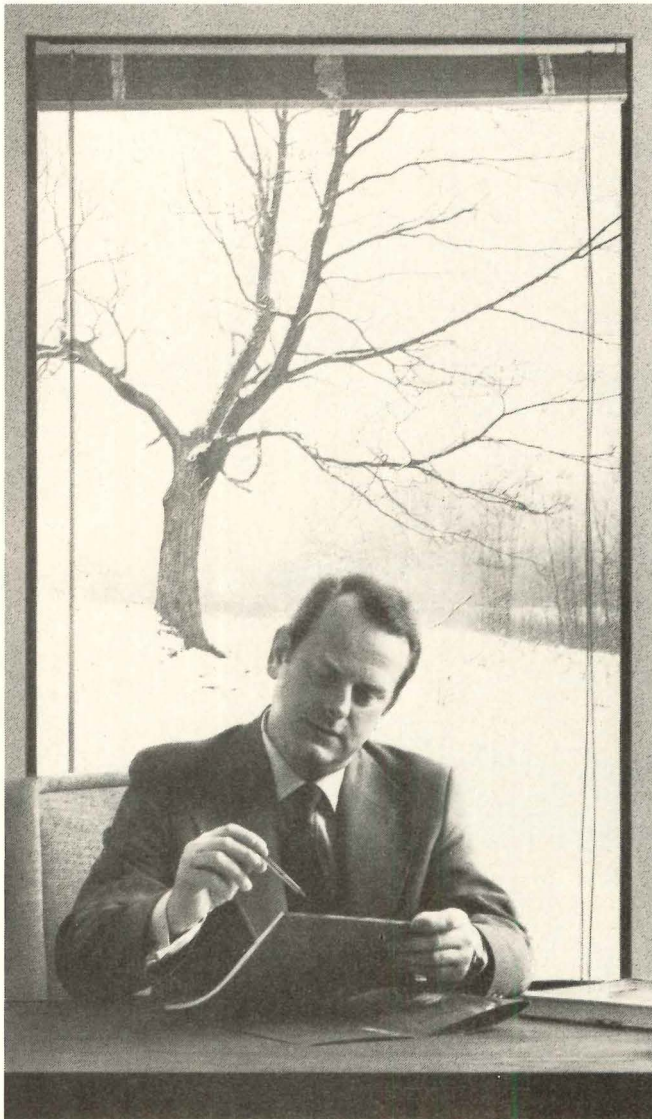

Copyright © 1976 Thiokol Corporation

## Insulating glass. The heating and cooling system you don't even have to plug in.

What's more, there are no wearing parts. And the only maintenance is an occasional washing.

The point is that once purchase and installation costs are paid, double-pane insulating glass throughout a building is a year-round system to help keep in the heat all winter and not lose your client's cool in the summer. Saving energy. Saving money.

This diagram, for example, shows that on a typical winter day, the interior surface of a double-pane, double-hung unit of insulating glass can be 21% warmer than its single-pane counterpart\*. Resulting in a heat transfer coefficient (U value) slashed from 1.13 to 0.65. Add a metalized coating to the glass and the U value

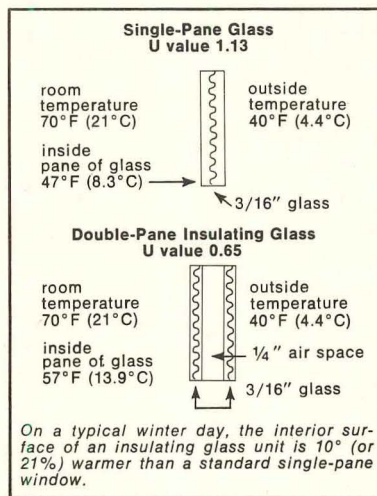

drops to a highly efficient 0.50.

In addition to lower heat loss are the many years of service you can expect from insulating glass units, particularly when they are manufactured with sealants based on our LP® liquid polysulfide polymer. Fact is, over 80% of IG manufacturers use polysulfide base sealants.

We think that simple fact speaks for itself.

For more information on insulating glass units and the polysulfide base sealants that give them long life, write Marketing Communications, Thiokol/Chemical Division, P.O. Box 1296, Trenton, New Jersey 08607.

Based on calculations from the ASHRAE (American Society of Heating, Refrigeration and Air Conditioning Engineers, Inc.) Guide and Data Book.

# Thiokol

Specialty Polymers • Off-the-Road Vehicles • Synthetic Fibers • Sprayers • Propulsion • Educational Services  
Friction Materials • Ski Lifts • Pyrotechnics • Closures • Rubber and Rubber Chemicals • Radiation Curable Polymers and Coatings

*For more data, circle 21 on inquiry card*





Medical Center—Andover, Massachusetts • Architects: Drummy Rosane Anderson, Inc.

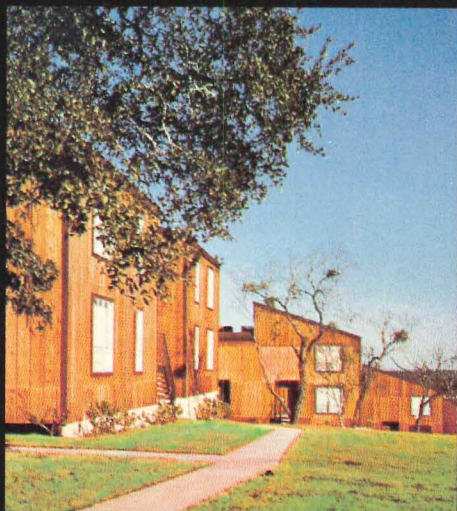

Woodhill Apartments—San Antonio, Texas  
Architects: Hoff, Blackstone and Strode, AIA

# *Redwood Plywood*



Nob Hill Condominiums—Hauppauge, New York • Arch.: John A. Jacobsen and Associates • Sponsor & Builder: The Campagna Development Corporation





Professional Center—Carmel, California • Architects: Rochlin and Baran, AIA, and Assoc.



Office Building—Sausalito, California  
Arch.: Wurster, Bernardi and Emmons, Inc., AIA  
Structural Engineer: W. B. Clausen



Regula's Designs in Flowers—San Francisco, California  
Designer: John Augsbürger

## *.its beauty is more than skin deep.*

al appeal is clearly the principal reason for selecting redwood plywood as a building material. The warm beauty and rich color of its surface enhance the structure itself and its physical setting.

Redwood plywood also offers the architect and builder many practical advantages and economies.

Durable. Redwood plywood is naturally resistant to rot, decay, and protected with both a waterproof bond and a special water-repellent preservative.

Fire-resistant. Redwood plywood, in 5/8" thickness, has earned a low flame-spread rating that qualifies it for all Class II uses in the Uniform Building Code.

Maintenance is minimal. Redwood plywood will take and hold a wide variety of finishes, or weather beautifully when unfinished.

Conserves energy in heating and cooling. Like other wood products, redwood plywood affords high insulation value, requires less fuel to maintain comfortable year-around temperatures.

Construction is simplified. Because of redwood plywood's cross-laminated strength, it can be applied directly to studs without diagonal bracing. No building paper is required with shiplapped or battened joints. And redwood plywood comes not only in standard 4 x 8 panels, but in 4 x 9 and 4 x 10 sizes as well, to facilitate modular design.

Many patterns are available. Choose from plain, grooved and inverted batten designs, in solid-color heartwood or sapwood-streaked faces. All suitable for interior or exterior use—all textured for rich surface interest.

Current examples of redwood plywood applications are shown in the accompanying photographs. For data on specifying redwood plywood, see the Redwood Plywood Guide in Sweet's or write us at Department P.



CRA CALIFORNIA  
REDWOOD

ASSOCIATION 617 Montgomery Street, San Francisco, CA 94111

*Redwood—a renewable resource*

For more data, circle 22 on inquiry card



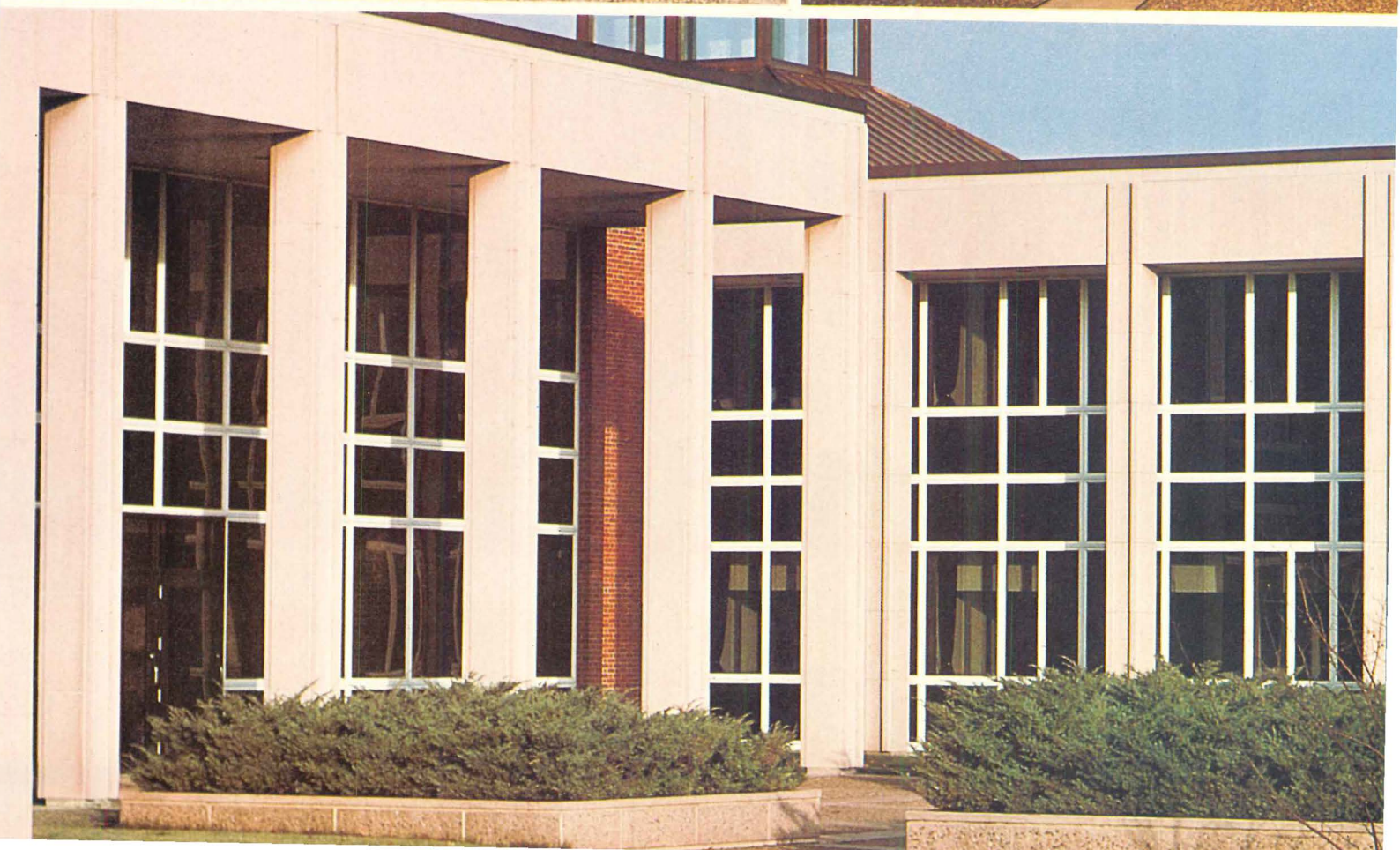
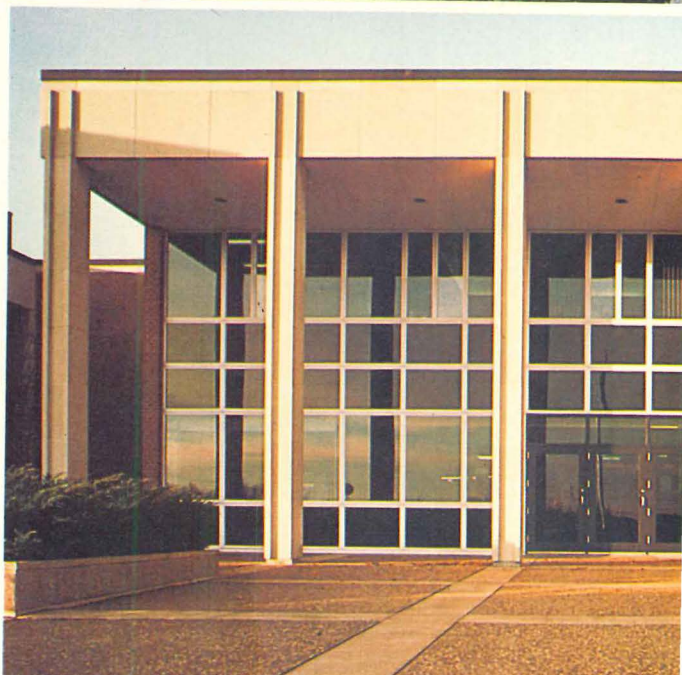
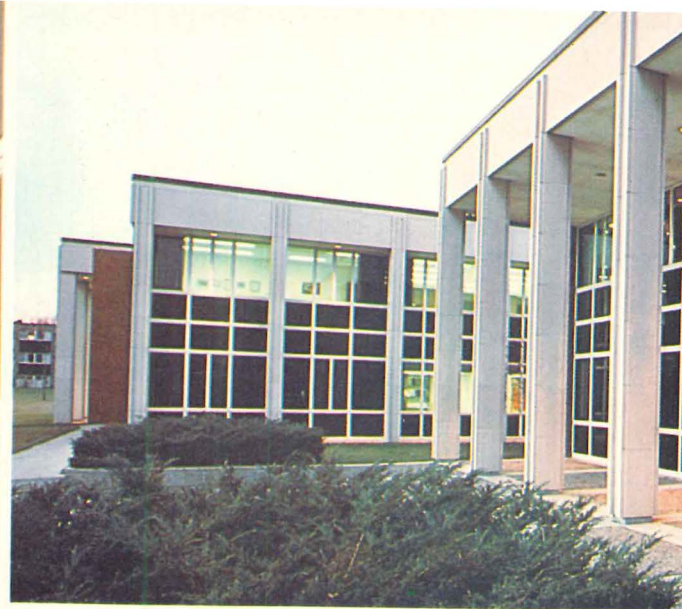
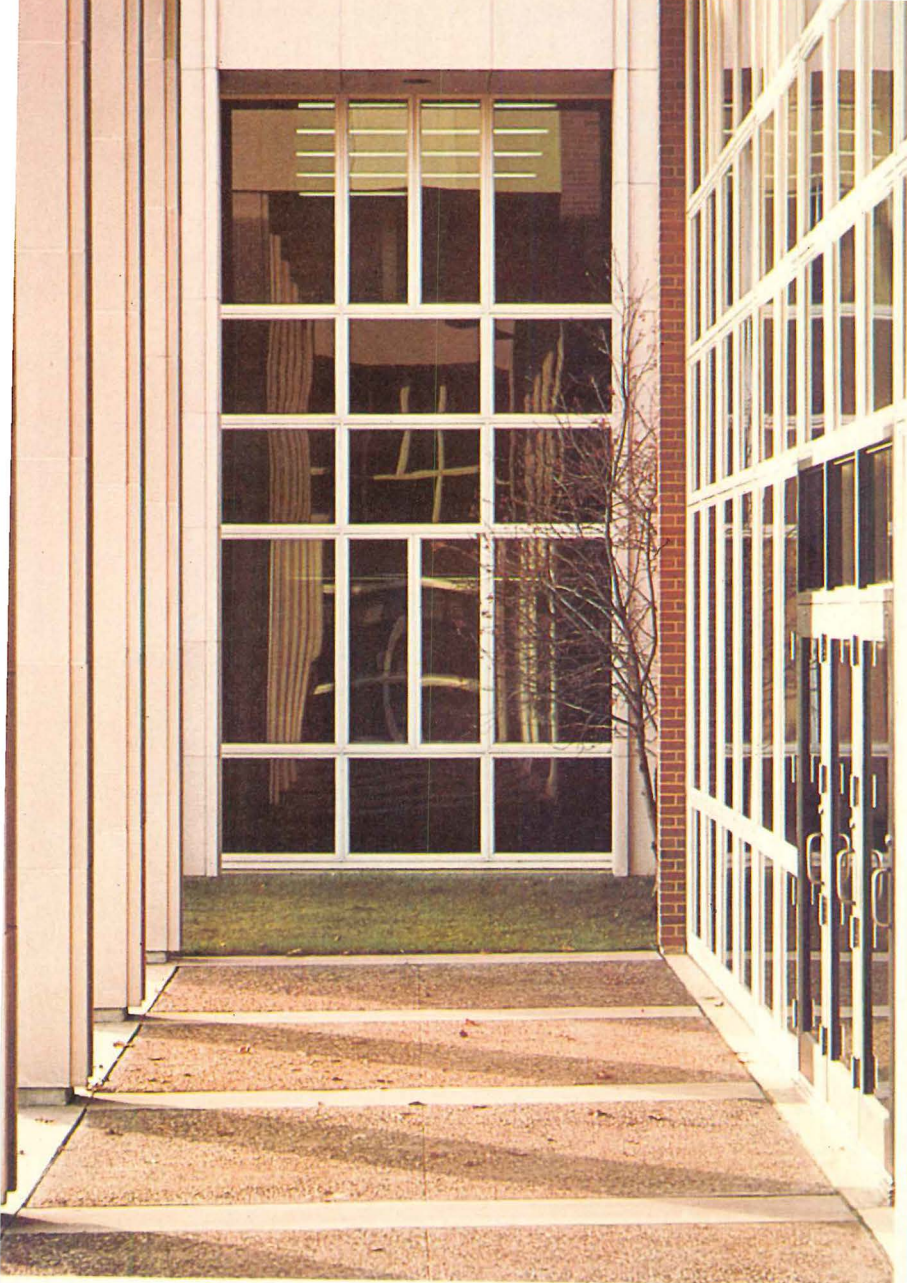



# Six years ago Washington County took Andersen to court.

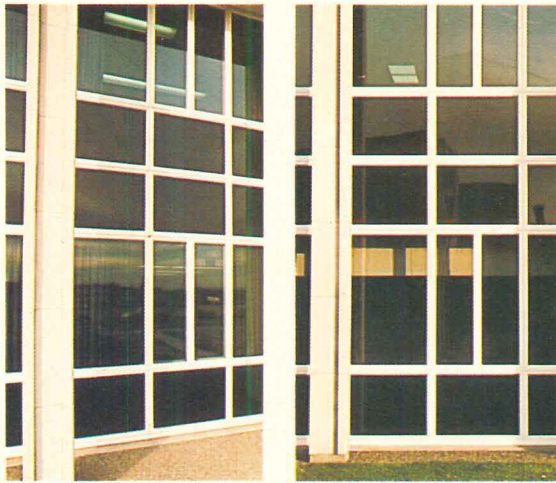

1969 Perma-Shield Window.

1975 Perma-Shield Window.

## And we're still appealing.

Back in 1969, Washington County opened its dramatic new courthouse and government office building. And the first Andersen® Perma-Shield® Windows were put on trial.

Now, after six years of cold, snowy Minnesota winters and humid, sun-baked summers, Andersen's crisp, clean beauty is still appealing.

The evidence? A side-by-side comparison with the brand new Perma-Shield Windows in the building's 1975 addition.

A confrontation that could keep a jury deliberating for months as to which are the old and which are the new.

The reason for Perma-Shield's long-lasting beauty? A low maintenance rigid vinyl sheath (over a wood core) that doesn't rust, pit or corrode. Doesn't chip, crack or peel. Keeps on looking its best year after year.

But don't accept one county's decision. Try the case yourself. Use long-life, low maintenance Perma-Shield Windows in your next building.

For more details, see Sweet's File 8P. Or call your Andersen Dealer or Distributor. He's in the Yellow Pages under "Windows". Or write us.

The beautiful, carefree window.

**Andersen® Windowalls®**  
ANDERSEN CORPORATION BAYPORT, MINNESOTA 55003

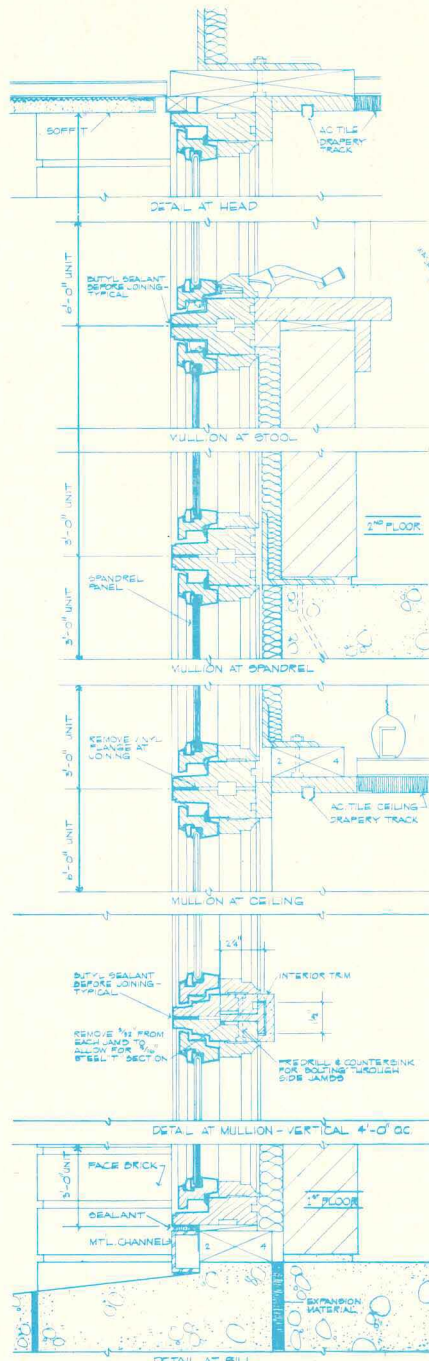



**"GE's Twin-Package System has the flexibility to help relieve the gas problems in commercial and industrial buildings."**

**"I could use a little help myself."**

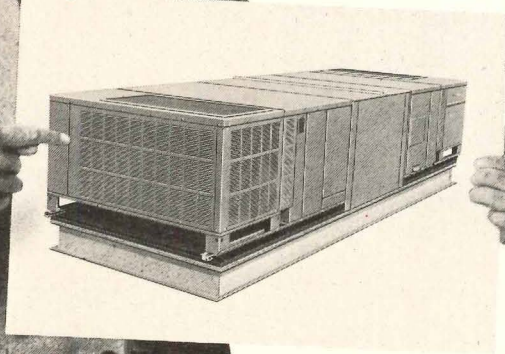
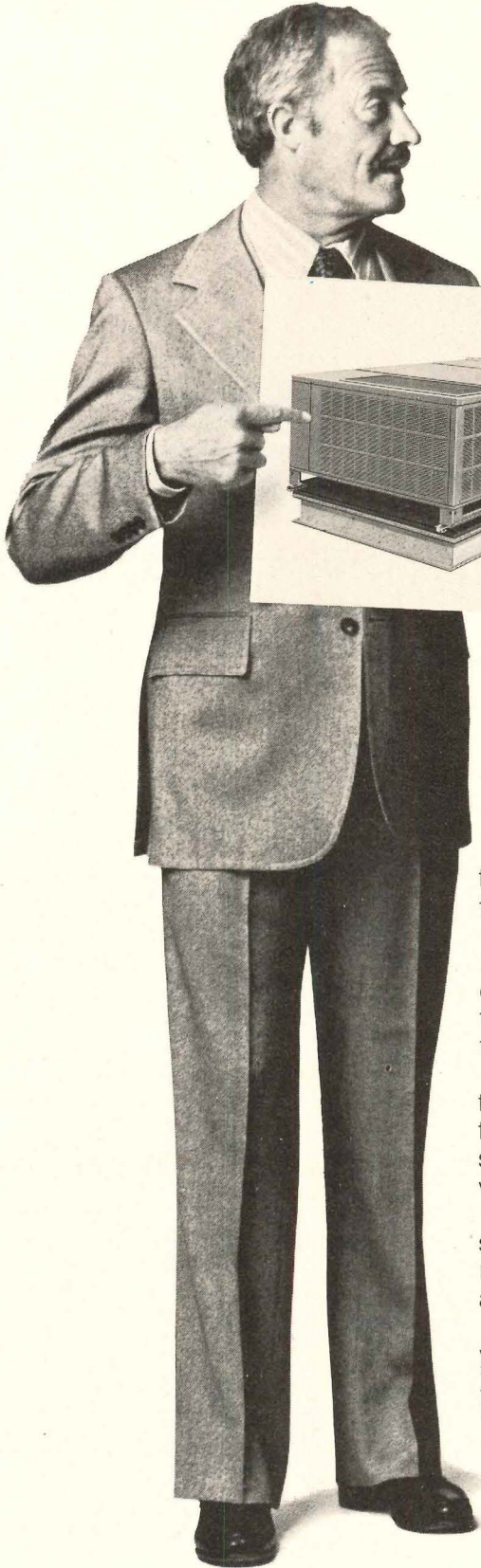

GE has a Twin-Package System with 15, 17-1/2 or 20-ton capacities, in three combinations.

The single package cooling system can be installed with four stages of cooling which allow you to match more closely your cooling requirements. With electric strip heaters you can have up to eight stages of heating.

With the Weathertron® Heat Pump, it can have two stages of compressor heat plus eight additional stages of electric heating, and two stages of cooling.

Combined gas-electric, in the three capacities, gives you up to four stages of heating, and four stages of cooling. A number of other variations are also possible.

Because this system uses standard 7-1/2 and 10-ton equipment, you can have improved parts availability.

For more information, contact your GE Central Air Conditioning Zone or Independent Distributor. He's in the Yellow Pages.

**GENERAL  ELECTRIC**

*For more data, circle 24 on inquiry card*



NEWS REPORTS  
BUILDINGS IN THE NEWS  
HUMAN SETTLEMENTS  
REQUIRED READING

**The jobs bill is still uncertain of a go-ahead from Congress and from the President.** But if it succeeds, new public works projects could get rolling by early next month. Details on page 34.

**President Ford has signed the housing authorization bill** despite his apparent opposition to many of its programs. The bill revives the conventional public housing program and provides a Treasury loan for construction of housing for the elderly. Details on page 34.

**New York City has plans to build a playground for handicapped children as well as for those who are able-bodied.** Architects working in the state of New York, and wishing to participate in the design competition for this playground, should contact the New York City Department of City Planning, Playground Competition, Publication Sales Office—Room 1616, 2 Lafayette Street, New York, New York 10007.

**Congress has finally appropriated funds for the Pennsylvania Avenue restoration project proposed more than 15 years ago.** The plan calls for construction of both residential and commercial units along the historic route between the White House and the Capitol. Details on page 34.

**Prescriptive standards are needed for buildings that will limit energy savings, the AIA told the Federal Energy Administration recently.** Urging that the FEA revise its proposed State Energy Conservation Plan guidelines, AIA vice-president Carl L. Bradley argued for adoption of performance-based standards.

**The Justice Department plans to re-open its antitrust case against the American Society of Civil Engineers.** Ended four years ago in a consent decree, the case challenges prohibitions on price competitions as stated by the profession's code of ethics. Details on page 34.

**Ten architectural and artistic design projects are part of a national touring exhibit** sponsored by the General Services Administration. The display features winners of GSA's Second Biennial Design Awards program, including projects involving historic preservation, adaptive re-use, interior space planning and design, office building construction, fine arts, and barrier-free design. Now on display at Boston's Federal Center, the exhibit will open September 14 at the Massachusetts Institute of Technology; October 18 at the Federal Center in New York; November 17 at McCormick Place in Chicago; and December 28 at the Federal Building in Kansas City, Mo.

**An exhibit exploring the impact of black artisans on the architecture and building crafts of the South will open** September 30 at the Los Angeles County Museum of Art. "Two Centuries of Black American Art" will remain in Los Angeles until November 21 and then travel to the High Museum of Art, Atlanta (January 8-February 20, 1977), the Dallas Museum of Fine Arts (March 30-May 15, 1977), and the Brooklyn Museum (June 25-August 21, 1977).

**New York City Club's Bard Awards for Excellence in Architecture and Urban Design were recently presented.** The winners were: Bustop shelters, by Holden/Yang/Raemsch/Terjesen, Architects; Arts for Living Center, by Prentice & Chan, Ohlhausen, Architects; and 1199 Plaza Cooperative Housing, by The Hodne/Stageberg Partners, Inc., Architects. Alfred DeVido, Philip Johnson, Peter Samton, and Joseph Wasserman served on the jury.

**The Concrete Reinforcing Steel Institute's 1976 design awards program is now taking entries.** Deadline is November 15, 1976. The awards recognize reinforced concrete structures that show "creative achievement in esthetics, economy, engineering and functional excellence"; and are open to all registered architects and engineers (individuals or teams) whose structure is located within the continental United States and has been completed since January 1, 1974 or essentially finished by November 15, 1976. For more information, contact: Victor Walther Jr.; Concrete Reinforcing Steel Institute; 180 North LaSalle Street, Room 2110D; Chicago, Illinois 60601.

**The projects of 11 American architects are currently being exhibited in the 1976 Venice Biennale.** The display, dealing with suburban alternatives, contains works by: Raimund Abraham, Emilio Ambasz, Peter Eisenman, John Hejduk, Craig Hodgetts, Richard Meier, Charles Moore, Cesar Pelli, Robert Stern, Stanley Tigerman, and Denise Scott Brown with Robert Venturi. The exhibition was organized by the Institute for Architecture and Urban Studies in New York City.

**ARCHITECTURAL RECORD invites submissions for RECORD INTERIORS of 1977 and RECORD HOUSES and Apartments of 1977.** Deadlines for receipt of material are: October 1, 1976 for RECORD INTERIORS, to be featured in the January 1977 issue; and November 1, 1976 for RECORD HOUSES and Apartments, for the 1977 mid-May issue. For further details, contact Barclay Gordon, ARCHITECTURAL RECORD, 1221 Avenue of the Americas, New York City 10020. Telephone: (212) 997-2334. (Also see page 198.)



## Ford signs housing bill after a long battle

The housing authorization bill President Ford signed just before the Republican Convention last month actually revives, continues, or expands a number of categorical-type housing programs the President does not want. For example, it revives the conventional public housing program, provides a \$2.5 billion direct-from-the-Treasury loan program to build housing for the elderly, and continues for another year a program that subsidizes mortgage payments for private builders of housing for rent to low-income families.

President Ford, however, said he signed the bill because "good government requires" that a number of program extensions become law "as soon as possible." He also noted that Congress was voting less actual spending—for the public housing program for example—than the maximum allowed under the authorization bill.

The final law was the product of a prolonged battle between Congressional Democrats and the Ford Administration forces led by Housing Secretary Carla Hills.

On public housing, the bill calls for \$100 million of annual contract authority spending to be committed to the construction of new substantially rehabilitated conventional housing projects. The appropriation, however, is \$85 million.

On housing for the elderly, the \$2.5 million Congress authorized is "off-budget" lending by the Treasury

to builders of new housing for the elderly—enough to start about 90,000 new units. It requires no appropriation.

The battle of trimming back planning grants ended with \$100 million authorized, but only \$62.5 million voted, as compared to last year's \$75 million.

Other actions include raising the mortgage limits and the maximum allowable income for a moderate-income family who want to buy a house under the revived home-ownership program. The government now subsidizes the mortgage rate down to 5 per cent. The program was also liberalized to make mobile homes eligible.

Other provisions authorize funds for the new National Institute of Building Sciences; boost the funding for the urban homesteading program; and make permanent an exemption from the mandatory flood insurance, thus making it possible for homeowners to finance the sale of houses in flood-prone areas not in compliance with the law.

The actual amount approved for all subsidies for lower-income families for fiscal year 1977 (beginning October 1) is \$675 million, including an Administration program under which Secretary Hills is trying to house as many needy families as possible in existing apartments, rather than in new buildings constructed under government contracts.—*Donald Loomis, World News, Washington.*

## Jobs bill still not guaranteed of a go-ahead

The fragile coalition who wired together enough Senate votes to override President Ford's veto of the jobs bill fears their deal may yet come unstuck. The coalition has to hang together long enough to get the \$3.95 billion appropriation bill through both houses. And the President will have to sign the bill before Washington bureaucrats can give the mayors and governors the green light on any spending.

Whether the President will is an open question: but if he does, Commerce Department approvals of public works projects might begin by October 1, as would spending by some states of new allocations for sewage treatment plants from the Environmental Protection Agency (EPA). Spending by cities and states of Treasury's countercyclical revenue-sharing checks could start by November 1.

But by early this month, which is the earliest an appropriation bill is expected to reach the White House, new political strains could develop around the Congressional consideration of the \$5 billion bill for EPA grants and a \$6.6 billion revenue-sharing bill—both of which have already passed the House. Adoption of these bills (and the appropriations bills for them that must be enacted by October 1) poses an-

other danger for the smaller \$3.95 billion jobs programs, particularly if Ford vetoes the appropriation bill.

The mayors and governors are being urged to recommence their lobbying efforts on the three senators who cemented the bill together: (1) Jennings Randolph (D-W.Va.), who is Chairman of the Public Works Committee. The \$2 billion in his part of the bill allows the Commerce Department's Economic Development Administration to parcel out funds project-by-project with most getting \$5 million or less, and no state winding up with more than a \$125 million slice of the piece. The money can go for almost any kind of building or public works or recreation project—except canals. (2) Edmund Muskie (D-Maine), who shoved through the \$125 million for revenue-sharing grants to be parceled out over five quarters retroactive to July, mostly to cities with high unemployment. The money would be used to maintain public service by keeping employees on public payrolls. (3) Herman Talmadge (D-Ga.), who led the block of 66 senators from 33 Southern and Western states that would get a slice of the additional \$700 million in water pollution control funds.—*Donald Loomis, World News, Washington.*

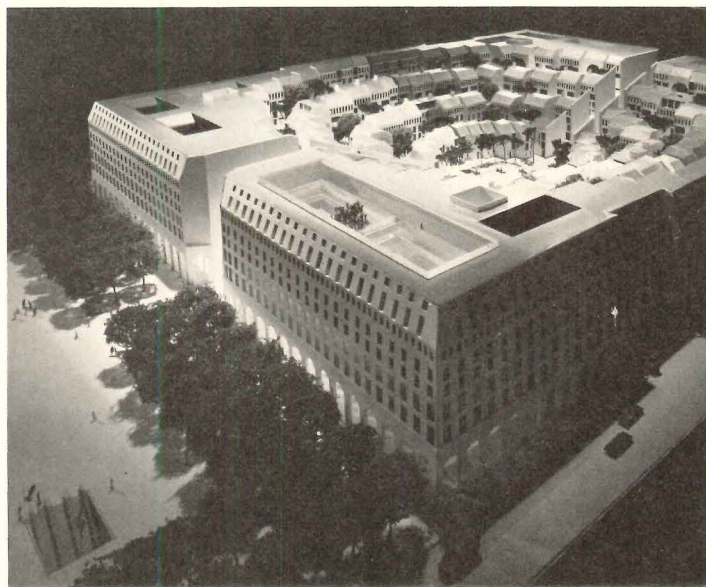

## At last, Pennsylvania Avenue project gets funds from Congress

Congress has finally put some money behind its plans to spruce up Washington, D.C.'s Pennsylvania Avenue. The House of Representatives has authorized \$38.8 million to begin restoration of the historic route between the White House and the Capitol. The Senate approved a similar bill last December.

First proposed more than 15 years ago, the plan calls for construction of both residential and commercial facilities, a mixture that should encourage people to come into Washington's downtown area. Congress has determined to avoid the mistake made in the construction of the city's L'Enfant Plaza, an office complex that empties after working hours. A total of 1,500 rental and condominium units (including the scheme above designed by Hugh Newell Jacobsen, RECORD, May 1974, pages 117-119) will be built about midway between the Capitol and the White House. The project is expected to require \$130 million in Federal funds over the next 15 years and to attract about \$400 million in private investment.

## Justice attempts to re-open antitrust case against ASCE

The Justice Department is trying to re-open its antitrust case, ended in a consent decree four years ago, against the American Society of Civil Engineers. The case was the twin of the Justice prosecution of the American Institute of Architects, both challenging professional code of ethics prohibitions on price competition.

Each society rewrote its code to remove the bans on price bidding, although the National Society of Professional Engineers elected to fight the issue and is currently at the United States Court of Appeals in Washington with its case. What Justice is now arguing is that the ASCE code revision did not go far enough, and that more changes are needed to open the way for one member to bid against another.

Being questioned is what is now

Federal money will be used to purchase and restore the historic Ward Hotel, a building where many Presidents stayed but which has been closed since 1968. The current owners had planned to remove the structure's ornate facade and convert it to an office complex.

The Senate version of the bill authorized the full \$130 million in Federal funds, but, to speed things up, the Senate says it will now consider the House-passed measure. Passage is most certain, and the Ford Administration also backs the bill.

To get the money flowing, Congress would either pass a special appropriations bill after the November elections, or it would wait and provide for the project in appropriations for fiscal 1978. In either case, money could presumably be used as soon as it comes available. The Pennsylvania Avenue Development Corporation, which will administer the project, has been functioning for four years, since Congress first approved redevelopment plans.—*Judith Dobrynski, World News, Washington.*

Article Three of the ASCE code, which holds it to be unprofessional, dishonorable, and undignified for any "engineer" to attempt to supplant another engineer in a particular engineering after definite steps have been taken towards his employment." Justice claims that since the ban on competitive bidding was removed, the society has used the don't-steal-client provision to bar price competition and has "aggressively investigated alleged violations of Article Three."

The Government's case rests primarily on Society disciplinary action taken against two top officials of M&E, the Boston-based design firm that is a subsidiary of Research Cottrell. ASCE dropped Franklin Sunn, then president, from membership for three years and vice president George K. Tozer for two. The charge was that M&E had won away—by derbidding—a design review and



tion services contract for the gkok water system that a joint ven- of Black & Veatch International Camp, Dresser & McKee had ally negotiated a contract on.

Justice calls the action against n and Tozer evidence that ASCE is obeying the 1972 court order that it will not adopt "any plan, pro- n or course of action which pro- ts members. . . from at any time mitting price quotations for engi- ring services." The antitrust law- are asking that the Society be held ontempt of court for not obeying order, and be punished by being ered to drop Article Three from its e—as well as reinstate Sunn and er.

The Society, suggesting it will t the action, claims that the issue of ng to supplant another engineer is entirely different one from price mpetition. BVI managing partner mas B. Robinson, however, admits price "was the wedge by which y got the ear of the client." —Dan- Moskowit, *World News, Wash- on.*

**Chicago neighborhoods for landmark status**

ne of Chicago's best historical ar- chitecture comes to life in such major le buildings as Henry Hobson ardson's Glessner House or Louis ri Sullivan's Carson Pirie Scott & Building. And charged with identi- g and preserving the city's quality itecture, the Commission on Chi- o Historical and Architectural mmarks, with City Council ap- val, has designated many of these ctures as landmarks. But in the past r or two, the commission, respond- to public sentiment, has increas- y turned its attention to Chicago's itecturally significant residential hborhoods to be named landmarks areas instead of individual build- s.

In this endeavor, according to ar- ctect Daniel Brenner, the commis- n's work "is considerably behind w York City," which has designated eral hundred buildings as land- ks. Brenner sits on the Council's isory board and is a principal of nner-Danforth-Rockwell, Chicago.

One example of such a neighbor- d is the six-block-long Astor Street trict, approved by City Council as a dmark last December. Architects esented in the district include such sters as Frank Lloyd Wright, Joseph an Silsbee, and Stanford White, of Kim, Mead and White. Three ped- l styles—the Queen Anne, the ardsonian Romanesque, and the rgiarian Revival—dominate Astor et, located in the city's near-north . Still more areas that boast the k of the Chicago school's George ner, and Adler & Sullivan, for ex- ple, are under consideration.

The trend toward making land- ks out of neighborhoods has pre- ably aroused the ire of developers,

who claim such designation unduly restricts free enterprise. Leonard S. Eisenberg, a senior vice president at Arthur Rubloff & Co., one of Chicago's major owner-developers, says landmark designation of neighborhoods drives new construction to the suburbs. Despite developers being hampered severely by the slack demand for multi-family housing, Eisenberg says, the landmark areas add still another thorn to what he calls restrictive zoning on the city's lakefront and high-rise building codes that add to costs. "Pretty soon they'll declare the whole city a landmark and then it'll all decay at the same rate" he says.

But Brenner says Eisenberg's claims "are a lot of hogwash." The only case the commission has lost, he says, came when Adler & Sullivan's Old Chicago Stock Exchange was demolished to make way for a new high-rise office building. According to the Chicago commission's staff, the neighborhood trend will continue; director William M. McLenahan says the advisory committee has advised that "60 or 70" more buildings, including many neighborhoods, be considered for landmark designation.

Brenner says reactions of residential real estate owners to having their property named a landmark varies widely. In some cases, owners find designation strengthens rent demand, he says, but other claim it can hurt their ability to refinance a mortgage. At any rate, Brenner says public sentiment, and as a result, political momentum, currently favors preservationists. "There will always be some fights, but at the moment, high-rise is a dirty word to the public," he says.

Following the designation of Astor Street, the commission recommended to the City Council that two more neighborhoods receive landmark status. They are a one-block area known as the Jackson Boulevard District and a ten-square-block neighborhood called the Mid-North District. Furthermore, the commission is considering designation of three more city neighborhoods—the McCormick Row House District (part of the Old McCormick Seminary), the Hutchinson Street District, and the Old Town District.

Throughout the Mid-North neighborhood, styles popular in residential structures from 1850 to the late 1880's can be seen: the decorative detail of the Italianate style, the color and texture of Queen Anne facades, and the round arches and rough masonry made popular by Henry Hobson Richardson. And in the area next nearest to landmark designation, the 1500 block of West Jackson Boulevard in Chicago, the same general styles are evident, in addition to the Second Empire style with its high mansard roofs. This charming little enclave, however, is probably safe from destruction even if it does not receive landmark status, because young, middle-class families have bought into it and will most likely protect it.—*Daniel Brown, World News, Chicago.*

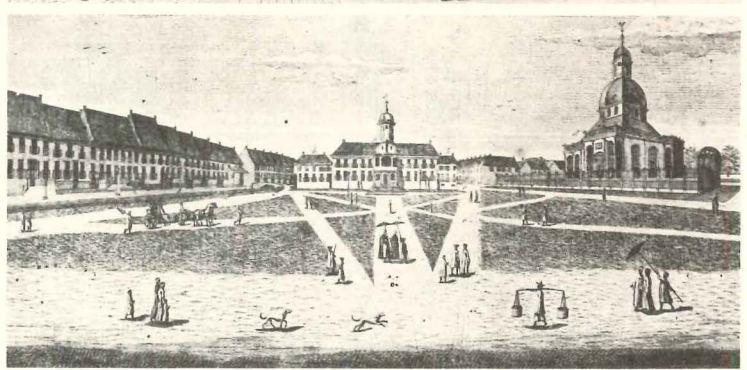

**Port city of Jakarta continues major restoration project**

A few years ago, the United Nations sent industrial designer Sergio Dello Strologo to Jakarta to help the Indonesian government improve its labor-intensive industries. After a realistic appraisal, Dello Strologo chose to concentrate on traditional ethnic crafts (crafts being the main potential for export in an area with some of the world's finest artisans); and he went about advising the Indonesians on how to market and thus capitalize on their indigeneous arts.

Now, eight years later, the Jakarta government headed by Governor Ali Sadikin has discovered other ways to use Dello Strologo's expertise. With guidance from this Italian-born American (who also oversaw a restoration project for Kingston, Jamaica), Jakarta now has a major restoration project of its own—a project that is sure to spur economic development via the internal and international tourism engendered, and that, more importantly, is instilling civic pride in the city's past. From its 15th century beginnings, Jakarta has been a wealthy, cosmopolitan port and a long-time headquarters of the spice trade. Its history was greatly influenced by the Portuguese, British, French, Chinese, and Dutch.

Initially, the restoration of Jakarta was limited to the old town square. Under the direction of Project Officer Ir. Tjiong, the architects and designers closed the square to traffic and reproduced its original layout with lawns and a radial pattern of stone paths. A central cistern was restored over foundations uncovered during construction; and a cannon locally thought to induce fertility by touch was re-installed. Stadhuis, the Dutch

city hall was restored as the Museum of Jakarta, a monument celebrating the country's Indocentric history. And the original Justice Court House was turned into a performing arts center.

For the Jakartans, however, all this restoration was not enough; and according to Dello Strologo, "The enthusiasm of the intelligentsia of the city forced us to enlarge the project to include the ancient port of Sunda Kelapa."

Work on phase II has now begun: Plans have been laid and the zone has been declared historical. Eventually, houses down the canal leading to the old port Pasar Ikan (fish market) will be refaced in 17th and 18th century styles, enhanced by street signs reminiscent of the same era. A 240-year-old mosque will be restored, while two old warehouses of the Dutch East India Company will become museums of maritime and of spice trade. Nearby, a group of 17th century Chinese houses has been earmarked for restoration as a museum detailing one of the earliest settlements of Chinese outside their own country. And out in the bay, four islands, formerly a naval base, will become a "marine playground" for tourists to enjoy bathing, water skiing and sailing.

Primarily funded by the governor's office of Jakarta, the restoration project has catalyzed enthusiasm throughout Indonesian "hill-country" itself. "Jakarta has always been a style-setter," Dello Strologo says, comparing its development to that of New York. And already, other places are heeding Jakarta's pace: The city of Surabaya is planning its own restoration and Makassar has already finished restoring its old fort.—*Harriet Sugar.*



# TAKE A GOOD CLOSE LOOK AT Cem-FIL® AR GLASS FIBER, GLASS REINFORCED CEMENT...



## IT'S NO PIPE DREAM.

GRC (Glass Reinforced Cement) is a reality. In fact, Cem-FIL AR Glass Fiber is the fiber that has made GRC possible. It's the first and only fiber extensively field tested and proven alkali resistant. When combined with cement, the result is a relatively lightweight and exceedingly versatile building material.

This label is your guarantee of GRC integrity.



It assures that Cem-FIL AR Glass Fiber has been used as the reinforcing agent in the product that bears it. It also implies the highest degree of GRC technology and quality control in the manufacturing process. This label is found only on GRC products incorporating Cem-FIL AR Glass Fiber, available from a growing list of licensed GRC producers.

A few of many GRC applications:

### NO. 1 — LOW PRESSURE PIPE

Low pressure GRC pipe, manufactured through conventional concrete pipe production methods but providing a number of benefits including reduced transportation cost and an in-wall joint which affords savings in trenching and laying costs.

### NO. 2 — SYSTEM BUILDING

Manufactured housing incorporating GRC exterior panels for upper and lower stories.

### NO. 3 — SURFACE BONDING

Surface bonding of dry laid concrete block walls with skins of pre-mix GRC trowel or spray applied.

If you'd like to know more about GRC, its many applications and its availability, write or call.



2

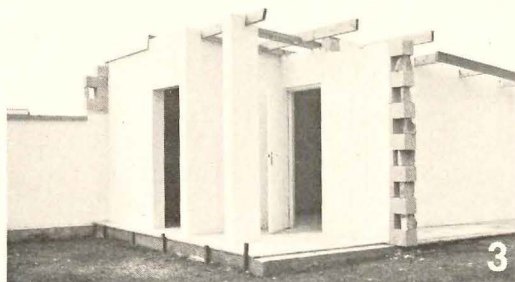

3

**cem-FIL®**  
CORPORATION

Two International Plaza Drive  
Nashville, Tenn. 37217  
(615) 361-4664

**When you specify GRC products, specify GRC reinforced with Cem-FIL® AR Glass Fiber. There is no equal.**

See Sweets General Building (Architectural File) 7.5/Cem



Associates

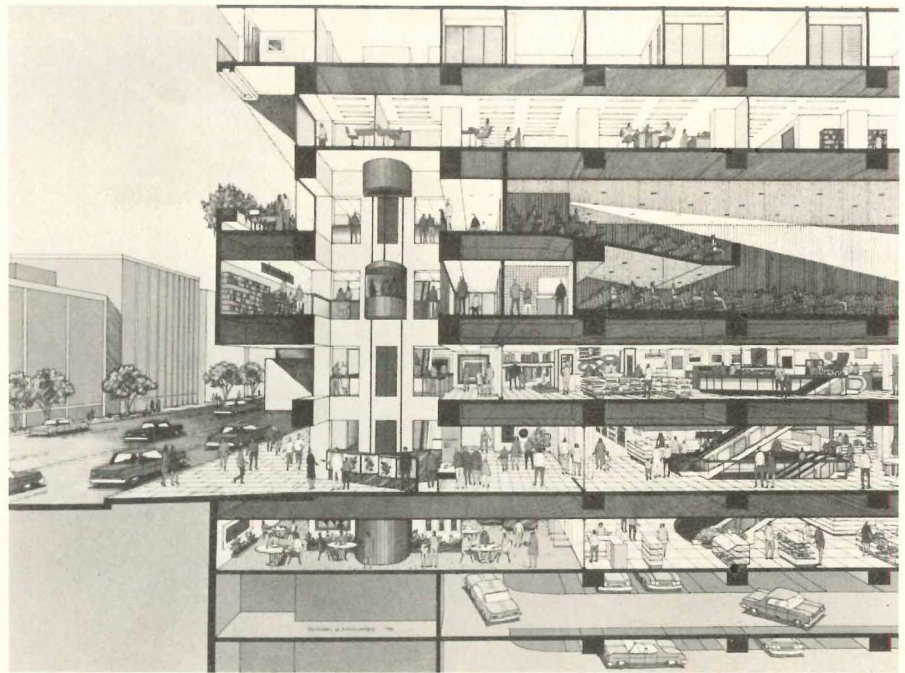
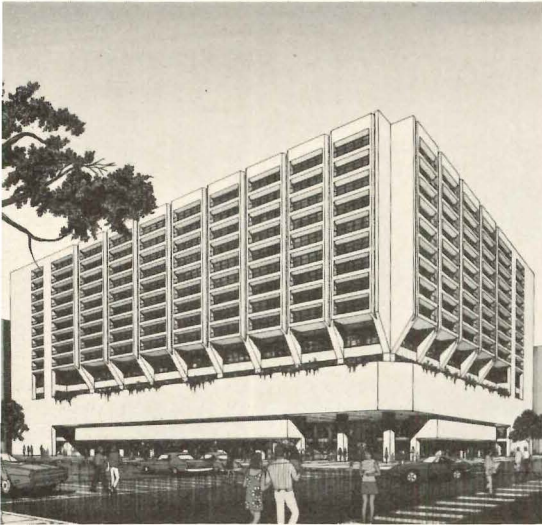

**Use structure to go up in Taiwan's bustling capital city**

As a city burgeoning with new developments, Taipei, Taiwan, will soon be getting a new, state-of-the-minute, multi-use structure. The L-shaped building will contain: 1) three basements, the two lower for parking and the top for a supermarket and bakeries; 2) four commercial

floors, the lower two housing a department store and small shops and the upper two including an 800-seat cinema, a small music house and several restaurants and clubs; 3) an office floor for shop owners on

the fifth level, and 4) ten upper floors of apartments. A four-story-high vertical lobby, with a glass elevator and a series of escalators, will interconnect the four activity floors. Due to the long span requirements of

these lower levels, the structure changes at the fifth floor: supported by brackets at the exterior bay, the level is designed as a Vierendeel truss. The exterior is hand-chiseled exposed concrete.

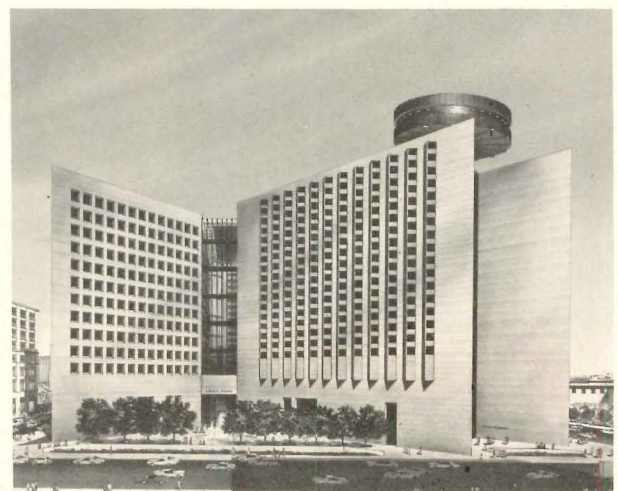

**Joint Venture III designs new Hyatt complex**

A new 500-room Hyatt Regency Hotel and two 16-story office buildings make-up the Merchants Plaza Complex, to be built in Indianapolis. Designed by Joint Venture III (Koetter, Tharp & Crowell; Caudill Rowlett Scott; Neuhaus + Taylor), the three buildings are juxtaposed diagonally, their walls creating a natural atrium that, glazed and roofed, will serve as the major entrance, in Hyatt's typical grand style, to all the complex. The lower three levels of the hotel are ap-

proximately one-half retail space, with small shops and restaurants on the ground floor. The skating rink shown at left has been deleted for financial reasons but will be replaced by a raised lobby bar. An escalator zigzags up the atrium space, carrying passengers to the second floor where they cross the atrium via a bridge and continue the ride to the next level. Another lobby bar, landscaped with live trees and plants, is located here. The complex contains 1,325,000 square feet.



# "Why do I think GAF<sup>®</sup> Mineral-Shield<sup>®</sup> Roofing is so hot? Because it's cold-applied and that makes a big difference."

## Bill Steinmetz

Chairman  
Midland Engineering Company, Inc.  
South Bend, Indiana



"A play on words, hardly," Mr. Steinmetz continues. "We've been thinking cold around our company for over six years now. With some 400 cold process roofing jobs under our belt, we know that Mineral-Shield roofing performs. Not only can we recommend it with complete confidence to our customers, but we have also found through our extensive job experience that there are many advantages and benefits to the roofing contractor.

"Because Mineral-Shield is cold-applied, the need for heating kettles and tankers is eliminated. Also gone are hot luggers, felt layers, and gravel spreaders. In fact, a contractor's job equipment needs are reduced substantially and the cold process application equipment can easily be towed to the job site by conventional pick-up truck. The economics of this are obvious...less handling, faster job set-up, less equipment maintenance, not to mention the elimination of lost time due to accidents or burns.

"What really sold us on GAF Mineral-Shield Roofing system is that it works! And after all, that's the name of the game whether you're looking at it from the point of view of the owner, roofing contractor, or architect."

GAF Mineral-Shield is a modern cold-applied built-up roofing incorporating multi-ply of roofing membrane plus layers of roofing mastic and a surfacing of white mineral granules, usually applied by mechanized spray equipment. All components—roofing membrane, mastic and granules—are factory-finished under rigid GAF quality control. A Class "A" Underwriters' Laboratories Rating is available. Guaranteed by GAF when applied according to published specifications.



GAF Corporation  
Industrial Roofing and Waterproofing,  
140 West 51 Street,  
New York, New York, 10020

Please send me further information on  
GAF Mineral Shield Cold-Applied Roofing.

Please have a representative call.

TA-AR-96

Name \_\_\_\_\_

Firm \_\_\_\_\_

Address \_\_\_\_\_

City \_\_\_\_\_ State \_\_\_\_\_ Zip \_\_\_\_\_

## GAF<sup>®</sup> Mineral-Shield<sup>®</sup> Roofing

For more data, circle 28 on inquiry card



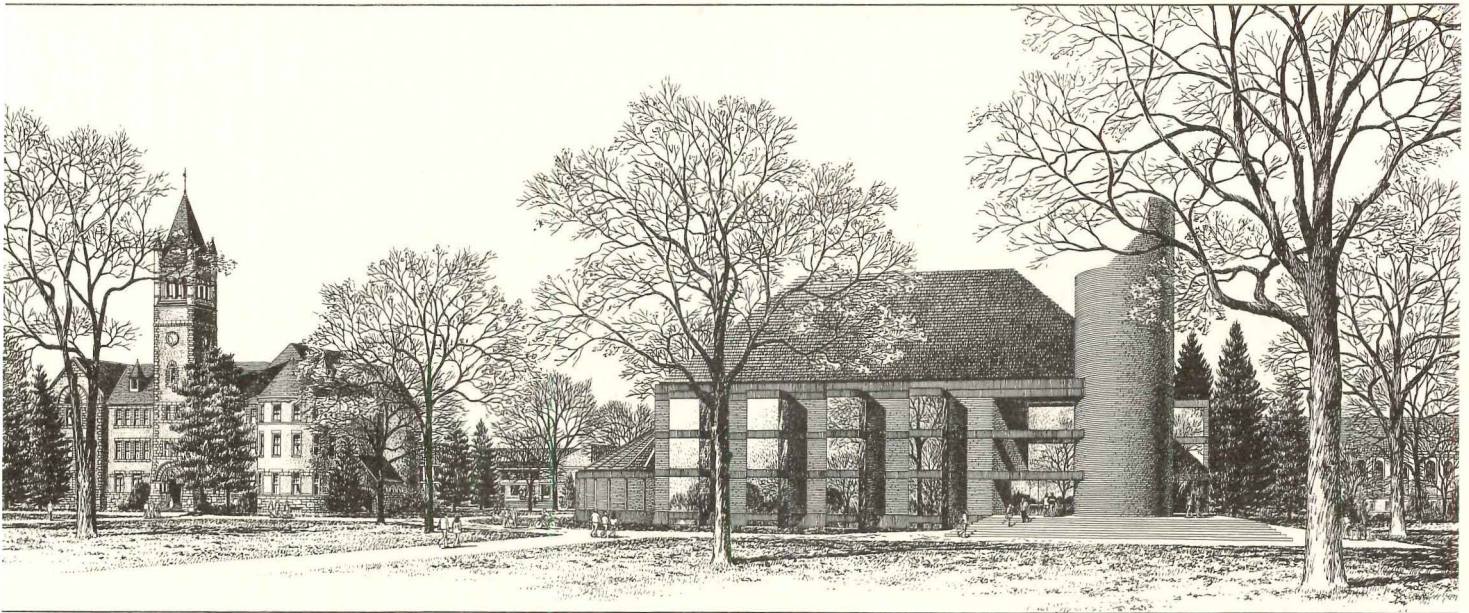

### burg campus to get new library by Jacobsen

Gettysburg College in Pennsylvania has plans for a new centrally located library that, though contemporary, will harmonize with its early-nineteenth-century environs. Using

pitched slate roofs, burgundy-colored brick, and broad, gently-pitched entry steps, architect Hugh Newell Jacobsen designed the building to blend with the campus' traditional

character and scale. The interior design is open-plan, and includes tinted glass bays that provide broad vistas to surrounding lawns and buildings as well as a rhythmic facade.

### mental center to be built in Rochester

ew Eastman Dental Center relocated on a site adjacent to the University of Rochester Medical Center was designed with an emphasis on a multi-faceted exterior to reflect interior functions. Architects Richard Foster and Michael Morstl, in designing this building that houses clinics, diagnostic facilities, and experimental laboratories, placed the intense use such as the X-ray section and auditorium nearest to the entrance. Solid walls, colors, con-

temporary furniture, innovative lighting and foliage such as that in the center of the circular clinics diminish the traditional "medical" atmosphere. Other major clinics are also on the ground floor, with adult and staff facilities on the second floor. For the economy of locating mechanical services vertically, laboratories were placed on four smaller floors that form a tower over the lobby area. The angling and height of this tower makes it the focal point of the surroundings.



### Minneapolis bank gets an indoor "oasis"

This indoor tropical garden in Minneapolis, designed by Lawrence Halprin & Associates as a "year-round oasis," has replaced the 3½-story-high main banking floor of the old Federal Reserve Building. Located on what is now the second floor of the National Bank Building, the public Garden Court is accessible from outside via an elevated walkway. Replete with plants, waterfalls, and running brooks, the 500-sq-ft garden is completely dependent on artificial light. Design of the garden required demolishing the existing interior of the Reserve's lower floors. In addition, the bank's vault—3-ft-thick concrete reinforced with armor plates and steel bars—had to be cut through.



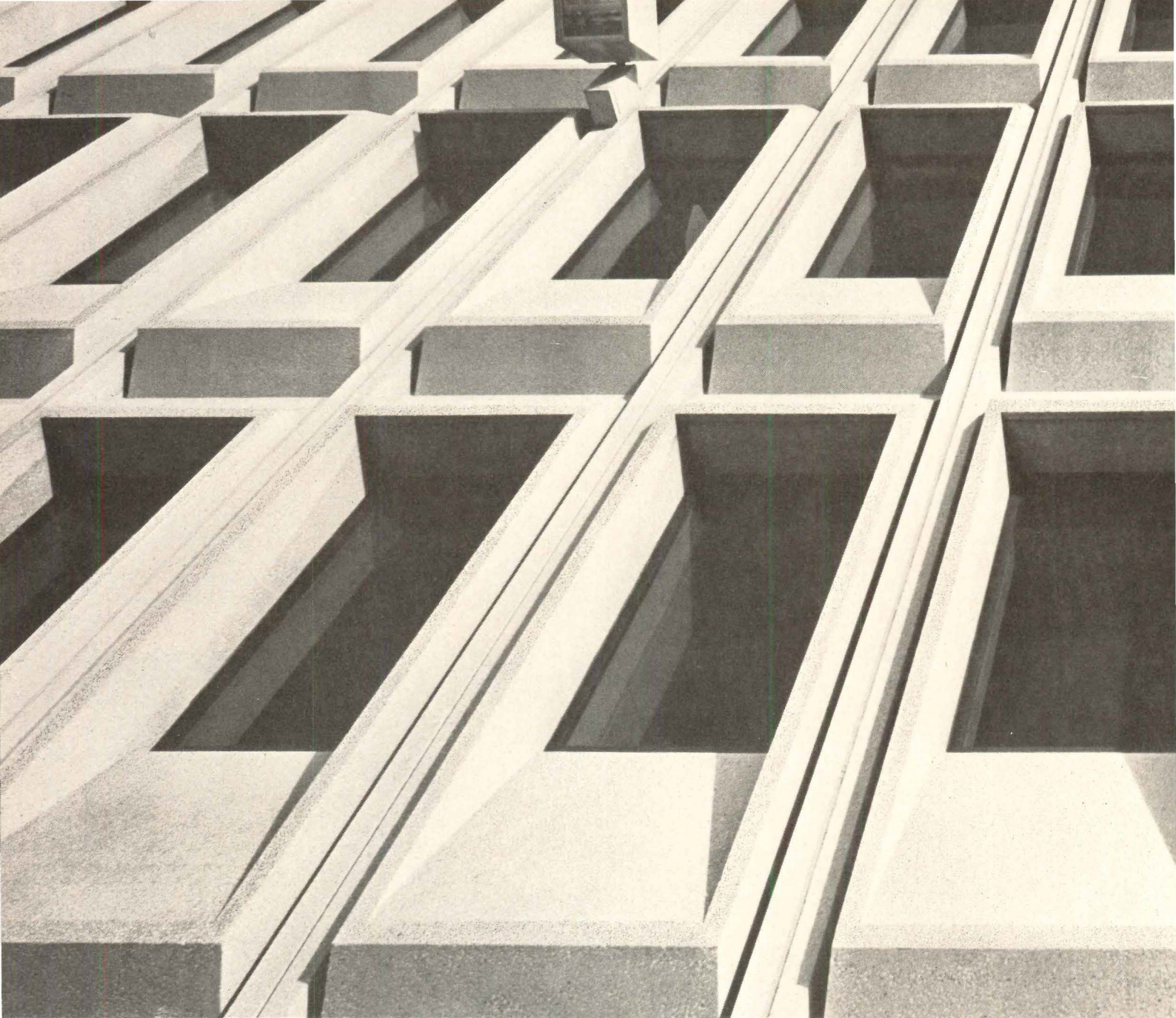

# Now...glazing that without going

That's LUCITE® AR abrasion resistant sheet. This high-quality glazing material resists vandalism and breakage. And more — "Lucite" AR has a tough, clear fluorocarbon hide that makes it 15 times harder to abrade and haze than conventional plastic sheet.

Which means the glazing you specify can be cleaned year after year without losing its clarity. And exposure to all kinds of

weather conditions leaves "Lucite" AR essentially unchanged.

These are the major reasons why Robert Moran, a West Orange, N.J. architect, specifies "Lucite" AR for school buildings such as the Essex County Technical Careers Center in Newark, N.J. And why an increasing number of urban school districts, from Philadelphia to Atlanta, are specifying it.

You can get "Lucite" AR in

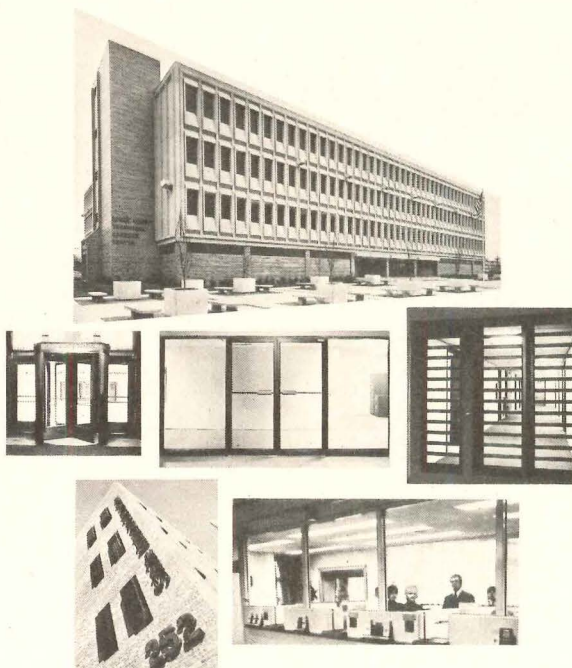

Glazing applications of "Lucite" AR in public institutions, banks, door lights and partitions.



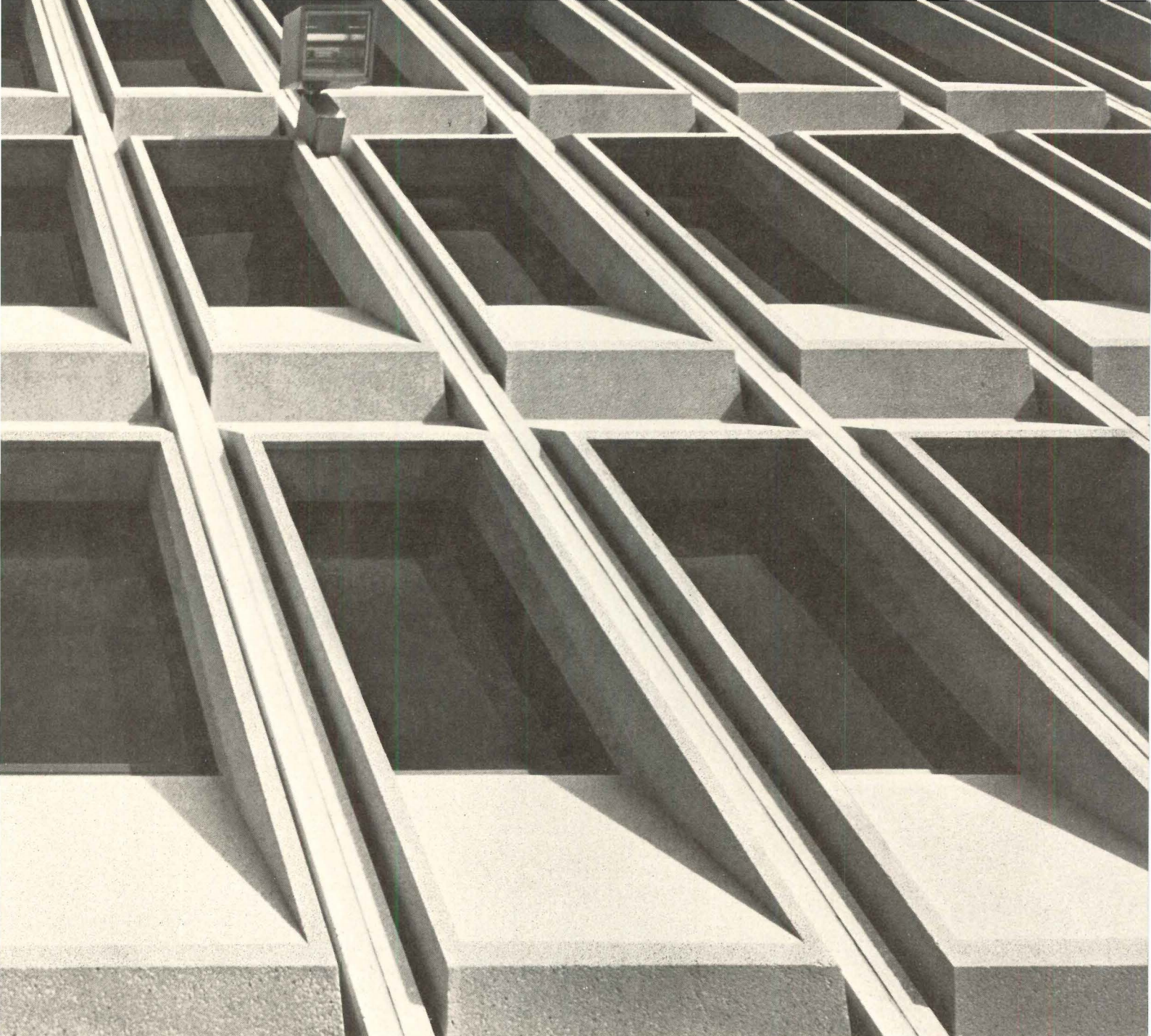

Essex County Technical Careers Center, Newark, N.J. Robert Moran, Architect

# gets tough on vandalism soft on abrasion.

olar tints to reduce air conditioning loads. Its low heat conductivity (K1.2) reduces winter heat loss. It is thermoformable and easily fabricated to meet our design requirements.

"Lucite" AR complies with ANSI Z97.1 1966/72 performance specifications for safety glazing used in buildings. It is finding increasing application in security glazing in banks, public institutions, and in bus

shelters, animal enclosures, door lights, partitions and hockey rinks.

Look for us in Sweet's Catalog (8.26/Du) or check "Lucite" AR abrasion resistant sheet yourself. Let us send you a test kit that demonstrates the abrasion resistance of "Lucite" AR. Write: Du Pont Company, Room 24940, Wilmington, DE 19898, or call (302) 774-2629.

The difference is clear with  
**LUCITE® AR**  
ABRASION RESISTANT SHEET





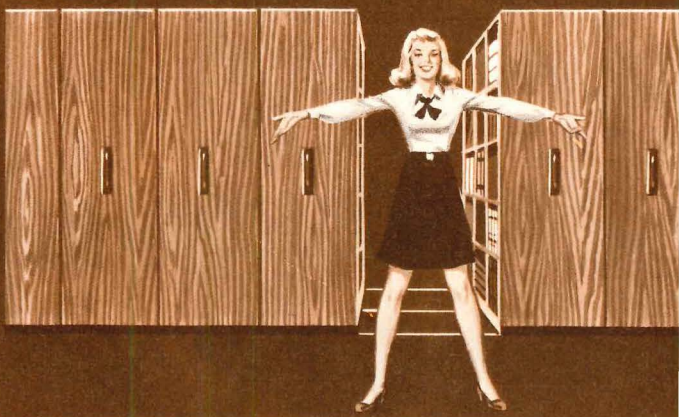
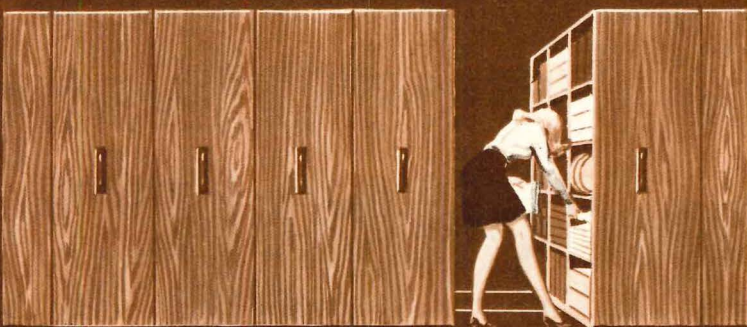
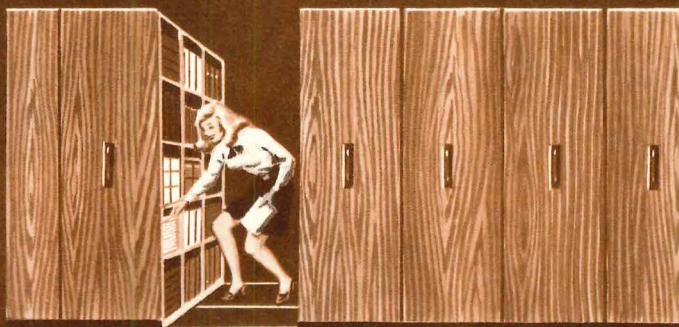
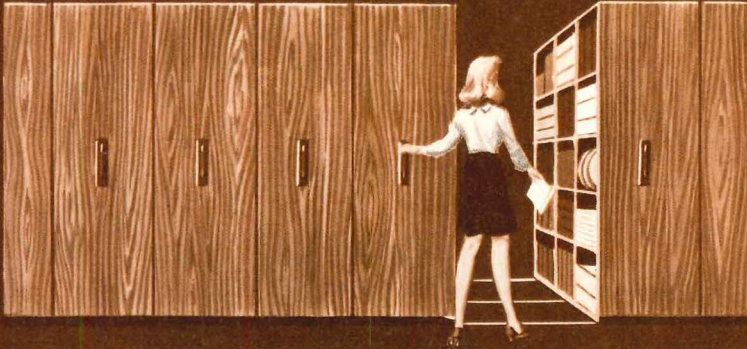

# FULLSPACE... the file with the movable aisle!

If you tried to provide your clients with this much storage or file space using ordinary files or shelves, you'd need 6 aisles and up to 4 times the floorspace. FULLSPACE does it with just one aisle that opens where it's needed. Furthermore, when the aisle is opened, all the space on both sides is exposed, greatly reducing access time.

But there's more to FULLSPACE than space-saving and efficiency. High quality finishes in handsome wood grains or colored laminates create handsome furniture that complements any decor.

*Want more information? Write today, or call us collect.*



**LUNDIA**  
The World's Record Holders

LUNDIA, MYERS INDUSTRIES, INC.  
Lafayette & Capitol Way  
Jacksonville, Illinois 62650  
217/243-8585

*For more data, circle 30 on inquiry card*



**ale of two cities**

*100 Years of Architecture in Chicago*, by Oswald W. Sobe, Peter C. Pran, and Franz Schulze; J. Philip Hara, Chicago, 1976, 191 pages, \$17.50.

*Chicago Architects*, by Stuart Cohen, with an introduction by Stanley Tigerman; The Swallow Press, Chicago, 1976, 120 pages, \$6.95.

Reviewed by Richard B. Oliver

Two recently published exhibition catalogs which describe a rich architectural scene in a notable American city. In each catalog, the city in question is Chicago, although a reader might swear he was reading about two entirely different cities. In fact, the reader is receiving two entirely different views of the same city, and two entirely different notions about what constitutes an architectural scene, and what constitutes architectural history.

During the last few years what was once a kind of guerrilla warfare against the impregnable bastions of modern architecture has expanded into a full-fledged civil war (though a war that often resembles a chic parlor game). "Is modern architecture dead?" as a hotly debated issue, is the clear successor to that pathless question of the 1960s, "Can our cities survive?" Nowhere, to my mind, have the battle lines and issues of this altogether serious architectural debate been made so vivid and so compelling as in these two books which describe the same one hundred years of architectural development in the same American city.

*100 Years of Architecture in Chicago*, by Sobe, Pran, and Schulze, is a thoroughly orthodox view of Chicago architecture. The book includes a review of all the great monuments—the First Chicago School (1871-World War I)—the Reliance and Monadnock Buildings, the Auditorium Theater, the Rookery, the Marshall Field Warehouse, and others—and makes the influence of Richardson, Jenney, Sullivan, and Wright. There is a four-page play on Chicago architecture between the two. The remaining bulk of the book is devoted to the work of the Second Chicago School (1938-present), which is completely dominated by the presence of Mies. There is a great emphasis on the high-rise building (both office and apartment), and the "great hall" or universal space." The canonical Crown Hall and Lake Shore Apartments are included, along with the Sears Tower, the John Hancock, and the towers and plazas along Dearborn Avenue. The one unswerving criterion for inclusion in this book is that the form of a building

Richard B. Oliver is an architect who practices in New York.



"Miralago," by George Fred Keck (1929)



Illinois Institute of Technology, by Mies van der Rohe (1940-72)

must result from structural clarity, and a direct expression of function.

*Chicago Architects*, by contrast, is the revisionist view of the "young Turks." The primary bias of author Stuart Cohen has been to include a number of notable and fascinating (and perhaps great) buildings not included in the orthodox histories of Chicago. Here are works not previously appreciated because they were built between the Columbian World Exposition in 1893, and the arrival of Mies in Chicago in 1938, a period of time in which Siegfried Gideon would have us believe that the only project of value was the Gropius and Meyer submission in the *Chicago Tribune* Competition. The book is amply illustrated with such examples as the eclectic architecture of Howard Van Doren Shaw; the avant-garde (and often Internationally-Styled) projects of George Fred Keck, such as his House of Tomorrow and Crystal House at the 1933 Century of Progress Exhibition; and the Art Deco and Streamlined splendors created by Holabird and Root. There are even buildings which are Miesian, but, ironically, not a single Chicago building by Mies himself is included.

The former book is unabashedly orthodox, complete with the jargon of a party-line gone stale. The book rides a fine line between

being a dull rehash and a suave recap of what almost everybody already knows (anyone, that is, whose architectural history courses featured heavy doses of *Space, Time, and Architecture*). The latter book is nothing if not *au courant*, brimming with an energetic David and Goliath air of having pulled off a coup, full of a Lewis and Clark sense of having discovered a whole new collection of *objets trouvés*. To say, however, that one book represents the "bad old guys," and the other the "good new guys" would be misleading and altogether inappropriate.

*100 Years* and *Chicago Architects* are, in fact, strongly complementary, and the chance to see one against the other is very provocative. *100 Years* sees architectural history as a Gideonesque revelation of a single primary line of development with individual examples included or excluded as a function of how well each supports the theory. *Chicago Architects* subscribes, instead, to the E. M. Forster view of history as a series of messes, and seeks to include a diverse set of works without much urge to weave a consistent tale. The former book views the Chicago scene as one characterized by a brilliant singularity of direction. The latter book views the brilliance of the scene in terms of its resonant and often crazy diversity.

Each book is curiously incomplete. What is missing from each book is most easily found in the other—two books co-existing and interdependent, like yin and yang (or a horse and carriage). Even members of the two casts of characters appear in both books. Especially fascinating is Walter Netsch, who in *100 Years* is solidly in the classicizing Second Chicago School, while in *Chicago Architects*, he appears as one of a band of eccentric romantics. Or Charles Atwood, who designed the Reliance Building in 1894, surely a seminal building in Gideon's theory, but who a year earlier designed the neoclassical Hall of Fine Arts for the Chicago Fair, a building regarded by Augustus Saint-Gaudens as the finest since the Parthenon.

Although the two books do not, in my opinion, represent "bad-guy/good-guy" positions, the books are not of equal quality. *100 Years* suffers from just plain smugness—from the tone of the text, to the steel gray and black cover, to the price tag—and from the lack of a fresh approach to familiar material. By contrast, *Chicago Architects* is so full of wonderful new material that one can ignore, and even sympathize with, an underlying tone of indignance and impatience (and even despair that Gideon will ever be routed) that pervades Cohen's very scholarly and meticulously researched essay.



# Insulation is

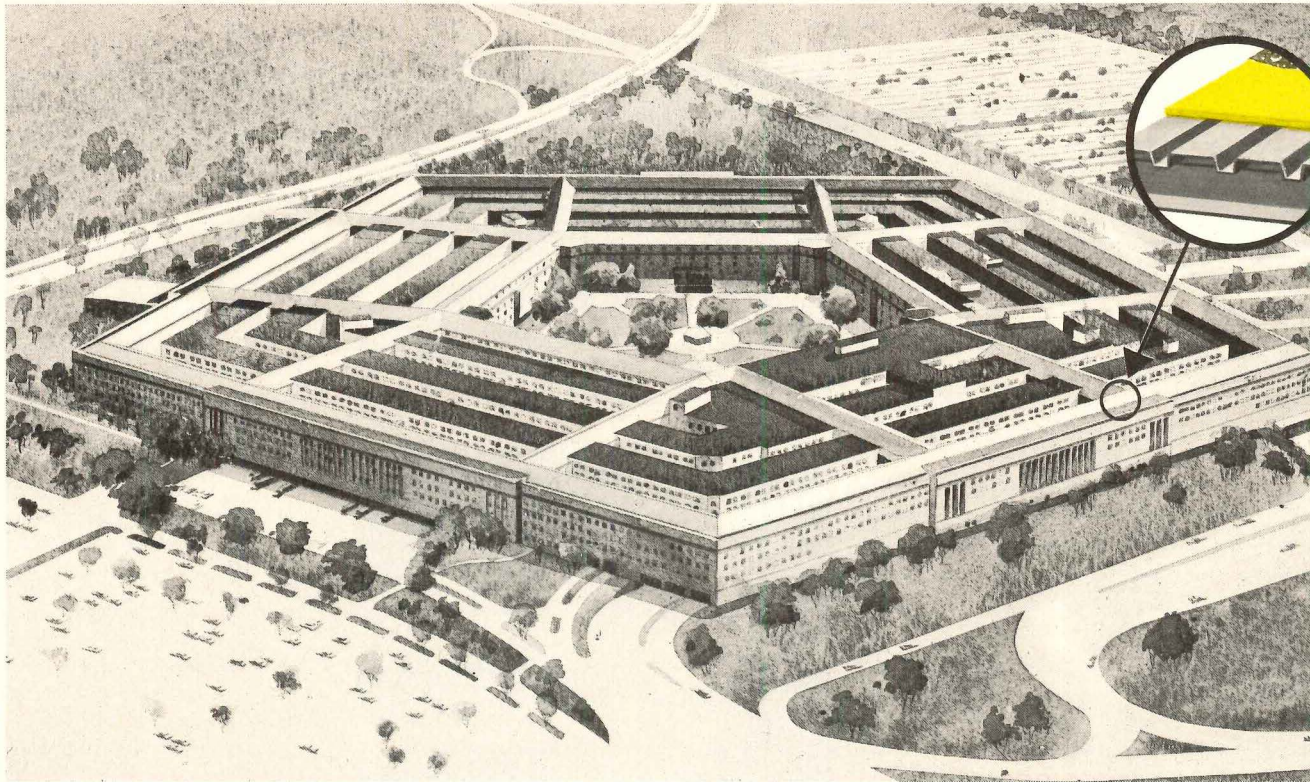

Projected cost to heat and cool the Pentagon for the next 20 years, if it were built today using only 15/16-inch Fiberglas roof insulation:

## \$2,541,454



**Owens-Corning Fiberglas roof insulation — the only glass fiber roof insulation on the market.** Dimensionally stable. Retains thermal value. Easier to apply than organic/mineral boards. For over 30 years, the *best* base for built-up roof decks.

**T**he Pentagon—world's largest office building.

If it were being designed by today's architects for today's soaring heating and cooling costs, I trust it would have the specifications of the version on the right.

This version has a full 2 1/4" layer of roof insulation, instead of the thinner layer that has been used for offices, schools, stores and other commercial buildings for the past 20 or 30 years.

Using thicker 2 1/4-inch Fiberglas

\*T.M. Reg. O.-C.F.



# Cheaper than oil

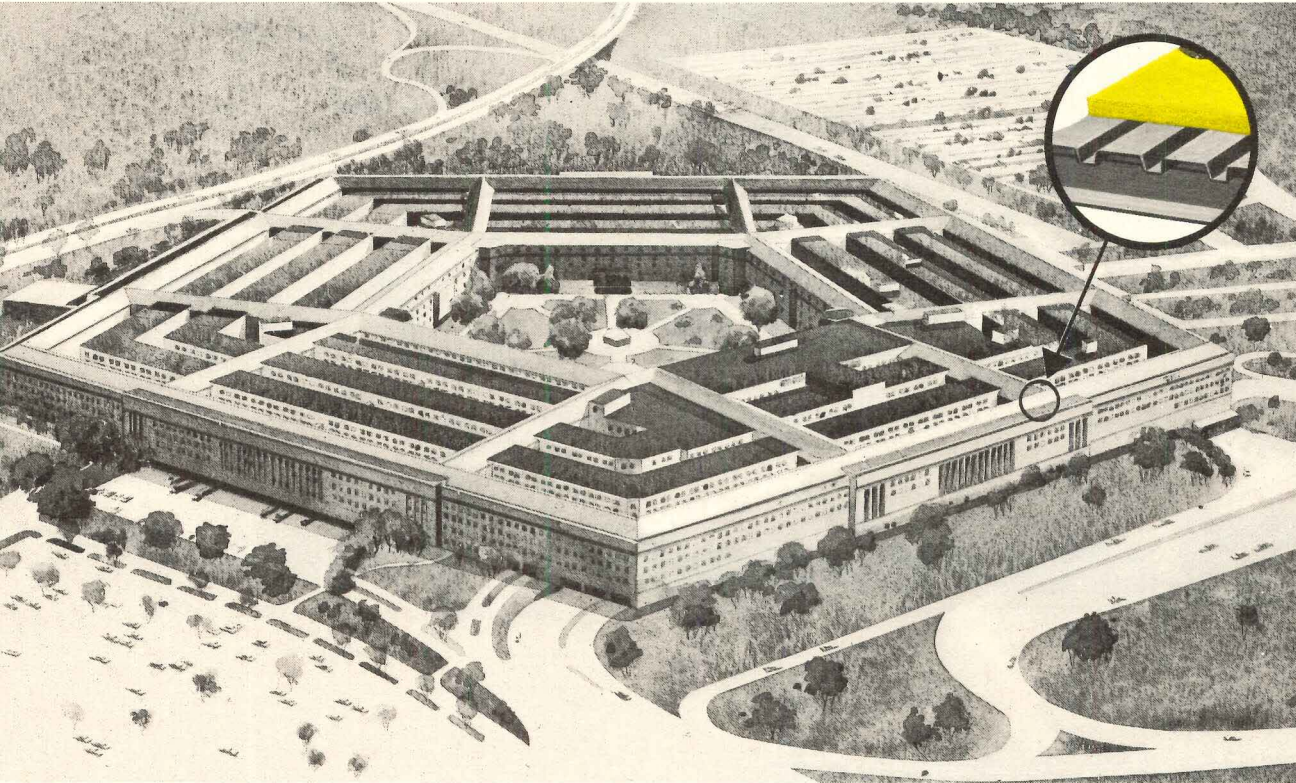

Projected cost to heat and cool the Pentagon for the next 20 years, if it were built today using thicker 2¼-inch Fiberglas roof insulation (after allowing for the cost of thicker insulation!):

## \$1,207,500

Insulation saves money two different ways:

### A saving of \$1,333,954

It saves on energy costs. Estimated savings per year, based on heat and electric cooling in the Washington area, with a projected rise in energy costs at 7% per year and estimated future savings discounted at 10% per year: \$66,697 per year. Total savings: \$1,333,954 every 20 years.

It saves on construction costs. Estimated first cost of this en-

ergy-tight Pentagon would be *lower* than if the less efficient version were built! Reason: the improved thermal performance of the roof would permit use of smaller-capacity, *less costly* heating and cooling equipment. Amazingly, the estimated savings would be large enough to cover the added cost of the thicker roof insulation *twice* over.

Important: Thicker Fiberglas roof insulation also makes sense when it's time to re-roof *existing* buildings. It should pay for itself in a few

years, then go on saving thousands in fuel bills for years to come.

### Ask our "talking" computer

Our EMS II (Energy Management System) computer can give you savings figures on your next roofing job — by phone! You'll get projected energy *and* equipment savings, plus *payback* period. (Actual savings may vary.) For details, call your local O.-C.F. rep. or write: I.C. Meeks, Owens-Corning Fiberglas Corp., Fiberglas Tower, Toledo, Ohio 43659.

Owens-Corning is Fiberglas

OWENS/CORNING  
**FIBERGLAS**  
TRADEMARK ©



# STOP SOFFIT STAINS!

with Fry's Drip Screed for Plaster or Drywall

Ugly soffit stains often spoil an otherwise beautiful job. They also rob you of time and dollars spent on callbacks. Fry Drip-Screed used as a drip mold protects you from soffit stains, also gives you cleaner, razor sharp edges. Now available vented, too, to permit greater air circulation and compliance with codes. Made of rugged extruded .050 aluminum with clear plastic coating (per Federal Specification TT-E-529 Class B). For detail sheets and/or samples, write today.

FRY REGLET CORPORATION  
801 West Milford Street, Glendale, California 91203  
Phone: (213) 245-9471

**FRY REGLET** Corporation

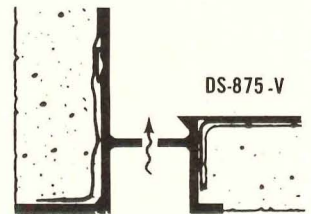

DS-875-V

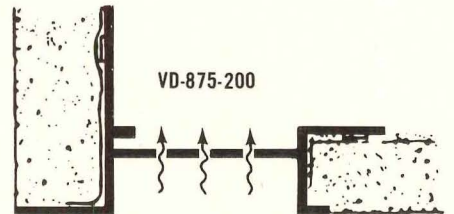

VD-875-200

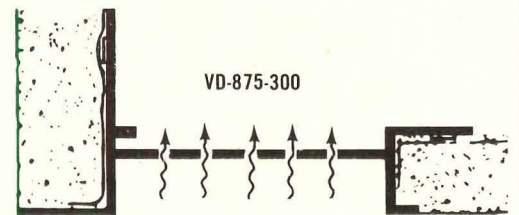

VD-875-300

For more data, circle 32 on inquiry card

## "Olympic or equal."

When you specify "Olympic or equal," we sure hope you get what you want.

Because for quality, beauty and the tough guarantee your customers deserve, nobody in the business "equals" Olympic!



**OLYMPIC**

Olympic Stain. A division of COMERCO, INC.  
1148 N.W. Leary Way, Seattle, WA 98107 (206) 789-1000

## There is no equal.



For more data, circle 33 on inquiry card

## Haws makes it an

# EASY REACH!



This electric water cooler ably serves individuals in wheelchairs as well as the general public, and it meets requirements of Public Law 90-480. Haws Model HWCD-8 has dual, self-closing lever valves, offering greatest user convenience. All-stainless steel exterior eases maintenance, assures permanent sparkle. If your upcoming building project involves federal funding, you'll

want full facts on this wheelchair model. Contact us. HAWS D FAUCET CO., 1441 Fourth S Berkeley, CA 94710.

**Haws**  
WATER COOLERS

For more data, circle 34 on inquiry card



# Save up to 70% in space!

## Joy axial fans offer you this big design advantage over conventional centrifugals of equal performance.

Joy believes air moving systems should be built in, not built around. And the Joy Axivane® fan makes a "built in" system possible. Constructed around the motor, the Axivane fan features in-duct mounting to eliminate duct turns, offsets and plenum boxes.

Result: Smaller equipment rooms. More usable space!

In addition to saving up to 70% in space, the Axivane fan offers these additional benefits:

**UP TO 50% LESS WEIGHT**  
permits reduced structural requirements.

**LOWER INSTALLATION COSTS**  
thanks to a pre-adjusted, self-contained package delivered in one piece for easy, fast installation.

**QUIET OPERATION**  
sound attenuation is much simpler with the higher frequencies of the Axivane fan.

**LOWER OPERATING COSTS**  
due to greater operating efficiencies.

**ADJUSTABLE BLADES**  
provide a wide operating range.

**CONTROLLABLE PITCH IN VAV SYSTEMS**  
for maximum energy savings automatically thru blade pitch control at partial loads.

Yes, you'll have room to spare when you specify Joy Axivane fans. For additional information, contact Joy Manufacturing Company, Air Moving Products, New Philadelphia, Ohio 44663. In Canada: Joy Manufacturing Company Ltd., Alpha Fan Division, Winnipeg, Manitoba.



# Save up to 70% in space!



Offices and plants throughout the world

**NEW  
PHILADELPHIA  
DIVISION**





303 SIDING 24 oc

19/32 THICKNESS  
GROUP 1  
EXTERIOR  
PS 1-74 000



2-4-1

GROUP 1  
INTERIOR  
PS 1-74 000



UNDERLAYMENT

GROUP 3  
INTERIOR  
PS 1-74 000  
EXTERIOR GLUE



M.D. OVERLAP

GROUP 1  
EXTERIOR  
PS 1-74 000



C-D

48/24  
INTERIOR  
PS 1-74 000



B-C

GROUP 2  
EXTERIOR  
PS 1-74 000



303 SIDING 16 oc  
T-1-11

GROUP 4  
EXTERIOR  
PS 1-74 000



C-C

24/0  
EXTERIOR  
PS 1-74 000



B-B PLYFORM®

CLASS 1  
EXTERIOR  
PS 1-74 000



UNDERLAYMENT

GROUP 1  
INTERIOR  
PS 1-74 000  
EXTERIOR GLUE



A-C

GROUP 1  
EXTERIOR  
PS 1-74 000



STRUCTURAL  
C-D PLUGGED

INTERIOR  
PS 1-74 000  
EXTERIOR GLUE



303 SIDING 16 oc  
T-1-11

GROUP 1  
EXTERIOR  
PS 1-74 000



C-D

32/16  
INTERIOR  
PS 1-74 000  
EXTERIOR GLUE



STRUCTURAL I  
C-D

24/0  
INTERIOR  
PS 1-74 000  
EXTERIOR GLUE



C-D PLUGGED

GROUP 3  
INTERIOR  
PS 1-74 000



STRUCTURAL I

A-C  
EXTERIOR  
PS 1-74 000



C-C PLUGGED

TOUCH SAND  
GROUP 3  
EXTERIOR  
PS 1-74 000



A-D

GROUP 2  
INTERIOR  
PS 1-74 000



CALL FOR ENTRIES

PLYWOOD  
DESIGN  
AWARDS  
1977 000



Announcing the Plywood Design Awards for 1977. Four categories: residential/single family, residential multi-family, vacation homes, commercial/institutional. \$1,000 Award and Citations of Merit in each category. Judges: William Baird, FAIA; John D. Bloodgood, AIA; Paul Rudolph, FAIA. Sponsored by the American Plywood Association and Professional Builder and Architectural Record magazines. For entry forms, write American Plywood Association, Department AR-096, 1119 A Street, Tacoma, WA 98401.

For more data, circle 36 on inquiry card



# Your long life needs are answered!



Stanley's LifeSpan™ hinges are the slimmest, longest life, concealed bearing hinges on the market. Concerned with life cycle costs? They're guaranteed for the life of the building!

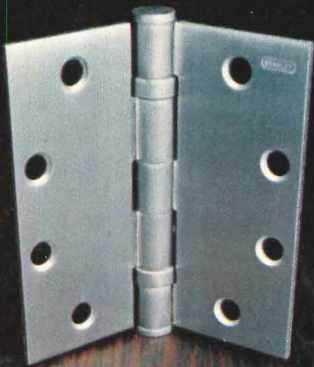

Stanley's FBB179 line of five knuckle hinges is the standard of the industry. Substantial and time proven!

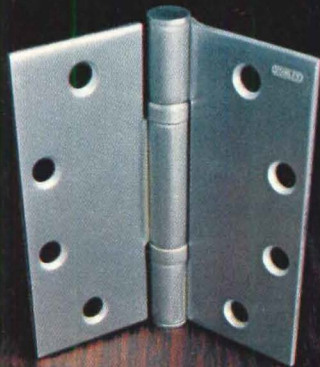

Stanley's BB600 was the first three-knuckle ball bearing hinge line ever made. Still a favorite for beautiful buildings meant to last.

Stop worrying about long life performance. With Stanley you get the quality you respect, the beauty you hoped for, and the service that makes your job easier. Stanley Hardware, Division of The Stanley Works, New Britain, Conn. 06050. In Canada: The Stanley Works of Canada, Ltd.

See our catalog in Sweet's Architectural File.

**STANLEY**  
helps you  
do things right

For more data, circle 37 on inquiry card



# WHEN PANKOW NEEDED TO SAVE MONTHS, VULCRAFT SAVED THE DAY.

In June 1974, Pankow Construction Company needed to begin erection of the structural steel framing for the Penn-Can Shopping Mall in Cicero, New York.

The plans called for both steel joists and wide flange beams.

Pankow had no problem getting the joists. But then they got some bad news about the beams. Steel mills were back ordered, and could not supply them before the first quarter of 1975.

A costly delay stared Pankow right in the face.

So Pankow and the design team including McLean Steel of Hayward, California, redesigned the structural framing to use Vulcraft open web joist girders, for both floor and roof, to replace wide flange beams.

Vulcraft joist girders were chosen for a number of reasons.

They could be quickly and easily designed to take the place of beams.

Vulcraft could deliver them fast.

And Vulcraft joist girders were competitively priced.

The change to Vulcraft joist girders enabled Pankow to finish the structural framing right on schedule.

Vulcraft joists and joist girders had saved the day.

And they can do the same for you.

For more information, just contact your local Vulcraft representative. Or write Vulcraft, P.O. Box 17656, Charlotte, North Carolina 28211 for your Joist & Joist Girder Guide. (See Sweets 5.2/Vu.) Or call (704) 366-7000.

It could make your day.





*Use of 100' long span joists and 30' joist girders created a large clear span area in the center section of this enclosed shopping mall.*



*Wide spacing of deep steel joists (8" in floors and 7'6" in roofs) resulted in stiffer floor system and saving in the cost of joists.*



*Vulcraft steel joists and joist girders allowed for simple and fast column connections.*



*Joist girder design flexibility provided for a wide range of load support, from normal roof loads to heavy mechanical equipment loads.*

# VULCRAFT

A Division of Nucor Corporation





**Weathered brick without the weather. Or the brick  
That's the beauty of Mason**







You're looking for the warmth of weathered brick, look at Masonite's new Brick Design hardboard paneling. You won't need a bricklayer or a big budget. It comes in tan, red and white, and you

won't find a more realistic brick panel on the market.

Discover Masonite's many inviting styles and finishes. They help you make the most of any room.

*Man-made finish on real Masonite brand hardboard.*



*For more data, circle 39 on inquiry card*



**Specifying a building  
has suddenly become  
simpler, faster and more efficient.**





Things have just gotten easier for you. Thanks to better building systems from Johns-Manville. Simpler because you can specify a whole built-up roof or a wall, for example, with all components supplied by J-M. Faster because the time and effort you spend specifying is cut drastically.

More efficient because one very complicated specification will give you an entire wall or roof system.

And J-M building systems offer savings to contractors, builders and owners as well. Because all J-M building components are made to fit and work together. Because one source supply can mean better delivery schedules, quicker erection, reduced handling and labor costs.

Some of the better building systems that can save you time and effort include:

**J-M Built-Up Roofing Systems**, complete, from-the-deck-up capability using J-M components, including vapor barrier systems, insulation boards, inorganic base and finishing felts, expansion joint covers, roof drainage and flashing systems, adhesives and special products.

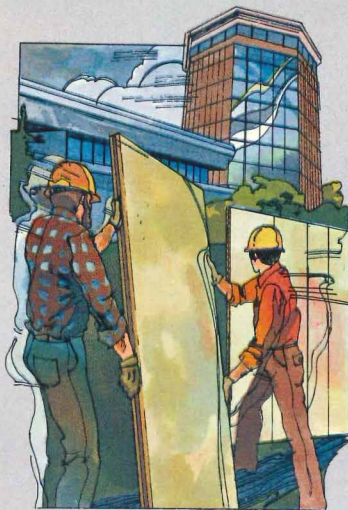
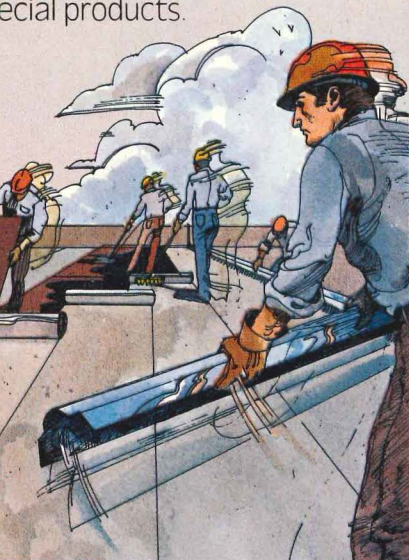

**J-M Wall Systems** that give the look of masonry without the massive weight, plus economy, fast enclosure and long life.

Corspan® extruded masonry panel system, in a selected range of colors. Spans floor-to-floor without intermediate girts. Used as a complete wall for an entire structure of any size or type.

Struct-O-Wall™ thru-wall system combining J-M masonry architectural panels with lightweight structural steel studs, insulation and interior finish.

Plus a wide selection of Architectural Panels, lightweight masonry accent or feature panels providing freedom of design for both spandrel and fascia applications.



**J-M Pre-Engineered Building Systems** including an insulation/ceiling package providing an effective thermal barrier and an

attractive finished ceiling; combination insulation/facing materials; plus lighting components, architectural panels, acoustical ceiling panels and tiles and air-handling components.

The new Johns-Manville Building Systems Division is staffed and structured to help put these systems to work for you. By providing technical specialists who can help you and your team with your project. By supplying complete application literature.

Find out how better building systems from Johns-Manville can make things easier for you.

For detailed information refer to Sweet's Catalog File under "Architectural," "Industrial Construction," and "Plant Engineering and Engineering." Or phone Johns-Manville at 303/770-1000 and ask for any of the following: Built-Up Roofing Systems-Dick Ducey; Insulation-Pete McCracken; Roof Accessories-Don Korte; Wall Systems-Dave Lucy; Pre-Engineered Building Systems-Roger Bengtson.

And for general information, call the J-M Product Information Center, Ext. 2745.

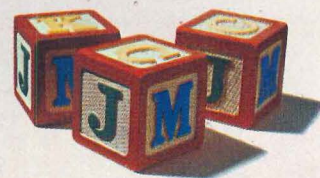

**We've got better building systems.**



**Johns-Manville**

For more data, circle 40 on inquiry card





# A KOHLER TOUR of AMERICA'S BATHS

**The Kohler Collection**—Kohler helps you to sell more by offering faucets and fittings for every building or remodeling plan.

Like 24-carat gold electroplate or chromium faucets, with polished or brushed finish, acrylic handles in four colors and six complete lines to choose from.

Alterna (upper left)...versatility plus a choice of accent inserts in teak, walnut, ebony or white.

Flair (upper right)...gracious quality in white, amber, charcoal or clear handles.

Centura One-Controllable (middle) with no drip,

no-leak dependability. Push-pull or single lever. "Antique" (lower left) brings luxury to any decor. Featuring the "Antique" Rite-Temp pressure compensating shower control in 4 decorator dial plates: Espresso, Parchment, Black Black and White.

Triton II (middle right) offers attractive styling, reliable performance.

And Trend (lower right)...economy in a choice of acrylic or chrome handles.

For more information, write to Box EB, KOHLER CO., KOHLER, WI. 53044. Kohler products are available in Canada.

**THE  
BOLD LOOK  
of KOHLER**

For more data, circle 41 on inquiry card





HOME FEDERAL SAVINGS & LOAN ASSOCIATION BUILDING  
Johnson City, Tennessee

## Conserve energy. Go thermal.

Now your building can provide spring-like weather all year round and still conserve energy thanks to Amarlite's PBS-383 Curtainwall System.

PBS-383, provides a highly efficient thermal barrier, preventing weather transfer from exterior to interior of your building, helping you to conserve air conditioning and heating costs.

Installing the curtainwall system in your building does a lot more than just save you money, it also turns your building into an attractive, modern structure. PBS-383 will accommodate one inch glazing through the use of standard sections and has a two and one-half inch mullion width for monumental appearance. Not only does this system provide the architect with complete design freedom, but it is also easy to install.

Designed specifically for high-rise applications, PBS-383 uses snap-on glazing beads at the interior

horizontals to provide a system that may be either interior or exterior glazed, depending on building design and job conditions.

Attractive, both money and energy saving, easy to install, and above all — an efficient thermal weather barrier, Amarlite's PBS-383 can put the "spring" back into the life of your building.

For further details about our full line of energy conserving products contact AMARLITE/ANACONDA, P.O. Box 1719, Atlanta, Georgia 30301.

**AMARLITE**<sup>®</sup>  
ANACONDA  Aluminum  
Division



**don't overlook  
the versatility of  
INRYCO/MILCOR®  
steel framing**

**It may be the best way to achieve the effect you want within your budget.**

Because of its versatility, light gage steel framing offers worthwhile opportunities for savings in buildings of all shapes and sizes...without restricting your design.

Its uses range over a wide spectrum, including: floor, ceiling and roof conditions; interior load bearing walls and non-bearing partitions; and a great variety of exterior wall conditions. It can provide the complete structural framework for buildings up to four stories high.

Just about any surfacing material may be used with it. Interiors may be drywall, plaster over metal lath or gypsum lath, wood paneling, etc. Exteriors may have cementitious membranes—textured stucco, exposed aggregate, etc.

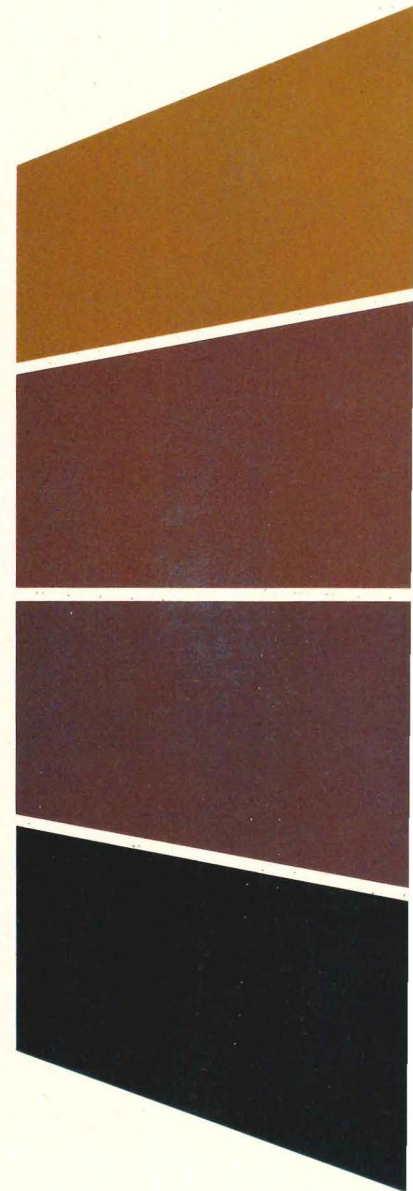
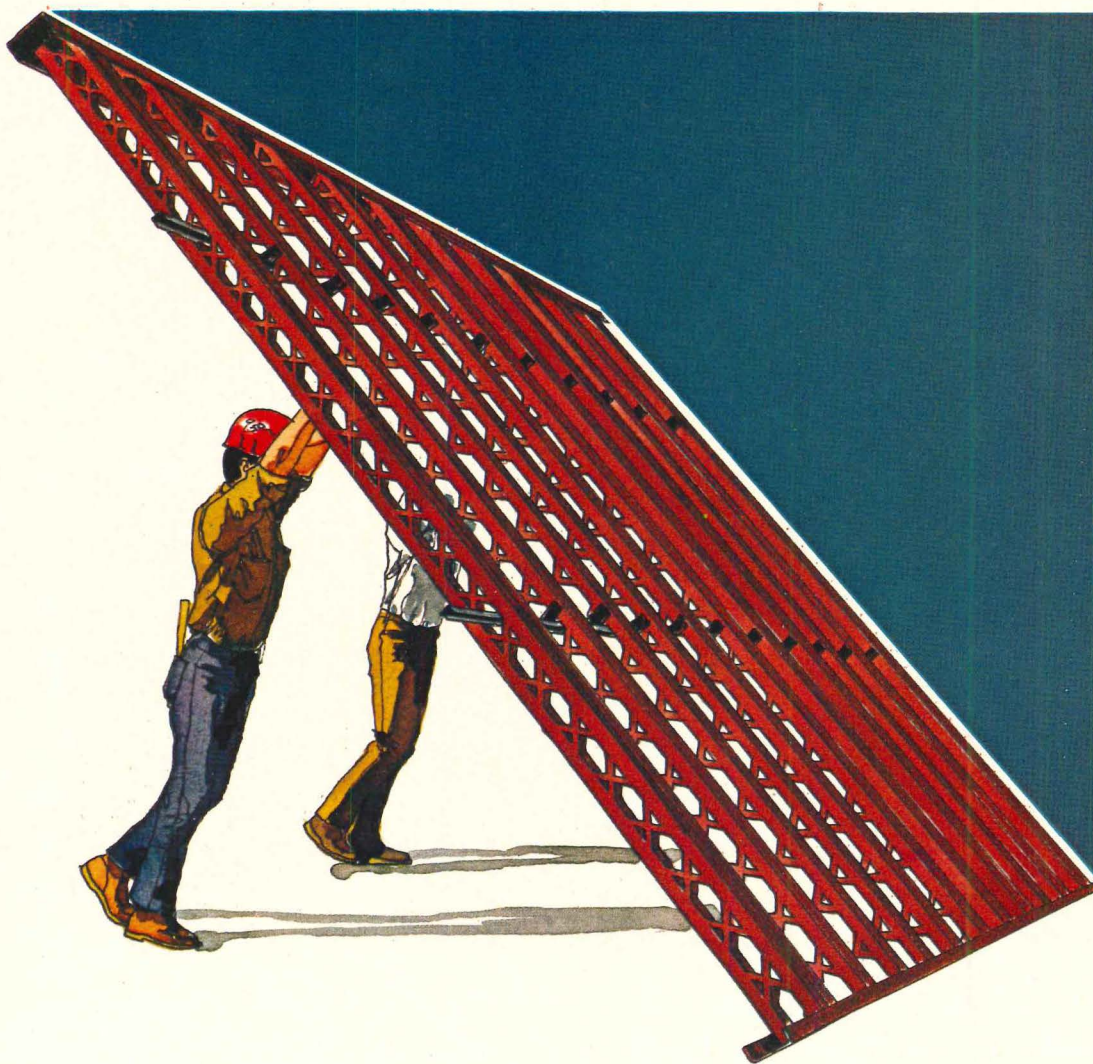



regate, simulated brick or stone—or may be brick  
eer, metal panels, textured plywood or any other  
et material.

e savings it offers may be the result of any one or a  
mbination of factors: easier execution of intricate  
signs; lower in-place cost; faster erection; reduced  
ndation and footings requirements because of  
t weight; insurance savings through incombustible  
ngs. Some or all of these led to its selection for use  
ne varied buildings shown in the accompanying  
otos—a small representative selection of recent  
yco/Milcor projects.

erever your design emphasis is concentrated—  
h rise or low rise; commercial, institutional or  
idential—Inryco/Milcor Light Gage Steel Framing  
ystems might well provide the perfect solution to a

budget problem. See our catalog in Sweet's, section  
5.3/1n. Or, if you'd like our representative to call and  
discuss how the advantages of these systems may  
apply to a project you are planning, please contact:  
Milcor Division; INRYCO, Inc.; Dept. J, 4033 West  
Burnham St.; P.O. Box 393; Milwaukee, WI 53201.

*For more data, circle 43 on inquiry card*



**Inryco**  
an Inland Steel company

General Offices: Melrose Park, Illinois  
Formerly INLAND-RYERSON CONSTRUCTION PRODUCTS CO.









# Range Finder

**You'll discover a vast panorama of textures, styles and lusters in contract carpets made of our yarns.**

That's because our specially engineered acrylics, nylons and blends offer mills a rich variety of carpet styling opportunities for specific end-uses.

Your choice of textures, for instance, includes level loops, cut and loops, high/low ribbed loops, cut piles and tip shears in woven, tufted, or fusion bonded carpets. You'll find a vast range of lusters, too, as well as over 22,000,000 possible colorations.

No matter what style, texture, color and carpet brand you specify, you can be sure the carpet will perform for years if it carries our Dow Badische Performance Certification label on it. That means the carpet has passed many tough lab tests to meet our exacting market standards.

Variety adds spice to specifying carpets featuring our yarns. Our label adds assurance. Always look for it. For further specifying help, contact our Contract Carpet Consultants Service and ask for our Contract Carpet Selection and Specifications Guide.



**Dow Badische Company, Create Center  
Williamsburg, Virginia 23185  
(804) 887-6573**

**PERFORMANCE  
CERTIFICATION**

**DOW  
BADISCHE**

**Dow Badische produces acrylic and nylon fibers and yarns especially engineered for carpets of beauty and performance.**

*For more data, circle 44 on inquiry card*





# Certain things you can depend on.

Mom and Rover are pretty reliable. So is the inevitability of taxes. You can also put your faith in a few, very select mechanical devices.

One of them, that a lot of architects have depended on for years, is a Halsey Taylor water cooler.

### Exclusive design features

It's no accident that our coolers deliver years of reliable service with very little maintenance. We've designed a lot of extras into them. Such as our exclusive automatic regulating valve that maintains a constant stream height regardless

of varying line pressures; heavy-duty start capacitors that assure compressor start-up, everytime; and our efficient pre-cooler that boosts cooling capacity by 60 percent.

We balance the complete cooling system for longer service and lower life cycle cost. And happier customers.

### Color and textural harmony

Each of our welded unitized cabinets is topped by a buffed stainless steel receptor and Halsey Taylor's

unique anti-squirt twin-stream bubbler. To harmonize with virtually any interior, we offer cabinets in satin finish stainless steel, PATINA bronze tone stainless, eight different Polychrome colors and a choice of vinyl clad steels. We also offer the widest selection of water coolers in the industry.

Halsey Taylor water coolers. Not a big item in your specs but something you can honestly depend on. We'd like you to have our new catalog. Write to Halsey Taylor Division, Route 75, Freeport, Illinois 61032.

**Halsey Taylor**  
KING-SEELEY  THERMOS CO.

For more data, circle 45 on inquiry card



## "How-to" books that belong in the A/E's management library

by Bradford Perkins, Llewelyn-Davies Associates

**CURRENT TECHNIQUES IN ARCHITECTURAL PRACTICE**, Robert Allan Class, AIA and Robert E. Mehler, Hon. AIA, editors; *The American Institute of Architects and Architectural Record*, New York, 1976, 275 pages, illustrations, \$25.00.

**HOW TO PREPARE PROFESSIONAL DESIGN BROCHURES**, by Gerre Jones, McGraw-Hill Book Company, New York, 1976, 277 pages, illustrations, \$6.50.

Two important books have recently been added to the rapidly growing library of management literature for design professionals. Each attempts to fill a real gap in the current literature, and each partially succeeds.

My initial review of *Current Techniques in Architectural Practice* was made as one of the instructors responsible for the management course at City College of New York's College of Architecture. No satisfactory general text exists, and my colleagues and I all wondered this book would meet our needs. Our view was a qualified "yes."

The book has chapters on 20 topics divided into four categories with rather general titles: Organization and Delivery, Business Management, Project Management, and Management and Production Tools. Within these categories there are chapters—each by a different author—on such topics as: "The Professional Organization," "The Client," "Financial Management," "Construction Cost Control," "Office Machines," "Drawings," "Specifications," and "Trends in Architectural Practice." Individual authors are: David R. Gibner, Philip J. Meathe, Harold L. Adams, MacDonald Becket, Peter Piven, David M. Bowen, Bernard B. Rothschild, Richard G. Jacques, Charles R. Sikes Jr., Herbert McLaughlin, James Y. Robinson Jr., Peyton E. Kirven, Harold J. Rosen, Robert F. Mattox, Jack D. Rain, James J. O'Brien, Ned H. Abrams, and Paul Heineman.

Because it is a loosely edited anthology of 20 authors' views on 20 related topics, the book suffers from the common problems of such books: inconsistent writing styles, skills, viewpoints and levels of detail; redundancy; and occasional detours from the central theme. These problems are mitigated somewhat because most of the authors are well-qualified to write on their assigned topics. But because it is a compendium it is necessary to review the characteristics of the parts as well as the whole:

1. It has a number of excellent chapters,

which are major contributions to the available literature, such as Bernard Rothschild's chapter on "Insurance Management" and David Bowen's on "Personnel Management." Unfortunately many others, including the ones on the client and computing, are disappointing given the authors' recognized knowledge.

2. There is a great disparity in viewpoints and level of detail. Some chapters such as the ones on personnel insurance and financial matters would be of interest to the practicing professional while others such as the ones on codes, project delivery, and project management seemed to be written for laymen.

3. The traditional complaint about most management literature that it is big-firm oriented can probably be applied to this book as well. Parts of the book are relevant to any design professional, but many of the specific techniques are not. No real effort is made to deal with the specific issues facing the average-size (10 people) architectural firms.

4. The book also tends to proselytize for the AIA in a few areas. The chapter on construction cost control references the AIA's theories on cost information, and several other chapters refer to the AIA financial management system. The AIA has made some contribution in both areas, but far better references exist.

5. The book is missing some important material. As a whole, it barely deals with such topics as legal methods of compensation, managing consultants, managing growth and change, and starting a new office.

In spite of these flaws, however, this is a good book. It certainly does not justify the flyleaf's accolade that "This book will doubtless emerge as *the* critical tool for managing an architectural practice in the '70s." It is, however, a useful addition to the literature relevant to both students and the practicing professional.

### And about those brochures

McGraw-Hill has recently published the second in Gerre Jones' series of marketing texts. As with his book *How to Market Professional Design Services*, *How to Prepare Professional Design Brochures* is clearly the effort of a person who knows his subject, has a point to make, and writes well. But, as was also the case with his first book, this book is not the final word on the subject.

Before noting some of the flaws, I should state three basic facts concerning this book:

1. The subject is important to any firm's

marketing effort. The book includes the results of a survey that a large number of project interview lists are made up from brochures, and a good brochure will have an influence on whether one makes the list.

2. Most firms prepare mediocre brochures. In spite of the fact that most recipients look upon brochures as representative of a firm's best effort, according to the author, most brochures are badly done. A client survey gave the architect/engineer brochures reviewed an average score of 4.2 on a scale of 10.

3. This book is well worth buying and reading. Not only is it a small investment to make to help improve the result and reduce the effort to achieve better results, but it is also the only text on this subject directly relevant to the design professions.

The book deals in exhaustive detail with the mechanics of brochure preparation. What is curious, however, is that the depth in the discussion of mechanics is not matched with a similar depth in what makes a good or a bad brochure. For example, there is a whole chapter on writing styles, but the examples used are almost entirely drawn from entertaining but irrelevant publications. Throughout the book the actual subject—the design professional's brochure—is only infrequently used as the source of illustrations. Because of the shortage of brochure examples and discussion of specific design firms' brochure experience, I found less than I had hoped in the topics that mattered the most to me, such as:

1. "What can we do for \$2000, for \$3000, for \$10,000?"

2. "How do I present my experience in such a way that it is relevant to the maximum number of clients?"

3. "How do I relate my brochure to my over-all marketing effort?"

Nevertheless, this book does give solid answers to such questions as:

1. "What are the tasks that must be accomplished in producing a brochure?"

2. "What major decisions must be made during each step?"

3. "What technical aids are available in achieving the desired result?"

These and many more questions are well handled. Hopefully, though, enough people will buy this book to permit Mr. Jones to expand it in future editions so that it reflects more of his extensive personal and consulting experience with the specifics of design professionals' brochures.





## Construction costs. The Battle of the Bulge.

Time. Labor. Materials. The high cost diet that'll bulge a construction budget. Trimming that costly bulge in washroom construction is the beginning of Bradley Washfountain savings.

Bradley Washfountains save time with rapid delivery for remodeling and fast track schedules. Only 3 plumbing connections to provide washing capacity for 2 to 8 people. Uncomplicated, fast installation that cuts the high cost of labor. And a Bradley equipped washroom has lower component and material costs than a lav-equipped washroom with the same capacity. It all adds up to a total savings of 46% to 73% on construction costs. Plus reducing the amount of space needed for washing facilities by an average of 25%.

Increasing washroom efficiency and decreasing washroom construction costs. That's a Bradley Washfountain. And that's how you can trim your construction costs. By contacting your local Bradley representative. Or write for more information on the complete Bradley line. Bradley Corporation, 9107 Fountain Blvd., Menomonee Falls, Wisconsin 53051.



**Bradley**  **Cuts down on costs.**

*For more data, circle 13 on inquiry card*



## Some pertinent reminders on contracts

Charles D. Maurer, Jr.

Common pitfall of design professionals is failure to reduce to writing the agreements they have reached with their clients, even on those smaller construction jobs (under \$10,000).

Of course, a well-written contract provides a clear definition of the responsibilities and relationships of the parties. For instance, unless unequivocally defined in writing, the design professional and the client may have completely different opinions concerning whether the design professional is a guarantor of his work. Clearly, the design professional insists on no such guarantee, as he recognizes the limits of his ability and the state of his art. Nevertheless, the client may assume such a guarantee, even to the extent of seeking to establish in a court of law that such a guarantee exists.

Naturally, allocating responsibilities of the parties is also more clearly accomplished in a written contract than in an oral one. The parties can expressly delineate who will bear the responsibility for loss or destruction of material during construction; who will be responsible for job site safety and supervision. In the absence of a written contract, the law may allocate these responsibilities in a variety of ways, any of which could be detrimental to the design professional.

### The law requires written contracts

Certain types of contracts are required to be in writing by state law. The law imposing this requirement, like that of its English counterpart, called a Statute of Frauds because its purpose is, obviously, to prevent fraud. The Statute of Frauds varies among states, however, certain contracts required to be in writing by the Statute in virtually all states are: 1) contracts which cannot be performed in one year, 2) contracts for the sale of land, and 3) contracts for the sale of goods in excess of \$500. Although the design professional does not generally contract for the sale of land or goods, his services might well be incapable of completion within one year, thereby necessitating a written contract. Reference should be made to applicable state law to determine which contracts are required to be in writing. Contracts which do not comply with the Statute of Frauds are void or unenforceable, and a void or unenforceable contract may leave the design professional without a remedy for collecting his fee.

### Obtaining payment from an estate

A second type of statute which may prevent a design professional from collecting his fee, is called a Dead Man's Statute. This type of statute prevents parties in an action against a decedent's estate from testifying concerning transactions with the deceased person. Simply stated, the death of a client can prevent proof of the oral agreement with him, and thereby deny the design professional compensation for his services from the decedent's estate. A written contract will help eliminate this risk.

Another general rule of law pertinent to written contracts is the Parole Evidence Rule. The purpose of this law is to lend stability and finality to a written contract, which the parties intend to be the final, complete, integration of all their negotiations. Once a court is satisfied the parties had such a final, complete, written contract, it will not consider any other evidence of prior or contemporaneous agreements or negotiations, which would alter or vary the terms of the written contract.

This rule alone should compel the design professional to seek a comprehensive written contract. It is important to recognize, however, that many jurisdictions will allow extrinsic evidence to prove a contract was not intended to be a complete integration of the parties' agreement. To protect against this circumvention of the Parole Evidence Rule, the parties should include a clause stating the written contract is the complete expression of the agreement.

### Know who may legally sign

Since the legal status of a contracting party is important to the validity and enforceability of the contract, a written agreement is preferred to an oral agreement. Whether a contracting party is an individual, minor, corporation, public agency or married person affects the entire complexion of the contract, including its validity and enforceability.

Public agencies and corporations are limited by legislation and articles of incorporation to contract for certain purposes. Contracts beyond those purposes may be unenforceable. Additionally, the persons signing the contract on behalf of the agency or corporation must have the power to bind that entity if the contract is to be enforceable.

For instance, if a contract names Ajax Investors as owner and John Doe signs as owner, the design professional should ascertain the

legal status of both before signing himself. Here, it is unclear whether Ajax is a sole proprietorship, partnership or corporation. It is also not clear if Ajax has the power (if Ajax is a corporation) to enter into the contract. Lastly, it is not clear if John Doe has the authority and power to bind Ajax. An express provision in a written contract stating the legal status and authority of the parties to enter into the contract reduces the likelihood of a successful attack upon the enforceability of the contract.

A court faced with enforcement of a contract has much less difficulty interpreting a written, as opposed to an oral, contract because its terms are physically before the court, rather than lodged in testimony and bits of evidence through which the court will have to search for the elements of the agreement. Standard form contracts (e.g. AIA, NSPE, ACEC) increase the ease with which a written contract can be enforced because the language of such contracts has acquired special definition within the profession through widespread use. This aspect of standard form contracts is especially helpful in the event contract rights are assigned or duties delegated.

### Written contracts reduce financial risk

One of the most often overlooked advantages of reducing a contract to writing is the opportunity afforded the design professional to advance his own interests by incorporating specific safeguards against his own financial exposure. Such safeguards might include liquidated damages provisions, provisions holding the design professional harmless from liability (e.g. provisions holding one design professional harmless from liability arising out of the professional acts, errors or omissions of a joint venturer) and provisions limiting the design professional's liability. Although such provisions may be subject to attack as offending public policy, their value does not depend solely on their enforceability. More importantly, the negotiations attendant to the inclusion of such provisions provide a clear understanding of the design professional's capabilities and erase unreasonable expectations which might otherwise have been the basis of a lawsuit.

Mr. Maurer is an attorney admitted to the practice in California, Washington and Arizona. He is associated with Risk Analysis & Research Corporation in San Francisco, which counsels architects and engineers on professional liability.



Scaled to today's emerging office environment, the new 500 Series from All-Steel offers uncompromising comfort...unsurpassed All-Steel quality. 28 models; a full selection of fabrics, vinyls, shell colors and base options. Write for information. All-Steel Inc. Aurora, Ill. 60507.



All-Steel Showrooms in New York, Los Angeles, Chicago, Aurora. In Canada, All-Steel Canada, Ltd. One of the **CFI** Companies.

*For more data, circle 48 on inquiry card*



## Building type: fire stations

	Average		High average	
	\$/SF	%TOT	\$/SF	%TOT
Foundations	\$ 1.78	4.7	\$ 1.88	4.5
Structure	1.03	2.7	1.09	2.6
Roof structure	5.07	13.4	5.36	12.7
Door closure	7.88	20.9	9.08	21.6
Lighting	0.85	2.3	0.89	2.1
Fixtures	2.24	5.9	2.68	6.4
Finishes	1.29	3.4	1.56	3.7
Painting finishes	1.22	3.2	1.46	3.5
Plumbing finishes	1.03	2.7	1.24	2.9
Utilities	1.65	4.4	1.74	4.1
Heating systems	0.23	0.6	0.24	0.6
Cooling	1.51	4.0	1.68	4.0
Protection	0.19	0.5	0.21	0.5
Electrical	4.16	11.0	4.62	11.0
Mechanical	4.66	12.3	5.18	12.3
Special conditions	2.19	5.8	2.31	5.5
Building cost	36.98	97.9	41.22	97.9
Per sq ft	0.79	2.1	0.87	2.1
Total building cost	37.77	100%	42.09	100%
Per sq ft	2.21	5.9	2.44	5.8
Construction cost	\$39.98		\$44.53	

## Building type: court houses

	Average		High average	
	\$/SF	%TOT	\$/SF	%TOT
Foundations	\$ 3.28	5.8	\$ 3.47	5.5
Structure	0.73	1.3	0.77	1.2
Roof structure	4.32	7.7	4.56	7.2
Door closure	13.11	23.4	15.18	24.0
Lighting	1.14	2.0	1.20	1.9
Fixtures	3.83	6.8	4.57	7.2
Finishes	6.10	10.9	7.19	11.4
Painting finishes	2.85	5.1	3.42	5.4
Plumbing finishes	1.34	2.4	1.61	2.5
Utilities	0.27	0.5	0.29	0.5
Heating systems	2.03	3.6	2.14	3.4
Cooling	1.26	2.2	1.40	2.2
Protection	0.09	0.2	0.10	0.2
Electrical	4.28	7.6	4.72	7.5
Mechanical	3.30	5.9	3.66	5.8
Special conditions	3.00	5.3	3.17	5.0
Building cost	50.93	90.8	57.45	90.9

## INDEXES: September 1976

1941=100.00 (except as noted)

Metropolitan area	Cost differential	Current Indexes				% change last 12 months
		non-res.	residential	masonry	steel	
U.S. Average	8.5	540.1	507.4	533.6	519.9	+ 9.1
Atlanta	7.5	612.9	578.0	605.8	594.2	+ 3.2
Baltimore	8.5	623.2	586.0	611.5	597.2	+13.1
Birmingham	7.3	477.1	443.8	464.4	457.9	+ 6.7
Boston	9.0	545.7	515.7	552.7	531.3	+10.6
Buffalo	9.1	579.6	543.4	570.6	553.8	+ 6.5
Chicago	8.3	571.2	543.2	552.9	545.0	+ 3.9
Cincinnati	8.8	613.8	577.7	603.5	588.2	+16.3
Cleveland	9.0	589.9	555.1	580.1	563.2	+12.0
Columbus, Ohio	8.2	525.9	494.0	522.4	506.4	+ 3.2
Dallas	7.9	513.7	501.5	507.1	495.9	+ 3.6
Denver	8.4	589.8	554.9	585.0	572.0	+ 9.4
Detroit	9.8	625.0	596.0	634.4	610.1	+10.9
Houston	7.4	508.2	477.3	497.1	488.3	+11.6
Indianapolis	7.8	482.7	454.4	475.2	464.8	+ 8.2
Kansas City	8.7	533.6	504.3	525.5	511.3	+ 8.8
Los Angeles	8.5	615.4	562.7	599.7	585.9	+ 9.5
Louisville	7.6	514.7	483.4	502.7	492.9	+ 6.9
Memphis	8.4	547.9	514.5	529.6	518.4	+ 7.5
Miami	7.9	598.2	570.0	596.2	587.4	+17.6
Milwaukee	8.7	619.6	581.9	615.1	594.4	+ 9.5
Minneapolis	8.9	557.4	524.5	550.5	537.7	+ 6.7
Newark	9.0	501.7	471.2	498.6	485.5	+ 2.5
New Orleans	7.5	532.6	502.8	524.4	512.6	+12.7
New York	10.0	554.8	516.0	545.1	533.6	+ 2.9
Philadelphia	9.1	591.3	563.4	592.6	573.9	+ 9.4
Phoenix (1947 = 100)	8.2	318.0	298.7	314.1	305.9	+ 8.6
Pittsburgh	8.9	517.1	486.6	516.9	499.7	+ 7.0
St. Louis	8.7	552.8	521.9	547.8	535.4	+ 9.0
San Antonio (1960 = 100)	7.6	216.7	204.3	212.9	207.5	+14.3
San Diego (1960 = 100)	8.7	252.5	237.2	250.1	248.5	+19.8
San Francisco	9.6	810.8	741.2	804.2	777.8	+10.3
Seattle	8.6	542.6	485.8	533.0	515.0	+11.2
Washington, D.C.	8.4	526.9	494.8	519.3	504.4	+ 7.3

Cost differentials compare current local costs, not indexes, on a scale of 10 based on New York

Tables compiled by Dodge Building Cost Services, McGraw-Hill Information Systems Company

## HISTORICAL BUILDING COST INDEXES—AVERAGE OF ALL NON-RESIDENTIAL BUILDING TYPES, 21 CITIES

1941 average for each city = 100.00

Metropolitan area	1966	1967	1968	1969	1970	1971	1972	1973	1974	1975 (Quarterly)				1976 (Quarterly)			
										1st	2nd	3rd	4th	1st	2nd	3rd	4th
Atlanta	329.8	335.7	353.1	384.0	422.4	459.2	497.7	544.8	575.0	583.8	585.3	597.2	598.7	602.6	604.1		
Baltimore	280.9	295.8	308.7	322.8	348.8	381.7	420.4	475.5	534.3	538.7	540.2	579.6	581.1	609.7	611.2		
Birmingham	270.7	274.7	284.3	303.4	309.3	331.6	358.3	402.1	421.2	438.6	440.1	447.4	448.9	469.0	469.5		
Boston	262.0	265.7	277.1	295.0	328.6	362.0	394.4	437.8	462.5	484.1	485.6	511.7	513.2	535.7	537.2		
Chicago	320.4	328.4	339.5	356.1	386.1	418.8	444.3	508.6	529.6	539.2	540.7	558.6	560.1	560.3	561.8		
Cincinnati	278.3	288.2	302.6	325.8	348.5	386.1	410.7	462.4	500.1	518.0	519.5	549.1	550.6	602.9	604.4		
Cleveland	300.7	303.7	331.5	358.3	380.1	415.6	429.3	462.2	509.5	516.6	518.1	529.5	531.0	578.7	580.2		
Dallas	266.9	270.4	281.7	308.6	327.1	357.9	386.6	436.4	477.9	488.3	489.8	498.1	499.6	506.1	507.6		
Denver	297.5	305.1	312.5	339.0	368.1	392.9	415.4	461.0	510.0	530.4	531.9	552.1	553.6	580.3	581.8		
Detroit	296.9	301.2	316.4	352.9	377.4	409.7	433.1	501.0	538.7	554.4	555.9	596.0	597.5	615.1	616.6		
Kansas City	261.0	264.3	278.0	295.5	315.3	344.7	367.0	405.8	444.9	481.1	482.5	507.6	509.1	523.8	525.3		
Los Angeles	302.7	310.1	320.1	344.1	361.9	400.9	424.5	504.2	531.8	546.7	548.2	592.6	594.1	599.1	600.6		
Louisville	284.0	286.1	305.3	392.3	353.2	384.7	406.4	447.2	485.5	499.5	501.0	557.4	558.9	588.1	589.6		
Minneapolis	289.4	300.2	309.4	331.2	361.1	417.1	412.9	456.1	488.6	513.9	515.4	536.5	538.0	548.3	549.8		
New Orleans	259.8	267.6	274.2	297.5	318.9	341.8	369.7	420.5	442.1	463.5	465.0	493.2	494.7	522.8	524.3		
New York	304.0	313.6	321.4	344.5	366.0	395.6	423.1	485.3	515.3	524.1	525.5	532.0	533.5	539.4	540.9		
Philadelphia	286.6	293.7	301.7	321.0	346.5	374.9	419.5	485.1	518.5	531.5	533.0	566.0	567.5	581.8	583.3		
Pittsburgh	271.1	275.0	293.8	311.0	327.2	362.1	380.3	424.4	465.6	475.2	476.7	508.0	509.5	508.5	510.0		
St. Louis	288.3	293.2	304.4	324.7	344.4	375.5	402.5	444.2	476.7	497.5	499.0	527.4	528.9	542.7	544.2		
San Francisco	386.0	390.8	402.9	441.1	465.1	512.3	561.0	632.3	672.5	716.0	717.5	751.8	753.3	790.1	791.6		
Seattle	275.0	283.5	292.2	317.8	341.8	358.4	371.5	424.4	450.2	472.5	474.0	513.6	515.1	525.9	527.4		

Costs in a given city for a certain period may be compared with costs in another period by dividing one index into the other; if the index for a city for one period (200.0) divided by the index for a second period (150.0) equals 133%, the costs in the one period are 33% higher than the costs in the other. Also, second period costs are 75% of those in the first period (150.0 ÷ 200.0 = 75%) or they are 25% lower in the second period.



# Only galvanizing protects around corners

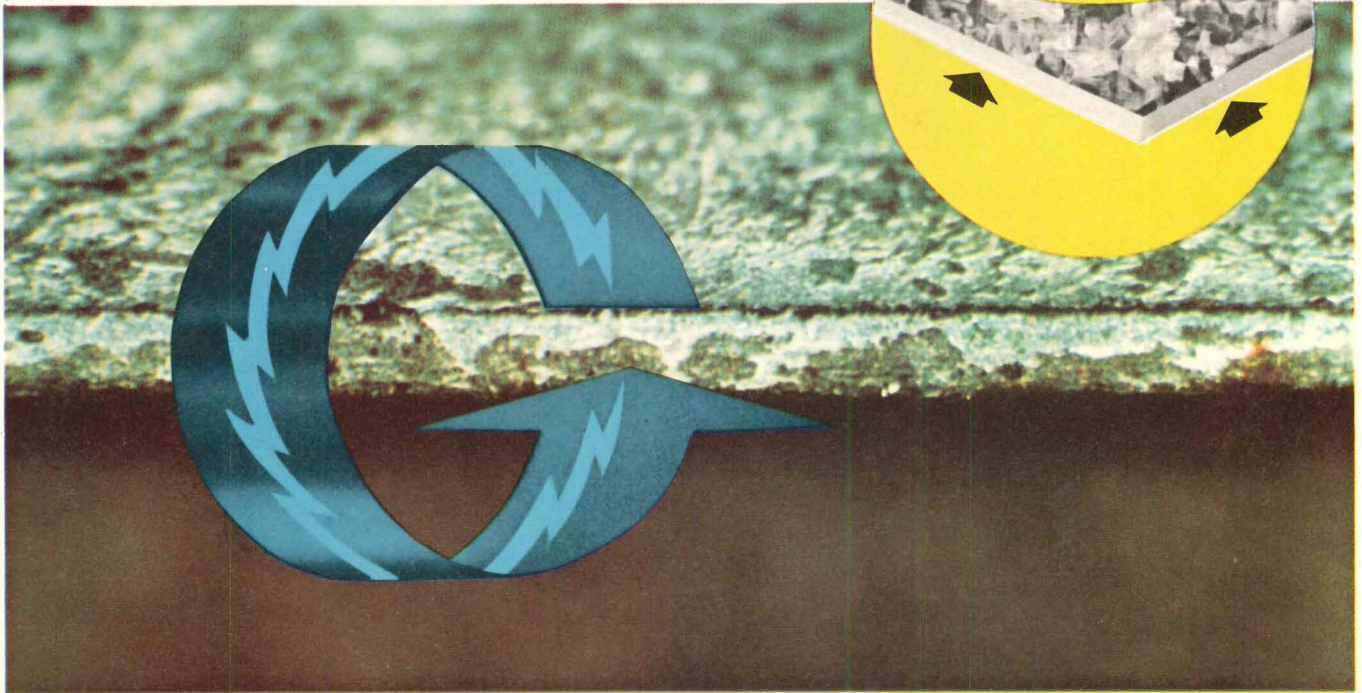

## to guard this cut edge against rust for over 4 years

Other coatings, such as paint or plastic, protect only the surface they cover—and only for as long as they cover it. When you cut, drill or scratch through the coating, you open the door to destructive corrosion which eats into the exposed surface and underneath the adjacent coated areas.

The magnified color photo above shows proof that the electro-chemical sacrificial action of the zinc coating can go around corners to protect cut and drilled edges. What you're looking at is the top surface and cut edge of a 22 gauge, regular G90 mill-galvanized steel sheet which has been outdoors in the industrial environment near Pittsburgh for four years. The sheet was exposed to the elements on September 20, 1971 and the photo was taken on September 20, 1975. As corrosion attacked, the galvanized coating on the top

surface has given up some of its zinc to be deposited by electrochemical action as a tough crust of zinc oxide on the cut edge. After four years, the only hint of rust is the slight yellowish spot on the right side of the photo.

Another advantage of galvanizing versus any surface coating is that the protective layer of zinc is metallurgically bonded **into** the steel. It won't peel off of the steel because it's actually a **part** of the underlying metal.

If you'd like to know more about the protective capabilities of galvanizing, write on your letterhead for our galvanizing booklets.

**GALVANIZING GIVES YOU LONG-TERM PROTECTION FOR YOUR INVESTMENT IN FABRICATED STEEL.**

**ST. JOE**  
MINERALS CORPORATION

250 Park Avenue, New York, New York 10017, Tel. (212) 953-5106

ZN-733



## The South: cooling off

Construction activity in the South has contributed to the exuberance and vitality of the Southern economy in recent years, and within short decades, economic development has been caught up with the industrialized North. Construction activity swelled also and between 1956 and 1975 the South increased its market share of total square footage of new construction from 25 per cent to 36 per cent. (See chart.)

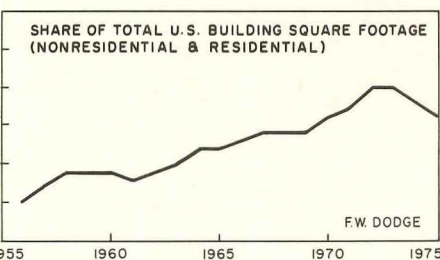

When expansion accelerated, constant pricing of the construction process was bound to produce the overheating that occurred toward the end of the sixties. Market share took an upward turn between 1969 and 1973 before dropping sharply in 1974 and 1975—the same decline in two decades.

The Southern economy has been the fastest growing of the four regional economies since World War II. Aggressive overtures on the part of local chambers of commerce were uniformly successful in luring manufacturers to the South, offering the enticements of tax abatements, and a non-unionized labor force. Manufacturing employment increased at a faster rate than in the Northeast and the Midwest as a result. White-collar jobs increased as well, as large corporations established headquarter offices in major Southern cities.

Further stimulus came from Federal government outlays in the South. The manned-space programs and many military installations in the post-war period resulted in the rapid expansion of Southern cities and the creation of many civilian jobs.

On top of everything else favoring the region, the South is the ideal place for the development of retirement communities as the proportion of the retirement age population in the United States increases.

Now let us take a look at the future of construction in the South, and consider two possi-

ble paths for its aggregate market share to take through 1980:

1. Extrapolation of the trend of the last two decades results in a level of 41 per cent by 1980.

2. Below-trend growth during a cooling-off period puts market share at 37 per cent by 1980.

There are two reasons, at least, to believe that the industry will proceed along path number 2. One is that a readjustment to a lower level is already taking place following the overheating of the 1969-1973 period, which resulted in high vacancy rates in office and residential buildings. The second is that the Midwest and the West, and to a lesser extent, the Northeast, are expected to strengthen their market positions over the next few years. (RECORD, May, June, July, 1976)

### Nonresidential construction

**Manufacturing:** Industry in the South is diversified and growing. Capital expenditures in Florida and Texas, for example, tripled and doubled, correspondingly between 1958 and 1972. Between 1956 and 1975, market share of manufacturing construction increased from 21 per cent to 31 per cent along a saw-toothed upward sloping path. In recent years, market share growth has been above the long-term trend, but a readjustment to a lower level is forecast for the near future. A 29-30 per cent level is projected for the end of the decade.

**Commercial building:** The South's share of commercial building hovered around 30 per cent between 1956 and 1968, and then, soared to 39 per cent in 1973 before falling back in 1974 and 1975. A 36 per cent increase in white-collar employment between 1966 and 1974 explains the surge in office building in the seventies. Market share of office building construction is expected to be at the 31 per cent level by the end of the decade, supported by anticipated higher levels of employment in the South.

Since 1966, the South has had an increasingly large share of the stores and shopping centers market, paralleling the growth in residential construction. Market share climbed from 31 per cent in 1966 to 39 per cent in 1973. The projected 36 per cent level by 1980 is in line with the long-term trend in residential construction.

**Institutional building:** The region's share of the institutional building market was growing very slowly through 1970, and then the South's

share rose sharply from 27 per cent in 1970 to 34 per cent by 1975. Construction of educational facilities has not fallen off as sharply as in other regions in recent years, and as a result the South's share has risen almost 10 percentage points over the last five years. Hospital construction has also contributed to the increase in market share along with construction of public buildings. The region is expected to maintain its market position and be at the 33 per cent level in 1980.

### Residential construction

**Single-family housing:** The sustained boom in single-family housing in the South was caused by population, income, and employment growth in the last two decades, as well as the comparative cost advantages enjoyed by the region because of climate and labor costs.

The region's share of single-family housing increased along a steep upward trend between 1956 and 1975. Market share rose from 26 per cent in 1956 to a peak of 44 per cent in 1972. The South is expected to retain its dominant role in the single-family housing market as population, income, and employment continue to grow beyond the present decade. Market share, however, will remain below the trend in the second half of the decade but is expected to resume an upward trend in 1978 reaching a level of over 40 per cent by the end of the decade.

**Multi-family housing:** During the multi-family housing boom of 1972-1973, the South had 44 per cent of the market compared with only 16 per cent in 1956. In 1961, the region's share began an uninterrupted climb to the 1973 peak before crashing to 25 per cent in 1975.

Both public and private construction drove up market share in the sixties and seventies. Over-expansion in the face of rising costs produced the highest vacancy rates in the nation. Market share is expected to remain relatively low but is expected to begin rising by the end of the decade and reach a level of 34 per cent by 1980.

In summary then, a cooling off period is expected to follow the overheating of recent years. During this period, the South's share of total square footage of new construction is expected to remain high, but will lie below the long-term trend line of earlier years. By the end of the decade market share will be rising again and a level of 37 per cent is forecast for 1980.

Jeanne A. Grifo, senior economist  
McGraw-Hill Information Systems Company



ONLY ONE FOAM  
INSULATION\*  
IS FIRE RATED  
OVER  
STEEL DECKS.  
THERMAX<sup>®</sup> ROOF  
INSULATION.

\*IN USA.



## **This is an industry breakthrough.**

We have just developed a non-composite foam insulation which qualifies for Factory Mutual Class 1 fire rating when installed directly over unsprinklered steel decks.

It's a roof insulation board never before available. One with all the advantages of urethane: thin profile, lightweight, ease of handling, meeting all of today's more exacting requirements for insulating values. And with a Class 1 fire rating.

**Celotex Thermax® Roof Insulation.** It is a strong, lightweight roof insulation board with a foam core (reinforced with glass fibers) sandwiched between two asphalt-saturated asbestos facer felts.

It gives you the high insulation values of urethane, plus fire rating, without requiring a second product like perlite, foam glass or fibrous glass between it and a steel deck.

**Superior insulating efficiency.** 1.2 inches - thick Thermax Roof Insulation boards give approximately the same insulation value as 3 inches of cellular glass, 2½ inches of perlite or 1⅝ inches of

fibrous glass. Because of this insulating efficiency, Celotex recommends Thermax Roof Insulation be applied in single thickness.

**Lightweight.** Compared with other FM-rated roof insulating materials providing the same insulation value, Thermax boards are 3 to 6 times lighter. That's up to 75% less deadload factor. The advantages are obvious: you can reduce the size and gauge of roof supports, have greater flexibility in choosing heating and air-conditioning equipment, reduce the size of metal or wood facia around roof perimeters. And still have that Class I fire rating.

**Are there any disadvantages?** No. It does not cost any more, it is easy to cut and handle, gives more footage per truckload, uses less warehouse space and requires less handling.

We started out by saying we had an industry breakthrough. We'd like to prove it to you. Contact your local Celotex sales representative, or call John Hasselbach direct: Commercial Roofing Department, The Celotex Corporation, Tampa, Florida 33622.

**Celotex®**

BUILDING PRODUCTS  
The Celotex Corporation, Tampa, Florida 33622

a JIM Walter company



# Antron® II nylon. The known for its lasting

Architect: Vincent G. Kling & Partners, Philadelphia, Pennsylvania.  
Flooring Contractor: B. Shehadi & Sons, Livingston, New Jersey





# DuPont carpet fiber good looks. At A.T.&T.

New A.T.&T. Administration Building,  
King Ridge, New Jersey.



carpet—all 150,000 square yards—is a special  
construction with pile of Antron\* II nylon.  
Antron\* II was selected for its outstanding  
long-term appearance-retention qualities.

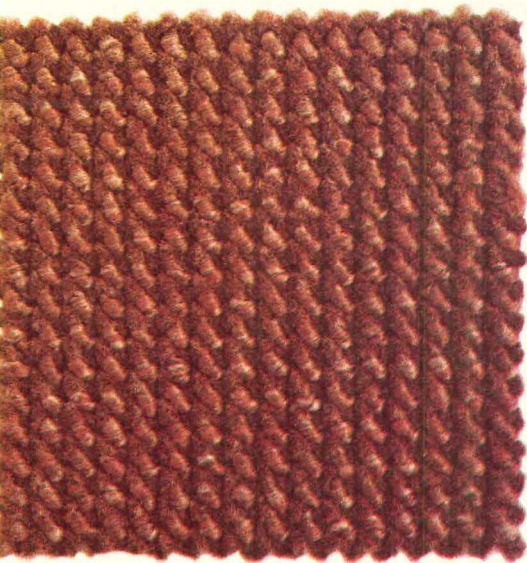

**"Antron" II?** "Antron" II nylon is designed  
to mask the presence of soil. And, because it is

a nylon, it's the most abrasion-resistant of all  
carpet fibers. In addition, "Antron" II has a  
pleasant, subdued luster, unlike bright or  
sparkle-luster fibers that can dull rapidly in  
contained high-traffic areas. Cleanability and  
texture retention are excellent.

These are the properties most specifiers  
expect from "Antron" II, the fiber known for its  
lasting good looks. And they are among the  
reasons why it is the leading contract carpet  
fiber brand.

**How "Antron" II masks soil.** Here in this 250X  
electron micrograph, you can see the remark-  
able four-hole fibers of "Antron" II. The four  
microscopic voids scatter  
light to mask soil and help  
blend soil concentrations  
into the overall carpet look.  
The smooth exterior shape  
minimizes soil entrapments,  
making cleaning more  
effective than irregularly  
shaped fibers.



**"Antron" III nylon** for durable, effective static  
control is available in most styles in "Antron" II.

**Specifier's Information Kit.** For more information—a  
carpet manufacturers' resource list, a specification guide  
for commercial office buildings, and a maintenance man-  
ual—write: Du Pont Contract Carpet Fibers, Centre Road  
Building, Room AR, Wilmington, DE 19898.

\*Du Pont registered trademark. Du Pont makes fibers, not carpets.

## Antron® II.

### The leading contract carpet fiber brand.



REG. U.S. PAT. & TM. OFF.







Now... for large fixed window applications

# Pella's new Clad Pivot Window

**the high performance pivot window with the beauty of wood inside**

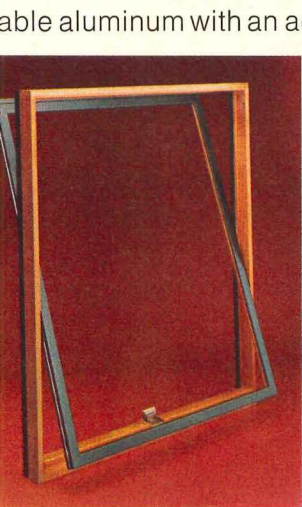

The sash brings outdoor glass surface inside for fast and economical maintenance. When pivoted, the sash is held in washing position by a keylock.

It's the newest addition to the Pella Clad System, and like the rest of the system, it's designed to be virtually maintenance-free. The exterior is protected by a skin of durable aluminum with an acrylic enamel finish that won't chip or peel. To help cut maintenance costs even further, it pivots to permit exterior glass to be washed from inside the building.

But what really makes this new Pivot Window unique is its wood construction. Wood not only contributes a rich, warm look inside, but its unsurpassed insulating value makes it a wise choice in today's energy-short economy.

Two different models are available — Pivot, with a single sash, and Pivot Contemporary which includes

two sash within a single frame, the upper one pivoting and the lower one fixed. Keylocks, standard on all units, prevent unauthorized operation but allow opening for washing and emergency ventilation. All units can be equipped with Pella's Double Glass Insulation System and Pella Slimshades®.

For complete specifications fill in and mail the coupon today.

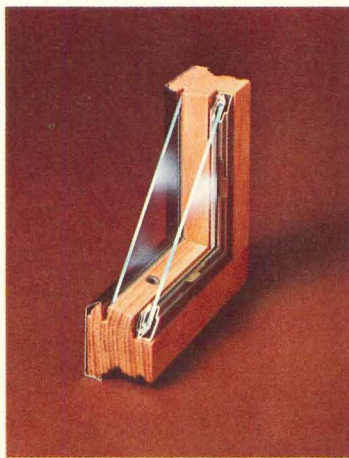

Pella's *Energy-Tight* Double Glass Insulation System has 13/16" dead air space between panes—provides maximum insulation at lowest costs. Insulating glass also available.

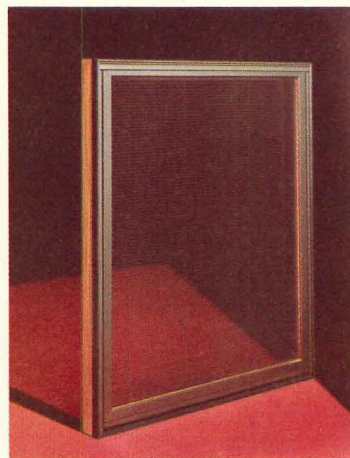

Optional Pella Slimshade® fits in the dust-free space between the panes of the Pella Double Glass Insulation System and provides privacy and light control at the touch of a dial. Helps reduce heat loss and solar heat gain, as well.

Please send me complete specifications on the new Pella Clad Pivot Window and other Pella products.

Name \_\_\_\_\_

Firm \_\_\_\_\_

Address \_\_\_\_\_

City \_\_\_\_\_

State \_\_\_\_\_

ZIP \_\_\_\_\_

Telephone \_\_\_\_\_

**Mail to:** Pella Windows & Doors, Dept. T3116, 100 Main St., Pella, Iowa 50219.  
Also available throughout Canada. This coupon answered within 24 hours.

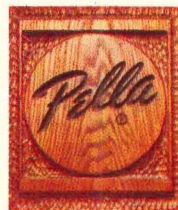

© 1976 Rolscreen Co.

For more data, circle 51 on inquiry card





The Prudential Insurance Company  
55 N. Livingston Ave., Roseland, N.J.  
Architect: The Grad Partnership, Newark, N.J.



# Integrated Ceiling Systems from Johns-Manville.

## Now you can create ceilings that work as beautifully as they look.

Appearance and performance. That's what you'll have when you specify an integrated ceiling system from Johns-Manville.

Our wide choice of attractive ceiling configurations allows you the kind of design freedom you want. And we've combined these with lighting, sound control and air handling options—all from one manufacturer—for a truly integrated ceiling system.

### **Attractive modular grid intersection.**

Until now, modular ceiling grids have rarely been the object of aesthetic praise. We're introducing one that will be, with mitered flanges and a thru-regress at all intersections.

And, it's versatile. Air boots go anywhere on any runner. Telephone and electrical wiring is easily dropped through the grid.

Besides outstanding appearance and versatility, the grid shape offers superior structural properties. It's roll-formed from 25-gauge steel and locks together in three planes to accommodate vertical, lateral and torsional loads.

### **Efficient distribution of light.**

J-M Integrated Ceiling Systems feature Holophane luminaires, backed by 75 years of experience and technical leadership in providing energy-efficient lighting solutions. Our

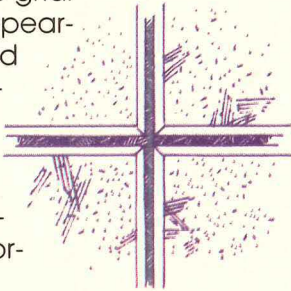

luminaires provide visually comfortable illumination, too. Even the new energy-saving HID lamps may be used without creating brightness problems.

We also offer computer-aided evaluations of lighting layouts for your project planning.

### **True sound control.**

With J-M Integrated Ceiling Systems, you can select the acoustical material most appropriate for your requirements. Whatever the criteria—NRC, STC, durability, appearance or fire endurance—you have a choice of J-M acoustical products.

### **Quiet, dependable ventilation.**

J-M air handling systems are known for reliability and flexibility. They maintain excellent distribution patterns even at low volume outputs and go virtually unnoticed in the ceiling. You don't see them and you don't hear them. And, if you want to move an air terminal, it's as simple as lifting it from the current position and inserting it at the new. No tools are required.

Learn more about Johns-Manville Integrated Ceiling Systems. Call your local J-M office or write: Johns-Manville Sales Corp., Holophane Division, Greenwood Plaza, Denver, Colorado 80217.

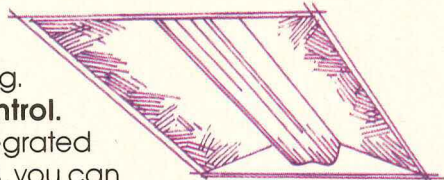

## Johns-Manville



# If you want all the latest answers,

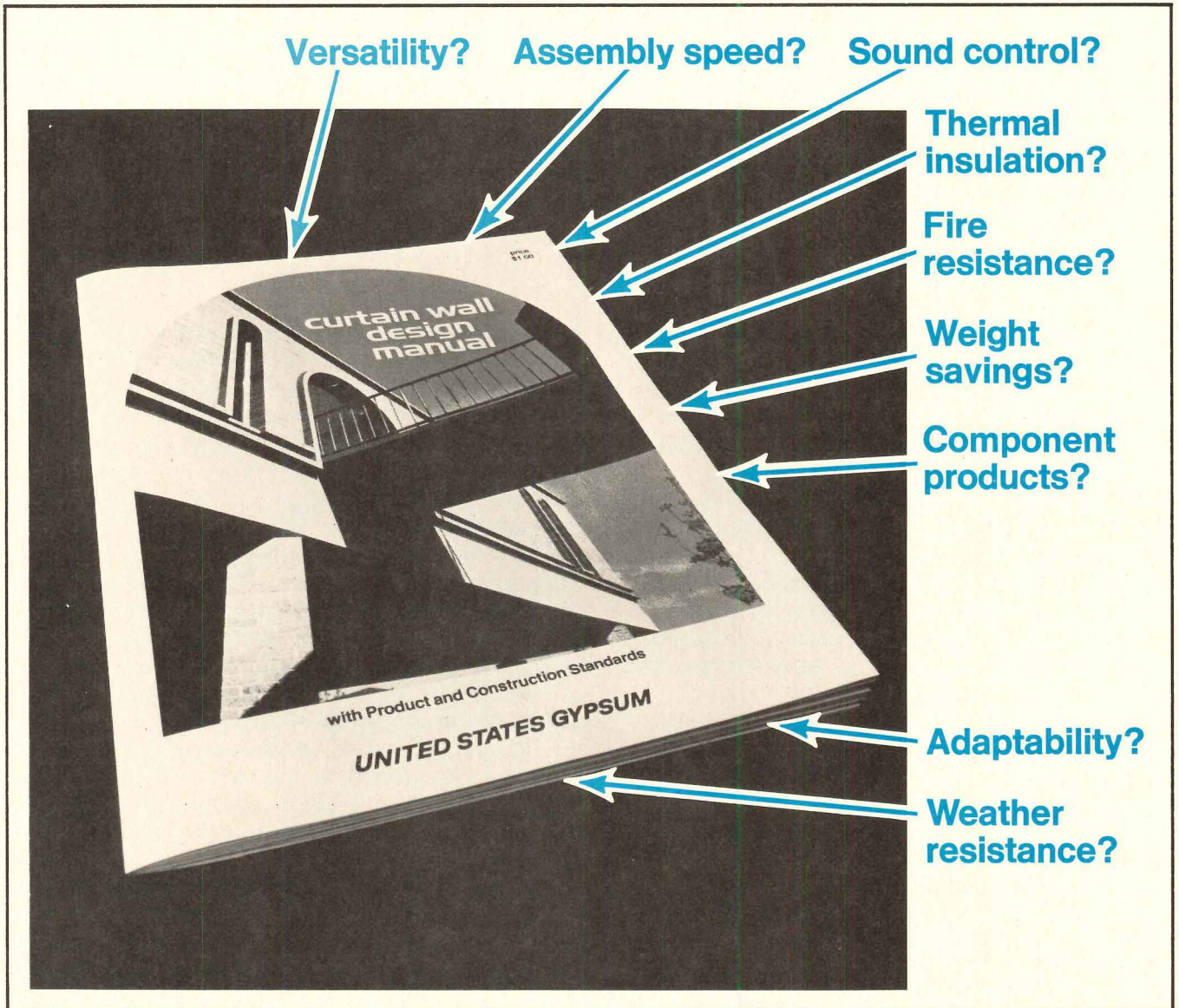

Versatility?

Assembly speed?

Sound control?

Thermal insulation?

Fire resistance?

Weight savings?

Component products?

Adaptability?

Weather resistance?

## just ask.

This new STEEL-FRAMED CURTAIN WALL design manual is yours for the asking. U.S.G. covers everything for you in this handy reference guide, from bed-rock basics to the latest information regarding Problems and Remedies, Physical Test Data and Applications for Stucco, Brick or Panel Facings. Mail the coupon now and update your knowledge of the many advantages of USG® Curtain Wall Systems . . . the low cost way to enclose concrete and steel frame structures.

United States Gypsum, 101 S. Wacker Drive,  
Chicago, Illinois 60606, Dept. AR-96

I'm asking . . . so please send your new answer book,  
The Curtain Wall Design Manual, to:

Name \_\_\_\_\_

Firm \_\_\_\_\_ Title \_\_\_\_\_

Address \_\_\_\_\_

City \_\_\_\_\_ State \_\_\_\_\_ Zip \_\_\_\_\_

**UNITED STATES GYPSUM**  
BUILDING AMERICA

For more data, circle 53 on inquiry card





## An open-air opera house **STAGE LIFTS BY DOVER**

The unusual design of the Santa Fe Opera House opens the audience to the New Mexico sky. Each summer, international opera stars perform here in imaginative and innovative productions. The superbly equipped stage features two Dover Stage Lifts, one in the orchestra pit, and one at the rear of the stage, used for stage effects and for moving scenery between levels. For more information on Dover Stage Lifts, write Dover Corporation, Elevator Division, Box 2177, Dept. A, Memphis, Tennessee 38101.

**DOVER** Stage Lifts

*For more data, circle 54 on inquiry card*

Santa Fe Opera House, Santa Fe, New Mexico  
Architects: McHugh, Kidder, Burran, Wright, A.I.A.  
Contractor: Modern Construction Co.  
Dover Stage Lifts sold and installed by Dover Elevator Co.  
Lift data:  
Orchestra lift: 17' X 54' overall,  
39,320 lbs. lifting capacity, 8' travel.  
Scenery lift: 18' X 24' overall,  
21,600 lbs. lifting capacity, 37' travel, 4 stops.



# We're seen in all the best places.



Louisiana State University – Baton Rouge, La.

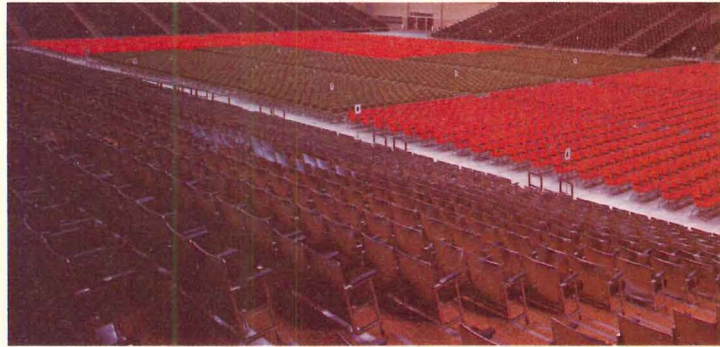

Everett R. Cook Civic Center – Memphis, Tenn.



Dothan Civic Center – Dothan, Ala.

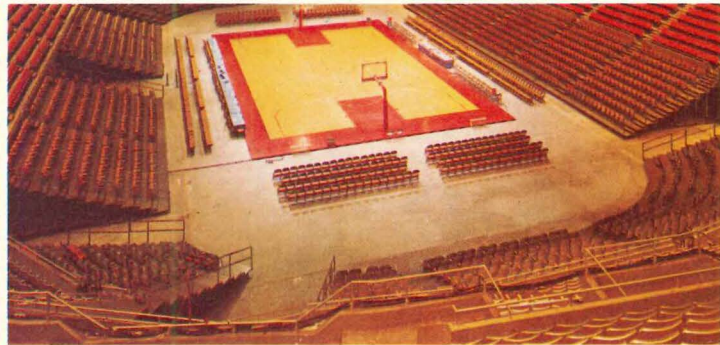

Nassau Coliseum – Uniondale, L.I.



North Texas State University – Denton, Texas



Dayton Exposition Center – Dayton, Ohio

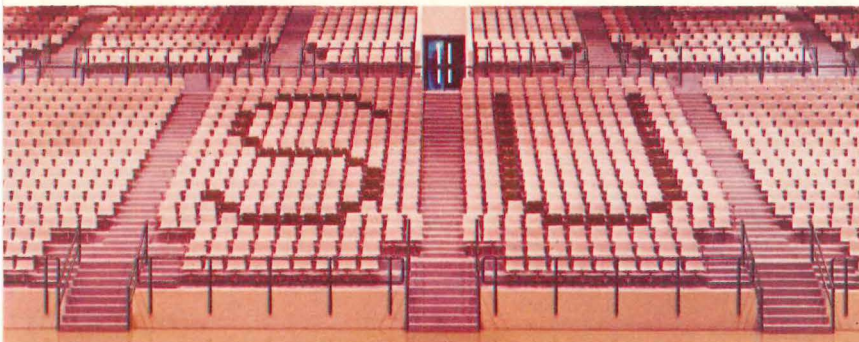

Stetson University – Deland, Fla.

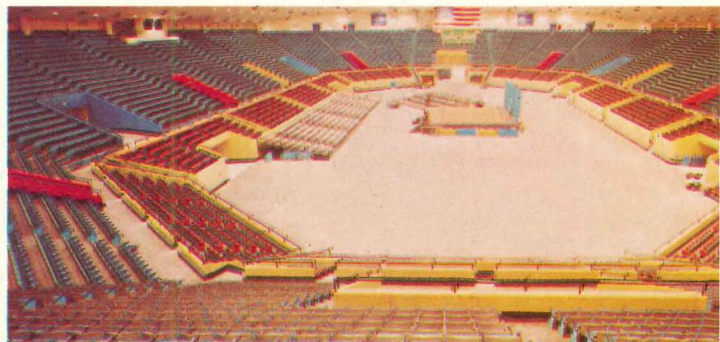

Freedom Hall – Louisville, Ky.

Heywood-Wakefield  
The First and Last Word in Public Seating



Heywood-Wakefield Company Menominee, Mich.





# Why Zonolite® Monokote® fireproofing is as basic as the steel it protects.

The optimum fire protection system still remains the subject of much research and debate. But one fact is recognized: no matter what combination of sprinklers, smoke detectors and other devices are used, there should be no trade-off in basic structural protection. Zonolite® Monokote® fireproofing provides the basic protection needed to maintain the structural integrity of your building.

- Monokote protects steel columns, beams and decks, which can buckle and fail at 1100° F, and minimizes the chance of costly structural steel repairs.
- Monokote helps contain fire by minimizing the passage of heat through steel decks and concrete floors.
- Monokote becomes an integral part of your structure, sheathing supporting members with a permanent, durable, protective, monolithic surface.
- Monokote is quickly and safely spray applied to desired thicknesses for up to four hours of protection.

Monokote is a proven product, backed by the long and extensive fireproofing experience of W. R. Grace & Co. For complete information on fireproofing that is as basic as the steel it protects, contact your local Zonolite Monokote representative or write Construction Products Division, W.R. Grace & Co., 62 Whittemore Avenue, Cambridge, Massachusetts 02140. In Canada, 66 Hymus Road, Scarborough, Ontario M1L 2C8.

## GRACE



A photograph of a brick building entrance. The entrance is framed by a semi-circular canopy with a white, grid-patterned ceiling. Four large, spherical pendant lights hang from the ceiling. Below the canopy is a set of double doors with a decorative pattern of circular cutouts. The building is constructed of red brick, and the entrance is set on a concrete walkway.

# Aluminum Entrances



Kawneer means variety. The broadest and most comprehensive selection of entrance systems from any architectural aluminum products manufacturer is available from Kawneer. From stock door "packages" to the exciting spectrum of monumental building entrances like the Entara entrance system, the variety is virtually limitless.

### How to turn 12 into thousands,

The variety begins with 12 basic door systems. And then, each can be adapted to meet special design or functional needs. For example, the basic 190 series door can be specified in more than 200 separate and distinct combinations of push/pull hardware, operating hardware options and finishes. Each element is designed and engineered to meet the exact and unique requirements of any entrance situation. And, in a complete system of design coordinates, such as Entara, the exact number of entrance styling and functional combinations is practically unlimited. Kawneer makes more out of entrances so designers can make more of their buildings.

# by Kawneer

And yet, behind this wide variety available in Kawneer entrances is only one standard of engineering and construction: The very best. Each Kawneer Entrance System is a total performance combination of door, frame, and hardware that will stand up to the demands of traffic volume and building usage. The excellence of engineering and rugged construction is backed by a continuing program of testing which assures the user that Kawneer Aluminum Entrance systems will provide efficient performance for years and years. No matter what the variety.



A helpful, 28-page guide to entrance systems is available from Kawneer. Write for your copy of *Aluminum Entrances by Kawneer*. Kawneer Product Information, 1105 North Front Street, Dept. C, Niles, Michigan 49120.

**KAWNEER**  
ARCHITECTURAL PRODUCTS  
1105 NORTH FRONT ST., NILES, MICHIGAN 49120

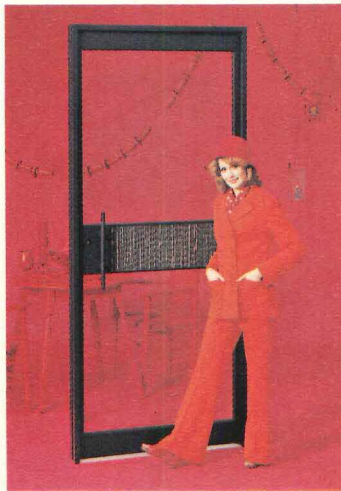

I-Line series 3000 door in Permanodic Black finish with tapered pull and Stria textured panel in Pewter finish.

I-Line 4000 Series entrance in clear anodized aluminum finish, with panels of Quarry texture in Pewter finish and a cast aluminum pull handle.



"190" door in Clear anodized aluminum finish with F-2 style hardware.

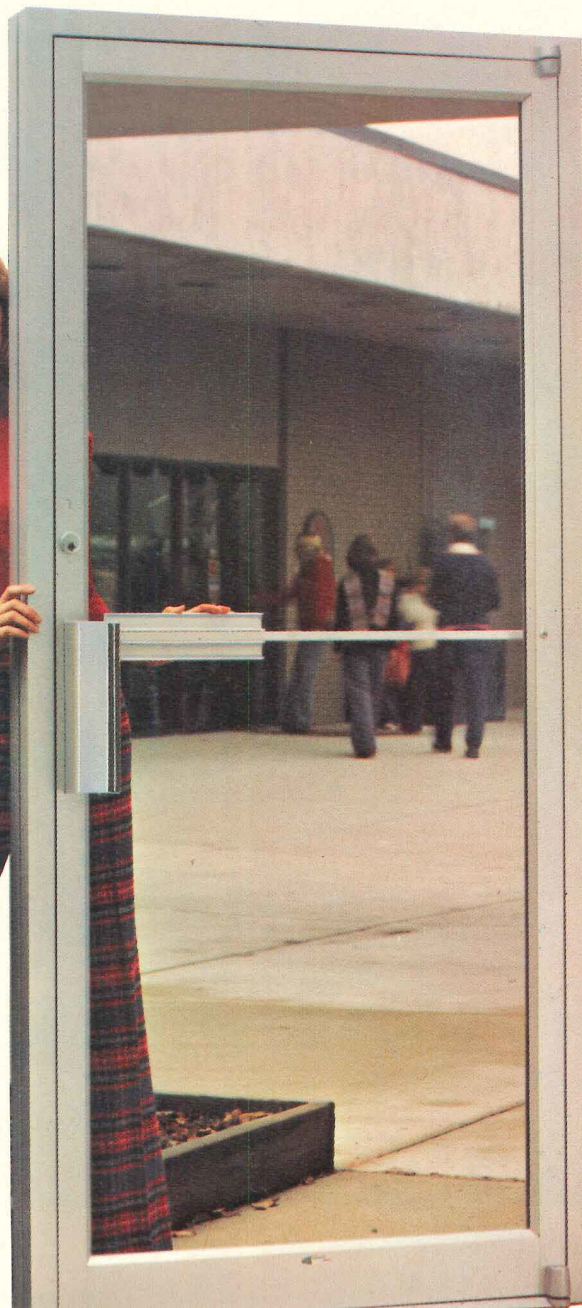



# This building ha laughs, cries and fal

**That heat source is people.  
And the efficiency of Vari-Tran®  
helps make it all possible.**

There is nothing conventional about the use of energy at the Ontario Hydro Building in Toronto. The building operates at a comfortable temperature year round without a standard heating system. Climate control is maintained by recycling the heat generated from the building's lights, equipment—even people.

The result is a building that operates using less than half the energy of a conventional structure of equal size.

With the help of Vari-Tran coated glass, the Hydro Building has become an architectural Mecca for energy efficient construction. Monolithic Vari-Tran 1-114 fabricated into insulating units was specified as an integral component in the building's sophisticated mechanical design.

We want you to know the energy and dollar savings LOF high performance glass can mean for your clients. Contact one of our architectural representatives or Marty Wenzler at Libbey-Owens-Ford Company, 811 Madison Avenue, Toledo, Ohio 43695. They'll be glad to put our computer to work on a spec sheet for a building you have in the works.

For more detailed information on our products, please refer to the LOF Sweet's Catalog, "Glass for Construction."





# heat source that love.

Hydro Place, Toronto, Canada  
Canada Square Corporation  
Architects: K. H. Candy, Chief. Arch.—Ontario Hydro, and  
an Assoc., Toronto, Ontario  
K. R. Cooper, Toronto, Ontario  
Contractor and fabricator of insulating units: Pilkington Glass Ltd.

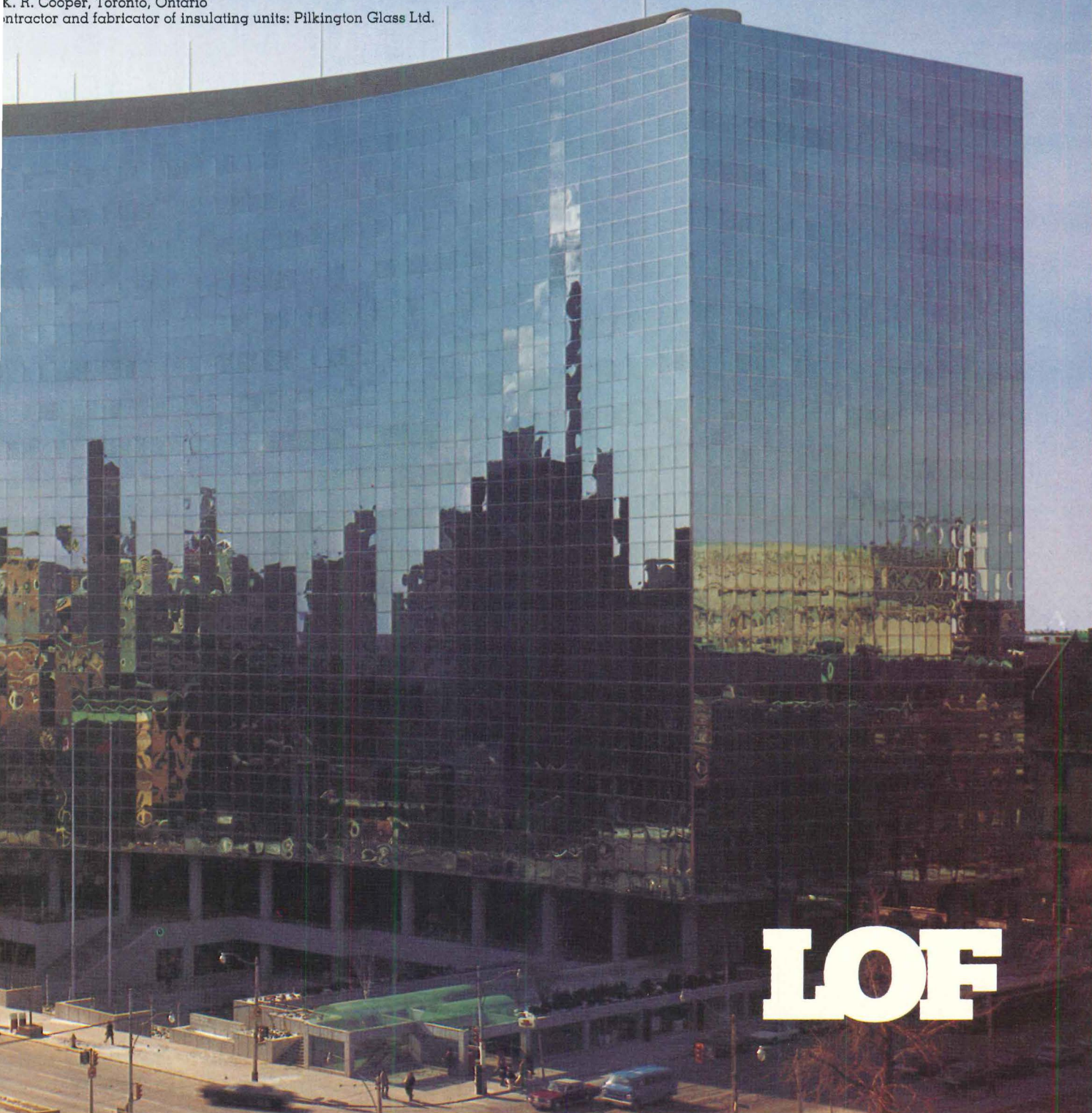

# LOF



# There are times when you want a feeling of warmth.



Weyerhaeuser wood doors warm up any room.

We manufacture the broadest line of architectural wood doors in the industry. Stave lumber core. Particle core. Fire. Sound retardant. X-ray. All with the natural warmth of domestic hardwood veneers. Or you can specify MDO or plastic laminate faces.

Our complete line of custom serv-

ices includes factory finishing, special detailing and beveling, machining for hardware and security devices, moisture protection, computerized estimating and coordinating production to your job schedule.

And for warm doors that also stay cool, specify Weyerhaeuser wood fire doors.

After 30 minutes in a fire, a hollow-core metal door can reach al-

most 1000°F on the side opposite the fire.

Under the same conditions Weyerhaeuser wood fire door v increase in temperature less th 250°F. That's a 750-degree marg of safety.

Our wood fire doors are rated 90, 60, 45, 30 and 20 minutes. Th meet or exceed all major buildi codes. And have been independe



# And there are times you don't.



tested by Underwriters Laboratories, Inc.

Every architectural door we make carries a full performance warranty and, where applicable, the U.L. label.

There's no better guarantee in the industry.

So, when you're thinking doors, think warm. Or think cool. But think Weyerhaeuser.

## Architectural Doors

**Weyerhaeuser Company, Box B-2983, Tacoma, WA 98401**

Send us this coupon for complete information on our entire line of wood doors. We'll also send you our new door poster. It provides a comprehensive look at our line, plus valuable code information at a glance.

Name \_\_\_\_\_ Firm \_\_\_\_\_

Address \_\_\_\_\_

City \_\_\_\_\_

State \_\_\_\_\_ Zip \_\_\_\_\_ Phone ( ) \_\_\_\_\_



**Weyerhaeuser**



# IF OUR FREE SPECIFICATION GUIDE DOESN'T ANSWER ALL YOUR QUESTIONS ABOUT ACRILAN® ACRYLIC CARPET FIBER, OUR SPECIALISTS WILL.



## ANY QUESTIONS?

Write for Monsanto's new Acrilan Specification Guide. Call (404) 434-4949 for assistance from a Specification Specialist.

Dear Monsanto, AR-9  
 Yes, I have some questions on Acrilan I want answered. Please send me your new Specification Guide, free of charge.

NAME \_\_\_\_\_

FIRM \_\_\_\_\_ TELEPHONE \_\_\_\_\_

ADDRESS \_\_\_\_\_

CITY \_\_\_\_\_ STATE \_\_\_\_\_ ZIP \_\_\_\_\_

Monsanto Textiles Company  
 320 Interstate North Parkway Atlanta, Georgia 30339 (404) 434-4949

For more data, circle 61 on inquiry card

## Yesterday...

Yesterday's look . . . today's materials and energy saving light sources. This cast aluminum lantern duplicates the appearance of hand wrought Swedish black iron. It's the latest in AAL'S NOSTALGIA line. A variety of finishes, lamps, and lenses available. Matching wall mount brackets, too. For complete information and color brochure, write on your letterhead.



**ARCHITECTURAL  
 AREA LIGHTING COMPANY**  
 13901-B South Carmenita Road  
 Santa Fe Springs, Calif. 90670  
SUBSIDIARY OF LCA CORPORATION

For more data, circle 60 on inquiry card

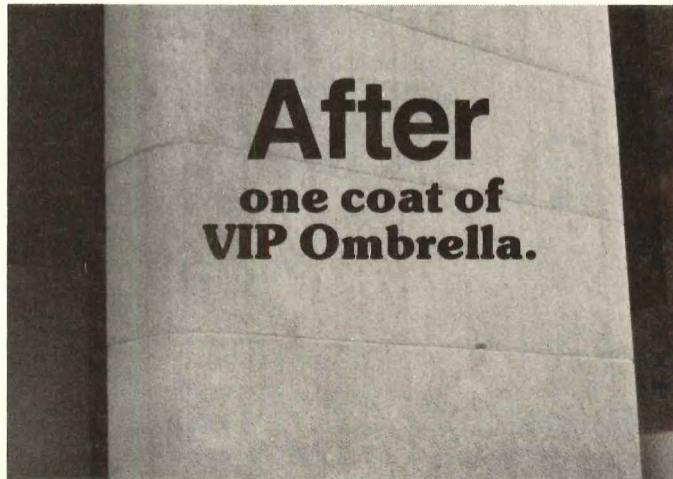
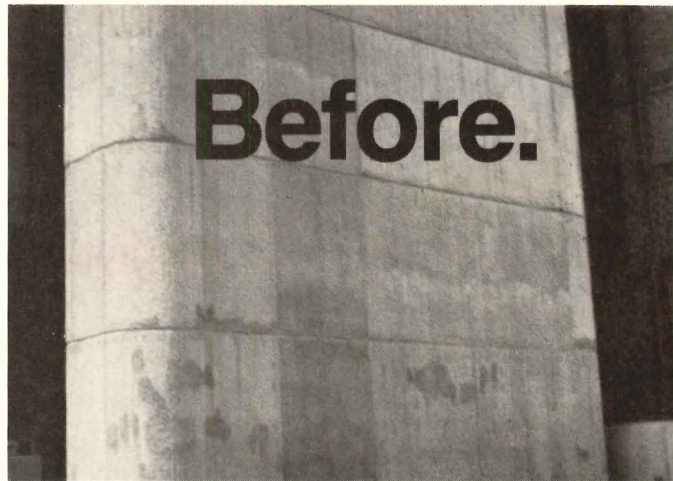

**"Umbrella exceeded our expectations. All color imperfections have been blended out and the towers appear to be 10 stories of monolithically poured concrete"**

... John P. Fullerton, A.I.A.  
 Nichols, Fullerton, Py & Vavra

Now, for the first time, you can waterproof natural concrete or masonry and do away with stains, form marks and patching without streaking or lapping. Simply apply VIP Umbrella semi-opaque.

If your concrete or masonry looks great, protect it with VIP Umbrella clear. You'll be protecting your client, too.



**The first semi-opaque coating that waterproofs but won't streak, run or show lapp marks. And our clear has 26% solids—the highest in the industry.**

VIP Waterproofing Systems, 7245 N.W. 43 St., Miami, Fla. 33142  
 VIP Umbrella—clear and semi-opaque • VIP ter-polymer sealers  
 VIP ter-polymer coatings—smooth and high-texture  
 VIP roofing system—the proven liquid-applied roof

For more data, circle 63 on inquiry card



About the only way  
to pick this lock is to select it.



Emhart High Security Locking System. A major advance in positive protection for buildings that breaks dramatically with traditional lockset design. Unique cross-cut key bit\* and interlocking tumbler pins create astronomical odds against picking.

DirMo II Design. Other designs and functions available tailored to your security and styling needs.



HARDWARE DIVISION, EMHART CORPORATION  
BERLIN, CONNECTICUT 06037





# BECAUSE OF MASONRY FIRE WALLS, THE ONLY THING THAT SPREAD FROM SUITE 503 WAS NEWS THAT THE FIRE WAS OUT.

When fire breaks out in a building, the critical concern is control. Smoke detectors and sprinklers may help. But a sure way to prevent the spread of fire and protect lives and property is with masonry fire walls, designed and built between rooms, suites and apartments for just that reason.

Masonry fire walls insure that fire will stop where it starts. And assure a flame-free exit for occupants and approach for firemen. There are no "working parts" to malfunction; yet masonry fire walls are always working to provide sound barriers and structural support even when they aren't needed to stop a blaze cold. And because they

stand up to extreme water pressure, masonry's fire rating is waterproof, too.

Despite all preventive measures, fires do break out in buildings. So design and build for maximum fire control with masonry. No matter what type of building you're designing or erecting.

It could mean the difference between a five alarm fire and very little cause for alarm.



**INTERNATIONAL MASONRY INSTITUTE**

Suite 1001, 823 15th Street, N.W., Washington, D.C. 20005 (202) 783-3908

*For more data, circle 65 on inquiry card*

THE MASON CONTRACTORS AND BRICKLAYERS UNION OF CANADA & THE U.S.A.





You told us what you wanted in a pre-engineered elevator system...and the price you needed for today's market.

The Otis GO-LINE has it, and much more.



You asked for a wide choice of carrying capacities so we could precisely satisfy your building's needs. We have you eleven different selections to choose from. You wanted off-the-shelf delivery and fast, efficient installation by experienced crews to prevent a lot of problems. The GO-LINE has it.



You requested large, digital readout fixtures inside the car so passengers can position themselves for prompt exit at desired floors. You wanted highly visible directional lanterns, located in both car entrance columns, combined with an audible signal to alert waiting passengers. The GO-LINE has it.

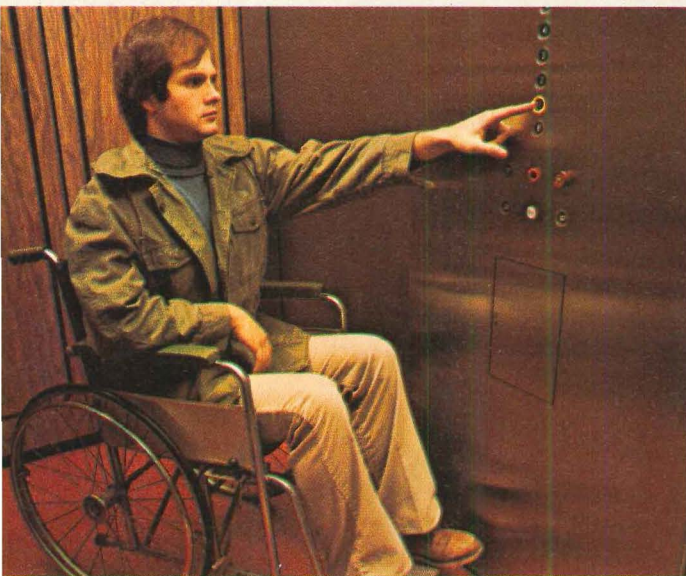

You told us you wanted fast, positive door operation and instant door reversal to protect entering and exiting passengers. You specified solid state control to improve equipment reliability. You wanted control panels designed for easy accessibility by wheelchair using passengers. The GO-LINE has it.

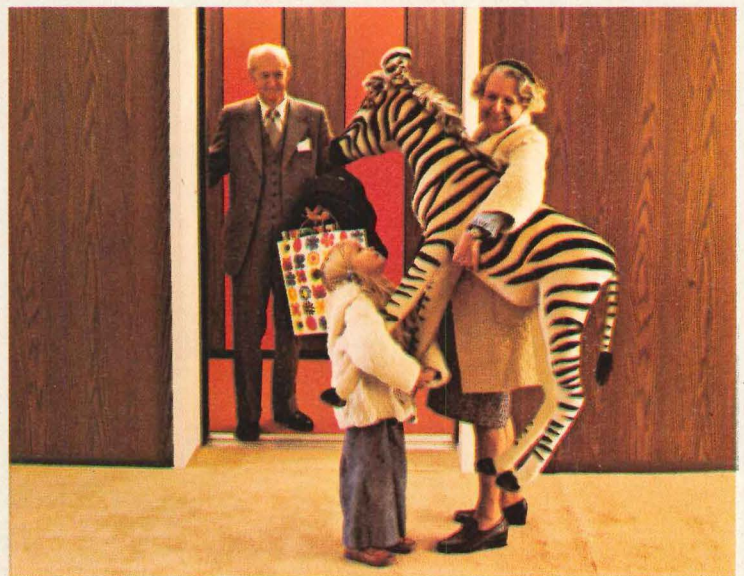

You wanted the option of adding special emergency equipment, emergency lighting and power, telephones, intercoms and key switch control. You asked for a wide choice of easy-to-maintain wall panels, with a variety of carpet and ceiling colors to match your building's decor. The GO-LINE has it.

And you asked us to maintain the traditional Otis quality...at a price you can live with. We did what you asked. The GO-LINE has it all.

**Otis**  
Elevator Company



# Technical service and practical design aids ease design of this Weathering Steel parking structure.



*Client:* Virginia Department of Highways & Transportation; *Owner:* Town of Grundy, Va.; *Designers:* Higgs & Higgs, Inc., Vienna, Va.; *Consultant Architect:* James W. Ritter, Springfield, Va.; *Contractor:* Wiley N. Jackson Company, Roanoke, Va.; *Fabricator:* Structural Steel Company, Inc., Roanoke, Va.; Structural steel furnished by Bethlehem Steel Corporation.

The depth of the mountainside excavation, which greatly influenced the cost of the project, dictated the need for a long (240 ft), narrow (63 ft) structure.



# depend on Bethlehem

ate road-widening project through Grundy, Va., eliminated many of the town's Main Street parking spaces. And because of the area's steep terrain, alternative off-street parking sites were available.

Solution: build a three-level, 144-car parking structure into the side of a mountain to replace the spaces eliminated by the construction.

The difficult nature of the site immediately suggested the use of structural steel framing. It could provide the required column-free long spans. And it could be erected rapidly.

**Engineering service valuable.** "Bethlehem Sales Engineering personnel were very helpful in furnishing us with technical publications and advice," reports Mr. Gerry E. Higgs, president, Higgs & Higgs, Inc., designers of the structure. "Two slide presentations, featuring steel-framed parking structures and the use of Weathering Steel in construction, were given to our engineering staff. It was also on the advice of Bethlehem's Sales Engineer that we considered Weathering Steel for the interior, as well as the exterior framing of the structure."

**Weathering Steel?** The designers decided on ASTM A588 Weathering Steel for both the exterior and interior framing for two reasons: (1) it provides a very rustic appearance which, when fully matured, will blend well with the surroundings of this rural coal mining community; and (2) its low maintenance will minimize future financial burdens on the town.

Several special design details are employed to minimize staining during the weathering process. Open slots are placed in the concrete slabs around all columns to avoid runoff from the columns onto the slabs. At grade level, gravel berms surround all the column bases.

**Architectural considerations.** A low-profile parking structure was desired in order to avoid overpowering the neighboring one- and two-story buildings. The design features an open structure with exposed steel framing, partially clad with sand-blasted precast panels.

A set of ramps at the south end provides entrance and exit to the parking structure. One of the ramps also serves as the entrance and exit right-of-way for the property on the mountainside above the parking garage. The system of circular and straight ramps allows one-way traffic to be maintained on all parking levels. Stair towers, located at each end of the structure, control pedestrian flow.

**Technical and advisory services available.** Bethlehem's Sales Engineering Division offers a wide variety of services to help make it easier for you to design in steel. Our Preliminary Framing Analysis can provide you with budget information for the total "systems package" of a structure under study . . . Our advanced engineering group can assist you with technical evaluations. For more information, just call the Bethlehem Sales Engineer at the Bethlehem office nearest you. His number is listed below.

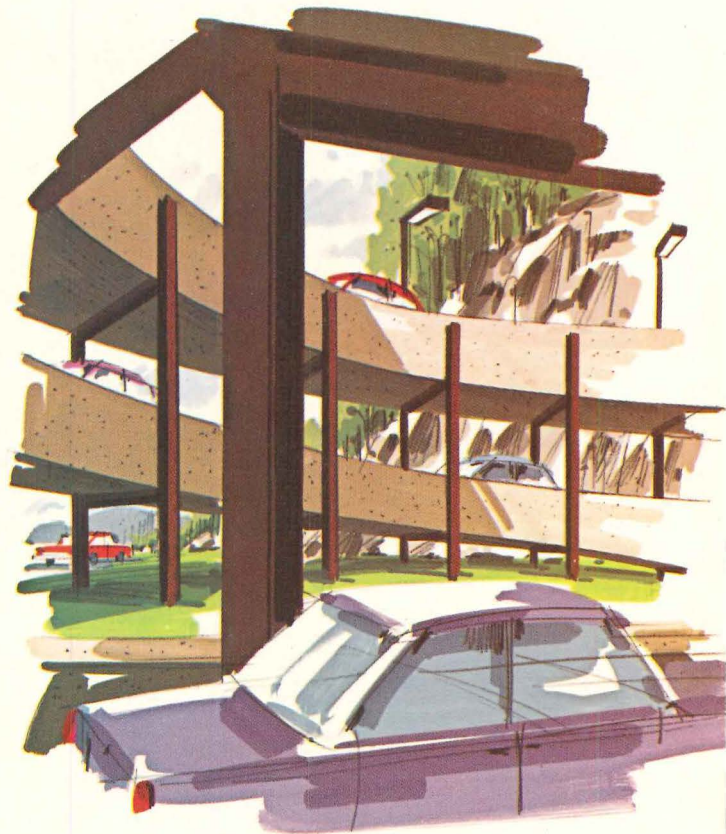

A circular ramp at the north end permits traffic flow from the level below to the one above.

## Bethlehem



### Phone:

Atlanta (404) 522-4918	Los Angeles (213) 726-0611
Baltimore (301) 685-5700	Milwaukee (414) 272-0835
Boston (617) 267-2111	New Haven (203) 865-0833
Buffalo (716) 856-2400	New York (212) 688-5522
Chicago (312) 664-5422	Philadelphia (215) 561-1100
Cincinnati (513) 381-6440	Pittsburgh (412) 281-5900
Cleveland (216) 696-1881	St. Louis (314) 726-4500
Detroit (313) 336-5500	San Francisco (415) 981-2121
Houston (713) 659-8060	Seattle (206) 285-2200

Ask for Sales Engineer

Slide presentations, as well as numerous Bethlehem publications and design aids, provided valuable assistance to Higgs & Higgs, the project's designer.





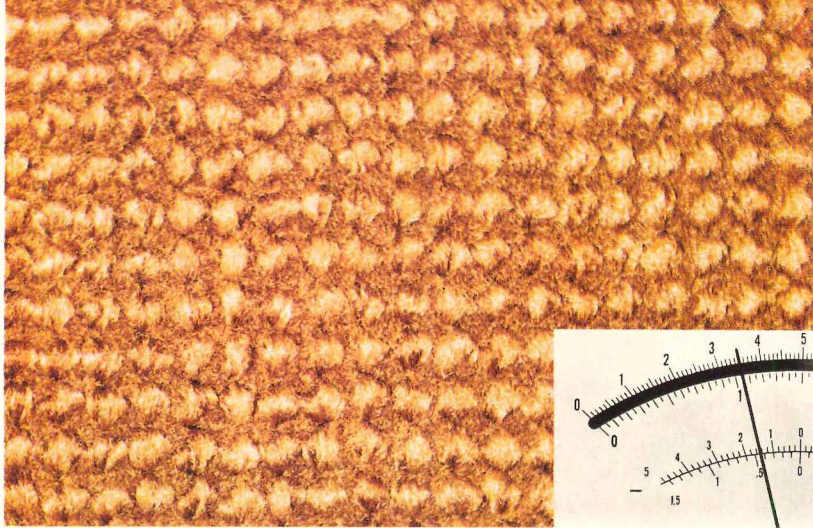

Static generated by nylon.

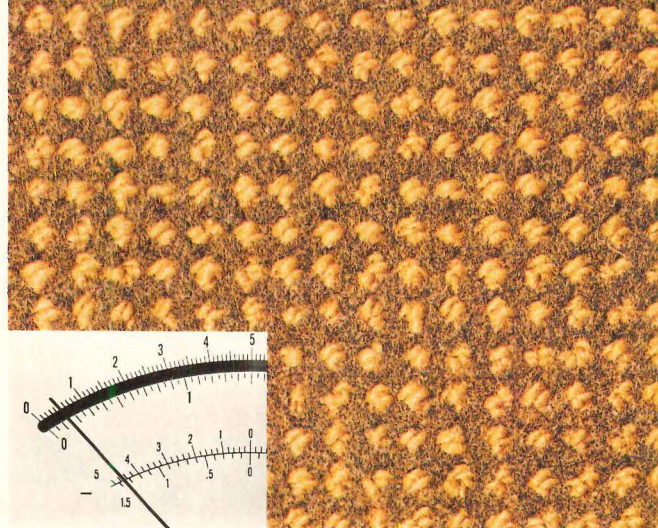

Static generated by Fortrel PCP.

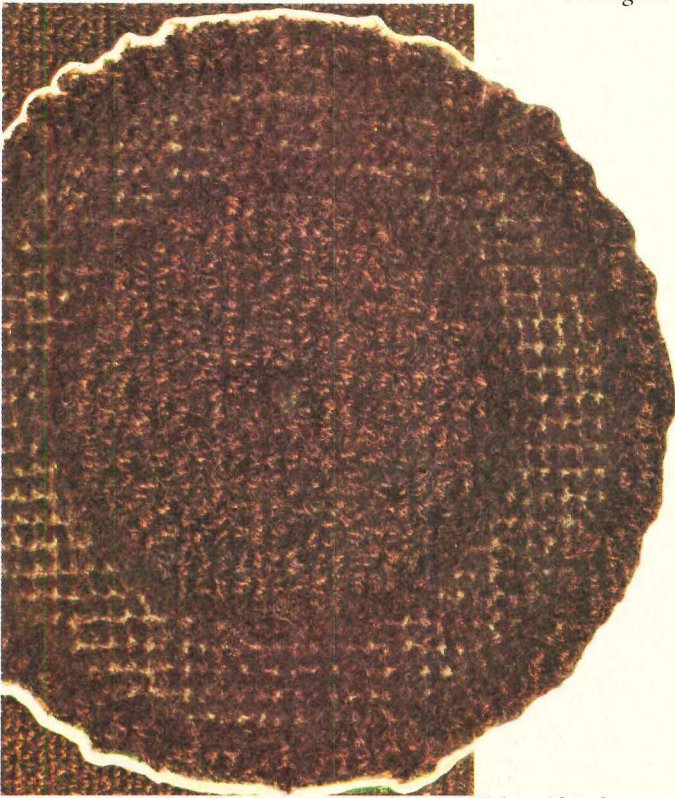

Acrylic after 1,800 cycles on a Taber Abrader.  
Fortrel PCP after 1,800 cycles on a Taber Abrader.

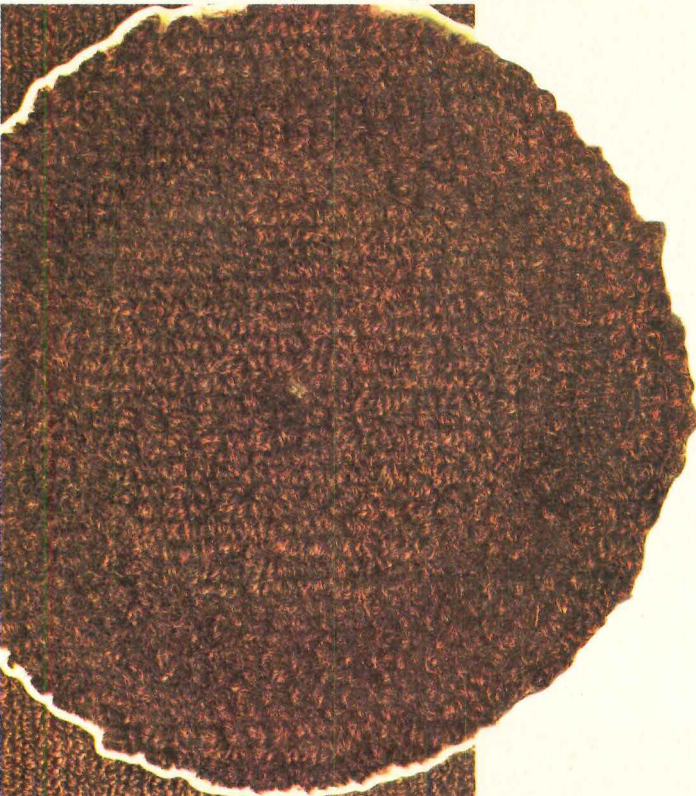

## Which carpet

You're looking at photos of the actual results of the tests conducted by Certified Testing Laboratories, Inc. The carpet of Celanese Fortrel PCP polyester, and commercially available carpet of similar construction in different fiber.

Fortrel PCP outperforms them.

### More Durable.

After only 1,800 cycles on a taber abrader (taber abrasion test ASTM D-1175), the carpet of acrylic fiber reached the breaking point (abraded to backing) and registered a pile weight loss of 11.6%. The carpet of Fortrel PCP polyester didn't reach the breaking point until 22,000 cycles! And didn't lose 11.6% of its pile weight until 29,900 cycles.

### Less Static.

In checking static generation, the AATCC Walk Test with Neolite Soles (134-1969) was conducted. Carpet of Fortrel PCP polyester generated a maximum static of 1.5 kilovolt, well below the threshold of human sensitivity (Even below the level necessary for such delicate applications as computer rooms and hospitals.) The carpet of Antron II, even with metallic protection, generated seven times as much static—3.5 kilovolts.

### No Fading.

In the AATCC Colorfastness to Light Test (Test Method 16E), the carpet of Fortrel PCP polyester showed no evidence of fading or color change after 100 hours of exposure.



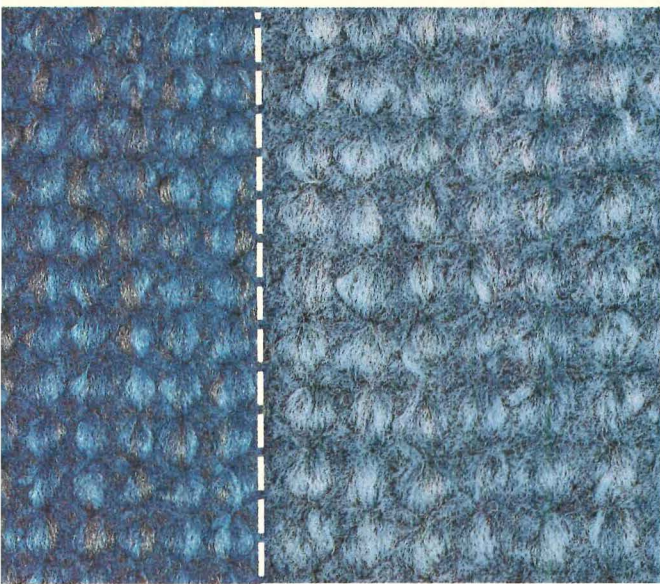

*Nylon before & after exposure to 1500 hrs. of Xenon-Arc lamps.*

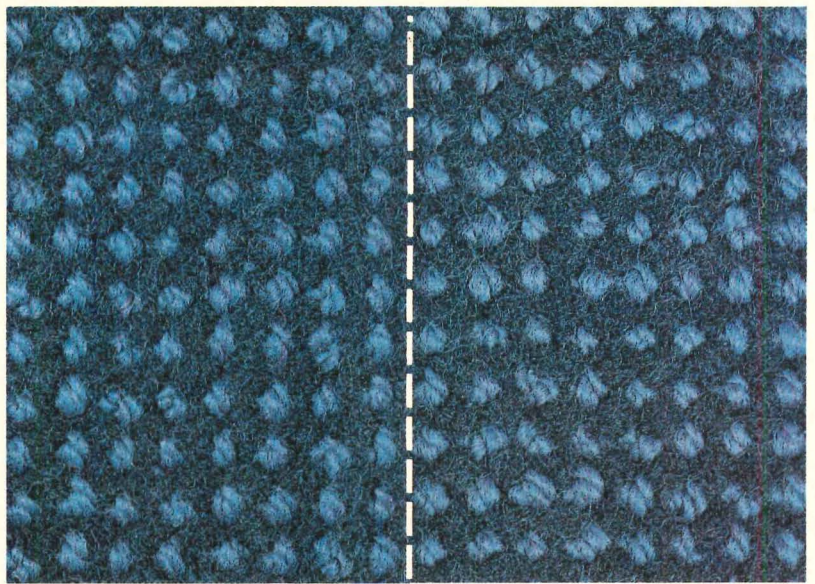

*Fortrel PCP before & after exposure to 1500 hrs. of Xenon-Arc lamps.*

# Do you want on your floor?

1500 hours of exposure to Xenon-Arc lamps. (That's 15 times the industry standard.) The carpet of nylon faded substantially well before 1500 hours.

## Wear Guaranteed.

These are only three of twelve testing standards that every carpet of Fortrel PCP polyester must meet before it is awarded our five-year wear guarantee. It's the *only* wear guarantee available anywhere on contract grade polyester carpeting that guarantees that "if the surface pile of the carpet wears more than 10% within five years from the date of initial installation, Celanese will replace the affected area with equivalent carpeting absolutely no cost to you."

Now you can be sure which carpet you want on your floor. The one that resists static, fading, wearing, staining, soiling, and mold. And has a five-year guarantee around. Fortrel PCP.

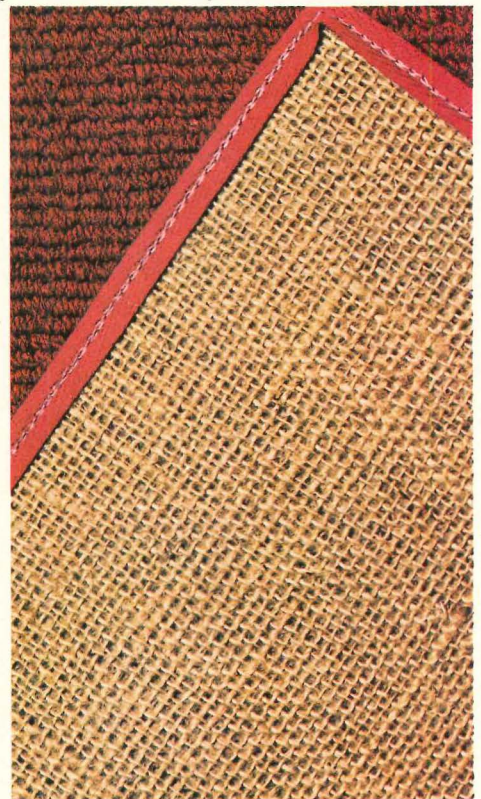

*The back of most carpeting.*

*The back of carpeting of Fortrel PCP polyester.*

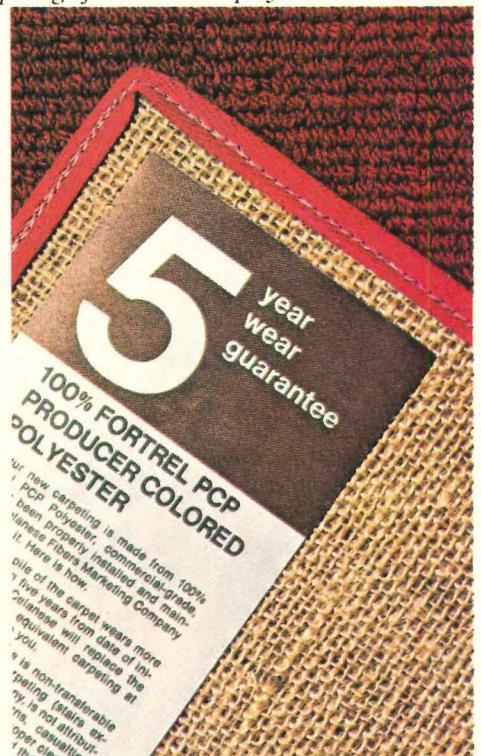

If your new carpeting is made from 100% Fortrel PCP polyester, commercial-grade, and has been properly installed and maintained, Celanese Fibers Marketing Company guarantees it. Here is how.

If the surface pile of the carpet wears more than 10% within five years from date of initial installation, Celanese will replace the affected area with equivalent carpeting at absolutely no cost to you.

Note that the guarantee is non-transferable and applies only to carpeting (stairs excluded) for which wear, if any, is not attributable to negligence or burns, casualties, cuts, pulls, and the use of improper cleaning methods or other causes beyond the control of Celanese.

This guarantee applies only to commercial-grade carpet as defined in Fortrel Polyester Carpet Performance FT-207.



Fortrel PCP is a trademark of Fiber Industries Inc., a subsidiary of Celanese Corporation. Celanese Fibers Marketing Company is a division of Celanese Corporation.

**Your next five years are guaranteed with:  
FORTREL PCP**

# This time do it right.

Floor Coverings Department, Celanese Fibers Marketing Co., 1211 Avenue of the Americas, New York, N.Y. 10036, (212) 764-7640.

For more data, circle 67 on inquiry card



# The beauty of Alcoa Coilzak in parabolic luminaires is the beautiful way it controls light.

Parabolic luminaires are esthetically pleasing, in the design of the fixture and in the type of light they dispel. This is particularly important where people work, read or shop, where low visual brightness contributes to a comfortable atmosphere. The secret is precise light control, made possible because the reflective material in quality parabolic systems is Alcoa\* Coilzak lighting sheet. Note that we said *lighting sheet*. In a properly designed luminaire, reflectivity is only part of the story. Controlled image clarity and reflective diffusion are just as important. Alcoa Coilzak sheet is an Alzak®-finished reflector material that meets precise reflectivity and gloss standards.

Operating costs of a parabolic lighting system can be low. Because of its efficient light

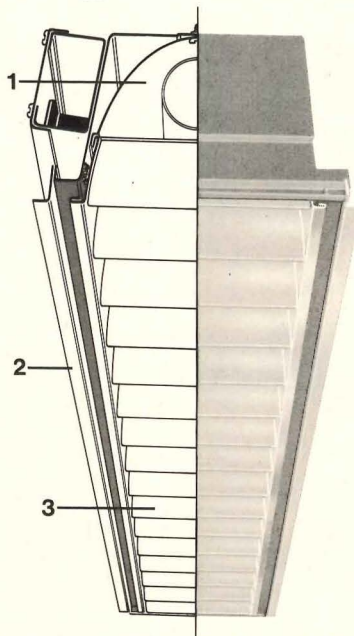

distribution, a properly planned system may require fewer luminaires, resulting in low electrical loadings. Savings in cleaning maintenance are possible also. Parabolic luminaires do not require a lens and the unique design, plus the static-free Coilzak louvers, resists soil and dust accumulation.

For more information on the many beautiful advantages of Coilzak lighting sheet in parabolic luminaires, write Aluminum Company of America, 551-J Alcoa Building, Pittsburgh, PA 15219.

\*Registered Trademarks of Aluminum Company of America

1. One-piece constructed Coilzak reflector with accurately controlled parabolic shape.
2. Extruded aluminum trim.
3. Coilzak parabolic baffle assembly.



Change for the better with  
Alcoa Aluminum

 **ALCOA**



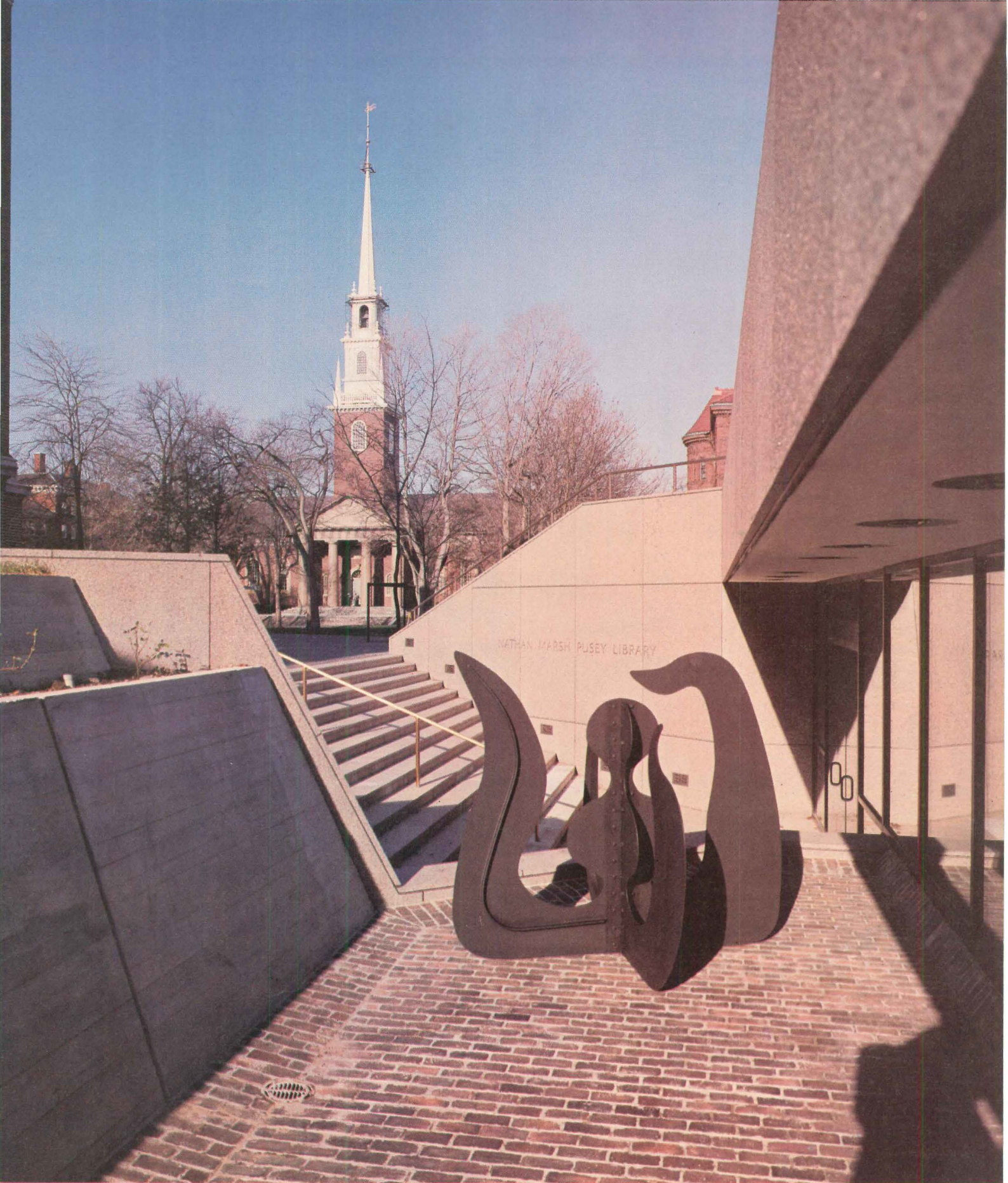

**IN DEFERENCE  
TO ITS ENVIRONMENT  
THE PUSEY LIBRARY WAS BUILT  
BENEATH HARVARD YARD**

By partially burying this three-level library underground and covering its roof with grass, planting, and paths which reinforce the existing circulation patterns of Harvard Yard, architects Hugh Stubbins and Associates have added an essential structure while preserving open space. Glass windows, concealed by sloping berms along two sides of the exterior and a central light court introduce natural lighting to staff and reader areas. Shown above is the principal entrance. The mobile in black steel is Alexander Calder's "The Onion."



The most recent addition to Harvard Yard is a courteous and restrained new library. It is a background building constructed for the most part below grade on a site that was too constricted for a building above ground. Harvard Yard, of course, is a place of great historic interest, a museum of native American architecture of every period and an environment revered by generations of Harvard students, Cambridge citizens, and lovers of campus architecture.

Before being asked to design the Pusey Library, Hugh Stubbins Associates had been engaged to survey the entire twenty-two-acre Yard with the object of improving access and services.

After careful observation of the patterns of activity and circulation within the Yard, the architects proposed that it be completely closed to automobiles and parking except for service and emergency access. This was implemented by the university.

Originally it had been thought that the proposed library should be completely subterranean, but new concepts of landscaping led to the idea that the building could emerge at least slightly above ground. The architects foresaw an opportunity they have since effectively capitalized upon—that of designing the library in a way that would open up new vistas within the Yard as seen from the inside of the new structure, or from its landscaped roof. Just as importantly, allowing the building to surface brings daylight into the interiors.

From the beginning, the Pusey Library was seen as an interconnecting link among three existing libraries — Widener, Houghton and Lamont (see site plan right), and an extension of each. Its roof has become a link as well, its paths and landscaping reinforcing the existing circulation network in the Yard. Inside the library, the principal circulation corridor is directly beneath the main diagonal path on the roof. The three major entrances to the new library are at important campus nodes. The principal entrance is directly to the east of the grand staircase of the Widener Library; the second is at the corner formed by Houghton and Lamont; the third is adjacent to 17 Quincy, the former official residence of the president of the university, now used for miscellaneous functions.

The new structure, which has been so precisely and definitively attached to its neighboring build-

The view across the landscaped roof of the new library (right) is as seen from the front of the Widener Library. The steps lead to the principal diagonal path, which connects with the circulation system of the Yard. The main entrance of Pusey is below grade at the foot of a staircase to the right of this stair. The stairway (below) also leads to the landscaped roof of Pusey. It is located between Houghton Library and Lamont Library.

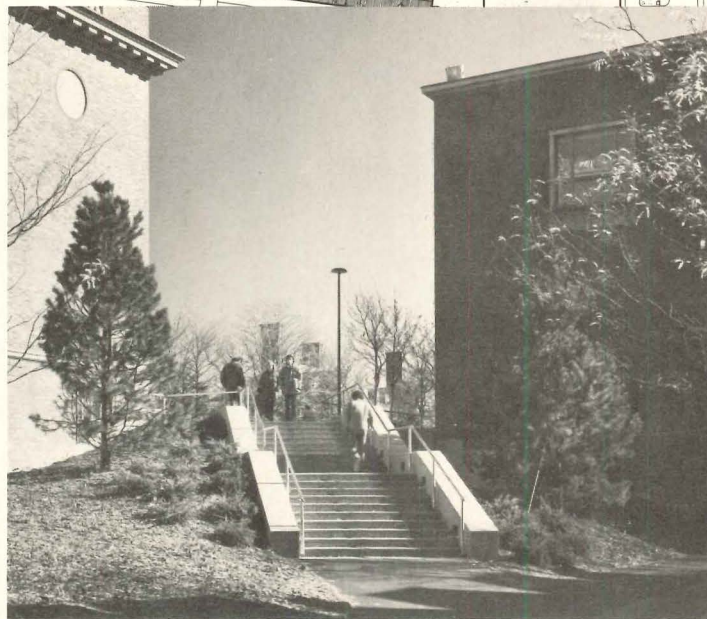
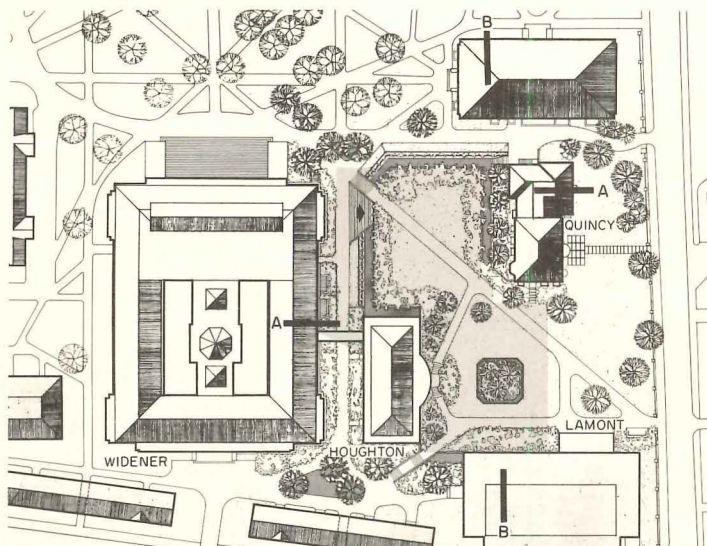

© Steve Rosenthal

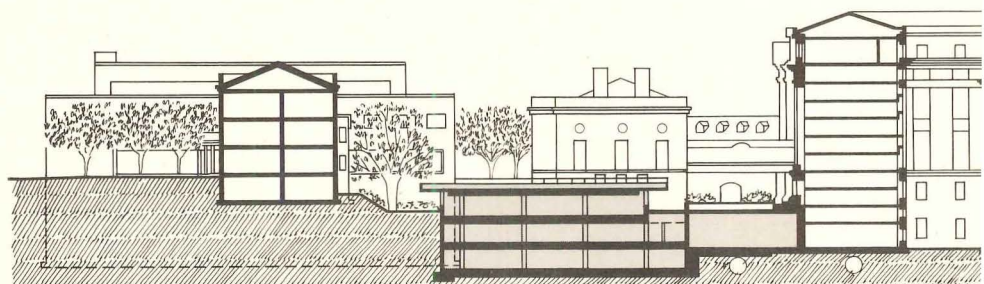

SECTION A-A





Edward Jacoby

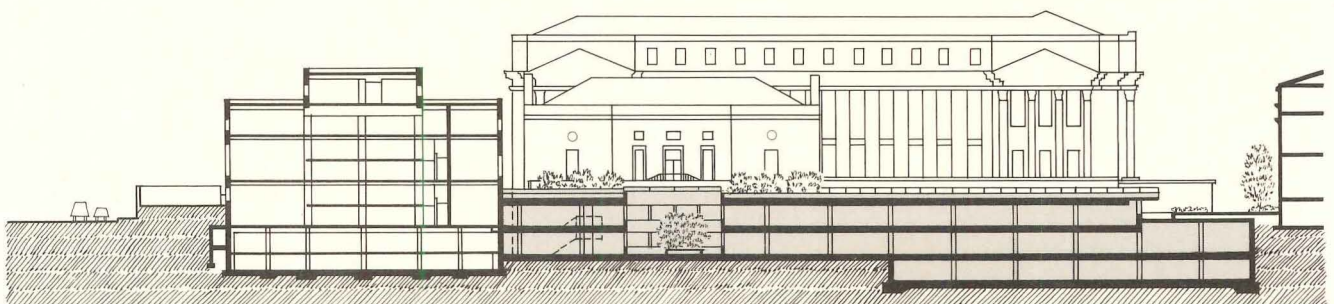

SECTION B-B



ings and to the campus infrastructure, adds 87,000 square feet to the buildings that comprise the Harvard College Library, which is a subdivision of the Harvard University Library, the largest university library in the world. Of the eight libraries within the College Library, three required their own reading rooms and better conservation of their priceless collections. These are the Harvard Theatre Collection, the Harvard University Archives and the Harvard Map Collection. The memorabilia of President Theodore Roosevelt needed adequate storage and display. Since, with the passage of time, books once regarded as commonplace have become rare, space had to be created that would allow such books to be kept at a temperature and humidity protective of their paper and bindings. Finally, as in all college libraries, the variety of services had increased and the collections were growing at rapidly accelerating rates. The new library accommodates the expanding general collections of Widener Library and the manuscript collections of Houghton.

In visible exterior form, the Pusey Library is a slanting grass-covered embankment as can be seen in the photos at right. Its roof is a stone-rimmed platform of earth containing a lawn, trees and shrubs, diagonally bisected by paths and stairs. On axis with the Neo-Georgian bow-front of Houghton is a square sunken courtyard (opposite page bottom right), which admits light to major interior spaces.

The portion of the building that appears above the surface is surrounded by a broad band of brick paving, which forms a moat between the berm and the window wall. At the top of the berm is a deep concrete trough planted with shrubs and vines.

Construction began on the Pusey Library in 1973 and was completed this spring at a cost of \$5,653,000.—*Mildred F. Schmertz*

NATHAN MARSH PUSEY LIBRARY, Harvard Yard, Cambridge, Massachusetts. Owner: *President and Fellows of Harvard College*. Architects: *Hugh Stubbins and Associates, Inc.*—*design: Hugh Stubbins, Peter Woytuk; project architect: Merle T. Westlake; project manager: Howard Goldstein; landscape: Robert Fager; interior design: Tetsuo Takayanagi*. Engineers: *LeMessurier Associates/SCI* (structural); *Haley and Aldrich* (foundations); *van Zelm, Heywood and Shadford* (mechanical/electrical). General contractor: *The Volpe Construction Co., Inc.*

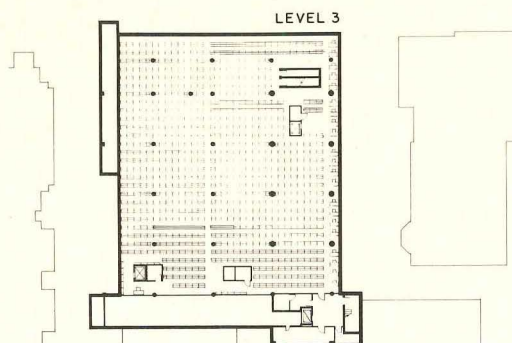
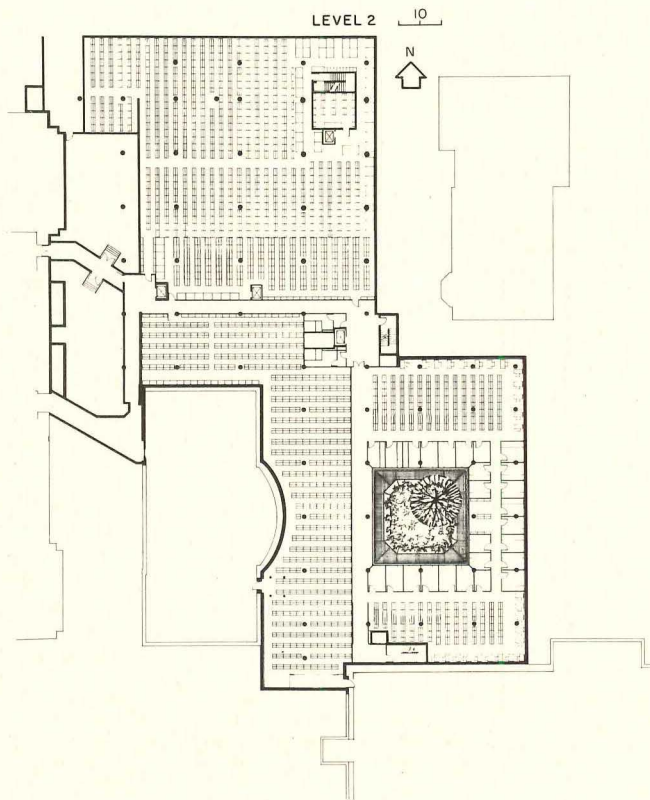
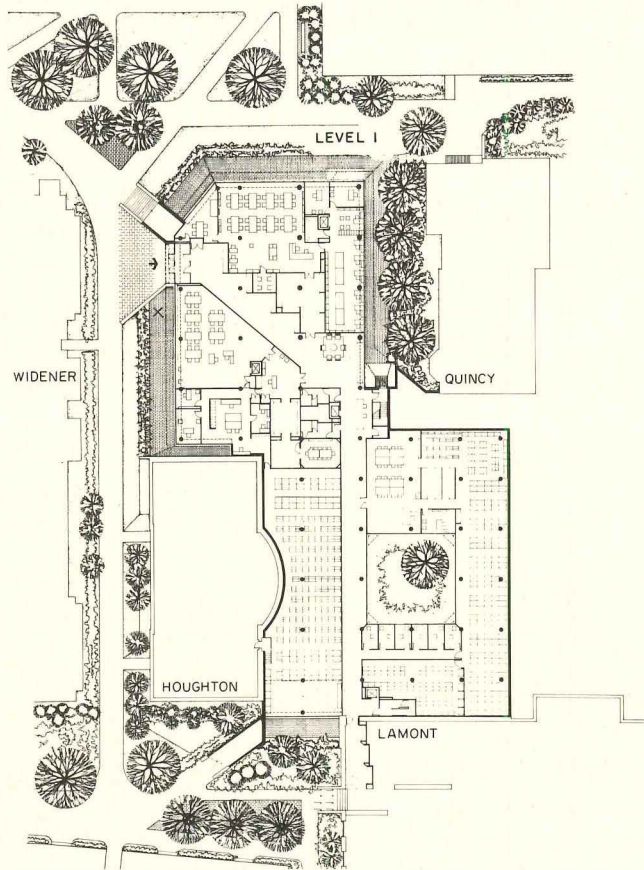

Edward Jacoby

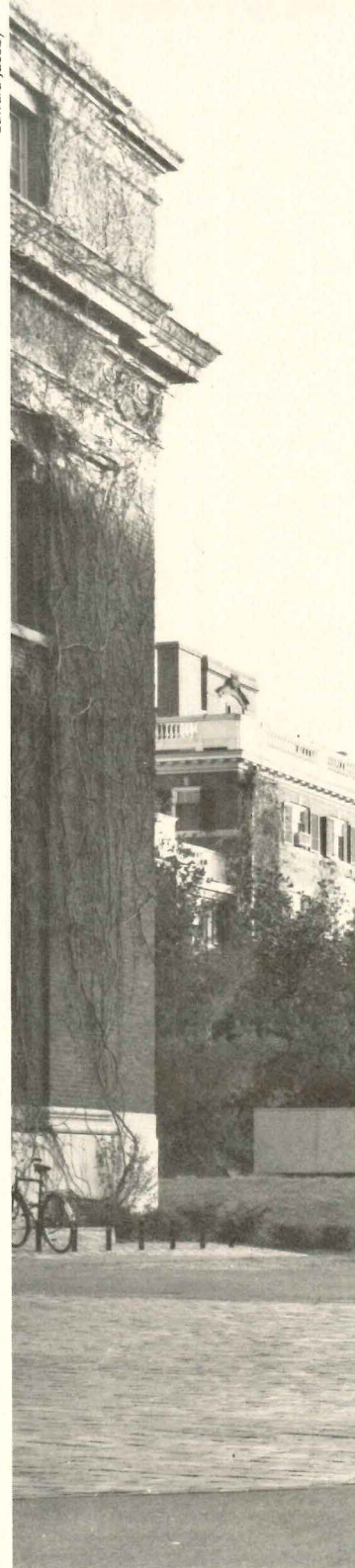

Edward Jacoby

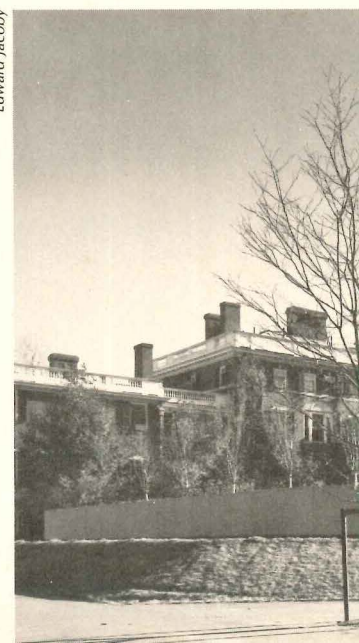





© Steve Rosenthal



As the main level plan (opposite page top) indicates, the library has been organized to provide good visual control from the circulation desk located just beyond the lounge adjacent to the exhibition gallery. The photograph (top) shows the degree to which the apparent bulk of the library has been minimized by the slanting berm. To the left of the photo is the corner of Emerson Hall and 17 Quincy. To the rear are Lamont and Houghton and to the right is Widener. The courtyard (right) is two levels deep. It is faced with panels of shipsaw granite alternating with bands of glass. The court is a small garden with a brick surround.

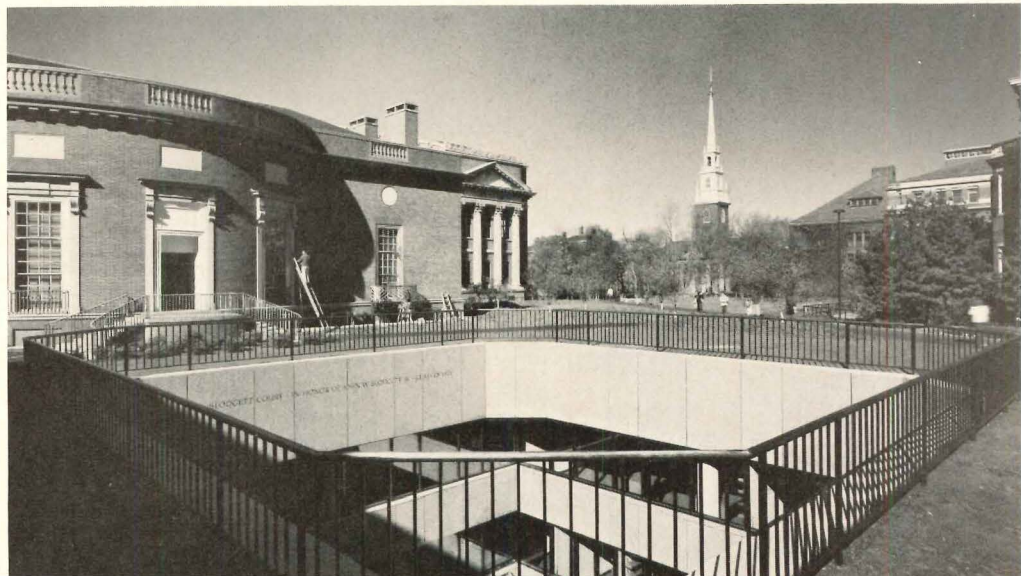



## PUSEY LIBRARY

All the interiors and custom-built fixtures were designed by the architects. Nylon carpeting is used throughout except in bookstack areas. Most of the furniture is of oak, as is the trim. Walls are covered with a textured vinyl fabric with a flat off-white, non-reflective surface. The acoustic ceilings are also off-white. Chairs are upholstered in either muted tweeds or brown leather. The daylight is softened by window hangings of natural hemp in an open-weave geometric pattern. All metal, from the window mullions to the smallest door hinge, is of bronze or bronze-finished aluminum. Accent lighting is either incandescent, or fluorescent warmed by gold reflectors within the light fixtures.



Edward Jacoby photos

The photo (top) is of the reading room for the theater collection. The principal corridor (middle) is an exhibition gallery. It contains four large oak framed, acrylic-fronted exhibition cases for changing exhibitions. The gallery opens into the lounge (left) with a long display case beneath the window overlooking the moat. The lounge is a hub that provides access to the theater collection and archives, as well as to the central circulation desk just visible at the edge of the picture.





# THREE INTERIORS

BY GWATHMEY-SIEGEL  
FOR DIFFICULT SPACES AND  
COMPLEX PROGRAMS

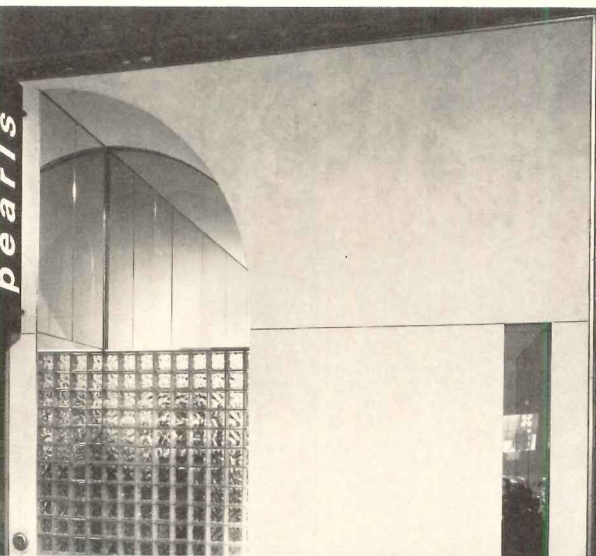
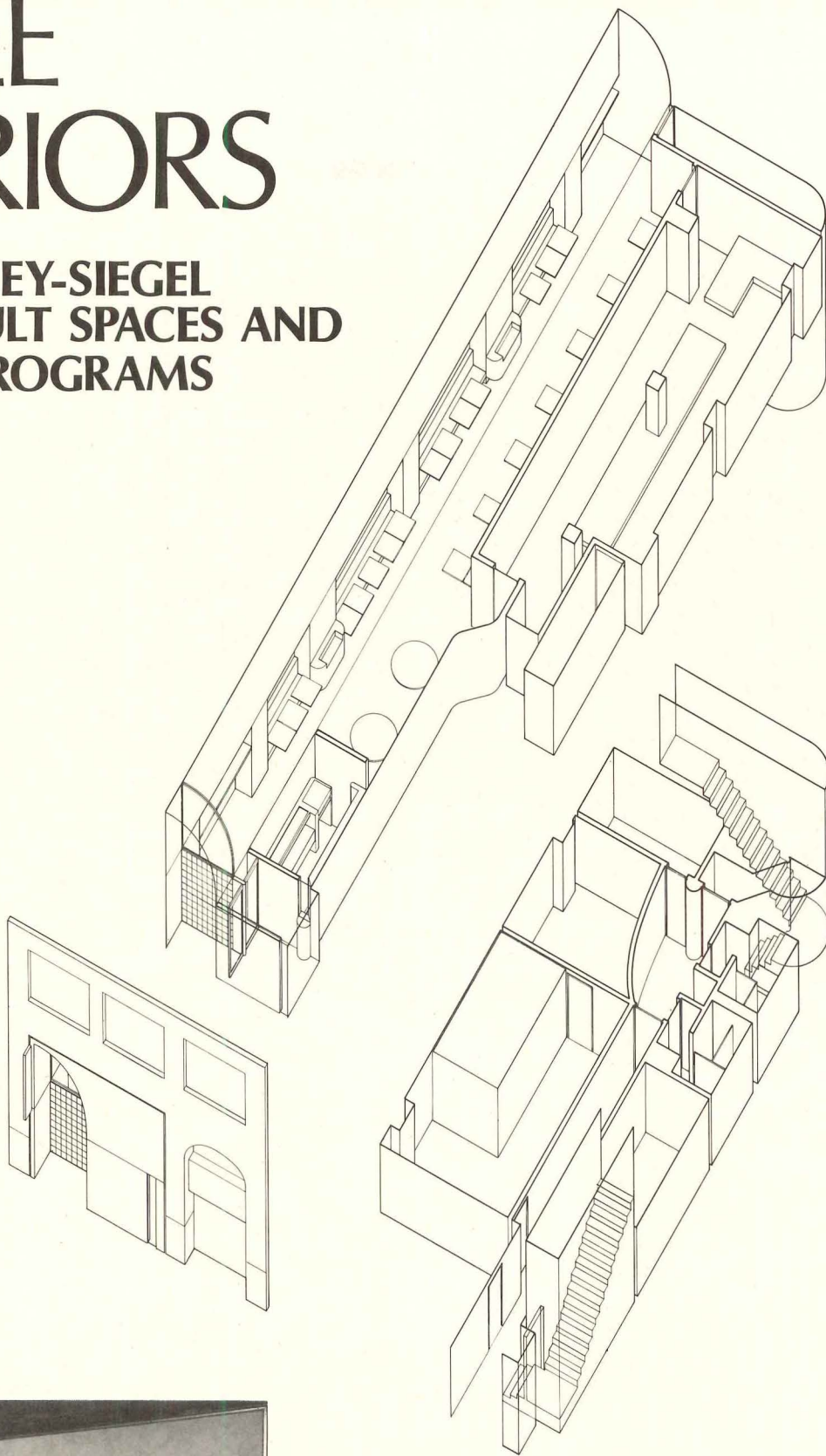

Like many other firms across the country, Gwathmey-Siegel finds an increasing percentage of its new commissions in the areas of renovation and interior design. The three shown here and on the pages that follow are in many ways typical of their recent work. Among the givens in each case was an awkwardly shaped space and a rather specific program to be accommodated in that space. Although the three projects are quite different in function, they have a similarity of scale and commonalities in architectural treatment that mark them as the work of a single firm—a firm that leaves the distinctive print of quality on all the work it does.



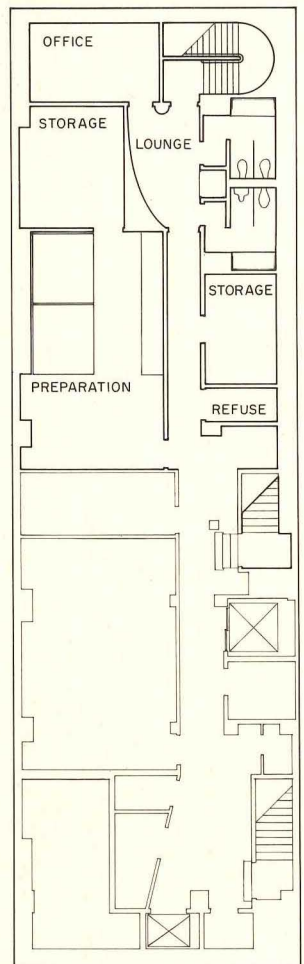

CELLAR LEVEL

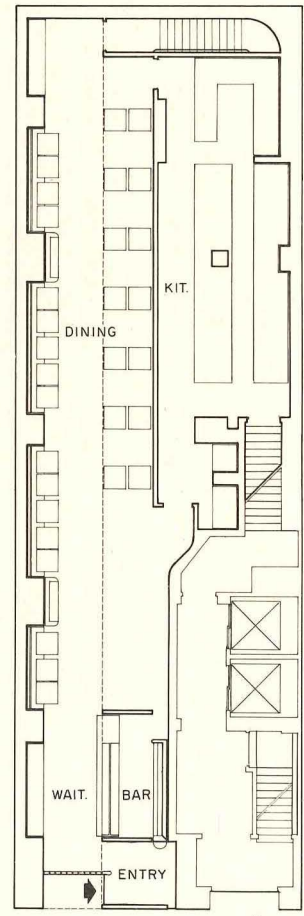

ENTRY LEVEL

PEARL'S RESTAURANT: BY CAREFUL RESHAPING, SOME OF IT MORE APPARENT THAN REAL, THE VIRTUES OF LINEAR SPACE ARE SKILLFULLY EXPLOITED





Gwathmey-Siegel was retained by the owner of a well-known restaurant in midtown Manhattan, forced to move to a nearby, new location. The new space is a 14-foot-wide by 100-foot-long volume at street level. To interact these inhospitable proportions, the architects developed a half-vaulted section that is reflected in the mirrors over the chandeliers, appears to complete the space along the entire length of the dining area (see photos). The front elevation reflects

the section with surprising accuracy and, in so doing, gives the suggestion that the entire volume was slipped into place.

The kitchen, unexpectedly, runs parallel to the dining area and is linked by a stair to food storage areas in the cellar. A small office, for the owner, is also located downstairs.

The character of the finished interior is elegant, but there is no design overreach. Though the cuisine is Chinese, there is a notable absence of ethnic or thematic

decor. The carpet is dark brown, the bar and cabinet work are white oak, the bentwood chairs are cane and white. A combination of wall-mounted and recessed lighting provides enrichment and visual accent without disturbing the restaurant's pleasant, low-key aura.

PEARL's, New York City. Architects Gwathmey-Siegel—John Chimera, job captain. Engineers: Geiger Berger Associates (structural), Thomas Polise (mechanical). Contractor: All Building Construction Corporation.



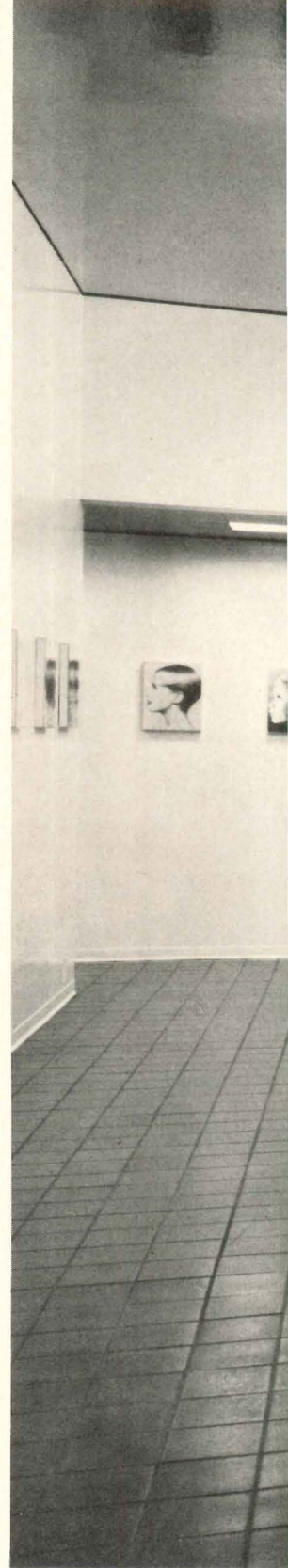

**VIDAL SASSOON:  
TRANSPARENCY AND  
GLOWING HIGHLIGHTS  
IN AN ELEGANT SPACE  
FOR GROOMING**

Located in a shopping mall facing an enclosed pedestrian street, this men's and women's hair cutting salon announces its presence by means of bold signage and a rear-screen projection system visible from the street. Customers are divided at the reception area by gender, then follow two separate but orderly routes through washing, cutting and drying (see plan). The women's areas, larger because of the preponderance of female customers, are broken down into several smaller volumes to

make the spaces more intimate. The areas where the ceiling has been dropped are finished in metal pan. The high-ceilinged areas are covered in mylar and, in combination with mirrors and accent lighting, give these spaces a glowing, reflective character.

Working more or less within Vidal Sassoon's standards, the architects selected other finishes that are durable and easy to maintain: dark brown quarry-tile for floors, plywood cabinets covered in plastic laminate. Colors

throughout are rather subdued, a conscious effort to let the materials rather than their colors express the character of the space. Detailing is elegant.

The ambience is dressy and tinged with a glamour that seems not inappropriate in a place where style is a large part of what it's all about.

VIDAL SASSOON, Costa Mesa, California. Architects: *Gwathmey-Siegel-Tsun Kin Tam*, job-captain. Mechanical engineer: *Thomas Polise*. Contractor: *Illig Construction Company*.





Marvin Rand photos

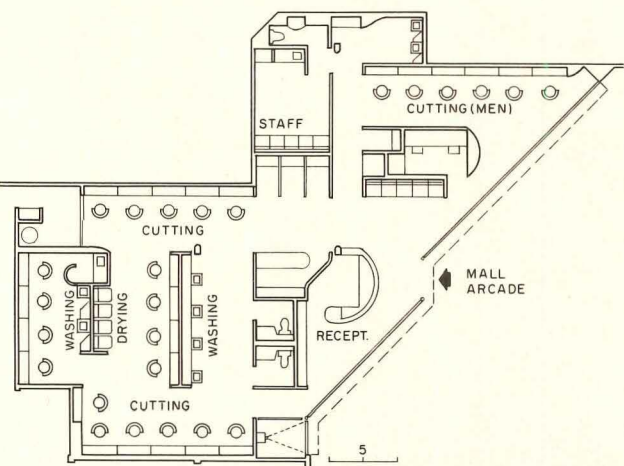



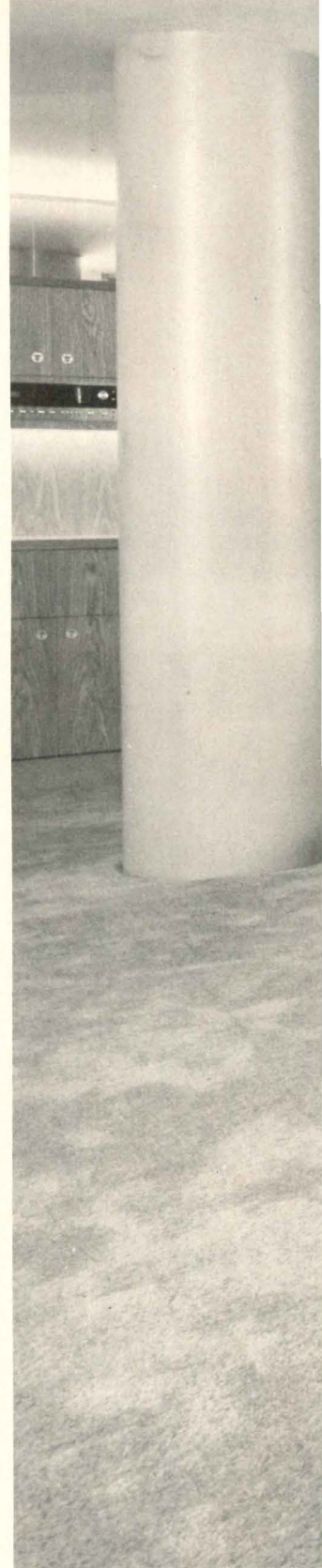
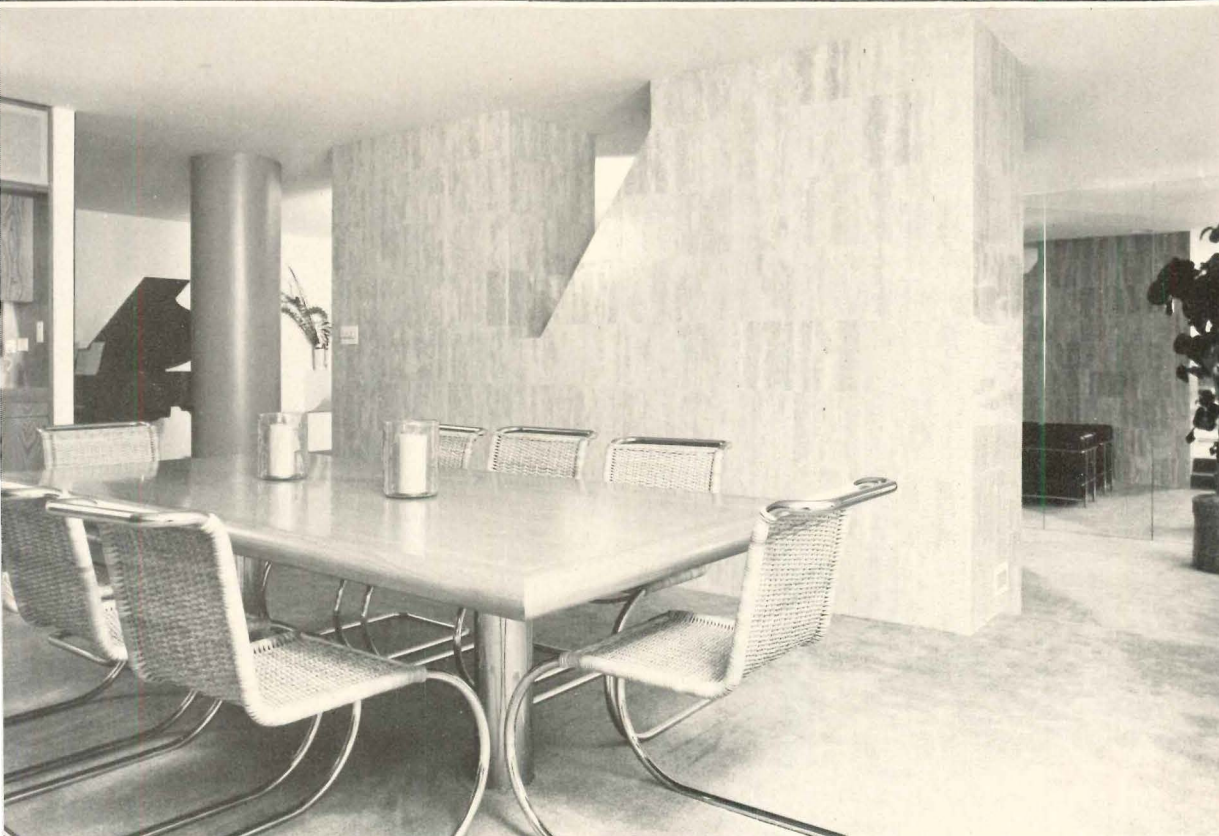
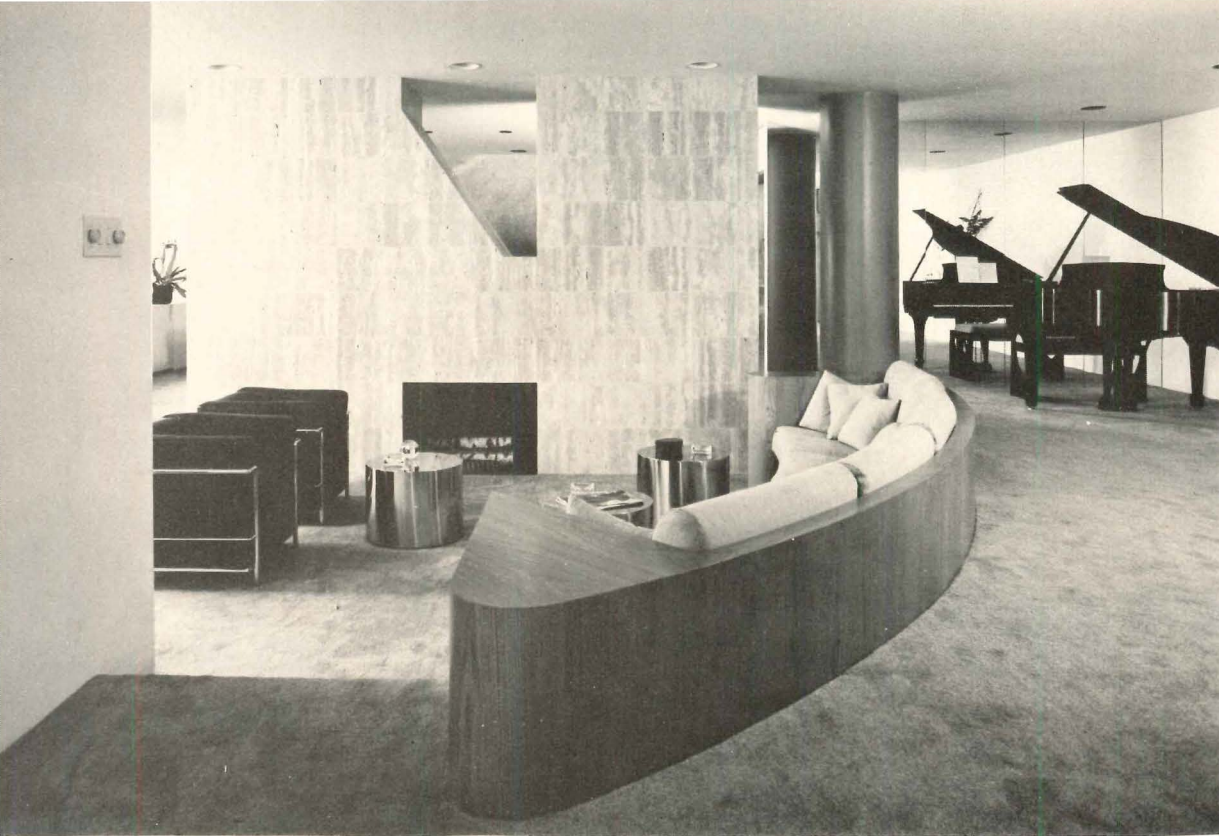

## UNGER APARTMENT: NEW VOLUMES, NEW FINISHES, NEW LIFESTYLE

In this apartment renovation for designer Kay Unger, the architect had three givens: a stepped down living room, a northern exposure and a regular grid of columns. Within these constraints, they were free to plan a series of interconnected spaces that pivot around cabinets, columns and a travertine-clad fireplace wall. The two-riser change of level and the sweeping arc of the sofa back define the living room but only part of the larger entrance and gallery space. The private zones, i





Tom Yee photos

...ding a den that doubles as a  
 ...restroom, are grouped at the  
 ...partment's west end. The existing  
 ...kitchen, next to a small studio,  
 ...is not renovated at the request  
 ...of the owner.

The extensive cabinet work  
 ...most all of it designed by the ar-  
 ...chitects, is finished in white oak  
 ...and detailed with exquisite care.  
 ...The walls are covered in white  
 ...ply and the carpet is a soft gray-  
 ...brown. The selective use of floor-  
 ...ceiling mirrors on one wall of  
 ...the living room is echoed in the

choice of polished metal window  
 blinds that, by reflection, turn the  
 apartment inward on itself at night.

The 6-foot by 6-foot painting of  
 an Old Law tenement, by Hugh  
 Kepets, a curious and ironic con-  
 trast to its surroundings, is a very  
 strong graphic element facing the  
 entrance.

-----  
 UNGER APARTMENT, New York City.  
 Architects: *Gwathmey-Siegel—Peter  
 Szilagyi, job captain.* Contractor: *All  
 Building Construction Corporation.*

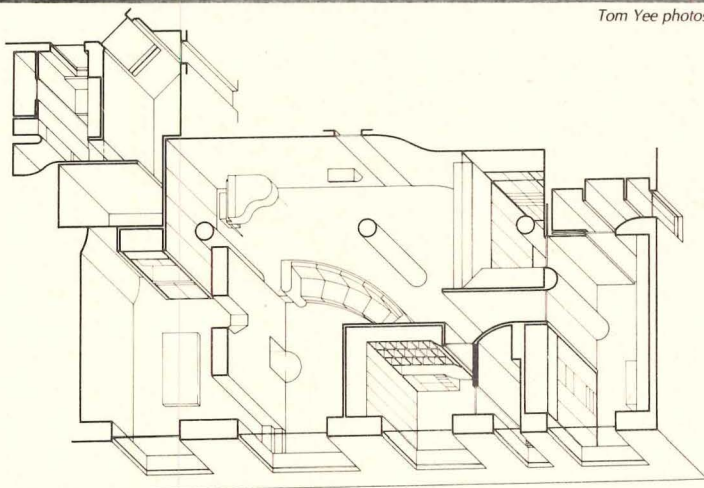



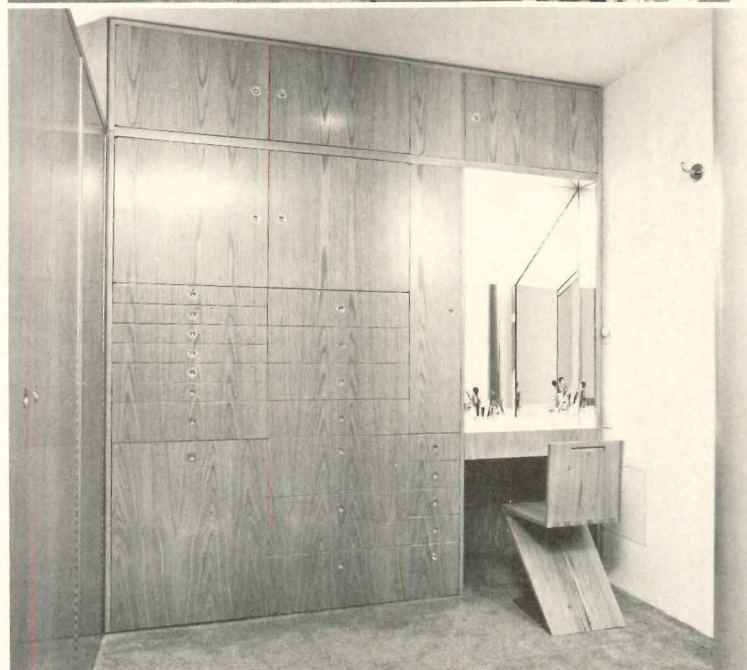

In the apartment's rather extensive private areas, skillfully designed and detailed cabinetwork is an integral part of the solution. Also important is the lighting, which is carefully balanced and flexible. Throughout the apartment, mirrors are used to expand the spaces in subtle—and sometimes surprising—ways.

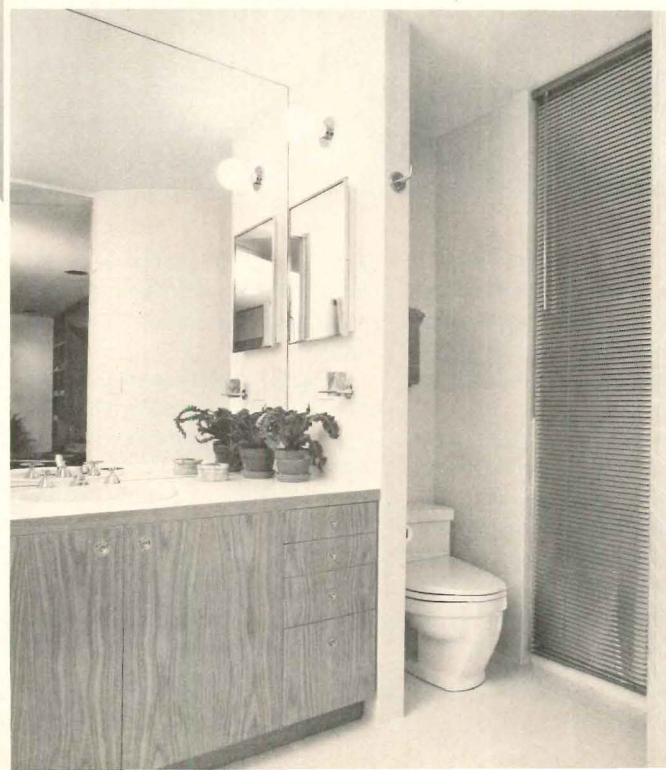



# STANLEY TIGERMAN ON BEING JUST A LITTLE LESS SERIOUS..

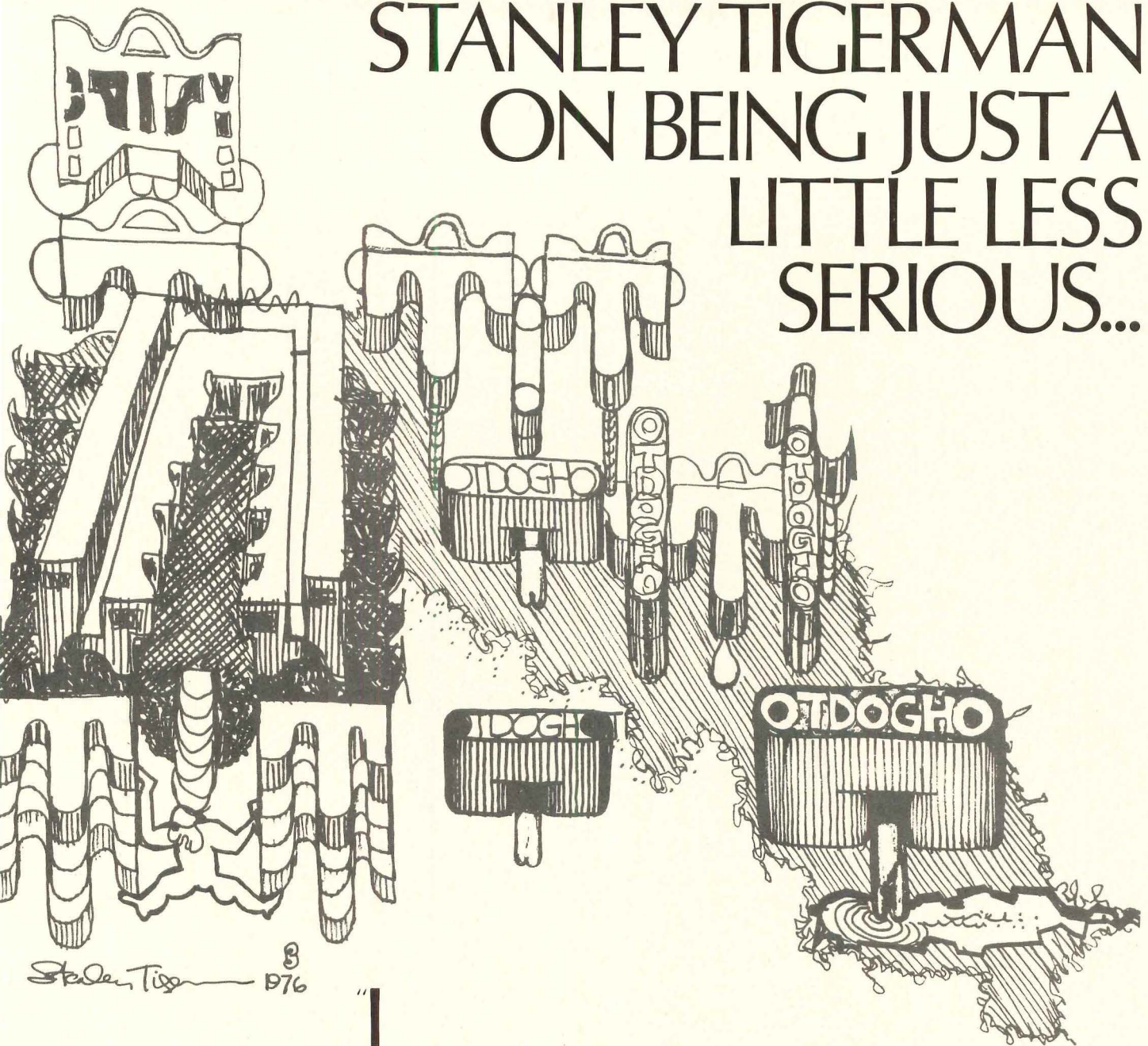

I think we take architecture seriously—at least I hope we do. But too many people have become too serious; they've become believers in some one right way. Except there is none," argues Stanley Tigerman.

Tigerman, who has done a lot of serious and important building in and around Chicago (and also around the world), has always been an explorer and an articulate exponent of alternatives. He now has an eight-man ("including the receptionist") staff all under 30 ("except for me") and is being "a little less serious. We're doing a lot of funny and wry and satirical things—work that makes people feel good and that makes us feel good.

"Architecture is pluralistic today. There are people doing boxes, people who express structure, advocacy people who do totally user-oriented design, formalists, guys who look to another time in a reminiscing way, even people who look only to themselves—self-eclectics. All of these things are possible and should be.

"We're doing something else—political, social, humorous, sardonic, of course relating to Venturi and that stuff. I think that's reasonable too. I don't think architecture needs to be cleansed anymore."

Tigerman's recent "not too serious" work—as the drawings on the pages that follow show clearly—is exploring curved shapes. It began with his studies for a library for the blind (page 116), where all of the curved shapes "have a reason." In some of the other work, the reason may be harder to rationalize, though Tigerman *has* a reason—even if its is to be purposely irrational. And if you cannot accept his reasons why, it is nonetheless difficult to answer his "why not?"

—W.W.



The important use of curved shapes in this house is to make it as abstract as possible—although in fact it is a simple, 14- by 70-foot winterized weekend and vacation house on the prairie in northwestern Illinois built within a \$35,000 budget.

The important design idea is that the house is not four-sided, but two-sided—an idea established by the rounded ends divided by a louvered vertical strip on the centerline. And beyond that, the house is intended to be a series of oppositions or inversions. On the side facing the road (bottom in drawing, upper photo) the house is totally opaque and solid, with even the front door let in with curved shapes. Tigerman sees this side of the house as a performer on a stage, or as a proscenium, with an audience of apple trees to be planted 30 feet on center. The approach is deliberately not on axis—one is intended to see the house, then have it hidden behind the trees, enter the drive, “lose focus,” and then unexpectedly come upon the house with no opportunity to study it or even know how big it is. Even its cedar wall is “an opposition” to the natural trees planted in a geometric (unnatural) way.

Once you enter the house and move to the living spaces, you are immediately “thrust out of it”—with glass walls in an (unnatural) Mondrian pattern overlooking a section of the site that slopes down to a swimming pond and huge old trees beyond.

Functionally, the glass wall reflects the simple plan behind: The tall window lights the stair well, the small window adjacent is over the tub, the larger windows open to bedrooms on the upper level, dining and living spaces below. Guests sleep on curved built-in couches on the main level.

The Hot Dog House (as it is inevitably known) has 1,600 square feet of living space, for a cost of \$22 per square foot.

PRIVATE RESIDENCE, northwestern Illinois. Architects: Stanley Tigerman & Associates. Contractor: Donald Zimmerman.

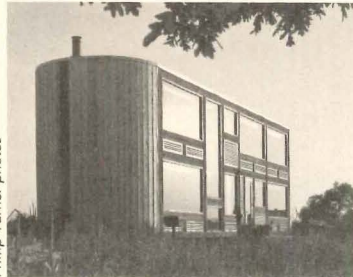
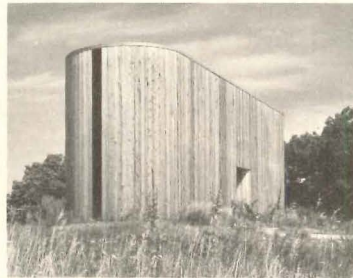

Philip Turner photos

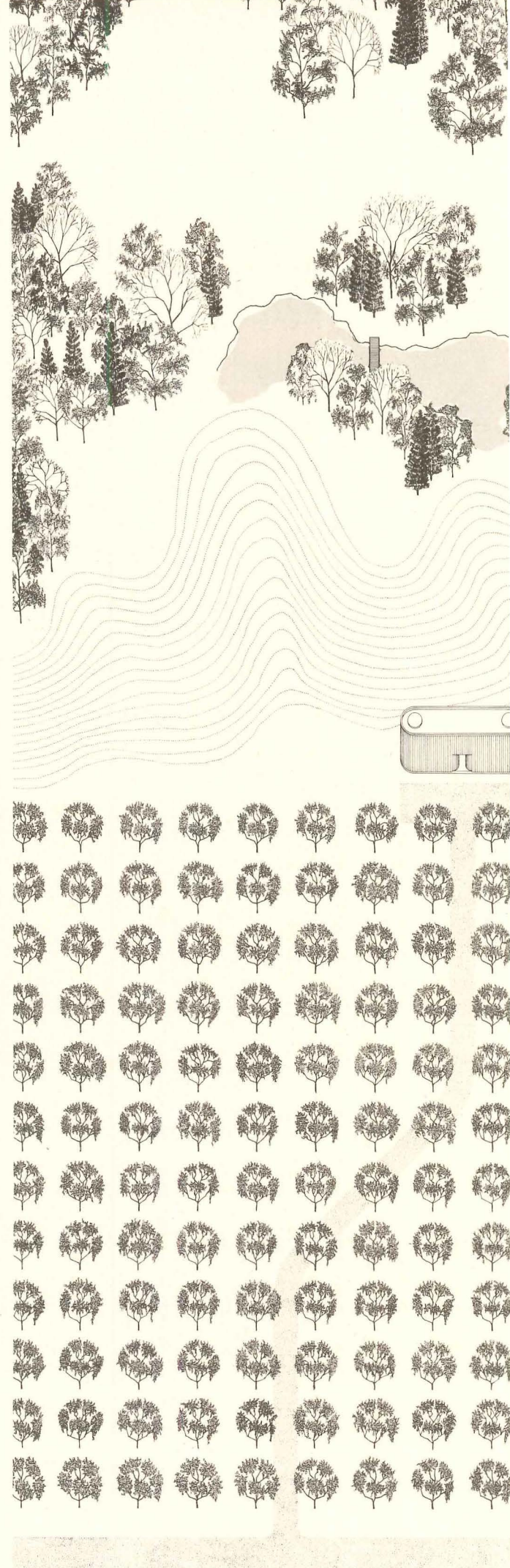
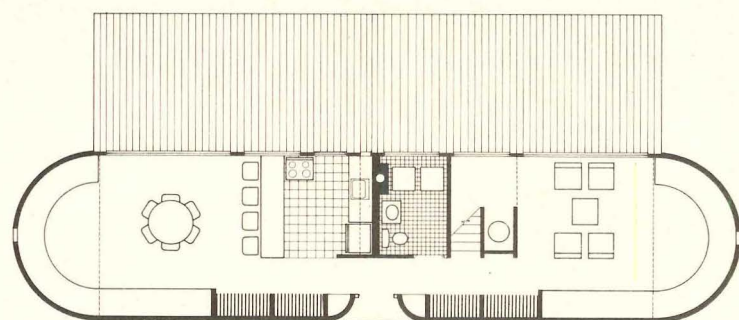
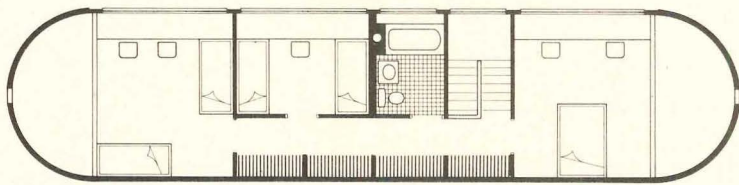



Built on a high dune overlooking Lake Michigan, this house in Indiana is a direct offshoot and elaboration of The Hot Dog House—the owner of this house loved it and came to Tigerman.

For all of its varied symbols, from Spanish mission to male/female, the house is extremely functional and practical. The owners wanted extreme informality and got it—the front door, after a long climb up the steps of the dune, opens directly to the kitchen and a centrally-placed round kitchen table. Down a few steps—so the kitchen equipment and clutter is hidden—is the living room, which opens through large (and fancifully shaped) glass areas to a main living deck and the magnificent view down the dune to the Lake. Directly off this main space, but reached by opaque and serpentine passageways lit by curved neon tubes (“why not be unexpected, full of surprises?”), are the master bedroom and, on the opposite side, bedrooms for the family’s two daughters. Stairs on both sides of the living room lead down to unprogrammed, on-grade spaces—one for the parents and one for the children—and both with decks separated for privacy by the sand dune that reaches up to the edge of the upper level deck.

The house is finished inside and out in cedar—except for the north-view wall (top elevation) which is—again—in total opposi-

tion to the rest of the house. It is white—finished in stucco both sides. While the rest of the house is windowless, this wall opens every room in the house, except the kitchen, to the magnificent view. The curves in elevation are an inversion of the plan curves in the rest of the house. Why the bell? “The owner wanted one. If you like, make it a Spanish mission. Or if you like, make it a way to call the girls in from the beach. All I know,” says Tigerman, “is

that the first time I showed the drawings to the client, he loved it.

“And it made him laugh. The whole thing is—in addition to being functional and workable—to make people laugh and be surprised. Why can’t we sometimes do things in a humorous way?”

PRIVATE RESIDENCE IN INDIANA. Architects: Stanley Tigerman & Associates—Stanley Tigerman, design; Anthony Saifuku, associate-in-charge; Dan Sutherland, assistant. Engineers: Henry Hawry (structural); Ted Skrzenta & Associates (mechanical).

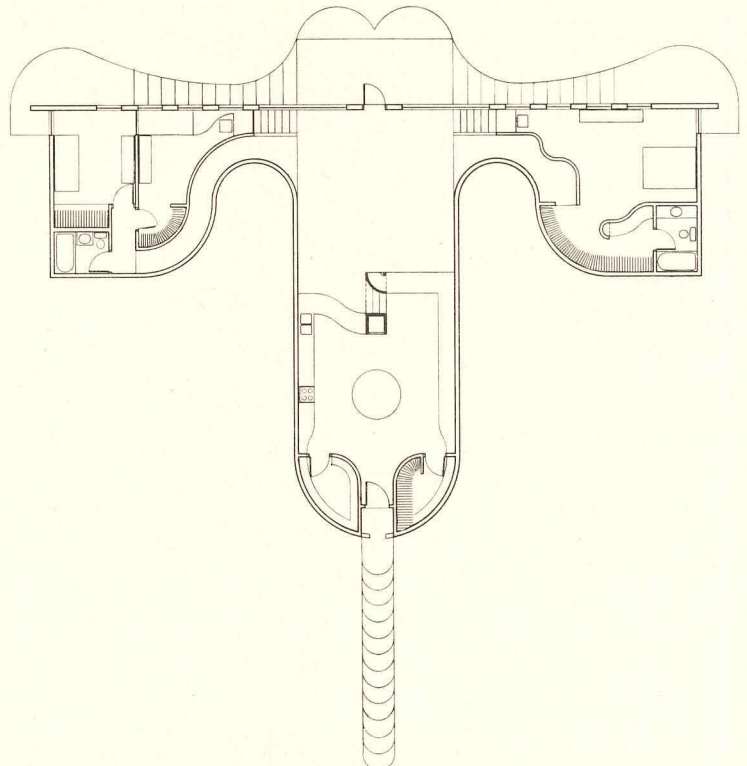
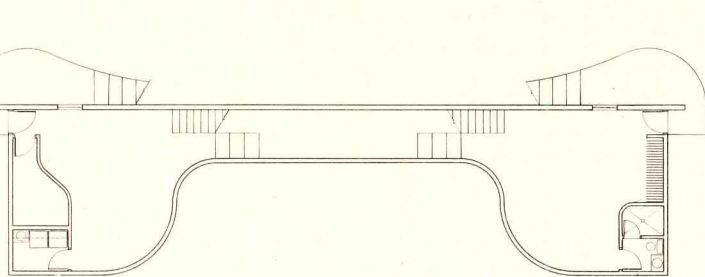
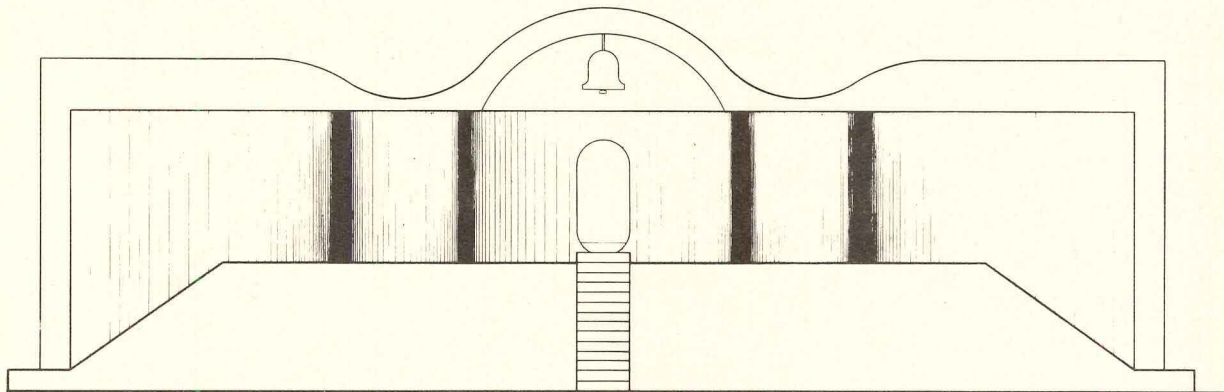
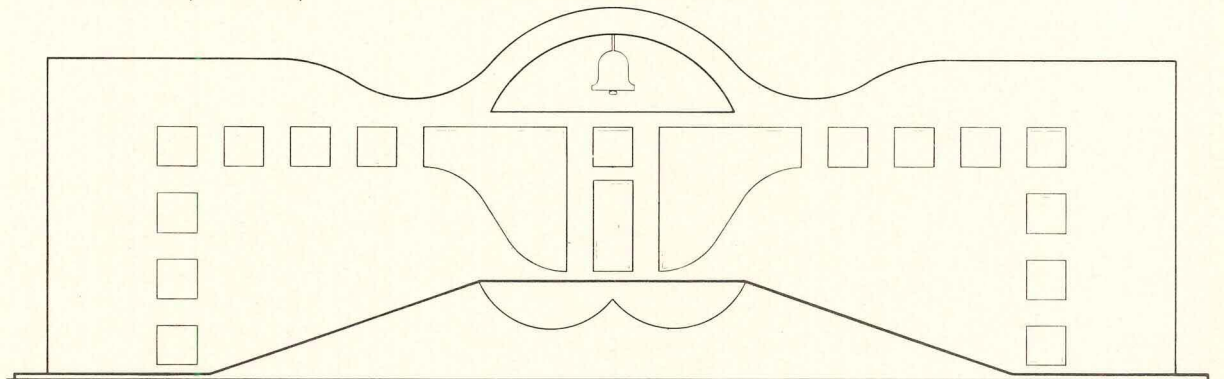
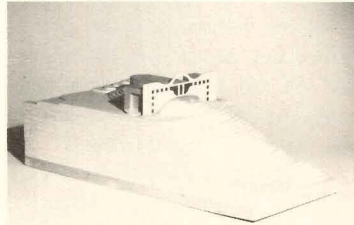
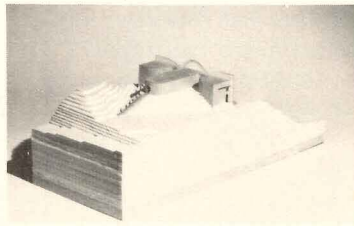

tion to the rest of the house. It is white—finished in stucco both sides. While the rest of the house is windowless, this wall opens every room in the house, except the kitchen, to the magnificent view. The curves in elevation are an inversion of the plan curves in the rest of the house. Why the bell? “The owner wanted one. If you like, make it a Spanish mission. Or if you like, make it a way to call the girls in from the beach. All I know,” says Tigerman, “is



St. John's is the center of the Catholic community at the University of Illinois, Champaign-Urbana. Both the 800-seat chapel and the L-shaped Newman Foundation dormitory that wraps around it were crowded for space; and Tigerman created the needed space and a whole new circulation and organization for services and other church functions with an extraordinary "cloud room" in the U shaped by the two existing buildings.

The design scheme involves removing the stained-glass windows on the "inner" side of the chapel, creating a series of seven openings to a new, six-foot-wide cloister at the level of the chapel floor. This area is skylighted, incorporating part of the stained glass. Beyond that space is the "cloud room"—a large, essentially open space under a concrete roof that sweeps down in waves from a high point near the chapel to a low point at the wall of the dormitory. The functional explanation is simple, for the roof not only helps create a dramatic shape inside soaring upwards towards the great space of the church; it drops low enough on the Newman Hall side to avoid blocking the lowest level of dormitory windows.

This strong curve in elevation is echoed in the plan in several ways: Just outside the church and cloister, and at that level (four and a half feet above the floor of the "cloud room") are a series of con-

fessionals and sacristies, floating in space under the "clouds"—for the concrete roof is to be blue with *trompe l'oeil* clouds.

Echoing these shapes (and best seen at the left of the new room in the plan top right), are a series of "banquette spaces" carved out of the floor of the cloud room. They are at the basement level of the church, where the priests maintain offices, a conference room, and classrooms.

The new room also creates a new circulation for the church, which is especially useful in winter. Worshipers now enter through a new entrance into the cloud room—move up to the church by processional stairways at both the narthex and altar. There are also short stairways down to the basement offices and to the lowest level of the dormitory.

This project is awaiting funding for construction.

ST. JOHN'S, UNIVERSITY OF ILLINOIS, Champaign-Urbana. Client: *The Newman Foundation*. Architects: *Stanley Tigerman & Associates—Stanley Tigerman, design; Timothy Sullivan, associate-in-charge; Wesley Goforth and Dan Sutherland, assistants*. Engineers: *Ray Beebe* (structural); *Ted Skrzenta & Associates* (mechanical). Estimating consultants: *Hanscomb Associates, Inc.*

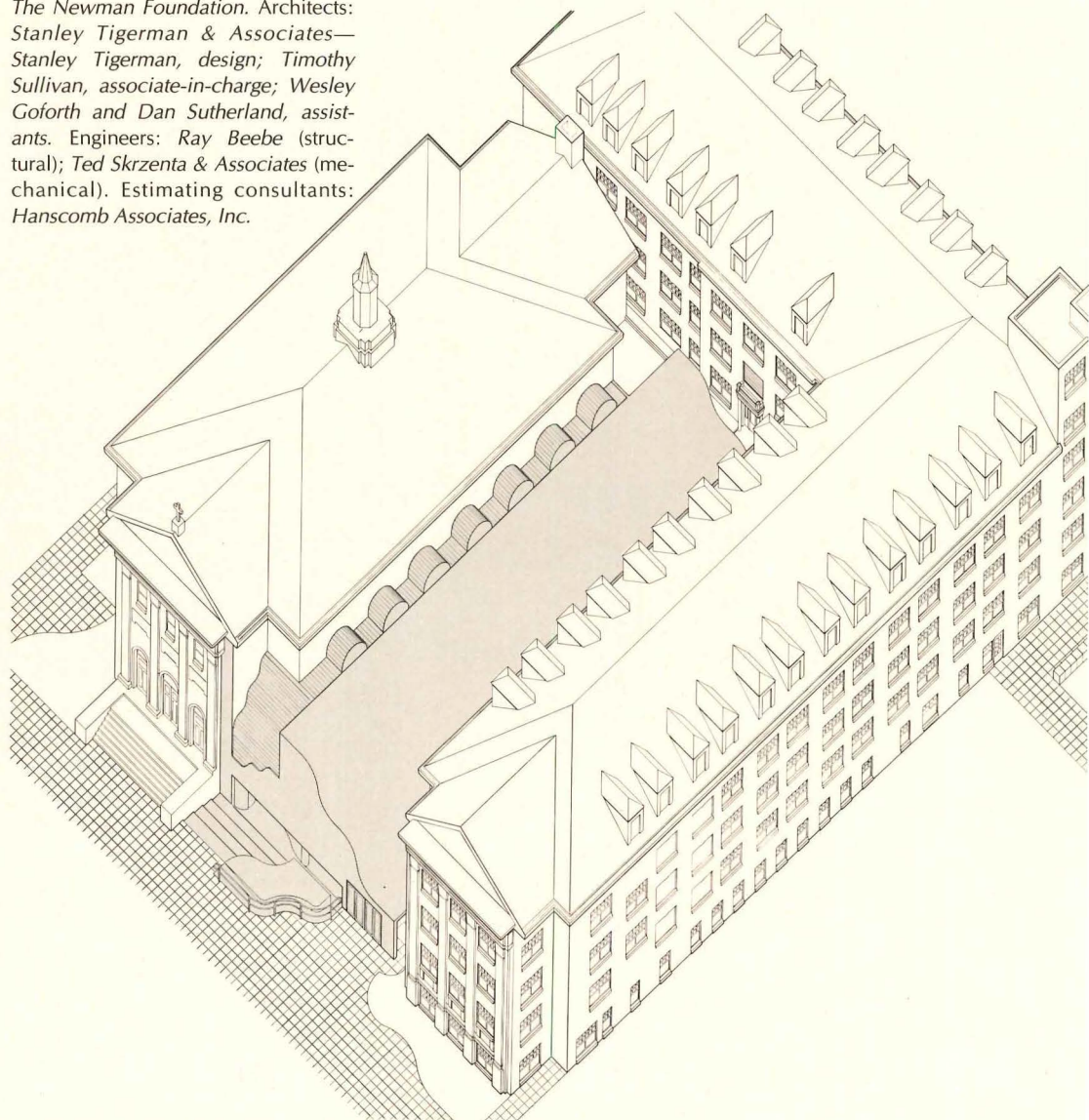
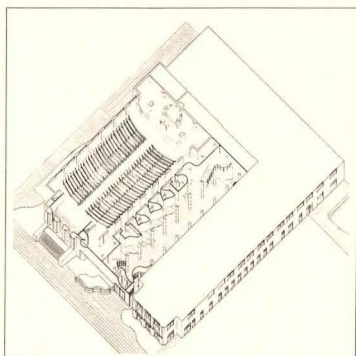
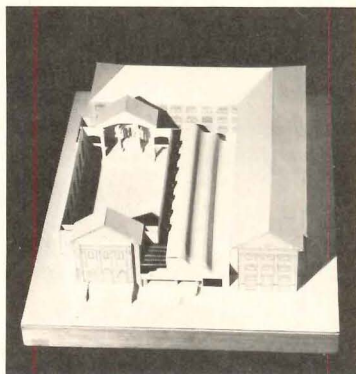
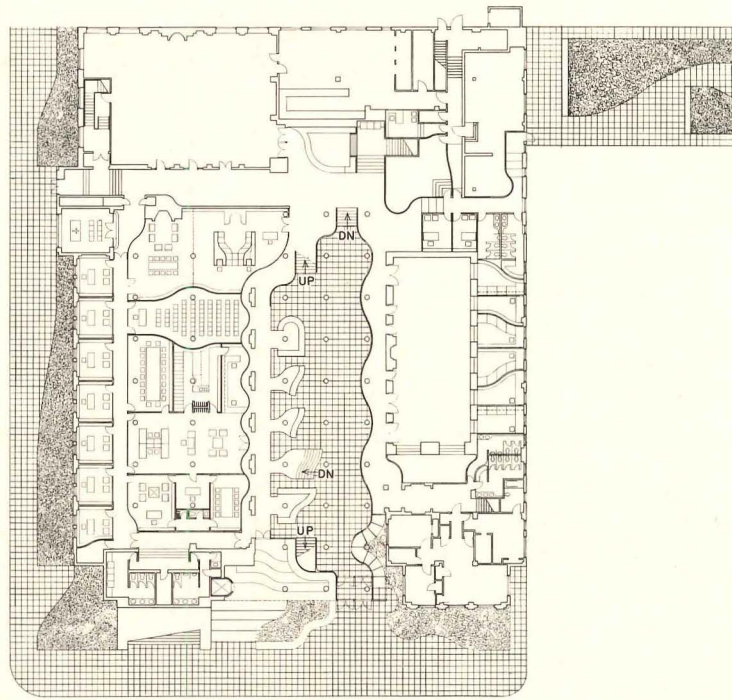



Three narrow stores on a block in Chicago's West Side are being transformed by volunteer labor into The Ukrainian Institute of Modern Art. The building is intended as a meeting place for the community, a museum ("with an extraordinarily good art"), a gallery, and a working studio for painters and sculptors.

With the dividing walls removed, the three stores combine to form an area 50 feet wide, with three columns which—fireproofed and covered—will serve "as modulators of the space," dividing the main exhibit room (lower end of plan) into varied exhibit and service areas. The main room will be divided (from bottom to top in plan) into all museum "store" just inside the entrance, a reception area and office, a conference room, toilets, and a storage area. To the left of the plan is the main exhibition room, with a free-standing projection booth for motion pictures or slides. At the rear of the site (top in plan), will be a cinder-block studio space with upward acting doors opening onto the alley at the rear. This space will be subdivided as needed. Between the new building and the existing structure will be an open courtyard—parties, for drawing classes, or sculpture garden.

Again, Tigerman's curved ornaments are everywhere. "Mainly," he explains, "they are intended to use and express the columns as modulators of the space." On the front elevation, the wall simply extends back to expose the columns and to begin to express what is happening inside and beyond in the courtyard (where the columns are simply freestanding). In "a reverse kind of preservation," Tigerman left only one narrow strip of the existing terra cotta coping, but altered the three ornaments so that the top half of each bends forward 45 degrees—"so they now project over the street like garbs" in extraordinary contrast to the white stucco wall with its dark and butt-glazed strip windows. The ornaments still serve to

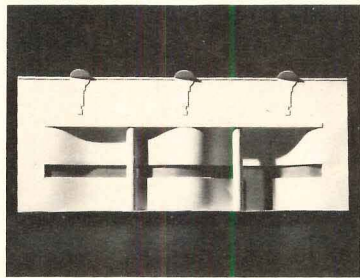

carry the pattern of ornament that extends the length of the block.

All interior walls, and the walls of the courtyard, will be painted white to unify the varied surfaces of block, drywall, and the brick party walls.

This project is now under construction.

UKRAINIAN INSTITUTE OF MODERN ART, Chicago, Illinois. Architects: Stanley Tigerman & Associates—Stanley Tigerman, design; Robert E. Fugman, associate-in-charge.

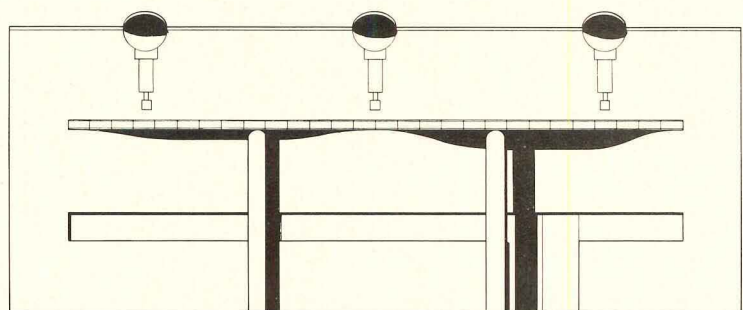
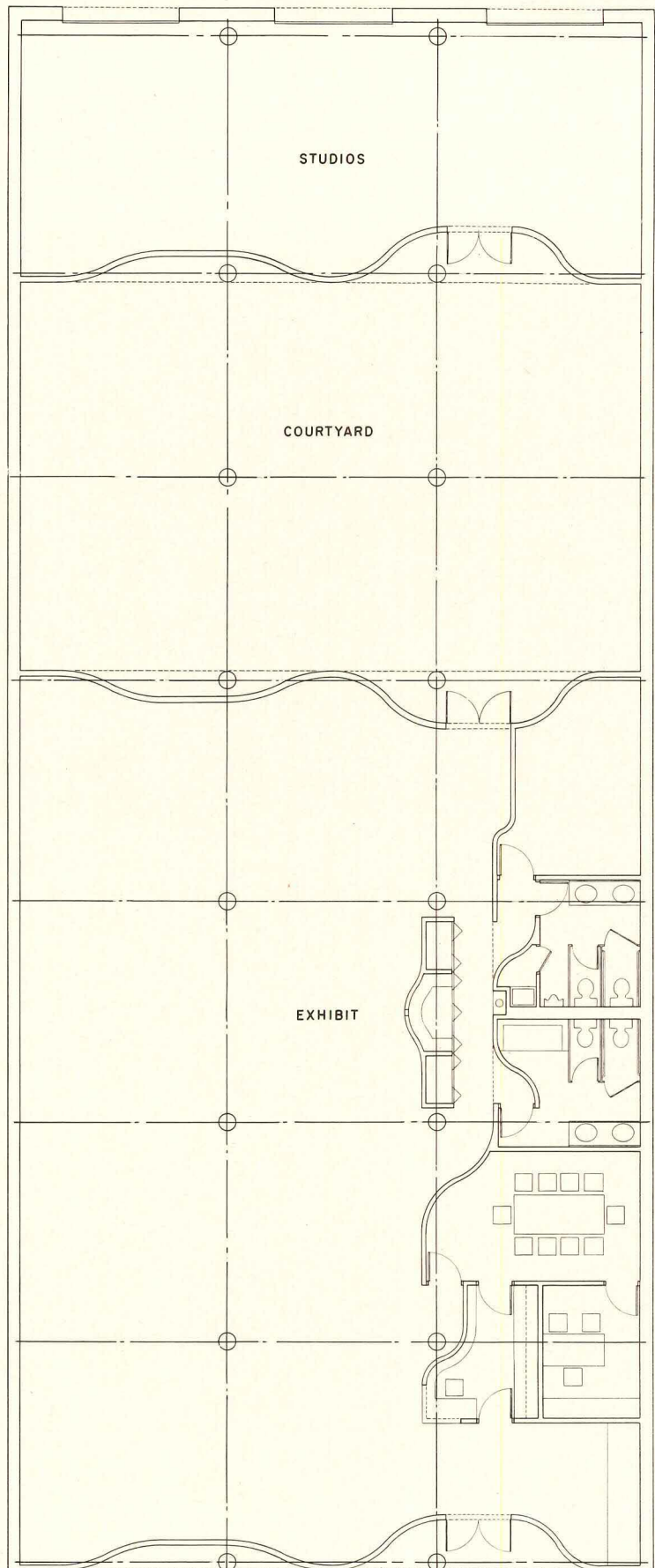



Probably the very best building Tigerman has ever done—and surely the most sensitive—is this Illinois Regional Library for the Blind and Physically Handicapped, now under construction on Chicago's West Side near the Circle Campus of the University of Illinois.

In this building, Tigerman's curved shapes, which in other work might be considered fanciful, are completely functional, everywhere working to assist the blind or wheelchair-bound to use the library on their own with a minimum of assistance from the staff.

And perhaps more completely than in the other work shown in this article, Tigerman has developed his "reversals" or "oppositions and inversions." For example:

- Where the building is tallest—on the hypotenuse and short side of the triangular building—the space is in fact one story inside; a tall "people space." In the center, where it is lower, are layered three low (7½-foot-high) levels of stacks.

- The building is brightly colored inside and out. The metal exterior panels are a Mondrian-red baked finish; all structural members are painted yellow; and all of the mechanical elements, exposed inside and on the rooftop, are blue. Why the color? Tigerman gives three reasons: "Some of the users, while legally blind, are not totally blind—and light and bright colors are the only things they are able to see. It's

whimsical and playful—and it's good for a library to be thought of as 'fun' instead of as 'a serious place for serious learning.' Finally, the building will be used by people with other physical disabilities, by friends and relatives of the blind, and by the community residents. I wanted to design a building that gives everyone who uses it a lift. . . ."

- The final "inversion" is perhaps the most striking: The solid portions of the wall (drawing lower right) are made of lightweight metal panels. Yet it is the one dense wall—the poured concrete wall of the longest side—that is made transparent with an extraordinary window (drawing at right). The window is 165 feet long, butt-glazed without columns or support of any kind—which of course requires the wall above the window to act as a massive beam. "This is irrational," Tigerman would agree. "But so is blindness irrational. . . ."

Significantly, the window is set at such a height that only those in wheelchairs and seated staff members at service desks can really see outside.

The shape of the great window reflects in elevation the beautifully thought-out circulation system just inside the window. Using the curving shapes (easier to "read" than tactile changes in surfaces), the blind visitor will be able to "feel" where he is. The circulation system is also (see caption on facing page for details) entirely linear—"easier for a blind person to remember," says Tigerman, "than any system with free-standing elements. And everything has rounded corners—there are no surprises."

The building is 32,000 square feet, will cost \$1.9 million, and is slated for completion in May 1977.

ILLINOIS REGIONAL LIBRARY FOR THE BLIND AND PHYSICALLY HANDICAPPED, Chicago, Illinois. Architects: Stanley Tigerman and Associates and Jerome R. Butler, Jr., City of Chicago Bureau of Architecture—Stanley Tigerman, design; Robert E. Fugman, associate-in-charge. Engineers: James L. Mitchell, Inc. (structural); Wallace & Migdal, Inc. (mechanical/electrical). Estimating consultants: Hanscomb Associates, Inc. General contractor: Walsh Bros., Inc.

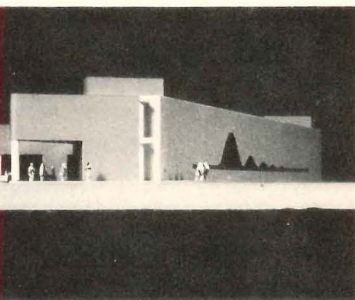
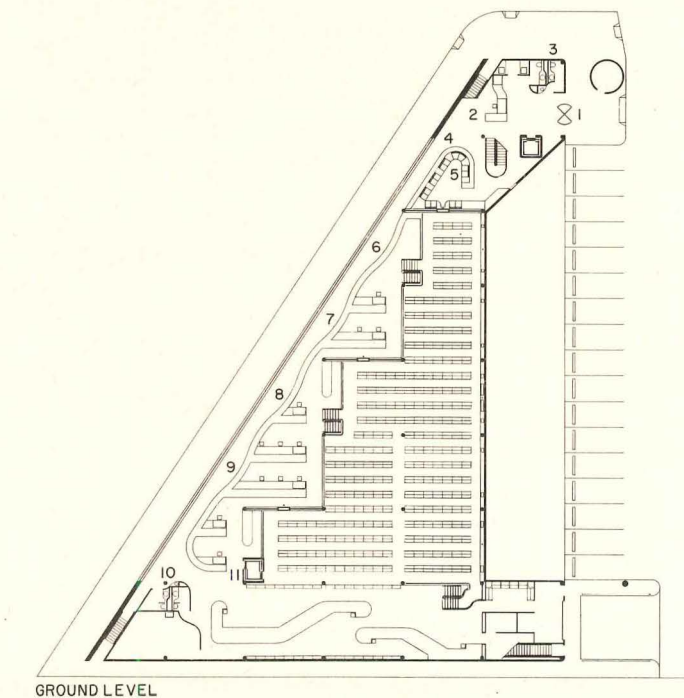
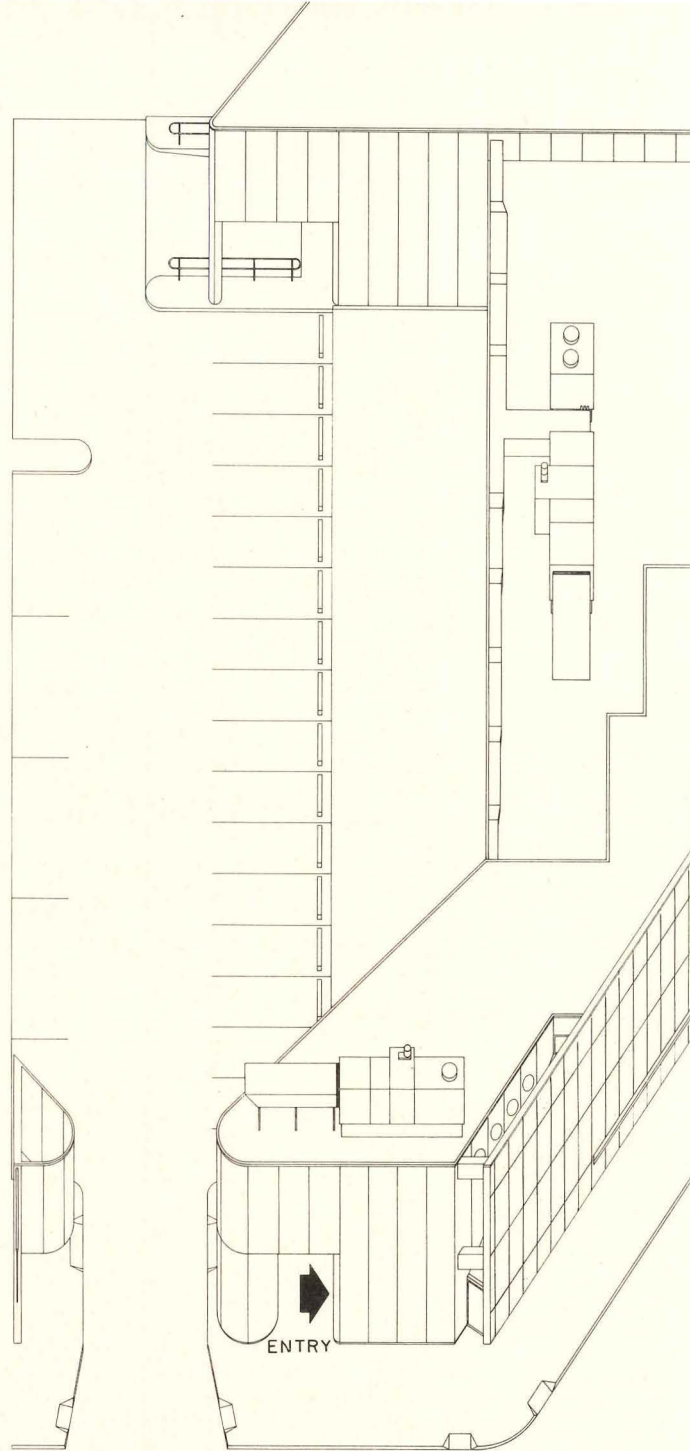



How the circulation works: When a blind visitor enters the building (1 in ground level plan, below left), the reception desk (2) is just a few steps away. There are washrooms immediately adjacent (3). The receptionist guides the visitor to the Braille card catalog—and from that point on he can function on his own. From the card catalog, the visitor can follow the wall back to a banquet area (5) for reading or use of “talking books.” To get a book from the stack area, he follows along the curving counter into the library. The counter is curved not just in plan—at each point that it curves in-

ward, it also dips down, signaling the visitor that there is a circulation desk at that point (6, 7, 8, and 9 in plan and counter detail, upper right). The card catalog tells the visitor that the book he wants is at, for example, “the second dip.” Because the counter curves inward, people lined up for service are out of the main traffic pattern.

Finally, the visitor can continue along the counter to reach toilets (10) or the elevator to the second floor (11). On the upper level (plan left), the visitor is just steps from the librarian’s office (12) or the large community meeting room (13).

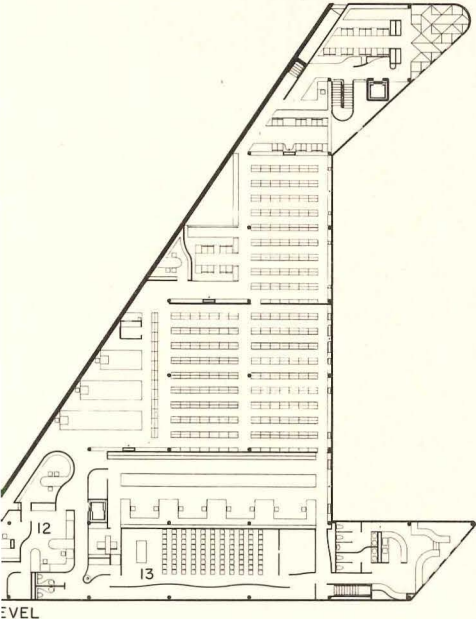
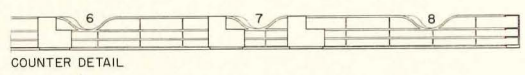
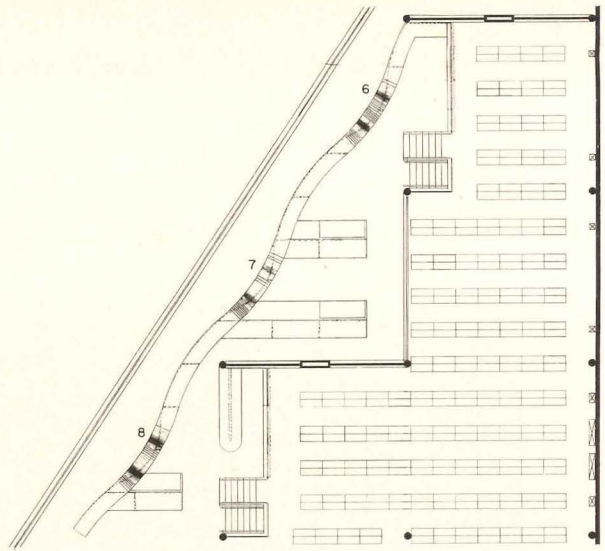

LEVEL

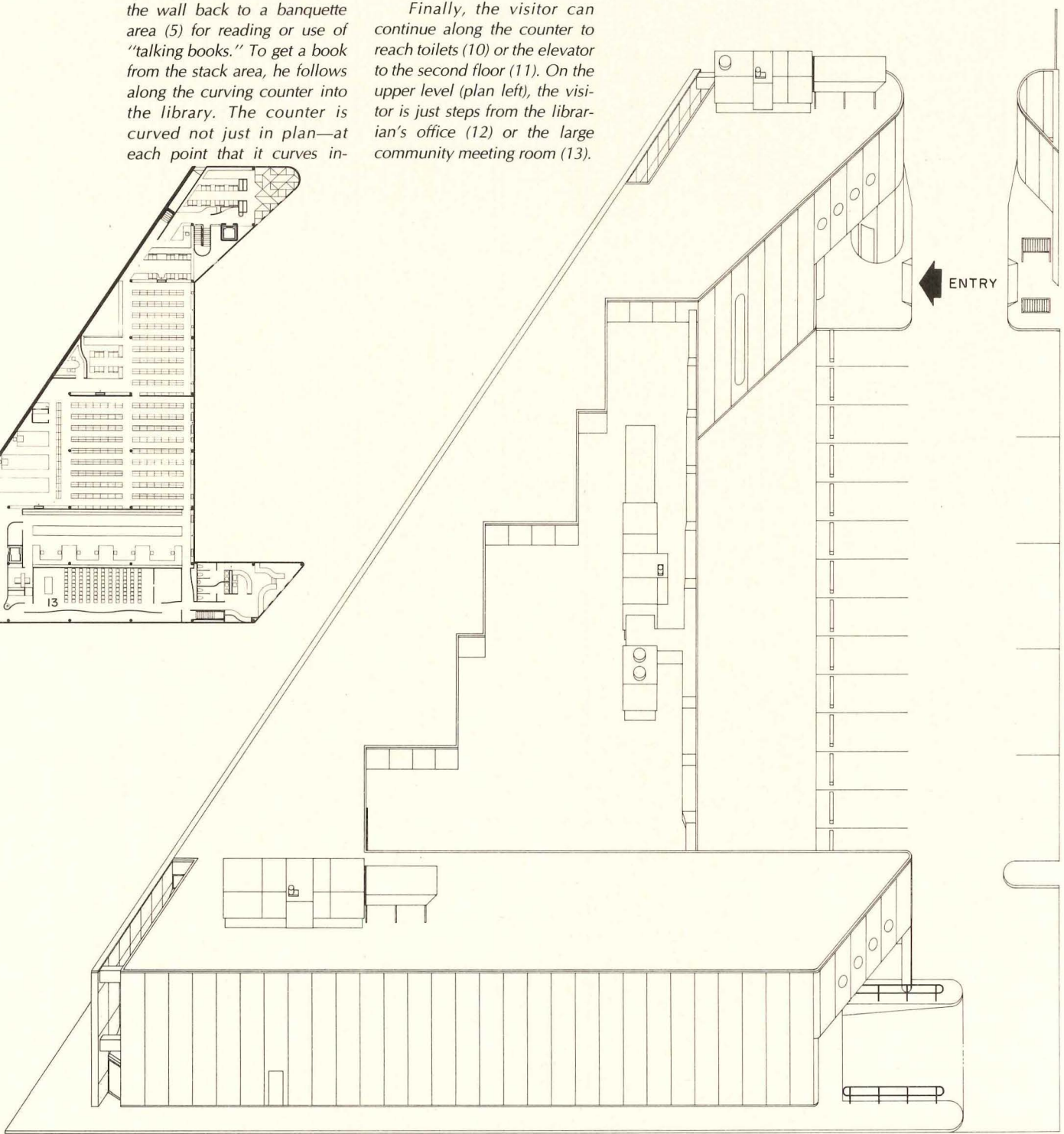



Zipper house is the inevitable "office name" for this group of 12 townhouses to be built in Evanston, Illinois. In an earlier scheme, the "zipper teeth" (best seen in the plan at right) were part of a curving wall with windows that looked down the central courtyard. When this proved too expensive at bid time, the "teeth" were redefined as on-grade planters in the central court, and as terraces off the living rooms screened from each other and the neighborhood by shaped hedges—which are in the budget.

Beyond that, Tigerman's "curved lines" are used on both elevations of what is, in essence, a very simple box. Rather more than a "decorated box," the use of two siding materials divided by the curved line is, in Tigerman's words, "a study in ambiguity." On alternate elevations, 4-inch vertical boards stained gray and 8-inch horizontal shiplap stained brown are reversed, and separated by a trim piece painted magenta. This strong line (which occurs on both front and back elevations, but is best seen in the rear elevation at the bottom of the page) not only scribes the curved line between the two sidings, but reaches up between adjacent units and then turns back around one window—but not both. Thus, in the use of two siding materials and colors, and by "sliding the windows sideways" with the magenta line, the design suggests that parts of one unit belong to the other, a confusion intended to complicate a perfectly straightforward plan. "A study in ambiguity"—and a final example of Tigerman's efforts to be a little irrational, a little humorous, and a little irreverent about "the rules of design." And even if you cannot accept his "reasons why"; it is nonetheless difficult to answer his "why not?"

"ZIPPER" HOUSING, Evanston, Illinois. Architects: Stanley Tigerman & Associates—Stanley Tigerman, design; Robert E. Fugman, associate-in-charge; Wesley Goforth, assistant. Engineers: Henry Hawry (structural); Ted Skrzenta & Associates (mechanical).

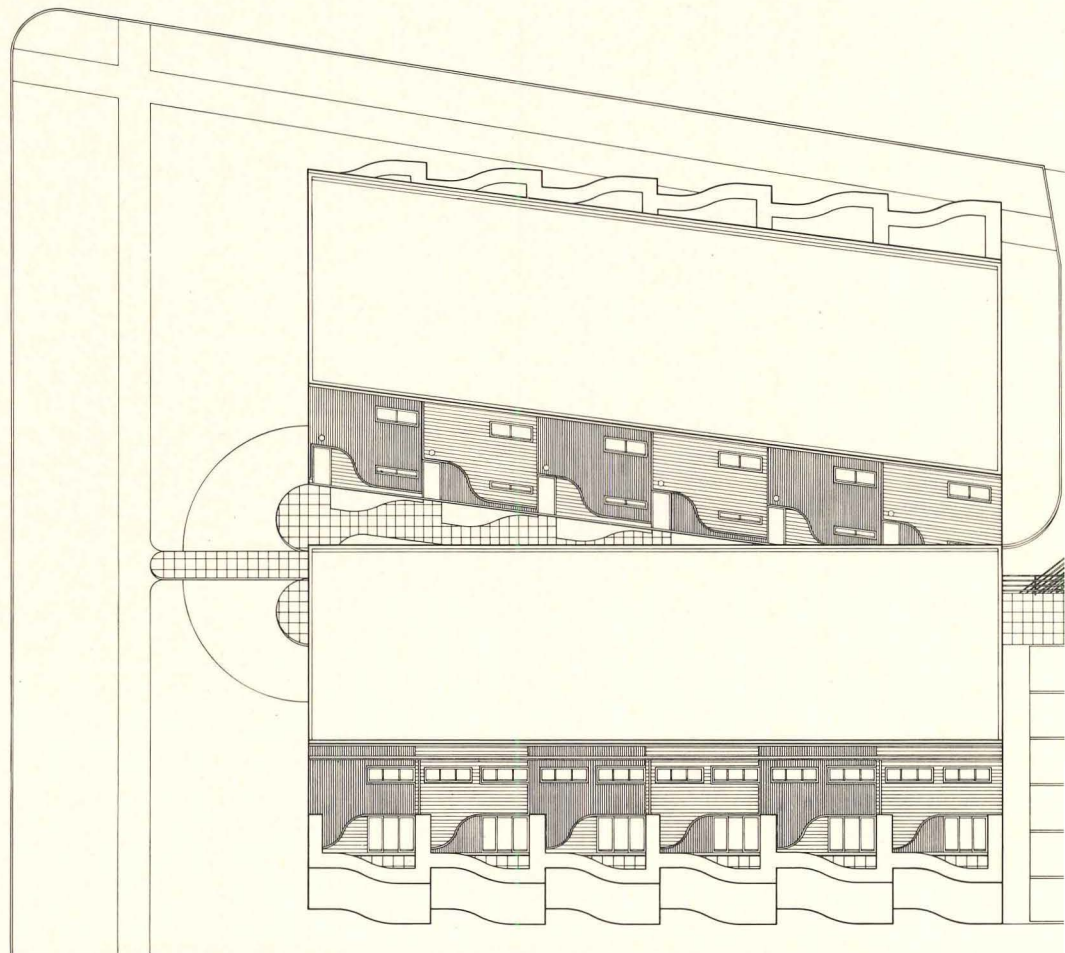
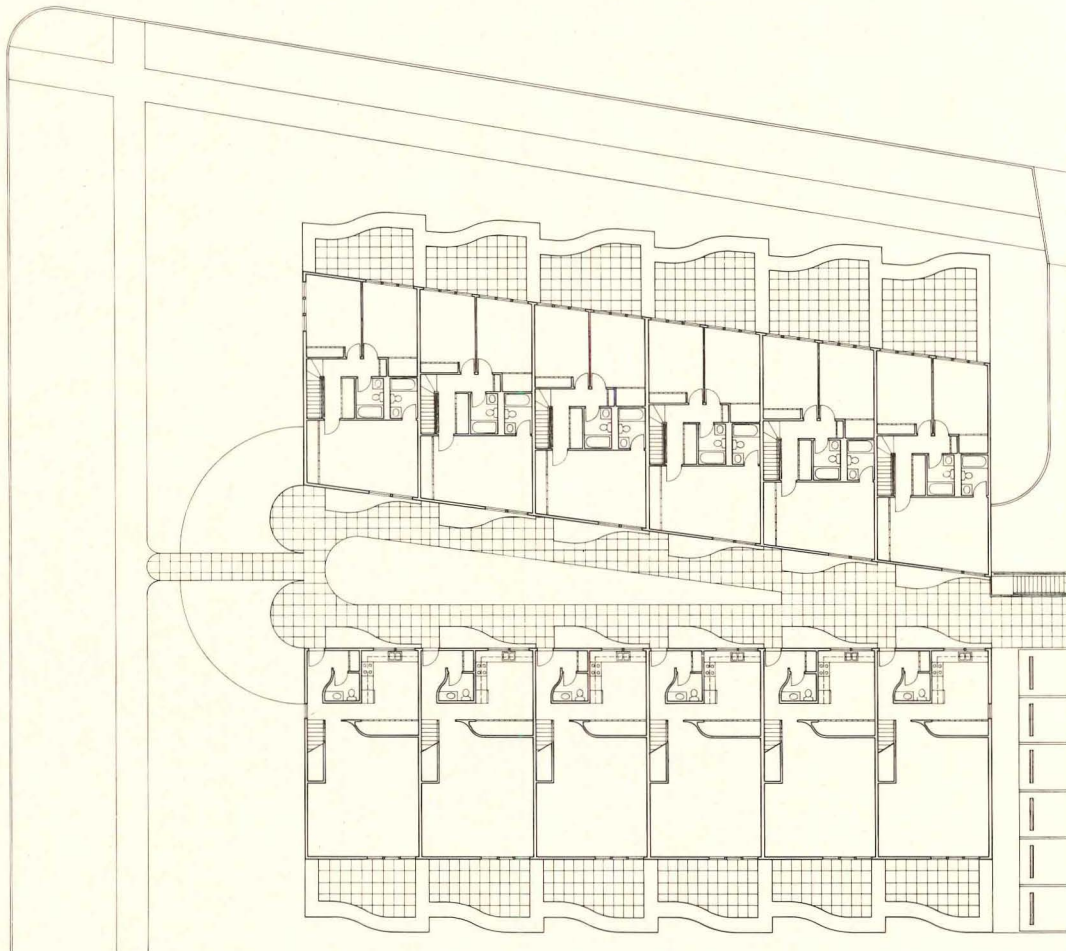
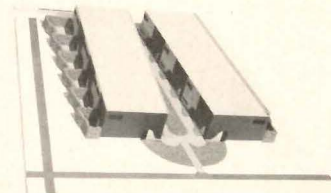





Bank of Suffolk County; Gil Amiaga photo

## EVEN SMALL BANKS CAN EXPRESS A REGIONAL VERNACULAR

Whenever the issue of a regional style in architectural design is raised, it can quickly become the source of controversy both among architects and among clients who may be sensitive to a feared brand of provincialism. Still, the recognition of existing surroundings and localized construction methods coupled with differing regional background influences is going to produce some important and appropriate variation—whether purposely created or not. And it may be surprising to see that one of the largest degrees of regional variation can be found in that most routinely conformist of image-conscious building types, banks.

On the following pages are a group of banks in different parts of the country by local architects who were not afraid—as were not their clients—to express (intuitively or purposely) a strong sense of where they are. The resulting diversity shows an increasingly better and more confident sense of unique location than perhaps at any time since architecture took over local craftsmen's efforts. And it is certainly to be applauded in the face of much of the "sameness" that has gone before. In *RECORD*'s August, 1974 (page 109) issue, it was pointed out that the recent proliferation of smaller banks (mainly branches) is meant to bring business geographically "closer to home." Here it will be illustrated that these businesses are now not only closer to home; they can look like they are closer to home.

—C.K.H.

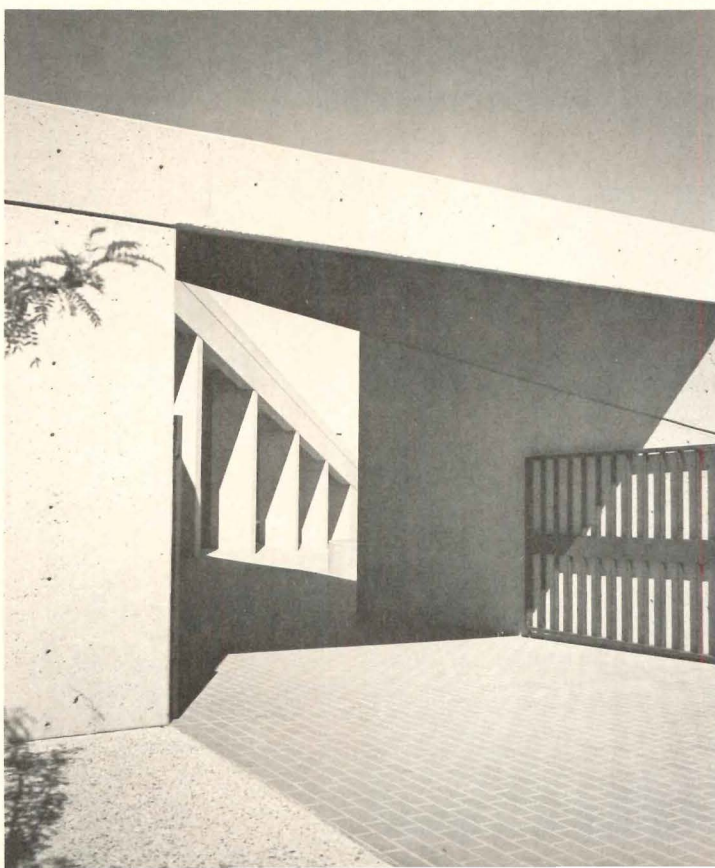

The First National Bank in Albuquerque, Sandia Plaza; Joshua Freiwald photo





## A CASUAL AMBIANCE FOR THE CALIFORNIA "WILDS"

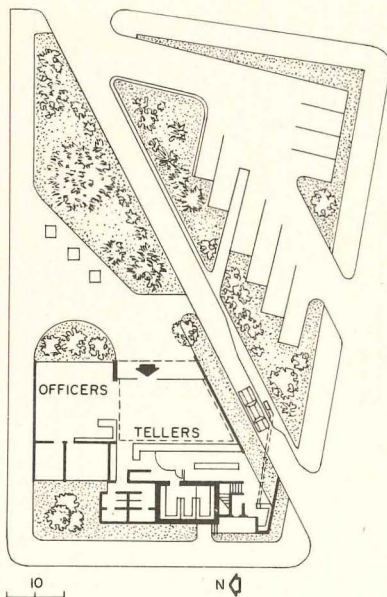

In an immediate area stripped of its natural environment by high-orientated commercial development, the Vallejo branch of the Redwood Bank is an inviting reminder of distant natural forests and informal lifestyle that brought many of the present settlers in the place. Sheathed inside and out by wood from the bank's namesake tree, the fireproofed wood-frame structure nestles low and unimposing within a surrounding grove of redwoods, which are intended to grow as a vertical contrast and as an appealing identification marker. The trees also visually shield the parking area and help to form a park-like plaza for neighborhood use at all hours (photo above). Access to drive-in teller windows also involves experiencing the natural setting by leading cars directly through it.

Within, the 5,700-square-foot building continues an appreciation for the unartificial by primary lighting from the sun through heat-insulated fiber glass ceiling-roof panels and by a consequent profusion of plants. Pipe standards above the panels hold lighting for a night-time effect. The banking facilities can be closed off from the main room to allow its use during non-business hours by the community (dotted line on the plan, left). They include offices on a mezzanine above the tellers. Mechanical equipment and toilets are located rear to the vault. In the photograph at left, the main banking room can be seen with the tellers' counters, rear.

THE REDWOOD BANK, Vallejo, California. Architects: *Smith Barker Hansen*; Engineers: *Forell/Elseesser Engineers, Inc.* (structural); *Norris Nelson* (mechanical); *Tage Hansen* (electrical). General contractor: *Krull & Krull*.





Gil Amiaga photos

## BANE SCULPTURE IN A MECHANISTIC N FOR NEW YORK'S SUBURBS

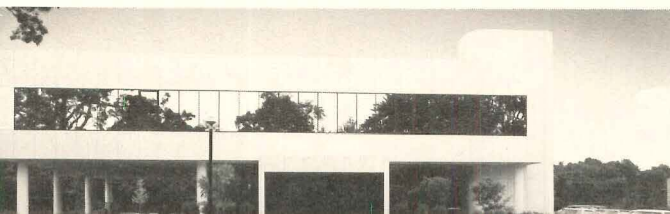
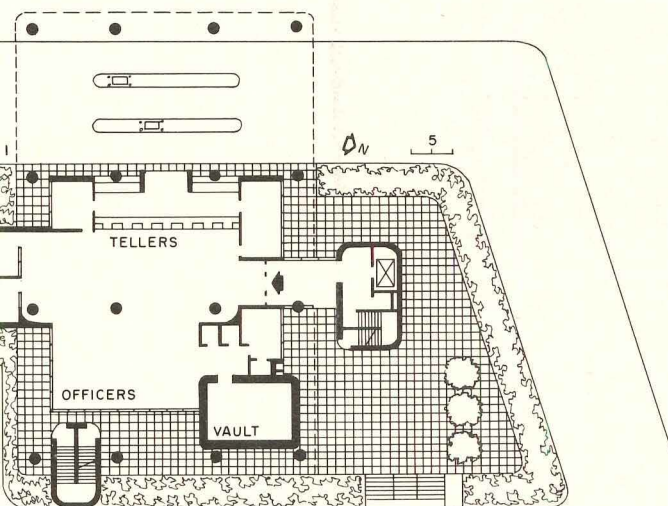

Alluding to the Villa Savoye, architects Michael Harris Spector & Associates state that the Bank of Suffolk County makes no pretense of assimilating into its environment—the V-shaped intersection of two major highways. Like the Villa, it appears as a machine—but for banking instead of living. Accordingly, it is a visual extension of the much larger man-made environment of nearby New York City and—at the same time—complements by the contrast of its stark-white, porcelain-finished metal panels the surroundings of dark greenery and paving. It also projects its surroundings to passers-by through reflective-glass windows, which are gasketed into, and are flush with, the panels. Unlike those of the project on the opposite page, this bank's designers and owners clearly believe that the building itself should be highly visible to the public. Like that project, this is a well thought-out response to environmental conditioning.

The building's sculptural quality is achieved by verticality in predominantly flat surroundings and by an arrangement of elements that are composed for equal interest from any view. The banking floor is freely defined by a number of enclosed forms containing specific functions such as the vault and stairs, and it is capped by a rectangular floor of flexibly planned offices. Drive-in teller windows are located within the building.

CORPORATE HEADQUARTERS, BANK OF SUFFOLK COUNTY, Hauppauge, New York. Architects: *Michael Harris Spector & Associates*. Engineers: *Thompson & Czark* (structural); *S. Limoggio & Associates* (mechanical/electrical). General contractor: *Abraham Shames*.



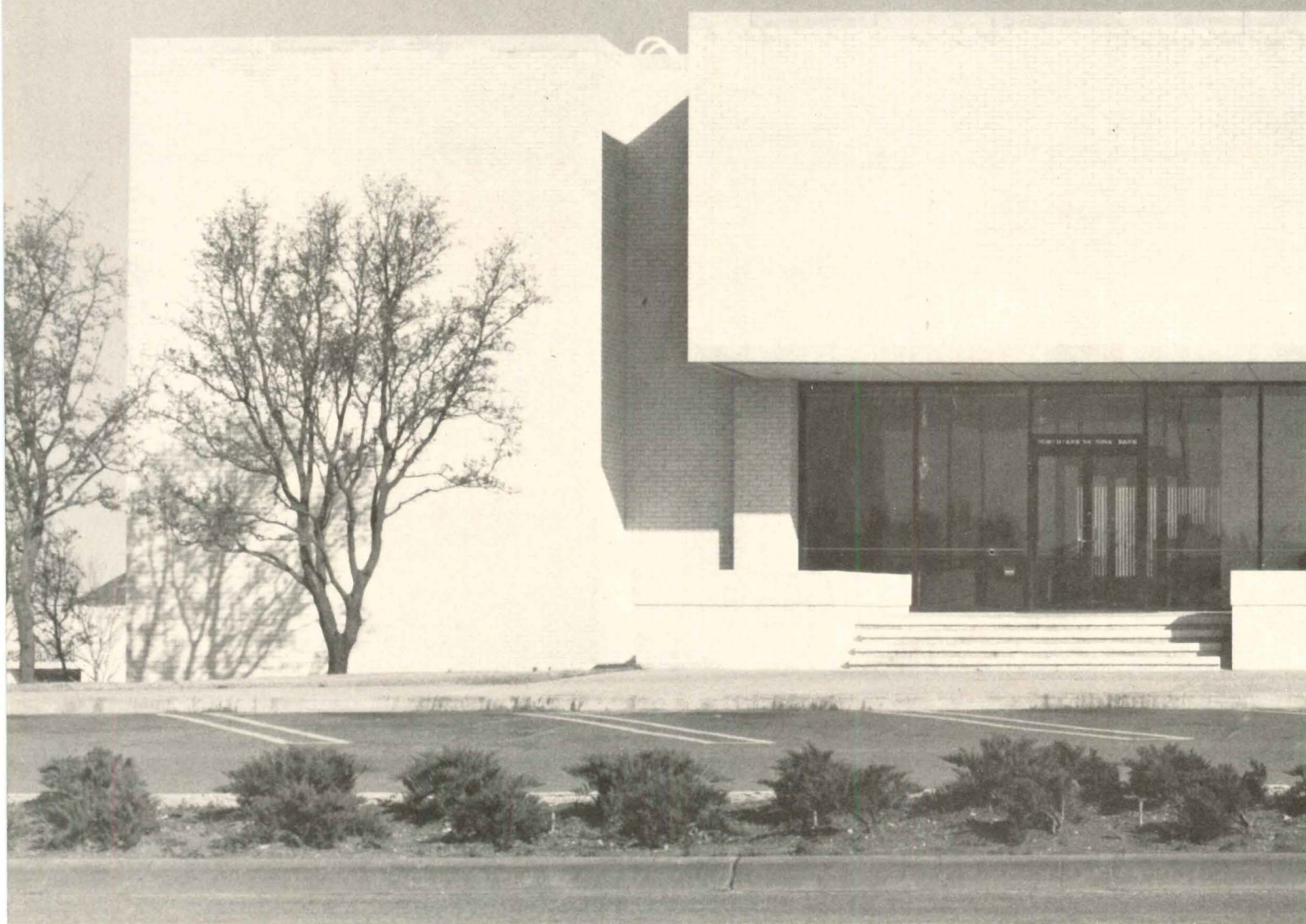

## AN ELEGANT UNIVERSAL STATEMENT OF "BANK" THAT PROUDLY SAYS TEXAS

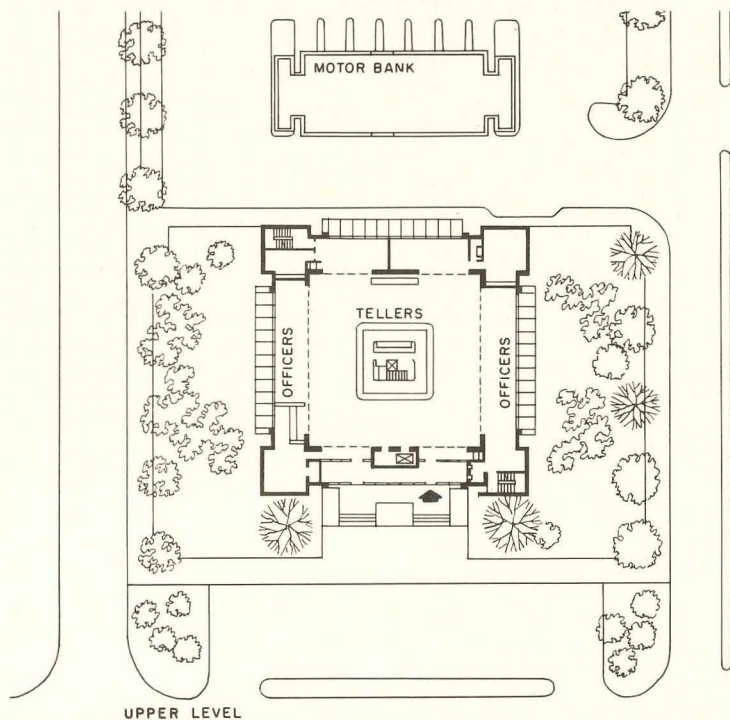

Far from the wide open plains but recalling them in its strong horizontality, the Northpark National Bank occupies a corner of the site of the innovative Northpark Shopping Center (RECORD, January 1976, pp. 135-40) in suburban Dallas. Designed by the Omniplan architects (who were also responsible for Northpark), the relatively small building's purposely strong proportions and white brick cladding are intended to achieve an additional objective to that of complementing the Center's forceful horizontality. They are also intended to visually assert the bank's importance, which could have been easily overwhelmed by its massive neighbor.

A large banking room on the steel-framed main level is designed to accommodate the demands of a planned additional three stories of banking facilities. A central teller's "island" has direct vertical access to the bookkeeping department on the concrete constructed level below. The bank's interiors were designed by Mrs. E. G. Hamilton, wife of the Omniplan partner, and contain red carpeting and blue upholstered seating of unusually muted coloring. These furnishings contrasted to white brick walls on which are hung a rotating display of artwork loaned by Raymond Nasher, the owner of Northpark and the chairman of the bank.

NORTHPARK NATIONAL BANK, Dallas, Texas. Architects: *Omniplan*, principal-in-charge: E. G. Hamilton. Engineers: *Datum Structures Engineering* (structural); *Raymond Goodson Jr., Inc.* (soils); *William Hall & Co.* (mechanical/electrical). Landscape architect: *Richard Vignola*. General contractor: *Henry C. Beck Company*.



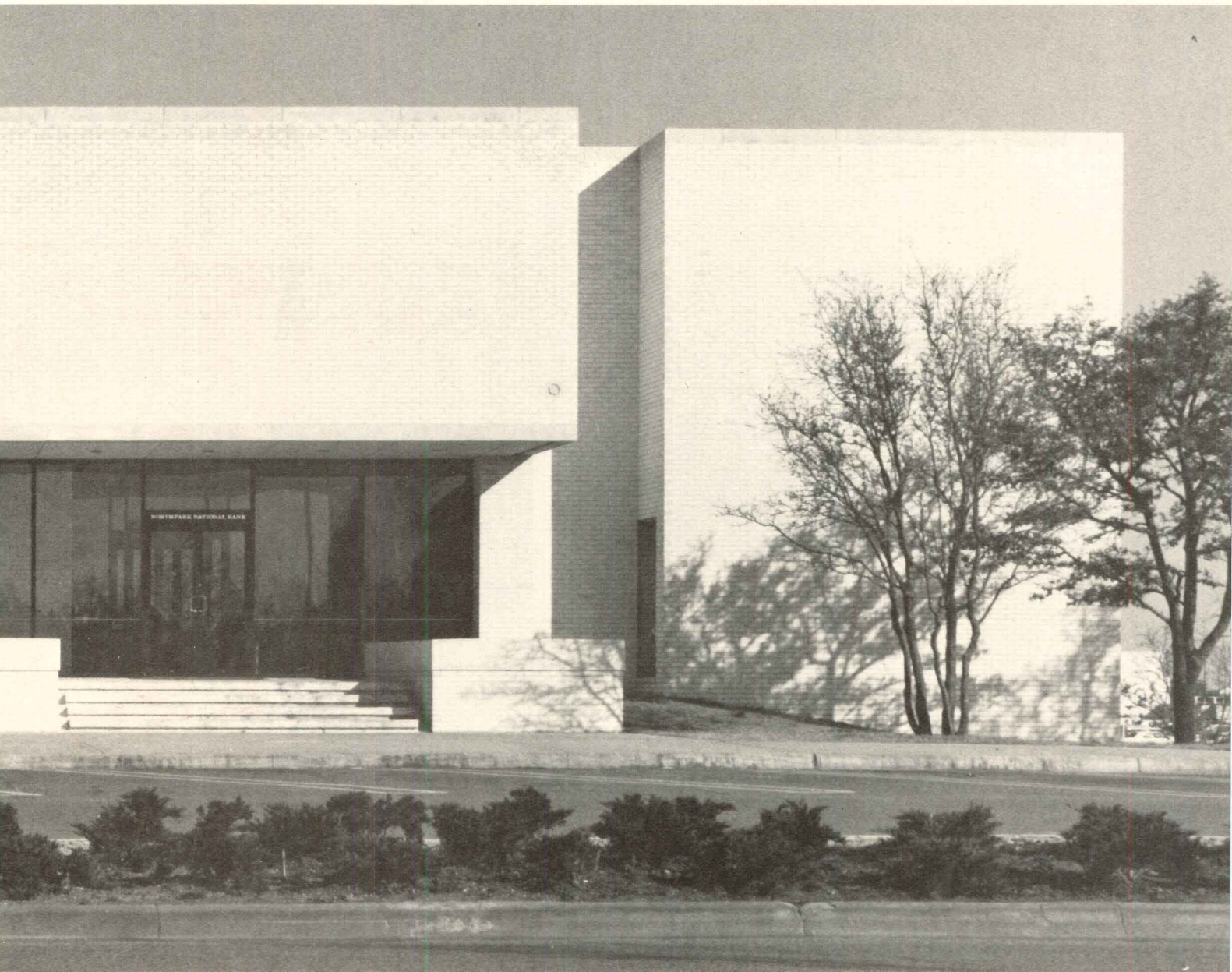

*Jeof Winningham*



*Michael Haynes*





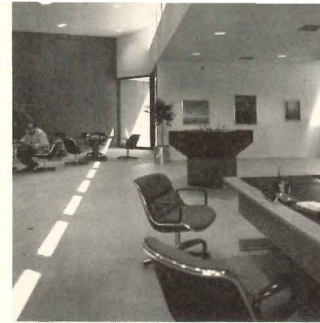
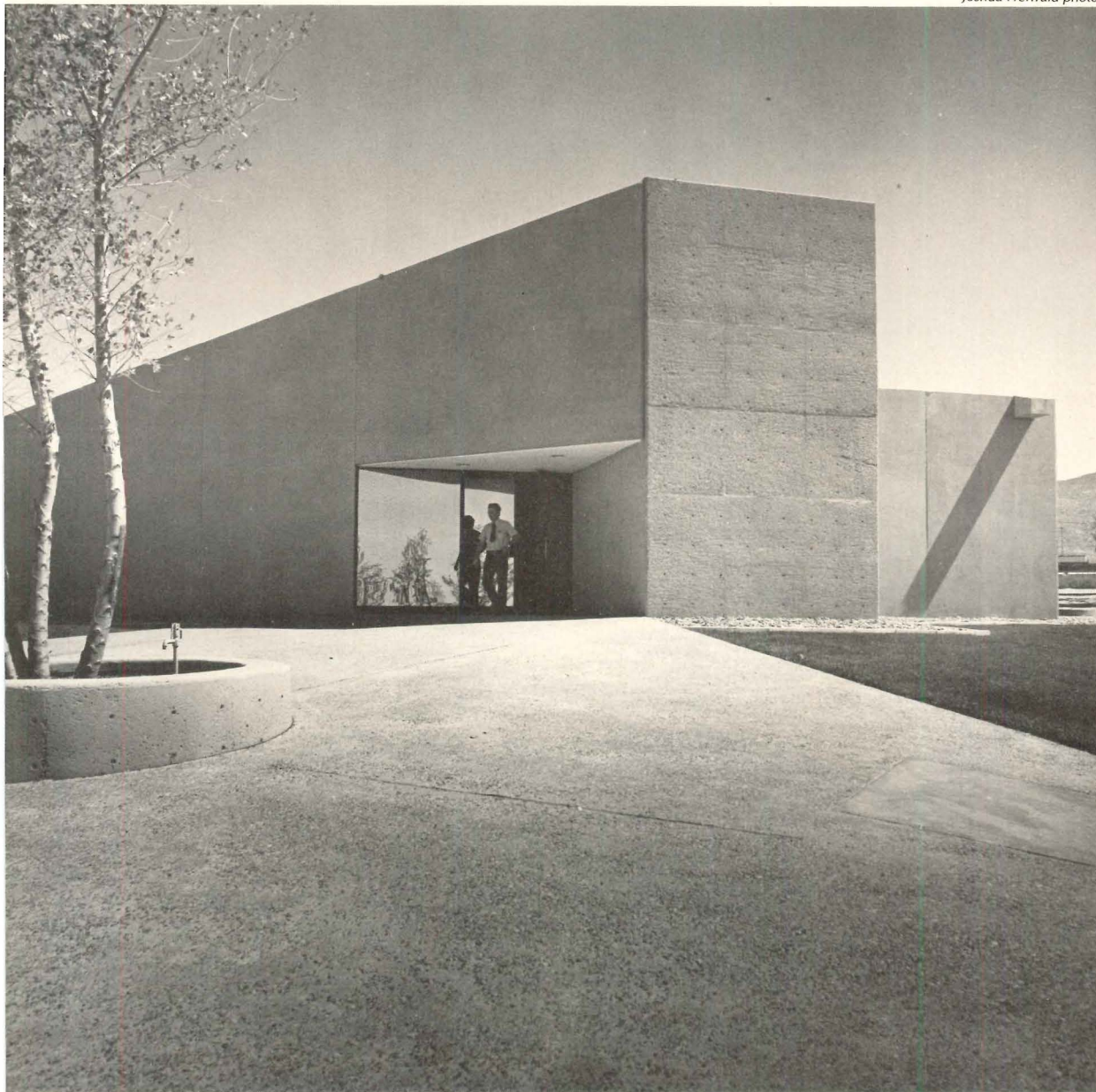

The Manzano branch is located to a shopping center. Views to the distant mountains are limited by surrounding commercial development and hence by limited fenestration. The solid volume of the building has walls that are parallel to the roads at the entrance and at the drive-in teller stations. A changing decorative element is created by the shadows of surrounding trees on the precast and poured concrete walls.

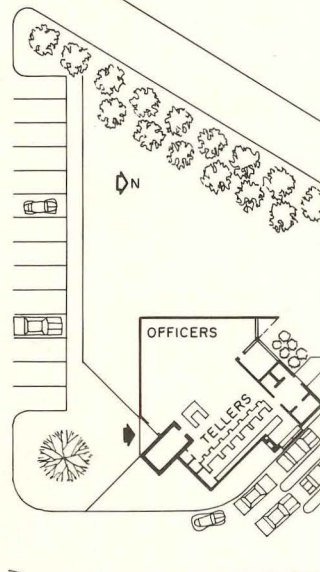

## RUGGED FORMS BORN OF NEW MEXICAN TRADITION

Perhaps the most determined of the architects here in a search for a regional vernacular, Antoine Predock has evolved highly individual imagery in his designs for these branches of The First National Bank in Albuquerque. He sees this imagery as more of a response to environmental considerations than to a stylistic recall of indigenous architecture, although the allusion is clearly evident.

In the case of the three branches shown here, each occupies a location in a different roadside commercial area of varying appeal for the extremes of varying income groups. And each has different problems of relating to views, wind, sun—and, of course, the public. But the three share common materials such as warmly-colored, bushed-hammered concrete walls and—perhaps more importantly a certain ruggedness which speaks distinctly of the hearty Southwest. Each of the branches is essentially triangular in plan. In the case of the two on this and the opposite page, the roof—like a sheltering hat—slopes down toward the southern corner, a prow into sandstorms and the heat of mid-day. On the opposite “open” side of the building, the treatments are very different. At Manzano, the tellers occupy this focal position in a low projection from the main room, and a clerestory over them is the main source of the natural light and limits views of the pervasively commercial surroundings. The higher-ceilinged main

room is devoted to a large space required by the particular program for a large banking consultation area. Roof-top mechanical equipment is concealed by high parapet walls. The steel structure is clad in sandblasted precast-concrete panels, while the vault is constructed of contrasting poured-in-place concrete. The exposed walls of the vault are carefully articulated from the panels (photo above).

At Sandia Plaza, the open side of the triangular plan is lit open through glass walls to a court, paved with quarry tile which continues into the banking room and onto the sloping roofs. The extensive views visually extend the banking room and include distant mountains above a planted berm in the court. The berm largely conceals the low-lying commercial development of the surrounding regional center. The diagonal through the site made by the building provides a convenient path for pedestrians to other locations within the center. The entire building's structure and enclosing walls are poured in-place concrete. The walls are sandblasted, and the roof is a pre-tensioned “waffle” slab in which recessed lighting brightens an ambience that feels open to the outside. Two other interesting projects shown overleaf illustrate Predock's versatility with different programs and the purposefulness in his designs.

BRANCHES OF THE FIRST NATIONAL BANK IN ALBUQUERQUE, Albuquerque, New Mexico. Architect: *Antoine Predock*. Engineers: *Randy Holt* (structural, Manzano); *Robert Krause* (structural, Sandia Plaza); *Allison Engine* (mechanical); *Don Fowler* (electrical). General contractors: *Bellamah Construction* (Manzano); *Lembke Construction* (Sandia Plaza).



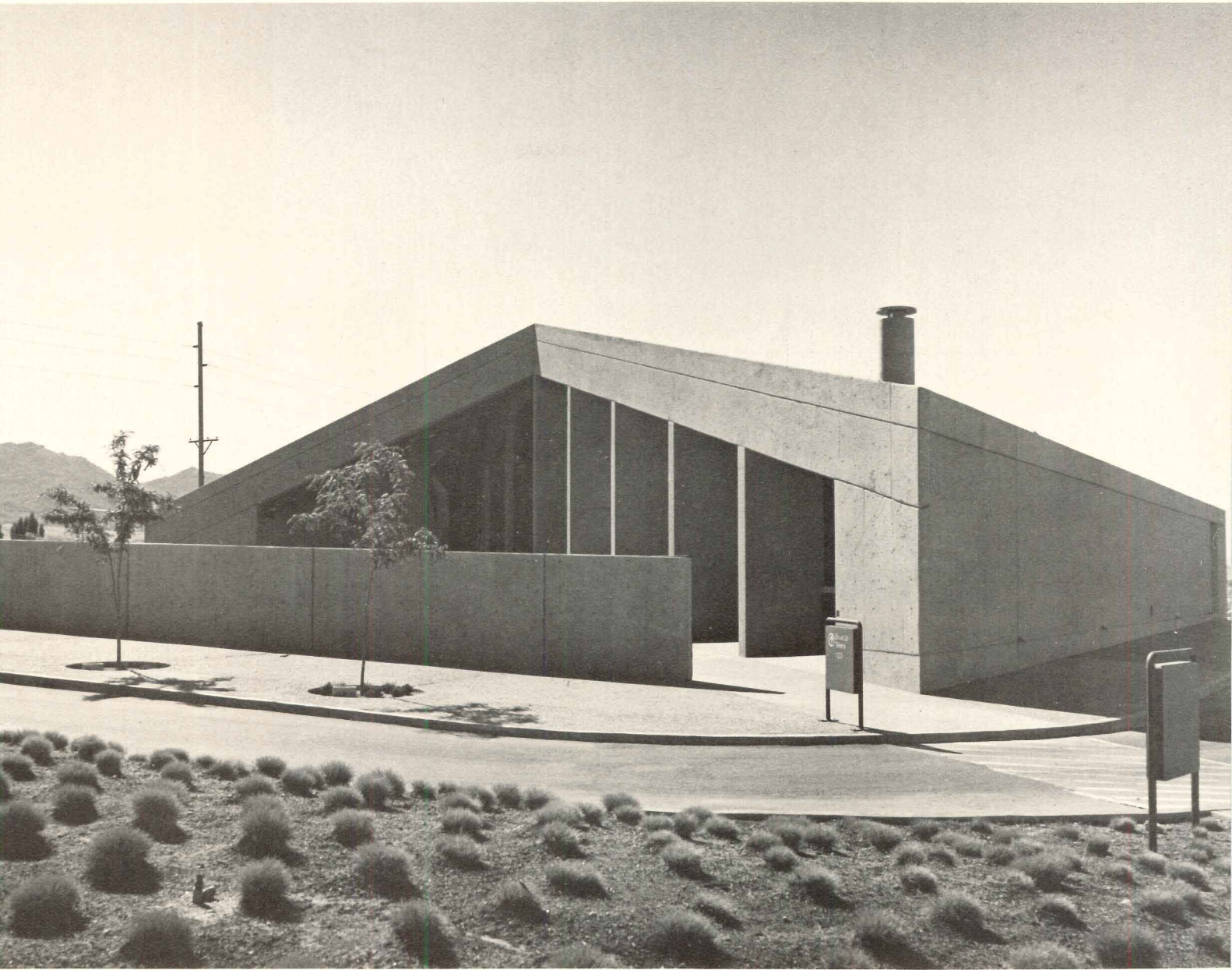

The Sandia Plaza branch has exterior walls that—like Manzano—are parallel to surrounding roadways, which are connected to an adjacent shopping center. However, here the resulting rectangular volume has been cut away to provide a walled court, shielded from the streets in a locally traditional fashion (photo, right) and extending the sense of space from within. Earth berms, planted with local materials, and a fountain create a quiet oasis within the walls.

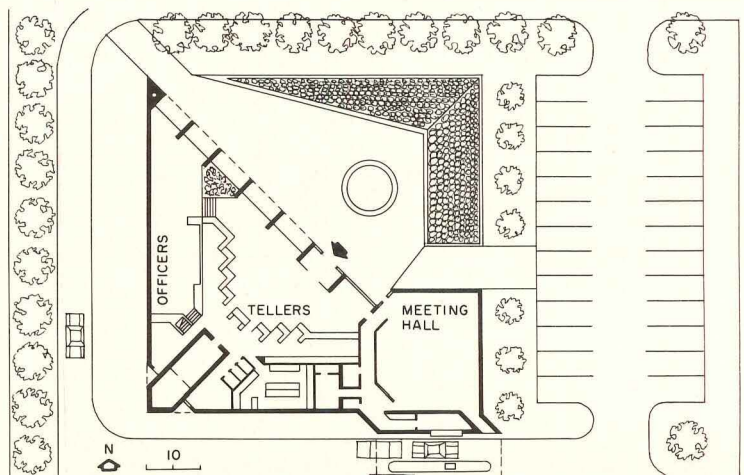
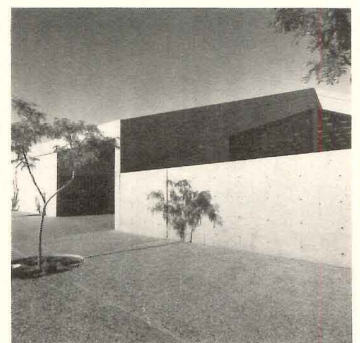





The West Central Branch is located in the most visually and economically deprived area of the three. Accordingly, it has its own pleasant interior environment with minimal window treatments. The angled entrance is designed to be in the juncture of the existing building and a future wing. The latter will have to contain the entrance plaza (photo left). To contribute a positive element to the environment, the building is sited in a large lawn, which extends down an adjacent hill and covers a screening berm to the east, where important views of mountains are then framed.

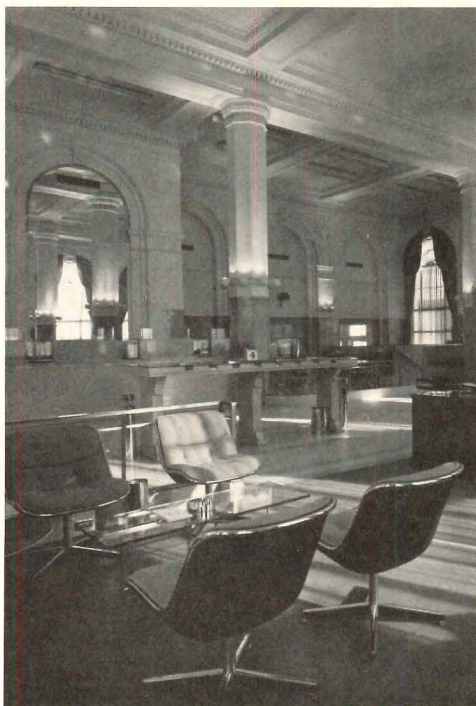
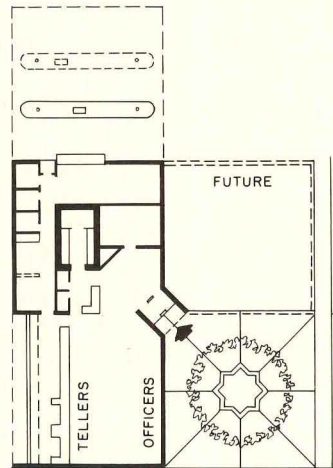

Other projects for the First National Bank by Predock include a remodeling of the downtown headquarters, which the architect described as a previously badly abused neoclassic building. In a shift from his design for new buildings, he has restored the building to its former character. At the other end of the spectrum are steel frame mobile branches, which can be pulled from temporary site to temporary site on wheels. The wheels are sunken below grade during the unit's stay in one place. These units are expected to be replaced by the construction of permanent branches. The steel framing and decking is exposed on the interior.



Gordon H. Schenck, Jr.

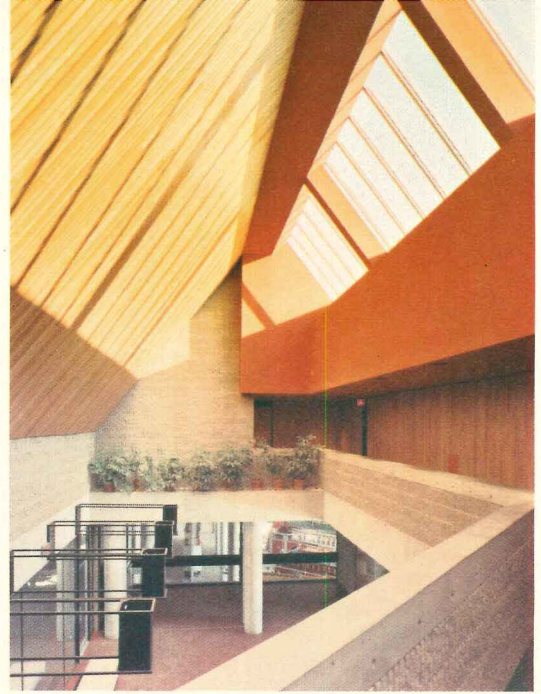

James N. Boorn



Scott Garner



Ronald Carriker

BUILDING TYPES STUDY® 493

# PUBLIC ADMINISTRATION BUILDINGS

How well are we designing for the public realm? The question of the quality and the efficiency of our public architecture has become a subject of increasing concern to professional architects, who design these buildings, and to the governmental entities who commission them and use them. Here is a portfolio of recent successes—focusing on medium-size buildings in medium-size towns, the kind most architects find themselves working with.



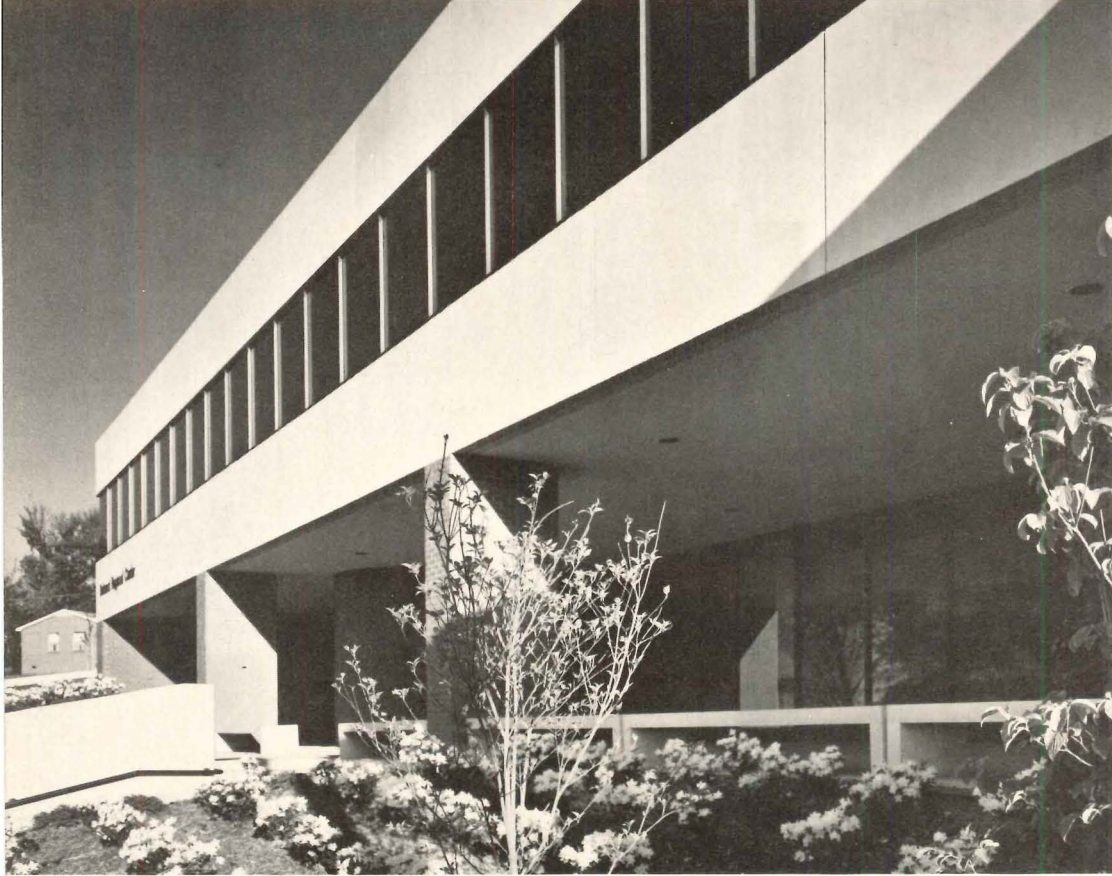

## BELMONT REGIONAL CENTER

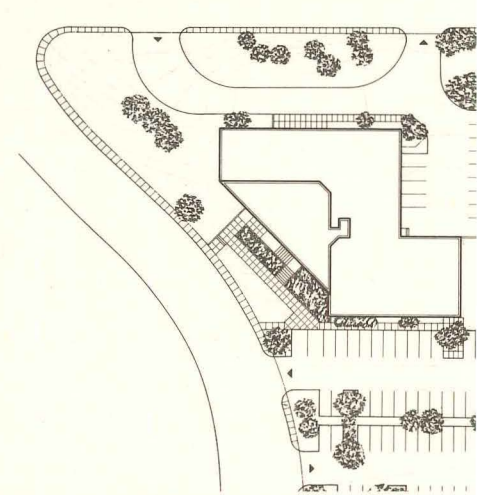





Gordon H. Schenck, Jr. photos

This building is a 25,000-square-foot neighborhood center in Charlotte, North Carolina. Its facilities include a day care service, a branch of the Charlotte Public Library, office space (designed to be flexible) for various social-service agencies including the county health department, a multi-purpose auditorium, classrooms, and meeting rooms. Outside, the day care facility has an enclosed play yard, and there is also extensive parking space on the site and drop-off and pick-up areas for buses and cars.

The site (see plan on the left) is in the shape of a trapezoid, and it slopes downward approximately 35 feet from its highest point to a small creek (which is at the bottom of the

plan). The architects decided that the building should be multi-level, and it should be located near the highest point on the site. Parking is located nearer the creek, and partially within its flood plain (large photograph above).

The main entrance to the building (photographs opposite) faces the main street and the passing traffic, thus announcing itself to passers-by, and also being accessible for entry from the adjacent parking lot. A secondary entrance, with convenient drop-off and pick-up points for buses and cars, is located off the secondary street (at the top of the adjacent site plan, and shown in the large photograph on the following page).

The lowest level of the Belmont Regional





Center houses the day care facility, which has its own entrance from the parking lot (extreme right of the three plans on the opposite page). The main floor of the building (center plan opposite) contains all of the social-service and educational facilities, which are grouped around the public lobby, shown in the photograph on the opposite page. Circulation through the lobby is accomplished by ramps, one of which can be seen in the background of the photograph opposite, behind the receptionist, who from her central position has visual control of the entire area.

The upper, or mezzanine, floor of the building houses the administrative offices for the center; above it, clerestory windows allow

sunlight to flood into this area and into lobby below.

The structural system for the building consists of one-way poured-in-place concrete slabs for the upper floors, and concrete columns, beams, and slabs on grade. The exterior walls are of red brick on block, with exposed concrete spandrel beams. The windows are bronze tinted glass which are housed in bronze anodized frames.

BELMONT REGIONAL CENTER, Charlotte, North Carolina. Architects: *Gantt/Huberman Associates*. Project architect: *Scott Garner*. Engineers: *Frank Hicks* (structural); *McKnight Engineers, Inc.* (mechanical); *Ben Weinreb, P.E.* (electrical). General contractor: *Gates Construction Company*.





Gordon H. Schenck, Jr. photos

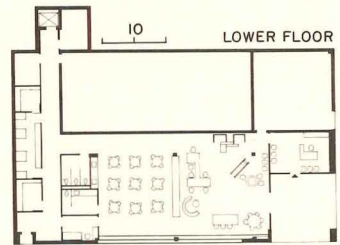
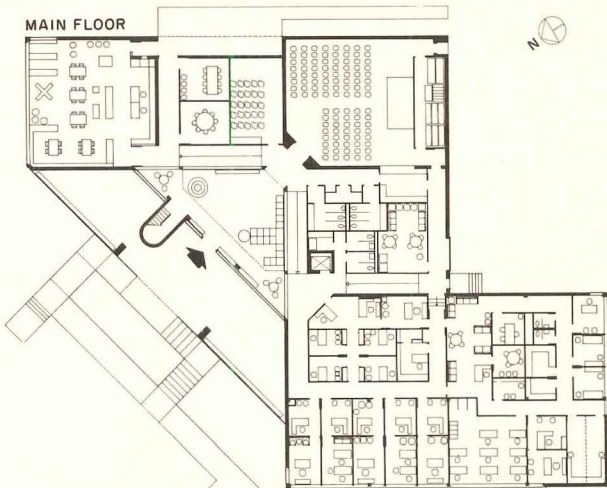
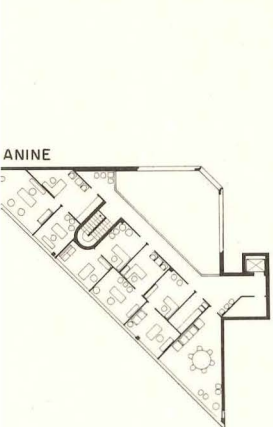



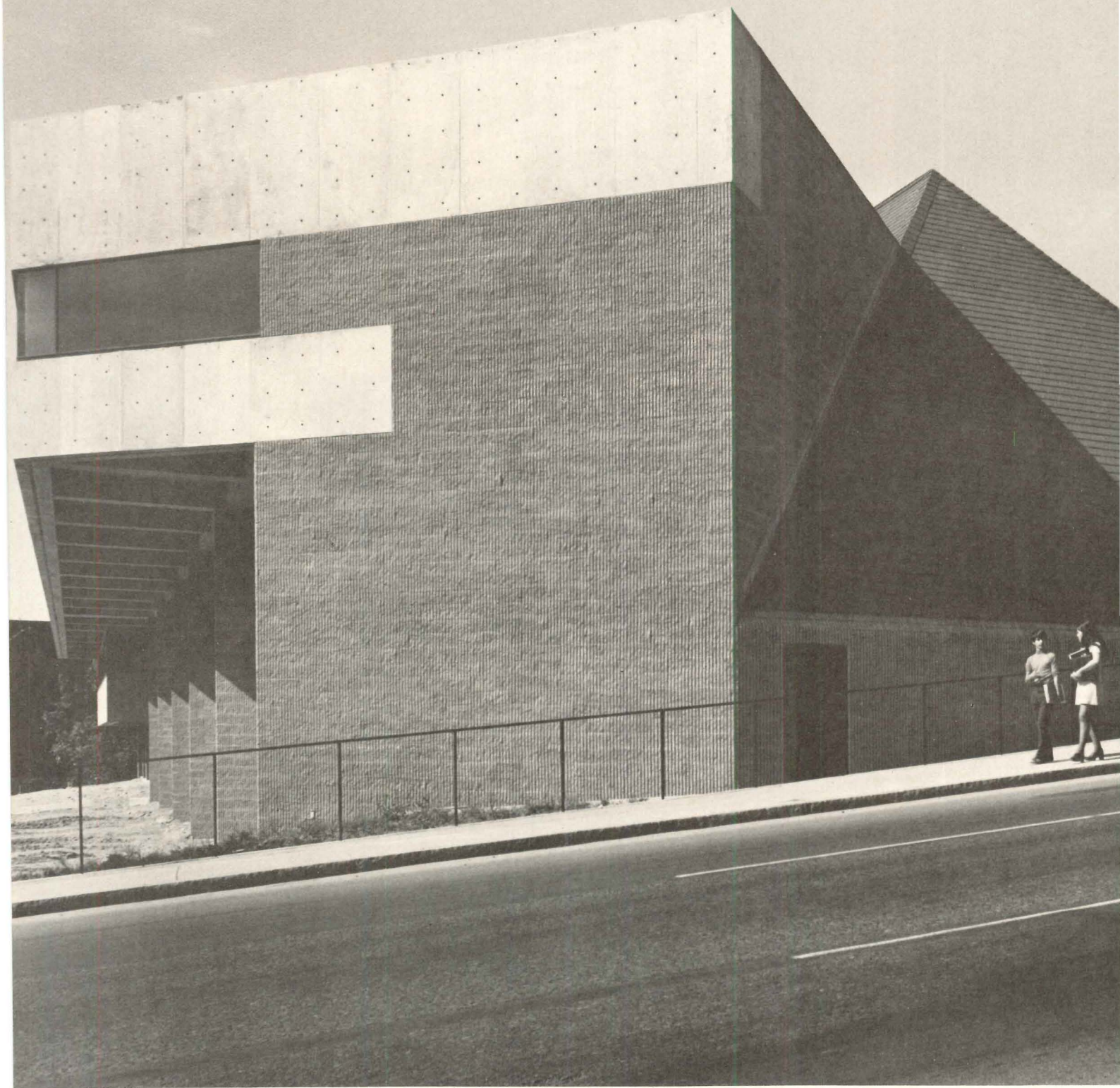

## AMSTERDAM PUBLIC SAFETY BUILDING

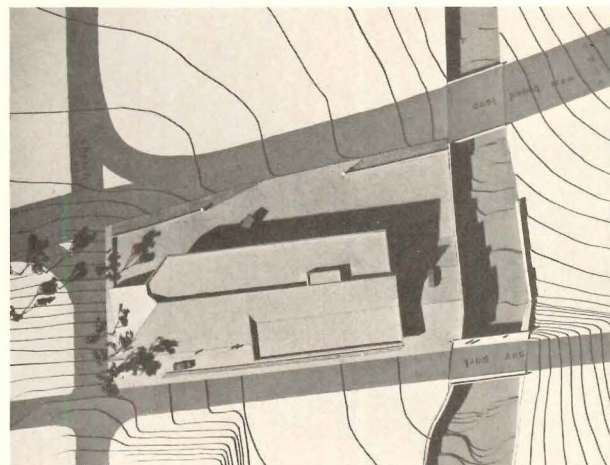



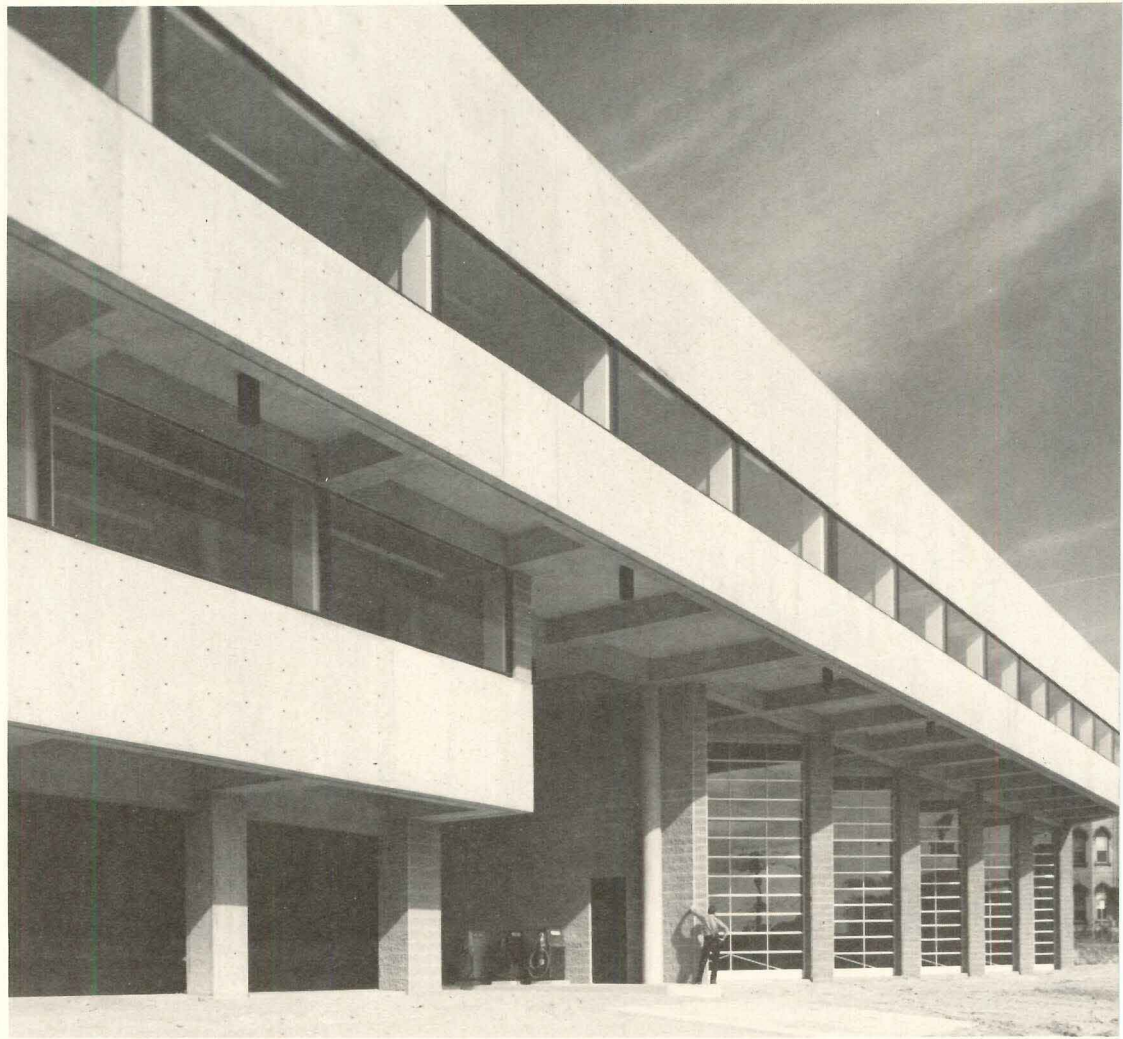
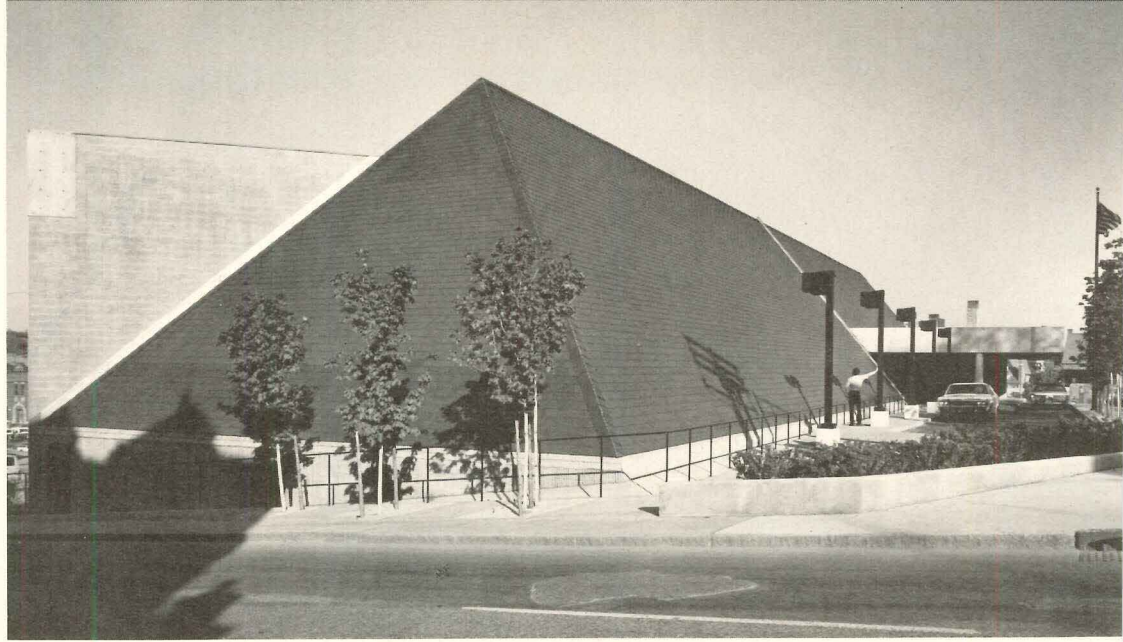

James N. Boorn photos

Amsterdam, New York, is a small industrial town that lies on a steep bank of the Mohawk River in upper New York State. The town was about to lose its police station and central fire station—each in separate buildings and both inadequate—to a major downtown urban renewal project. In the face of this, the town's council decided that it would make sense to house both of these public services in a new building—dubbed the Amsterdam Public Safety Building. Doing this, the council reasoned, not only would save money on construction, but it would also give the new building the chance to be big enough, visible enough, and public enough to provide an important cornerstone, a landmark, for the ambi-

tious rebuilding that was contemplated for the center of the town.

The cleanliness of this logic seems evident. But so, too, is the fact that—even though both fire protection and police services are conceptually similar as public safety operations—they in fact have almost nothing to do with each other in terms of actual operations. So to the architects fell the task of developing a clear separation of these two operations within a single building.

The architects in this case are Feibes and Schmitt of Schenectady (*RECORD*, June 1974, pages 136-37), and their design depends heavily on the peculiar nature of the new building's site, which is shown on the left. It is a long and



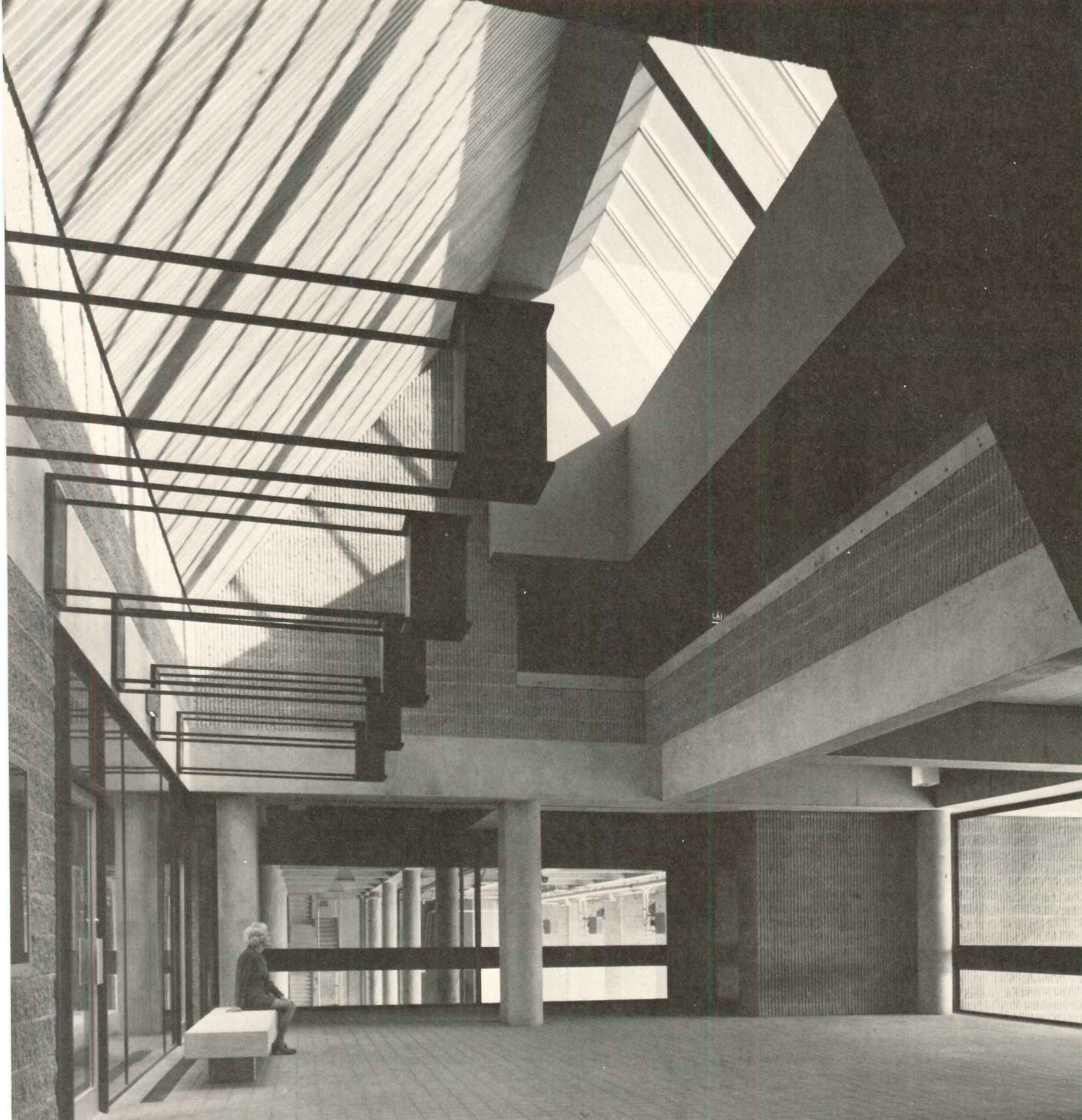

James N. Boorn photos

narrow piece of land hemmed in on its two long sides by limited access state roads. One of the roads is 16 feet higher than the other, resulting in a steeply sloping site. Its short sides are stopped on one end by a creek and on the other by a steep street.

Thus the Amsterdam Public Safety Building is long and narrow and three-stories-high, nudging itself into the hill. The main entrance, which is shown in the large photograph above, is reached from the road on the upward side of the site, and it is on the middle of the building's three levels (see plans on the opposite page). Access for fire engines and police cars is on the downward side of the site. The main lobby separates the police services, which are on one

side (and which contain the small courts shown opposite), from those of the fire department, which are on the other side. The building, according to the architects, is meant to seem like it is growing out of the hill in level like the natural ledges on which it is built. The floors cantilever outwards on the downward side, and on the uphill side they form a soaring, pyramidal shape, as shown in the photograph on the previous page.

AMSTERDAM PUBLIC SAFETY BUILDING, Amsterdam, New York. Architects: *Feibes and Schmitt* (architects); *John T. Percy and Associates* (structural engineers); *Rist-Frost Associates* (mechanical/electrical). General contractor: *Sweet Associates, Inc.*



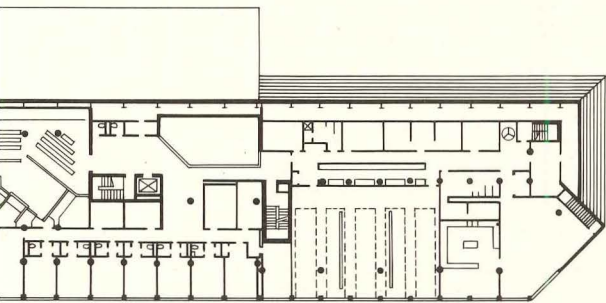

THIRD FLOOR

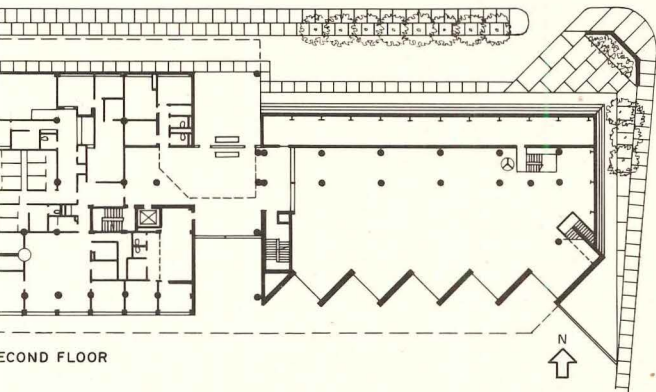

SECOND FLOOR

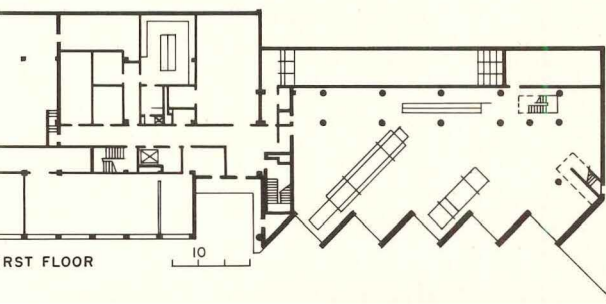

FIRST FLOOR

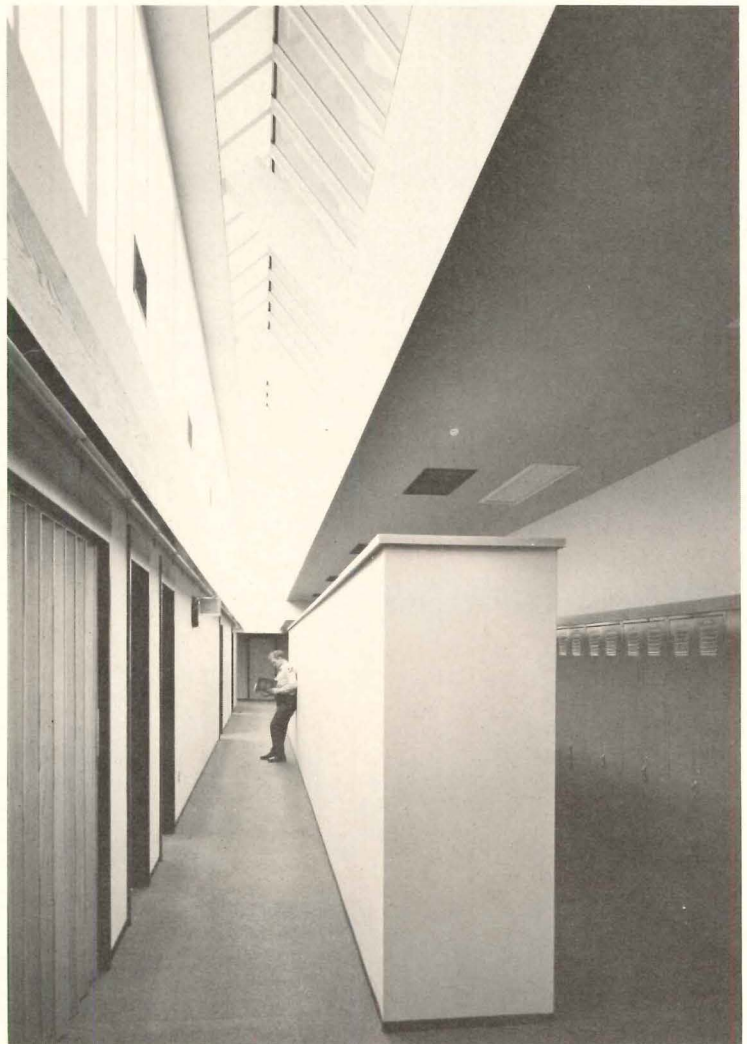



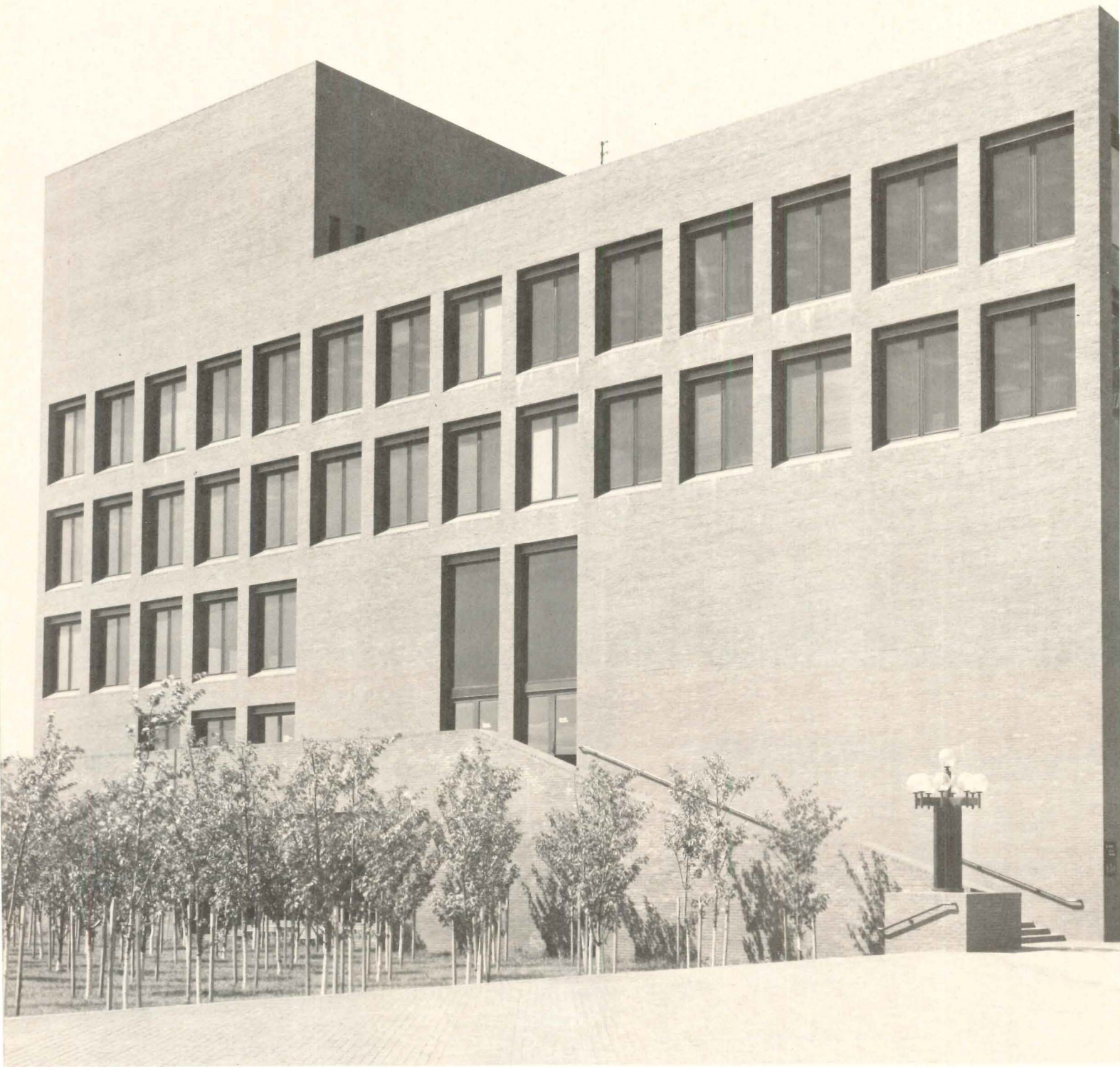

## MALDEN GOVERNMENT CENTER

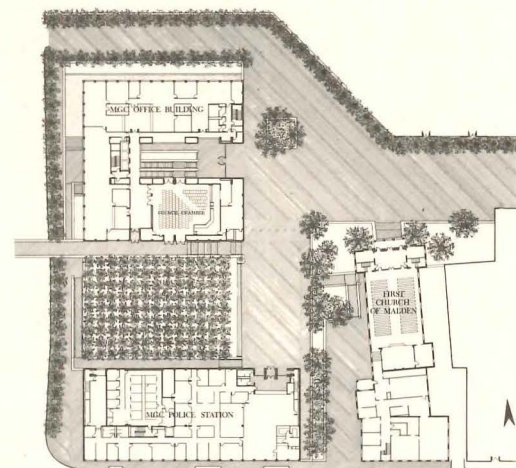



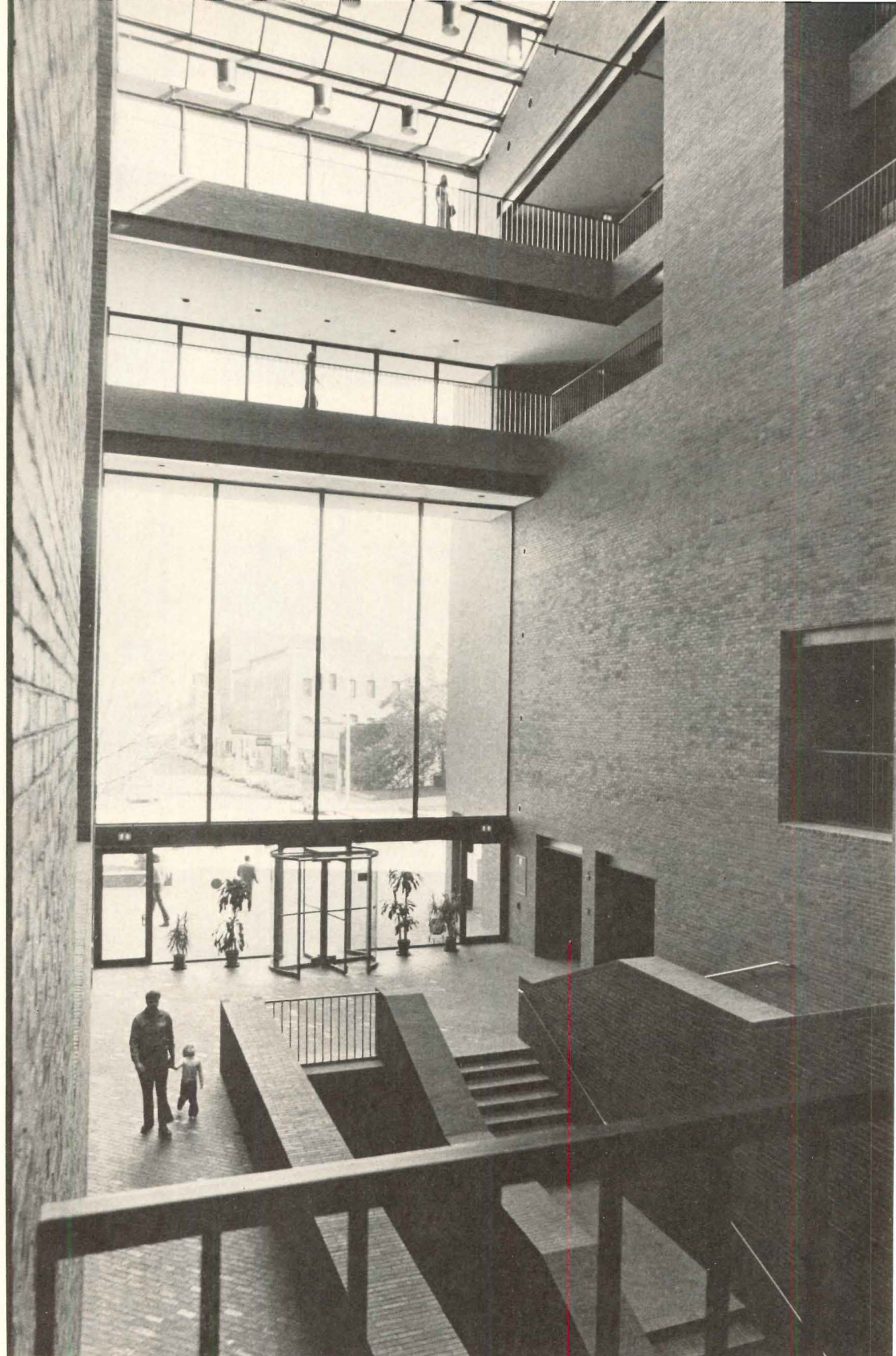
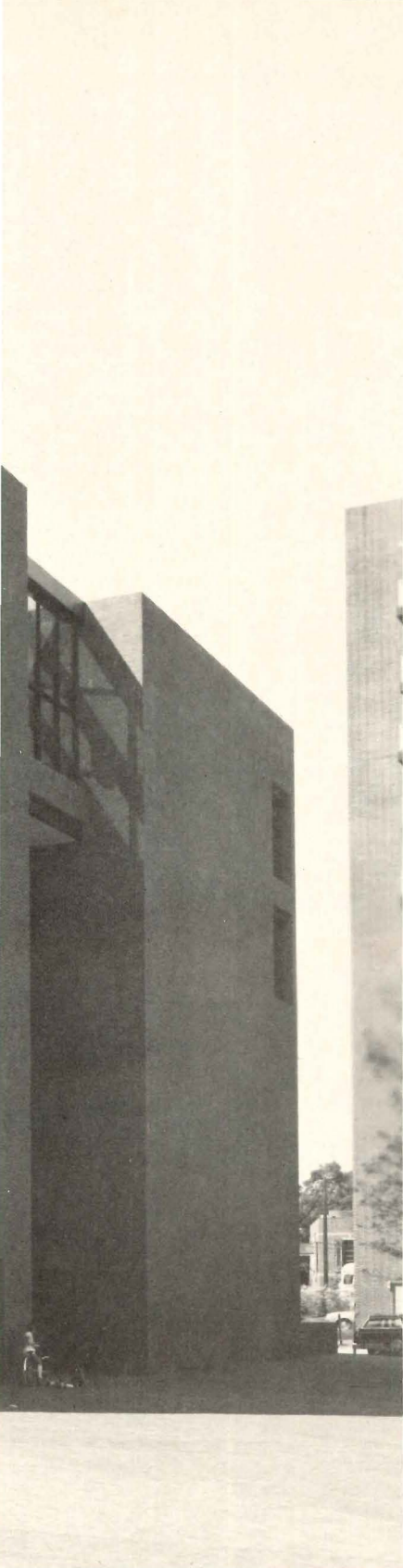

Cyros Merkezas

town of Malden, with a resident population of 55,000 people, is adjacent to Boston as a separate municipality. The firm of Doxiadis Associates had been retained by the Malden Redevelopment Authority to plan the renewal of Malden's downtown—which, if everything goes according to present plans, will eventually involve turning the main thoroughfare into a mall. Doxiadis Associates subsequently became involved in the design of Malden's new Government Center. It replaces the old city hall with a handsome and more spacious building, which also includes new quarters for the police department. Flexible open planning is the basic interior concept of the Malden Government Center, since gov-

ernment operations, local or otherwise and no matter what particular kind they are, change over the course of time, requiring the redistribution of a building's space. The most striking feature of the Malden Government Center is the full-height atrium in its center (photograph above). Its glass roof allows sunlight to pour into the center of the building, and on every floor there is a wide landing all around the atrium. Offices in turn open onto this atrium, and it is hoped that the atrium will become a focus for openness and social interaction among the building's residents.

There are virtually no private offices in the new building—with the exception of the office for the mayor, which is private, and which has



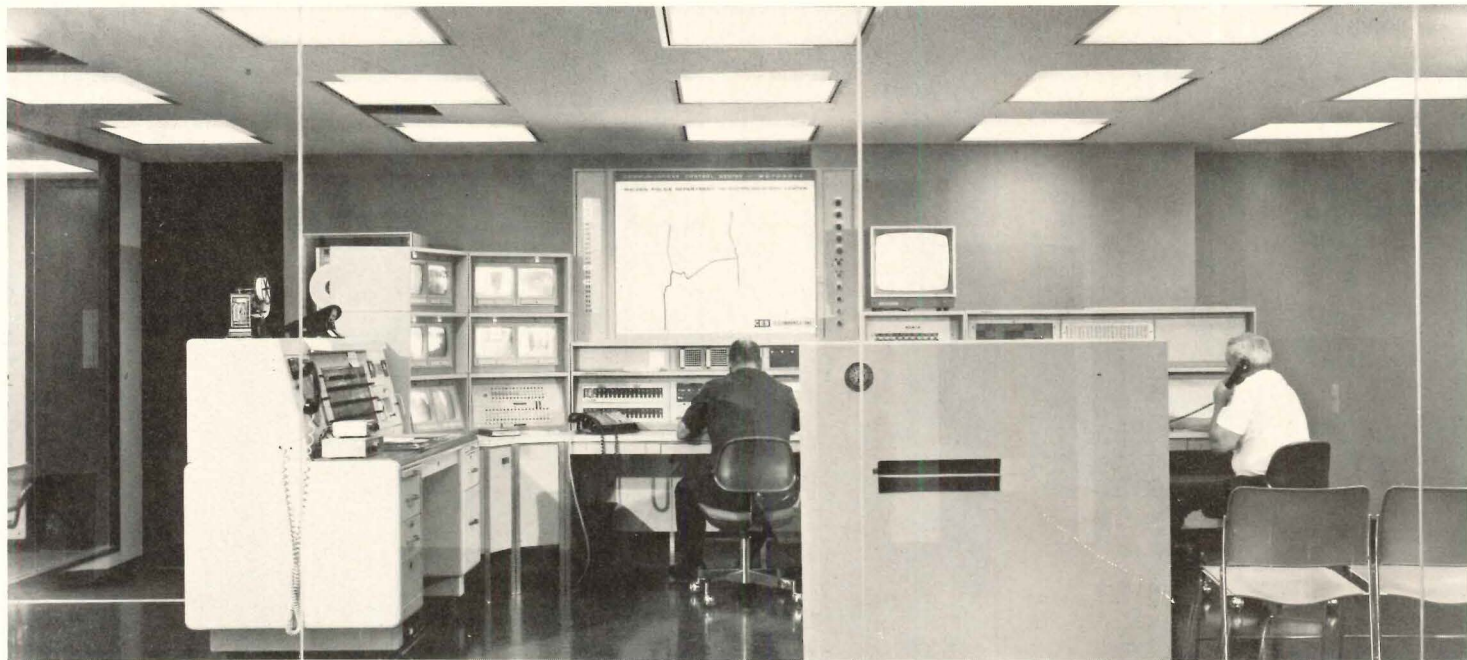
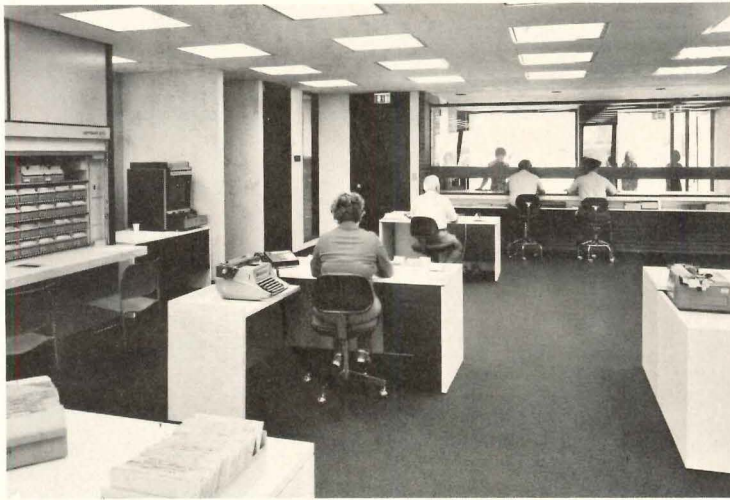

one wall that opens up to make the office part of a conference room, as is shown in the two photographs above right. The other offices are in open areas.

MALDEN GOVERNMENT CENTER, Malden, Massachusetts. Architects: *Doxiadis Associates, Inc.*; architects-in-charge: *Constantin B. Maniotes, Kenneth D. B. Carruthers*; project manager: *James Maltby*; project team: *Cyros G. Merkezas, Joseph Stephenson, Andre Houston, Peter Rosen*; associated architect: *Robert J. Lynch*. Engineers: *Colin and cardi* (structural, mechanical, and electrical). Consultants: *Everett Spurling* (specifications); *Sasaki Associates, Inc.* (landscape); *Emily Malino-Doxiadis Associates, Inc.* (interiors). General contractor: *White Construction Co., Inc.*





Ronald Carriker photos

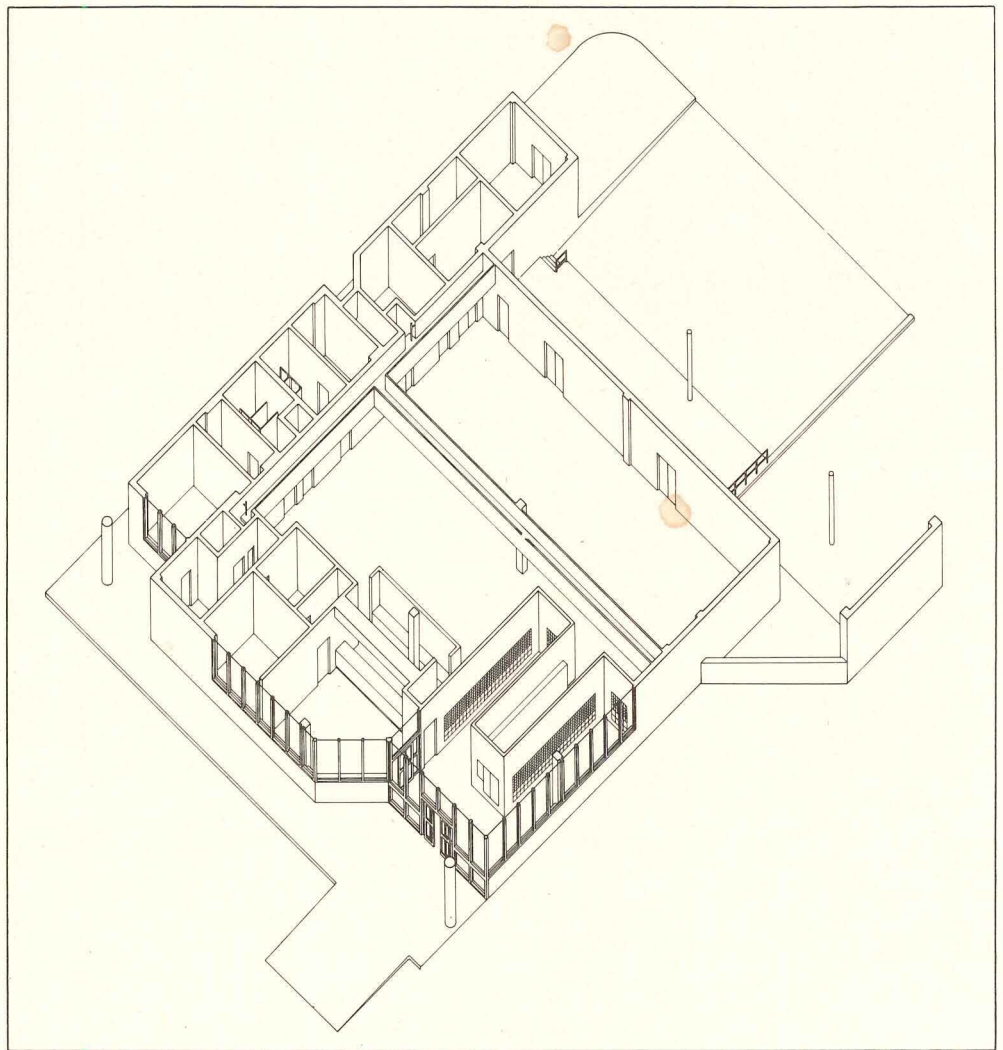
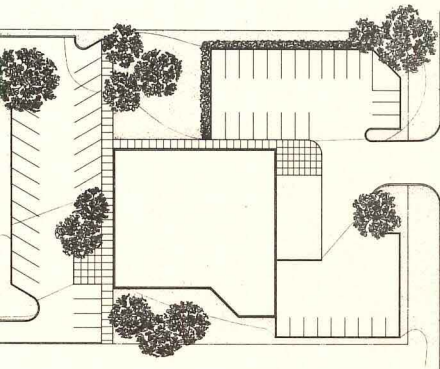

## AHOSKIE POST OFFICE

The building shown here is a small post office for a small community in eastern North Carolina. Here, as with the post office in Winston-Salem shown on the following page, the architectural conviction is that simplicity will best carry the day. Customer parking and the main entrance to the building are directly in front, and employee parking and loading and unloading docks are in the back, reached from a secondary street. The color and scale of the new post office building, together with some additional planting and the retention of several old trees on the site, are all meant to create an effect that is harmonious with the surroundings—which are residential in character, with small wood-frame or brick buildings. The floor

plan of the building is derived directly from the Postal Service's work flow requirements; the only public areas are the small lobby which contains the lock boxes and which is open 24 hours a day and the service lobby, which is open only during normal business hours. These areas achieve a sense of openness by the use of glass, which is tinted gray and mounted in black aluminum frames.

UNITED STATES POST OFFICE, Ahoskie, North Carolina. Owner: *United States Postal Service, Southern Region*. Architects: *Gantt/Huberman Associates*. Engineers: *Frank B. Hicks Associates* (structural); *McKnight Engineers, Inc.* (mechanical); *Bullard Associates* (electrical). General contractor: *C. D. Mixon & Co.*



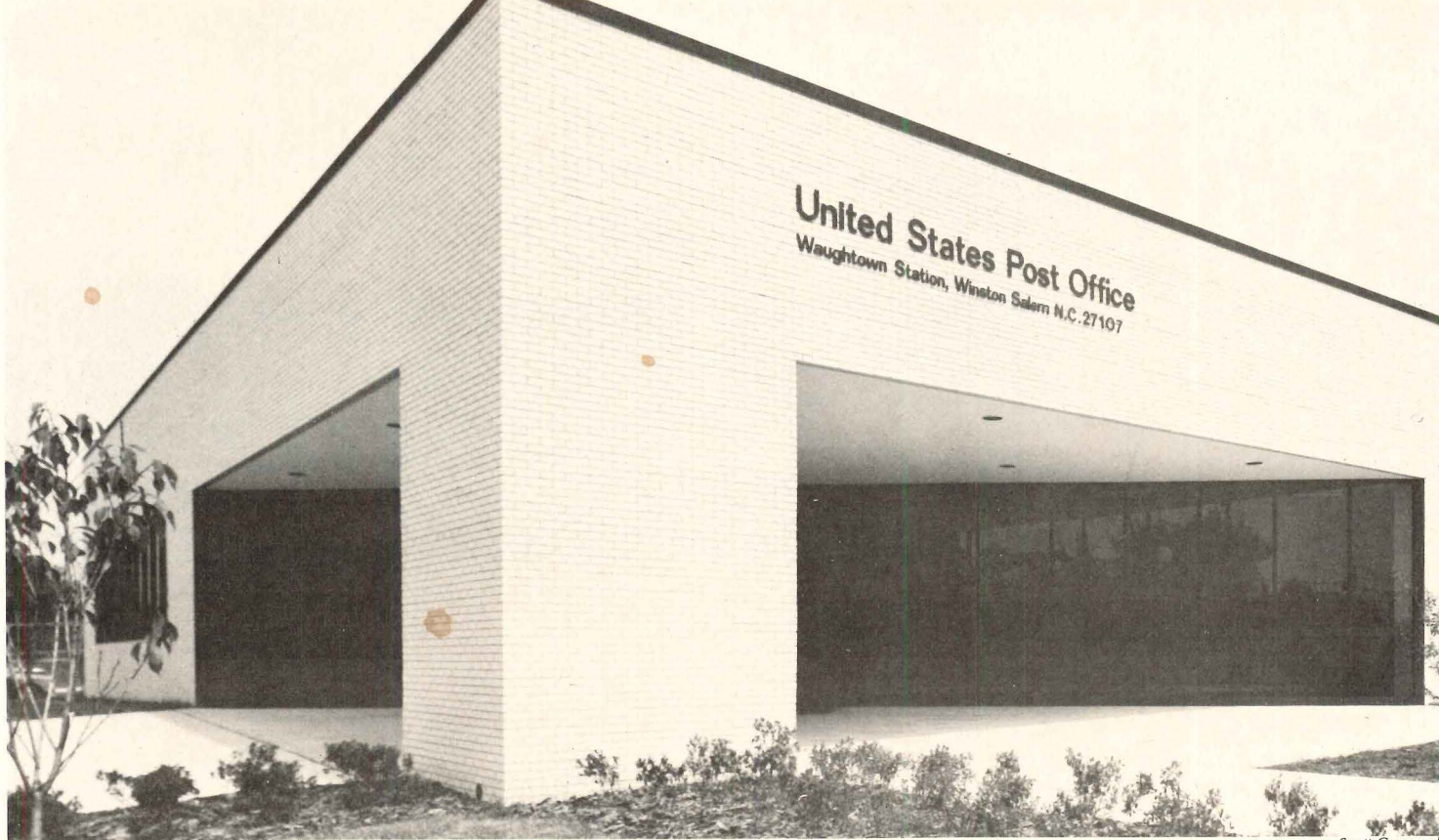

Scott Garner photo

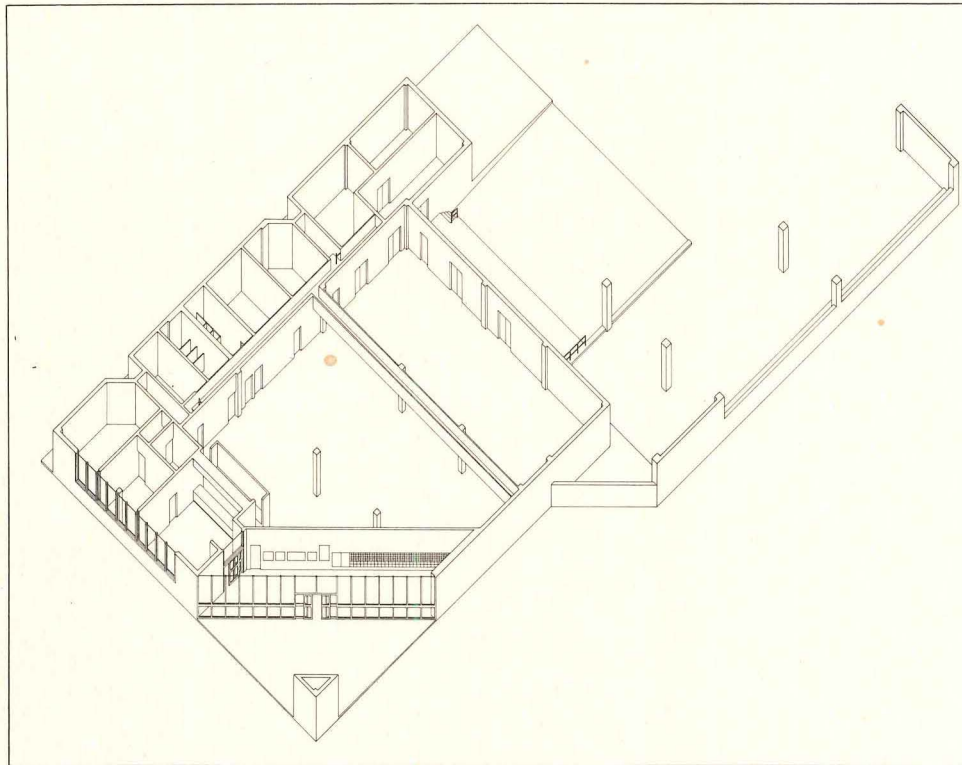
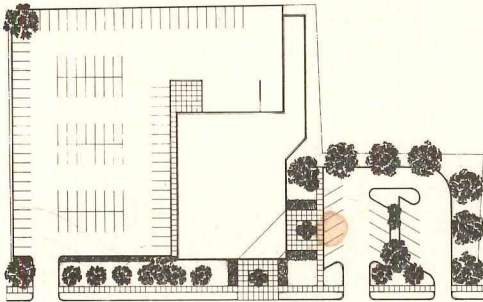

## WAUGHTOWN STATION POST OFFICE

This is a small branch post office in a transitional neighborhood in Winston-Salem, North Carolina, and it is built on a site that was formerly the parking lot for an adjacent industrial building. The design of the building is intentionally simple and intended to act as a billboard to signal the postal presence. It has a strong 45-degree portico to indicate its public entrance—which serves people who walk straight in and those who arrive by way of the parking lot as well.

All of the parking for employees is located on the side and in the rear—the part of the site that is adjacent to the industrial facilities and out of the sight of the neighboring small wood-frame houses.

The building, like its design, is simple with an on-grade concrete slab floor, steel columns and beams, bar joists, and metal decking. Exterior walls are of wire-cut brick and block back-up, and the windows are gridded glass with black anodized aluminum frames. Inside, the public lobby has vinyl tile walls and a concealed spline ceiling, while the work areas have standard finishes.

UNITED STATES POST OFFICE, Waughtown Station, Winston-Salem, North Carolina. Owned by United States Postal Service, Southern Region. Architects: Gantt/Huberman Associates. Engineers: F. B. Hicks Associates (structural); McKnight Engineering Inc. (mechanical); Bullard Associates (electrical). General contractor: R. K. Stewart & Son.



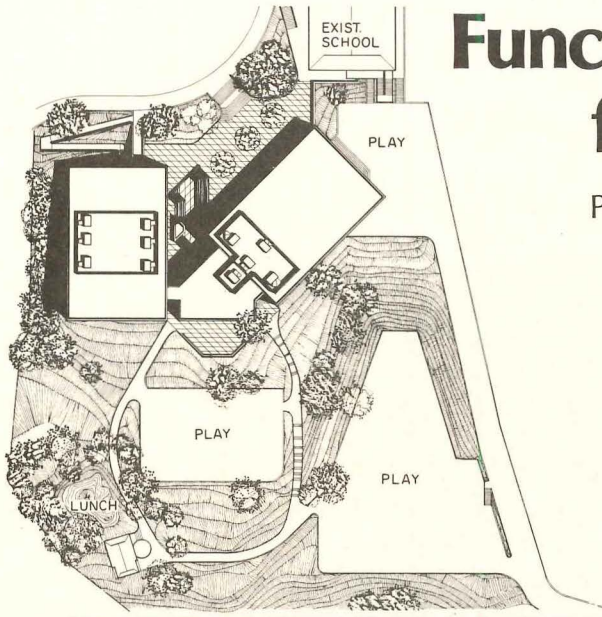

# Functional simplicity in design for earthquake resistance

Piedmont Junior High School, located in the San Francisco Bay Area, replaces an older complex of buildings that could not be economically upgraded to meet California's earthquake resistance codes. While only one example of such school development now occurring throughout the state, it is particularly a design of refined simplicity—and ultimately of economy.—*Janet Nairn*





Prompted by what is commonly known as the Field Act—an act which outlines the minimum structural requirements for design, construction and reconstruction of all California public schools for earthquake resistance—the Piedmont Unified School District ordered examination of all its schools by local engineers, and found the junior high school unsafe. It became evident that a new school building would be more economical to construct than structurally reinforcing the existing complex.

The Field Act was passed by the state legislature on April 10, 1933 (one month after the Long Beach earthquake in which many schools suffered damage). Amended through the years, it stands in the forefront of California's attempts to set minimum requirements for public safety specifically due to earthquake hazards. In 1967, an amendment to a related act required that all schools built prior to 1933 be brought into conformance with the Field Act, thus including the Piedmont Junior High School, built in 1924. Piedmont capitalized on state assistance, so much so that the school was 100 per cent paid for with state aid.

The school is located, along with elementary and senior high school buildings, in an area adjacent to community and recreational facilities, encircled by private residences. The key to its design is simplicity. The configuration of the buildings is a V-shape, with two classroom wings (of equal dimensions: 73 by 115 feet) connected by a triangular building—all conforming to the contour of the hillside. Rather than designing a traditional classroom scheme with rooms branching off a central corridor, the classrooms were placed in the center with a corridor on the perimeter. This permitted mechanical and electrical systems to circle the classroom core and extend into each room. This core was designed for maximum flexibility, for it was open-planned with sliding wall partitions on a 15-square-foot grid pattern. To facilitate the handicapped, a ramp connects the street with the main classroom wing and an elevator is provided.

Specific structural construction for earthquake resistance was entirely by addition of symmetrical shear walls at each corner of all buildings, to restrict horizontal movement due to the expected lateral forces of an earthquake. Extensive geological studies—specifically of the site in relation to the nearest earthquake fault—were conducted, substantiating the engineering solution in use of shear walls.

It is a combination of the buildings' configuration, use of perimeter corridors, classroom grids and engineering solution for earthquake resistance that also make the design of this school extremely economical.

PIEDMONT JUNIOR HIGH SCHOOL, Piedmont, California. Architect: *Chester Bowles, Jr., of Marshall & Bowles*. Engineers: *Forell Elsesser Engineers* (structural); *Woodward-Clyde Consultants* (soils); *Marion Cerbatos & Tomasi—Ivan Tomasi, principal-in-charge* (mechanical); *Stanley H. Anderson* (electrical). Consultants: *Fitzroy-Dobbs* (acoustical); *Henry Chapot* (cost); *William H. Knight, Louis Ferry, Alton Sprague* (education). Interiors/graphics/landscaping: *Marshall & Bowles*. Contractor: *Charles J. Branagh, Inc.—Peter Rocereto, job superintendent*.

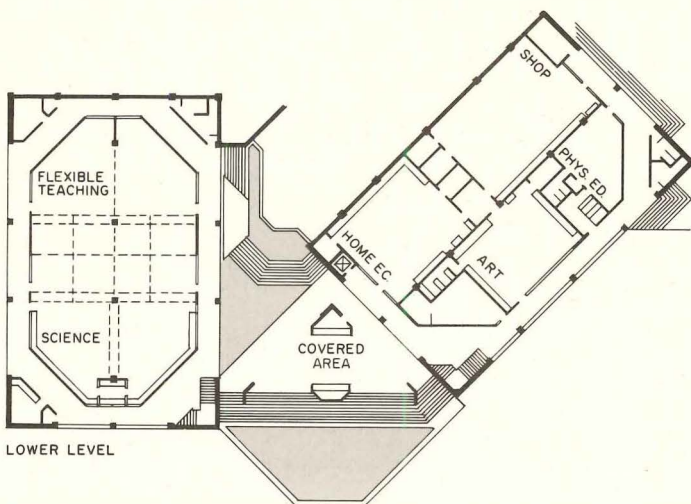
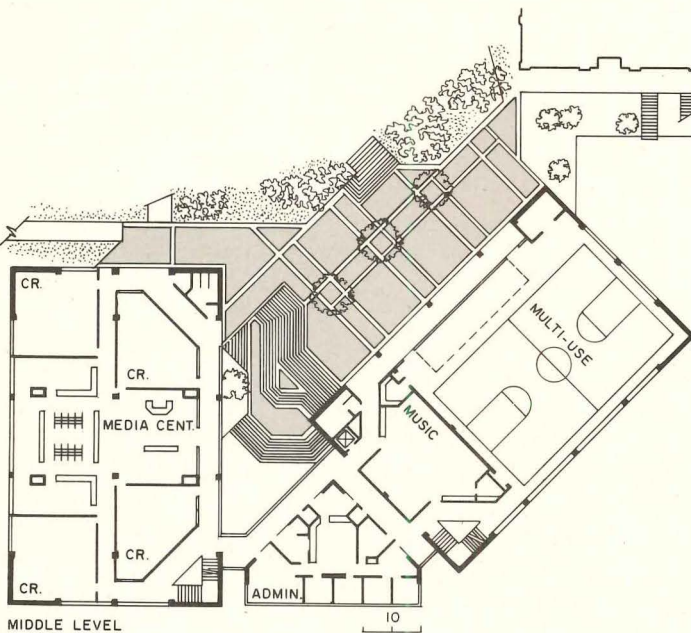
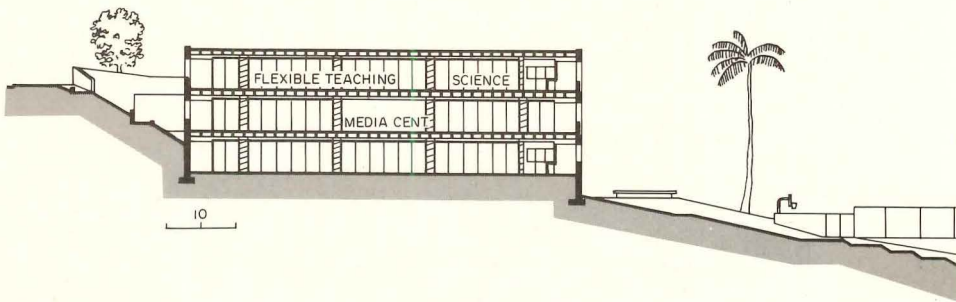
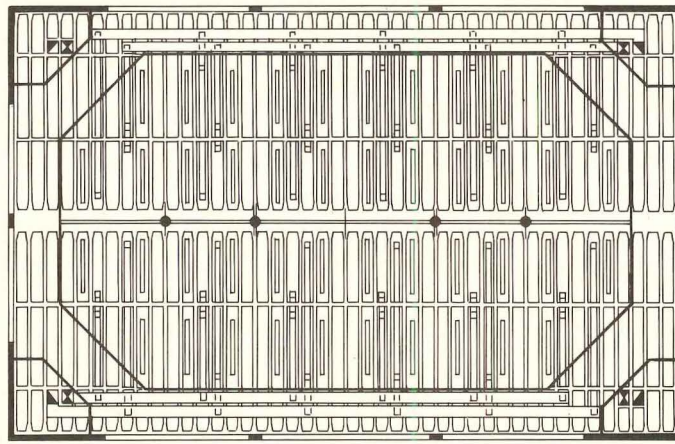

Simplicity in design is expressed in all the school's aspects, including the straightforward economic solution for earthquake resistance in the placement of shear walls at the corner of all buildings (left). A full view of the building (top right) can only be seen from the lower portion of the hillside. The angle formed from the hillside shaped configuration of the building complex was developed to create a large, open plaza (bottom right) that allows students a gathering place and permits a nearly direct entry onto the school grounds.









While the perimeter corridors are important in allowing for open-planned classroom space and efficient circulation, they also—especially through angular corners—guide views in one direction to the open plaza, and in another direction to the play areas on the lower portion of the hillside and to San Francisco in the distance. Teachers' private offices and work rooms are located in the corners (plans page 142). An open walkway under the complex (top) connects the plaza and play areas. A need for flexible space on the two-acre site necessitated an open-planned classroom core (bottom), which creates a maximum of 12 rooms on each of the first and third floors of the main classroom wing. A multi-media center and library are combined on the second floor (middle); and the gymnasium (not shown) serves a dual purpose as auditorium, having an acrylic plastic window wall (nearly unbreakable), tinted to filter strong light from the south. During construction, most trees on the site were saved, including a row on the northwest seen from the library.

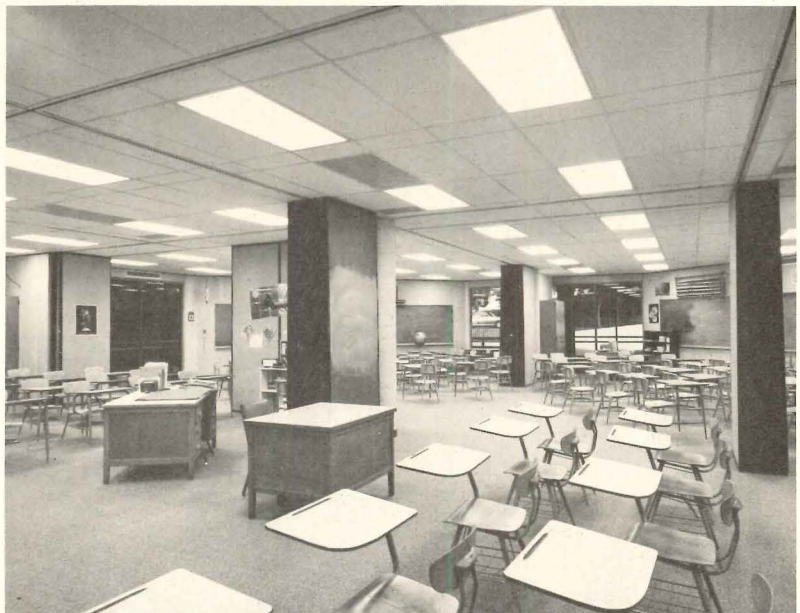
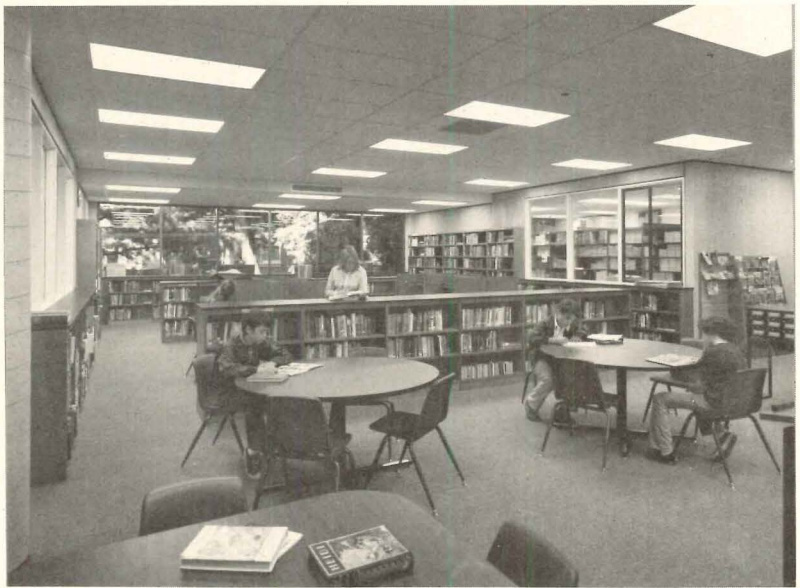



# EVERYTHING YOU WANT in one roof insulation board...



## Permalite® Pk® perlite/urethane rigid roof insulation combines the fire resistance of perlite with the superior insulation of urethane!

### new treated top surface.

New asphalt-impregnated skin permits uniform cure of urethane during manufacture, provides superior bond to built-up roof to top surface of insulation and improves ability of top surface of urethane to withstand application of bitumen heated to 500°F.

### more insulation, less thickness.

Urethane with a k factor of .13 provides highest insulation efficiency. Perlite is dimensionally stable, moisture-resistant, fire-rated, easy to work with, non-irritating. Together—

as one composite product—they provide more insulation with less thickness and save both fuel and mechanical costs.

### Full rating-bureau approvals.

Permalite Pk rigid roof insulation meets requirements for UL and FM ratings not possible with urethane alone. Permalite Pk provides the way to use urethane insulation on a metal roof deck and get an acceptable fire rating. Insurance people love it. Write now for sample and technical data.

To meet other roof insulation needs, GREFCO also offers Permalite® Sealskin® perlite insulation board.

## Permalite® Pk

The roof insulation board designed to keep heating and air conditioning costs down as the cost of fuel goes up!



A subsidiary of  
General Refractories Company

GREFCO, Inc./Building Products Division  
Oak Brook, Illinois 60521 — (312) 654-4500



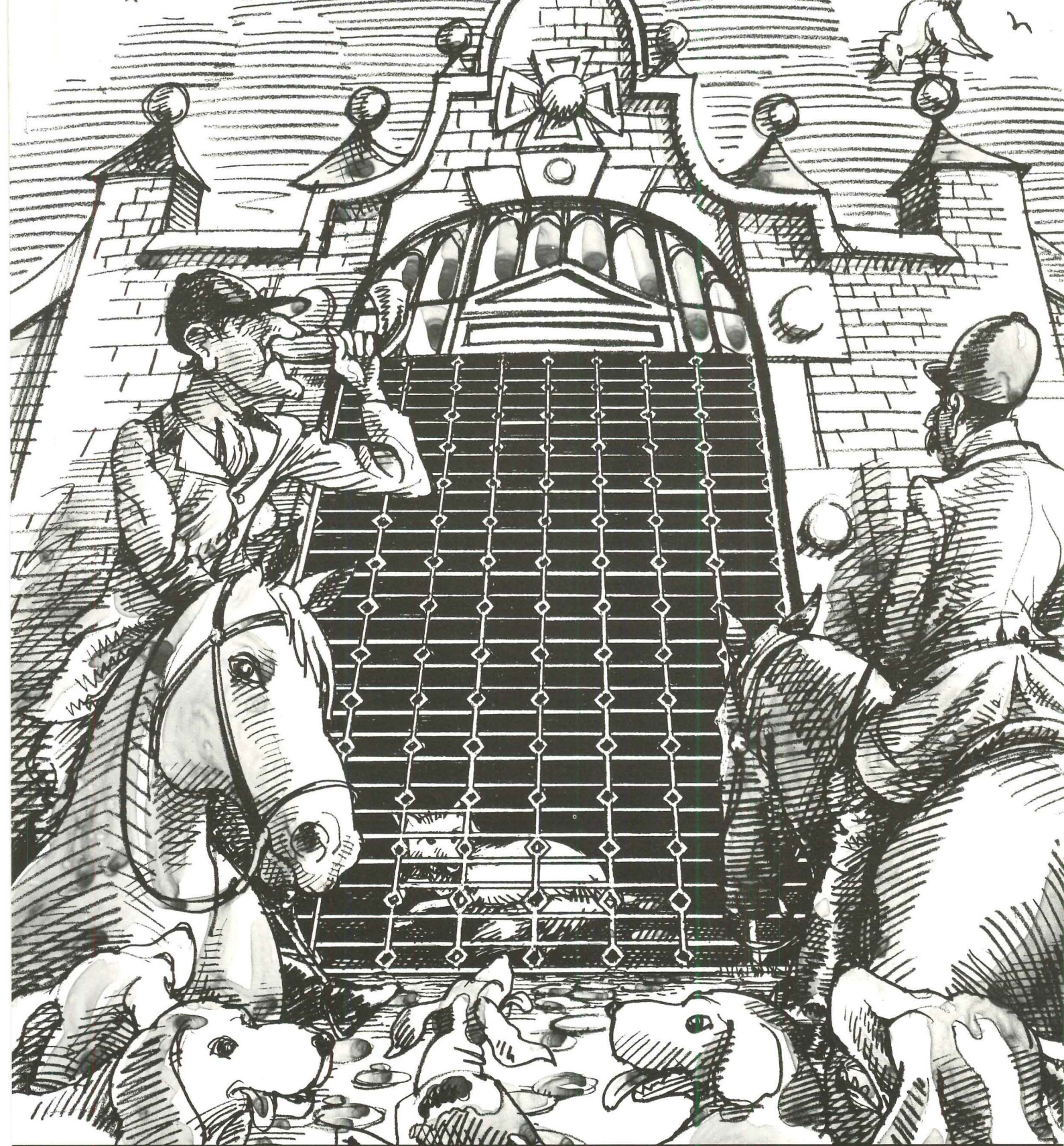

## Cookson Rolling Grilles. The best way to close an opening

Specified nationwide by architects who demand dependability, superior craftsmanship and outstanding performance. For information on our custom-engineered rolling door grilles and counter doors, consult our catalog in Sweet's (8.7/Co) or send for your own copy. The Cookson Company, 700 Pennsylvania Avenue, San Francisco, CA 94102



For more data, circle 70 on inquiry card



information, circle item numbers on Service Inquiry Card, pages 217-218.

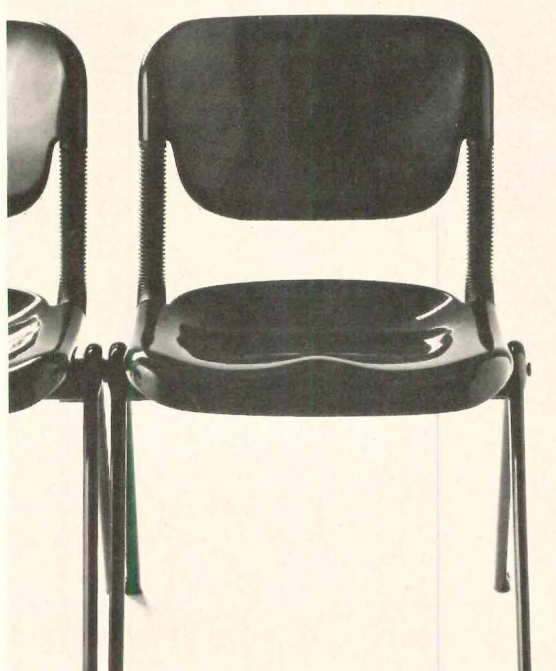
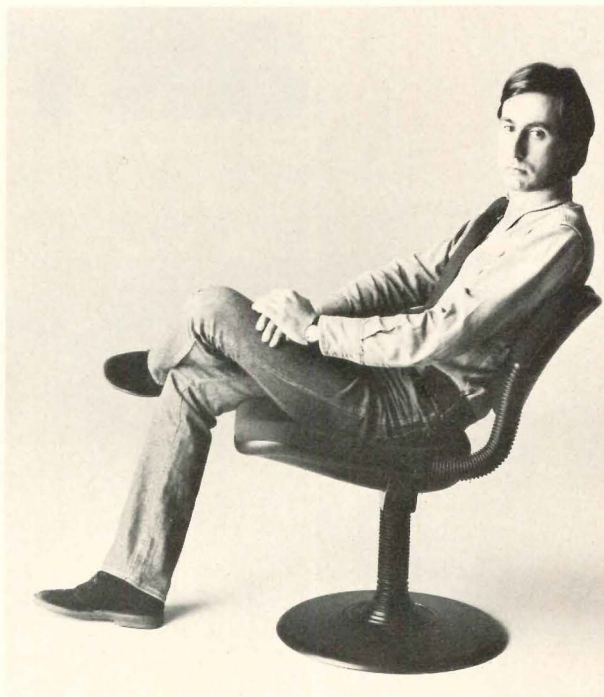

## ra seating offers automatic response to changes in sitting position

up of office chairs, de-  
y Emilio Ambasz and  
o Piretti, incorporates  
mechanisms permit-  
backrest to tilt back-  
nd the seat to slide for-  
when the user sits up,  
ward, etc. There are no  
adjustments of any  
Another mechanism

under the seat of pedestal base  
chairs provides forward tilt for  
work situations. Some of the  
mechanisms are concealed by  
rubber bellows, forming the  
arms on some models. All  
mechanisms work inde-  
pendently of each other, result-  
ing in seating that is adaptable  
to a wide variety of working po-

sitions and job functions, ac-  
cording to the company. *Verte-  
bra's* ergonomic design is rec-  
ommended for mass seating,  
classrooms, waiting rooms and  
executive suites, to name a few.  
Seat and backrest components  
are dark molded ABS with com-  
plementary finishes on the ped-  
estals. A black finished disc

base is also available. Four dis-  
tinct groups comprise the line.  
Institutional seating (lower left)  
is 48 cm wide, and has stack  
chairs with black tubular steel  
frames, with or without arms  
and tablet arms. Operational  
seating (lower right) is also 48  
cm wide, but features pedestal  
bases. Both have upholstered

options. Managerial seating is  
54 cm wide, while executive  
seating (upper left) is 60 cm  
wide. Both are offered with or  
without arms, fully cushioned  
and upholstered, and have ped-  
estal bases. ■ Krueger, Green  
Bay, Wis.

Circle 300 on inquiry card  
more products on page 153



# Overly makes pools for all reasons

You name the type of aluminum or stainless steel pool you need and Overly will design, fabricate and install it. We specialize in indoor, outdoor and rooftop swimming pools, in custom-designed therapy pools, executive exercise pools and movable bulkheads to add flexibility to pool use. A variety of water filtration systems is also available.

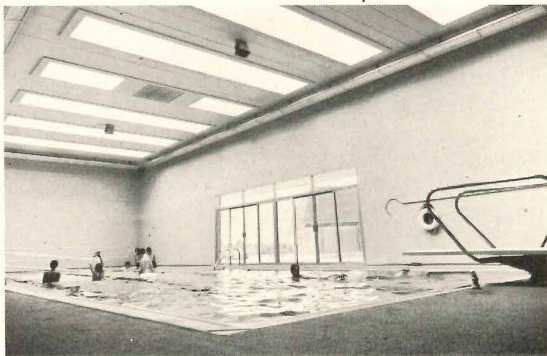

the Empire State Plaza in Albany, N.Y.

We can do the big jobs, too. One of our most recent installations was the fabrication and installation of over 100,000 square feet of shallow, reflecting pools at

Overly pools have many distinct advantages. They resist damage from earthquakes far better than ordinary pools. They won't rust, helping to keep maintenance to a minimum. And there's no grouting, caulking or sealing to fail.

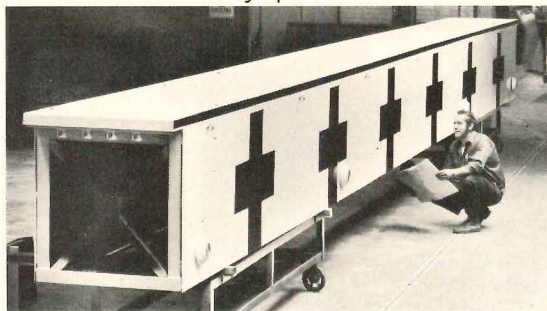

We warrant our pools for five years as to workmanship and leakproof performance. And all welds are vacuum tested.

Our design, fabrication and installation capabilities are detailed in our new brochure, Overly Pools. Write for your copy, or see us in Sweet's Catalog.

Overly Manufacturing Company, 574 West Otterman Street, Greensburg, Pa. 15601

**overly**  
MANUFACTURING CO.  
DOES WHAT OTHERS DON'T



For more data, circle 71 on inquiry card



For more information, circle item numbers on Reader Service Inquiry Card, pages 217-218.

**SLATE** / The labor-saving advantages of butt joint set-off slate—no need for grouting or acid wash—are shown in a detailed brochure. The joint-free, mono-faceted appearance is made possible by the uniform thickness of the slate 7 by 14 in., permitting a butt joint installation over adhesive on either floor or wall. Architects' comments and references are given. ■ Vermont Structural Slate Co., Inc., Fair Haven, Vt.  
Circle 400 on inquiry card

**STEEL JOISTS** / The 48-page 1976 edition of "Standards, Specifications and Load Tables for Open Web, Joist Span and Deep Longspan Steel Joists" is now available. J and H-series joists are covered in each category. Data on mechanical properties, unit stress, deflections, camber, paint, bridging, and spacing, and an eight-page "Code of Standard Practice" are included. ■ Steel Joist Institute, Arlington, Va.  
Circle 401 on inquiry card

**SEALANT** / *Side-Lap Sealant* is specifically formulated for metal building applications, according to a 4-page brochure on this sealing material. The product's ease of application and low-waste benefits are presented, along with placement and selection instructions. ■ Construction Fasteners, Inc., Wyomissing, Pa.  
Circle 402 on inquiry card

**PLAY EQUIPMENT** / More than 50 items of wooden "through-the-play" equipment for preschool and elementary age children are presented in a catalog. Shown are units for building and assembly projects, homemaking play, work tables, storage, and storage and display units. Price schedules, construction and finish details, and guarantee information are given. ■ SturdiBuilt, Inc., Monroe, La.  
Circle 403 on inquiry card

**WALLCOVERINGS** / "National Pride" is this firm's 1976 line of contemporary contract wallcoverings fully described in a 70-page binder. The collection includes vinyls, mylars and fabrics, many suitable for both wallcoverings and upholstery. Most products meet Federal specifications. ■ Boyd Architectural Wallcoverings, City of Industry, Calif.  
Circle 404 on inquiry card

**FLOORING ACCESSORIES** / A full-color eight-page brochure presents a complete line of vinyl and rubber flooring accessories. Featured are vinyl and rubber floor base, stair treads, nosings, carpet accessories, and corner bumper guards, plus a section on adhesives. ■ The Johnson Rubber Co., Middlefield, Calif.  
Circle 405 on inquiry card

**ROLLING GRILLES** / Steel rolling grilles for installation in shopping malls, office buildings, banks, stadiums, etc. are detailed in a full-color brochure. Extended are a two-piece bottom bar feature that provides security even where floors are slightly out-of-level; a patented emergency opening device allows grille opening even if electrical power is cut. Standard features include 5/16-in. steel rods encased in aluminum tubes that are continuous from jamb to jamb. ■ Jim Walter Doors, Tampa, Fla.  
Circle 406 on inquiry card

**FAUCETS** / An envelope-size folder on decorator faucets for kitchen and bath shows styles in cast brass, monolithic, vitreous china; bright or brushed gold chrome, gold, avocado, white, and special accents. ■ Bradley Faucets, Menomonee Falls, Wis.  
Circle 407 on inquiry card

**FIRE DETECTION SYSTEMS** / An eight-page brochure illustrates and describes a full line of fire-detection devices and alarm systems. Most models are intended for industrial and light commercial applications, though a single-station ionization detector/intrusion alarm unit for residential use is included in the catalog. ■ Pyrotronics Div. of Baker Industries, Inc., Cedar Knolls, N.J.  
Circle 408 on inquiry card

**AUTOMATIC SPRINKLER/STANDPIPE** / Two recent publications from the National Fire Protection Association deal with sprinkler systems. The first volume in a projected textbook series is "Automatic Sprinkler and Standpipe Systems" by Dr. John L. Bryan of Maryland. He presents the basic concept and principles involved in design, installation and function of standpipe and sprinkler systems. Chapters deal with such topics as: fire department procedures; the automatic sprinkler head; wet pipe, dry pipe, deluge, preaction and specialized automatic sprinkler systems; and exposure sprinkler and water spray systems. The text is fully illustrated, with bibliographies for each chapter. (400 pp.; \$14.95) Sprinkler installation standards for one- and two-family dwellings and mobile homes are now available in NFPA 13D, with Tentative Interim Amendments printed near the text to which they apply. Included in NFPA 13D are sections on system design for both wet- and dry-pipe; sample hydraulic calculations and layouts; water supply, pipe, and fitting requirements for home sprinkler systems. (40 pp.; \$2.50) Both, from the NFPA Publications Sales Dept., 470 Atlantic Ave., Boston, Mass. 02210.

**MEDICAL WALLS** / An illustrated 24-page bulletin is available for the professional involved in the design of medical care facilities. It describes a new series of "Modular Medical Walls" intended to increase medical attendant efficiency in patient care. Major features, technical characteristics, installation steps and a design guide are included. ■ Square D Co., Oshkosh, Wis.  
Circle 409 on inquiry card

**BUILDING SYSTEMS** / Included in this brochure is information on space frame and glazing, an integrated modular system with multi-story capability, a system with large, open bays, straight columns, open web trusses and standing seam metal roof that augment the standard rigid frame product line. ■ Butler Mfg. Co., Kansas City, Mo.  
Circle 410 on inquiry card

**CHAIRS, TABLE BASES** / Ten accent chair designs, plus a table base series, are introduced in a six-page catalog supplement published by the contract division of the company. Nine of the 10 chairs shown are pedestal models, three with Mediterranean-style bases featuring wrought iron trim. Also shown is a new "6-Series" chrome table base, coordinated in design to a new sled chair frame and offered in a range of sizes. Included are general specifications for all new products pictured, as well as price list. ■ B. Brody Seating Co., Chicago, Ill.  
Circle 411 on inquiry card

**TERMINAL HVAC** / This is an updated publication on the company's line of heat/cool "thru-the-wall" air conditioners. The six-page color illustrated publication presents ratings and specifications on 16 models for 230/208- or 265-volt operation in cooling capacities from 6,000- to 15,000-Btuh, with electric heating from 2.0- to 5.0-kW. ■ General Electric Co., Louisville, Ky.  
Circle 412 on inquiry card

## Introducing Sando-Flash™

Patents Pending

### The Universal Roof Expansion Joint Cover

A unique concept offering the architect/designer a simple solution to any roof expansion problem.

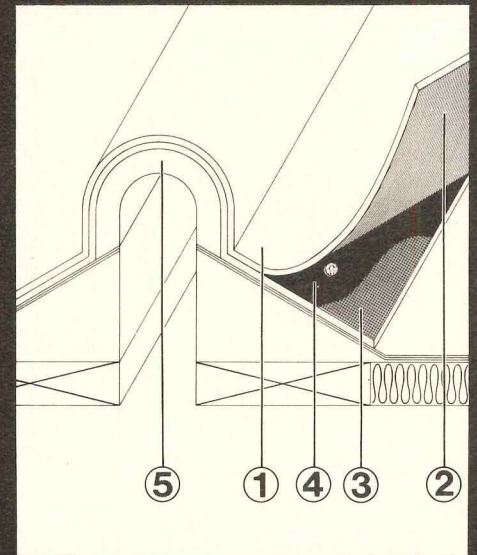

The specially formulated Neoprene Cover (1) with a unique substratum fabric (2) can be mopped to the roof — *without stripping* — with either hot asphalt or pitch. The expansion bellows consists of woven wire cloth (3) coated with a special rubberized asphalt coating on both sides (4). This is a dual-purpose component—easily shaped to any contour. The wire mesh provides an extremely high-strength elastic bellows which doubles as a self-sealing nailing strip, which is always tight to the weather regardless of temperature or expansion stresses. It is permanently bonded to the neoprene cover. Finally, the package is backed with a layer of insulating foam (5) which reduces heat loss and condensation.

For more information on  
Sando-Flash, call or write:

# S

## SANDELL

MANUFACTURING COMPANY, INC.

84 Sherman Street, Cambridge,  
Massachusetts 02140 (617) 491-0540



*Two good names...*

**Acrylite**<sup>®</sup>  
ACRYLIC SHEET  
MOLDING COMPOUNDS

*and*

**XT**<sup>®</sup> polymer

*and now another*

**CY/RO**  
**INDUSTRIES**

*A new company, a new name, a new world of exciting possibilities in transparent plastics. A partnership of the experience and know-how of American Cyanamid and Rohm GmbH. Integrating the highest standards of quality of the United States and Europe. Bringing you Acrylite<sup>®</sup> acrylic sheet and molding compounds—and XT<sup>®</sup> polymer—as you know them... American technology and invention... expertise in production, marketing, and distribution. The quality and service you've learned to rely on from Cyanamid. And more—much more. The Continental leadership, research tradition and creative design which are*

*the hallmark of Rohm GmbH. A combined commitment to innovation in transparent plastics, seeking out the most demanding applications for high performance plastic products. Synergizing to create broad new spectrums of properties... new solutions for unfulfilled needs. New conceptions... enabling new departures for industry, new lifestyles for individuals. Let CY/RO help you design the future. CY/RO Industries, Wayne, New Jersey 07470*

*CY/RO is the news in transparent plastics.*

**CY/RO**  
INDUSTRIES

A Partnership of Cyanamid Plastics, Inc. and Rohacryl, Inc.

For more data, circle 73 on inquiry card



**OTE-CONTROLLED DEADLOCKS** / This electric actuator combines an electrically-controlled strike with a secure long-bolt deadlock. "Series 7600" actuator can be installed in any narrow-stile commercial door; operation of the M.S. deadlock is by 24 volt DC current. Options include a thumb-turn opener for egress in case of power failure; status-signaling diodes in the door of the unit, and keyboard or card-actuated access control systems. ■ Adams Rite Mfg. Co., City Industry, Calif.

Circle 301 on inquiry card

**ELECTRIC METERS** / Group metering boxes of up to six units are now available for garden apartment installation. The enclosure is rated for 600 amps; the meter/breaker modules are removable. After the branch circuit wiring is pulled through, the units are reinstalled; separate covers completely enclose the un-metered bus bars. The meter/breaker units. Group metering comes in 2-, 4-, and 6-meter models; sockets are rated for 150, and 200 amps. ■ Anchor Electric, Manchester, N.H.

Circle 302 on inquiry card

**URETHANE FOAM COATINGS** / The "Weather/Flex Plus" coating system for protecting rigid urethane foam exposed to sunlight, water, pollutants, etc., is now available in five colors: white, tan, gray, green and blue; with custom shades for large orders. The finish is a two-breathable system applied by airless spray, and is designed to produce a color-stable, nearly-maintenance-free protective surface regardless of configuration. ■ Irathane Systems, Hibbing, Minn.

Circle 303 on inquiry card

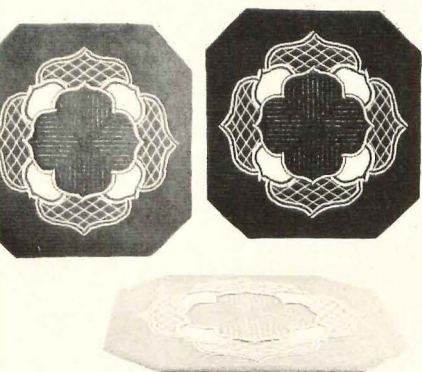

**AREA RUGS** / Intended for use as area rugs or as decorative wall hangings, this fall 1976 line includes several new designs. Pictured is octagon-shaped "Medallion" designed by Marie Creamer and based on a traditional lotus blossom motif. Other patterns are "Odyssey," a contemporary circled-square sunburst; and "Cloud Bands," a one-color, textured fretwork pattern. All rugs are 100 per cent nylon. ■ Regal Rugs, Inc., N. Vernon, Ind.

Circle 304 on inquiry card

**GAS/MICROWAVE RANGE** / This cooking unit combines a top-mounted microwave oven, with timer dials and selector control; four surface burners with pilotless electric ignition; and a 25-in., continuous cleaning lower oven with roll-out broiler underneath. Both ovens have see-through black-glass windows with interior lights. Model "76-4886" is available in white, avocado and gold colors. ■ Tappan Appliances, Mansfield, Ohio.

Circle 305 on inquiry card

**RECESSED FIXTURES** / Six different housing sizes and a wide range of lens cell configurations are features of the new Paralouver II series of low brightness recessed fixtures for static/air supply or heat transfer/air supply functions. One-, two- and three-lamp models are available; all are said to provide good light control, high co-efficients of utilization, and favorable light loss factors. Louvers are either natural aluminum or gold finish; the black reveal gives a floating appearance. ■ Day-Brite Lighting Div., Emerson Electric Co., St. Louis, Mo.

Circle 306 on inquiry card  
more products on page 155

## The Yale Series 3000 Door Closer.

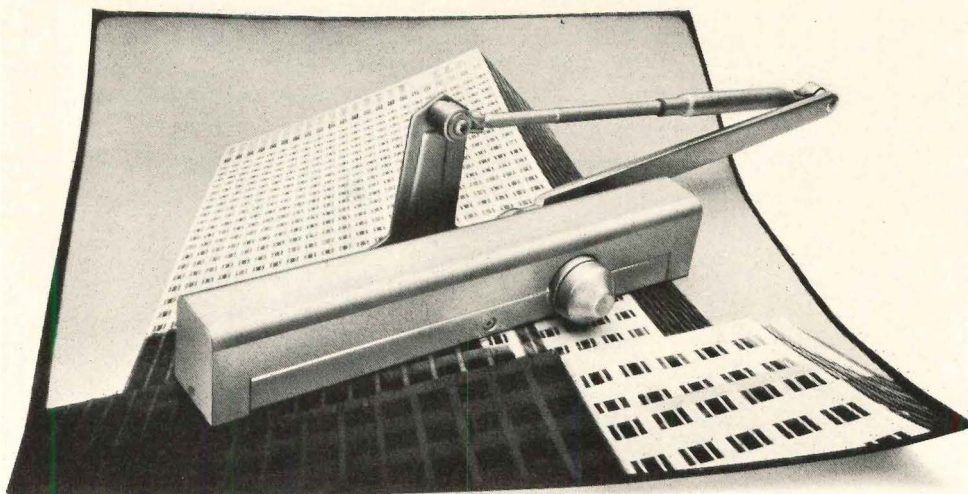

### It can be anything an architect wants it to be.

We've made the Yale® Series 3000 closer as versatile and flexible as a closer can be to make a complicated job a whole lot easier for architects, specifiers and installers.

The problem: special design factors that can make it necessary to specify as many as three or four different closer series in a single building.

The Series 3000 Yale Door Closer is the solution. Need that check, power adjustment and full cover? Specify the 3500. Need a closer with a narrow cover for an entrance door? Specify the 3300. Want that check, but don't need power adjustment or a cover? Specify the economical 3000-BC.

No question about it. The Series 3000 Yale Door Closer is the most versatile closer that can be specified on a job.

For more information, contact your Yale representative. Or contact Eaton Corporation, Lock and Hardware Division, Yale Marketing Department, PO Box 25288, Charlotte, N.C. 28212. We have a 3000 series catalog we want you to have.

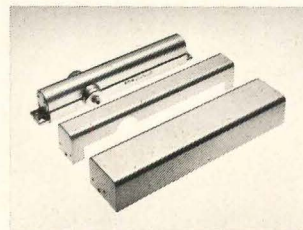

**EATON**  
Security Products  
& Systems



# Plaster in a roll the no problem heavy duty wallcover that covers problem walls ...including concrete block!

Plaster in a Roll™ goes up like wall paper over every conceivable surface including *poured masonry, concrete block, plaster, gypsum board, expanded foam, metal, glass, wood and plastic.*

Easily installed by any wall covering applicator, this unique *gypsum impregnated jute* product bridges small voids, hides blemishes and bumps. An optional *anti-graffiti* protective coating provides a tough, clear, low-gloss finish, highly resistant to most common stains.

If you're involved in renovation or construction in *hospitals, hotels, motels, schools, apartments, public buildings* or any *high traffic area*...if you're looking for *lead paint hazard elimination* or want a one-step process that takes you from a problem to a finished wall...take a look at *Flexi-Wall* covering systems.

We're a one-step time and money saver which can turn your problem walls into a decorator's dream. Specify Flexi-Wall Plaster in a Roll™ wherever you would use Type III heavy duty vinyl wall-covering.

**Call  
(803) 855-0500**

For complete architectural data and swatch book, write Flexi-Wall Systems, P.O. Box 477, Liberty, South Carolina 29657.

(Sweet's Architectural and Interior Design Files #9.13/FI., Spec/Data File, Section 9/Wall Coverings. Means Building Construction Cost Data/Wall Covering Gypsum.)

 **FLEXI-WALL**<sup>®</sup>  
Plaster in a Roll™



# PHILBEN EXACTA 17 MAKES OVER OUTDOOR LIGHTING

Philben, pioneer in outdoor lighting and first to produce integral cast low-profile fixtures with pole mounting, further expands its leadership with new EXACTA 17, the ultimate cut-offinaire fixtures for area/street lighting.

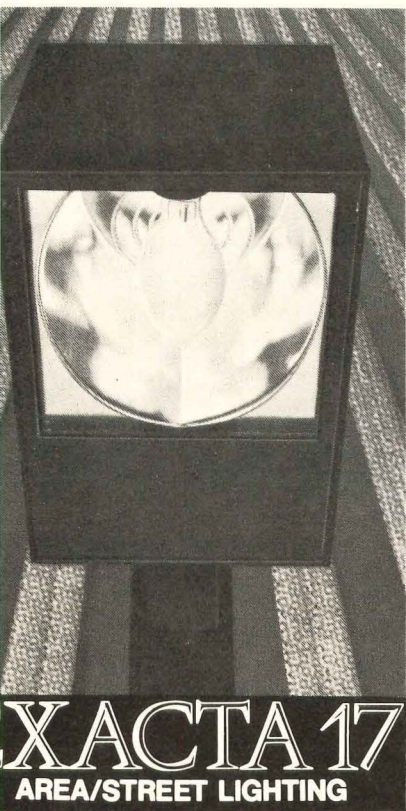

## EXACTA 17 AREA/STREET LIGHTING

**OPTIMUM EFFICIENCY  
EXACT DISTRIBUTION  
GLARELESS PERFORMANCE  
EVERLASTING INTEGRAL  
DIE-CAST CONSTRUCTION  
ULTIMATE IN QUALITY**

Available in 20 sizes, in 20 models utilizing Mercury Vapor, Metal Halide, and High Pressure Sodium light sources ranging from 100 to 1000 watts. The winners—in efficiency, glareless performance, precision optics and everlasting, weatherproof, integral die-cast aluminum construction—with economy.

**Philben®**  
mc PHILBEN LIGHTING  
EMERSON ELECTRIC CO.  
LONG ISLAND EXPRESSWAY/MELVILLE, N.Y. 11746  
CANADA, P.O. BOX 150, MARKHAM, ONTARIO

For more data, circle 76 on inquiry card

### AUTOMATIC DISHWASHERS /



Functional improvements, options for energy conservation and more decorating flexibility are featured in this 1977 line of residential dishwashers. Six undercounter and four portable models are included, all with an adjustable upper rack, new pump impeller and filtering system, and concealed door latch. Each unit is insulated for noise reduction. An optional "dry selector" switch permits the user to air dry dishes without extra heat. ■ Whirlpool Corp., Benton Harbor, Mich.

Circle 307 on inquiry card

### THERMAL WINDOWS /



The "E-series 560" picture window shown is a new addition to this line of insulated glazing. Its "thermal-break" design incorporates a closed-cell vinyl foam insulation to resist shock, racking and twisting, as well as providing noise-deadening qualities. A "zero" air infiltration feature is said to seal the entire window against temperature change, dust and dirt. Fin windows with colonial lines and snap-on exterior box frame trim are available for residential, commercial and institutional construction. ■ Capitol Products Corp., Mechanicsburg, Pa.

Circle 308 on inquiry card

### POOL LIGHTING /



A new line of incandescent lamps is especially designed for use in swimming pool areas. The moisture-resistant lights have a rugged Pyrex envelope and heavy-duty filament construction for shock and vibration resistance. Most of the lamps can operate in any burning position; outputs range from 100 to 500 w. ■ North American Philips Lighting Corp., Hightstown, N.J.

Circle 309 on inquiry card



**OFFICE SEATING /** "CAS Series" chairs feature a short arm and base design for easier maneuverability and good posture support. The frames are cast aluminum alloy available in six colors; seats and backs are finished in a smooth nylon. The line comes in seven models designed for managerial through secretarial functions. ■ Sunar Ltd., Waterloo, Ont.

Circle 310 on inquiry card

more products on page 157

## PARKER RECEPTACLES...

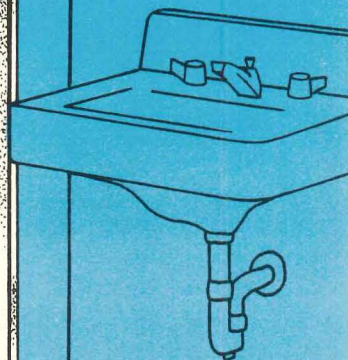
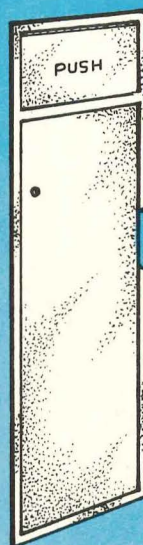

when  
there's  
no  
room  
for  
waste

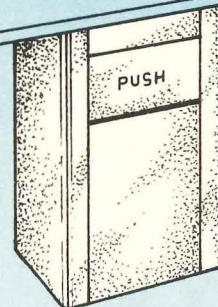
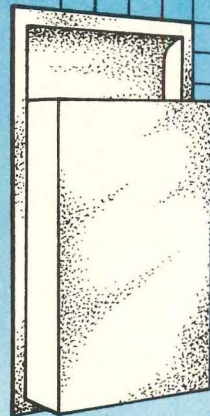

In a washroom where space is at a premium, providing a waste receptacle can be a real problem; but, Parker offers a variety of attractive solutions. The three Parker receptacles shown all supply generous waste capacities while consuming a minimum amount of room. Though diverse in style, all are constructed of durable stainless steel and designed for easy servicing. When you must make the most efficient use possible of limited washroom space, choose a Parker receptacle — you'll really eliminate waste!

 **charles  
parker**

290 PRATT ST., MERIDEN, CONN.

06450



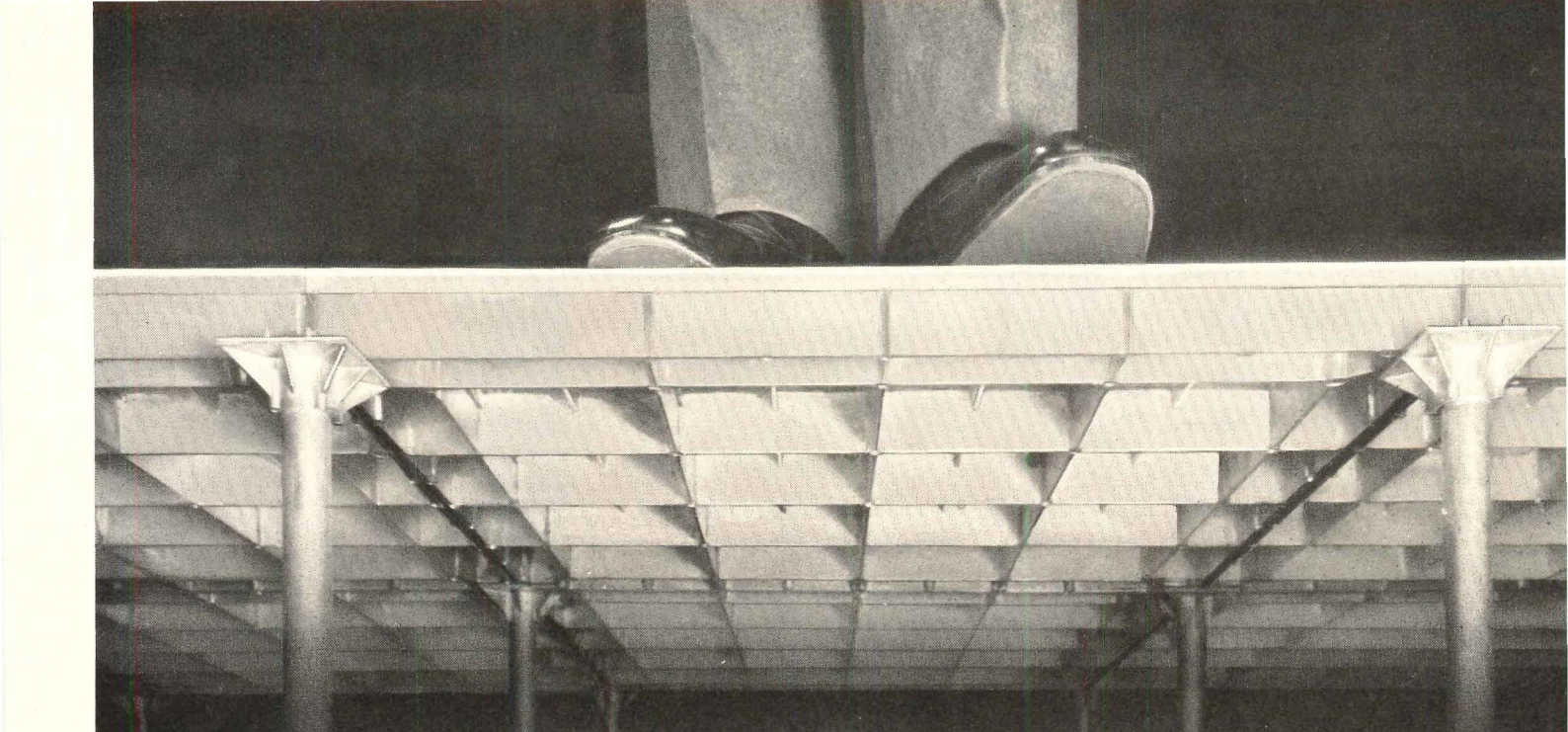

# If you specify any computer floor but aluminum, it's a bad compromise!

Truth is that in 1956 when the need for raised flooring in computer rooms became apparent (with function the chief design criteria) a stringerless floor made up of pedestal mounted die-cast aluminum panels was the choice. That's how the Floating Floor System was developed. Since then, Floating Floors® have been providing trouble-free service in thousands of computer rooms.

Stringerless design makes Floating Floors the only true infinite access floor system. Male and female locking devices, at four corners of each floor panel, provide the highest lateral stability. In fact, Floating Floors meet Federal specifications for seismic zone #3 (San Francisco).

The sad truth is that in order to compete with Floating Floors, other manufacturers have had to promote floor systems of inferior materials and design such as stringer-supported wood and steel. While costing a little less initially, these other floor systems can represent a very bad investment over the long term.

Computer downtime due to electrostatic build-up or magnetic dust may result from one of these wood or steel stringer-supported floors. Costly delays are often caused by the inconvenience of working under stringers, or disassembling and re-assembling them.

Floating Floors on the other hand have proven to be problem-free even after as many as 20 years of service. Monolithic construction with aluminum ensures dissipation of static electricity. And since aluminum is non-magnetic and does not require painting, iron rust and paint flakes are not present to enter the air and interfere with computer operation. Aluminum will not of course, rust, warp or burn.



The Floating Floor system is designed to meet future expansions and changes. Components can be easily changed around since precision die cast and milled aluminum floor panels ensure a uniformity in size (machined to  $\pm .005$  —  $.000$ ) not found in hand assembled products. And there is plenty of strength for the installation of new equipment.

In fact, the overall quality of Floating Floors is so good that we are able to give a FIVE YEAR UNCONDITIONAL GUARANTEE AND BUY-BACK PROGRAM with every floor installed.

For more complete information refer to Floating Floors bulletin 10.27 FL as shown in SWEETS under Specialties — Access Flooring. Call us for assistance.

FLOATING FLOORS, INC.  
6955 Wales Road, Toledo, Ohio 43619  
Tel: (419) 666-8750

IN CANADA: Bruce (EDP) Services Ltd.  
3650 Weston Rd.  
Weston, Ontario  
Tel: (416) 741-0854

*For more data, circle 78 on inquiry card*

## FLOATING FLOORS, INC.

*Available World-wide from Licensees and Distributors •  
Installations Coast to Coast*



**ACUSTICAL PANELS** / The tight curved corner shown is a new addition to this line of interlocking acoustical panels. With a 24-in. radius, the new corner unit is suitable for aisles, exits, and other traffic areas where space

is limited. It has a sound adsorption rating of .55 and is compatible with other components of the "panel" line. ■ Rosemount Partitions, Inc., Roseville, Minn.

Circle 311 on inquiry card

**MOVABLE PANEL WALLS** / Multi-directional movable panels look and perform like fixed partitions when set in place, according to the manufacturer. The "Pathfinder" walls operate in ceiling tracks, which allow panels to navigate freely through T, L, or cross intersections without the use of switching devices or curves. An

operator handle in the edge of each panel lowers it firmly on the floor, at the same time raising a mechanical flange on top of the panel to form an airtight seal with the ceiling track. In-place wall panels have no hanging weight; will not sway with strong drafts; and can be leaned against without damage. The last panel in each series has a lever handle to seal the panel against the adjacent wall, and a handle to create an opposing force to seal all other panels together. Work surfaces—chalkboards, projection screens, shelving, etc.—can be built-in or added-on via slots in the panel edge extrusion. ■ Hough Mfg. Co., Janesville, Wis.

Circle 312 on inquiry card

**CARPETING** / The "Tretford Carpet System," a fusion-bonded carpeting suitable for continuous installation, is now offered in nylon. The Irish-made carpeting is said to be especially suitable for such extreme high-traffic areas as subway cars, airports, supermarkets and schools. The concentric diamond surface, bonded into a PVC sound-insulating underlay, helps hide seams. The carpet may be cut on the surface, as in the escalator bank application shown, and can be fitted around columns or structural elements. ■ Eurotex, Inc., Philadelphia, Pa.

Circle 313 on inquiry card

**GYPSONUM PANELS** / "Custom Granada Cork" is a new addition to the *Textone* line of vinyl-faced gypsum panels for permanent or movable partition requirements. The scuff- and wear-resistant patterns are factory-laminated to fire resistant *Sheetrock*. *Textone Firecode* panels meet Federal specification SS-L-30C, Type 111. Also, "Custom Stippled" (not shown) now comes in four colors—orange, green, yellow and blue. ■ United States Gypsum Co., Chicago, Ill.

Circle 314 on inquiry card  
more products on page 159

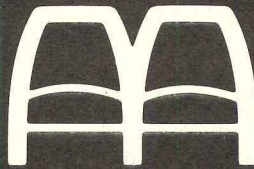

Monroe High School, Monroe, Michigan, and Daverman Associates, Inc., Architects, of Grand Rapids, Michigan, are two of a growing number of professionals who prefer Massey Seating. Primarily because Massey seats are as beautiful as they are durable and comfortable.

For full information, see Sweets Architectural Catalog File 12.5/MA. For the name of your nearest distributor, write or call Massey Seating Company.

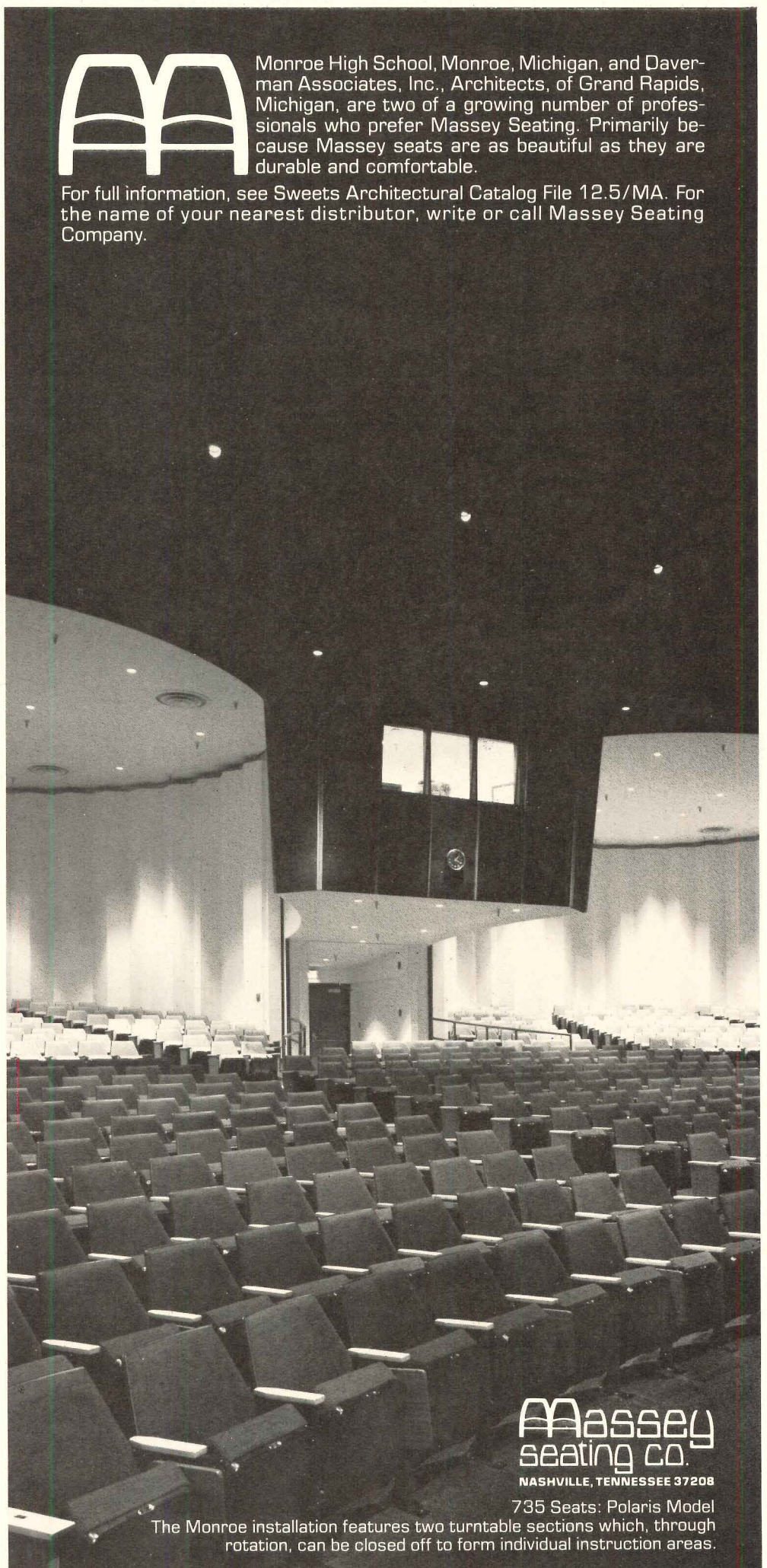

**Massey Seating Co.**  
NASHVILLE, TENNESSEE 37208

735 Seats: Polaris Model  
The Monroe installation features two turntable sections which, through rotation, can be closed off to form individual instruction areas.



# Introducing the CLEANLINE® Sprinkler.

A beautiful way to help save lives.

Now there's a new way to design in fire protection for life safety in modern high rise and other buildings without intruding upon design aesthetics. Grinnell's new CLEANLINE® Recessed sprinkler is so unobtrusive, so trim and compact, once it's installed you'll hardly know it's there.

But don't let CLEANLINE's quiet good looks fool you. Beneath that attractive closure you'll find one of the most reliable sprinkler heads in the industry. When room temperature reaches a predetermined level, the attractive closure falls away,

exposing the *fast-response* Duraspeed sprinkler. As a second predetermined temperature is reached, the sprinkler activates, distributing a uniform water spray to put down a fire.

The standard finishes



available are satin chrome and white. CLEANLINE Sprinklers are also offered in a variety of finishes to match any decor. All metallic finishes are UL-listed.

There's a lot more to tell about CLEANLINE. For more information and complete specifications, call your nearest Grinnell district office listed in the Yellow Pages, or write Grinnell Fire Protection Systems Company, Inc., 10 Dorrance Street, Providence, Rhode Island 02903.



**GRINNELL**  
GRINNELL FIRE PROTECTION SYSTEMS COMPANY, INC.

PROTECTING LIFE AND PROPERTY SINCE 1850.

For more data, circle 80 on inquiry card



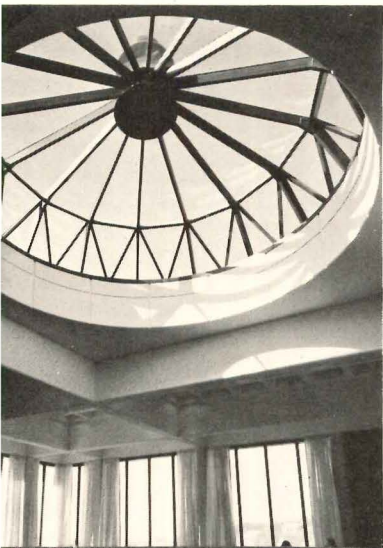

# Wasco Makes Excellent GLASS Skylights Too!

That's right, Wasco does make flat glazed skylights and Wasco will work with you to develop specifications, drawings and costs. Your needs and requirements are important to Wasco. You can trust them to perform.

Wasco Products, Inc. is the well known leader in acrylic Skydomes and is working with O'Keeffe's Inc. for over fifty three years of combined daylighting experience. So whether you are interested in acrylic skylights, flat acrylic or domed acrylic skylights Wasco wants to help. No project is too small or too complex to get Wasco's prompt attention and for you to get a fair price. For further information, case histories, or design assistance write.



P.O. Box 351, Sanford, Maine 04073  
Tel. 207-324-8060

For more data, circle 81 on inquiry card

## STRIP LIGHTING / "Counterpoint" uses standard

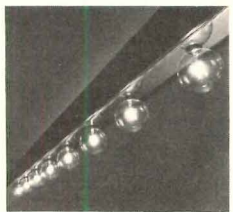

lighting components to produce highly individual strip lighting effects, according to the manufacturer. Single- or continuous-mounting uses standard 90 deg inside and outside corners for lighting patterns. The decorative

closure, in mirror chrome, gold, black or white finishes, snaps into the extruded aluminum housing. Standard units come in lengths up to 96-in., and widths of 2½-, 5-, 12-, and 24-in. Clear or colored lamps are available on 4- or 6-in. centers. ■ Neo-Ray Lighting Systems, Inc., Brooklyn, N.Y.

Circle 315 on inquiry card

## SPIRAL STAIRCASES / A competitive price is

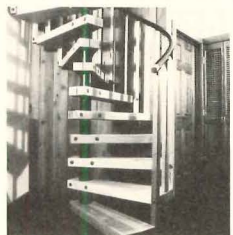

claimed for this line of wood spiral staircases. The treads are made of 3-in.-thick split hardwood that resists loosening; wooden balusters are 2-in.-thick. The installation shown is one of 45 produced for a condominium

development in Vail, Colorado. ■ Scott Douglas Design Inc., Gulfport, Fla.

Circle 316 on inquiry card

## SIGNAGE SYSTEM / Combining words and graphics



for fast recognition, this pictographic signage system uses individual 6½- by 6½-in. plaques. These signs, said to be both tough and lightweight, can provide a uniform method of identification throughout a variety of buildings, and include both general information and special subject signage. Standard colors are white against dark brown, with custom colors available. ■ The Letter Factory, Minneapolis, Minn.

Circle 317 on inquiry card



**MULTI-MEDIA CARRELS / "4-Plex"** is one of a series of student study carrels available in trapezoidal, round or rectangular configurations. All panels are interchangeable and can accommodate such audio-visual equipment as slide projectors with integral rear-projection systems; synchronized cassette players; 8- and 35-mm projectors; and TV receivers and players. Plastic laminate panels can be surfaced with acoustical carpeting, chalkboard, pegboard, etc. ■ Monroe Industries, Inc., Wichita, Kan.

Circle 318 on inquiry card

more products on page 161

# Hastings CHECKER BLOCK®

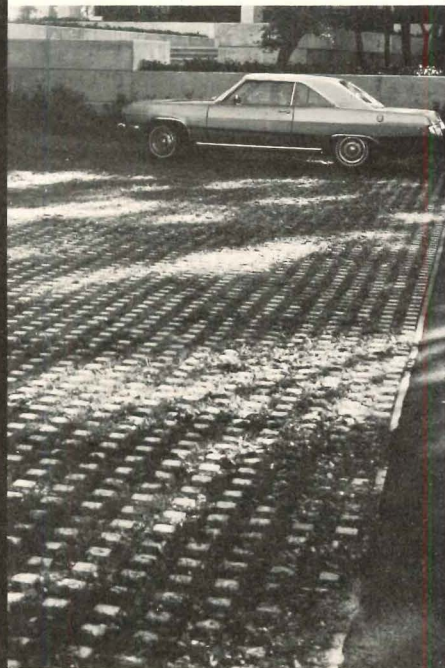

## ...Paves with Grass.

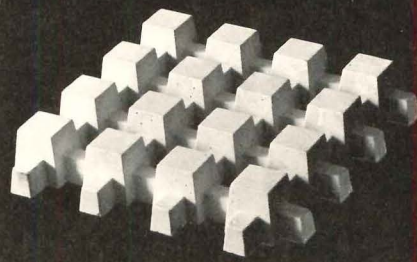

Hastings Checker Block provides the solution to the problem of overflow parking, emergency vehicle and service roads where a grass surface is preferred.

Projects from Maine to California have used Checker Block because they are manufactured as close to each jobsite as possible.

Each paver is 24"x24"x4," reinforced with 8" gauge wire and has a minimum 5,000 psi. Checker Block offers an environmental advantage because they offer the highest ratio of grass to concrete of any similar material, permitting water to be returned to the earth. For descriptive literature, write Hastings, 410 Lakeville Road, Lake Success, N.Y. 11040.



For more data, circle 82 on inquiry card



Another Paddock First

# A SURGE CONTROL RECIRCULATION SYSTEM THAT WORKS AUTOMATICALLY AND INSTANTANEOUSLY

## Revolutionary New System Activated By Number of Swimmers and Type of Activity

The Paddock SCRS® Perimeter System responds automatically to dynamic impulses activated by the swimmers in the pool. The following recirculation phases are maintained continuously and automatically for the life of the pool:

- Pool water level to provide a constant minimum flow rate from pool surface at all times.
- Surge weirs that open and close as use dictates to provide instantaneous "in-pool" surge capacity when required.
- Action of main drain for most efficient channel flow.
- Increase or decrease recirculation rate to prevent gutter overflow.
- Push button water level control for competitive swimming.

In addition to automatic control, the Paddock SCRS System also provides surge containment capacity and flow rates up to 3,000 gallons per minute right in the pool wall.

Check out Paddock's new surge control recirculation system for new construction or renovation today. It offers untold economies and efficiencies now and for the life of the pool. Write Vice President, Marketing; Paddock Pool Equipment Company, Inc., P.O. Box 511, Rock Hill, So. Carolina 29730.

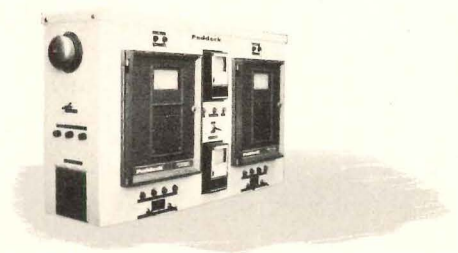
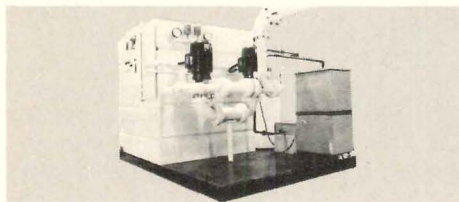

▲ Paddock's Hydro-Analyzer automatically controls pH level and chlorine residual in your pool and saves you thousands of dollars annually.

◀ Paddock can supply the total Mechanical Package—skid mounted and pre-wired—eliminates field errors.

**Paddock**  
OF CALIFORNIA, INC.

For more data, circle 83 on inquiry card

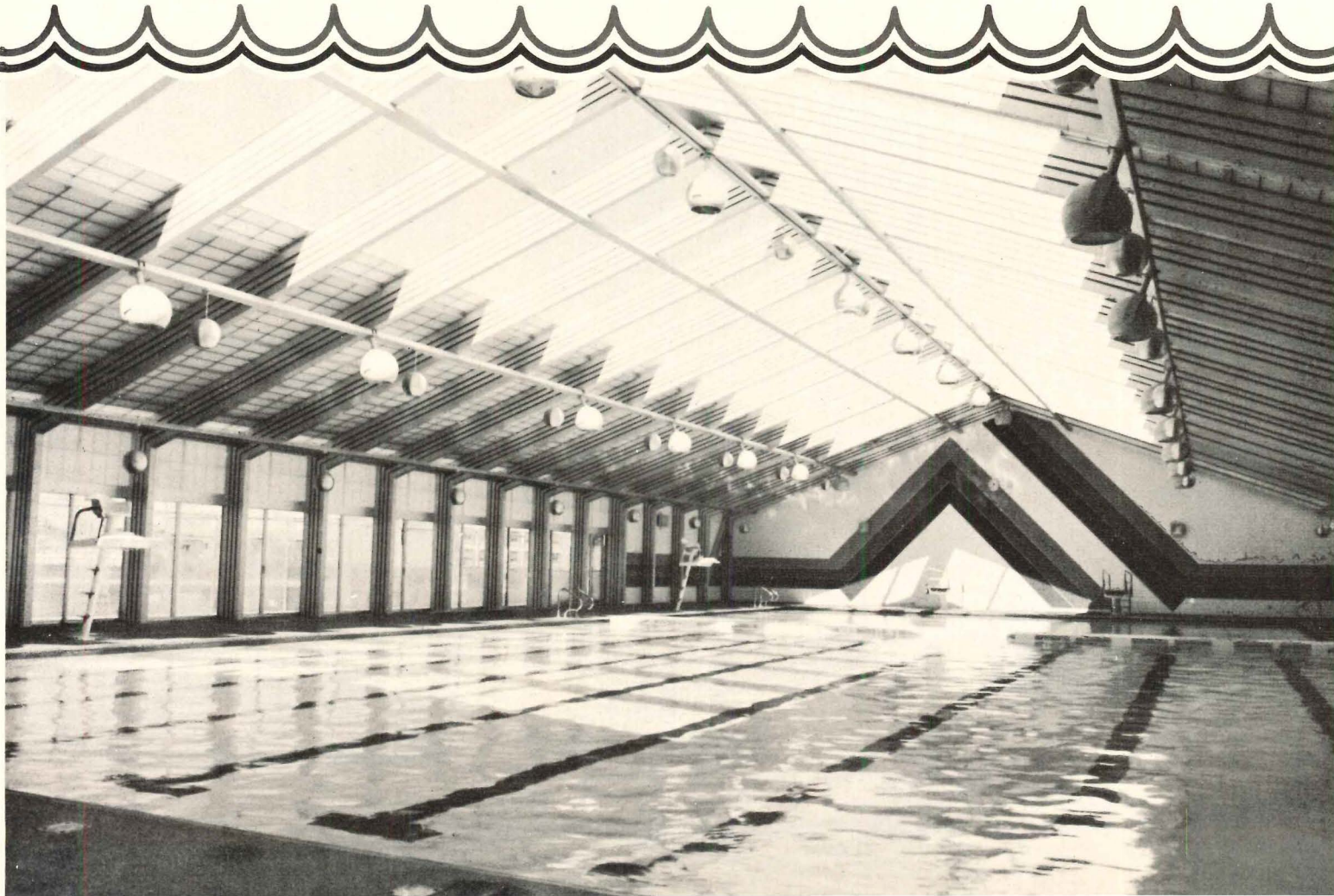



**When you want a small package delivered fast, it's in the bag.**



Delta's DASH guarantees delivery on the flight or routing you specify between all Delta cities and most cities served by other airlines through interline agreements. Packages accepted up to 50 lbs. with length plus width plus height not to exceed 90."

Call Delta for an expedited pick-up, or bring your package to Delta's passenger counter at least 30 minutes before scheduled departure time (or to the air cargo terminal at the airport 60 minutes before schedule departure time). The package can be picked up at the DASH Claim Area next to the airport baggage claim area 30 minutes after flight arrival at destination. Or we deliver it at an additional charge.

Delta reservations can give actual DASH charges between specific points. You may pay by cash, company check, most general-purpose credit cards, special credit arrangement or, on government shipments, by GBL.



Rate examples	(Tax included)
Atlanta-Washington . . . . .	\$21.00
Boston-Miami . . . . .	26.25
Los Angeles-New Orleans . . .	31.50
Dallas/Ft. Worth-	
Los Angeles . . . . .	26.25
San Francisco-Atlanta . . . .	31.50
Philadelphia-Houston . . . . .	26.25
New York-Tampa . . . . .	26.25
Chicago-Orlando . . . . .	26.25
Detroit-Memphis . . . . .	21.00

For full details, call Delta reservations.

For expedited pick-up and delivery at extra charge, call 1-800-424-1092 toll free anywhere in the Delta system. In Washington, D.C. call 466-3131.

**Delta is ready when you are.®**

For more data, circle 84 on inquiry card

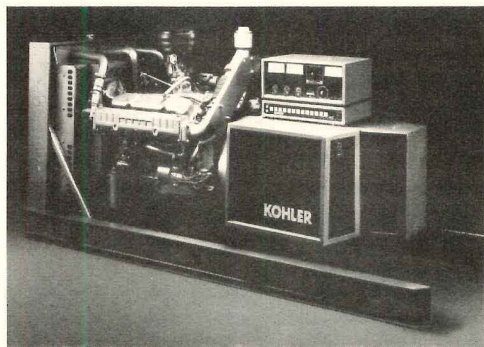

**STANDBY POWER** / The new "Fast Response" power systems, ranging from 30- to 250-kW capacity, are said to have a recovery time of 0.05 second or less from load transients. These generators also have an increased short circuit capability: under such conditions, the current output initially reaches as high as 1000 per cent of rated current, and is able to sustain 300 to 500 per cent capacity. This high amperage trips breakers connected to the short, permitting quick return of power to unaffected circuits. The generator is described as having no voltage collapse point. A standard programmable electronic controller, the "Decision Maker," governs instrumentation and fault lamps for all units in the line. ■ Kohler Co., Kohler, Wis.

Circle 319 on inquiry card



**WASTE TREATMENT** / Pictured is a 50,000 gallon-per-day capacity physical/chemical process packaged waste treatment system now in use in Florida. The highly-automated installation processes domestic wastewater to produce an effluent meeting EPA standards. It is not affected by toxic substances in the sewage, making the "Package Waste Treatment System" suitable for marinas, recreational vehicle dumping stations, airports, etc., as well as the typical apartment development. A 100,000-gpd model is also available; units can be combined into larger systems to process any desired volume of wastewater. The power required is 230 VAC, 60 Hz, 3 phase; necessary chemicals are said to be readily available. ■ General Electric Co., Re-entry and Environmental Systems Div., Philadelphia, Pa.

Circle 320 on inquiry card

**ICE MAKER** / A compact mini-cube ice maker designed for low-volume requirements, model "SC70-30" can be put in a space 18½ in. (47.0 cm) wide and 25½ in. (64.8 cm) deep. Its height is 38 in. (96.5 cm) without legs. The unit can produce 70 lbs (30 kg) of small, 11-sided cubes in 24 hours and stores up to 30 lbs. (13 kg.) ■ Liquid Carbonic Corp., Chicago, Ill.

Circle 321 on inquiry card

more products on page 163

# THE Stemwinder

NEWS AND VIEWS ON HARDWOODS AND VENEERS



Richard K. Stem  
President

Chester B. Stem  
Incorporated

## ESCAPE FROM THE ORDINARY — WALL PANELING

When you're looking for something dark in wall paneling veneer, but don't want what everyone else is using, give some thought to BENGÉ. It has a dark grain with a deep golden background that is available either quartered or flat sliced. When quarter cut, it produces a marvelous figure. We have a strong inventory. Ask for a sample.

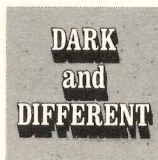

"Bee's Wings" is the figure revealed by a quarter cut of exotic NARRA. We'd be delighted to send you a hand sample.

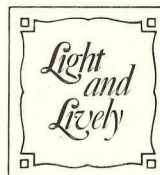

AVODIRE is an African wood that was once very, very popular—but never common. It is highly figured with a lively grain over a light background. Most of our inventory is quarter cut and lends itself to most designs of today. It would grace any feature wall with its golden color.



**FLITCH SPECIFICATION.** There may be times when simply specifying stock wall paneling is inadequate—times when you wish to more precisely express your own individual taste. The flitch specification process—plus Stem's bold inventory of woods—allows you to do just that. You handpick the veneer that best meets your aesthetic criteria for color and grain patterns. We welcome your inquiry.



Chester B. Stem, Inc.,  
2704 Grant Line Road,  
New Albany, Indiana  
47150. Manufacturers  
and importers, sliced  
wood and lumber.  
Fifteen minutes from  
Louisville, Ky. airport.  
Phone (812) 945-6646.



**STEM**  
EMINENCE IN WOOD

**Let's face it: only wood is wood.**





## Economical steel joists provided flexibility in installing mechanical, electrical and telephone systems for Mission State Bank.

For the Mission State Bank, Mission, Kansas, economy and flexibility were just two of many good reasons for selecting steel joists. Steel joists also facilitated installation of the bank's versatile bronze glass curtain wall. Erection during the winter months was made easier by the use of steel joists.

The attractive five-story bank used H-Series joists, mostly 16 and 18 inches deep. The general contractor was John M. Fogel Construction Company. The Architect was William M. Conrad, A.I.A., of Team 1—Architects, Engineers, Planners. The steel fabricator was The Bratton Corporation.

Aside from economy, flexibility and ease of installation, steel joists aid fast occupancy and design flexibility in construction.

Send for Specifications and Load Tables for Open Web Steel Joists, Longspan Joists and Deep Longspan Joists.

STANDARD SPECIFICATIONS and LOAD TABLES

OPEN WEB STEEL JOISTS    J Series    H Series

LONGSPAN STEEL JOISTS    LJ Series    LH Series

DEEP LONGSPAN STEEL JOISTS    DLJ Series    DLH Series

85

**STEEL JOIST INSTITUTE**  
2001 Jefferson Davis Hwy.  
Arlington, Virginia 22202

Mail to:  
STEEL JOIST INSTITUTE  
7th Floor, 2001 Jefferson Davis Hwy.  
Arlington, Va. 22202

Please send me your new copy of Specifications and Load Tables.

NAME \_\_\_\_\_

TITLE \_\_\_\_\_

FIRM \_\_\_\_\_

ADDRESS \_\_\_\_\_

CITY \_\_\_\_\_ STATE \_\_\_\_\_ ZIP \_\_\_\_\_

For more data, circle 85 on inquiry card

75005



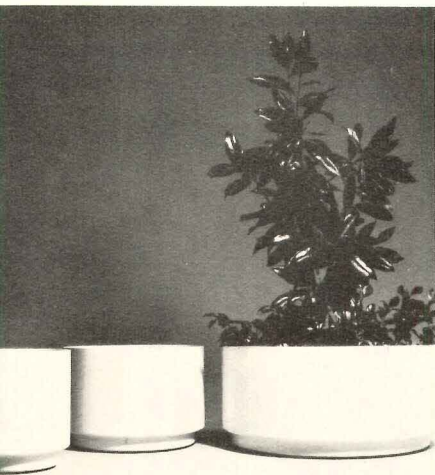

**PLANTERS** / A series of three round plastic planters, coming in sizes from 7½ to 12¾-in. in diameter are topped with casters. ■ Beyerlian Ltd., New York

*Circle 322 on inquiry card*



**SAFETY RAILING** / A prefabricated railing system for outside or inside commercial and institutional crowd-control safety applications is made of precision-formed sheet metal components fabricated together quickly. Horizontal rails are 2 by 2½ and stocked in sizes 42 to 120 in. long. Posts are 3 by 3 by 42 in. high. ■ Equipto, Aurora, Ill.

*Circle 323 on inquiry card*



**LIGHTING/CEILING SYSTEMS** / The company offers distinct lighting/ceiling systems with replaceable and interchangeable modular suspension components. The "Vaulted Linear" (VL60), "Vaulted Directional" (VN60), and "Flat Linear" (FL60) are the same basic 5-ft sq ceiling planning module. Each module can be rotated 90 degrees and is designed to accommodate its own lighting, partitioning, acoustics, air distribution, sprinkler penetration and easy access. Unlighted modular choices are available. ■ Conwed Corp., St. Paul, Minn.

*Circle 324 on inquiry card*

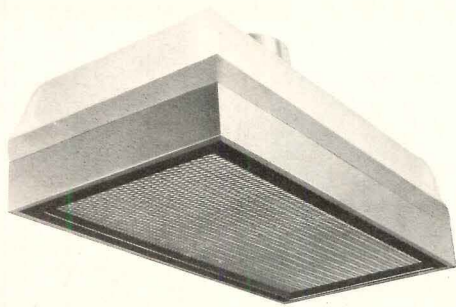

**CEILING MODULE** / A high-efficiency filter unit for clean room applications is capable of delivering up to 99.99 per cent efficiency in the sub-micron particulate size range and true laminar air flow characteristics, meeting or exceeding requirements for Class 100 clean rooms in engineered system installations. ■ Comp-Aire Systems Inc., Grand Rapids, Mich.

*Circle 325 on inquiry card*



**MINI WAREHOUSES** / A building system for construction of mini warehouses is available in standard 5-ft width increments from 20 ft to 35 ft spans. The buildings feature metal roofing with ¼-in. per ft slope. Eave heights up to 16 ft are a standard feature and integrated wall panels are offered in various color options. ■ Butler Mfg. Co., Kansas City, Mo.

*Circle 326 on inquiry card*

# pre-engineered or custom steel doors, frames---and hardware---all from one well-stocked local source.

Good news, because it means you can be flexible in your door and frame design without causing headaches on down the line. Curries Distributors are complete distributors. They carry almost everything required to fill an opening in the wall.

In addition to pre-engineered steel doors and frames of nearly every size, face width and jamb depth, they can also supply custom made doors and frames.

They carry finish hardware, too. They have fabrication shops. And, because they are stocking distributors (with a major manufacturer behind them) they can deliver material on time.

For details on our doors and frames, call your local Curries Distributor. He's in the Yellow Pages under "Doors" or "Doors-Metal".

*Or see Sweets/8.2.*

*Or write: Curries Manufacturing, Inc., 251 9th St. S.E., Mason City, IA 50401. (515) 423-1334.*



*For more data, circle 86 on inquiry card*



## Shock - absorbing Acrovyn® Handrails

**Look like a million.  
Wear like iron.  
Cost less than wood.**

Cut maintenance costs with vinyl-acrylic handrails. Installed on a free-floating aluminum retainer system, they shrug off impacts that would seriously damage unprotected walls. Easily-cleaned HRB-2 and HRB-4 are available in 7 integral colors.

Write for your Acrovyn Handrail Catalog today.



**CONSTRUCTION SPECIALTIES, INC.**

P.O. Box 380, Route 405, Muncy, PA. 17756 (717) 546-5941  
725 Twin Oaks Valley Rd., San Marcos, CA. 92069 (714) 744-0300

For more data, circle 87 on inquiry card

 **MONIER**  
ROOF TILE

### AMERICA'S MOST SENSIBLE ROOF

Economical • Colorful • Durable  
Incombustible • Easy to Install  
Prompt Delivery Nationwide

For further information, write to:  
MONIER-RAYMOND CO., P.O. BOX 158, Corona, CA 91720

For more data, circle 88 on inquiry card

## NO-SEAM WALLS<sup>®</sup> mean easier cleaning

### New King Size Glasbord® frp paneling eliminates seams

...seams that catch dirt, break open, cause refrigeration loss, deteriorate. Rooms under 9 ft. high can now have seamless walls — *no seams* — curb to ceiling or corner to corner. There are *no seams* to fail, *no seams* to harbor bacteria. Walls can be cleaned quickly and easily by ordinary methods. Material is accepted by U.S.D.A. and meets applicable requirements of F.D.A.

Glasbord paneling is a tough, durable fiber glass reinforced plastic (frp) wall lining. It will not dent like metal or chip and flake like paint. The hard, embossed surface resists scratches and abrasion. It stands up to impacts encountered in daily plant operations. Panels are available 3/32", 1/8", and 3/16" thick and in sizes up to 8'-4" wide by 40' or more long.

Get the full story on no-seam walls today.

Write for sample and literature.

**kemlite**<sup>®</sup>

**KEMLITE CORPORATION**  
P. O. Box 429, Joliet, Illinois 60434

For more data, circle 89 on inquiry card

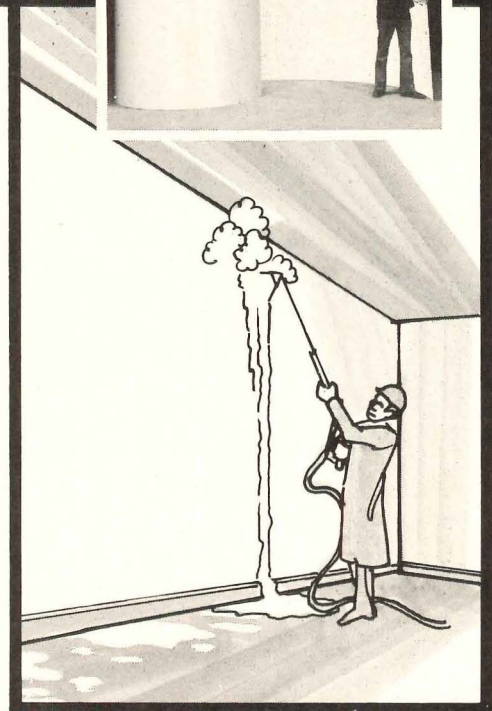
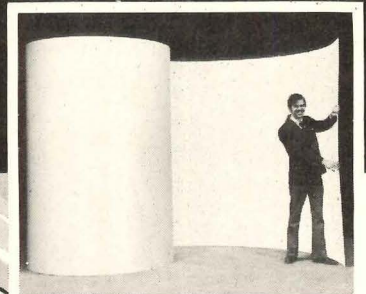



# Sooner or later, everyone needs an extra hand.



Think about it. Next time you approach a building door with your arms full, think what you go through, just to *get* through. Think how often it happens to you. To everybody.

Then think about how a Stanley Automatic Entrance is indeed a helping hand. How it keeps traffic moving. Enhances the look of the building. Makes things just a little bit easier for the people who use your building.



The Stanley Magic-Door® people — who originated the whole idea of automatic entrances some forty-five years ago — are ready to give you a hand on your next project. Just ask. Stanley Door Operating Equipment, Division of The Stanley Works, Farmington, Connecticut 06032.

**STANLEY**  
helps you do things right

For more data, circle 90 on inquiry card







FORMICA PRESENTS

INFINITY

## The broadest line in the laminate industry!

Now, Formica brings you an infinity of choices—to give you the breadth and depth you need!

New clear, vital solid colors. Patterns and woodgrains that mirror nature itself. So much that's new—so many options—that you'll find just what you want for every commercial and residential need. And we have it all.

Formica's Design Center—unique in

the laminate industry—has worked closely with customers, architects, designers and the Color Marketing Group to insure that each design *will* fill a need. Not just today, but tomorrow as well!

This infinity of choices is readily available through your Formica Distributor. Why not contact him now. He'll gladly show you the broadest line in the laminate industry.





# Lifetime Stainless Steel that Won't Chip, Pit or Ru

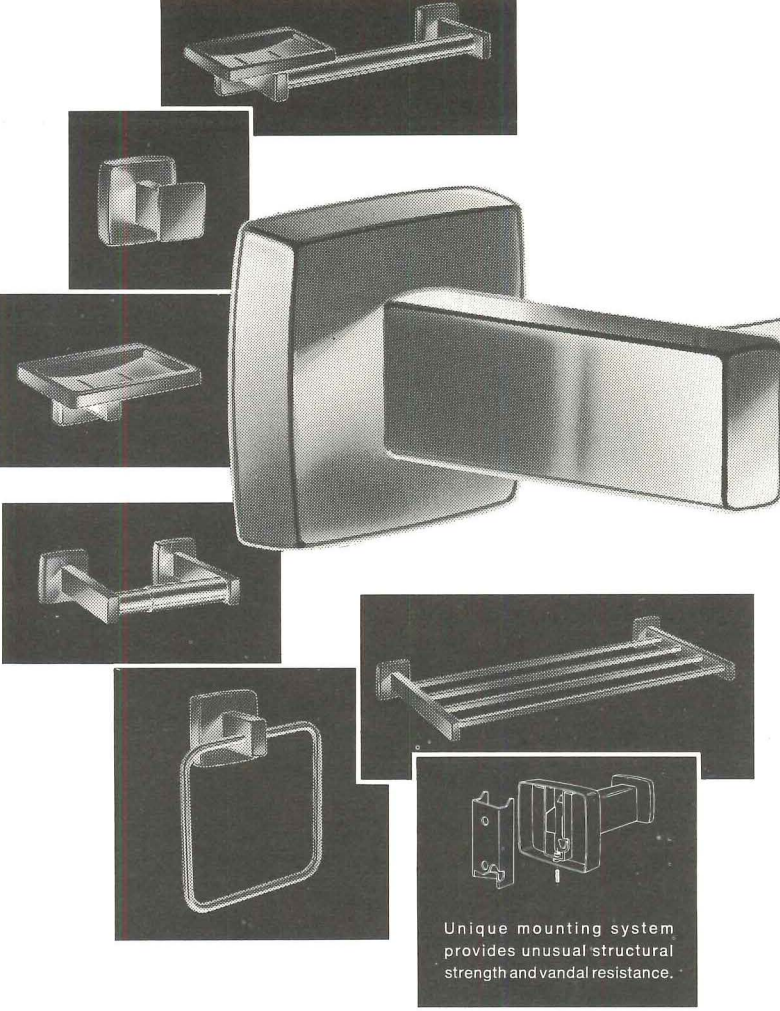

**Bobrick's New Distinctively Styled Bathroom Accessories**  
... thirteen models of 300 series stainless steel. Will retain original beauty for a building's lifetime.

**Satin or Bright Polished Finishes** to harmonize with modern decor in new hospitals, hotels and institutions.

For additional information write Bobrick Architectural Service Dept., 101 Park Ave., New York 10017. Bobrick products are sold internationally.

Unique mounting system provides unusual structural strength and vandal resistance.

# bobrick

For more data, circle 92 on inquiry card

## See these "must" brochures on Bali-Architect window blinds



Copy of Sweet's insert (Architectural, Interior Design files) fully detailed



Shows new concept custom mixing or matching several colors in same blind



Write for your free copies of both

**marathon carey - mcfall company**

Division of Marathon Manufacturing Company  
2156 E. Dauphin St. • Philadelphia, PA 19125

For more data, circle 93 on inquiry card

## Elegance in home refrigeration

**BUILT-IN TO BLEND-IN**  
All units built to 24" kitchen counter depth to fit flush with cabinets \* Front & side panels to match your decor \* Units will accept wood, glass, metal, leather, plastics ... or use your imagination \* 24", 30", 36", & 48" wide models \* Largest capacity home units manufactured \* All refrigerator, all freezer or combination models \* "Over-n-under" or "side-by-side" units \* Built-in ice makers \* Superb workmanship and individually factory tested for total performance.

**SUB-ZERO**

Now Available in Canada

Send for free colorful brochure on unique kitchens:  
SUB-ZERO FREEZER CO.,  
Box 4130, Madison, Wisconsin 53711



For more data, circle 94 on inquiry card



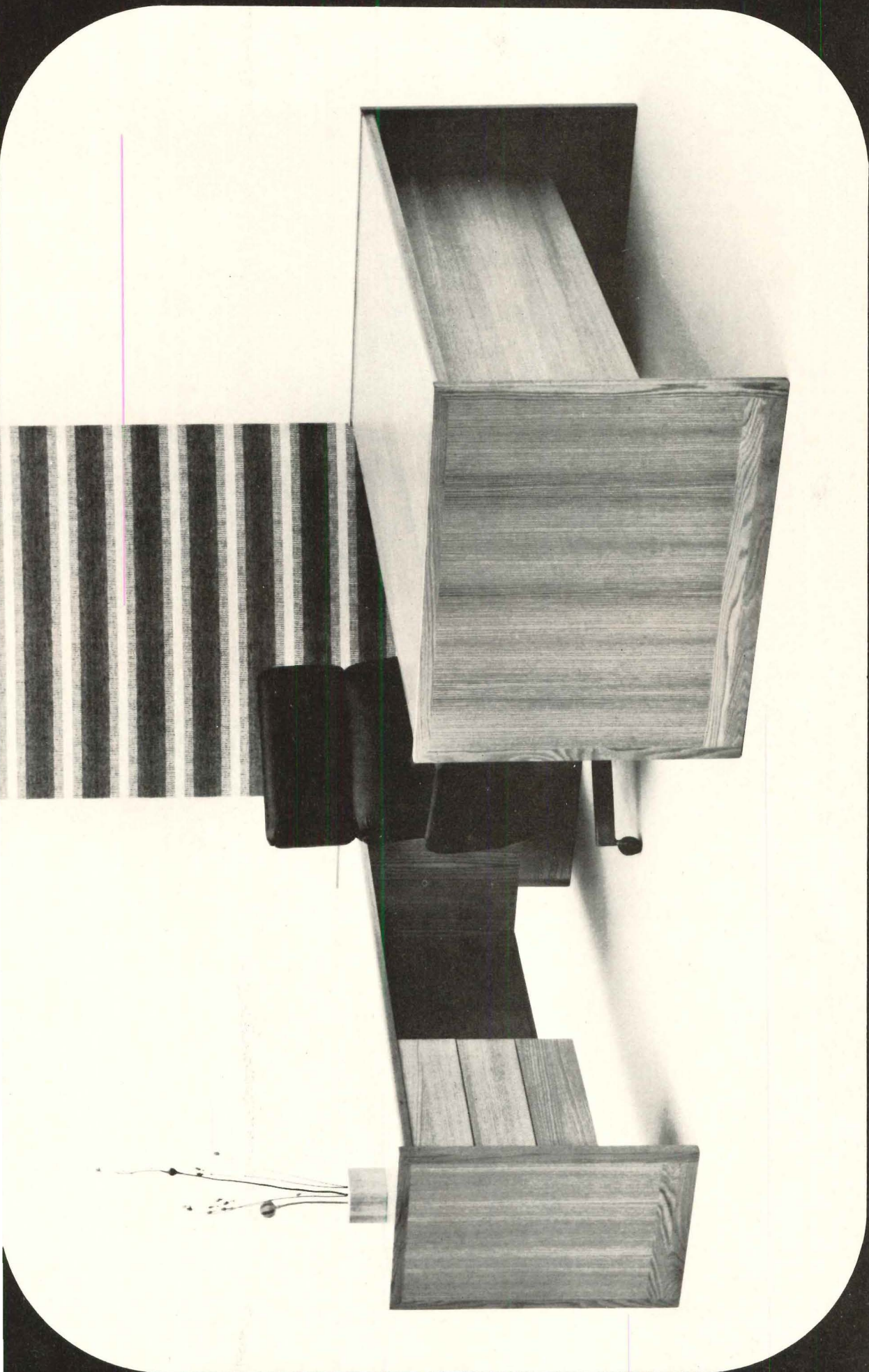

**RECENT BANK INSTALLATIONS**

First National Bank of Mobile  
Mobile, Alabama  
East Idaho Federal Credit Union  
Idaho Falls, South Dakota  
Iowa — D M National Bank  
Des Moines, Iowa  
Citizens State Bank  
Brainerd, Minnesota

American National Bank  
St. Paul, Minnesota  
First National Bank & Trust Co.  
Lincoln, Nebraska  
Merchants Bank  
Buffalo, New York  
Guarantee Bank  
Dallas, Texas  
The Valley Bank  
Oshkosh, Wisconsin

showrooms...chicago 312-944-6958 dallas 214-651-1387 new york 212-675-7030 san francisco 415-621-0159 atlanta 404-876-4448 tampa 813-251-3701 miami 305-757-0659

**buckstaff®**

oshkosh, wi 54901  
414-235-5890

*For more data, circle 95 on inquiry card*



## A howling success at securing exits

Nobody makes the same mistake twice when emergency exits are guarded by Detex Exit Control Locks. Let an unauthorized person misuse the door and all bedlam breaks loose.

Can't say we didn't warn him. When the clearly marked panic bar is pushed, two loud battery-powered horns erupt and a unique dead-locking latchbolt releases to allow exit. Available with 2 or 4 lock/unlock control modes.



PUSH TO OPEN - ALARM WILL SOUND  
New ecl-2200



EMERGENCY EXIT ONLY  
PUSH HERE  
ALARM WILL SOUND  
ECL-230—for heavy-duty deterrent in isolated areas

# DETEX

4147 Ravenswood Ave., Chicago, Ill. 60613

For more data, circle 96 on inquiry card

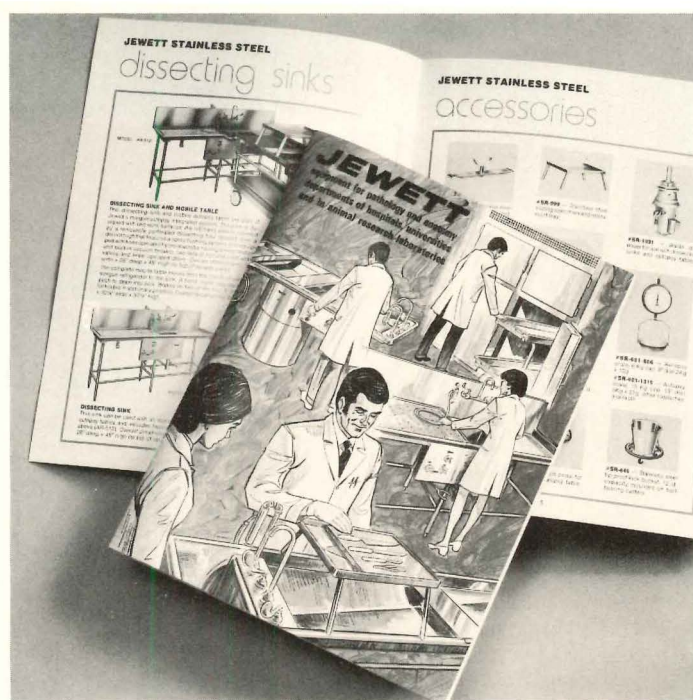

## Jewett offers morgue/autopsy planning service

Whether you are planning a new morgue/autopsy facility or modernizing and equipping present facilities, Jewett specialists provide expert design counseling. Jewett will analyze your requirements with you and your architect or consultant and will send you plans of the complete layout including equipment specifications. Jewett's morgue/autopsy planning services can save you time and costly mistakes. Your new construction or renovation project will not only be right for your current needs, it will also allow for future growth. Send for 16 page equipment catalog.



For more data, circle 97 on inquiry card

# ponded water is for fish.

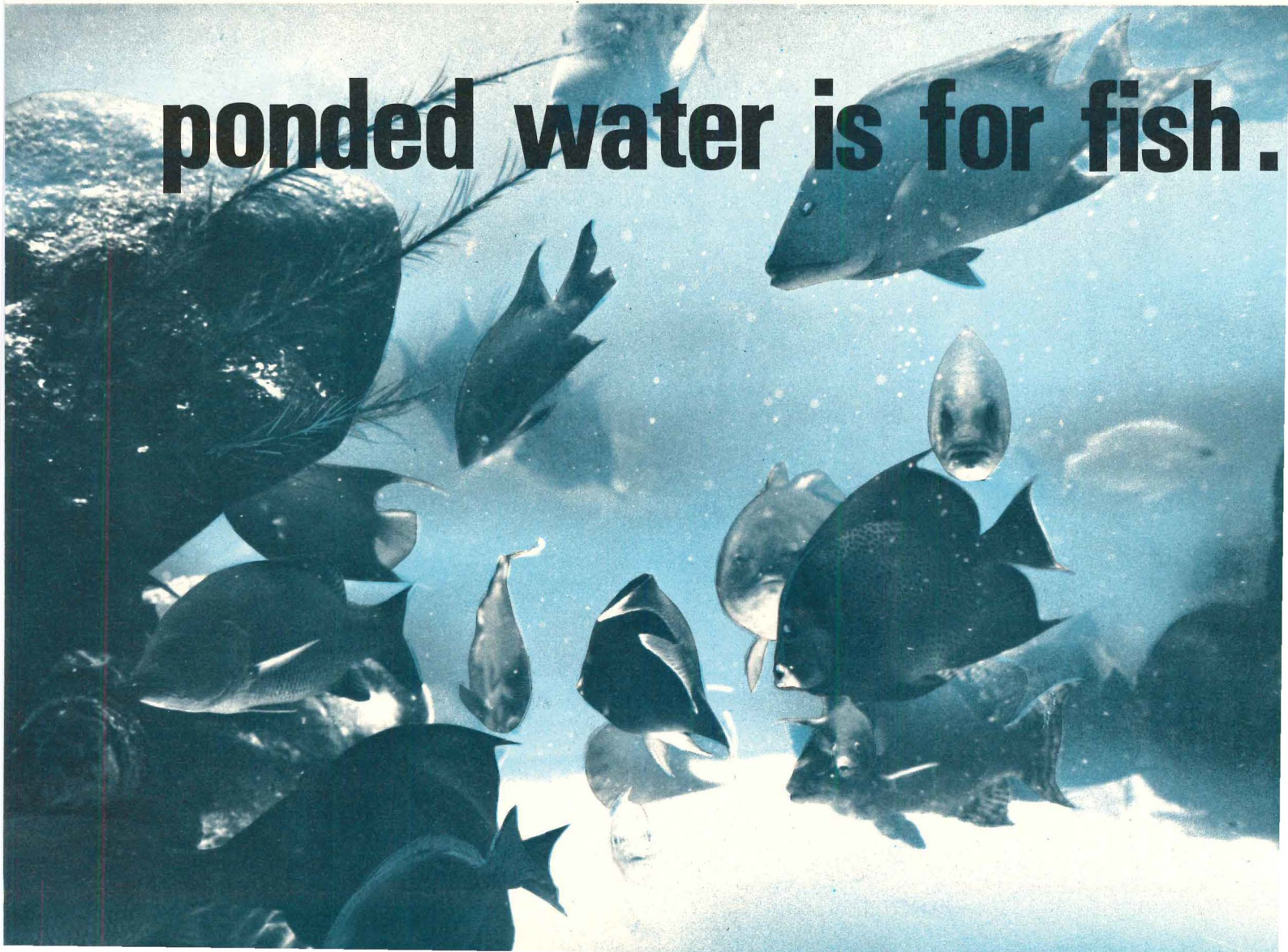



# Don't Let Your Clients Accept Substitute Docklevelers

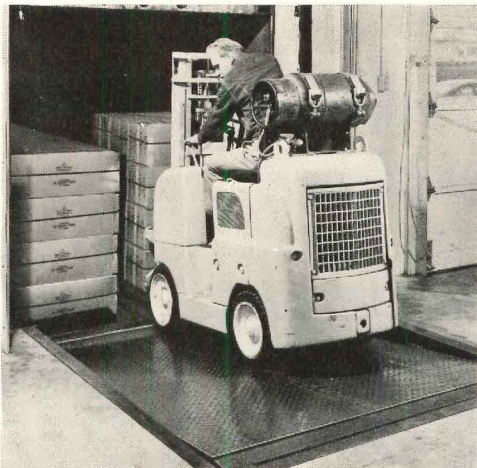

With today's high labor costs and safety emphasis you design loading docks to include permanent docklevelers. Facts prove they can easily pay for themselves in one year.

However, to assure maximum return on investment, specify genuine Kelley Docklevelers of the right type, size and capacity.

Docklevelers with patented automatic safety features and a predictable life span to stand-up

to high volume use year-after-year. Choose hydraulic or mechanical, standard heavy duty or extra-heavy duty models. Kelley Docklevelers cost about the same, or even less. So there's no reason to accept substitutes. Get the complete facts from your Kelley Representative or contact:

**Kelley Company, Inc.**  
6768 North Teutonia Avenue  
Milwaukee, Wisconsin 53209  
Phone: (414) 352-1000



For more data, circle 99 on inquiry card

55-767

# ...not roof decks!

of the most devastating elements contributing to roof membrane deterioration is ponded water. A positive slope to drains is the most effective means of solving this problem — no man-made mechanical device — just non-failing gravity! All-weather Crete sloped to drains is the answer. This unique insulation not only offers a completely new deck application with excellent thermal protection, but it's ability to be contoured can provide positive slope to drains. Why "fish around" for insulations that only insulate? Use the one that also helps increase roof life, can be applied for thermal protection and sloped to drains. All-weather Crete! Silbrico Corporation, 100 River Road, Hodgkins, Illinois 60525, Phone (312) 735-3322.

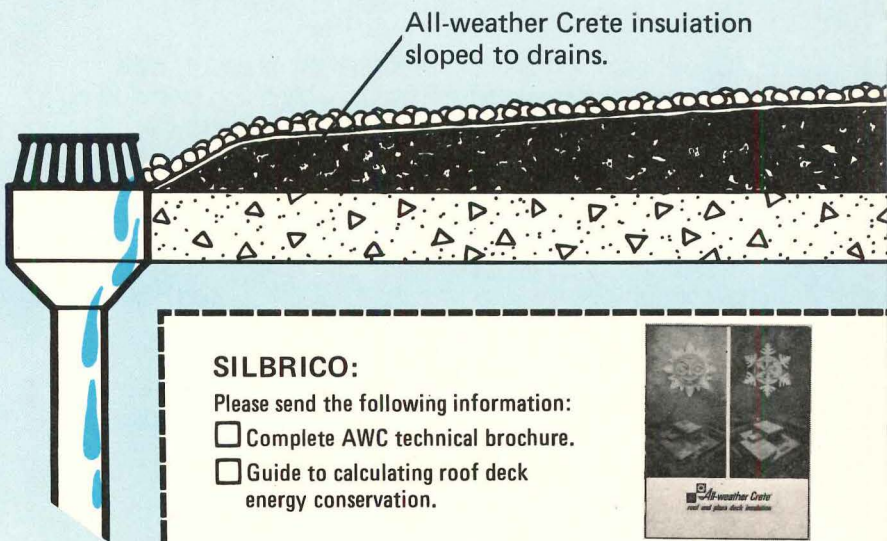

## SILBRICO:

Please send the following information:

- Complete AWC technical brochure.
- Guide to calculating roof deck energy conservation.



Name \_\_\_\_\_ Title \_\_\_\_\_  
Company \_\_\_\_\_  
Address \_\_\_\_\_  
City \_\_\_\_\_ State \_\_\_\_\_ Zip \_\_\_\_\_

 **All-weather Crete®**  
ROOF AND PLAZA DECK INSULATION

 **SILBRICO**  
CORPORATION



# Seal out moisture, dirt and stains.

# Seal in beauty.

# Protect the terrazzo and tile floors you specify with Hillyard Onex-Seal II®.



Onex-Seal II will penetrate and fill the pores. It helps prevent the rising of efflorescence, bleeding and dusting. It brightens the natural colors of the tile. Keeps them bright and true.

Onex-Seal II leaves a hard, high-gloss, non-flaking, non-tracking, mirror-type finish. It resists traffic wear. Onex-Seal II is the type of seal recommended by the National Terrazzo and Mosaic Association. You can have confidence in it.

What's more, floors finished with Onex-Seal II are easy to maintain. Dust daily and buff periodically. Custodians

may refinish after thorough cleaning, without stripping because Onex-Seal II won't "build-up". Reapplication of Onex-Seal II bonds to the old seal to become one integral film. This adds up to a substantial savings in labor costs.

Onex-Seal II is U/L classified as to slip resistance. When you specify terrazzo and tile floors, be certain to give them the best chance for a long and beautiful life. Recommend Onex-Seal II.

A trained Hillyard representative will provide you with full details. Or look up our specifications manual in SWEET'S.



## Hillyard

**FLOOR TREATMENTS**  
302 North Fourth Street  
St. Joseph, Missouri 64502  
(816) 233-1321

Quality products for professional floor care

*For more data, circle 100 on inquiry card*





## Ceco forms floor slabs for world's tallest hotel

Just one more example of Ceco's forming services designed to save time and money

Ceco is forming nearly a million square feet of concrete slabs in Atlanta's new 70-story Peachtree Center Plaza, world's tallest hotel. Work on this project includes all floor slabs and ramps for the base buildings above and below grade, as well as all slabs for the 70-story cylindrical tower.

For more than half a century, Ceco has helped contractors by developing better ways of forming concrete slabs and providing lump-sum prices that represent cost savings to them and building owners. Consequently, Ceco's forming services are used on hundreds of projects every day.

Ceco's field crews are the country's leading specialists in placing and removing formwork for rib-slab, waffle-slab and flat-slab floor construction. For more facts, refer to Sweet's or your nearest Ceco office.



*Peachtree Center Plaza, Atlanta, GA  
A Western International Hotel  
Developer:  
Portman Properties  
Architect:  
John Portman & Associates  
General Contractor:  
J. A. Jones Construction Company*

 concrete forming services  
**CECO**

The Ceco Corporation • General Offices  
5601 West 26th Street • Chicago, Illinois 60650



# npe PLASTICS SHOW '76

## What's up in construction?

### “Plastics...that's what!”

**A whopping 28.6 billion lbs. of plastics will be consumed annually by the construction industry by the end of the century... five times 1975 use. A growing plastics technology will insure this. You can stay on top of the dramatically advancing world of plastics at NPE/76, December 6-10, McCormick Place, Chicago.**

NPE/76 will be the most comprehensive U.S. plastics exposition in the history of this vital industry. More than 400 participating companies with more of everything... nearly 300,000 square feet of exhibits... new products... and equipment... design consultation services... educational seminars on plastics technology and applications... a cornucopia of new ideas and techniques to spark your company's profits... all available in one place, at one time, under one roof!

#### **New convenience and economy too.**

For the first time, a single economical registration fee entitles you to explore your special interests at the exhibits of the National Plastics Exposition as well as attend the eleven seminars of the concurrent National Plastics Conference. The low fee also includes unlimited free bus service between major hotels and McCormick Place.

#### **Advance registration kit available.**

Now you can register in advance for even greater economy and convenience. Your advance registration kit includes everything you need to pre-register at a price of \$7.50 (vs. \$10.00 at the door) as well as reserve your hotel room. To obtain your advance registration kit, write, or use the Reader Service Coupon. At NPE/76 you will have five, full, information-packed days. Plan to make the most of every minute.

#### **Your competitive edge**

Plastics are really going up in construction. That's why a lot of NPE/76 will be devoted to your specific interests... new materials, new processes, new applications.



#### **SPECIAL CONSTRUCTION SEMINAR!**

Topics will range from the impact of the Federal Trade Rule to new markets for plastics construction to solar heating and energy consumption to new building codes... plus others on management, marketing, processing technology that will enable you to cut costs, increase sales, innovate, and plan for the future.

In the three years since the last Plastics Show, a lot has happened. The plastics industry moves fast. So catch up at NPE/76. Save time and money by registering in advance. Write The Society of the Plastics Industry, Inc., 355 Lexington Avenue, New York, N.Y. 10017, or... CIRCLE READER SERVICE NO. 102.

## National Plastics Exposition

Sponsored by The Society of the Plastics Industry, Inc.







**TEST ONE: DU PONT NEOPRENE**  
Time: 1 minute, 30 seconds after ignition.



Time: 3 minutes, 00 seconds.  
Center chair involved.



Major flames out. Time: 6 minutes, 00 seconds.  
Damage: 1 chair involved, fabric melting and smoldering on two adjoining chairs.



**TEST TWO: HR POLYURETHANE**  
containing flame retardants.  
Time: 1 minute, 30 seconds after ignition.



Time: 3 minutes, 00 seconds.  
Five chairs in two rows involved.



Major flames out. Time: 29 minutes, 30 seconds.  
Damage: 5 chairs in two rows involved.



**TEST THREE: STANDARD**  
**POLYURETHANE**  
Time: 1 minute, 30 seconds after ignition.



Time: 3 minutes, 00 seconds.  
Five chairs in two rows involved.

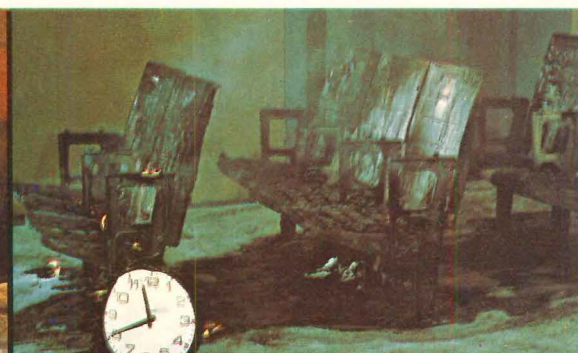

Major flames out. Time: 40 minutes, 00 seconds.  
Damage: All seven chairs involved.

## We tested theatre seats against fire. Neoprene cushioning foam performed best.

We conducted three burn tests at Factory Mutual's Test Center.

In each test we used seven theatre chairs in an environment intended to simulate that found in a typical theatre or public auditorium. Our fuel source in each case was typical theatre trash—popcorn boxes, drink cartons, cups and napkins—placed under the center chair.

As the photographs above show, there was considerably less flame damage among the chairs cushioned with deep foam of Du Pont Neoprene than among those cushioned with other common cushioning foams.

### The Test Chairs

Test #1 used cushions of Neoprene deep foam. Test #2 used cushions of high resiliency (HR)

polyurethane foam containing flame retardants. The chairs in these two tests were otherwise identical, with upholstery fabric and plastic seat backs containing flame retardants.

Test #3 was conducted with a standard type polyurethane cushioning foam in chairs with untreated components.

### Smoke Obscuration

During each test, light obscuration by smoke was measured by photo cells six feet from the floor. Data gathered show the chairs cushioned with Neoprene produced less total smoke because only one chair was consumed by the fire.

Combine the results of these tests with the resilience and comfort of

Neoprene foam, and it's easy to see why this versatile, durable material has been widely specified wherever public safety is at a premium.

For complete test data, plus information on suppliers of Neoprene foam cushions or finished seats, write: Du Pont Company, Room 24402C, Wilmington, DE 19898.

## Cushioning Foam of DuPont Neoprene





# Hager gives you the edge on hospital doors with Camtro

Hager's new patented Camtrol® double action pivots insure snug bathroom door fittings without rounding door edges. Camtrol's unique double acting pivot action is specially designed for hospital and nursing home bathroom doors weighing up to 100 lbs. Top and bottom anchor arms are precisely machined from strong, fine quality 3/16" steel for mortising into 1-3/4" doors. Only three moving parts insure a lifetime of dependable use. Plastic cinch anchors make masonry floor installation simple and fast. Base dust covers help provide extra sanitation.

Ask your architectural hardware consultant for an interesting look at Hager's complete line of fine quality institutional door hardware. Or, write Hager Hinge Company, 139 Victor Street, St. Louis, Mo. 63104. Everything hinges on Hager!

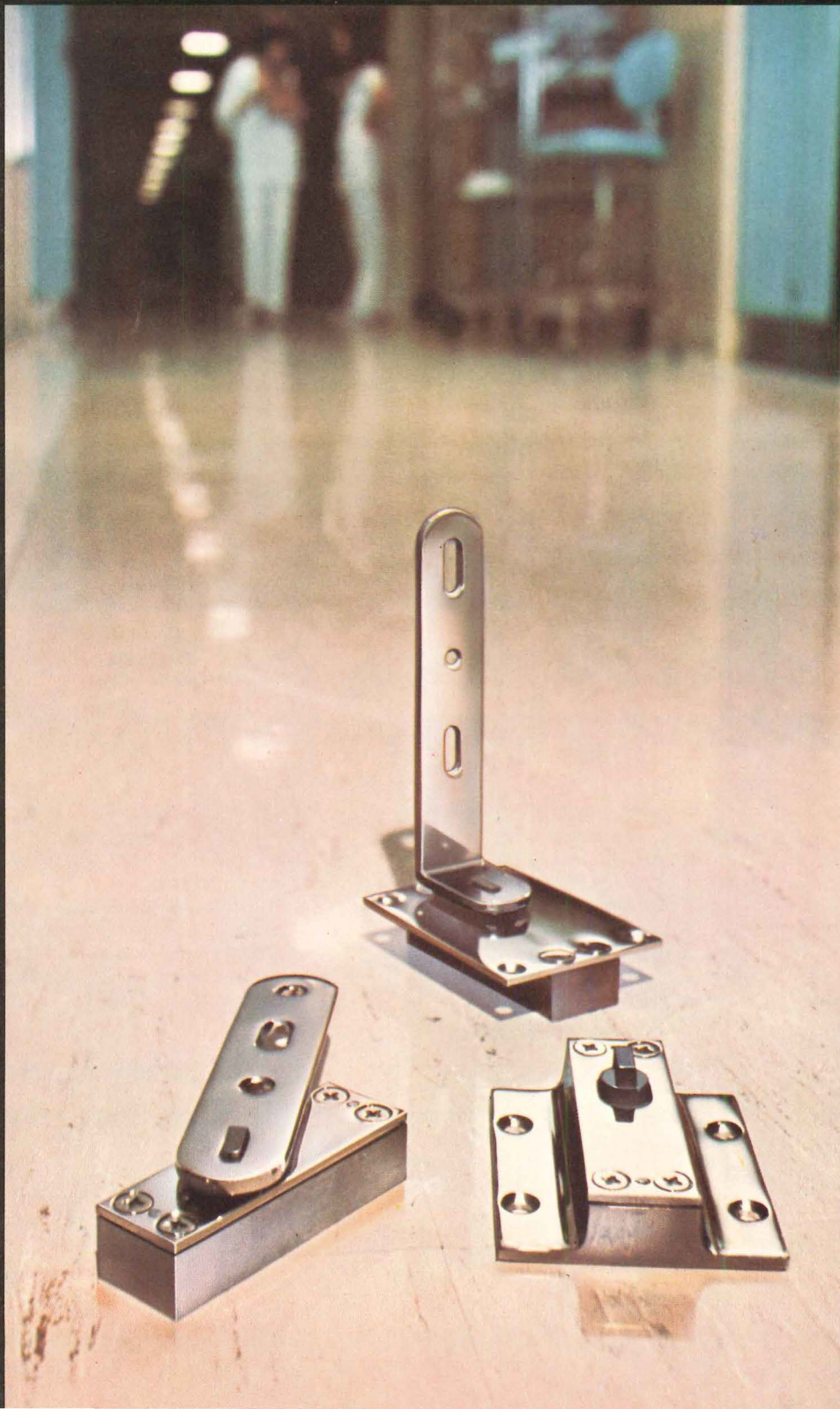



# Now! save up to 60% on installation!

beauty comes  
pre-formed and  
pre-packaged



Greene County Bank, Greeneville, Tenn., Architect: Boyd & Arthur, Roofer: Hicks Sheet Metal Co.

## MICROZINC 70<sup>®</sup>

*Pre-formed zinc fascia system*

What a difference Microzinc 70 makes! This pre-packaged, pre-formed batten fascia system saves 60% labor over conventional sheet metal installation practices. Comes in 5' or 9' interlocking sections packaged specifically for your job. No special tools are needed. For maintenance-free enduring beauty, specify Microzinc 70 on your next job. Send today for a free installation manual showing how you can save up to 60% on labor with Ball's Batten Fascia System.



**Metal  
& Chemical  
Division**

Greeneville, Tennessee 37743 • 615/639-8111

For more data, circle 105 on inquiry card





EDGEWATER HOSPITAL NURSES' RESIDENCE, Chicago, Illinois



NATURE CENTER, Kalamazoo, Michigan

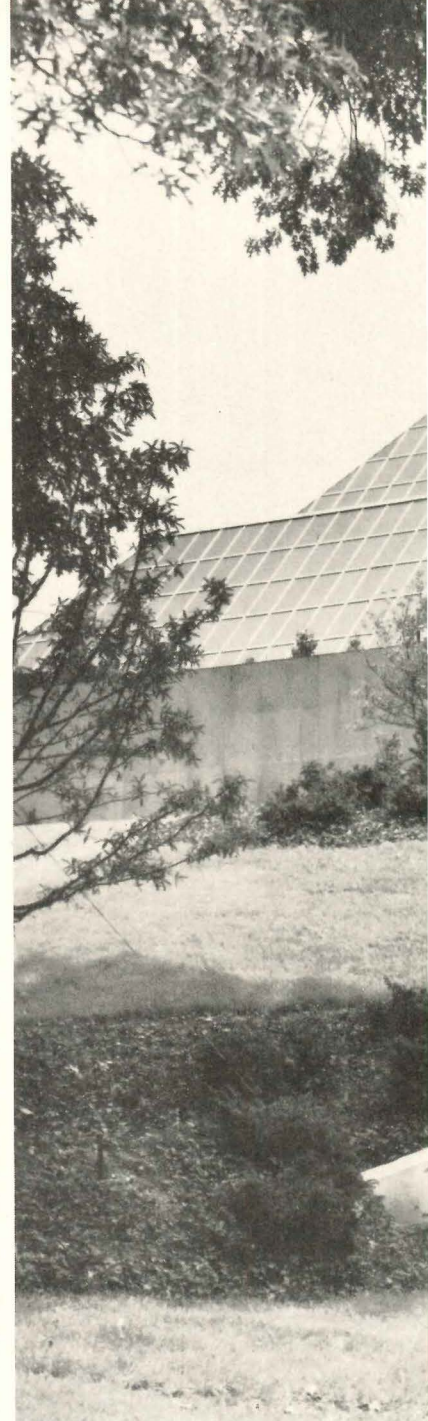

LEHMAN WING, METROPOLITAN MUSEUM OF ART

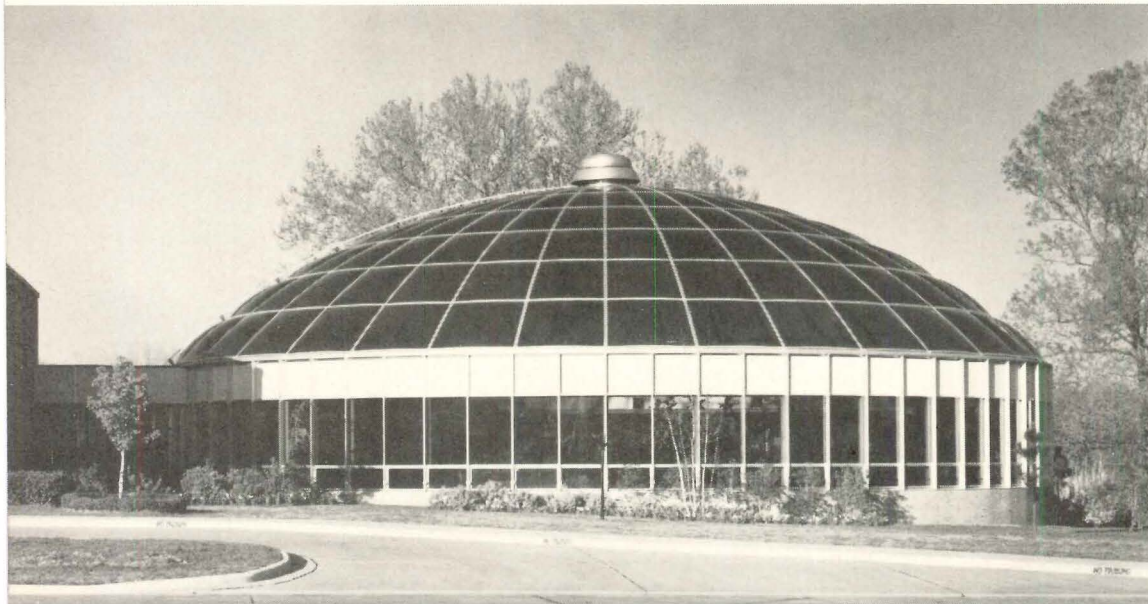

BARNWELL GARDEN AND ART CENTER, Shreveport, Louisiana



WATER TREATMENT PLANT, Crystal Lake, Illinois

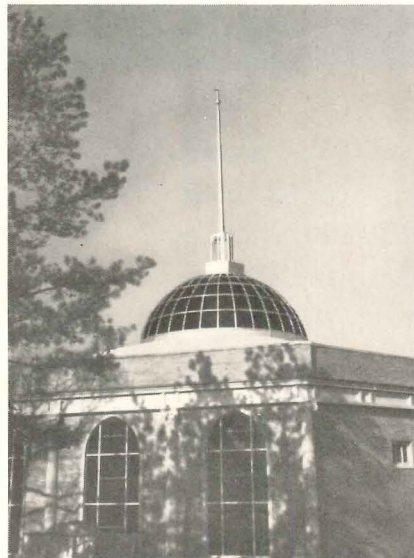

MOUNT CARMEL CHRISTIAN CHURCH, Decatur, Georgia

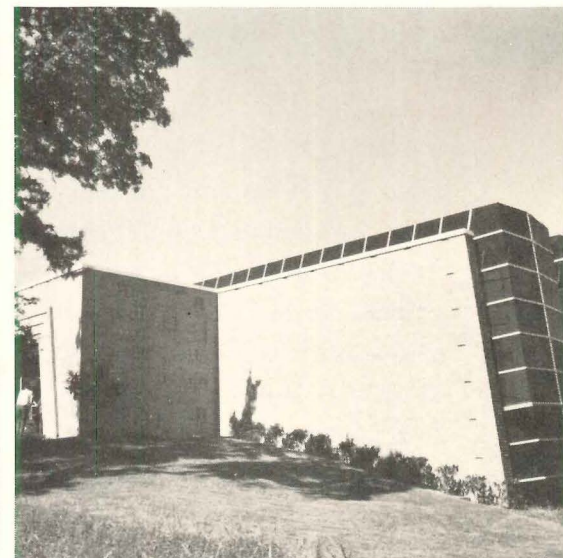

MARSALIS PARK ZOO, Dallas, Texas





rk City



## Who does skylighting for public buildings more ways than anybody?

**ROPER** **IBG**

Add a touch of drama to the design of your public space projects. Do it with skylights.

And for creative design assistance, call on Roper IBG, the skylight people.

In the U.S.—Ray Miller, Box 100,  
Wheeling, Illinois 60090, (312) 634-3131.

In Canada—Stan Kenny, Box 2000,  
Beamsville, Ont. LOR 1B0 (416)563-8276.

For other countries—Gerhard Schultz,  
IBG International, Box 100, Wheeling,  
Illinois 60090, (312) 634-3131.

See us in Sweet's.







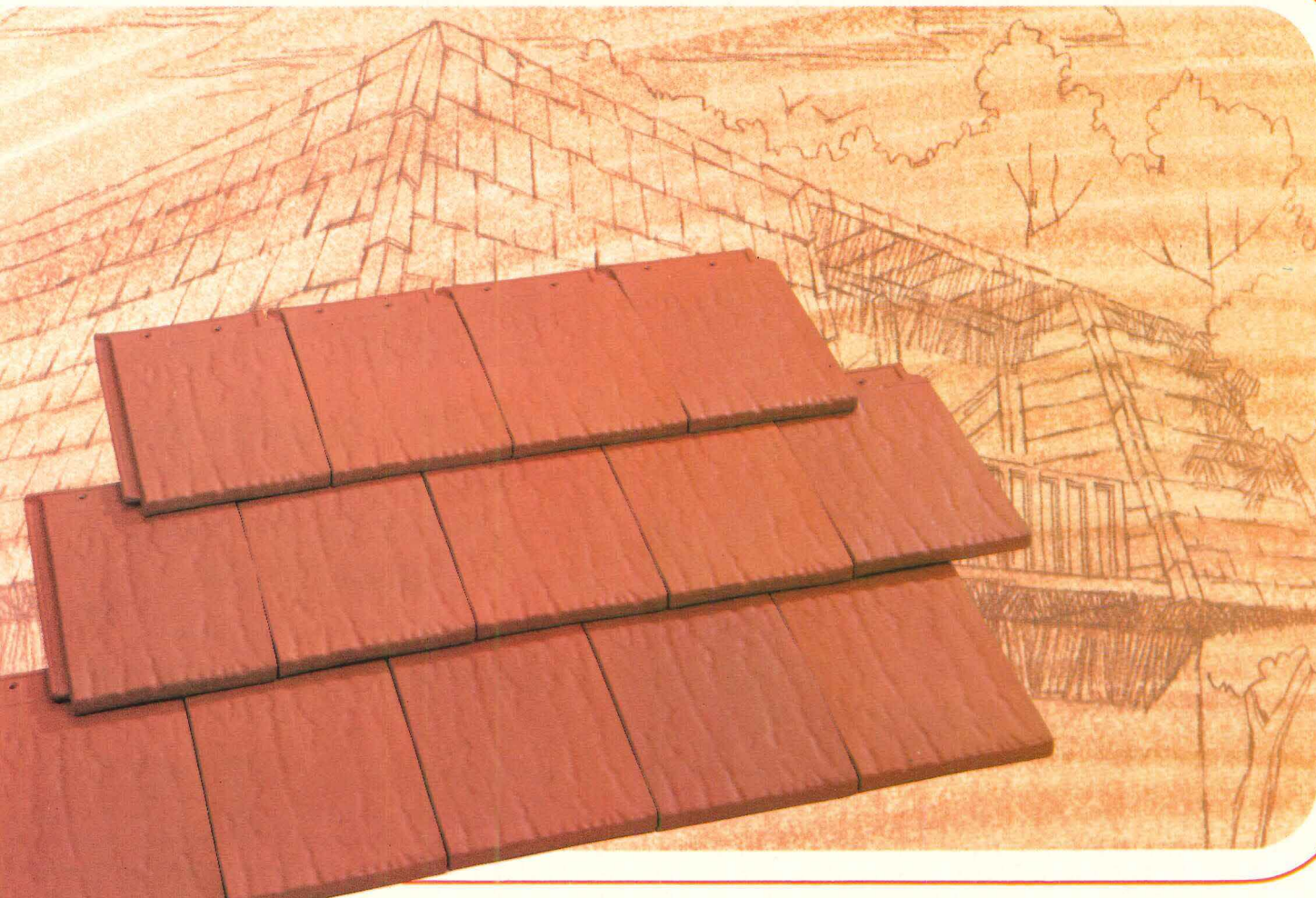

Russet Red

The beauty of a bygone day captured in a heritage for tomorrow.

# AMERICANA Roofing Tile by Ludowici.

Derived from the rugged hand-hewn character of split shakes and used during our country's colonial period, Americana has become one of the most versatile tile patterns in the portfolio of today's architects. Bold butt lines and a simulated wood grain face combine to provide an interplay of light and shadow, as soft but rich colors create varying moods with every angle of light.

With all Ludowici Tile, Americana colors are permanent, only mellowing with time. Earth Gray, Russet Red, Forest Green, Beach Brown, Lava Black, Hawaiian Gold, Sunset Orange (weathered surface) and two-tone glaze Pacific Blue are up the Americana spectrum.

The tile itself can be expected to outlast the buildings it

beautifies and protects, requiring little or no maintenance. It's fungus and decay proof. Defies fires. And resists the effects of storm and weather throughout the years.

Ludowici Tile stands out, handsomely and gallantly, in any climate.

Beautiful and lasting as Americana and other Ludowici tiles are, they often cost no more—and frequently less—than fire-resistant wood shakes, slate or other premium priced roofing materials.

For further information on the design versatility offered with Ludowici Tile, look in the Yellow Pages for your local Ludowici distributor, or refer to Sweet's Catalog. Or, mail the coupon.



SH  
Mediterranean Blue

LANAI  
Lava Black

NORMAN  
(light to dark black range)

ean Blue

1 1/4" STRAIGHT BARREL  
MISSION Fine Scored Red

SPANISH  
Smooth Red



**LUDOWICI-CELADON COMPANY**

111 E. Wacker Drive, Chicago, IL 60601 • (312) 329-0630

Send me a color brochure.       I'm interested in custom-made tile.

NAME \_\_\_\_\_

FIRM \_\_\_\_\_

ADDRESS \_\_\_\_\_ COUNTY \_\_\_\_\_

CITY \_\_\_\_\_ STATE \_\_\_\_\_ ZIP \_\_\_\_\_



# STOP LOOKING FOR LOUVERS?

**STOP** Operating and fixed louvers

**STOP** Competitive prices

**STOP** Installation available

Send for 28 page  
Technical Louver Catalog

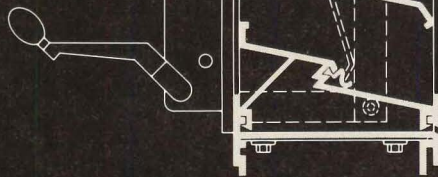

**cyclops**  
CORPORATION

**ELWIN G. SMITH DIVISION**

100 WALLS STREET, PITTSBURGH, PENNSYLVANIA 15202

CGS-122

For more data, circle 109 on inquiry card



Low cost Clearstrip — the flexible, see-through vinyl curtain — helps stop loss of cooled or heated air and reduces transmission of noise, smoke, dirt and fumes. Fast, safe passage for vehicles and pedestrians. Available for openings up to 14' high with unlimited width. Suitable for temperatures down to -20° F. Write or call today for free catalog.

**Clark's see-through  
Clearstrip<sup>TM</sup> curtain  
reduces air flow  
and noise.**

**Clearly—an energy saver.**

Clark Door Company, Inc.  
69 Myrtle Street,  
Cranford, N.J. 07016  
Tel. (201) 272-5100; Telex: 13-8268

**CLARK**  
**DOOR**

For more data, circle 110 on inquiry card

**Just like no hinge at all**

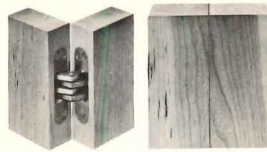
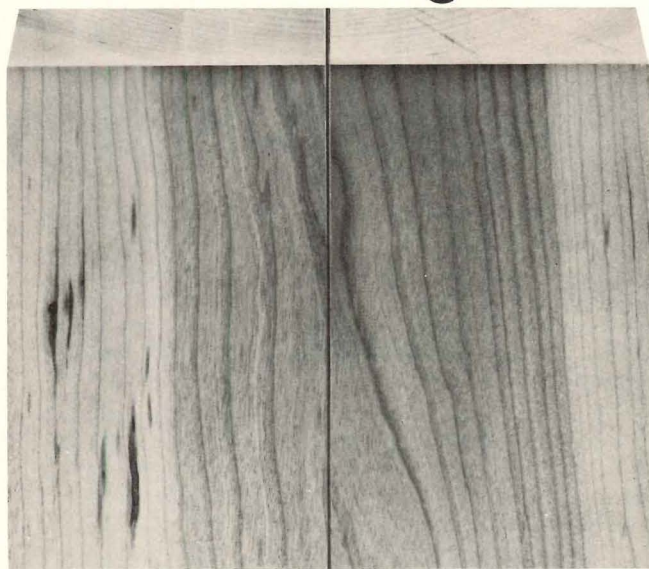

Now you see it. Now you don't!

**The hinge that hides**

Some hinges are decorative. Some are functional. But only one hinge is invisible.

So when the best hinge would be no hinge at all, specify Soss.

Choose from 18 models and four finishes. All models open 180° and disappear when closed.

Complete specifications are in Sweet's. Or, write to Soss Mfg. Co., Div. SOS Consolidated Inc., P.O. Box 8200, Detroit, Mi. 48213.

**the SOSS**  
**Invisibles**

For more data, circle 111 on inquiry card



# Old worlds need Glidden.



## Preserve and restore easy and fast with our latex and alkyd systems.

The wrecker's ball swings gently these days. More of America's fine old buildings, preserved and restored, will serve another century.

This trend brings you profitable new business — *if you keep costs down*. You can. With Glidden. Three ways:

- Single source convenience. Old structures present new challenges to painters—inside and outside. One source, Glidden, has every coating you need to do the whole job. You'll save your time, and workers' time, because you'll get the right coating at the right time, and right cost, from Glidden.
- Technical service backup. When you run into

problems you haven't faced before, call on Glidden technicians who have already faced (and solved) them.

- Free color styling and decorator help. From professionals of the Glidden Color Studio. Puts the "icing" on your bid to help sell the job.

Tell us about the job you're after. We'll tell you how we can help you get it.

**Glidden**

**SCM**® **GLIDDEN COATINGS & RESINS**  
**ARCHITECTURAL & MAINTENANCE**  
SCM CORPORATION, CLEVELAND, OHIO 44115



# cedar shakes & shingles VS Shakertown 8ft. panels



If you want a really handsome sidewall, Red Cedar shakes or shingles will give you a first-class job. But for a 500 square foot sidewall you'd end up handling a lot of materials. Like 840 shingles, another 840 undercourse shingles, over 50 8-foot lengths of nailing strips, and more than 3,500 nails.

Of course, you could do the same job with 8-foot long Shakertown Panels. You'd use only 54 panels and less than 700 nails.

And that's all.

That's because Shakertown Panels are made from #1 Certigrade Western Red Cedar

shakes and shingles permanently bonded to a wood backing. So you put up 8 feet of shakes or shingles in one piece, nailing only at studs.

With fewer pieces to handle, installation takes less time. In fact, Shakertown Panels go up three times faster. And once they're in place, they look, last and insulate just like individual shakes and shingles.

So if the high cost of applying shakes and shingles is more than you can handle, find out how easy it is to handle Shakertown Panels. Write us.



## Shakertown® Panels

Box 400X, Winlock, Washington 98596

(206) 785-3501

In Canada: Bestwood Industries, Ltd., Box 2042,  
Vancouver, B.C. V6B 3R6



# How to use classroom and library space more efficiently with **MEG EDUSPACE** storage systems.

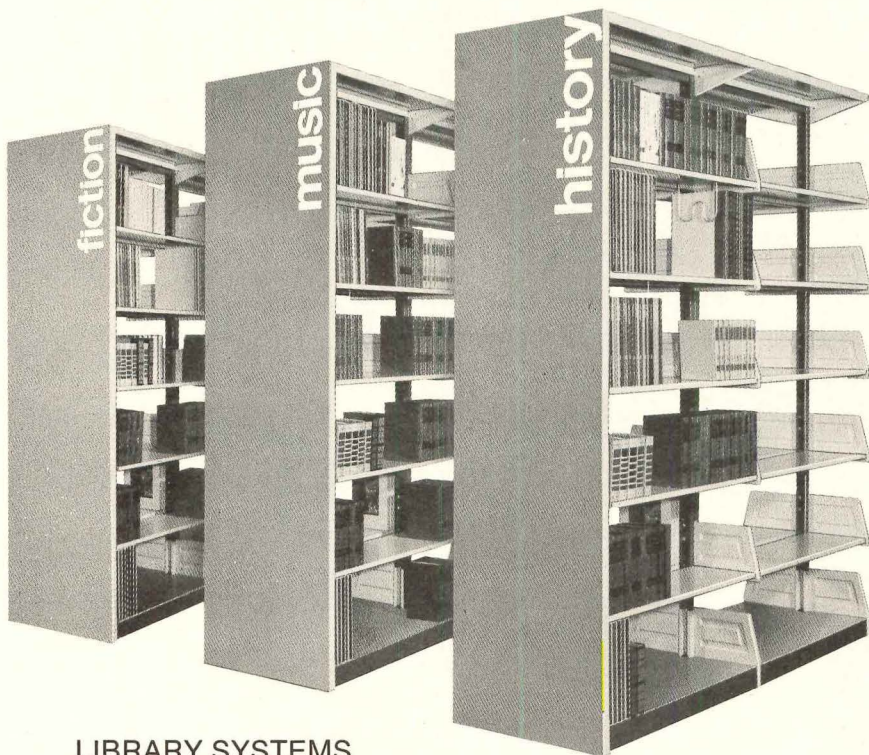

## LIBRARY SYSTEMS

Now, from a single source, you can specify a wide array of high-quality, space-saving storage systems that provide the ultimate in interior planning and design, deliver the optimum in efficiency and operation.

EDUSPACE systems by MEG includes: Library Systems; Space-Mobiles; Roll-Shelf; Fixed Casework, and DECOR-GRAPHICS...an original MEG concept that directs readers, students, technicians and teachers to the books and materials they need—quickly.

**LIBRARY SYSTEMS** MEG creates new dimensions in library design and operation with an integrated system of bookstacks, furniture and accessories. DECOR-GRAPHICS makes book selection easy by spelling out the classification system on the end panels. Bookstacks feature rugged, non-sway design, rigid shelves, easy installation

and safety edges. Library systems are available in T-Bar base or closed base designs. In sizes 42" to 90" high by 30" to 36" wide.

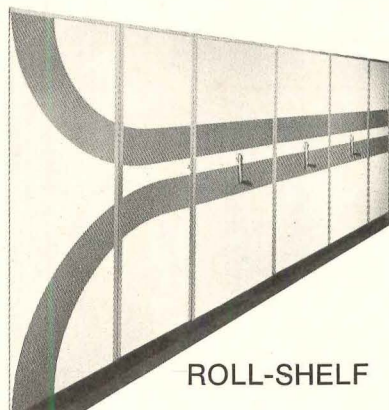

## ROLL-SHELF

**ROLL-SHELF** is high-density storage shelving on wheels. The shelving glides effortlessly on wheels along steel tracks. It adds up to 80% more storage capacity to existing areas, without increasing floor space! One aisle does the job of four, five or more. Interiors take on a new look with DECOR-GRAPHIC designed end panels. Materials, books and equipment are easier to find.

**SPACE-MOBILES** A complete line of movable storage units for total classroom flexibility. Tote tray storage, general storage, and wardrobe storage units can be modified to meet architects or individuals requirements with a variety of inserts. Fabri-



## SPACE-MOBILES

cated from high pressure plastic laminate, **SPACE-MOBILES** are available in your choice of decorator colors or wood grains. Features include: Heavy duty construction, full mobility, complete versatility and contemporary styling.

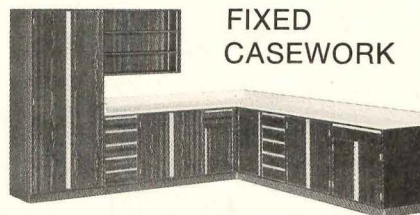

## FIXED CASEWORK

**FIXED CASEWORK** Educational Fixed Casework Systems by MEG represents the most advanced, most versatile and most economical system of contemporary styled cabinets. Educational Fixed Casework Systems are designed to meet the ever-demanding needs for improved storage and greater accessibility to teaching aids. Its flexibility and adaptability makes it a highly serviceable perimeter storage system for classrooms, teaching laboratories, arts and crafts, industrial arts, music, home economics, science and general school areas.

EDUSPACE is but one way MEG helps schools function better. MEG is also a leading source for a complete range of Distributive Education facilities. Today, find out what MEG can do for your school, library or learning center.

Write for **FREE Color Brochure** to:  
MEG, 100 Bidwell Road,  
South Windsor, CT. 06074.



See MEG at the ASBO Exhibit—Booth No. 506-507



**There are many different waterproofing conditions. That's why there are many different Tremco waterproofing systems.**

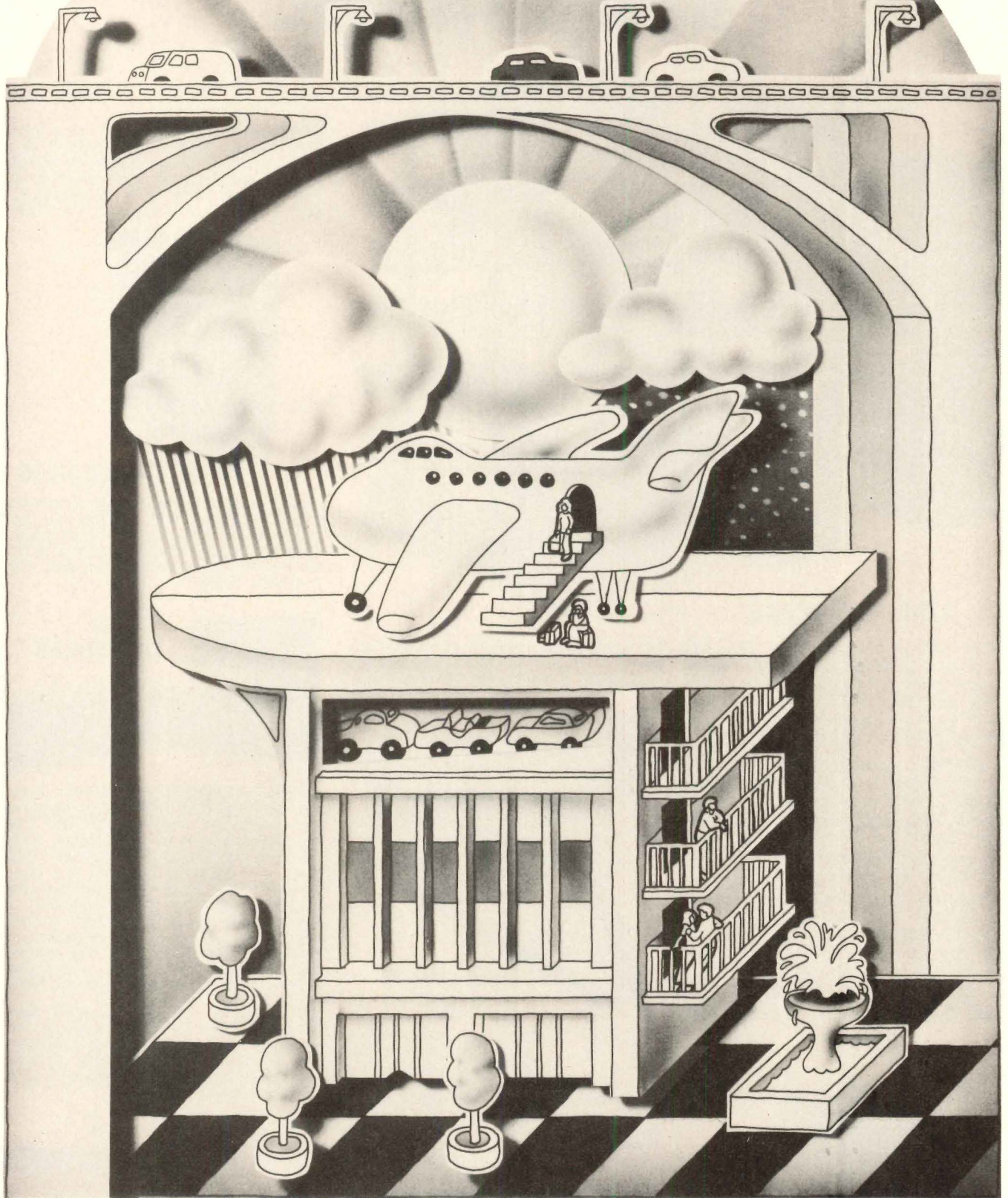



You know that many factors have to be considered when you design a waterproofing system. For example, some will be on grade, some below, some above grade. You may be looking for products with special qualities, such as quick adhesion to damp or green concrete, or surface finishes that are rougher than usual. Some systems will be limited by tight budget.

When you work with Tremco, there's one factor you don't have to concern yourself with: the quality of the system you choose. Just tell us your waterproofing requirements and you can count on us to recommend a proven Tremco system that will do the job effectively. To help you get the most out of the system, we'll work with you from drawing board to job-site application instruction.

Tremco offers a broad line of the best of both hot- and cold-applied liquid membranes that will help you meet most conditions.



## A versatile hot-applied system

Say, for example, the job has to be done under a wide range of temperatures and the concrete surface finish may be a little rougher than usual. TREMproof 150 is an excellent choice, particularly for unexposed waterproofing applications such as bridge decks, parking garages and plaza decks.

With the recommended application thickness of  $\frac{1}{8}$ -inch to  $\frac{3}{16}$ -inch, it will tolerate some surface irregularities, span structural cracks up to  $\frac{1}{16}$ -inch without cracking or becoming brittle. Service temperature range is  $-45.6^{\circ}\text{C}$  ( $-50^{\circ}\text{F}$ .) to  $82.2^{\circ}\text{C}$  ( $180^{\circ}\text{F}$ .)

Its recovery and self-healing properties provide a safeguard against job-site abuse. Punctures will re-seal or can be quickly repaired by heating with a torch.

## High-performance cold-applied systems

Tremco gives you a range of job-proven cold-applied systems to meet a broad range of two-course concrete construction techniques, plus critical areas (planters, reflecting pools, etc.) Take TREMproof 50. This two-part bitumen modified moisture-curing ure-

thane provides a high-performing, flexible rubber-like seamless blanket that becomes an integral part of the structure. It can withstand constant water submersion. And because it's highly elastomeric, a 60-mil application provides up to 90% recovery. Service temperature range is  $-40^{\circ}\text{C}$  ( $-40^{\circ}\text{F}$ .) to  $65.6^{\circ}\text{C}$  ( $150^{\circ}\text{F}$ .) It can be used on both vertical and horizontal surfaces and can be applied with trowel, squeegee or spray.

TREMproof 90W is a unique rubberized polymeric emulsion modified with asphalt. The system sprays on quickly and easily and cures within 15 minutes which prevents wash-off. It can be safely applied to green or damp concrete.

When you need a system for waterproofing traffic-bearing surfaces such as plazas, balconies, terraces, interior floors, etc., TREMproof 850 will do the job. This decorative liquid polymer cures to a flexible seamless blanket then becomes an integral part of the structure and provides excellent resistance to abrasion, chemical spillage and ponded water.

If you plan to use precast pavers, consider the Tremco Plaza Deck System which includes ingenious KingPin® pedestals and a TREMproof liquid polymer. The system eliminates unsightly surface drains, excessive slopes and joint sealants. KingPin pedestal fingertip height adjustment allows for deck or paver irregularities. The open joint design helps avoid ponding and freeze-thaw problems, such as heaving and spalling.



## One source for all systems

That's the beauty of working with Tremco. One convenient source that can supply any system you need. Tremco meets special waterproofing challenges head-on.

So remember. There are all kinds of waterproofing conditions and all kinds of waterproofing systems. But there's only one company that can offer you job-proven systems plus 45 years of on-site experience. And that's Tremco. Let us work with you on your next waterproofing job. Tremco, Cleveland, Ohio 44104. Toronto, Ontario M4H 1G7.

# TREMCO®





**OMNI FACADE**

**It's designed  
to redesign the industry**

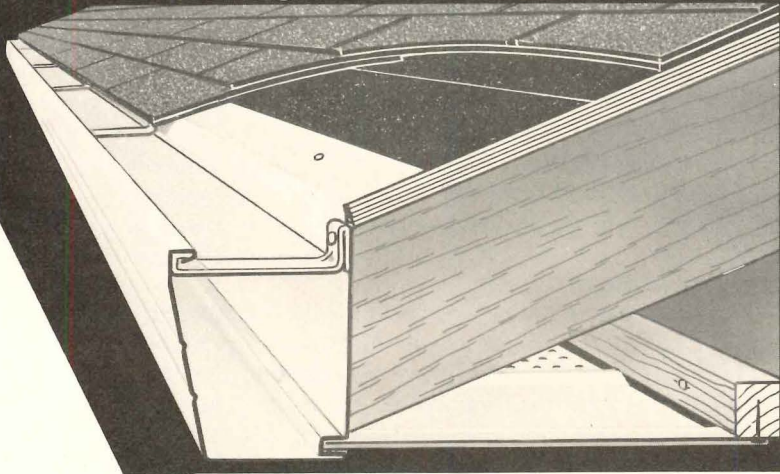

It's a completely new concept in rain carrying systems. Omni Facade provides both gutter and fascia in a single piece of aluminum that's channeled to hold either pan or continuous roll soffit. It reduces time and material costs and provides architects with a clean-line look in roof design. It's Omni Facade.

Simply call (312) 543-5700 today and ask about the rain carrying system of tomorrow.



**OMNI PRODUCTS™**

1550 West Fullerton Avenue • Addison, Illinois 60101

For more data, circle 116 on inquiry card

**AE/UPDATE**

A classified advertising section devoted to helping architects and engineers keep up to date on building product manufacturing.

**FREE FENCE SPEC KIT SAVES TIME, TROUBLE!** Invaluable for planning chain link fencing. Kit includes drawings on styles, wire gauges, gates, fittings, framework. Also includes lab reports, work sheets and specifications. *Page®* aluminized fabric lasts 3-5 times longer than the best of galvanized. Page Fence Division of Acco, P.O. Box 430, Bridgeport, Conn. 06602. American Chain & Cable Company, Inc., Member of the Babcock & Wilcox Ltd. Group of Companies.



For more data, circle 117 on inquiry card



New Medical Laboratory Equipment Catalog illustrates Jewett's complete line of refrigerators and freezers for hospital and installation. A wide range of morgue autopsy equipment is also included in this sturdy binder. Comprehensive drawings and specifications feature metric as well as English dimensions to accommodate

Jewett's international market of over 100 countries throughout the world. The Jewett Refrigerator Co. Inc., 2 Letchworth St., Buffalo, NY 14213.

For more data, circle 118 on inquiry card



## Designing with steel?

### Look at the aesthetics and structure/ability of Regal Welded Steel Tubing

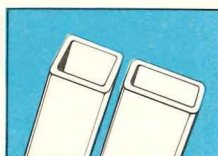

1" square thru  
12" x 8" rectangle.  
.083 thru .500 wall

Our clean-lined, smooth squares and rectangles assure better appearance and give you basic design advantages.

Higher strength-to-weight ratios let you use lighter structural columns and beams, trusses, mullions, and stairways. Also provide handsome concealment of conduit, pipe, etc.

You can simplify layout and speed construction due to easy joining to the four flat surfaces.

These are only a few of the cost-saving advantages of Regal structural steel tubing. Learn more about how Regal structural steel tubing can save you time and costs. Write for our new catalog, free on request. Or contact your steel service center.

**The Copperweld  
Tubemakers**

**REGAL TUBE COMPANY**

7401 South Linder Avenue  
Chicago, Illinois 60638 U.S.A.  
Phone: 312-458-4820

For more data, circle 119 on inquiry card

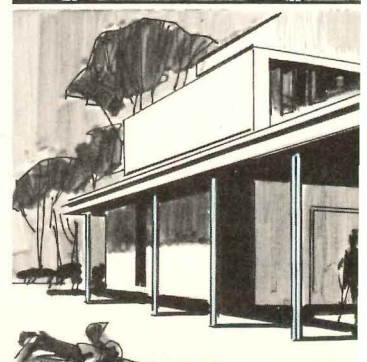
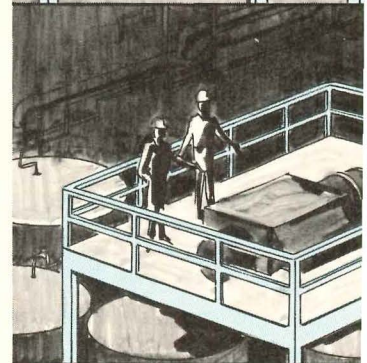



## The economical approach to hospital walls.

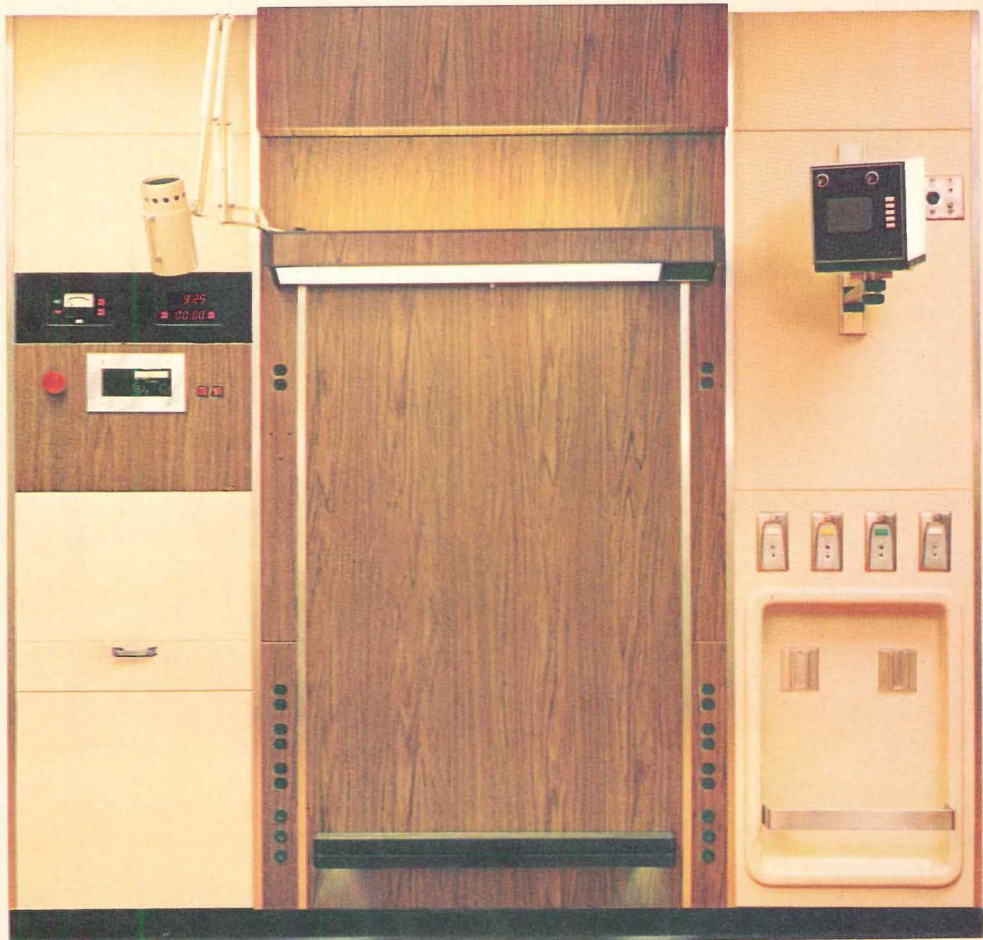

Series 3000 Modular Hospital Walls

For ICU/CCU, recovery or general patient care areas, Square D modular hospital walls offer these major advantages:

**LOW INITIAL COST.** The latest numerically controlled, high production techniques are used to assure the highest quality at the lowest price.

**ADDITIONAL SAVINGS.** Each modular wall is completely piped and wired at the factory to meet all existing codes. Therefore, installations may be completed in hours instead of days.

**APPEARANCE.** Available in a wide variety of attractive colors and wood tones, these walls are designed for long life and quality appearance.

**USABILITY.** Key components are strategically located and color-coded for easy component identification and use. New components adapt to the wall in a matter of minutes.

**SERVICEABILITY.** Vertical raceways are easily re-

movable for service and essential electrical components are accessible from the hinged door service module.

For the best buy in modular hospital walls for new construction or renovation projects, contact your nearby Square D field office... there are 140 of them nationwide. You can also write or call us directly: Square D Company, Dept. SA, 3300 Medalist Drive, Oshkosh, WI 54901. (414) 426-1330.



**SQUARE D COMPANY**

*Wherever Electricity is Distributed and Controlled*



...AU NATUREL





# AVEC ESPRIT

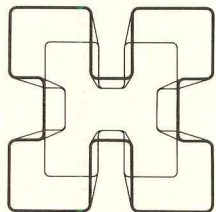

The **Hauserman Office System** gives you freedom to choose.

Hauserman provides flexible space division, storage and work components for your design requirements. And, with new products and wide variety of color, fabric and finish options, the Hauserman Office System accommodates you.

Au Naturel, avec esprit or in-between Hauserman gives you quality with design freedom.

See the Hauserman Office System at NEOCON, Merchandise Mart, 410A, June 23-25. Or, visit our Demonstration Centers in Chicago, Cleveland, San Francisco, Dallas, New York City or Toronto, anytime.



**HAUSERMAN**

Hauserman, Inc.

5711 Grant Avenue

Cleveland, Ohio 44105

(216) 883-4100

Hauserman LTD

125 Bethridge Rd.

Rexdale, Ontario, Canada

(416) 713-3211



**Bally** where all our energies  
are aimed at reducing  
your energy costs.

**In Bally Walk-Ins  
the packaged  
refrigeration systems  
use less electricity  
(up to 20% less)  
than comparable size  
remote systems  
assembled on  
the job site**

**It's one more reason why  
you should buy Bally.**

The use of less electricity results from many things. For example, every component in the system is perfectly balanced in size and capacity . . . our coil design obtains maximum air flow to fully utilize its BTU output . . . defrost periods are time-limited and carefully monitored . . . tubing size and length are predetermined for maximum efficiency . . . and each system has a precisely correct refrigerant charge.

Bally is the world's leading producer of walk-in coolers/freezers. They can be assembled in any size for indoor or outdoor use . . . easy to enlarge or relocate. Refrigeration systems from 50°F. cooling to minus 30°F. freezing. Subject to fast depreciation and investment tax credit.

(Ask your accountant.)  
Write for free 28-page book  
and urethane wall sample.  
**Bally Case & Cooler, Inc.,  
Bally, Pennsylvania 19503.  
Phone: (215) 845-2311.**



© 1976 All rights reserved.

ADDRESS ALL CORRESPONDENCE Dept. AR-9

For more data, circle 122 on inquiry card





# PPG GLASS GAVE THIS AGING HOTEL A BEAUTIFUL FACE-LIFT.

Skirvin Tower in Oklahoma City is no longer a hotel anymore (it isn't even a hotel anymore), but it is, once again, a useful, profitable building.

The building was completely remodeled from the ground up and from the inside out.

Now, it's the 101 Park Avenue building, home of some of the

poshest offices in the city, and headquarters of Continental Federal Savings & Loan.

It's a beautiful, modern office building. And PPG Solarban® 480 Twindow® reflective insulating glass played an important part in the transformation.

First of all, it looks sensational. Seeing the blue Oklahoma sky and

dazzling sunsets reflected in this building, it's hard to remember the dowdy, old bricks.

But, perhaps more important, the glass is incredibly practical. Its reflective coating reduces glare and solar heat gain. And during the burning summers on the Great Plains, this is a welcome relief to the air-conditioning system.

The glass is also double glazed for insulation. So when those bitter cold snaps blow down from the north, everybody stays warm and cozy.

Not all old buildings can or should be remodeled. They shouldn't all be destroyed either. Some, like the Skirvin Tower Hotel, present a genuine architectural opportunity. Not to mention a challenge.

We think there's no better way to meet the challenge and take advantage of the opportunity remodeling offers than with PPG reflective glass.

Write to us. We'll send you a Sweet's Catalog telling you more about it. PPG Industries, Inc., One Gateway Center, Pittsburgh, Pa. 15222.

PPG: a Concern for the Future

Owner: Continental Federal Savings & Loan.  
Architect: Noftsger, Lawrence, Lawrence and Flesher,  
Oklahoma City, Okla.



For more data, circle 123 on inquiry card





3-Sphere  
Opal-White  
Cluster



Wall-mounted  
Smoke Diffuser  
with G40 Lamp



1-Sphere  
Clear Diffuser  
with G40 Lamp

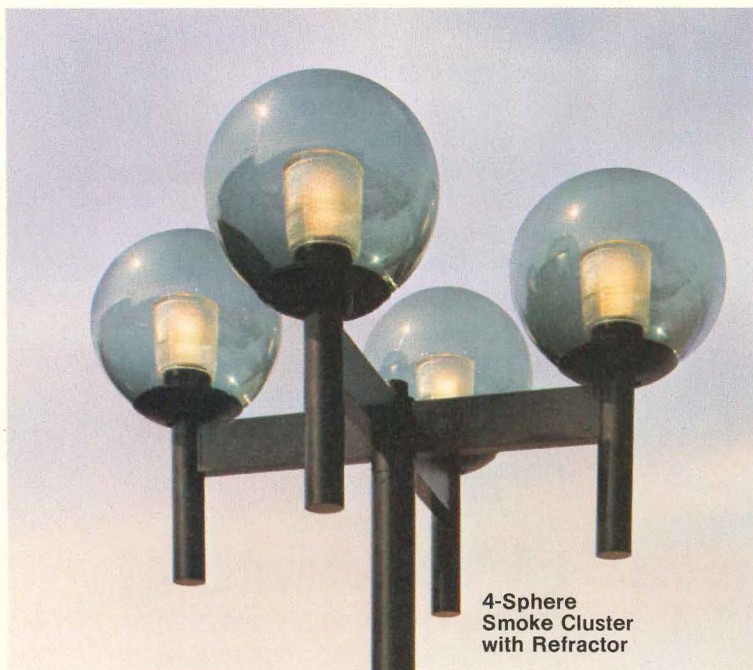

4-Sphere  
Smoke Cluster  
with Refractor

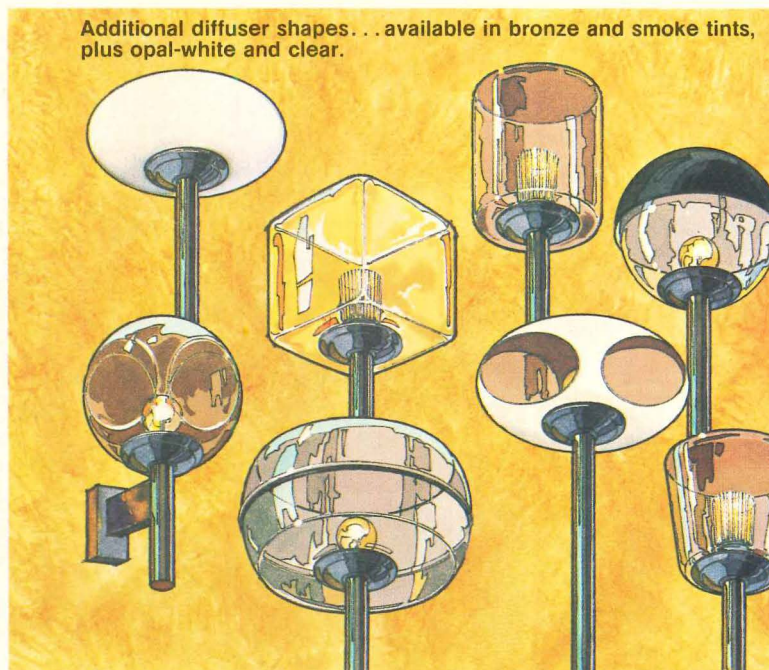

Additional diffuser shapes . . . available in bronze and smoke tints, plus opal-white and clear.

# APPLETON GLO-METRICS™

Contemporary, modular-design outdoor luminaires for visually exciting lighting systems—day and night.

You can achieve a variety of architectural lighting effects in a visually unified system with Appleton Glo-Metrics luminaires.

The Glo-Metrics luminaire system is modular, offering unusual flexibility in lighting design. There are nine striking acrylic diffuser shapes in a choice of sizes . . . in transparent bronze and smoke color tints, plus clear and opal-white. Each design is offered for individual pole-top or wall mounting, or with bracket for pole-top cluster mounting in groups of 2, 3, or 4 luminaires. And they are all available for a choice of lamp types and wattages (with prismatic refrac-

tors where appropriate), providing various lighting levels and aesthetic effects.

The Glo-Metrics system also includes Appleton's unique Mardi-Gras™ luminaire. It has an internal, motor-driven projection system that makes the spherical diffuser appear to revolve in a dramatic blaze of colors and patterns. For wall or pole-top mounting.

Outstanding Glo-Metrics luminaire features; a double-locking system for securely attaching diffusers to their smooth, cast aluminum fitters; pre-wired, crisply styled extruded aluminum mounting arms; luminaire stems

with clean, symmetrical lines; ultra-violet-resistant acrylic diffusers, and integral "in-pole" constant wattage ballasts for mercury and high-pressure-sodium lamps. The finish is attractive, durable acrylic enamel.

Ask your Appleton distributor, or write for the Glo-Metrics Catalog, Appleton Electric Company, 1701 Wellington Ave, Chicago, Ill. 60657.

(In Canada, Appleton Electric Ltd., 750 Lawrence St., Cambridge, Ont. N3H 2N1)

5-241



**APPLETON®**

For more data, circle 124 on inquiry card



# J-M Asbestogard™ Vapor Barrier System. The only approved system which takes solid mopping of hot asphalt.



When roof specifications call for a vapor barrier over steel decks, it makes sense to install the best.

Especially when you consider the job a vapor barrier has to do.

It should permit a minimum of water vapor to pass through it. Should be simple to apply. Should have long life. Must not detract from the structural integrity of the roof system. Should not present a fire hazard.

J-M Asbestogard vapor barrier felt applied to the steel deck with cold-application Asbestogard adhesive and followed with a solid mopping of hot asphalt to firmly anchor roof insulation, meets all these requirements.

Asbestogard felt is made with long, high-grade asbestos fibers and parallel fiber glass yarns for toughness and tear resistance.

It unrolls easily. Stays flat in the wind, doesn't wrinkle, and won't burn through when hot asphalt is applied.

Asbestogard meets Factory Mutual Requirements for Class I Construction and is the only UL rated vapor barrier system.

Start your roof installation with the J-M asbestogard Vapor Barrier System and you'll have J-M quality and dependability from the deck up.

For more information on Asbestogard or the J-M single-source built-up roofing system, call Dick Ducey, Johns-Manville, P.O. Box 5108, Denver, Colorado 80217, 303/770-1000.

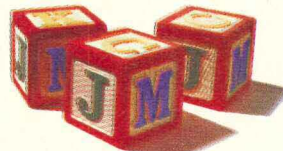

**For single-source  
built-up roofing systems.**

**JM Johns-Manville**

For more data, circle 125 on inquiry card



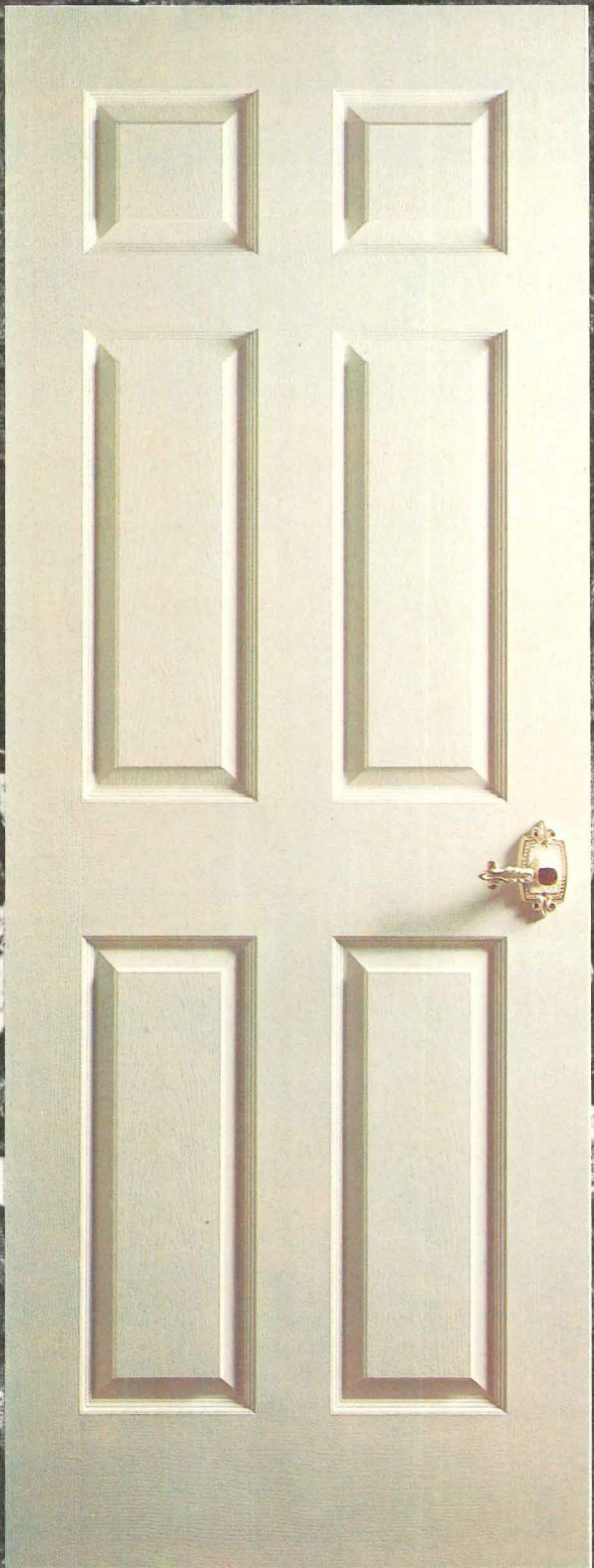

Never before were the best of tradition and technology combined in so pleasing a manner.

*Benjamin Harrison*  
*Francis Lightfoot Lee*

A penny saved is a penny earned. Surely Colonist's great virtue is this.

*W. Lloyd Garrison*

Embossed so sharply, even the King could spyeth its quality without his spectacles.

*John Hancock*

Builders findeth no better way to offereth authentic detail free from the tyranny of high prices than with Colonist faced doors.

*George Wythe*

*Th. Jefferson*

We must count ourselves fortunate that Colonist the work of honest men. Seeing how they've captured the look of wood stile and rail doors, I give thanks they turned not their skills to counterfeiting money.

*Sam'l Adams* *Benj. Franklin*

Colonist surpriseth me not. For who else might best be expected to raiseth the art of embossing hardboard to this perfection but the very people who hath invented the material...Masonite Corporation.

*Thos. Mifflin*  
*Geo. S. Patton*



# 'Tis a Unanimous Yea! ...for COLONIST<sup>®</sup> by Masonite Corporation

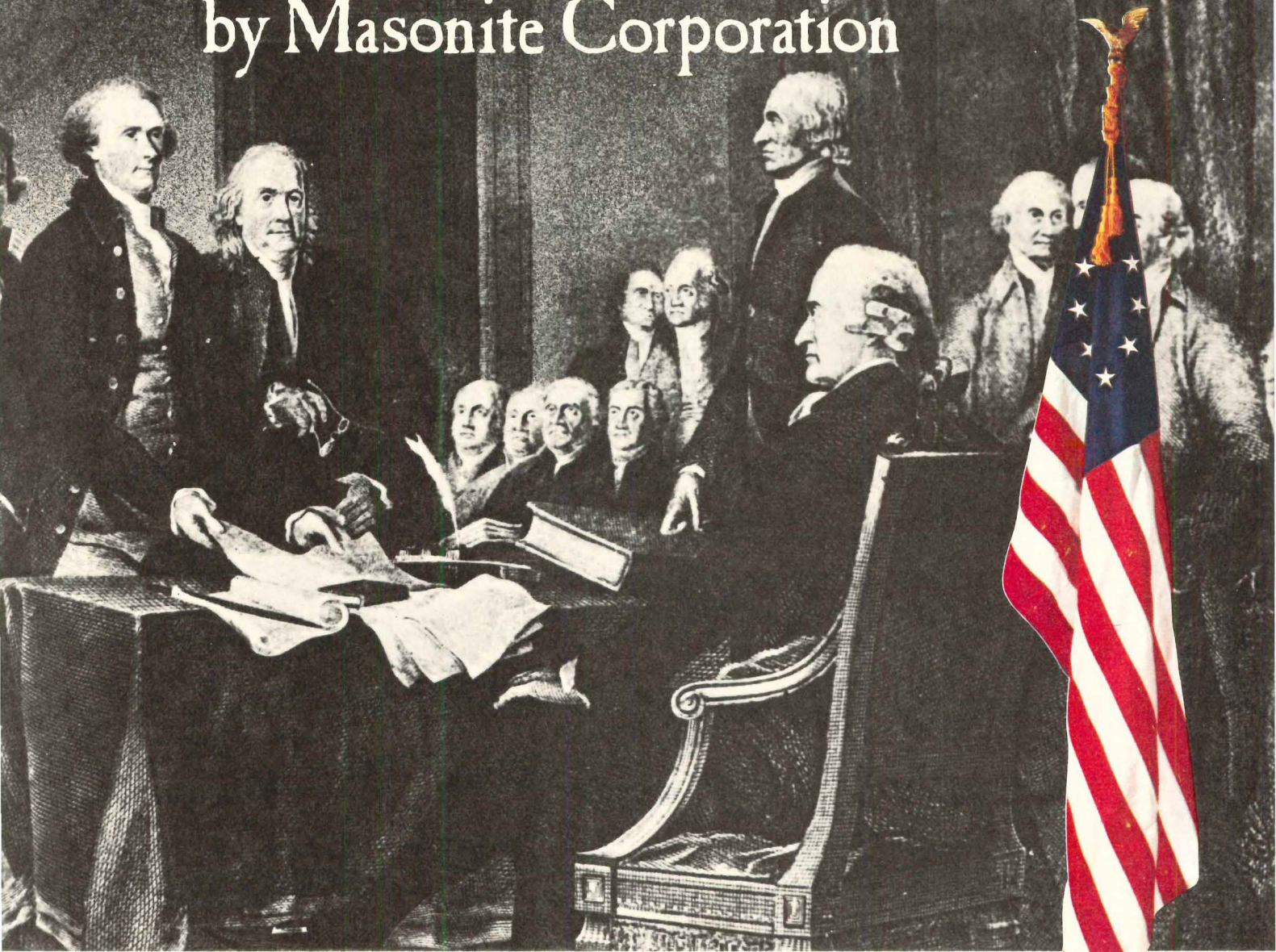

Every American home must not only shelter  
its citizens but also lend pleasure to  
their life. Colonist is a great stride  
toward this end.

*John Adams* *Wm. Whipple*

That changes are irksome to the  
human mind, but Colonist is a  
solution to be welcomed.

*Robt. Spear Paine*

*Arthur Middleton*

Builders selling Colonial homes with flush  
doors hath as much chance of success as  
innkeepers who serveth beer in coffee  
cups. Since Colonist, they hath no excuse.

*Benjamin Rush* *Robt. Morris*

A single piece of hardboard that's free  
from the dangers of separation and  
distortion and yet looks truly like a wood  
door... 'tis proof of American ingenuity.

Want ye the names of  
COLONIST suppliers?  
Take pen in hand and  
write Masonite Corporation,  
29 North Wacker Drive,  
Chicago, Illinois 60606





A splendid opportunity for architects to have their work published  
in two prestigious award programs:

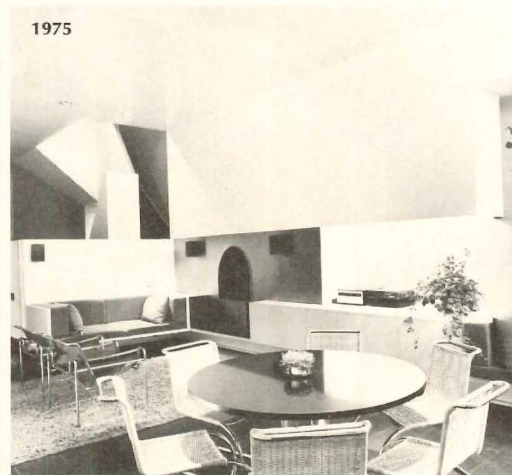
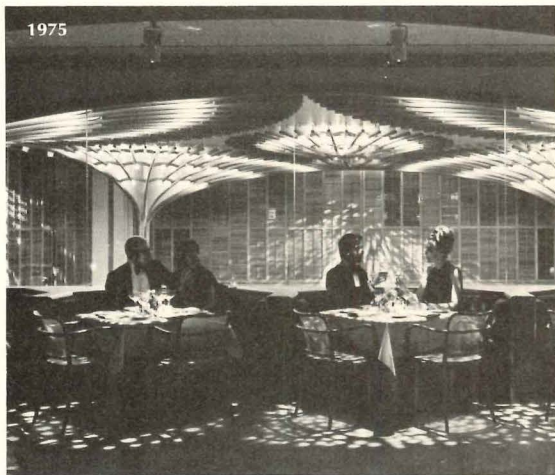

## RECORD INTERIORS • RECORD HOUSES and APARTMENTS

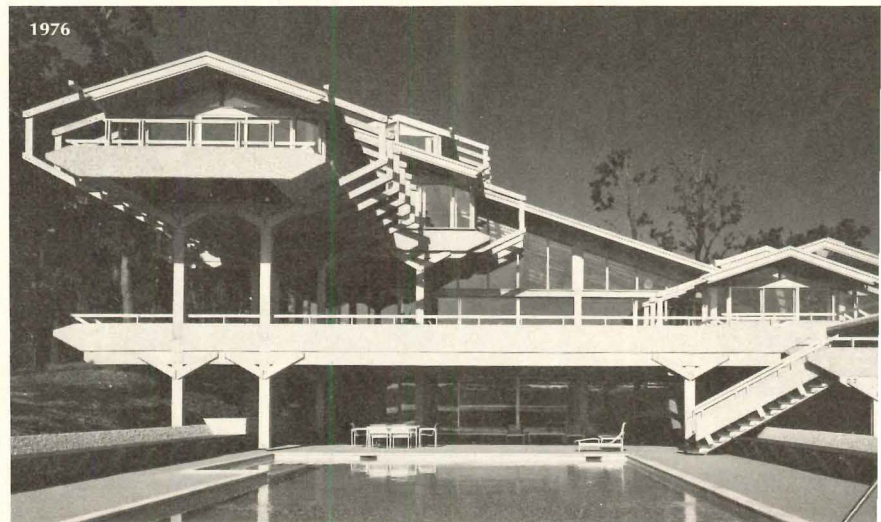
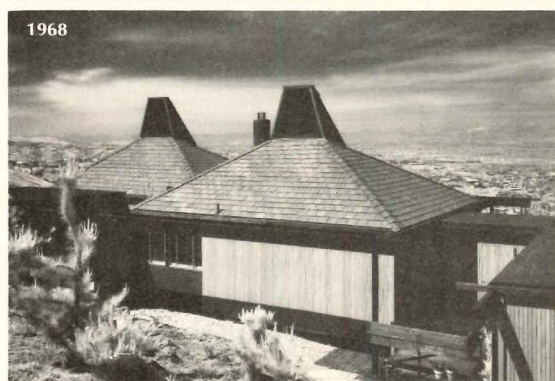

Both award programs are open to any architect registered in the United States and submissions of unpublished work will be welcome for Record Interiors until October 1, 1976 and for Record Houses and for Apartments until November 1, 1976. No formal presentation requirements are made, though materials submitted should include plan(s), photographs, and a general description of the project. Submissions will be returned but not before date of publication.

### For more information:

Barclay F. Gordon, Architectural Record  
1221 Avenue of Americas  
New York City, 10020  
Telephone (212) 997-2334

OR

Janet Nairn, Architectural Record  
425 Battery Street, San Francisco, Cal. 94111



These oxfords have stridden through the offices of PATH for over a year.



Good thing the floors are carpeted with Anso<sup>®</sup> nylon. It's guaranteed for 5 years.

The New Jersey administrative offices of a thronging urban public transit system can often be as busy as the system itself. So when the Port Authority Trans-Hudson Corporation wanted a carpet that was not only attractive but extremely durable, buyers chose this level loop of ANSO anti-soil nylon.

It's backed by the Allied Chemical Guaranteeth<sup>®</sup>: the guarantee with teeth. It promises that if any carpet of Anso nylon wears more than 10% over five years, Allied Chemical will replace it free.

The Guaranteeth also applies to Anso-X, the anti-shock version of Anso nylon. Carpets of Anso-X are also guaranteed anti-static for the useful life of the carpet.

Discover what more and more architects and specifiers are discovering about Anso nylon. Phone or write: Allied Chemical Corporation, Fibers Division, Contract Dept., 1411 Broadway, New York, N.Y. 10018. (212) 391-5069.









# Create a four star atmosphere with a Tonico Solitude Ceiling.



To connoisseurs, four stars are an international symbol of excellence. A creative menu and an expansive wine list are two of the criteria that any four star restaurant must meet. Another is atmosphere.

Gold Bond® Tonico® Revealed Edge Ceiling Panels add the right touch of elegance to the interiors of restaurants, offices and specialty shops. Tonico Panels absorb sound and the edge reveal provides an attractive three-dimensional effect. Together, they tastefully complement a luxurious interior.

The Tonico Solitude Panels come in fissured and nondirectional fissured patterns. The vinyl base finish has excellent washability, for easy maintenance.

Tonico Solitude Panels are as functional as they are beautiful. With NRC's up to .60 and STC's up to .41, noncombustible Tonico Panels offer an exciting array of hidden virtues that any designer will appreciate.

If you demand elegance and performance, don't compromise. Insist on Gold Bond Tonico Solitude Panels.

For more information, call your local Gold Bond representative, refer to Sweet's File 9.1/Go., or write Gold Bond Building Products, Division of National Gypsum Company, Dept. AR-96CS, Buffalo, New York 14225.

**We're gypsum,  
and then some.**





Architectural Record presents...

**fifteen  
issues  
a year  
for  
architects  
& engineers** | **one  
each  
month...  
and three  
spotlight  
issues**

The editors of Architectural Record regularly throughout the year present a wide variety of editorial content specifically geared to the known interests of architects and engineers.

In addition, responding to the need of architects and engineers for in-depth presentations of significant trends and developments in major areas of interest, the editors of Architectural Record each year publish three Spotlight issues. Each is an expansion of a continuing feature in the regular issues of the Record.



**RECORD HOUSES  
AND APARTMENTS**

The annual mid-August issue, devoted to a comprehensive survey and analysis for architects and engineers of the most significant current developments in engineering for buildings. Bonus coverage of newly active building engineers.



**ENGINEERING  
FOR ARCHITECTURE**

The annual mid-May issue devoted to the year's best architect-designed houses and apartments. More than 45,000 architect and engineer subscribers . . . plus distribution to 20,000 Sweet's-qualified builders and 4,000 Sweet's-qualified interior design offices.



**PRODUCT REPORTS**

The annual mid-October round-up of the most interesting new and improved building products. Organized by the Uniform Construction Index, this "product file on the drawing board" provides a quick up date of out-of-date catalogs and literature.





# New Design Guide for Textured Structural Tile



Request this free, 8-page color folder which illustrates a variety of textured tile installations and gives complete back-up data.

## Textured tile styles:

Relief, random textures  
Tone colors

- virtually maintenance-free surface for the life of the building
- interior or exterior walls with desirable fire ratings



### Stark Ceramics, Inc.

P. O. Box 8880  
Canton, OH 44711  
(216) 488-1211

For more data, circle 129 on inquiry card



## Raynor we deliver!

Everyone knows how important planning and coordination are on a construction project. That's why we're as concerned with delivering our product as we are with installing it. We have our own trucks on the road all the time on pre-scheduled runs. And, because a load is carefully checked by our own people, chances of damage are kept to a minimum.

It's this extra concern for quality that's made Raynor a

brand you can depend on for residential, commercial and industrial doors made of wood, aluminum, fiberglass or steel.

Call us for more specifics. 815/288-1431. Or write Raynor Manufacturing Company, Dept. AR, Dixon, IL 61021, for the name of the Raynor factory-trained distributor / installer nearest you.

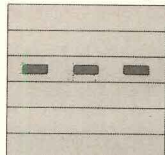

**RAYNOR™**

Raynor Manufacturing Company, Dixon, Illinois 61021

For more data, circle 130 on inquiry card

## for better communications ...for superior sound

specify **Rauland**

advanced new communications systems



Unique TELECENTER II systems provide a new concept in internal telephone communications, especially ideal for schools, combining familiar pushbutton operation with a wealth of versatile features, including exclusive Digital Readout which identifies callers sequentially. New TOUCH-COM intercom systems are remarkable for their low-cost practical utility to provide dependable two-way communications for business and industry.

For more data, circle 131 on inquiry card

## extended health care facility communications

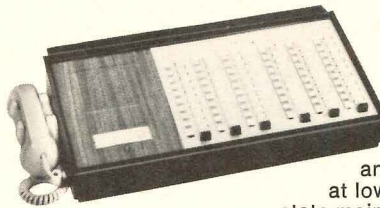

Rauland Visual and Audio-Visual CALL-A-NURSE Systems are U/L Standard 1069 approved.

They are designed to provide effective patient-nurse communications and to maximize nursing care at lowest cost-per-bed. All-solid-state maintenance-free design; easily expandable as needs grow; surprisingly low in cost.

For more data, circle 132 on inquiry card

## professional sound reinforcement systems

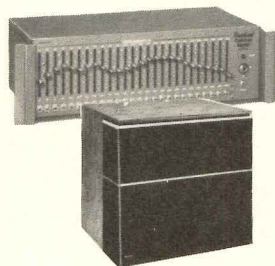

The exclusive Rauland Spectrum-Master Equalization technique, integrated with matched amplifiers and speaker systems, achieves theatre-quality sound even in the most adverse acoustical environment. Systems are available for every sound reinforcement need—for theatres, auditoriums, halls, churches, gymnasiums, arenas. Rauland has the right custom-fitted audio system for any application.

**ASK FOR FULL DETAILS** An Authorized Rauland Communications and Sound Specialist in your area is ready to provide complete information and engineering data for your consideration and use. Write us today, or use the reader service card.

For more data, circle 133 on inquiry card



quality's other name in  
Sound and Communications

**RAULAND-BORG CORPORATION**

3535 W. Addison St., Dept. R., Chicago, Ill. 60618 • 312-267-1300



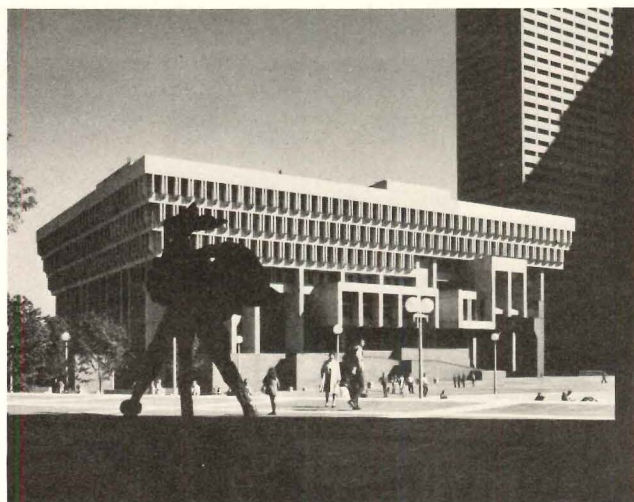
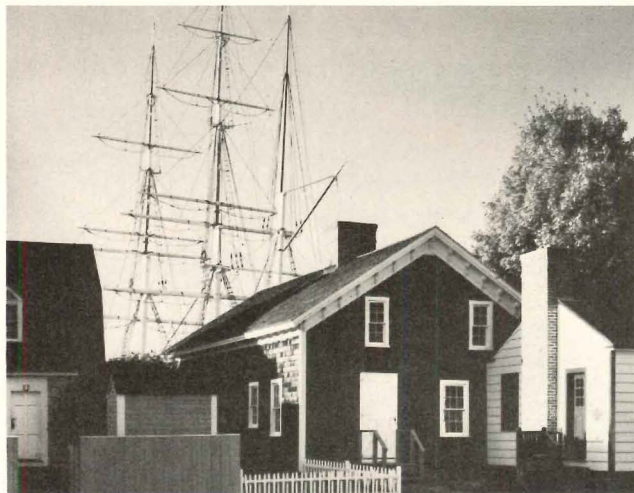
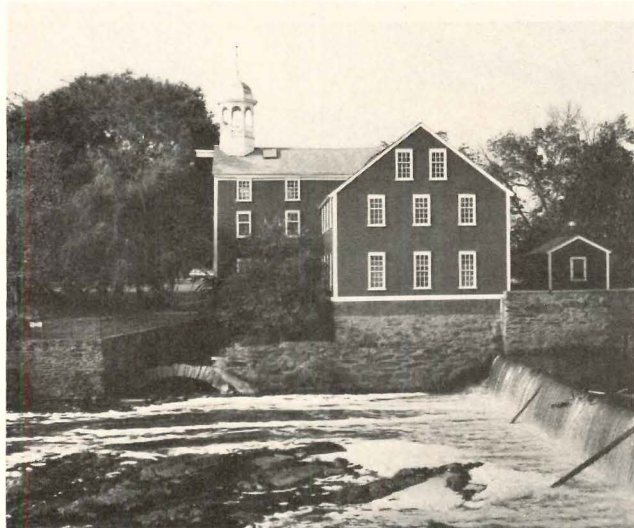
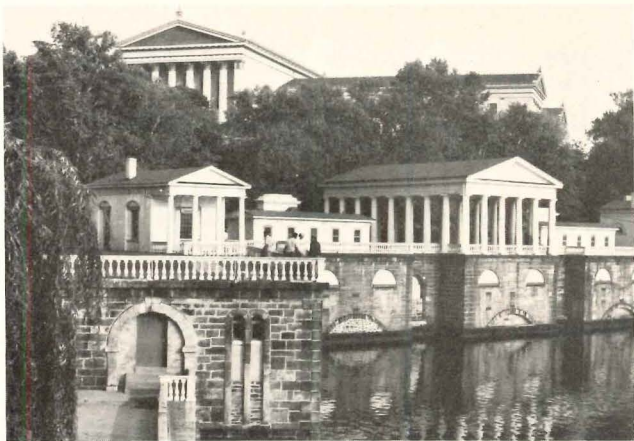

# The All-New 1977 Calendar of Historic Architectural Event

The 1977 Architectural Calendar is better than ever! It is all new... 365 more historic events in architectural history and 13 more stunning architectural photographs by award-winning architectural photographer G. E. Kidder Smith, FAIA. And, for the first time, this year's calendar is designed to be used as a write-in desk calendar as well as a wall calendar! They said it couldn't be done, but the 1977 Architectural Calendar continues its daily commemoration of memorable architectural events... famous figures in architecture and engineering... births and deaths of the world's greatest architects and engineers... significant, amusing and little-known facts that inform and surprise even the most knowledgeable...

- The day Palladio was fined for absenteeism from the construction site
  - The day the Parthenon was "rediscovered" during the Renaissance
  - The day that Latrobe complained that architecture wasn't a profession for a gentleman"
  - The day Michelangelo began painting the Sistine Chapel
  - The day Thomas Jefferson insured Monticello—for \$6300
  - The day Inigo Jones loaned his client (and King) £500
  - The day the Congressional Medal of Honor was awarded to a famous American architect
  - The day Disneyland opened
- ... these and hundreds of other bits of history make the 1977 Architectural Calendar a valuable source of architectural knowledge and a true collector's item.

Illustrated with 13 beautiful, full-color photographs illustrating the architectural heritage of the United States, this calendar will make a handsome and decorative addition to your home or office and would make a much-appreciated (and inexpensive) gift. This strikingly designed calendar is printed on luxurious enamel stock in an oversized, 9x12" format. Only a limited number of calendars are being printed this year, so in order to avoid disappointment, order today! Send your payment for \$5.00 to Architectural Record Books, 1221 Avenue of the Americas, 41st Floor, New York, NY 10020, or use the handy order blank below.

.....  
**Architectural Record Books**  
 1221 Avenue of the Americas, 41st Fl.  
 New York, New York 10020

Please send me \_\_\_\_\_ copies of **The 1977 Architectural Calendar** @ \$5.00 each.

Name \_\_\_\_\_

Address \_\_\_\_\_

City \_\_\_\_\_

State \_\_\_\_\_ Zip \_\_\_\_\_

Payment must accompany your order



Gresham and Smith, Architects, design buildings to meet the needs of clients as translated from clients.

The eighty physician medical clinic presented Gresham and Smith's architect design team with a variety of needs:

MAXIMUM FLOOR PLAN FLEXIBILITY

UNIFIED EXTERIOR TREATMENT

CAPABILITY FOR SHELL-IN SPACE AND VERTICAL EXPANSION

PATIENT PRIVACY AND COMFORT

MAXIMUM NATURAL ILLUMINATION IN PATIENT TREATMENT AREAS

MINIMAL HEAT GAIN/HEAT LOSS

MINIMAL EXTERIOR SOUND TRANSMISSION

Architecturally and economically, the Disco Window system provided the Gresham and Smith team with a solution to each of these challenges.

## Architects for the Medical Center Clinic in Pensacola prescribed Weathertrol Windows



**DISCO ALUMINUM PRODUCTS, INC.**

*For more data, circle 134 on inquiry card*

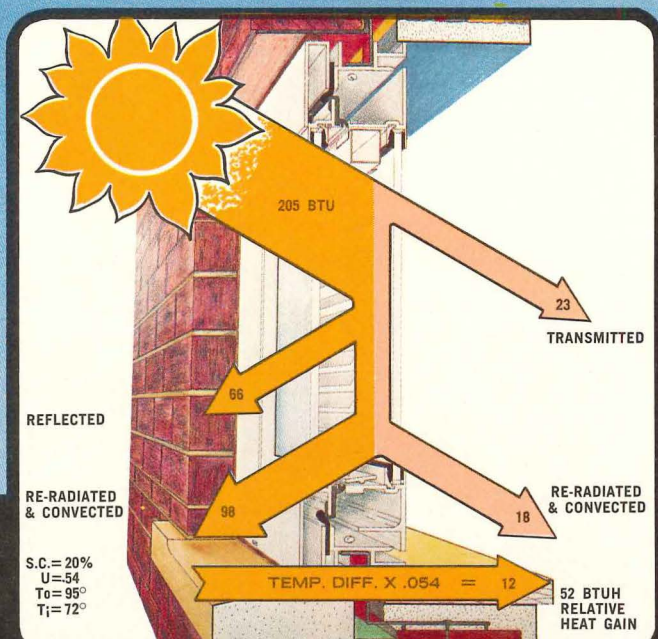

Architect  
Gresham and Smith, AIA  
Nashville, Tennessee

General Contractor  
Joe M. Rodgers and Associates, Inc.  
Nashville, Tennessee

Windows  
Disco Aluminum Products, Inc.  
Selma, Alabama

Glass Contractor  
Nelson/Brantley Glass Company  
Montgomery, Alabama

Glass  
Libbey-Owens-Ford 214 Gold Vari-Tran®  
Toledo, Ohio



For more information write  
Disco Aluminum Products, Inc.  
Post Office Box 325  
Selma, Alabama 36701



# See it our way.

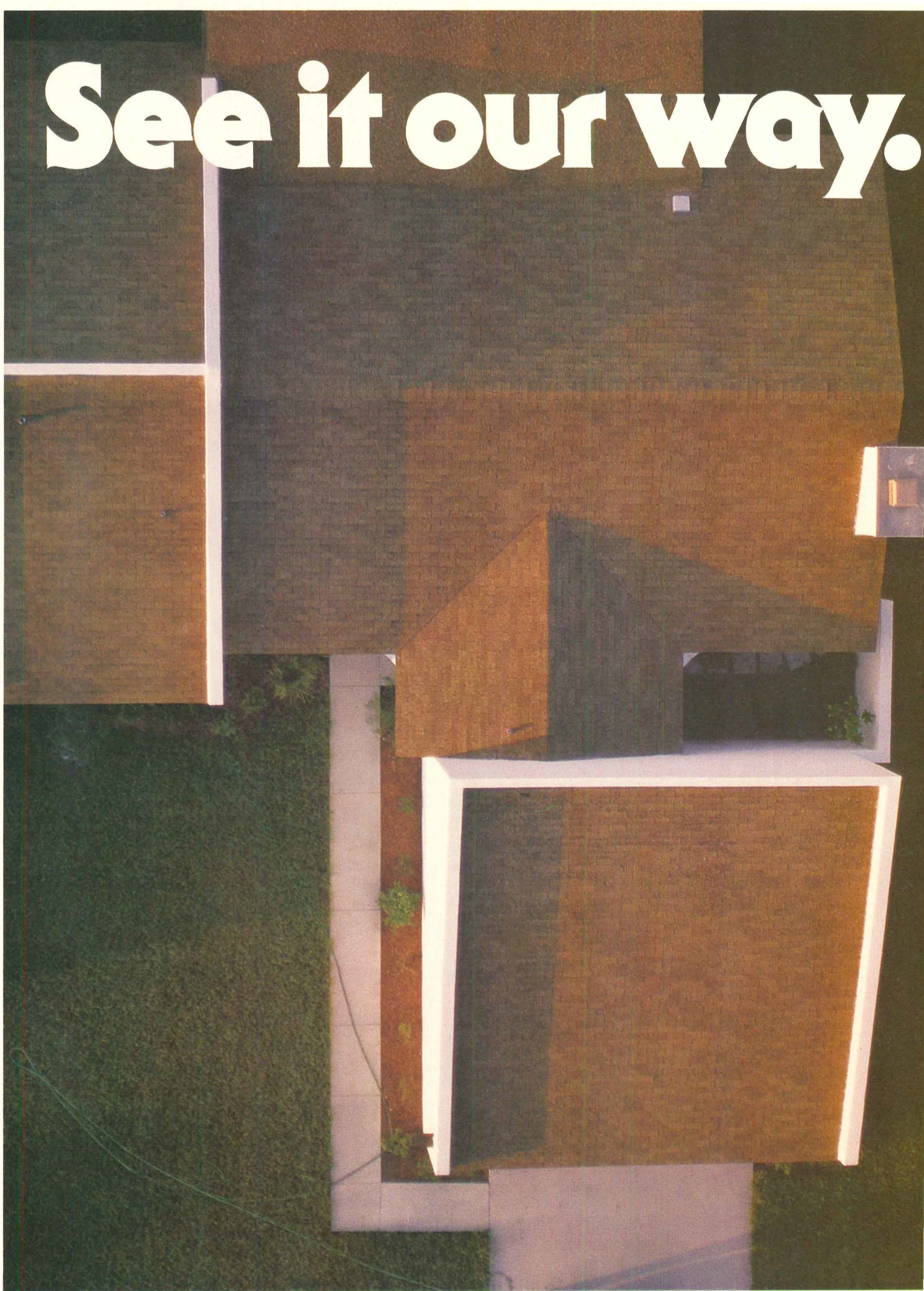



**Specify Glasstex\*—the only Class “A” textured surface fiber glass shingle in the business. (From CertainTeed, who else.)**

You've never had it so good! Beautiful, fiber glass, self-sealing, wood-grain-textured shingles. For added protection against fire and wind.

Glasstex textured fiber glass shingles are now available in 5 versatile colors that will last the life of the roof. And that life is backed by our 25-year limited warranty against defects. Practically speaking, that's  $\frac{2}{3}$  longer than conventional shingles, because our Glasstex shingles are made to last longer.

But the more you find out about Glasstex textured fiber glass shingles, the more we think you'll see it our way.

For a complete product description write:

Glasstex, CertainTeed Corporation,  
P.O. Box 860, Valley Forge, PA 19482

\*Glasstex is the registered trademark for textured fiber glass shingles from CertainTeed Corporation.



# Glasstex

**Textured fiber glass shingles. (From CertainTeed, who else.)**





Many world famous amusement parks and recreational areas.

# “Imagineering” in light.

**From custom lighting a fantasy land—to creating a nighttime environment of beauty for offshore drilling islands.**

**Let Hubbell Lighting’s custom capability work for you.**

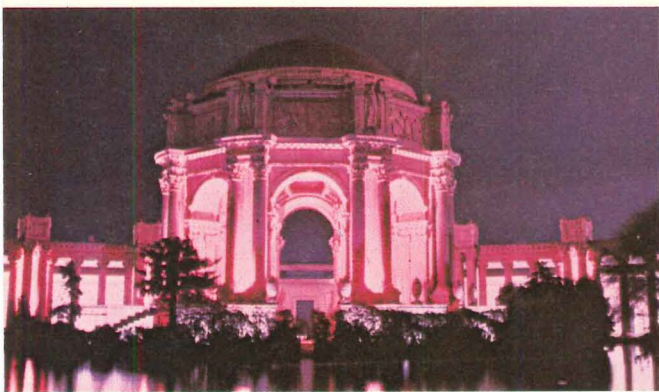

The Palace of Fine Arts in San Francisco. Century 21, one of a number of World Fairs with custom lighting.

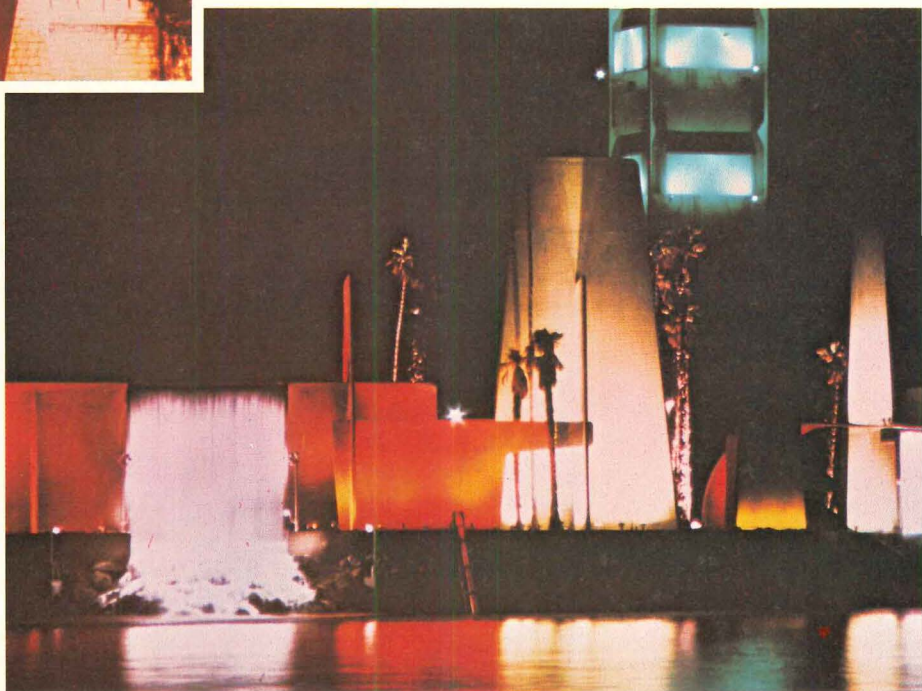

A beautiful nighttime environment at an offshore drilling island.

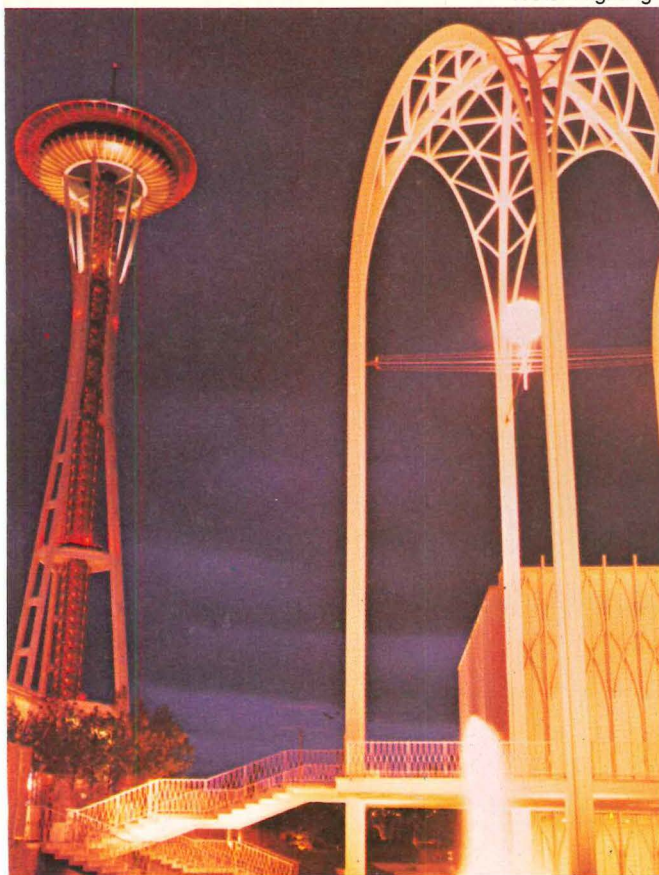

Turning lighting concepts into reality. That's what Hubbell Lighting is all about. And our custom capability throughout the nation speaks for itself. In shopping centers. College campuses. Commercial and industrial buildings. Whatever the decorative or functional need—Hubbell Lighting can provide the answer.

At Hubbell Lighting, we have a reputation for handling one-of-a-kind challenges. Challenges that range from lighting the hold of a cargo ship—to growing roses. Some of our most imaginative solutions illuminate amusement parks and recreational areas, today. Plus many World Fairs in the past. For over a quarter of a century, our creative engineering has been solving unique lighting problems like these. Solving them with imagination and total practicality.

When you're looking for something special, look to Hubbell Lighting. From innovative custom designs to the manufacturing of special products—we handle it all. And we back it up with the most extensive photometric and performance testing in the industry.

Put our imagination to work for you. Contact your local Hubbell Lighting representative or our custom design specialists today. Call 703/382-6111.



**lighting division**

**Harvey Hubbell Incorporated** Christiansburg, Virginia 24073

*For more data, circle 136 on inquiry card*



Take it from Dave Lennox . . .  
**THIS NIFTY WEATHER  
MACHINE IS YOUR  
ANSWER TO**

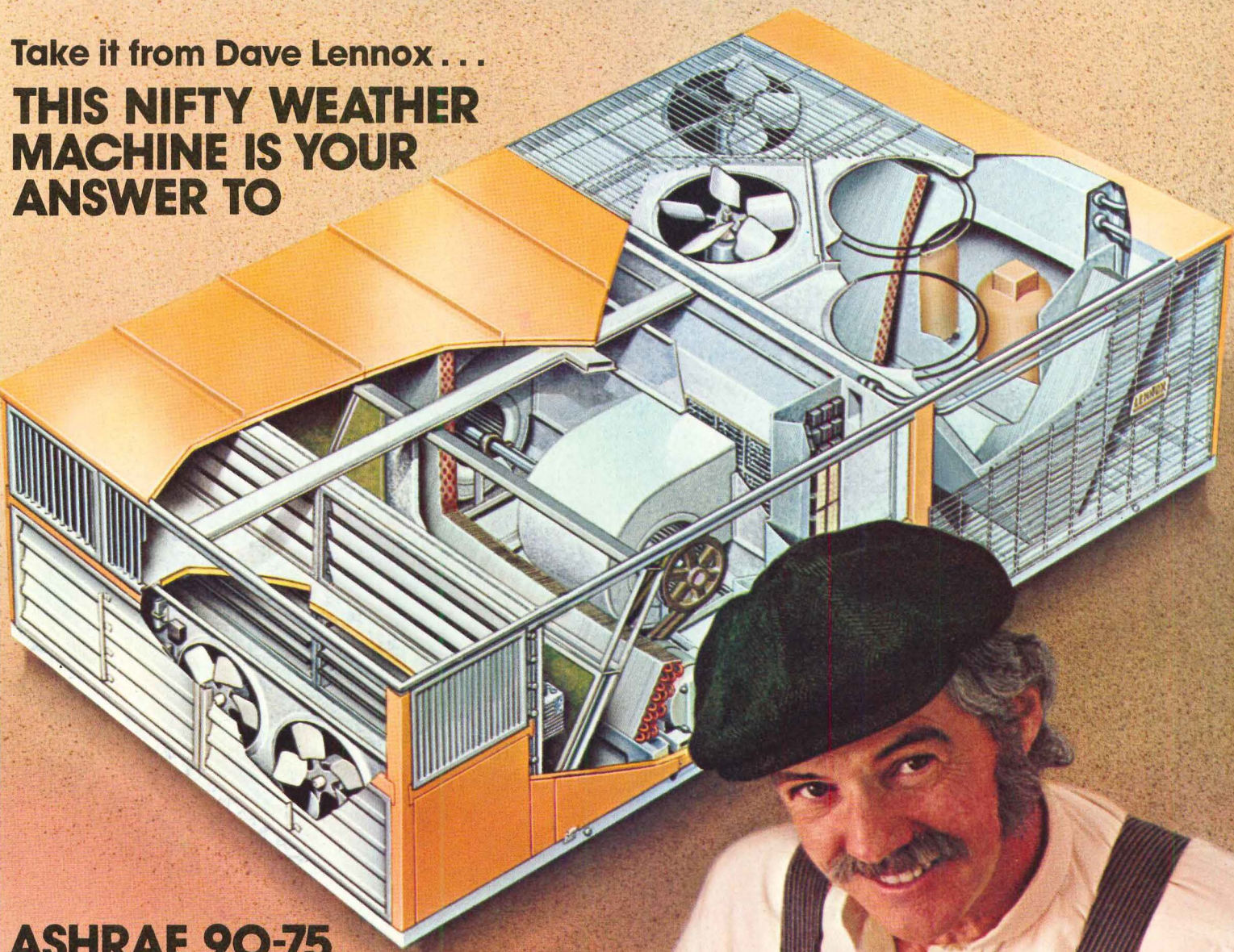

## **ASHRAE 90-75 ENERGY GUIDELINES.**

The new Lennox DSS1 system lets you design your own single zone HVAC package to surpass ASHRAE 90-75 energy guidelines. The DSS1 offers extraordinary flexibility . . . efficient operation and service . . . exceptional energy savings . . . and consequent cost savings.

Here are a few of the many DSS1 options that give you the right size, right energy, right cost for your application:

- 26 to 45 tons cooling; up to 950,000 Btuh heating.
- Two-speed, first stage compressor saves energy.
- Heat recovery package (allows recovery of heat from refrigeration in supermarkets and restaurants; controls humidity without losing heat).
- Power Saver™ package (allows use of outdoor air for cooling).
- Power Saver II™ (allows recovery of heat from lighting).
- Latent Load Discriminator™ (increases partial-load EER up to 30%).
- Heat pump options available soon.
- Solid state, energy-saving control system.

Get the facts.

For complete information, see your Lennox Territory Manager. Or write: Lennox Industries Inc., 673 South 12th Avenue, Marshalltown, Iowa 50158.

**LENNOX**  
AIR CONDITIONING • HEATING

"Attaboy,  
Dave!"

**Nifty problem-solving ideas from Lennox.**

For more data, circle 137 on inquiry card





**"Today most contract draperies are flame resistant. It's the smoke you have to worry about.**

**That's why I chose fiber glass!"**



**Fire destroys.**

But it's the smoke that causes many of the human casualties when a fire breaks out in a building.

So when you are selecting materials for the interior of your building, don't just look at their flame resistance. Like Mr. Grove, look for smoke protection.

The fiber glass fabric he chose meets all applicable flammability standards. It's classified "noncombustible" by Underwriters' Laboratories. It won't support combustion, drip or continue to burn after heat or flame is removed. And fiber glass yarns are so naturally

resistant to combustion or thermal decomposition that properly finished fabrics woven from them emit no significant smoke when exposed to flame or intense heat.

This is not true of many widely used contract fabrics. Is it true of the fabric you are considering?

Write to us for a sample of the Madison Hospital fabric and for information on other fire- and smoke-rated drapery fabrics. PPG Industries, Inc., Fiber Glass Division, One Gateway Center, Pittsburgh, Pa. 15222.

**PPG: a Concern for the Future**

*For more data, circle 138 on inquiry card*

**Homer Grove, Administrator  
Madison Hospital  
Madison, Tennessee**

Fabrics of PPG Fiber Glass  
from the John Whipple Collection  
of Haag Brothers, Inc.  
Chicago—Atlanta—Los Angeles

**Fiber Glass**





**One call brings  
Lyon quality  
to both offices  
and plants!**

You're in good company when you go Lyon all the way: with quality office furniture and steel equipment for convenience and storage. Lyon office furniture offers exciting options—plush or price, as your taste and budget decide. And we put the same careful craftsmanship into Lyon steel equipment

for plant use. Over 1600 items with proven Lyon quality, conscientious Lyon service.

Your Lyon Dealer will work closely with you, taking advantage of our four strategically located plants to assure fast delivery. And he'll follow through, in both office and plant, from early layout plans through the

final installation.

So why make two calls for office furniture and steel equipment? Get it all from your Lyon Dealer.

Lyon Metal Products, Inc., General Offices, Aurora, Ill. 60507. Plants in Aurora, Ill., York, Pa., Los Angeles. Dealers and Branches in all principal cities.



LYON METAL PRODUCTS, INC.  
951 Monroe Avenue, Aurora, Illinois 60507

Please send me a current Catalog  Please have a salesman call

Name \_\_\_\_\_

Firm \_\_\_\_\_

Address \_\_\_\_\_

City \_\_\_\_\_ State \_\_\_\_\_ Zip \_\_\_\_\_

We're in the Yellow Pages under LYON "OFFICE FURNITURE", "STEEL SHELVING", "LOCKERS" and "SHOP EQUIPMENT"



# CLASSIFIED SECTION

## POSITIONS VACANT

### VOLUNTEER PEACE CORPS/VISTA

Architects/planners needed for Peace Corps projects in Latin America, Africa, Asia; VISTA projects in U.S. Housing projects, design of schools, hospitals, community centers, rehab., university teaching, regional planning, etc. Expenses paid: travel, medical, vacation and living. U.S. citizens, singles or couples only. Information: Cynthia Poindexter, ACTION, Box A-1, Washington, D.C. 20525.

**University of Petroleum & Minerals-Dhahran, Saudi Arabia-** A newly established Architectural Engineering Department at the University of Petroleum & Minerals, Dhahran, Saudi Arabia, has a faculty position opening for an architect or architectural engineer with teaching and/or practical experience in architectural design. Minimum two-year renewable contract, competitive tax free salaries plus housing, transportation to and from Dhahran each two-year tour with annual two months' paid vacation plus other allowances and benefits in policy. Apply immediately with complete resume indicating marital status, age, nationality, home and office addresses and telephone numbers to: Dean of Faculty & Personnel Affairs, University of Petroleum & Minerals, Dhahran, Saudi Arabia.

**Architect-Engineer firm, nationally ranked in top 400,** seeking experienced person or persons, with established contacts and proven track record at marketing Architect-Engineer services for its southeastern regional office. Clientele desired includes full scale industrial and broad range of architectural. Reply with resume, P-1519.

**Architects-Design & Project Management . . .** Designer and builder of medical buildings and schools seeks architect with experience in medical field. Must have good design ability with leadership and administrative skills to supervise projects from client-contract through completion. Compensation package consists of excellent salary, bonus's, profit sharing, and other fringes plus advancement on merit. For prompt interview write or telephone Harry Case daily 1/414/437-4353 or at home evenings and weekends 1/414/435-0685. Management Recruiters, 115 S. Jefferson, Suite 302, Green Bay, Wis. 54301. Licensed employment agent.

**Architect: Position available with well established, 100 man and growing, midwestern A/E firm** as lead designer. Responsibilities would include development of design concepts, directing the architectural design effort of the entire firm and minor participation in marketing efforts. National, regional, or at least, high level local recognition for past work considered essential. Experience would ideally include a similar position with a smaller firm or an immediate subordinate position in a larger firm. Equal Opportunity Employer. Write KZF Environmental Design Consultants, Inc., 2830 Victory Parkway, Cincinnati, Ohio 45206.

**Head, School of Architecture—Oklahoma State University.** Nominations and applications are sought from architectural educators and practicing architects interested in providing educational leadership to approximately fifteen faculty members and three hundred students. Applicants should submit complete addresses. Closing date is October 31, 1976. Send inquiries and materials to Professor Alan W. Brunken, School of Architecture, Oklahoma State University, Stillwater, Oklahoma 74074. The University is an equal opportunity/affirmative action employer.

**Lead Architect for inter-disciplinary firm in Midwest University community.** Associate status available to right man on a proven basis. Send complete resume, present earnings and personal objectives to P-3053, Architectural Record.

## POSITIONS VACANT

**Leading career education center has immediate opening for faculty in AIA-approved architectural technology program.** Baccalaureate degree in architecture and office experience necessary; registration and teaching experience desirable. Curriculum includes drafting, graphics, history, working drawings, design, engineering, estimating and specifications. Send resume to: Dr. Eleanor Bushee, Associate Dean for Academic Affairs, School of Technical Careers, Southern Illinois University at Carbondale 62901. An equal opportunity employer.

**Executive Manager: Expanding Architectural firm in southern city.** Responsibilities include implementation of production monitoring system, personnel development, scheduling project manpower, maintaining professional consultant pool, contract preparation, computer orientation. Confidential resume, salary requirements to P-2900, Architectural Record. Interviews developed with candidates.

### POSITION WANTED

**Financial Executive—Heavyweight—Listed co. V.P., Controller—CPA (Big 8 exp.)—Attorney—Acquisitions, financial controls, taxes, Exp'd. real estate, construction industries.** Combines technical skills with imagination. \$28-32,000 required. For resume: PW 3080 Architectural Record.

**Architect, 36—NCARB, 12 years diversified experience in design, production and office supervision,** seeks permanent and challenging position anywhere in the U.S. Conscientious, highly productive and personable. Some travel o.k. Reply to: PW-3082, Architectural Record.

**Architectural Management Consultant. Business degree, experience in all phases of architectural practice.** Seeking management position in medium to large size firm. For resume: PW-3031, Architectural Record.

**Registered Iowa Architect desires position with challenge and responsibility,** all types of projects from client contact to completion. PW-2016, Architectural Record.

**Architect: Former principle, small firm, 15 years experience in client contact, design, office management, project coordination, and field supervision—all phases of construction,** seeks challenging career opportunity. Portfolio. Will relocate. PW-3017, Architectural Record.

**Architect, Registered, with excellent design capabilities and 6 years of diversified experience,** seeks position as Project Architect/Designer. Will relocate, for particulars reply: PW-2985, Architectural Record.

### EQUIPMENT FOR SALE

**Charrette/White Flat Files: self-contained file with integral cap.** Drawers operate on ball bearing rollers/hinged front depressors. Stack units to any height. White files blend well with any office decor. Four sizes for immediate shipment in wooden/crates. Mail orders and information: Charrette Corporation, 2000 Massachusetts Avenue, Cambridge, Massachusetts 02140.

**82 air conditioning/heating units. Brand new. 277 volts.** From discontinued motel project. Quick Sale. 914-737-4582.

### LITERATURE

**Free Construction Management Publication.** Write for your free sample copy of CM World Newsletter and information on the 1976 Owner Construction Guidelines and CM Directory. You will appreciate learning about this helpful service if you are involved with the CM, construction or design industry. Write CMW, P.O. Box 1-A, Westerville, OH 43081, or call 641-882-4388.

## PROFESSIONAL SERVICES

### Kinsey Architectural Arts

Come to the source: We're architectural rendering specialists, responsive to the architects cost and quality standards. Phone for instant project price quotation and particulars. Illustrated color brochure with full details forwarded.

2509 Sylvania, Toledo, Ohio 43613  
Tel. (419) 475-7011



### MATERIALS HANDLING CONSULTANT

**DISTRIBUTION CENTERS**  
Warehousing and Storage Arrangement  
Equipment Design and Specifications

Twenty Years of Successful Practice  
Metropolitan New York  
Fee or Per Diem

**PETER GONDELL**  
19 Crest Drive · White Plains, N.Y. 10607

**'Nationwide Architectural Rendering Service'—3 day national C.O.D. service. 10" x 17" B/W \$50.00—Color \$85.00.** Send check or purchase order with plans to Larry R. Anthony, Box 8254, Canton, Ohio 44711 or call 216/863-0425.

### SPECIAL SERVICES

**Consulting Structural Engr., BSCE, MSCE, PE (NY, NJ, PA.), 18 yrs. diversified experience in buildings & structures, offers design, drawing & spec. writing services at reasonable charges.** SS-1320, Architectural Record.

**Vitruvius Designs Corp.—artistic renderings & scale models for a better image.** Regular drafting services available. Box 1316 Dept. AR, Radio City Sta., New York, NY 10019. (212) 697-5499.

**Confidence Levels in Estimates. Computer assisted Monte Carlo simulation takes your estimate and data and assigns reliability for \$35.00 cost.** Engineering Analysis, Dept. AR, 1430 St. Marc, #703, Montreal P.Q. (514) 932-4336.

**Architectural Illustration guides, tree stamps, transfer sheets—free catalog.** Instant Landscape—20 Whaleship Plaza, San Francisco, CA 94111.

### ARCHITECTURAL ARTS

**Architectural Arts—Ink drawings—presentation renderings/perspectives. Color schemes—finishes. Models.** David 1-819-684-8320. Ottawa

### BUSINESS OPPORTUNITY

**Architect—To manage Elizabethtown, Kentucky office.** Must have construction experience and willing to relocate. Will consider limited partner. Cox & Associates—Architects 502-267-8746, 3309 College Drive, Louisville, Kentucky 40299.



**Medical Gas Handbook for Hospitals.** "The Design Handbook of Medical Gas Systems for Hospital and Medical Facilities" by Richard H. Toder. This handbook contains the latest design criteria for oxygen, nitrous oxide, nitrogen, vacuum and compressed air systems including: pipe sizing charts and tables • illustrations • description of systems • bulk and manifold storage • gas dispenser types and recommended locations • piping design including materials, valves, alarms, and installations • compressor and vacuum pump types, sizing and selection. \$10.95 per copy. Send check to Richard H. Toder, 141 E. 89th St., New York, NY 10028.

**Europe: Architectural Guide 1860-Today** by Eryll Habegger. 13 countries-500 Bldgs. with address, architect + date. 150 Illus. \$4.50. Order from: Architectural Guidebook, 421 West Belden, Chicago, Illinois 60614.

## FOR SALE

**Walter Burley Griffin Plan for Canberra**—Authentic color reproduction as poster 20" x 28" of his prize-winning entry in the 1911 international competition for the design of Australia's national capital. This plan is printed by permission of the Australian Government to mark the centenary of Griffin's birth in Chicago. Poster contains a biography of the man and his work and two photographs of Griffin and his wife, Marion Burley Griffin. Unique opportunity. Quality poster can be framed for display. Price only \$5.95, which includes packaging and postage by sea mail. Add U.S. \$2 for airmail. Order from Clareville Press, P.O. Box 8, Torrens, S.C.T., Australia, 2607.

## NOTE:

### NEW McGraw-Hill EQUIPMENT BULLETIN

The used, surplus, and rebuilt equipment ads in this Classified Advertising Section will also appear, at no extra cost, in the McGraw-Hill Equipment Bulletin.

This new free monthly reprint will reach an additional audience of qualified cost-conscious readers (who have requested it) in fields served by 27 other McGraw-Hill publications.

To find out how you can benefit from this bonus readership when you have items for sale, lease, or rent—contact the Classified Advertising representative in the McGraw-Hill regional office nearest you, or write to:

### McGraw-Hill EQUIPMENT BULLETIN

P.O. Box 900, New York, N.Y. 10020



## OFFICE NOTES

### Name changes, new firms

**Christopher D. Craiker** and **David C. Hanchette**, planners and architects, announce the opening of their office in the Shelter Bay Office Complex at 655 Redwood Highway, Suite 301, Mill Valley, Calif.

**Gensler and Associates** architects have moved to larger facilities located at 248 Battery St., San Francisco, Calif.

The architectural firm of **Barry E. Milowitz, architect, p.c.**, has relocated its offices to three new locations: 455 Central Avenue, Scarsdale, N.Y., 277 Northern Blvd., Great Neck, N.Y., and 405 Lydell Ave., Rochester, N.Y.

**Armand Bartos and Associates**, architects, have moved their office to 10 East 40th St., New York, N.Y.

**Frost Associates Architects, Frost Interior Design, Inc.** announce the opening of a Westchester office at 503 Grasslands Road, Valhalla, N. Y.

**Cohos, Evamy & Partners**, architects, engineers, planners, interior designers, announce the relocation of their offices to 902-11th Ave., S.W., Calgary, Alberta T2R OE7.

John H. Hadley, Jr., AIA, has formed his own firm, **Hadley/Architects**, headquartered at 335 N. La Cienega Blvd., Los Angeles, Calif.

**C. Randolph Wedding, AIA**, St. Petersburg, Fla. architectural/planning firm, and **Allott and Lomax**, consulting civil engineering firm, Manchester, England, have formed a professional association offering their combined architectural/engineering services.

### New associates, promotions

The Perkins & Will Partnership, architects, have appointed **Stanley Pinska** and **Richard S. Thomas** as associates.

The Kling Partnership, architectural, engineering and planning firm, have announced the appointment of **Berdell Buckley** as director of business development.

**Philip A. Nicholas, AIA**, has joined Albert Kahn Associates, Inc., architects and engineers, as manager of marketing.

Stone, Marraccini and Patterson, architects, planners and health planning consultants have announced that **Dr. Robert H. Chapman, AIA, AAHC**, will assume major responsibilities in development of the firm's health planning and health facility projects.

**Edward R. Jones, Jr., AIA**, and **Richard C. Niblack, AIA**, have been named senior vice presidents and members of the executive committee of Charles Luckman Associates.

Poor, Swanke, Hayden & Connell Architects, announce that **Der Scutt AIA** has become a partner in the firm and that **Ralph A. Krass AIA** and **Susan Podufaly Schaub AIA** have become associates.

**John S. Crane, James B. Gwin, Jr.**, and **Allen Rice** have been named partners in the firm of Golemon & Rolfe, architects.

### Erratum

On page 61 of the July 1976 issue, we neglected to indicate that the second set of cost figures published for "Warehouses" refers to "Refrigerated Warehouses."

## IN THE CAUSE OF ARCHITECTURE FRANK LLOYD WRIGHT

### WRIGHT'S HISTORIC ESSAYS FOR THE FIRST TIME IN ONE VOLUME

### Essays for Architectural Record 1908-1952

With a symposium on architecture

EDITED BY  
FREDERICK GUTHEIM

Now for the first time ever, the seventeen historic essays Frank Lloyd Wright wrote for *Architectural Record* are collected in one definitive volume. In *The Cause of Architecture*, Wright's major statement of his architectural philosophy, is an essential key to understanding this creative giant.

Reproduced in their entirety and in their original format as they appeared in the pages of the *Record*, these essays give penetrating insights into the mind of an architectural genius at the time he was creating his most significant works.

This handsome, 256-page volume is illustrated with hundreds of photos, drawings, plans and perspectives of F.L.L.W.'s greatest buildings as well as a fascinating photo-essay of never-before-published pictures of Wright taken shortly before his death.

Edited by noted Wright authority Frederick Gutheim, the book also includes a symposium of eight essays by Wright's associates that take a new look at the life and work of America's greatest architect.

*In the Cause of Architecture* will be of lasting interest to architects, students, and all those interested in Wright—a basic reference for school, home and office libraries. Beautifully designed, it will be a treasured gift for years to come.

Architectural Record Books AR-9-76  
1221 Avenue of the Americas, 41st Fl.  
New York, New York 10020

Please send me \_\_\_\_\_ copies of  
*In the Cause of Architecture: Frank  
Lloyd Wright* @ \$17.50 each.

Name \_\_\_\_\_

Address \_\_\_\_\_

City \_\_\_\_\_

State \_\_\_\_\_

Zip \_\_\_\_\_

Payment must accompany order \_\_\_\_\_



# ADVERTISING INDEX

Prefiled catalogs of the manufacturers listed below are available in the 1976 Sweet's Catalog File as follows.

- A Architectural File (green)
- I Industrial Construction File (blue)
- L Light Construction File (yellow)
- D Interior Design File (white)

**A**

Acco-Page Fence Division	188
A AllianceWall Corporation	25
Allied Chemical Corp., Fibers Div.	199
All-Steel Inc., One of the C.I.T. Companies	66
Aluminum Co. of America	26, 96
A Amarlite Products Div.	57
American Iron & Steel Institute	6-7
A-I-L American Plywood Association	48
A-L Andersen Corp.	30-31
Appleton Electric Co.	194
Architectural Area Lighting	88
Architectural Record	202
Architectural Record Books	32-1, 64A, 64D, 204, 213
A-D-I-L Armstrong Cork Co.	2nd cover-1, 2-3, 5
A-I ASG Industries Inc.	12

**B**

A Ball Corp., Metal & Chemical Div.	177
A Bally Case & Cooler, Inc.	192
Bethlehem Steel Corp.	92-93
A Bobrick Corporation, The	168
A-I Bradley Corporation	64
Buckstaff	169
Building & Construction Exposition and Conference	180

**C**

A-D-L California Redwood Assn	28-29
A-I Ceco Corp.	173
A Celanese Fibers Marketing Co.	94-95
A-I Celotex Corp.	70-71
Cem-Fil Corp.	36
A-I-L Certain-Teed Corp.	206-207
Chester B. Stem Inc.	161
A-I Clark Door Co., Inc.	182
A Construction Specialties	164
A-I The Cookson Company	148
I Curries Mfg. Inc.	163
Cy/Ro Industries	152

**D**

Delta Air Lines	161
Detex Corp.	170
Disco Aluminum Products Inc.	205
A Dover Corp., Elevator Div.	79
A-D Dow Badische Co.	60-61
A Dow Corning Corp.	24
A-D-L DuPont de Nemours & Co., Inc., E.I. Antron	72-73
A-D-L DuPont de Nemours & Co., Inc., E.I. Elastomers	175
A-D-L DuPont de Nemours & Co., Inc., E.I. Lucite	40-41

**E**

Eaton Corp., Yale Marketing Dept.	153
Elixir Industries	20
Eljer Plumbingware Div., Wallace- Murray Corp.	16
Emhart Corp.	89

**F**

A-D Flexiwall-Systems Div. of Wall & Floor Treatments Inc.	154
A Floating Floors Inc.	156
A Follansbee Steel Corp.	21
A Formica Corp.	166-167
Forms & Surfaces Inc.	9
A Fry Reglet Corp.	46

**G**

A-I-L GAF Corp., Building Products Division	38
A-I-L General Electric Co.—Air Conditioning	32
A-I-L General Electric Co.—Lighting System Business Dept.	14-15
A-I General Electric Co.—Plastics Div.	22-23
General Tire & Rubber Co., Chemical/Plastics Div.	146-147
GF Business Equipment Inc.	17
Glidden Durkee Div. of SCM Corp.	183
A-D-I-L Goodrich General Products Co., B.F.	18-19
A-I-L Grace & Co., W.R., Construction Products	81
A-I Grefco Inc., Building Products Division	145
A-I Grinnell Fire Protection System Co. Inc.	158

**H**

A-I Hager Hinge Company	176
Halsey Taylor Div., King Seeley Thermos Inc.	62
Harvey Hubbell Inc., Lighting Div.	208
A Hastings Tile	159
A-I E.F. Hauserman Co.	190-191
A Haws Drinking Faucet Co.	46
A Heywood-Wakefield Co.	80
A-I Hillyard Chevcal Co.	172

**I**

Ildan Inc.	32-1
A-I-L INRYCO, Inc.	58-59
A International Masonry Institute	90

**J**

A Jewett Refrigerator Co., Inc.	170, 188
A-D-I-D Johns-Manville Building Systems Division	54-55, 195
Holophane Division	76-77
Joy Mfg. Co.	47

**K**

A Kawneer Company Inc.	82-83
A-I Kelly Co., Inc.	171
Kemlite Corp.	164
A Kohler Company	56

**L**

Latco Products	32-1
A-I-L Lennox Industries Inc.	209
A-I-L Libbey-Owens-Ford Co.	84-85
A Ludovici-Celadon Co.	181
Lundia, Myers Industries, Inc.	42
A-I Lyon Metal Products Inc.	211

**M**

A-D Marathon Carey—McFall Co.	196
A-D-L Masonite Corp.	52-53, 196
A Massey Seating Co.	196
A Jas. H. Matthews & Co.	196
McPhilben Lighting	196
A-I Merchandising Equipment Group	196
A-L Monier-Raymond Tile Co.	196
A Monsanto Company, Textiles Div.	196

**N**

A-I-L National Gypsum Co.	200
A Nucor Corp., Vulcraft Div.	5

**O**

A-I-L Olympic Stain Company	196
Omni Products Inc.	196
A Otis Elevator Inc.	196
A Overly Mfg.	196
A-D-I-L Owens-Corning Fiberglas Corp.	4

**P**

A Paddock Structure Inc.	196
Page Fence Division of Acco	196
A Parker Co., Charles	196
A-L Pella Rolscreen Co.	7
Philips, Eindhoven	64B
A-I PPG Industries Inc.—Coatings & Resins	196
A-I PPG Industries Inc.—Commercial Glass	196
A-I PPG Industries Inc.—Fiberglass	196

**R**

Rauland-Borg Corp.	196
A-I Raynor Mfg. Co.	196
Regal Tube Co.	196
A-I-L Reynolds Metals Co.	196
A-D-I Roper IBG	178
Russwin, Div. Emhart Corp.	196

**S**

St. Joe Minerals Corporation	196
A Sandell Mfg. Co.	196
A-L Shakertown Corp.	196
A-I Silbrico Corp.	170
Sloan Valve Company	4th c
A Smith, Elwin G., Div. Cyclops Corp.	196
Society of the Plastics Industry Inc.	196
A Soss Mfg. Co.	196
Southern California Gas Company	196
Sorgel Electric Corporation, Sub. of Square D	196
A-L Stanley Works	49
A-I Stark Ceramics Inc.	196
Steel Joist Institute	196
A-L Sub-Zero Freezer Co., Inc.	196

**T**

A-I Thiokol Corp., Chemical Division	196
A-I Tremco Incorporated	186

**U**

A-I-L United States Gypsum Co.	196
A-I United States Steel Corp.	3rd

**V**

A Vulcraft Div. of Nucor Corp.	196
--------------------------------	-----

**W**

Warth Paint Co.	196
A Wasco Products, Inc.	196
A-L Weyerhaeuser Company	196



FIRST PRIZE \$7,500

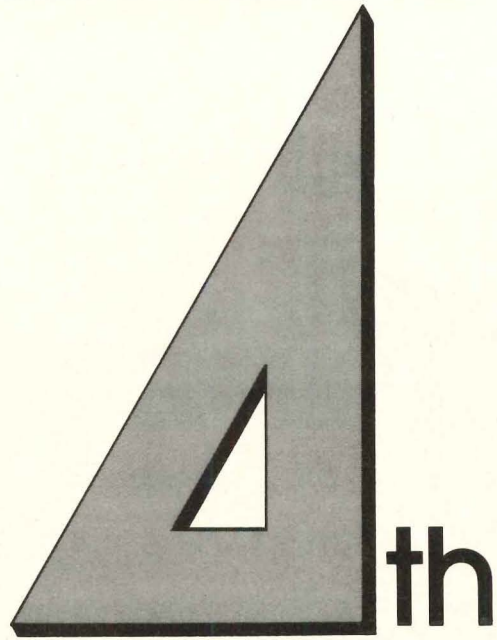

## CREATIVE DESIGN AWARD PROGRAM

For Mobile and Modular Homes

Enter an awards program that gives the designer an opportunity to test his inventiveness and originality against the necessity of practicality. It's the field of manufactured housing — mobile or modular. The competition is open to architects, industrial designers, their firms, and students in accredited architecture or design schools. Entries should concentrate on practical, and pleasing, single-family units that can be mass-produced and transported to the site. A crackerjack design could win you \$7,500. Four other awards will be made for designs that rank well.

Take a crack at a crackerjack competition with cash awards. Mail the coupon today for complete details.

# IT'S A CRACKERJACK COMPETITION!

All entries must be postmarked on or before May 31, 1977.



**REYNOLDS ALUMINUM**  
TRANSHELTER PRODUCTS

Reynolds Metals Company  
Fourth Design Award Competition  
P.O. Box 27003  
Richmond, Virginia 23261  
Attention: Advertising Department

Please send me all the information on the Reynolds Fourth Transhelter Design Competition.

Name \_\_\_\_\_

Firm or School \_\_\_\_\_

Address \_\_\_\_\_

City \_\_\_\_\_ State \_\_\_\_\_ Zip \_\_\_\_\_

### ARCHITECTURAL RECORD

McGraw-Hill, Inc., 1221 Avenue of the Americas, New York  
New York 10020

Advertising Sales Mgr.: Louis F. Kutscher (212) 997-2838

Eastern Sales Mgr.: Robert G. Kliesch (215) 568-6161

Western Sales Mgr.: James A. Anderson (312) 751-3770

Assistant Business Mgr.: Joseph R. Wunk (212) 997-2793

Research Mgr.: Camille Padula (212) 997-2814

Classified Advertising: (212) 997-2557

### District Offices:

Atlanta 30309

J. L. Moran, 100 Colony Square, (404) 892-2868

Boston 02116

Robert L. Tagen, 607 Boylston St., (617) 262-1160

Chicago 60611

James A. Anderson, Robert T. Franden, Edward R. Novak,  
645 N. Michigan Ave. (312) 751-3770

Cleveland 44113

Edward C. Weil, III, 55 Public Square, (216) 781-7000

Dallas 75203

David M. Watson, 123 Speer Blvd., #400 (303) 837-1010

Detroit 48202

John W. Maisel, 1400 Fisher Bldg., (313) 873-7410

Los Angeles 90010

Richard R. Butera, 3200 Wilshire Blvd.-South Tower (213) 487-1160

New York 10020

Blair McClenachan, 1221 Avenue of the Americas (212) 997-3584

Philadelphia 19102

Robert G. Kliesch, George T. Broskey, Three Parkway  
(215) 568-6161

Pittsburgh 15222

Edward C. Weil, III, 2 Gateway Center, (412) 391-1314

St. Louis 63011

Richard Grater, Manchester Rd., (314) 227-1600

San Francisco 94111

Richard R. Butera, 425 Battery Street (415) 362-4600

### Overseas Offices:

Brussels

Galerie Porte de Namur, 22-26, Chaussée de Wavre  
1050 Brussels, Belgium

Frankfurt/Main

Elsa-Brandstroen Str. 2, Frankfurt/Main, Germany

London

34 Dover Street, London W.1, England

Milan

Via Baracchini No. 1, Milan, Italy

Paris

17, rue Georges Bizet, 75 Paris 16e, France

Tokyo

2-5, 3-chome, Kasumigaseki, Chiyoda-ku, Tokyo, Japan



# Park Ridge Hospital prevents epidemic of slapped-up signs with integrated signage system.

The interior of Park Ridge Hospital—a warm, harmonious blend of wall colors, textures and carpeting—is therapy in itself.

Located in Greece, New York, and serving the Greater Rochester area, the hospital was dedicated in September 1975. A two-building complex, it covers approximately 300,000 sq. ft. The medical building contains 194 patients' rooms—all private—in addition to offices, conference rooms, labs, therapy departments, etc. It is connected to the adjoining Supply, Processing and Distribution building via a glass-enclosed walkway.

## Signage as a subsystem

A hodge-podge of signs, slapped up as an afterthought to construction,

would have seriously marred the hospital's handsome interior. But the architects and hospital administrators, aware of the need for an efficient traffic moving system, wrote a complete signage program into their initial plans.

Matthews was called in a year before the building completion date to design and fabricate a total, integrated signage system for both interior and exterior traffic control.

Over 300 individual signs—interior and exterior—were installed. Most were fabricated of damage-resistant NOMAR fiber reinforced polyester. All of the signage is tastefully understated but highly functional, with complete continuity of color and letter style.

Matthews. Total responsibility for total signage systems. Write for further details to Jas. H. Matthews & Co., 1315 West Liberty Ave., Pittsburgh, PA 15226.

**Architect:** Stevens, Bertin & O'Connell, Rochester, NY

**Construction Mgmt. Firm:** John W. Cowper Buffalo, NY

**Signage Contractor:** Empire Sign Co., Inc. Rochester, NY

**JHM MATTHEWS**

## Architectural Division

For more data, circle 141 on inquiry card

1., 2., 3., 4., 5. and 9. NOMAR with screened graphics embedded. 6. Cutout aluminum logo. 7. NOMAR post and panel assemblies with surface applied reflective pressure-sensitive legends. 8. Reverse screen process on acrylic identifies patients' rooms. Slide-in cards and strips for adaptability.





*Owner:* The Showboat Hotel & Casino, Inc., Las Vegas, Nevada.  
*Architect:* Jack Miller & Associates, Inc., Las Vegas, Nevada.  
*General Contractor:* Tiberti Construction, Las Vegas, Nevada.  
*Fabricator:* Industrial Steel Corporation, Las Vegas, Nevada.  
*Erector:* Steel, Inc., Las Vegas, Nevada.

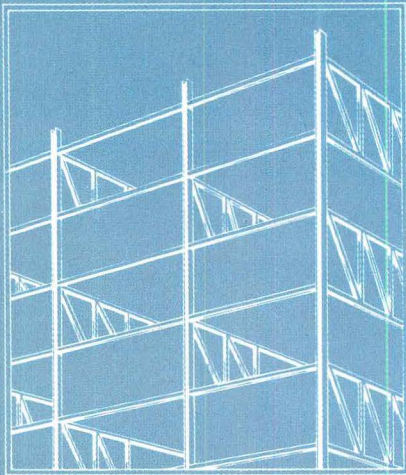

## Staggered Truss Steel framing system saves 45 working days in Las Vegas hotel expansion.

The Showboat Hotel and Casino, one of Las Vegas' most popular spots, has recently undergone a \$6 million expansion program. Nine new floors and 198 new guest rooms—as well as larger banquet facilities—have been added to the existing nine-story, 154-room structure.

The choice of Staggered Truss Steel Framing for this new construction provided several benefits to the owners: (1) It conformed with the existing framework and permitted identical elevation treatment within original foundation load limits. (2) By eliminating interior columns, it provided unobstructed floor space for two column bays the entire width of the building. (3) Preassembly of the trusses in the fabricator's shop allowed construction to proceed without interrupting service or creating undue disturbance in the guest area immediately beneath the new addition. (4) It shortened the erection time of the steel frame to only five weeks, saving 45 working days, and permitting earlier occupancy.

In this project, and many others, Staggered Truss Steel Framing—developed by M.I.T. under a grant from U.S. Steel—proved to be the most practical and economical construction system. For more information on the design of Staggered Truss structures, contact a USS Construction Representative through your nearest U.S. Steel Sales Office. Or write for our booklet, "Staggered Truss Framing Systems for High Rise Buildings" (ADUSS 27-5227-02), to U. S. Steel, P.O. Box 86 (C600), Pittsburgh, Pa. 15230.



TRADEMARK

**United States Steel**





**You waste  
a lot of water  
when you use flush tanks  
instead of  
Sloan Flush Valves.**

**Figure it out for yourself.**

Number of  
tank toilets in  
your building

Number of gallons  
a Sloan Flush Valve  
saves compared  
to a flush tank

Total number of  
gallons wasted  
by flush tanks  
on every flush

Plus the number  
of gallons wasted  
by unnoticed leaks

$$\boxed{\phantom{000}} \times 0.64 = \boxed{\phantom{000}} + \boxed{?}$$

No matter what figure you got, remember it's only for a single flush. Think of how many times all the toilets in your building are flushed every day. Every month. And since every Sloan Flush Valve uses 0.64 gallon less than a flush tank, think of how much water you could be saving, instead of wasting. What's more, a Sloan Flush

Valve saves you money by using this same minimum water volume with every flush. No more, no less. That's because it completes its cycle, then shuts off automatically. Again, there's less water wasted and a lower water bill. Remember, it takes energy to pump water. The less water you have to pump, the less energy you

have to pay for. So stop wasting water and start saving money. To tell you how, we'd like you to have the test report from an independent laboratory that proves Sloan Flush Valves use 0.64 of a gallon less than tanks. For your free copy, just write to us.



Sloan  
Flush  
Valves.

Anything else  
is a waste  
of money.



**SLOAN VALVE COMPANY**

10500 SEYMOUR • FRANKLIN PARK, ILL. 60131