

GRAND OPENINGS.

Hardware Friendly openings can now be ordered in dimensions from 1" to 16" for over 25 Cirrus® ceiling systems. Machine-cut for precise detailing, they accommodate lights, HVAC fixtures, sprinkler heads and speaker grilles. For more information, call 1 800 233-3823 and ask for Hardware Friendly.

A View from the Sidewalk

It's a solace, in this hot contentious summer of civil strife, persistent recession, political discord, carnage in newly liberated European lands, drug- and AIDS-related bereavements, and a fragile planet under attack from uncontained development, to be able to fall back on small, simple pleasures.

High among them is the fine but eroding art of walking. Having recently done my share of travel on behalf of this magazine, I never cease to rejoice at the profit gained through donning a pair of stout shoes and casing the town. For walking, for the architect and student, is more than a means of *transportation*; combined with *observation*, walking is a teacher of many things—planning, urban design, materials, details, textures, colors under different lights, sociology, zoning at work.

Compared to the jet, the automobile, the bicycle, and even the horse, walking is not an efficient way to go, except in places like Manhattan, San Francisco, or Boston where you typically make better time on foot. In any case, walking needs to be done at different paces to fit the setting. Some streets must be done slowly, savoring here an ingenious bit of paving texture, there a clever cornice silhouetted against the sky. Other settings, lacking any great interest, need to be done quickly, if only to get the blood circulating and to rest the left brain.

Country walks are different, especially if you try to get from the bottom of a mountain to its top. Honest sweat takes the place of observation, and the reward is in the soothing countryside and in arriving at your destination, not through any esthetic dividend.

Perhaps the greatest virtue of walking is that for the most part we still design buildings and neighborhoods to be seen at the walking pace of three-and-one-half miles per hour. If you have tried to see sights from even a bicycle, you find that details begin to blur, textures become fuzzy, and turning your head risks a broken skull. Trying to take in the urban scene by car is even less rational; it's like eating a shrimp with a pitchfork: the scale and dynamics are lacking.

One mistake made even by experienced walkers is to walk only forwards. You miss one half of the scene that way. While man and woman were not created to walk backwards, you should try it whenever you can, especially in light traffic. So turn around every once in a while and look back. It rounds out the picture.

A final bit of advice. Avoid the temptation to record the scene. I find the mind is a far better recorder of architecture than the slide camera, and doesn't throw you off your walking rhythm. With a camera, you stop at every step and worry the question, "Should I or shouldn't I?" Better to come back next day and take your pictures, or bring along a pad and pen and preserve the beleaguered art of sketching. Don't dilute the walking experience solely for half an hour of uncertain pleasure later at the slide projector.

Many streets are dull, you say, and walking takes too long. Perhaps. But until we design more cityscapes to be viewed from the *road*, we may as well take advantage of exploring the view from the *sidewalk*. While it's still there.

Stephen A. Kliment

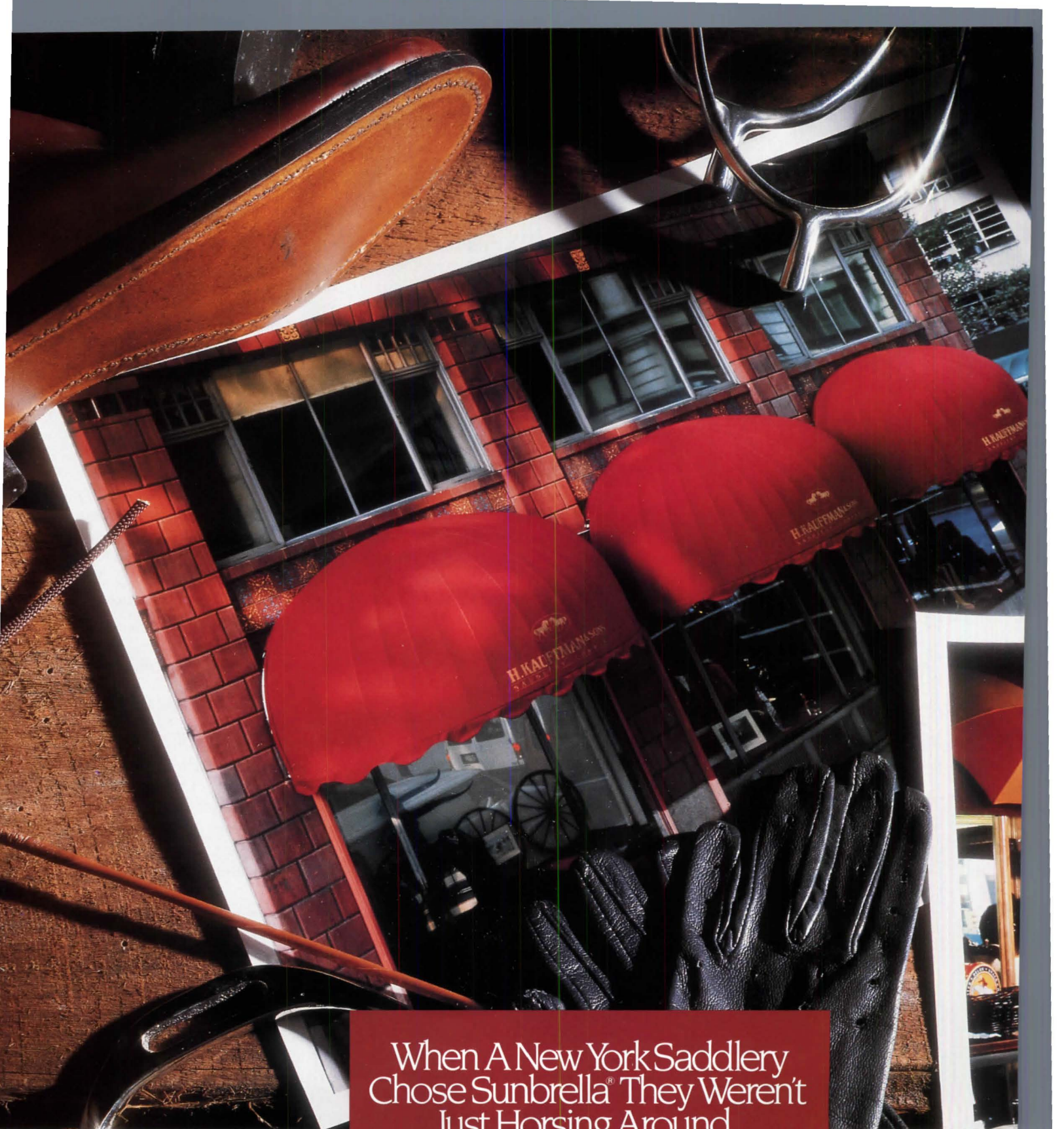

When A New York Saddlery
Chose Sunbrella® They Weren't
Just Horsing Around.

Not just any fabric would do

for H. Kauffman & Sons

Saddlery Company. They needed something that was versatile, beautiful and durable. Sunbrella solution-dyed acrylic fabric and Sunbrella Firesist® fabric are all those things.

The versatility of our fabric is evident all over the store. Inside and out creative uses of the fabric abound: in the beautiful awnings that grace the outside, in the canopies hanging over the showroom, in the door and window treatments, in the many accent pieces

The beauty of Sunbrella shines through in every Sunbrella fabric we offer. Regular Sunbrella is available in over 90 colors and styles.

Japan

Frank Israel's Building-as-Billboard

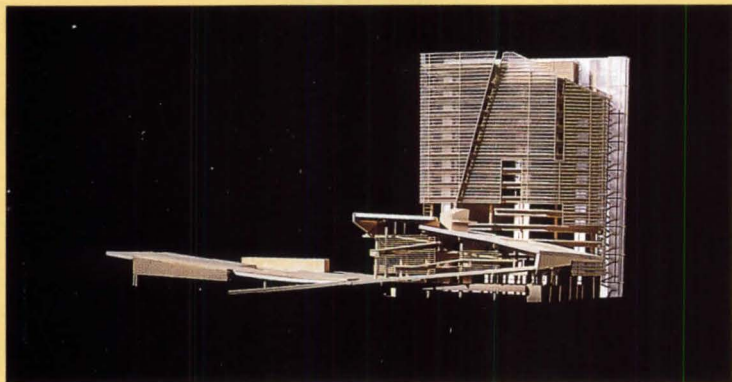

© Tom Bonner

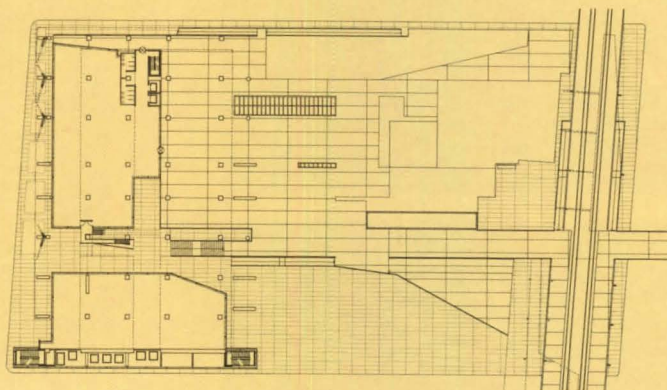

Frank Israel's design for the headquarters of Bunka Shutter incorporates the company's products—shutters, overhead doors, operable screens of grille-system material—in the facade of a semitransparent tower. Poised to capture the hourly, daily, and sea-

sonal shifts of light, the three-dimensional objects also combine to create a corporate signature and a high-rise advertising catalog. The tower rises at the edge of a low complex of gardens, galleries, shops, restaurants, and cafés that slopes down from an

adjacent elevated metro station in a new industrial community outside Tokyo. A proposed second phase includes using landscaping to draw a nearby forested area through an extension of the low complex on the other side of the metro route. ■

Japan

Isozaki Awarded World Architecture Expo Hall

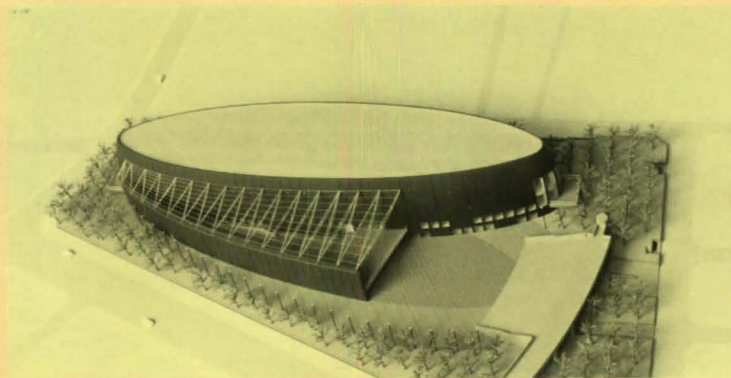

The first World Architecture Triennale at Nara, some 25 miles outside Osaka, selected Arata Isozaki from among 644 international contenders to design the Nara Convention Hall. The hall, on a 60-acre exhibition site in a redevelopment area, is scheduled to house

the planned World Architecture Exposition in 1998. Tadao Ando, Mario Botta, Hans Hollein, and Christian de Portzamparc were among five finalists. Redevelopment plans, to be completed by the end of the century, include a bus terminal, an information cen-

ter, a department store, urban housing, a sports center, and a museum of architecture. Architects for the various planning phases will be designated over the next six years. The Triennale also awarded a gold medal and \$30,000 to Charles Jencks. ■

New Wave for Prague Suburb

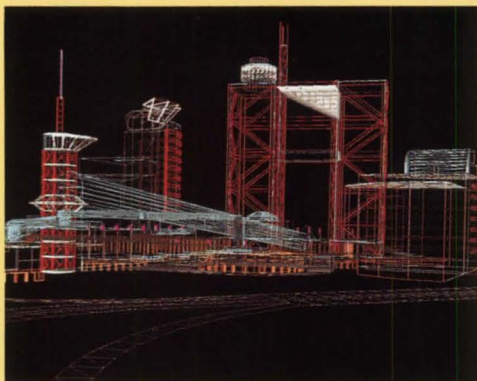

Nove Butovice ("New Technological City") is, according to project architect Marc Spector, the fulfillment of a Czech government desire to create a built image of "Wow!" He claims "the country hasn't seen these construction techniques, building materials, and large scales." The design emphasizes exposed structure; a generous use of glass further reveals human activity and production. Two 40-story office towers joined by skywalks form a symbolic gateway to Prague, whose historical center, some 26 miles away, is visible from a five-story restaurant atop one of the towers. The plan, chosen by the chief architect of Prague through an international competition for a site owned by Canadian developer William Alguire, includes 150,000 sq ft of retail, a 600,000-sq-ft trade center, a 500-room hotel, conference centers, and health-club facilities. Skywalks and plazas connect all the buildings. A housing tract will be acquired, and existing rail and road links will be upgraded as part of the plan. The first phase of the \$500-million project—the hotel and one office tower—will begin early in 1993.

Judith Davidsen

Wagon Wheels in the Sky

© Strode Eckert Photographic

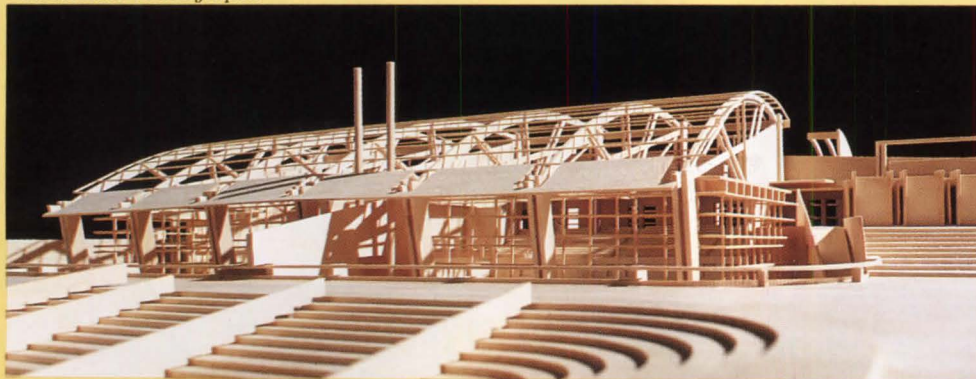

More timber imagery than actual timber, the Camas Community Center in Camas, Washington, will serve a town rooted in logging and boating, and whose ancestors pioneered the Oregon Trail. Architect Keith Hoelscher uses symbolic reference to covered wagons

and wheels and the implements of timber and boats. And, in an area where high rainfall frequently forces recreation indoors, the wood skeleton permits outdoor views and light to enter through generous expanses of glazing and fiberglass-panel roofing. ■

James Stirling 1926-1992

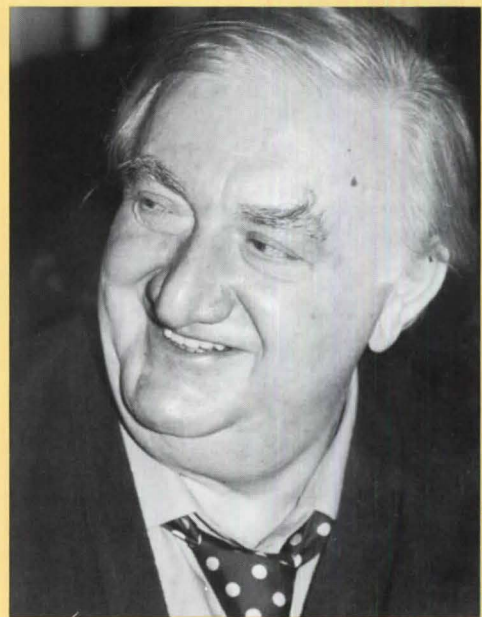

© Dorothy Alexander

It is hard to believe that we lost James Stirling, who died suddenly in June at age 66. His career, ever capable of surprise, seemed on the verge of taking yet another dramatic turn. In practice since the mid-1950s, Stirling always went his own way, bursting into prominence in the '60s with such seminal projects as the Leicester University Engineering Laboratories and the Cambridge University History Faculty building. Noting that Leicester echoed Aalto, Wright, and Melnikov, Colin Rowe wrote, "it is not the obvious art-historical field day which, initially, it may appear." Other influential projects followed, particularly the Olivetti Training School, where brick and glass were traded for plastic and a sinuous glazed spine. In the '70s, competitions for the Museum for Northrhine Westphalia and the Derby Town Centre affected the course of early Postmodernism. Stirling's projects in the 1980s were both abstract and eclectic (witness the Clore Wing at the Tate Gallery), and he could evoke Schinkel and Le Corbusier simultaneously (the Staatsgalerie in Stuttgart). His U. S. projects included an arts center at Cornell and additions to Harvard's Fogg Museum and the architecture school at Rice. Work has begun on a library at the University of California, Irvine. A factory, just completed in Germany with Walter Nageli, should have marked a new chapter in his career, not an end point. *J. S. R.*

Briefs

Projects

Sir Norman Foster will design a 53,000-sq-ft addition to Omaha's Joslyn Art Museum. The project, which includes renovating the museum's original Art Deco building, is Foster's first American commission.

Ellerbe Becket, in association with Heery International, Williams-Russell Johnson, and Rosser Fabrap, will design an 85,000-seat Olympic stadium for the 1996 games in Atlanta. After the games, the stadium will serve as the home of the Atlanta Braves.

Design of a \$1.5-billion terminal at London's Heathrow Airport has been awarded to Richard Rogers Partners. The project's first phase, to be completed in 2002, should handle 10 million passengers a year.

Circus Circus/Caesar's World may take their \$2-billion "urban resort"—for which Skidmore, Owings & Merrill will design image, program, and concept—out of Chicago if the Illinois General Assembly doesn't approve casino gambling by year's end.

Office changes

Peter Pfau has left the San Francisco firm of Holt, Hinshaw, Pfau, Jones to concentrate on smaller projects. "We talked for a while of setting up a separate division, but it just made more sense for me to go off by myself," says Pfau. On the East Coast, George Notter has started an independent practice, Notter + Associates, in the old Washington, D. C., offices of Notter Finegold + Alexander. Finegold Alexander + Associates continues in the Boston office.

Honors

Tadao Ando has won the first Carlsberg Architectural Prize, at \$225,000 the world's largest monetary architecture honor.

Professor of architectural technology Daniel Schodek has been awarded a Harvard Graduate School of Design chair funded by the Japanese design-build firm Kumagai Gumi.

Competition

Submissions are due October 15 for the 1992 Wood Design Awards. Contact the American Wood Council, 1250 Connecticut Avenue, Washington, D. C. 20036 (202) 463-2761. ■

Theme Wars Rage in Vegas



Eric Figgie

In Las Vegas, history repeats itself neither as farce nor as tragedy, but as a themed environment. In a move that takes the growing symbiosis between shopping malls and theme parks to the next logical step, Caesar's World recently extended its empire to include the 250,000-square-foot Forum Shops (left). Entered on moving sidewalks that take you through six triumphal arches standing in desert-defying torrents of water, this collection of expensive stores is your typical Roman *via*, where the sun sets and rises on an electronically controlled cycle, continually bathing acres of faux finishes in rosy hues. Animatronic robots welcome you with a burst of lasers, and a Rococo version of the Fountain of the Four Rivers drowns out the sound of nearby slots. The skill of the artisans assembled by Dougall Design



Associates is enough to make you forget the incongruity of shopping for neon running shorts under Corinthian columns.

Down the Strip, Egypt is mounting a comeback against the Roman legions in the form of the 2,521-room Luxor (right). When completed, this 30-story reflective-bronze pyramid will be the most striking object on the Strip. In case you didn't get the idea from the building's abstract shape, the hotel plans to transport guests to the check-in counter on boats floating down "the River Nile," and then take them to their rooms on inclined elevators. Architecture will mix with film in an atrium housing time-travel rides designed by *Back to the Future* special-effects creator Douglas Trumbull.

Aaron Betsky

Richard Haas

Wright on the Money

Is Frank Lloyd Wright worth only the money he's printed on, or is he the lowest denomination in Richard Haas's fantasy money series in order to give architecture a more common currency? The outdoor muralist switched scale for the summer issue of the Walker Art Center's *Design Quarterly*, which commissioned his new designs for U. S. money. Haas, an apprentice at Taliesin in the 1950s, invented a \$25 bill for Wright, and put Duke Ellington on the \$50, Martha Graham on the \$100, and Tennessee Williams on the \$200. ■

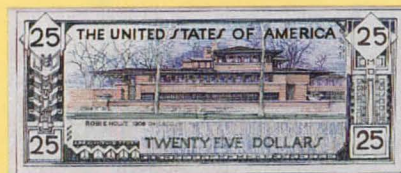

Architects at Earth Summit Champion Sustained Development

A chilling picture of the problems facing the planet was painted by Maurice Strong at a New York lunch shortly after his return from the Conference on Environment and Development (UNCED) in Rio de Janeiro, which he organized and ran on behalf of the United Nations. In the 20 years since the Stockholm conference, the world's population has grown by 1.7 billion; the world Gross National Product by \$20 trillion, most of it applied to environmentally destructive uses; and the conflict of jobs versus environment has grown ever sharper. The Brazil meeting attracted 30,000 participants, 178 national delegations, 10,000 members of the press, and 100-million broadcast listeners around the world. Here's a special report from correspondent Joe Goldman in Rio. S. A. K.

An auto filled with several representatives of the world's architectural organizations tunnels its way toward the center of Rio after a long day at the Riocentro convention center, site of preparatory meetings for the Earth Summit. The car passes by the mountainside of Rocinho, said to be the largest mountain ghetto in South America, with more than 300,000 inhabitants. The group marvels—horrified—at the precariousness of the houses, which seem to be dangling on the steep cliff with crazy glue. They are told about the deadly mudslides during the rainy season which wash the houses down the hill. And, due to the lack of sewers, effluence from one house falls to the roof of the house below. Looking at Rocinho by night, one sees why it is called the Christmas tree.

But delegate and AIA president-elect Susan Maxman, who had held discussions with the World Engineering Partnership for Sustainable Development (WEPSD) and other design groups, takes a rosier view on environmental prospects: "Engineers and architects have a historical animosity. But I believe we have a common cause in the sustainable-development debate and I hope we can further strengthen our bonds after Rio."

Talks with high-powered CEOs

The architects also met with leaders of the Business Council for Sustainable Development, a high-powered group of CEOs from 48 major corporations around the globe. Sus-

tainable development is the new buzz word for ecologically sound planning, and it was heard constantly in the halls of Rio. The phrase, coined in 1987, defines SD as development that meets the needs of the present without compromising the ability of future generations to meet their needs. Everyone here is convinced that SD will be crucial to the future of the construction industry. Decided at the Earth Summit were guidelines and definitions of SD for at least the next two decades.

The vehicle carrying the architects has returned to the downtown area with its high-rise towers of glass and concrete. "One thing is striking for me at this convention," notes Maxman. "The developed countries have to share technology with the developing countries to demonstrate the mistakes we have made."

Architects are a vocal presence

Architects maintained a strong and, at times, vocal presence at the June Earth Summit. They spent most of their first week in Rio networking with other professional, technical, and scientific groups. Perhaps the major ties were forged with WEPSD, a group anchored by the two largest international engineering organizations, the World Federation of Engineering Organizations (WFEO) and the International Federation of Consulting Engineers (FIDIC). The two groups are said to represent over 10 million engineers, technicians, and consultants.

In a presentation at the Global Forum, a concurrent gathering of nongovernmental organizations (known as NGOs) that kept a kind of vigil over the political actions in Rio, the architects had an open debate called "The Architecture of a Sustainable World," sponsored by a New Zealand group. The meeting, attended by about 40 architects from various parts of the planet, offered these five resolutions:

- To encourage the UNCED process to recognize the vital role the producers of the built environment must have in any move toward a globally sustainable society.
- To recognize that the inevitable structural changes to the built environment in pursuit of a sustainable society must involve both

the existing and future infrastructure, and development.

- To recognize that the built environment and its development [are the easiest ways to involve individuals in achieving] a sustainable society.
- To recognize that appropriate technologies and skills are available now and can be mobilized immediately in developing a sustainable built environment.
- To encourage architects and others to design in a manner that reduces the emission of environmentally damaging substances and conserves nonrenewable resources.

The second week of the conference set off the nitty-gritty job of lobbying. The major problem that the architect groups worked on was vocalizing their disappointment regarding one part of Agenda 21, the 800-page document that emerged as this summit's cornerstone. The objectionable wording was in Chapter 7 of the document (dealing with Health, Atmosphere, Water, and Waste), which, while it was said to deal effectively with some aspects of promoting sustainable human settlement, fell short in failing to recognize a proper role for human settlements and the way they are built, and rebuilt, as a "major part of any viable strategy towards sustainable development."

Don't forget hvac

Israel's Tony Rigg questioned the general lack of emphasis in Agenda 21 on heating and cooling, "which waste vast energy resources when we have appropriate technology which could minimize this waste."

Although the lobbying did not yield any semantic changes, architects and engineers hoped their group would have continued access through the Sustainable Development Commission, a UN body created in Rio to implement Agenda 21.

"This conference has been quite important as a starting point," said AIA delegate Bob Berkebile. "Sustainable strategies are now at the top of the agenda. Individuals and NGOs now sense their power. Government in general, and the leaders in particular, cannot be relied upon because of their short-term vision." ■

The Youngest Get Another Chance

Barton Myers Associates has designed a flexible haven on the campus of UCLA Medical Center for abused and drug-addicted infants—from newborns to preschoolers—and their families. The Child/Family Development Center is an internal playground, top-lit through giant canvas coffers, surrounded by two-story "houses." Each house can shelter 12 children and four counselors in a homelike layout of living room, two sleeping rooms, bath, porch, and an eat-in kitchen bay that penetrates the playground to provide home/world connections. Second

stories contain library, offices, and meeting rooms for the center's training components. An entry lobby (lower right in model) has a fireplace, inglenook, and garden overlooks, recalling the front hall of the central Los Angeles mansion where the Children's Institute International still maintains its original facility. Scheduled for completion by year's end, the \$3.4-million project can respond to budget availability by adapting to mixes of therapeutic daycare, 24-hour shelter, and training facilities for parents, foster families, and interns. *Judith Davidsen*



World War II Bunkers Landmarked

France has landmarked its section of the Atlantikwall, the coastal defense line the Nazis built in 1942 from Spain to Norway. After taking inventory of the 1,200 bunkers built by the Germans in France alone, the province of Normandy has designated 40 areas as historic. Some of the selected sites are private property; others are places such as the Pointe du Hoc, a rocky point west of Omaha Beach that was the scene of carnage on D-Day, when the wall meant to defend Hitler's "Fortress Europe" gave way under the Allied onslaught. *Tracy Metz*



N.Y. Living Hits Southern California

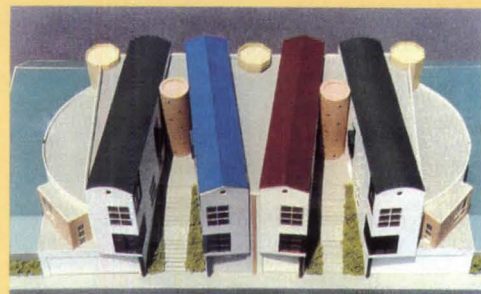

"We're making the perfect New York townhouse in Southern California," says Jeffrey Kalban, the Long Island-bred Los Angeles architect who is collaborating with Brooklyn-born developer Ivan Cohen on a 75-unit affordable townhouse community in Pico Canyon on the northern rim of Los Angeles. The row-house formations provide two living stories over individual garages, floor-through ventilation, and small backyards. The project is distributed over three terraces on an 18-acre hillside landscaped for walking (or, given the site's natural Bronxlike grade, a little light hiking) in Valencia, once a bedroom adjunct of Los Angeles and now an industrial and corporate center of its own. Originally planned as two-bedroom starter homes, with a few three-bedrooms, the units have been reconfigured—within the same 1,400-sq-ft program—to create 64 three-bedroom and 11 four-bedroom layouts more likely to encourage a lasting commitment to the community. Each house provides valley and mountain views, solar orientation with glazing on three exposures, and shafts that can accommodate elevators for handicapped access. The project includes a recreation center and clubhouse. Purchase prices start at \$140,000, roughly half the going rate in Southern California, to serve young professional and working-class families. Construction will begin in early 1993 after extensive site improvements. *Judith Davidsen*

AIA Convention

Hot Buttons and Cosmic Visions

Perhaps the hottest button pressed at this year's annual AIA convention (Boston, June 19-22) was passage of a requirement for mandatory continuing education as a condition for architects to maintain their memberships. Lauded by some and loathed by others, the resolution takes full effect at the beginning of 1996, when the details will have been ironed out by a test program.

There were also conflicting views on the importance of design. "Architects' greatest misconception is that clients even care about it, unless they are shown how it relates to a business plan," said University of Texas professor Michael Tatum in a seminar entitled *The Role of [Real Estate] Brokers in Procuring Design Services*. Hether Smith of brokers Julian Studley Inc. thought architects had "blown it" on commercial interior design (a big part of the work that brokers may influence) because they had created the impression they are only interested in buildings. "AIA stands for 'architect I ain't,' when I am talking to those clients," agreed Tatum. The best way to get a design job through a broker, said Smith, is to give facts and figures on, for example, appropriate costs per square foot that will make brokers look good to their clients.

Louder views on education

A higher tone was set by the *Five Presidents Forum*. AIA president W. Cecil Steward listed factors he sees shaping architectural education in the '90s: sustainable design, ethnic diversity, globalization, and the need to tame a rapidly expanding body of knowledge. He urged looking at the role of architects in a broader context than design of individual buildings, instilling a desire for quality in everyone involved in construction, and upholding academic standards. New courses and approaches to teaching were urged by AIA president Lynn Simon. Among them: environmental issues (as recently offered by the University of Virginia); teaching architectural princi-

Michael Charney



Joe Mamayek and Mark Moeller of Jung/Brannen Associates designed a chess set of models of buildings for Boston's Copley Square. The object: to give laypeople a sense of architecture's importance.

ples to nonarchitects; alternate-career counseling; more business courses; getting practitioners into education by having more of them teach; and getting education into practice by offering in-office courses.

"There is an increasing split between theory in schools and practice," said Rensselaer Polytechnic Institute professor Patrick Quinn. He advocated a "clinical practice," one conducted by an interdisciplinary team that would apply theory to actual design projects. John Busby acknowledged variable aspects to practice (that he thought would always be in flux), but also urged recognition of sound constant values. Among them: ethics, which, despite the antitrust suits of the recent past, "need to be strongly enforced." All of this led to one probable conclusion, urged by NCARB's Robert Burke—mandatory continuing education, which was about to be put in effect.

Activism is "not hugging trees," said AIA president-elect Susan Maxman in a public-policy session as she described a RUDAT in a "Beirut-like" area of North Philadelphia where there seemed to be little hope. "Just

the fact that someone took an interest made a big difference in how the residents regarded their neighborhood," she said. Will activism lose clients? "It establishes credibility," said David Dixon, who described how Boston architects took control by forming a design commission and forging links with other groups to improve the quality of new buildings.

Wetlands: keep out

Wetlands and why architects should care were one of several environmentally correct themes nursed along at the convention. At a popular seminar, researcher Carrie Fisher cited the benefits to a developer of avoiding wetlands construction. These included higher rents by preserving scenic views; the economies of higher density; and avoiding the costly process called for in the Clean Air Act designed to discourage variances.

If you must build, assembling a successful mitigation package is no easy task when it involves a potential impact on a wetland, said Mark Kraus, a senior associate at Environmental Concern, Inc. Known as "that M word," mitigation is liked by the building industry but is suspect among environmentalists. For example, an applicant may be required to guarantee 85 percent plant survival for two to three growing seasons as one price of acceptance. Site selection may require buying added land to meet requirements. Tidal wetlands' mitigation plans are scrutinized less rigorously than freshwater plans because they assure a water supply to the site. Joseph Larson of the Environmental Institute at the University of Massachusetts at Amherst had simpler advice: keep out. Building in wetlands can be high risk in future costs to the owner, buildings, and the community through flooded basements, septic-system failures, and toxic water caused by wetland filling or draining.

William Chapin was elected AIA first vice president. He will serve as president in 1994.

At Big Annual Computer Show, The Medium Was the Message



Steve Ross

Architects, engineers, and contractors come to the A/E/C Systems show (this June, in Dallas; see pages 44-49 for a products report) to learn how to handle their jobs faster. Better. With more pizzazz. For years, the expert speakers at the accompanying less-well-attended conferences have been saying that's all wrong. The technology, they say, will change the content of the jobs themselves, not just how fast they can be done.

One of this year's speakers, Tor Guttorm Syvertsen of the Division of Structural Engineering, Norwegian Institute of Technology, Trondheim, called for "rethinking the entire building process as essentially an information process, employing the new information technologies to create new ways of working, not only imitating or automating manual procedures." He sees the building industry evolving into a "networked, networking community," with a "new set of business practices that promote the efficient use of the new technologies throughout the industry, including the legal, regulatory and remuneration aspects." He also suggested that we get away from computer imitations of paper drawings, and "develop new ways to represent and convey information and knowledge, adopted to the capabilities of the computer as a new medium."

This year, after several years of hard times, the attendees listened. Attendance at the ex-

hibits in Dallas this year was up 9 percent over last year's anemic total in Washington, D. C. But conference attendance jumped 18 percent. Technology trends have certainly set the stage. For instance, the gurus have been saying for years that CAD systems should work at a more generalized level, with objects such as spaces, to which the designer can relate—and not merely doors and windows from specific vendors. Lo and behold, modeling software that does just that—long before the need for hard-line drafting—is finally enjoying some popularity. The gurus have also been saying that, because the computer can put so much information into the hands of designers, the best designs will have to be created with the aid of computers.

The Department of Energy, for example, is funding the Advanced Energy Design and Operations Technologies (AEDOT) project at the Pacific Northwest Laboratory, California Polytechnic State University, Lawrence Berkeley Labs, and the University of Oregon. The idea, discussed at this year's conference sessions, depends on computer technology to integrate energy, visual, acoustic, structural, and cost factors, among others, into the final design.

Until now, there's been something missing, something wrong with the whole idea. The gurus could talk. But who, aside from government (in a few demonstration projects) would pay to get all the information into the glowing box in the first place? Would manufacturers all computerize their catalogs? Would planners computerize their maps? Hydrologists their terrain data? Would government, professional societies, and trade associations focus on the broader issues like energy use and coordinated specifications? And would computer software and hardware vendors make sure everything worked together? We're not quite there yet, but the answer to all those questions emerged firmly this year. Yes, yes, yes.

The technology is now far enough along to force organizational changes in practices. In a bizarre twist, the economic downturn has left many practices with no choice anyway: The senior designer, who may have spent years escaping the drafting table, must now embrace information technology. *Must.*

And attendees knew it. A session on geographical information systems by George Korte of I-NET in Bethesda, Maryland, was full—and many who were there were architects or worked for architects. Korte, a PE, carefully delineated the differences between a CAD drawing and a GIS. When lines representing roads or rivers meet in a GIS, they can only meet in certain ways, for instance, forming "networks" of features that work together. Thus, importing information from a GIS into the design process is not simply making sure the map shows up inside the CAD software. The underlying intelligence must be retained. Will practices really trust that chore to low-level personnel?

Barry Pendergast of The Pendergast Group in Calgary dazzled another full house with various computer-generated animations and static displays that aided the design process, involved clients, and served as promotional material for gaining new clients. However, who but the firm's principal knows enough to put it all together just right?

The audience at my own session, on organizing to achieve a real payoff from computerizing, seemed up to the task. Most came from networked offices where work is increasingly distributed and coordinated across a broad range of professionals. Their questions were more on the details—especially details of scheduling and quality assurance—than on the philosophy.

We are ready for the 21st century. And it may all still be fun. The glowing box is becoming much more than an automated drafting table. *Steven S. Ross*

CSI Retrospective

The big building-product trade show comes out strong for quality—and environmental correctness.

The 36th annual convention and trade show of the Construction Specifications Institute was held in Atlanta this year, with 551 building-product manufacturers exhibiting. While total attendance, at just over 8,000, was down a bit from last year's San Diego event, the three days of morning and afternoon seminars were well attended, and covered an array of subjects that gives a good snapshot of the profession's concerns. Examples: Environmental Law for Today's Specifier; Recent Liability Rulings on VOCs; Exploring Quality in the Constructed Project. And, of course, Conflict Resolution. Product introductions were incremental: more fire-resistant; more ADA-compliant; more use of recycled materials. Some product introductions are shown here; for CSI-related literature, see page 132.

300. Out of sight. Stanley's 4 1/2-in. LifeSpan hinge is definitely unobtrusive: when the door is closed against its stop, the device is totally concealed. The hinge (top view, *a*, open position, *b*, and closed, *c*) is a simple, flattened-S bearing shape with integral tangs that prevent damage to hollow-metal doors; there are no springs or other mechanisms. A reinforcement plate permits modification of standard frames. Stanley Hardware, New Britain, Conn.

301. Fire-rated continuous hinge. The 911 Unigear system is approved for use with any size three-hour fire-rated steel door up to 9 ft. Supported fully by gearlike Delrin bearings and two extruded-aluminum sections, the hinge rotates a full 180 deg. Regularly spaced stainless-steel pins bedded in intumescent material fix the door in place when exposed to fire temperatures, enabling the assembly to meet the requirements of NFPA 252 and other fire-door standards. Zero International, Bronx, N. Y.

302. Silk-screen graphics. Exterior aluminum and glass can be decorated using Duranar Duragraphic fluoropolymer coatings. The silk-screen process permits many more color options than ceramic frit, and can appear three-dimensional when multiple glass surfaces are printed. Precise shading patterns give an illusion of depth to metal surfaces, such as this medallion on a Chicago skyscraper. Linetec, Wausau, Wis.

303. Building-product database. The Sweet's division of McGraw-Hill displayed a new Microsoft Windows-based electronic catalog, SweetSource. To be given to design firms receiving the green General Building catalogs, CD-ROM disks will carry product descriptions, text specifications, four-color photos, and details from building-product manufacturers across all 16 CSI divisions. An electronic-search function will let the specifier select and view only those products meeting preset conditions, e.g. fire-rated wood doors. Drawings and text are exportable to any Windows application. Sweet's Electronic Publishing, Grand Rapids, Mich.

304. Metal rain screen. Alucobond displayed a new rout-and-return option for its enameled-metal panels, with an easy-to-install mounting technique especially useful in retrofit applications. The lightweight facade consists of metal panels fabricated to form shallow open boxes, or cassettes, fitted with hooks that hang over pins set on load-bearing metal profiles. An upturned flange at the top of each cassette creates a rain-screen effect. Alucobond, St. Louis.

305. Laminated fire-resistant glazing. FireLite glass-like ceramic is now offered in a laminated version, FireLite Plus, which has the impact resistance required for applications needing a safety-glazing product as per ANSI Z97.1 and 16 CFR 1201. The new configuration maintains fire- and thermal-shock (hose stream) performance that meets NPFA opening-protective standards. FireLite Plus fits in standard fire-rated frames, and carries a maximum fire rating of 3 hours in sizes to 100 sq in., 60 minutes in sizes up to 2,721 sq in., and 45 minutes in sizes to 3,325 sq in. Technical Glass Products, Kirkland, Wash.

306. Sunroom design aid. Pella's upgraded window-design software offers several enhancements, including a new Sunroom program that generates a 3-D model when the glazing style for walls and roof and roof pitch have been entered. A 2-D-3-D toggle lets the architect go easily from one version to the other. 3-D models can be shaded and have finish textures applied for animated presentations. No charge. Pella/Rolscreen Co., Pella, Iowa.

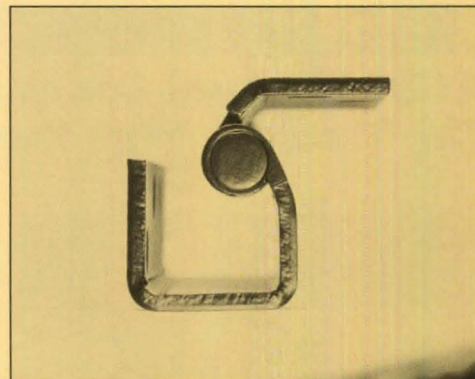

For more information, circle item numbers on Reader Service Cards.

Winning Mosaic

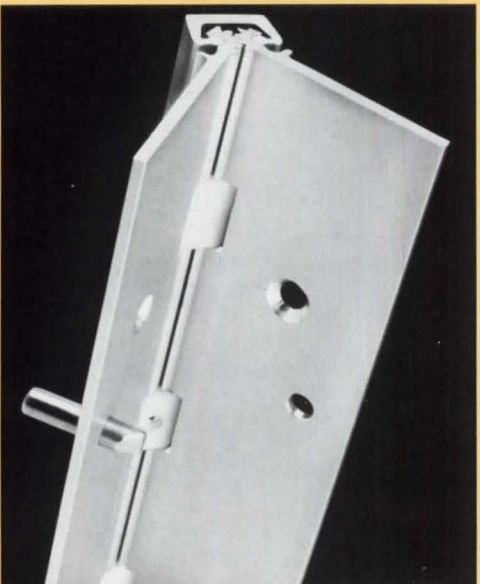

301

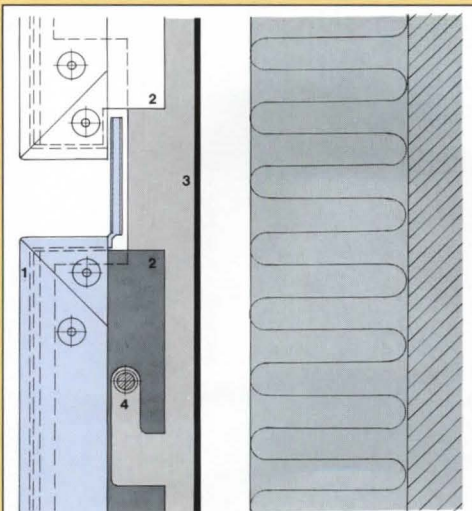

1. Metal cassette
2. Hook fastener
3. Profile
4. Pin

304

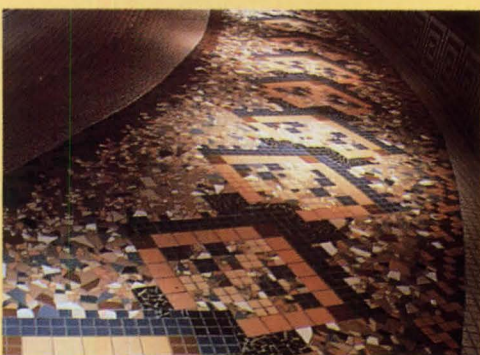
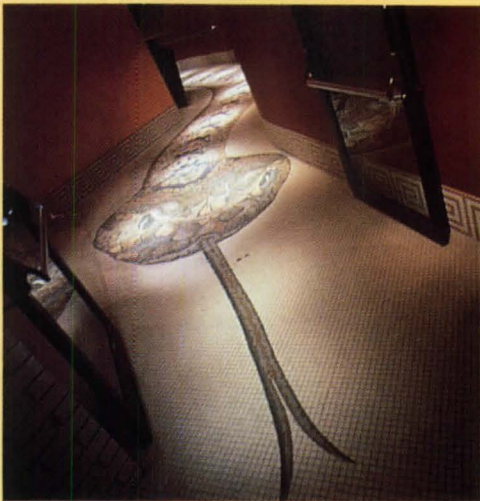

307. Serpentine. The winners of the Ceramic Tile Distributors Association (CTDA) Spectrum Awards, for creativity in the use and installation of ceramic tile and natural stone, have been getting better and better. The spectacular tile snake on the floor of Pete & Marty's Restaurant in Toronto, designed by architects Gordon MacKay and Ron Wong, tied for first place with the Team Disney Building in Lakeland, Florida by Arata Isozaki & Associates, in the New Commercial Construction category of this year's competition. From a forked "tongue" (top) and along an almost three-dimensional "back" (below), the intricate mosaic made of 1- and 2-in. solid and shattered ceramics from Dal-Tile was produced using the Colorco process developed by Jim Burnard. A computer program lays out the tile on a grid, incorporating whole, robotically cut, and shattered tile placed both in pattern and randomly. Material is supplied to the site as paper-mounted sections, in boxes labeled first to last. Colorco Ltd., Merrimack, N. H. ■

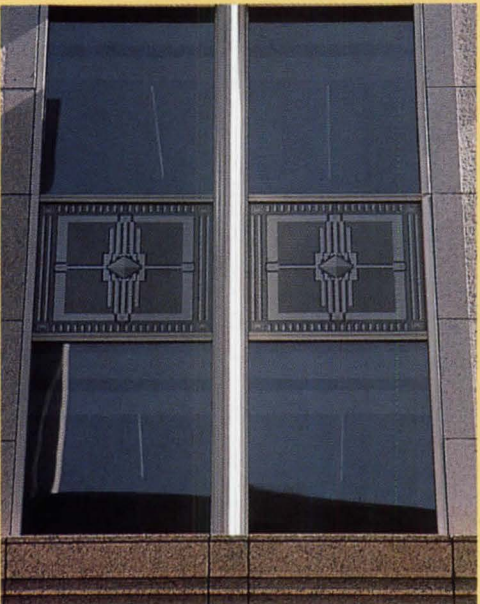

302



305 *Livas Design Group, Architect*

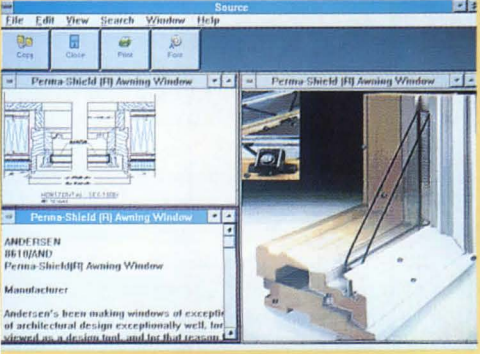

303



306

Securing the U. S. Abroad

By Stuart L. Knoop

U. S. embassies were, until recently, designed to convey the image of a nation confident in its guiding principles and open to the world. A series of searing experiences changed this approach: In 1983 the U. S. Embassy and Marine barracks in Lebanon were attacked by truck bombs; in 1985, the new embassy office building under construction in Moscow was revealed to have been severely compromised by Soviet eavesdropping apparatus. Sgt. Clayton Lonetree, a U. S. Marine Guard at Moscow's old embassy office building, was arrested in 1987 for allowing access by the KGB to sensitive areas of the building. The official American response to these events included the passage of the Omnibus Diplomatic Security Act of 1986 and, the development of new embassy design recommendations.

Architects have been designing for security at some level for centuries, from crenellations and portcullises to fences and locks. Security is as much a design constraint as the owner's program or zoning and building codes. With a number of new embassies under construction or completed, it's clear that they are now less open and more obviously defended (U. S. embassy in San Salvador, El Salvador, opposite bottom).

Presenting an architectural image that reflects our country's values, while meeting security concerns, is difficult for both the state department and architects. Too many designers, according to Skip Estrella, of Kaiser Permanente, writing in the journal *Security Management* (August 1988), resist facing these issues head on. He advises clients to "encourage architects to allow [security related] input into the designing process. Expect some resistance since planners have been relatively unrestricted in their processes."

In the post-cold war era, international terrorism has declined. American fatalities are down from nearly 200 killed in 1988, the year Pan Am flight 103 was blown up, to seven in 1991. Significantly, business targets have ac-

Stuart L. Knoop, a Partner in Oudens + Knoop, a Washington, D. C. architectural firm, specializes in embassy design.

1. Main entrance
2. Public parking
3. Chancery
4. Ambassador's residence
5. VIP guest parking
6. Employee parking
7. Marine security-guard quarters
8. Recreation center
9. Internal service-vehicle drive
10. Motorpool
11. Warehouse

counted for more incidents in most years than diplomatic, government, and military ones. In 1991, businesses were the most popular targets, accounting for about 230 incidents. Even so, embassies, subject to a wide variety of threats, will continue to represent security design's cutting edge.

A new-generation embassy

An unbuilt compound was designed for a site in a moderately developed suburb. Though the suburban location exposes officials to attack while riding in vehicles from the compound to the capital, the site (drawing above) was chosen to allow adequate separation—standoff—between buildings and the perimeter of the site (minimizing the effect of vehicle bombs).

Public transportation in this city is limited to crowded, undependable buses and some taxis, so the principal access is by private automobile. Every entering vehicle must be searched at a "sally port." Since this requires a few minutes for each vehicle, congestion is probable in the main entrance court. The trade-off is that vehicles are in a

protected compound all day, and persons can walk between their cars and the embassy in a controlled environment. Visitors park off compound, and they are under observation as they walk from the gate to the chancery.

Service access is through a separate sally port to a delivery courtyard. Freight is off-loaded to the warehouse where goods are uncrated, inspected, and transferred to embassy vehicles for delivery within the compound. The standoff distance separates the warehouse from the embassy in case there are surprises inside the crates. Vehicles for the ambassador's guests can be permitted on site after being checked at the sally port. At the discretion of the embassy, they can be parked either within the compound or at the external entrance court.

The Marine guard quarters is a focus of social life for American embassies, and visitors include embassy employees and the community at large. Admittance of their cars to the site is at the discretion of the embassy. If allowed to park in the employee parking area, the location of the vehicles maintains an ap-

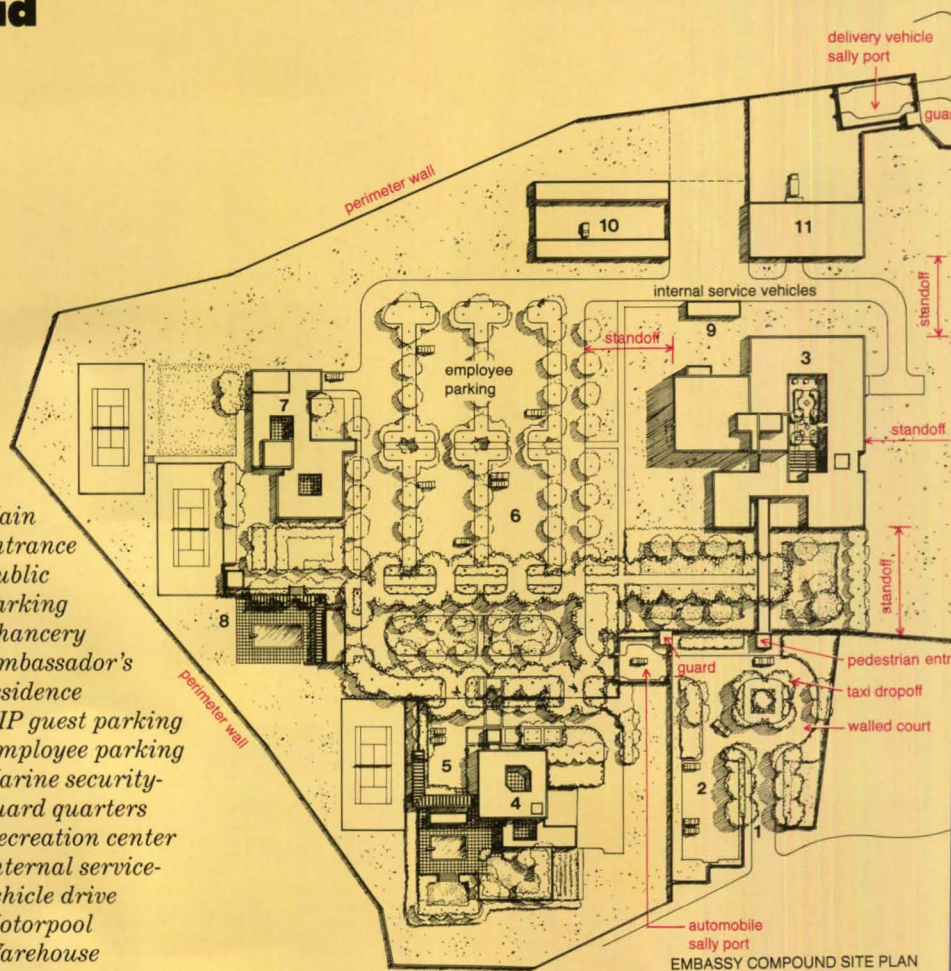

Despite rapidly changing world power relationships, embassies still embody the cutting edge of building-security design.

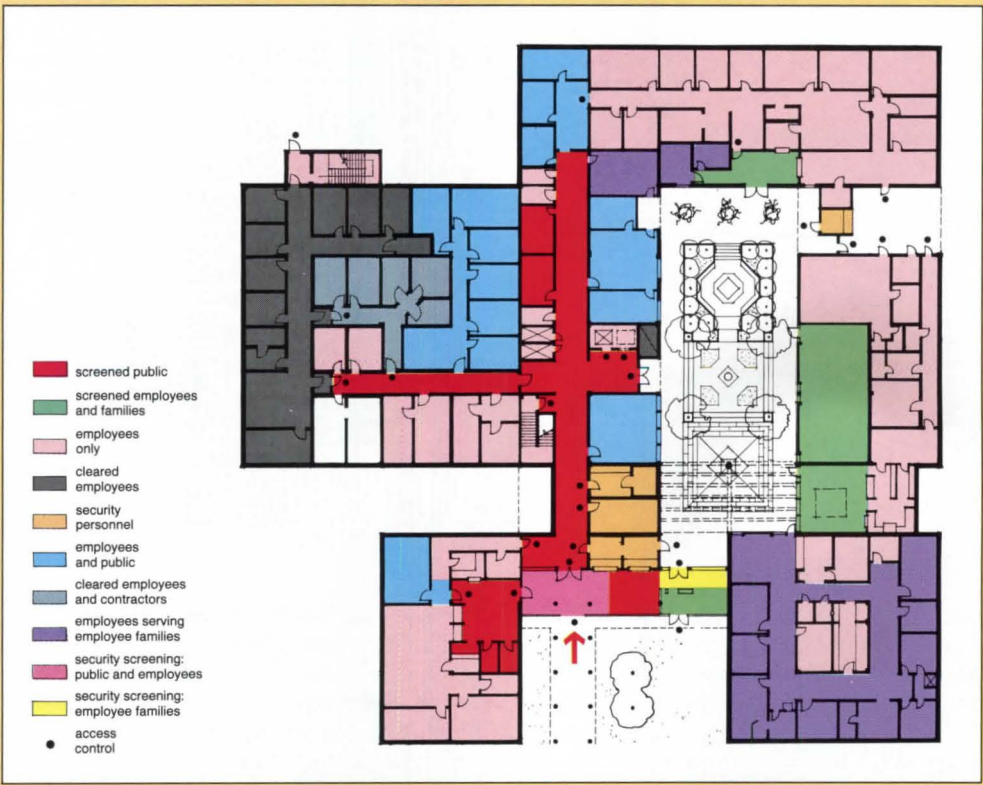

Guards and vehicular sally ports screen entrances to an embassy compound (opposite). Within the chancery (above), walk-through metal detectors screen users. Inspectors also examine bags, briefcases, and parcels.

the location of the vehicles maintains an appropriate standoff distance from the chancery.

The drawing above illustrates security zoning and access control. After screening, consular visitors proceed unescorted to the section at the left of the lobby where ballistic and forced-entry-resistant walls, doors, and teller windows separate the staff from the public. Other visitors, such as vendors and host-country officials, are screened, then proceed with escort to their destinations.

Employee access to any part of the building depends on level of clearance and need to have access. Control points shown on the plan are card readers or combination locks. Employees' families (once screened) are ad-

mitted to the courtyard where they can reach the health unit, commissary, mail room, and dining facilities without entering controlled areas of the building. At the far left is an area where classified activities are conducted, and includes a suite of offices, which are the only areas in this zone where local officials are permitted. The classified activities are sensitive enough to require radio-frequency shielding as an eavesdropping countermeasure, so the entrances to the area consist of interlocked vestibule doors.

Assessing risks for changing threats
Design for physical security does, of course, affect and sometimes conflict with other architectural program requirements. Windows, doors, and other openings are inherently vulnerable to penetration. Life-safety provisions and fire-control access must be designed to deny illicit entry. Security barriers, screening devices, and hardware must not compromise access by the disabled.

Though security is rarely the primary purpose of a project, nearly every building type

has some security component. Physical security design begins with a threat analysis. The owner, working with law enforcement and security professionals, must evaluate the following issues:

- *Type of threat:* burglary; vandalism; espionage; terrorism; hijacking; eavesdropping; assault; robbery; arson; theft; rape.
- *Potential perpetrator:* nonprofessional individual; hostile crowd; state-sponsored terrorist; amateur hacker; intelligence agency; commercial competitor.
- *Means:* manual force; hand tools; power tools; handguns; military weapons; explosive charges; car bombs; off-the-shelf electronics; sophisticated eavesdropping equipment.
- *Target:* retail goods; narcotics and pharmaceuticals; classified or proprietary information; symbolic buildings; political, sports, or entertainment figures.

Once the threat characteristics are identified, security strategies may be proposed. Building-security decisions, though, are never cut and dried. The owner—working with the architect, legal and insurance counsel, and security professional—must set the acceptable level of risk. First costs and operating costs of security measures must be compared to the potential replacement cost of assets, the costs incurred should information be compromised, or the costs from liability for injury or loss of life.

Further Information
"The Embassy of the Future" (1987) is a booklet containing recommendations for embassy security design. Write to: Director, Building Research Board, National Research Council, 2101 Constitution Avenue, N. W., Washington, D. C. 20418. ■



U. S. Embassy, San Salvador, CRSS Sirrione International, Architects.

Building-Security Basics

By John Burnett

Building security systems can be obvious, as a deterrent, or discreet. Either way, the time to address a building's security needs is at the front end of a project during the schematic design phase. Otherwise, security requirements will demand design and esthetic sacrifices. Building entrance, elevator, stairwell, and traffic-flow designs can be innately safer if such considerations are an integral factor at the onset. Building security increasingly means designing in technology. Deciding the most visually attractive location and coordinating surrounding finishes for security devices such as card readers, CCTV cameras, and the spatial needs of monitors and consoles (security-officer stations)—the focus of this article—should occur during early design stages. A checklist:

- **Allocate space for security equipment.** Space options may be restricted or unavailable once electrical switch gear, transformers, and other equipment is installed in the building's electrical room or a closet used to house electrical panels.
- **Locate the main security-monitoring terminal.** And consider whether remote sites are necessary. Will the main terminal be installed (as is frequently the case) at the security console? If so, will a remote terminal in the building manager's office be required? Will other systems such as CCTV or fire be monitored in the same location? Many larger buildings require remote terminals for tenants as well (example diagram above), which may suggest a different design for the security console and calls for additional coordination of conduit location.
- **Be aware of conduit-wiring requirements.** This is particularly important where expensive high-end finish materials such as stone are used, or in case of other esthetic concerns. For example, when card readers are to be mounted on a marble wall, the stone should be pre-cut to ensure access to conduits and to attain the most attractive

John Burnett is the U.S. sales director of Intercon Security Limited, which offers security-consulting services, protection, and components.

With early planning, architects can integrate building-security devices and systems, not merely add them on.

Building security system schematic diagram

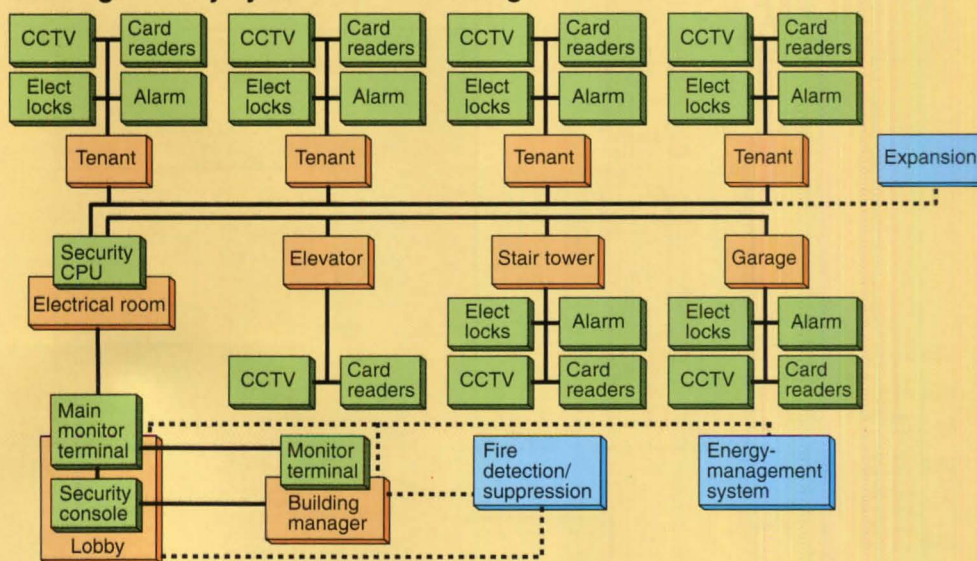

apertures. If left to the final construction stage, you can count on incurring hefty additional costs. Early programming of security needs will determine whether vertical building chases will accommodate security conduits.

- **Consider tenants' specific security requirements.** In multitenant buildings (particularly highrises), tenant space might use card readers hooked up to the base building system. In that case, the architect must allocate space for data lines and conduits to run from the tenant space to the main security central-processing unit.
- **Recognize that card-reader technologies vary.** Each option must be coordinated with the surface in which it is mounted. "Swipe" readers are usually surface-mounted and visible. "Insert" readers, on the other hand, are generally recessed, necessitating installation clearance within walls. "Proximity" readers can be surface-mounted, recessed, or completely hidden within a wall. In the latter arrangement, only a dot or other marking (which the designer can choose) appears on the activating surface.
- **Select door-locking devices to match door types.** Just as door types vary (glass, wood, aluminum- or steel-framed), so does security hardware, with wired devices—electric strikes, magnetic locks, smoke tower locks,

electronic latch sets, and electric hinges—adding complexity. Installation procedures differ as well. For example, an electric strike cannot be directly mounted on a glass door. Steel or aluminum door frames are often grouted solid with mortar, which prevents easy mounting of electrical devices. Architects should require that hardware preparation be completed at the time of manufacture. This not only cuts down field expense and delay, it flags any remaining door/hardware/security-device conflicts before fabrication.

- **Address elevator security.** Increasingly, access is being restricted by floor. Thus, card-reader apertures need to be cut in elevators. Mounting and clearance conflicts can result if these apertures are not accounted for in drawings and specifications. Lack of coordination could mean removing an entire stainless-steel panel to field-cut an opening. Furthermore, there may not be sufficient space to recess the card reader if elevator security becomes an afterthought.
- **CCTV cameras need not be intrusive.** mount CCTV cameras decoratively (you need not accept standard brackets), semi-flush, surface-mounted, or even concealed (pinhole cameras). For the last choice, you must allocate clearance for the camera body behind the finish surface. (This is especially important in elevators.)

Defending Communities



Oscar Newman

- *Don't expect custom finishes from all security companies.* Matching security devices to adjacent finishes (using bronze or stainless-steel face plates or other special color finishes) is usually feasible. However, not all security companies will provide such features without additional cost. Moreover, failure to specify custom finishes when prices are bid or negotiated could eliminate your options entirely, forcing you to stick with standard ill-matched hardware.

To avoid delays, extra costs, and a barrage of change orders, let a security contractor or consultant (as well as your usual hardware consultant) review schedules and specifications. That way, conflicts, such as that between electric strikes and inappropriate latch sets or deadbolts, can be avoided.

- *Be aware of security-wiring differences.* Two basic configurations exist—hardwired and multiplexed. Hardwired systems hook up alarm points individually to the main controls, whereas multiplexed systems typically connect these points to a data-gathering panel, and a single data line runs to the main security terminal. Multiplexed systems, which are considered more technologically advanced, require less conduit and cable, and are often preferred.

- *All security products are not created equal.* Different systems have different capabilities and if specific performance objectives aren't spelled out, you may have to settle for a security system that doesn't offer the level of support the client wants. As noted above, not all products have the same conduit and cable requirements, a fact that has spatial implications.

- *Consider expansion up front.* The time to think about future expansion is in the design stage. Space restrictions may limit the size, locations, and efficiency of a property's security system and staff. Furthermore, accommodating unplanned growth phases can become costly. Equally important, initial security considerations such as placement of the security console (or consoles), its size (including workspace for security officers), the number and location of CCTV monitors, can result in coordination nightmares unless carefully thought out ahead of time. ■

For all the talk of rebuilding cities since the riots in Los Angeles, there has been little discussion of the role of planning, design, or architecture in restoring a sense of community to areas—such as South-Central Los Angeles—marked by considerable disinvestment. One who has continued to work in and learn from such communities is Oscar Newman, best known for his seminal 1973 book, *Defensible Space* (it's out of print).

Newman's firm, the Institute for Community Design Analysis, of Great Neck, N. Y., has continued to address the way the physical environment encourages or deters crime, but the firm now engages communities, not just public housing, the focus of Newman's book. (He has, however, just completed assisted housing for racially divided Yonkers, N. Y.) Newman finds that architectural interventions not only can deter crime, they can build community self-esteem, essential to any long-term reinvestment strategy.

Shoring up a city neighborhood

The Five Oaks neighborhood, in Dayton, Ohio, is a predominantly residential neighborhood near downtown, with a mix of handsome, well-built houses, duplexes, and small apartment buildings. Though it doesn't fit the stereotype of the tenement-filled ghetto of older, bigger, central cities, the pathologies are often the same. In this case, according to the Institute's report, they are: "heavy through traffic, crime and the evidence of criminals, property conversions and disinvestment, lack of commonly held values among neighbors, loss of desired diversity of income and race."

The Institute's solutions use physical interventions (it proposes to rework the street pattern to create identifiable sub-neighborhoods and reduce through traffic). But its remedies are more comprehensive: lower barriers to home ownership (through reduced downpayments and assistance with rehabilitation); improve code enforcement (targeted at absentee owners who are "milking" properties); and enlist the community in targeted law enforcement. The plan slates improvements to promote surveillance among residents of a housing project within the neighborhood. As the report notes, "Reinvestment in one's own property and in the

neighborhood will now be undertaken not as a risky, individual action, but in concert with one's neighbors."

Rescuing the strip

Another Institute project is a rehabilitation plan for a two-mile commercial strip that lines State Route 7, the eastern boundary of Plantation, Florida. Plantation's highway strip is typical of aging commercial corridors that, like older cities, suffer from deterioration and disinvestment. In this case, Newman's team found crime was spreading into adjacent residential neighborhoods.

The Institute determined that the source of much of the area's crime was a poor, unincorporated area nearby. Solving that district's problems was beyond the project's scopes. To shore up the identity and security of the residential areas, the Institute proposed using architectural walls and gates to close eight of the neighborhood streets that penetrated the commercial strip (with special provision for emergency vehicles). A proposed reconfiguration of the strip itself separates through traffic from shoppers, eliminating dozens of curb cuts in favor of landscaped linear parking and an attractively planted sidewalk that abuts the storefronts rather than the speeding traffic. Pedestrian traffic and a specific commercial identity is further encouraged by a coordinated redevelopment of the strip's prime crossroads with small gardens and architecturally designed pedestrian bridges.

Constant concern for surveillance in community design isn't glamorous. But cities realize that if they can't reduce crime—and fear of crime—their future is in jeopardy. J. S. R.

Height + Water = Cool

A technological twist is breathing new life into a traditional architectural device used to reduce air temperatures in hot, dry climates. The Environmental Research Laboratory (ERL) at the University of Arizona, Tucson, is in the process of commercializing what it calls "cool tower" technology through a spinoff company, Cool Tower Systems. In traditional Middle Eastern architecture, tall masonry towers are used to catch passing breezes and direct them down to shaded courtyards, where fountains often lower temperatures further. Cool towers, as reinvented by the ERL, take those principles a couple of steps farther. A pump conveys water to the top of a tower where it passes through fibrous cooling pads mounted in an opening oriented to catch breezes (drawing at right). The cooling pads allow moving air to pass through the water, which evaporates. (Cool Tower Systems uses an evaporative material called Celdek.) As the air absorbs water, its temperature drops dramatically. The cool air falls, creating a wave of coldness at the bottom of the tower and a negative pressure at the top, drawing more hot air through the pads. This localized blast of cool air costs little in terms of energy or equipment.

A better evaporative-cooling mousetrap

Mechanical refrigeration using an evaporative process is not unusual in hot, dry areas. Southwestern restaurant patios are increasingly turning to misting devices, another form of evaporative cooling. And the following pages show some of the inventive ways evaporative cooling is used in Seville's Expo '92. ERL simply harnesses the laws of physics (the towers) and a medium that boosts the efficiency of the evaporation (the cooling pads) to make the most of the concept.

Cool towers are not an all-purpose solution: high humidity, for example, reduces the ability of air to absorb water from the cooling pads. Based on prototypes the ERL built in Tucson, the hotter and drier the day, the more effective the cooling, ranging from as much as a 40-deg drop when temperatures are over 100F (as they are for many days during the Southwestern summer) to a 15-deg drop during Arizona's rainier months. ERL calculated energy consumption of cool towers compared to other cooling methods

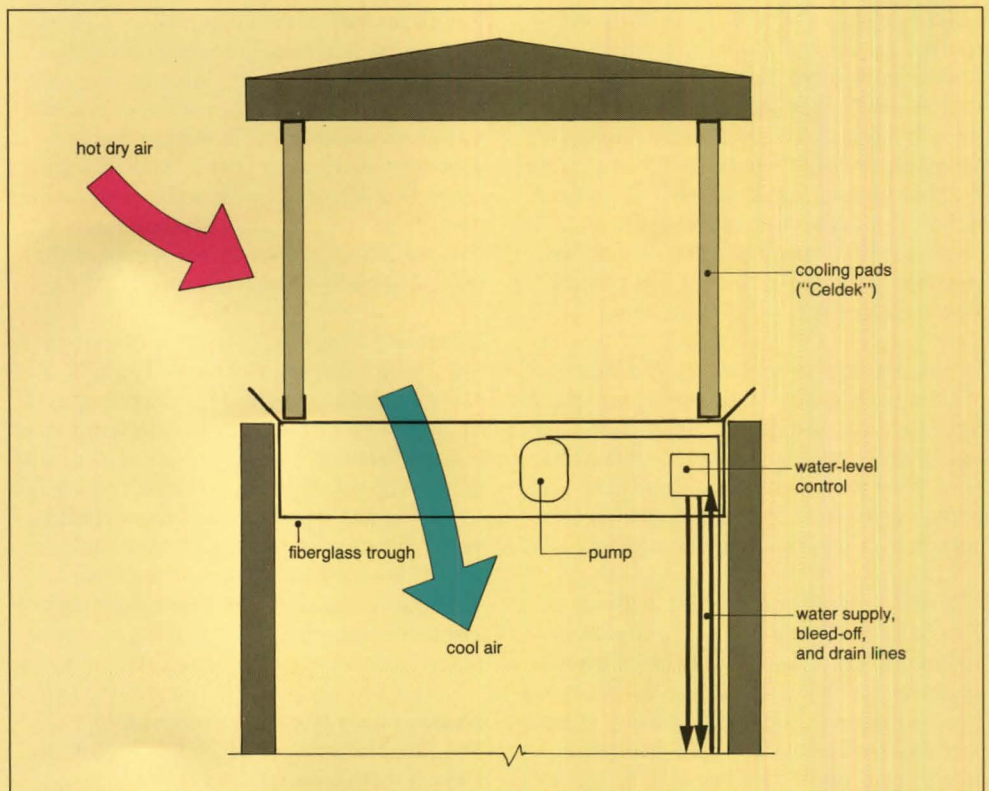

This section through the top of a cool tower shows its minimal requirements: insulated walls and roof, pump and related piping, cooling pads, and controls.

and found that conventional refrigeration created 7,500 Btu of cooling per kwh of power used, while cool towers produced 87,800 Btu using the same amount of power. (Other evaporative-cooling systems would fall near 19,000 Btu.) The system *does* need water (which is not typically plentiful in areas where cool towers are most useful), but ERL claims cool towers provide more cooling per unit of water than other evaporative systems.

Because cool towers don't produce tempered air within the narrow range of comfort occupants in air-conditioned buildings expect, they are best suited for such transitional areas as public entrances and concourses, shopping malls, outdoor restaurant patios, and home courtyards. They are also useful in remote areas where power is scarce. They've begun to appear in Arizona transit facilities in Phoenix and Scottsdale. In Tucson, they were designed into the Ronstadt Transit Center (opposite top) by C. W.

Fentress J. H. Bradburn and Associates. They've also been proposed for a yet-to-be-built civic plaza in downtown Phoenix.

Though Cool Tower Systems sells the towers as complete assemblies, architects may want to incorporate them into a larger architectural ensemble, enclosing the pads, pumps, and related components with the wall system intended for the rest of the project. The company provides design parameters and will engineer the system. Typically towers are 25 to 40 ft high, cover no more than 25 sq ft, and can cool areas ranging from 300 sq ft to 1000 sq ft (the latter indoors) per tower. *James S. Russell*

Further information

Cool Tower Systems, 8611 N. Black Canyon Highway, Ste 216, Phoenix, Ariz. 85021 (602/995-2101)
Environmental Research Laboratory, 2601 E. Airport Dr., Tucson, Ariz. 85706 (602/741-1990)

Since summer temperatures can reach 114F, waiting for the bus in Tucson, Arizona, can threaten the lives of those in poor health. Architects C. W. Fentress J. H. Bradburn and Associates incorporated two cool towers into the 18-berth Ronstadt Transit Center, located near the arts district in the city's downtown. Waiting passengers stand under or near the towers, which lower temperatures as much as 20 deg. The cooling effects are amplified through landscaping, broad roofs, and screens.

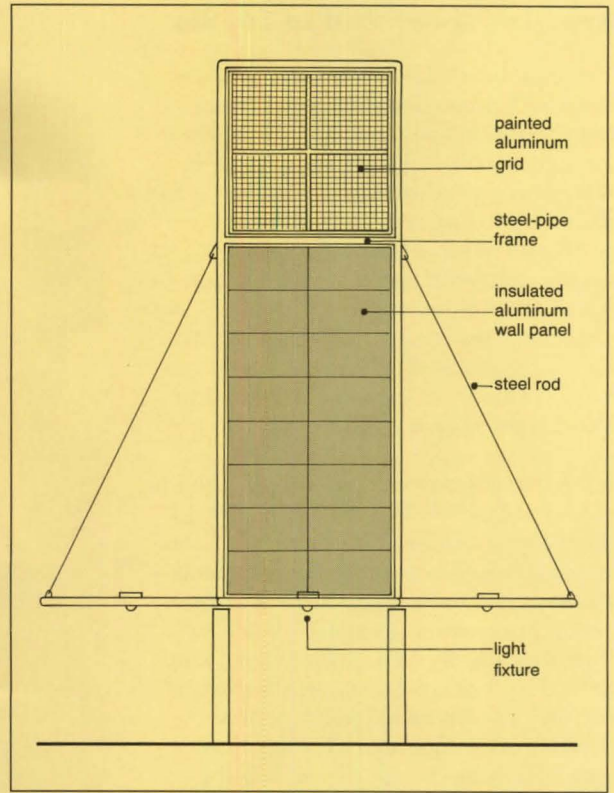

© Nick Merrick/Hedrich-Blessing

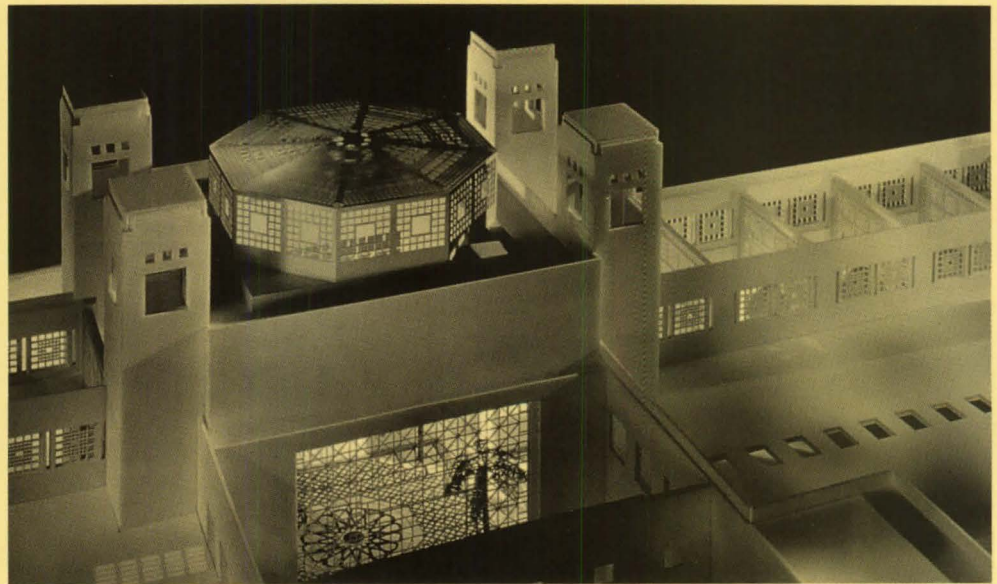
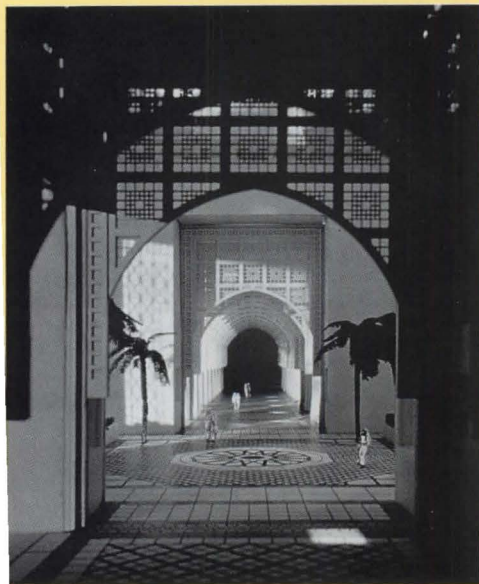

IDEA/Perkins & Will Architects has proposed a half-mile-long outdoor pedestrian spine for the men's campus of Saudi Arabia's Umm Al Qura University. This shaded street will incorporate 29 cool towers (left and right above). The towers

evoke regional prototypes. Daylight will be filtered and the walk will be screened from winds and blowing desert sand. The cool towers will create a transitional zone between the exterior at desert temperatures and the academic buildings,

which will be mechanically cooled using centrally chilled water piped to individual buildings. Flack + Kurtz has designed the mechanical systems and the Planetary Design Group, of Tucson, will develop the cool towers.

Bringing some chill to Seville

The organizers of Seville's Expo '92 were faced with protecting 18-million visitors from Southern Spain's searing heat, which averages 100F and can rise to over 115F. While many pavilions are at least partly mechanically cooled, architects of other pavilions and all of the public areas have devised a number of inventive ways to take the curse off the climate. There is plenty of local inspiration, especially the fountain-cooled, courts and gardens of Seville's 14th-century Alcázar Palace, which was designed after Moorish prototypes.

Informed by research carried out at the University of Seville's Department of Energy Engineering and Fluid Mechanics, such traditional devices as pergolas and fountains were adapted to increase their cooling efficiency. Space-frame pergolas containing vines irrigated by drip systems cover some 500,000 sq ft of the Expo site, absorbing solar energy and raising humidity (thus lowering the temperature in this dry climate). Many are equipped with misting devices (figure 3, opposite). The metal-mesh skin of the Bioclimatic Sphere (Antonio Cano, Pedro Silva and Manuel Alvarez, architects) supports hundreds of computer-controlled micronizers, producing clouds of mist based on temperature and breezes (1). Visitors willingly trade a wet-head look for the cooling effect. In a European version of cool towers, a ring of misters crowns the fabric towers that march down the Avenue of Europe (4, 5, opposite). Architects are Jean Marie Henning and Nicolas Normier, of France. The fabric coverings were designed by George Lippsmeier, of Germany.

Fountains are used not only to lower temperatures, but to give a tactile and psychological sense of coolness. Among the most unusual is the undulating 400-meter-long glass waterwall designed by SITE for Avenue 5 (2). It passes among refreshment stands and plant-festooned columns that support the Expo's monorail overhead. A rock garden at one end of the Avenue, a pond at the other, and layers of multicolored sands visible through the wall's glass suggest the changing course over time of Seville's Guadalquivir River. *J. S. R.*

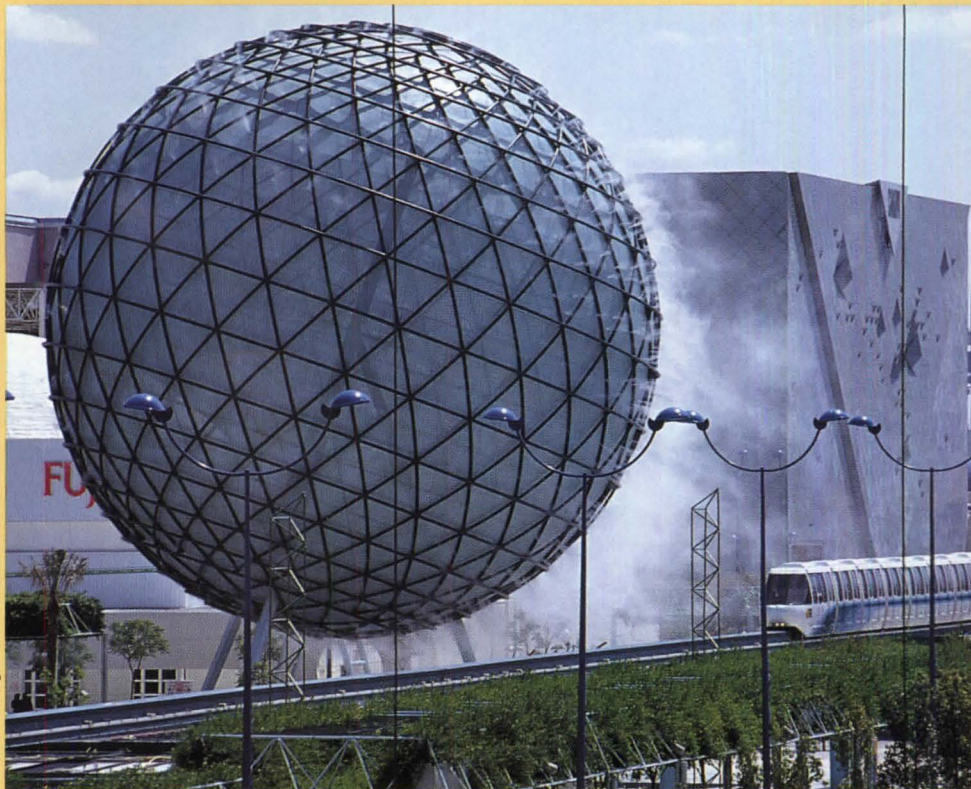

© Richard Bryant/ARCAID



Courtesy SITE

- 1. Bioclimatic Sphere
- 2. Avenue 5
- 3. Expo pergolas
- 4., 5. Avenue of Europe

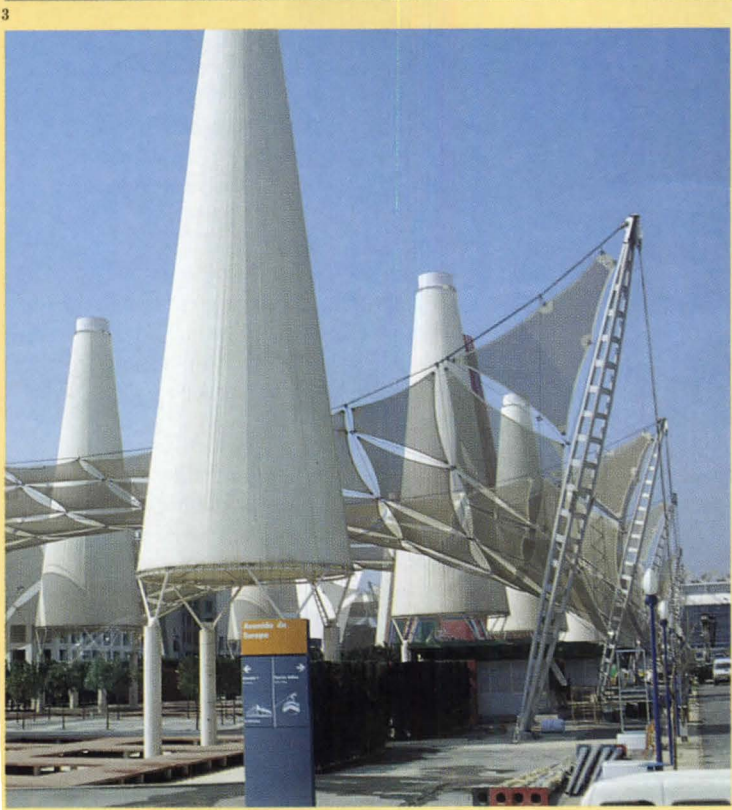

Product Reviews from A/E/C

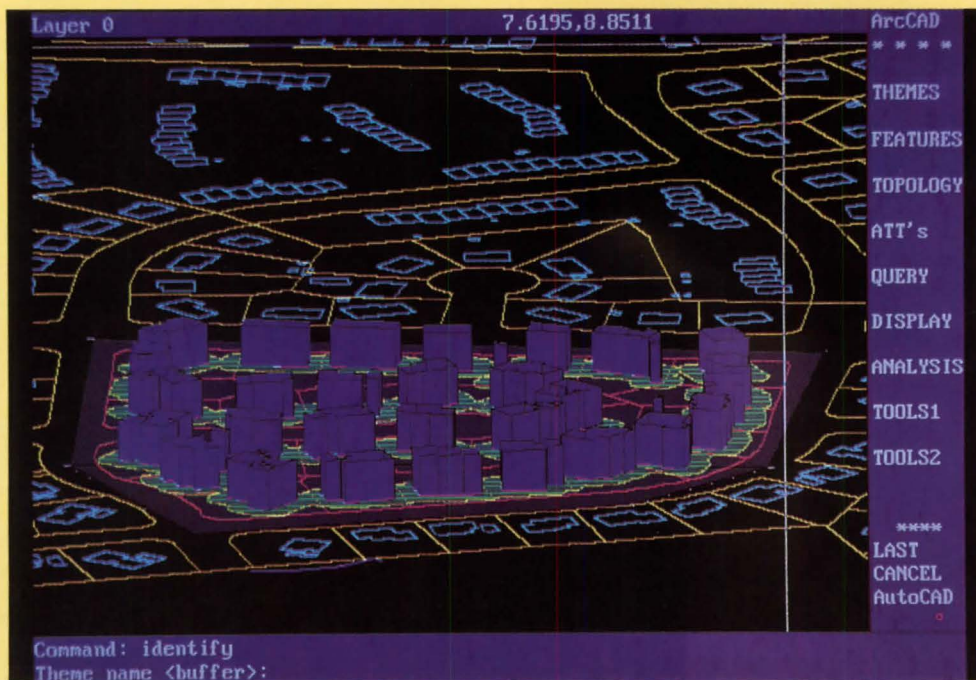

1
By Steven S. Ross

The coming age of software compatibility was on display at the national A/E/C Systems meeting in Dallas this June. All major CAD vendors showed software that can read and write AutoCAD binary DWG files—no more inaccurate, cumbersome DXF translations. Many vendors showed Windows-compatible versions of CAD software—the key to easy linking with non-CAD database, image-editing, and word-processing software. Equipment suppliers supported the Windows push by releasing device drivers to link Windows with plotters and other devices.

Even the two biggest developers of AutoCAD add-on software, ASG and Softdesk, have decided to compete on features, rather than by trying to lock customers into proprietary standards. Softdesk's Auto-Architect will read ASG's Vertex details. Apple even showed a \$1,299 gray-scale image scanner meant for use with DOS computers running Microsoft Windows. The OneScanner comes complete with easy-to-use software. **Circle 150**

The push for cooperation hit the estimating world, too. R. S. Means, for instance, has joined forces with 12 of the largest publish-

ers of construction-estimating software. The contents of Means annual construction-data books will now be electronically packaged for Timberline, Software Shop Systems, G2, MC2, BSDI/Composer Gold, and many other packages. **Circle 151**

The biggest spur to compatibility was, of all things, a government requirement. Vendors were told that if they wished to propose their wares for NAVFAC CAD II, the biggest CAD contract ever—supplying the Naval Facilities Command—they would have to be able to handle AutoCAD files. The requirement came about because NAVFAC surveyed CAD users, and found more of them exchanging AutoCAD files than all other file types combined.

Intergraph's Bentley Systems affiliate licensed Marcomp's programming library to read DWG files for Intergraph MicroStation (with the ability to write DWG promised for the fall). Marcomp had developed the capability for its Autoview Plus, an AutoCAD file viewing program. Other CAD vendors have licensed DWG translation capability from Sirlin and other firms in the "file management" software business.

All this may have the effect, oddly enough,

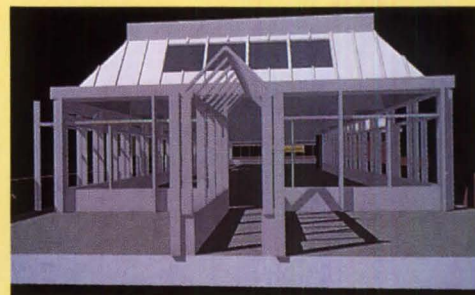

3
of dislodging AutoCAD from the top of the software heap. If other companies can read and write AutoCAD files, and if developers of add-on software can easily modify their Windows applications for other Windows CAD packages, what advantages does market leadership hold? On the other hand, Autodesk was hardly standing still. AutoCAD keeps getting better (finally, much better on networks), and is being joined by an ever widening array of multimedia and animation products.

Sweetening the pot, of course, was the continuing drop in equipment prices. It is now possible to buy a fully equipped engineering workstation from Sun, Silicon Graphics, or Hewlett-Packard for under \$15,000. A fully equipped DOS or Macintosh computer will set you back well under \$10,000. Apple's super-fast Quadra series, the high end of the Macintosh line, turned heads—and spurred high-end CAD vendors to announce improved products to run on it. Color output? Plotters and printer plotters dropped another price notch.

The big technical advances were closer integration of CAD and Geographical Information System (CGIS) files, especially on AutoCAD, and introduction of pen-based

Software compatibility was the theme, 'we're all connected...' the refrain at the Dallas show.

For more information circle item numbers on Reader Service Cards.

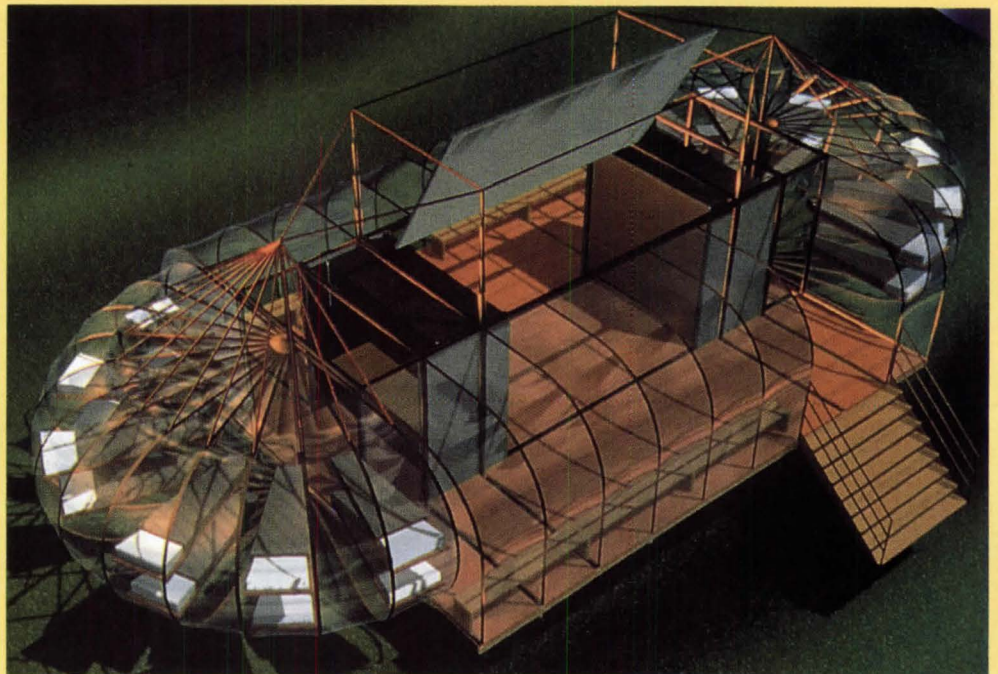
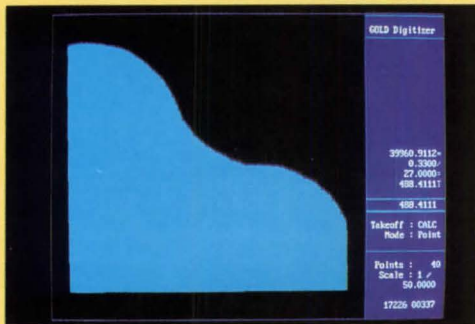

computing to architectural applications.

For users, there's an increased comfort level in all of this. It is hardly likely that any purchases made today will become obsolete due to vendors disappearing or refusing to support an older product.

But who, then, *will* do the support? We're all connected, it seems. But when something goes wrong, whom are we to blame? Obviously, a strong dealer is key.

CAD software

Aside from compatibility, easier networking and Windows versions were the big news.

Alias showed a revision of its Upfront modeling package for Windows, version 1.1, with easier links to AutoCAD files. Version 2.0 for the Macintosh, with more speed and versatility, was also announced. Both should be shipping as this issue appears. The Sonata CAD and modeling package for the IRIS Indigo workstation is ready for a North American rollout, too. All but a few installations so far have been in Europe. **Circle 152**

American Small Business Computers announced its first truly high-end CAD package, DesignCAD Professional. It comes

complete with SmartEST, an estimating package also sold separately. DesignCAD 3-D Version 4.0 includes better pull-down menus, more speed, and realistic shading (up to eight light sources).

Circle 153

Autodesk itself released AutoCAD 12 for DOS computers and the Sun SPARC series of UNIX workstations. It runs faster than AutoCAD 11, has a wider range of image zooms without forcing a lengthy screen regeneration, and allows soft locking of referenced drawings, so calling up a file with referenced files attached does not lock out all of the involved files from being edited on a network. Perhaps best of all, AutoCAD 12 files are essentially identical to AutoCAD 11, so exchanges between the two are worry-free, and AutoCAD 11 for Windows works with either 11 or 12. Autodesk raised the price for 12, to \$3,750, but AutoSHADE, minus the Renderman extension, is now built-in. (AutoCAD 12 will be reviewed in RECORD in a future issue.) **Circle 154**

Autodesk was also demonstrating AutoCAD Release 11 and Generic CADD 2.0 for the Macintosh; they shipped just a month before the show. AutoCAD Mac 11 has some features of AutoCAD 12 for DOS and UNIX,

and is much closer to the standard Macintosh interface than was the first Macintosh version, Release 10. **Circle 155**

Silicon Graphics also announced enhancements for AutoCAD 11 on its IRIS workstations. Many software vendors are supporting packages on the IRIS series, especially for the under-\$10,000 Indigo model. **Circle 156**

Autodesys showed version 2.0 of its form-Z 3-D modeling software, with easier curve generation and easier integration of solid and surface shapes. This Macintosh package is almost CAD-like in its range of drawing tools. **Circle 157**

CADworks is shipping AutoCAD link to read AutoCAD binary files into Drawbase. The conversion engine is from Sirlin. **Circle 158**

Digital Equipment Corp. and Electronic

1. ArcCAD for AutoCAD.
2. ArchiCAD.
3. Calcomp Designmate.
- 4.,5. Composer Gold by BSD, Inc. .
6. RenderStar's Modern Medium.

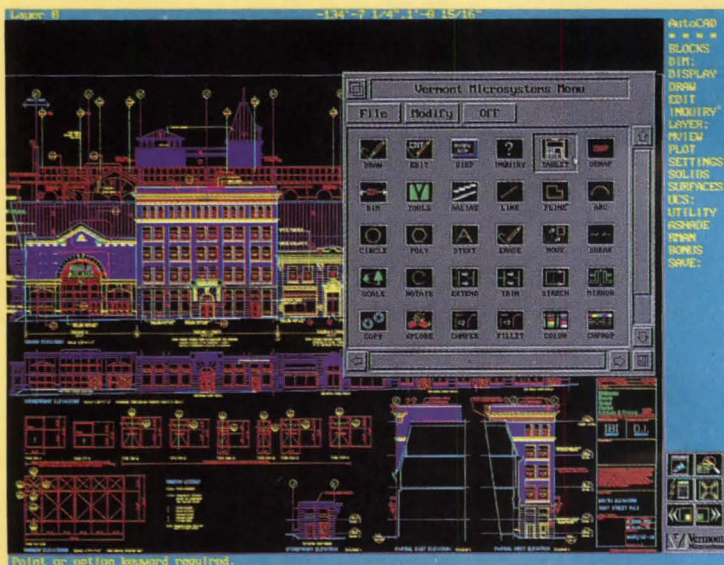

7

Data Systems were showing MicroGDS—a Windows-based version of the VAX workstation GDS software for computer-assisted design and (especially) for geographical information systems. It runs on 80386 (or fancier) DOS computers, but its file structure is compatible with mainframe GDS. A version for Hewlett-Packard Apollo 9000 Series 700 workstations was announced at the show as well. **Circle 159**

Foresight Resources was showing the latest version of its Windows CAD software, Drafix Windows CAD 2.0. The package, released last winter, received much interest at the show—mainly, it seems, because on-screen editing and drawing are easy, as with the firm's Drafix Ultra for DOS. **Circle 160**

Intergraph announced it would be adapting its MicroStation I/RAS B raster/vector editing software to the Sun SPARC series of computers. This allows scanned raster images to be edited and turned into vector drawings. A new Macintosh version of MicroStation was announced for this summer. Intergraph is also producing a Windows version for MicroStation; the interface looks like UNIX-based Motif software, but all the Windows links and utilities will be supported. Its ModelView PC-based rendering systems [RECORD, June 1992, page 52] now handles DXF files.

Circle 161



8

IsiCAD showed its Cadvance 5.0 for Windows. The software, scheduled for release by this fall, takes advantage of all the Windows utilities and links to other Windows software. Using technology licensed from Sirlin, it will be able to read and write AutoCAD DWG files directly. IsiCAD hopes to get architects to try Cadvance in part by keeping the price low—an introductory \$395 for users of other high-end CAD software. The "regular" price of \$1,995 is about two-thirds the norm for high-end CAD.

Circle 162

UNIC announced upgrades to both the Macintosh and the Windows versions of Architrion. Dubbed versions 5.7, they will include photorealistic rendering licensed from Ray Dream. The new versions are scheduled for September shipment.

Circle 163

Add-on software

The big packages got bigger still—with ASG, KETIV, and Softdesk adding features to their AutoCAD add-ons. Smaller firms explored new markets, however, not just with AutoCAD but with other software as well. The advances involved integration with geographical-information systems, corridor design, and combined scheduling-modeling-drafting approaches.

Andersen Windows released version AC2.2



Steve Ross photo

9

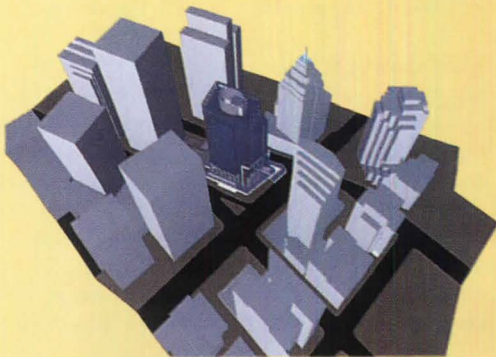

10

For more information circle item numbers on Reader Service Cards.



11 of its CADD-I AutoCAD add-on for specifying windows. It is now fully integrated with the AutoCAD menu and has more flexible layering capabilities. It is also fully compatible with Softdesk's Auto-Architect. CADD-I, and a DXF version for other CAD software, are available free to architects and builders. **Circle 164**

Artist Software said it would support its GT Express display-list-processing software for AutoCAD on the IRIS Indigo workstation from Silicon Graphics. **Circle 165**

ASG said it would also support most applications of its add-on software for AutoCAD on the IRIS workstation series from Silicon Graphics, including the new Indigo model. ASG also announced 14 companies that would distribute computerized details through its Vertex division. **Circle 166**

Building Systems Design Inc. showed its Composer Gold cost-estimating software; the interface is easy to use. **Circle 167**

DGI released Master Connection, to do two-way translations between MicroStation and DXF, IGES, and ISIF files in 2-D or 3-D. **Circle 168**

EPIC, the Electronic Product Information Corp., showed a standard Windows-based product-information system that integrates drawings of manufacturers' products with AutoCAD and other software. The system has been supported by the National Roofing Contractors Association and window (the kind you look through) manufacturers. **Circle 169**

Environmental Systems Research Institute has taken its ARC/Info geographical information system and linked it to AutoCAD. The result, dubbed ArcCAD, is not simply a way to display the ARC/Info-generated maps that are becoming so popular with local planners. Like a true GIS (see Practice article, page 33), ArcCAD extends AutoCAD's data model so that the resulting drawing obeys GIS "rules." **Circle 170**

FM:Systems introduced FM:Space-Management 4.0, an add-on that provides access to a facilities-management database from inside Cadvance or AutoCAD. The new version has a more flexible data structure, more ways to select data from the database, and a better report generator. **Circle 171**

KETIV showed its ARCH-T2/3-D add-on for

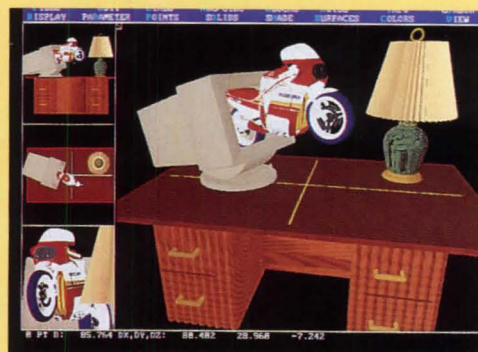

12

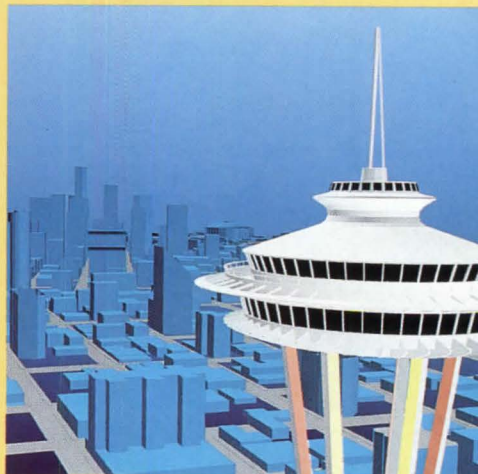

13

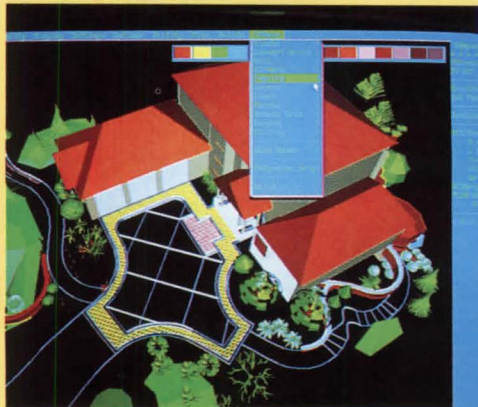

14

7. Vermont Microsystems' Automatic Window accelerator in software.
8. SLICK! for UNIX.
9. Wacom.
10. ArchiCAD.
11. AutoCAD: outerspace to inneroffice.
12. DesignCAD.
13. KETIV.
14. LandCADD.

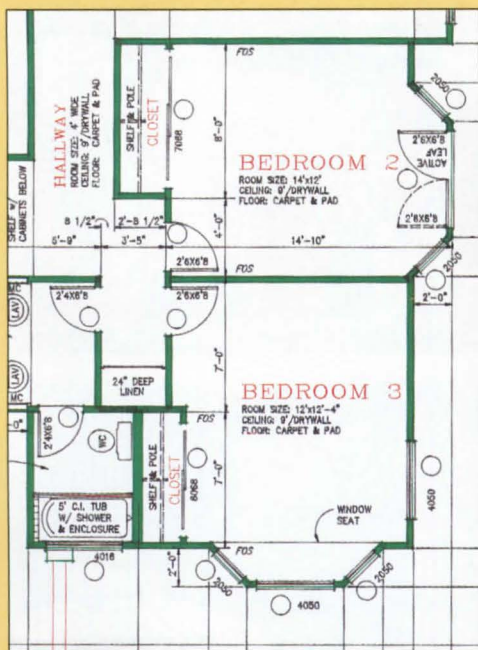

15



16

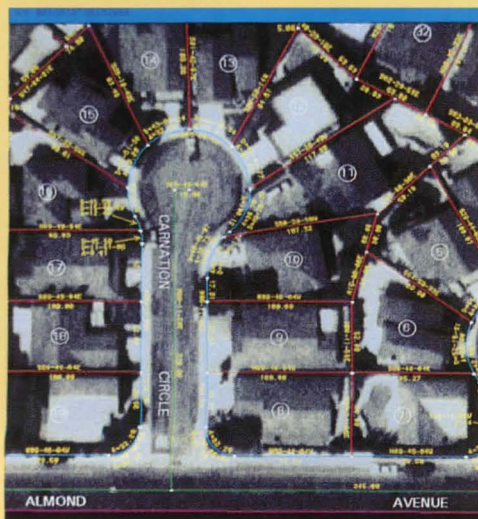

17

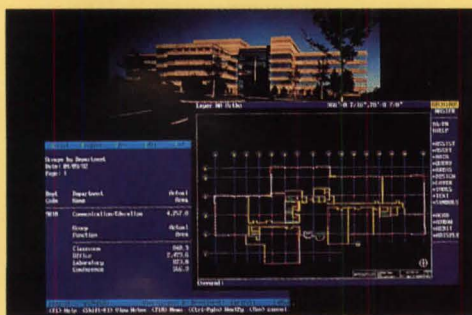

18

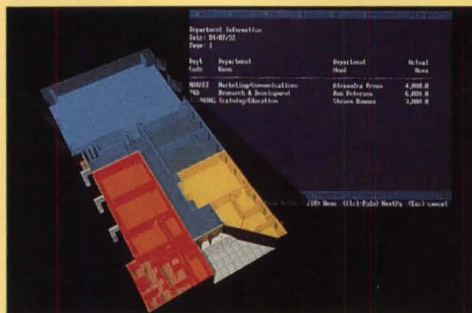

19

AutoCAD, with a rendering module, the Advanced Rendering Extension. It includes many 3-D AutoCAD "blocks" (symbols), all AutoSHADE and ARE compatible. **Circle 172**

Schreiber Instruments announced IMAGINE Nursery, for modeling 58 types of deciduous trees inside Autodesk 3-D Studio. The trees grow and change with the seasons. **Circle 173**

Softdesk, formerly DCA Software, showed major revisions to its Auto-Architect 3-D editing package for AutoCAD. Enhancements for production drafting—especially for manipulating pre-defined walls and details—were particularly interesting. The firm's Advanced Design add-on, for corridors (highways, power-line routes, and so forth) has also been improved. Softdesk also released a \$495 suite of productivity tools for AutoCAD—including easier layer management and drawing setup. **Circle 174**

Sweet's demonstrated its SweetSource CD-ROM catalog of product information at the show; it will be distributed starting in 1993 to users of the Sweet's catalog in paper form. But unlike the hard-bound volumes, it will be updated quarterly. (See **Product**

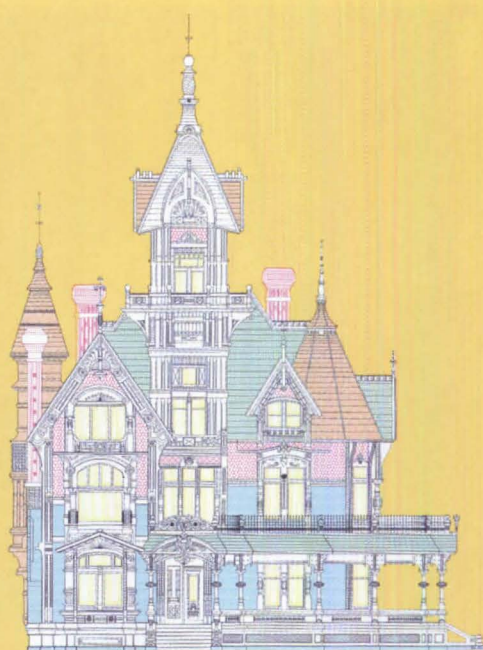

20

News on pages 34-35 for additional details). Circle 175

TAMKO Asphalt products showed version 2.0 of its AutoCAD add-on software, TamCADD, for developing roofing specs and detail drawings. **Circle 176**

Two new packages for automating takeoff, estimate, bid and job-cost accounting were released by Vertigraph. Bidworx Takeoff and Estimating System 5.0 can import most construction-cost databases. Bookworx, a new accounting package, can be run in a network. **Circle 177**

Visual Software announced a \$895 rendering package, Renderize, for the Indigo. It works with DXF and OBJ files. The firm also sells a file viewer, shader, and plotter for AutoCAD files on DOS or Sun computers. **Circle 178**

Image handling

More versatile and more network-friendly file viewing and file-management software was everywhere. The big new features this year were easier redlining—the ability to "mark" drawings for modifications—and easier version control. On the hardware side, many graphics-card manufacturers were of-

For more information circle item numbers on Reader Service Cards.

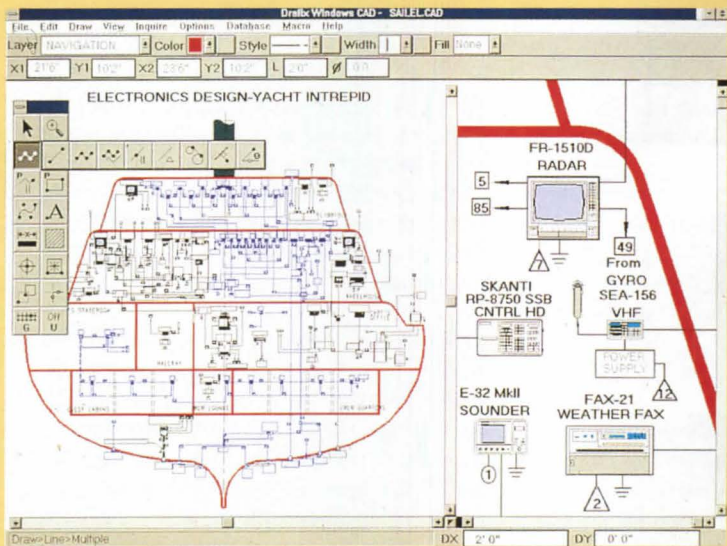

21

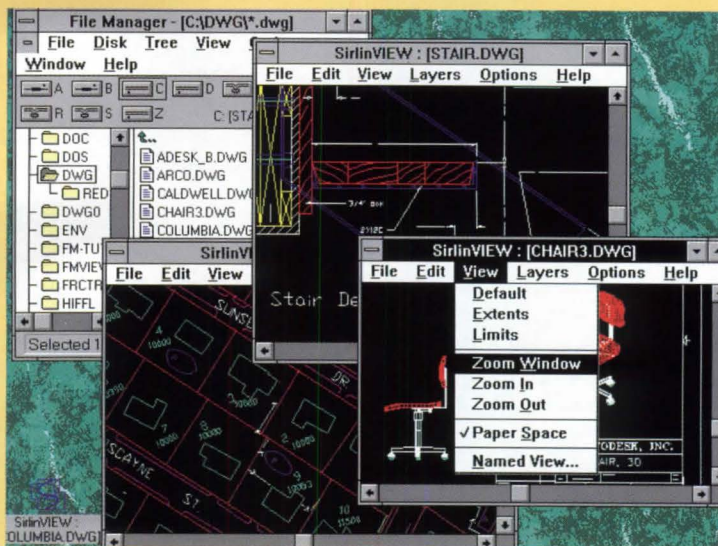

22

fering lower prices and more versatile driver software—for matching high-resolution cards with different CAD packages. It seemed clear at the show that the low end has been getting better—particularly 1024 by 768 interlaced displays. We played with some samples from Headland Technologies (Video Seven) and Hercules on our own equipment (rather than on fine-tuned show-booth monitors) and confirmed it: If you have avoided the cheap interlaced displays because of flicker in the past, look again. You might just get by.

In addition, the display-list drivers packaged with many boards (and often compatible only with AutoCAD) now offer far more than fast zooms and pans; most have on-screen menus and multiple viewports. In a sense, the extra features are necessary to keep ahead of AutoCAD itself; AutoCAD 12 has a very large zoom range without time-consuming on-screen image regenerations. (Display-list software and associated video hardware will be reviewed in a later issue.)

CADSystems Unlimited unveiled SLICK! for viewing, plotting, and redlining DWG and DXF files on Sun systems; an earlier version runs on DOS networks and stand-alone computers. *Circle number 179*

Cyco International released AutoManager WorkFlow 2.0; it tracks and views AutoCAD drawings and handles revision control in

DOS networks or on stand-alone computers. This successor to Cyco's AutoBASE 1.2 has a Windows-like interface, direct plotting to most plotters and printers, easier tracking of referenced drawings (drawings referenced by other drawings), and support for many third-party AutoCAD add-ons from ASG, Softdesk, and others. A Sun OpenLook version is promised by fall. *Circle 180*

Database Applications introduced CADEXnet v.4.1, designed for routing documents through a network for various approvals. It runs on DOS and Sun workstations; earlier versions also run on VAX/VMS systems. *Circle 181*

Expert Graphics introduced new Rasterex graphics boards and software. These boards are essentially programmable computers within your computer that manipulate images. One package it showed was RxRasterCAD; it takes scanned raster images and turns sections of them into AutoCAD vector entities. *Circle 182*

GTX's GTXRaster TRACE for AutoCAD turns most raster formats into a base for AutoCAD drawings. A/E/C Systems attendees were offered it for \$99. *Circle 183*

Ideal Scanners & Copiers released a new version of its CADImage/SCAN raster-to-vector software for large-format scanners. The biggest advance: It prescans the draw-



23



24

15. Calcomp plot, Designmate software

16. Calcomp electrostatic plotter.

17. ARC/INFO 6.1.

18., 19. Archibus facilities planning.

20. Novajet plot for Autodesk.

21. Drafix Windows CAD.

22. SView by Sirlin.

23. Alias Upfront for Windows 1.1.

24. Form Z (Le Corbusier's Chapel of Notre Dame du Haut).

ing—perhaps an old blueprint—for stains and variations in the background, and takes them into account when it makes the final conversion scan to a vector file. The Ideal/Contex scanner line is compatible with DOS, Sun, Macintosh, and other workstations. *Circle 184*

Image Systems Technology unveiled its CAD Overlay ESP 4.0. This latest version can, for the first time, snap a vector shape to a raster image inside AutoCAD, using any AutoCAD drawing command. For instance, you can use the VCIRCLE command to pick three points near a raster-image circle from a scanned blueprint. CAD Overlay ESP will snap a circle to the raster image, let you verify it, and erase the raster underneath. A version for Silicon Graphics workstations is promised by fall. *Circle 185*

Nth Graphics, a vendor of high-speed graphics boards and software, is now selling its viewing software, Nth View, separately. It handles real-time zooms and edge-pans, and features redlining and multiple views, even outside AutoCAD itself. Nth Drive display-list-processing software now handles true-color rendering within an AutoCAD viewport. *Circle 186*

Panacea, another pioneering developer of display-list software for speeding AutoCAD files, announced its TurboDLD "classic" and "deluxe" versions for almost any DOS-based equipment. *Circle 187*

Need 500-dot-per-inch images scanned in 24-bit color (up to 16.7-million shades)? Polaroid's new CS-500 line can scan a 4 by 6 image at that resolution in only 12 seconds. Polaroid has positioned the scanners as perfect for adding backgrounds to computer-generated models. The units are compatible with Windows and Macintosh systems, and are part of a comprehensive line that includes slide-output devices and digital printers. *Circle 188*

Sirlin announced that its low-cost Sirlin/POP CAD viewing software is available for Windows and Sun computers, as well as linking directly with AutoCAD. It can view files in DWG, DXF, HPGL, TIFF and PCX formats. *Circle number 189*

SoftSource's Drawing Librarian displays and prints AutoCAD DWG, Slide, DXF, and HPGL files, allows redlining, and links drawings to other files. There are versions for Sun, DEC, Windows, and straight DOS systems. *Circle 190*

Vermont Microsystems aimed a \$99 display-list driver directly at AutoCAD for Windows. Called AutoMate/WIN, it will work with any graphics card, including the company's own. *Circle 191*

Printers and plotters

Many companies offered printer-plotters based on the Canon BubbleJet engine for C-size drawings. Houston Instruments/Summagraphics expanded upon its JetPro version [RECORD, May, 1992, page 43], Pacific Data introduced its ProTracer, and JRL showed its JR-670. The various makers packed their units with different interpreters (HPGL, PostScript, and so forth), different paper feed trays, and other niceties at prices ranging from about \$1,500 to \$2,500. *Circle 192*

Calcomp cut the prices of most of the printers and plotters in its display at the show. But the big news was in a private suite, where the firm showed a new D-size 8-pen plotter, the DesignMate 3024, for \$1,992. It is a bit slow compared to the company's higher-priced Pacesetter models—about 20 inches per second plotting speed. But it is quiet, and offers impressive plotting software, including HP-GL/2, PostScript, and CalComp's PCI. *Circle 193*

The NovaJET color inkjet from Enter Computer (the Encad plotter people) is a new idea—fast (at least compared to plotters) E-size, 256-color plots using what are essentially oversize DeskJet ink cartridges. The output is gorgeous. Plotting languages built in are HP-GL, HP-GL/2 and HP RTL. The price is \$10,995. *Circle 194*

JDL introduced three D- and E-size direct-imaging plotters; they can produce a plot of that width in a minute or two, on paper, vellum, or film. Software allows easy integration into network environments. The ExpressPlotter II now has a Macintosh 32-

bit Quickdraw driver and Sun driver as well. *Circle 195*

Mutoh America showed its F-920A pencil plotter with a holder and automatic feed for up to 260 leads at a time. The unit can plot for days without running dry. This plotter also has a conventional 8-pen carousel. Mutoh was also showing a B-size laser plotter for \$8,495. *Circle 196*

Océ Graphics dropped the price of its new D- and E-size xerographic plotters to \$19,990 and \$20,990, respectively, and offered conversion packages to owners of earlier systems, to upgrade plotter-language capability and resolution. The firm also introduced screen-capture software for DECStation computers running Ultrix with X/windows, DEDWindows, or Motif; the Sun version has been available since late last year. *Circle 197*

Xerox offered improvements up and down the line—the Model 3050 plain-paper copier for D- and E-size drawings, for instance, is aimed at mid-volume needs. An E-size (48 by 36 in.) copy takes about 20 seconds. The price is \$22,495. The 3090 model, three times faster, comes in at about twice the price. Xerox also offered better warranty terms on all its printers and printer-plotters, and new fast SCSI interfaces to Hewlett-Packard and Silicon Graphics computers for its Versatec line. *Circle 198*

Computer hardware

Hewlett-Packard released two UNIX workstations in its Apollo 9000 Series 700 line; the models 705 and 710 cost about \$12,000 with 16 MB of random-access memory and 420 MB fixed disks. Among the software packages running on the Apollo was Powershade 3-D, a true ray-tracing package for amazingly realistic images. *Circle 199*

Sun Microsystems introduced a new family of low-cost, high-performance workstations. The lowest-price configuration, the 36 MHz SPARCserver 10 Model 30, with 32 MB of random-access memory and 424 MB fixed disk, lists at \$16,995. The price for the SPARCstation IPX was dropped to about \$12,000 with 16 MB of RAM

and 207 MB fixed disk. *Circle 200*

Project and facilities management

The Allegro Group announced Version 5 of its Resource Management System, with new or enhanced interfaces to Deltek, Harper & Shuman, Wind-2, and Timberline accounting software. It allows you to monitor expenses, handle scheduling, and so forth. *Circle 201*

Archibus introduced FM/6.0 with three new modules—real property and lease management, telecommunications and cable management, and building-operations management. There's also easier editing of data, and a much easier-to-use report generator. *Circle 202*

Graphic Systems, Inc., announced CAFM Access, based on the Oracle database system. The firm, run by Eric Teicholz, customizes the software for its clients. CAFM Works, a subsidiary, sells blocking and stacking software as well. *Circle 203*

Harper and Shuman released Version 10 of its Micro/CFMS facilities management software, with improved menu and client database. The product is endorsed by NSPE and sponsored by the AIA. The firm also released a Profit Center Reporting module, with up to three levels of business unit coding. *Circle 204*

Jacobus demonstrated a new approach to scheduling and planning; users see their building "built" on-screen according to the schedule selected. This "Construction Simulation Toolkit" helps visualize all the pieces of large projects coming together. The software is scheduled to ship late this summer. It works with Jacobus Technology's Walkthru PC, and with AutoCAD or Intergraph MicroStation files, among others. Jacobus also showed modeling packages for interference detection for AutoCAD, Intergraph, and IBM systems. *Circle 205*

The National Institute of Building Sciences continues to expand its Construction Criteria Base on CD ROM. It now includes product information as well as government specifications. One new specification database added this year—NASA's SPECSINTACT. *Circle 206*

Pathfinder introduced its Star*Watch Cosmos project-information system; it's capable of handling huge multi-billion dollar projects. Unlike most project management software, it is driven by "scope of work" reporting rather than by scheduling. This latest version automatically highlights project elements that require attention. It runs on single-station or networked DOS systems. *Circle 207*

Primavera Systems started shipping its Parade 2.0 performance measurement software for integrating cost and schedule data. It also displayed its SureTrak Project Scheduler 2.0, for smaller projects than the full-blown Primavera Project Planner Version 5.0, which now costs \$9,500. *Circle 208*

DailyLog, a Primavera add-on from CMR Publishing, makes it easy to enter daily updates on any project. A bundle with 5- to 7-day calendar conversion, ADM (Primavera) to PDM (specification) conversion, and variance reporting utilities. Version 2.0 will ship in early 1993. *Circle 209*

Pen-based input Archway showed its \$595 PenDrafter; it works with Superscript, Wacom, and Calcomp digitizer display pads. *Circle 210*

Stylos Development Corp. showed its new Stylos/Markup for the pen version of Windows. It works with AutoCAD and Intergraph files, any DXF files, or TIFF images. There are versions for portable and desktop computers. *Circle 211*

Summagraphics is bundling a 6- by 9-in. digitizing tablet with Windows for Pen Computing and an AutoCAD ADI driver. The package can be used for pen input to AutoCAD or any Windows-compatible software. *Circle 212*

Wacom, building on its experience with digitizer pens that are pressure sensitive (its drawing program for the Macintosh has used the technology for three years), introduced a digitizing tablet with LCD face; combined with the pen, the system offers easy—although a bit slow—pen input. *Circle 213*

Multipoint had a clever 3-D mouse for \$250. By swiveling the mouse body, you can move the cursor in the Z direction on-screen—making walkthroughs of simple 3-D models more realistic and intuitive. *Circle 214*

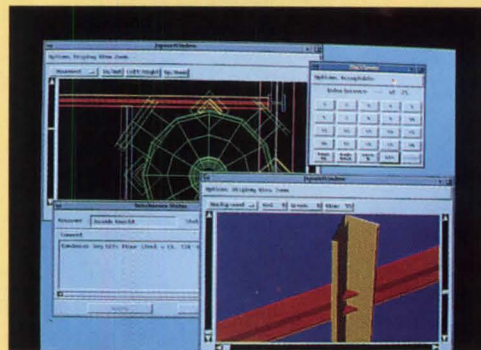

JT/ID for IBM.

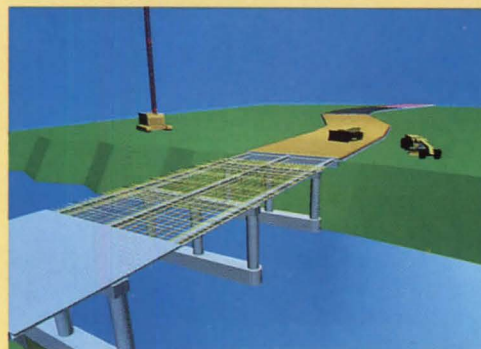

Jacobus Construction Management.



Auto-Architect for Softdesk.

Boom Town U.S.A.

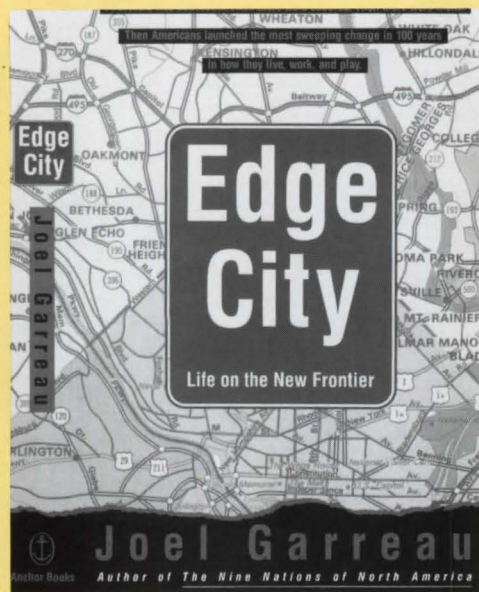

Edge City: Life on the New Frontier, by Joel Garreau. New York: Doubleday, 1991, 546 pages, \$22.50.

Edge City is about nothing less than profound changes in America. So why does author Joel Garreau begin by pandering? "The controversial assumption undergirding the book," he writes in his first sentence, "is that Americans basically are pretty smart cookies who generally know what they're doing." Garreau's intention is clearly to put some distance between his work and other books that decry the state of urban America.

The citizens of edge city are the heroes of his tale, reasonable people who just want good schools for their children, a nice place to live, and an easy commute. Not for Garreau the experts who question the consequences of leapfrogging suburban development, particularly the burgeoning satellite downtowns that now ring every major city.

The story of *Edge City* needs to be told. This shift to nodes and corridors of large-scale commercial and residential development is possibly more important than the explosion of suburbs around central cities after World War II. And, it is largely a story that, until Garreau and a few others came along, had remained undocumented. To the extent the book's conclusions are accepted—and it's

clear Garreau wants everyone to see that the future, rightly or wrongly, is in edge cities—it could greatly influence the debate over the future of cities, both old and new.

Unfortunately, the debate deserves a better book. Garreau's definitions seem specific at first (an edge city has 5 million square feet of office space), but he gradually fuzzes the borders until the edge city idea takes in virtually everything that could be called suburban. Edge city, though, represents a radical departure from the previous suburban norm of bedroom communities and modest, low-scale suburban strips.

Garreau's line is that edge city is just America's way of reinventing itself to suit circumstances. Edge city, though, is more profoundly a product of speculation. Though Garreau understands this fact on one level, he misses the implications. While extolling the virtues of edge city (convenience, safety, niceness), he decries the lack of such traditional-city amenities as "secondhand bookstores; cobbler shops with craftsmen who know how to take apart and carefully fix good boots; fine, cheap restaurants of exotic ethnicity, like Ethiopian; and bistros where you can nurse a glass, people-watch, and read all afternoon if you choose."

Garreau just doesn't get it. Edge city excludes such activities because the developer-builder-lender-manager matrix that produces it doesn't know from Ethiopian. It understands eateries like Houlihans because such chains have the deep pockets of a conglomerate behind them.

Architects as shapers of this new form of urbanism get short shrift. "When I first started reporting on Edge Cities," Garreau writes, "one of my first genuine surprises was to discover just how little architects usually have to do with the appearance of these places. The height, shape, size, density, orientation, and materials of most buildings are largely determined by the formulaic economics of the Deal." Providing no proof, Garreau asserts, "It was not so much that these designers had been banished from playing a role in the major decisions about Edge City. As often as not, they had exiled themselves."

Missing from Garreau's story is the realization that the speculative impulse that drives edge city follows the path of least resistance. Architects or planners who offer a complex, synthetic version of development are not invited to the party. That is why edge city is on the edge: here speculators face fewer zoning restrictions or ornery neighborhood groups. By going beyond traditional-city political boundaries, developers think they can leave behind social problems and their related taxes and crime. Smaller, less organized government entities tend to be more receptive to the entreaties of well-organized developers bearing cash. As taxpayers, we assist this process by extending sewers, utilities, and—most importantly—highways to meet these new developments.

It is accurate to say, as Garreau asserts, that architects tend to be focused on the older cities and downtowns. These are, after all, places where architecture continues to have meaning, where there is some interplay between the public and private realms. Edge cities do tell us something important about older cities, however. Density works. When the first big wave of suburbanization occurred immediately after World War II, it was justified on the basis that the density of older cities was obsolete. Now all of the problems of these older cities—from traffic to air pollution to crime—have been gradually moving out to the suburbs. Low-density development differs from the old downtowns only in the much vaster landscape over which congestion is spread. Edge cities—nodes of towers amid the highways—happened because we learned that many activities can't be supported except by greater density than bedroom communities offered.

This in turn should urge us to look at what edge cities mean vis à vis older cities. We saw many suburbanites return to cities in the 1980s. We saw unexpected growth in downtowns. But we also saw a continued deterioration in the quality of life within cities. The question Garreau doesn't ask—and the crucial one for this decade—is whether continued suburbanization, whatever form it takes, is at the expense of established communities. We might not like the answer.

James S. Russell

Turning Over A New Leaf

Design for the Environment, by Dorothy Mackenzie. New York, Rizzoli, 1991, 176 pages, \$35.

Green Architecture, by Brenda and Robert Vale. Boston: Bullfinch Press, 1991, 192 pages, \$40.

Reviewed by Scott Gutterman

Books on the environment can trigger feelings of despair, insignificance, and ultimately, boredom. Admonitions to the effect of "If only everybody would..." tend to fall on deaf ears. The two books surveyed here recognize, in different ways, the importance of avoiding too preachy a tone, lest the reader turn his overtaxed attention elsewhere. Instead, they present forthright summaries of the situation at hand, then show design-oriented options that may lead us to find solutions.

In *Design for the Environment* Dorothy Mackenzie outlines problems such as the greenhouse effect, deforestation, water and land pollution, and ozone depletion—all before describing a host of surprisingly attractive responses. The book shows ecologically responsible work in the fields of architecture, interiors, and product and textile design. The motto "reduce, re-use, recycle" is adopted in a variety of novel ways, from the simple decorating of a chic clothing shop in London with found fittings, to the conversion of a mined quarry outside Barcelona into a recreational park.

Mackenzie believes in taking the industrialized landscape as is and working with it. She is rightly wary of large-scale visionary schemes, and favors individualized, user-friendly solutions. The products she shows—lamps, clocks, and the like, all of them energy-efficient, lightly packaged, and made from indigenous materials—are impressive. In her surveys of graphic and clothing design, she finds natural materials such as sugar paper and undyed cloth that are as elegant as their chemically processed counterparts. She also cites businesses such as The Body Shop for integrating high style with environmental awareness.

Husband-and-wife team Brenda and Robert Vale take a more down-and-dirty approach in

Photos courtesy of Rizzoli International

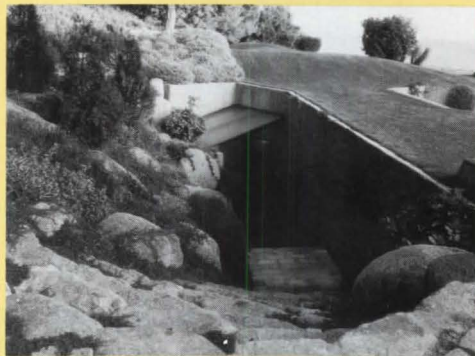

Satellite dish in Aflenz, Austria, designed by Gustav Peichl (top) and house in Catalonia, Spain, by Javier Barba (above) from Design for the Environment.

Green Architecture, unleashing a wealth of statistics to show how the planet is endangered. They feature designs and construction methods that allow the energy-efficient heating and cooling of buildings. Their focus on patterns of consumption seems directed at architects, engineers, and contractors; general readers are likely to come away more confused than when they started. In outlining a helpful set of principles for responsible building, the Vales, too, argue against monolithic plans and in favor of a low-key, community-centered approach. While both Mackenzie and the Vales offer numerous sunny, small-scale solutions to problems, neither seems to have fully come to grips with the enormity of the environmental problems facing us today.

Scott Gutterman is a writer specializing in art and architecture.

Architecture: The Natural and the Manmade, by Vincent Scully. New York: St. Martin's, 1991, 388 pages; \$40.

Reviewed by Nancy Levinson

In his latest book, Vincent Scully explores a rich theme. "The shape of architecture is the shape of the earth as it is modified by the structures of mankind," he writes. "Out of that relationship, human beings fashion an environment for themselves..."

Architecture: The Natural and the Manmade pursues its subject across continents and through centuries. The book begins in North America, with the Pueblo, Aztec, and Mayan peoples, and then travels to ancient Egypt, Greece, Byzantium, and Rome. Chapters are devoted to Gothic cathedrals and the gardens and fortifications of 17th-century France. Also examined are Renaissance towns, Palladian villas, English Romantic gardens, and our own century's troubled cities. The book ends with a return to the American experience, to the Vietnam Veterans' Memorial, whose designer, Maya Lin, studied with Scully.

Architecture keeps before us one essential distinction. In societies like the various native American tribes, Scully argues, "[t]he architectural principle at work... is that of the imitation of natural forms by human beings who seek thereby to fit themselves safely into nature's order." In contrast, in classical Greek society, and hence in our own, "the old imitation of the forms of the earth is given up" and the "human presence [brought] into a dialogue with nature." Generally, however, the author resists the academic tendency to classify and categorize. This is a deeply personal book, as emotional as it is intellectual. Writing here only of places he has visited, Scully pays close attention to the *experiencing* of buildings and landscapes. An imaginative observer, Scully finds unexpected relationships between buildings (such as Chartres and Bertram Goodhue's Nebraska State Capitol) and between architecture and the other arts. He connects the making of architecture to the full range of human endeavor, showing how it reveals both the world view and inner life of a society. ■

Briefly Noted

The Accessible Housing Design File, by Ronald L. Mace, FAIA. New York: Van Nostrand Reinhold, 1991, 213 pages, \$42.95. Using detailed illustrations and little jargon, this book presents an array of designs for handicapped-accessible parking, entrances, kitchens, bathrooms, and bedrooms. Plans meet or exceed ANSI and UFAS standards.

The Americans with Disabilities Act Facilities Compliance Workbook, by Evan Terry Associates. New York: John Wiley, 1992, \$150 (looseleaf).

A large looseleaf publication with worksheets and pages for notes, this book should help architects and facilities managers survey existing facilities and develop design solutions to the often vague requirements of the ADA. The book includes the full text of the ADA, the ADA Accessibility Guidelines, and regulations for the parts of the act that concern architectural changes in public accommodations and commercial facilities. The looseleaf format allows architects to add their own drawings and sketches.

Not In My Back Yard: Removing Barriers to Affordable Housing, by Thomas H. Kean and Thomas Ludlow Ashley. Washington: U.S. Department of Housing and Urban Development, 1991, 154 pages, \$4.

This book is the report of a blue-ribbon panel on regulatory barriers to affordable housing appointed by President George Bush and HUD Secretary Jack Kemp. The panel found that "exclusionary, discriminatory, and unnecessary regulations" raise the cost of housing by 20 to 35 percent, pushing the price of homes out of the reach of many lower-income families. The report recommends that the federal government act "as a vehicle for stimulating state (as well as local) regulatory reform efforts" and that HUD condition assistance to states and localities based on their removal of these barriers. The panel calls for changes in local building and zoning codes, as well as in national wetlands policy and the Endangered Species Act "to ensure proper consideration of housing affordability in the... implementation of environmental protection policy."

Collaborative Communities: Cohousing, Central Living, and Other New Forms of Housing with Shared Facilities, by Dorit Fromm. New York: Van Nostrand Reinhold, 1991, 296 pages, \$45.

An architect by training, the author maps out approaches taken in the expanding field of collaborative communities. The first section of the book covers European developments, while the second focuses on American projects. A third section examines issues facing architects in creating a collaborative community.

A History of Housing in New York City, by Richard Plunz. New York: Columbia University Press, 1992, 422 pages, \$19 (paper).

A richly detailed and clearly written book, Plunz's *History* concentrates on the years after 1850, when changing housing types and rapid growth transformed the city. The author examines development of the tenement and the garden apartment and looks at some of the pathologies of public housing. ■

Drawn for ARCHITECTURAL RECORD by Sidney Harris

PROPOSALS SUBMITTED TO THE LEARNED COUNCIL OF PISA IN AN ATTEMPT TO SOLVE THE PROBLEM OF ITS SERIOUSLY LEANING TOWER

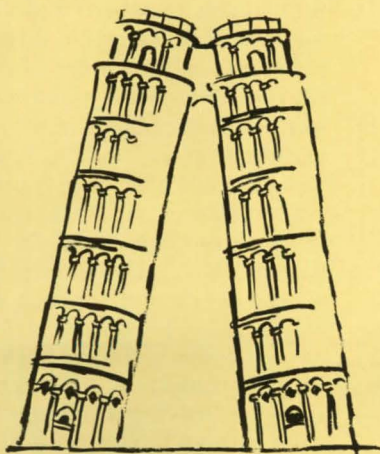

The Leaning Buttruss

This mirror-image support doubles available space for tourists.



The Sunken Tower

Top-floor entry at ground level. (100% guarantee not to lean)

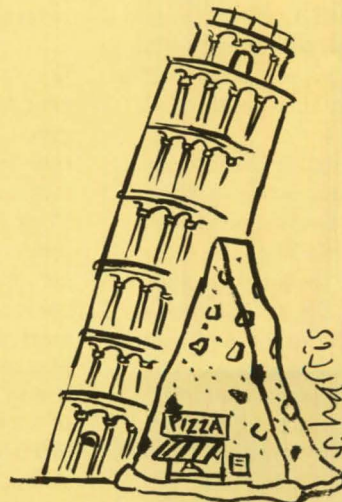

Pisa-Pizza

Wedge-shaped poured-concrete support doubles as fast-food outlet.

At a time of almost staggering political change in Europe—from the violent breakup of Yugoslavia and the more peaceful demise of the Soviet Union, to the reunification of Germany and the ongoing struggle to integrate the continent's economies—it would be easy to overlook Spain. But that would be a mistake, as our coverage of the 25th Olympic Summer Games in Barcelona and Expo '92 in Seville shows (pages 98-125). Spain has moved decisively from its longtime role as Europe's backwater, and joined its neighbors as a dynamic political, economic, and cultural force. What's more, Spain has looked beyond the short term of the Olympics and Expo, investing billions of dollars in new, often striking urban infrastructure, much of it designed by a young generation of Spanish architects.

Several of the projects in Spain called for collaboration among architects and artists. Back in the U. S. architect Adèle Naudé Santos and sculptor Mary Miss similarly joined forces for the Albright College Arts Center, a new campus hub that revolves around a two-story circular steel canopy (pages 78-83). Surface-integral ornament is a major artistic element in the Islamic Cultural Center of New York, designed by Skidmore, Owings & Merrill and located on Manhattan's Upper East Side (pages 90-97). Finally, Carlos Jimenez's Lynn Goode Gallery in Houston (pages 84-89) is a cool Modernist temple—not exactly a collaboration between the architect and any single artist, but rather a neutral backdrop for the work of many. *P. M. S.*

Inner Circle

A new arts complex serves as both a campus gateway and a focal point for indoor and outdoor activity.



*Albright College Center for the Arts
Reading, Pennsylvania
Adele Naudé Santos and Associates,
Jacobs/Wyper, Architects*

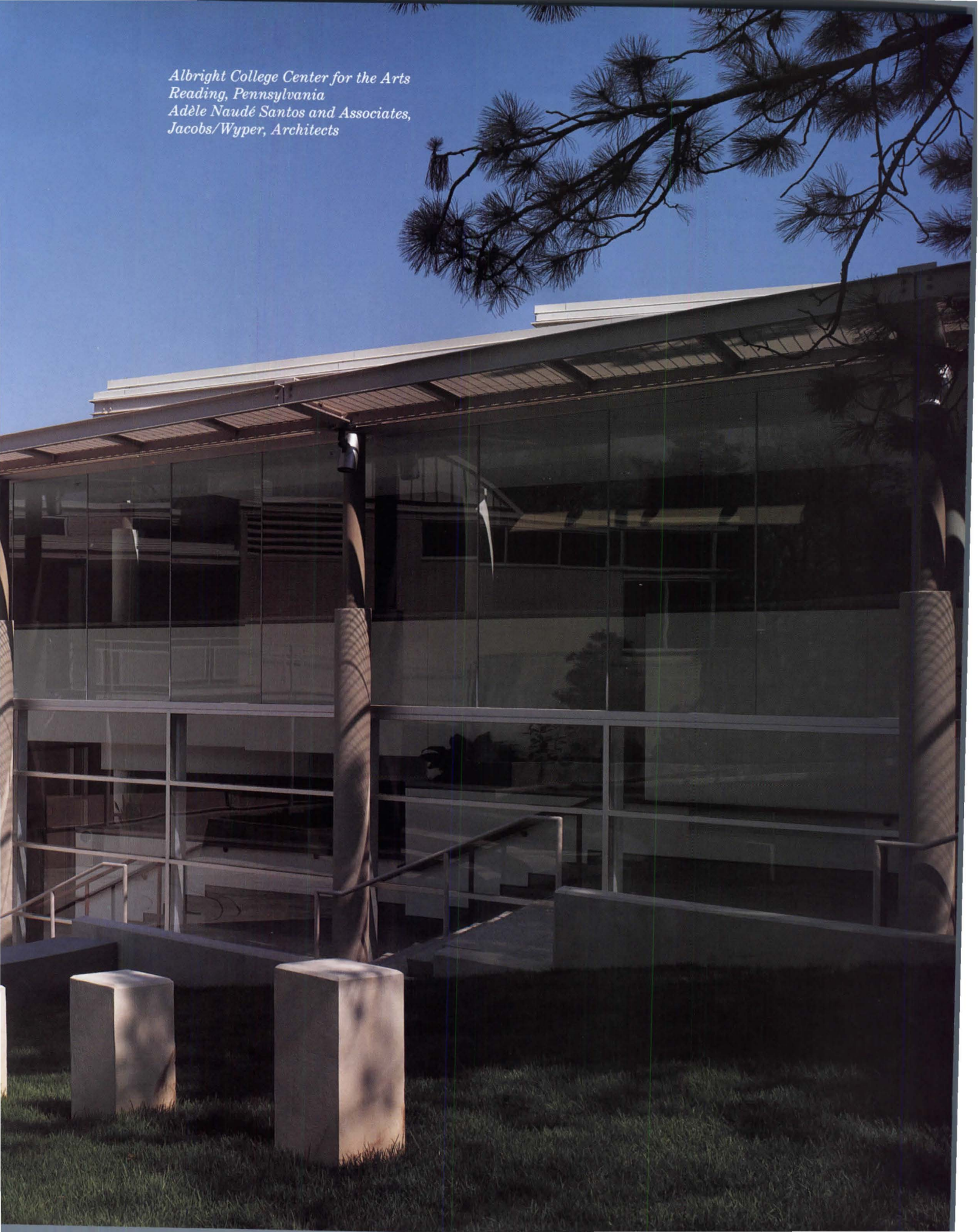

Like an automobile's clutch, the Albright College Center for the Arts in Reading, Pennsylvania, is one of those parts that makes everything else work together. Inserted into a campus whose post-World-War-II buildings didn't mesh with its earlier structures, and whose layout lacked definition for many of its outdoor spaces, the steel-frame, glass-and-masonry Center for the Arts brings a variety of architectural wheels into sync. Appropriately, the project's focal point is a hingelike structure that uses shifting circles to tie indoors with outdoors, upstairs with down, and old with new.

Although modest in size (just 35,100 square feet of new space and 13,000 square feet of renovated space), the facility has fast become a favorite meeting place for students. A multiuse complex, the center provides a high-profile home for the departments of theater, music, and art, as well as the college's Freedman Art Gallery. While larger schools can afford separate facilities for these departments, small colleges today are gathering these functions together in single buildings. (Both Tufts University and Middlebury College have similar multiuse arts centers opening this year, the former by CBT Architects and the latter by Hardy Holzman Pfeiffer Associates.) "The challenge we faced," explains Adèle Naudé Santos, "was giving identity to each of the major components while establishing a common character for the entire complex." The architects' solution was to give each department its own two-story structure and then tie them all together with a glass-and-steel bridge that curves around a courtyard designed in collaboration with the environmental artist Mary Miss. Depending on the needs of each department, the architects adjusted the ratio of glass to masonry for each component; the theater lobby, for example, has a mostly transparent facade, while the art studios boast north-facing light monitors and a higher degree of privacy. Instead of blending in with the red-brick architecture of the college's older buildings, the arts center stands out with gray brick set with mustard-hued mortar.

The pivot for the arts center is the two-story steel canopy. The canopy, a circular structure with an off-center metal basket suspended from the top, anchors the courtyard and continues Miss's environmental sculpture underneath and around it. While the artist's shifting metal plates and curving metal benches emerge from the earth, the canopy seems to hang from the sky. Like a pebble dropped into water, the canopy sends out waves of influence, establishing contact with the 19th-century Sherman Cottage at the edge of the courtyard and the rest of the campus. "Sculpture and architecture shouldn't be separate, but should work together," says Miss, who has collaborated with architects such as Tod Williams, Billie Tsien, Stan Eckstut, and Susanna Torre. "Adèle and I wanted to create something that would be a starting place, that would make lines out to other parts of campus," adds Miss.

Located just off the school's major through street, the Arts Center is a gateway to the campus, says Santos. To highlight this function on the project's western facade, the architects split the Freedman Gallery from the art department with an outdoor staircase and a passage to the courtyard. By offering a glimpse of the canopy and courtyard, the building draws people to its core. On the east, the center connects with the existing student center and an existing theater that has been renovated as part of the project. Walking through the building is one of its pleasures, whether one chooses the faceted glass-walled bridge or the covered passage underneath. A double staircase—half indoors and half outdoors—runs along either side of the theater lobby's glass curtain wall, blurring the separation between landscape and architecture. *Clifford A. Pearson*

Barry Halkin photos

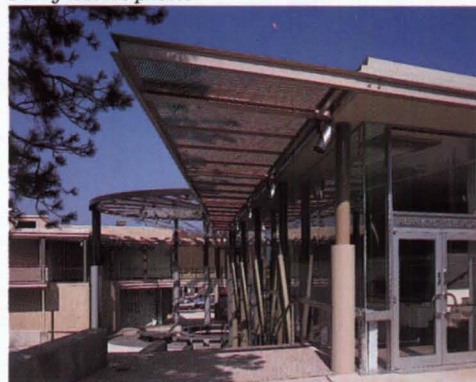

Set at an important crossroads, the arts center uses procession as a key theme in its design. Approached from the east (top), the complex connects on its second level with an existing student center. From the west, an outdoor stair takes visitors to the second-story bridge (above). To stay within a tight \$6.5-million budget, the architects designed simple steel-framed buildings with a few flourishes such as a steel canopy and glazed bridge. The bridge's faceted curtain wall (opposite) is butt-glazed and its joints are sealed with silicon. An environmental sculpture by Mary Miss includes shifting circles of metal plates set below grade, metal benches shaped like cogs, and an amphitheaterlike courtyard beyond (opposite).



MUSIC DEPARTMENT

ALBRIGHT THEATRE



SECOND FLOOR

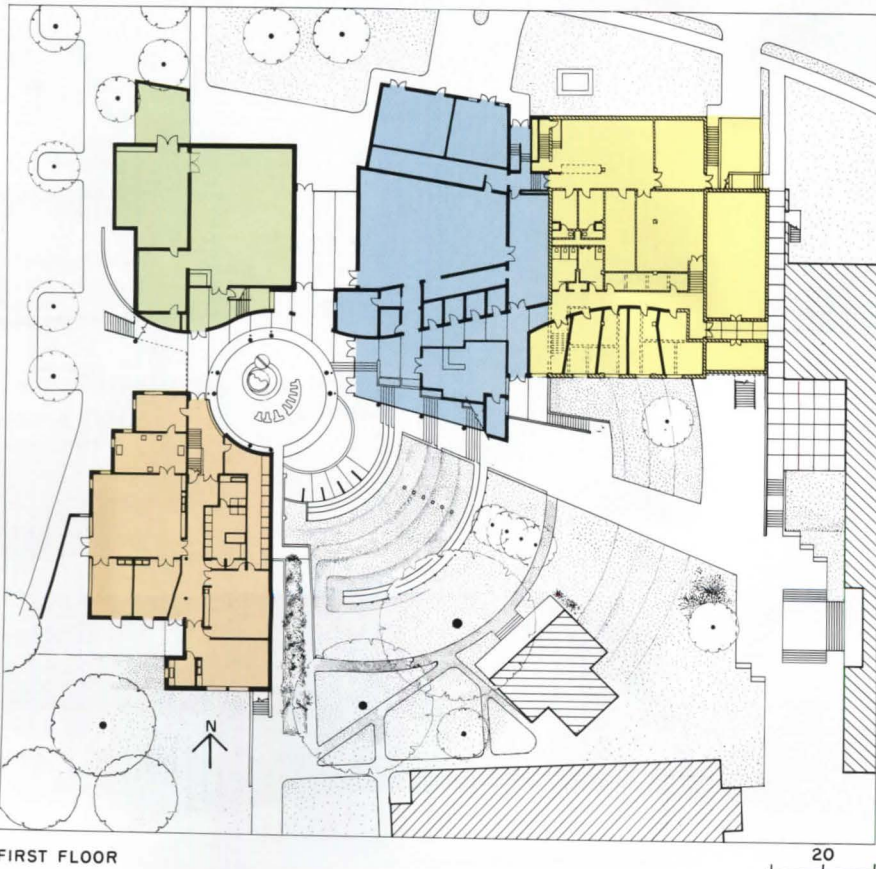

FIRST FLOOR

- RENOVATED THEATER
- NEW DRAMA AND MUSIC FACILITIES
- FREEDMAN ART GALLERY
- ART DEPARTMENT

The arts center comprises three new components—homes for the art department, music department, and the Freedman Art Gallery—as well as renovation of two existing theaters and some offices (plans left). The complex is linked to the existing student center to the east and recognizes the presence of the old Sherman Cottage to the south. The hinge around which the entire project turns is the outdoor canopy and environmental sculpture (1 and 3 opposite). Colorful elements such as a curving ochre wall (3) enliven an inexpensive material such as stucco. The center's curtain-walled theater block (2) includes a generous lobby (4) with a handicap ramp tucked behind a low wall (rear of 4).

Credits

Albright College

Center for the Arts

Reading, Pennsylvania

Owner: *Albright College*

Architect: *Adèle Naudé Santos and Associates—Adèle Naudé Santos, Robert deJager, Joseph Iano, Bruce Prescott, project team*

Joint-Venture Architect:

Jacobs/Wyper, Architects

Engineers: *Nick Kamaroitis*

(structural); Norihide

Imagawa, TIS and Partners

(canopy roof); Pennel and

Wiltberger (mechanical)

Consultants: *Mary Miss*

(environmental sculpture);

Professional Systems

Engineering (acoustics)

General Contractor: *Beihn*

Construction (building); E. A.

Reider Construction

(environmental sculpture)

Manufacturer Sources:

See Contents page



1



2



3



4

For Art's Sake

*Lynn Goode Gallery
Houston, Texas
Carlos Jimenez
Architectural Design Studio*





Distinguished by trees, color, and natural light, the Lynn Goode Gallery is one of several art galleries to have opened in Houston along the southern edge of a postwar residential district (above). Although deed restrictions protecting the area's character do not include the side of the street where the galleries are located, small lot sizes and mature trees ensure that new construction is in keeping with the neighborhood's low scale. The galleries form a buffer between houses to the north and a commercial district to the south, which extends several blocks to the Southwest Freeway (site plan).

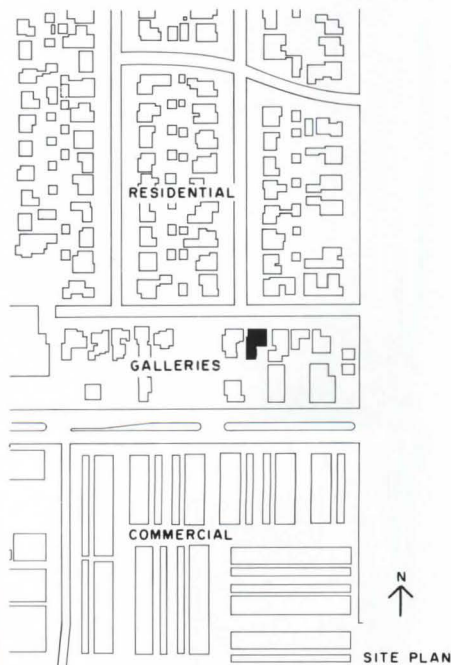

The advent of zoning in Houston may soon preclude the formation of the kind of mixed-use area that gives the Lynn Goode Gallery by Carlos Jimenez its special character.

Within the past few years, several art galleries have built space or moved into buildings on the southern edge of a neighborhood of 1950s tract houses and mature oaks. Occupying the same 50- by 100-foot lots as the houses, and keeping a one- or two-story scale, this low-keyed "gallery alley" enhances the area's residential repose. However, the exclusionist zoning now under consideration for Houston would require commercial uses, including galleries, to be buffered away from the neighborhoods, despite the fact that mild-mannered commercial activity need not clash with residential uses.

The Lynn Goode Gallery's buildable area was set in part by three magnificent live oaks. In addition to dominating the site and defining an L-shaped envelope, the trees fixed the location of the facade and the size of a sculpture court. Jimenez aligned the gallery facade with other buildings along the street, and linked the entrance to the sculpture court with an off-center axis running the north-south length of the building. Three zones of functions are arranged on each side of this axis: galleries mostly to the east, and administration and storage to the west. All the display spaces are positioned to receive north light through large windows shaded by the two street trees.

The simple building block conceals a surprising variety of exhibition spaces and interior perspectives. The main gallery is a two-story space that leaks off into a low, partitioned area facing the street. Two galleries upstairs are discrete rooms. The central axis itself is a linear gallery, terminating in a bowed hall oriented to the sculpture court. Landings off the central stair provide views of the exhibits.

Although Jimenez describes these simple forms as containers for art, the experience of visiting the gallery is not that simple. Again, it's the trees; they are always visible. Their shade permits larger window openings, normally taboo in art establishments, which mostly face north. The rooms are washed in natural light that changes in intensity and tone throughout the day. The light's color, filtered through the trees, also changes by the season as the leaves sprout, mature, and thicken (yes, live oaks change their leaves annually). Artificial light is kept to a minimum, mainly to balance color and for the occasional nighttime event.

The subtleties of light, the constant presence of nature, and the clear spatial arrangements are in pleasant balance. This is architecture that maintains its presence without competing with the art being shown. The only thing not reticent or subtle is the gallery's hot mango exterior. Contrasting with the deep green of the trees, the intense monotone is Jimenez's one visceral response in an otherwise rationalist project. The clear color reinforces the plastic quality of taut stucco skin and simple shapes. Shafts of light through leaves or fence boards cast dappled patterns on the grainy surface.

Many art galleries are neutral to an extreme, leaving hollow, characterless shells. For this project, Jimenez has instilled a modest work with architecture's most elemental qualities: flowing space, natural light, and responsiveness to nature. *Gerald Moorhead*



An off-center entrance bay (top left and opposite) announces the gallery's central axis, which ends in a small bowed gallery hall (bottom left) and rear sculpture court. To protect the oaks' shallow roots, the gallery's columns are non-loadbearing and the second floor is cantilevered, which allows the grade beam under the columns to be of minimal depth. The city permitted a variance to reduce off-street parking requirements, reducing the amount of paving over the tree roots.

Planes pulled back from the stucco skin are covered with standing-seam metal siding, a cool backdrop to the hot color of the stucco. An economical wood framing system is sheathed inside and out with plywood. The inner layer permits the gallery to hang large art works over gypsum-board walls.

As Jimenez's preliminary sketch shows (below), the three oaks helped determine the gallery's L-shaped plan, which is organized around a core stair and central axis.

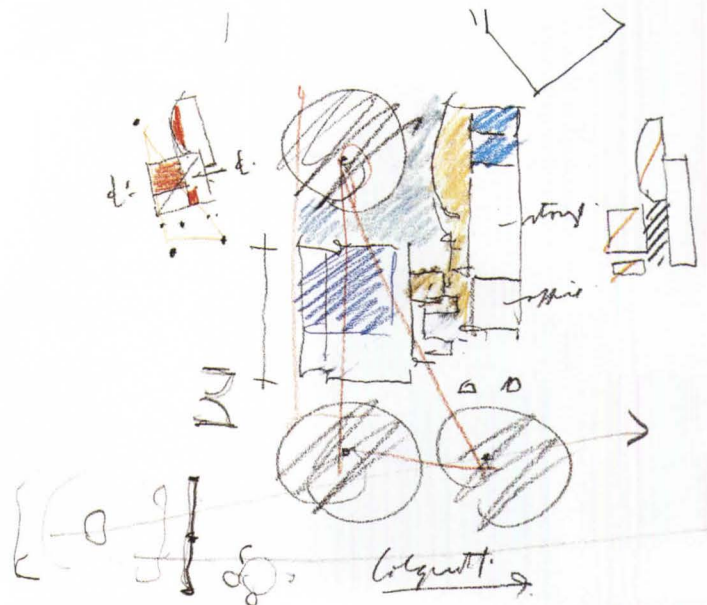



LYNN GOODE GALLERY
2710



Windows framing vistas through tree limbs appear as large pictures on the wall (left). Since the trees offer year-round shade, single-pane clear glass windows pose no air-conditioning problem. The hvac system has been oversized, however, to accommodate the occasional demands of an opening-night crowd.

While the exterior is frontal and formal, interiors combine axial alignments and picturesque diagonal vistas. Landings on the spiraling stair are good points for viewing large works (top left opposite). From the two-story entry (top right opposite), the axis extends to the back and ends in a bowed gallery (bottom right opposite).



- | | |
|-----------------|--------------|
| 1. Parking | 5. Reception |
| 2. Entrance | 6. Office |
| 3. Main gallery | 7. Storage |
| 4. Gallery | 8. Courtyard |

Credits

*Lynn Goode Gallery
Houston, Texas*

Architect: Carlos Jimenez
*Architectural Design Studio—
Carlos Jimenez, designer;
Dominique Brousseau,
assistant*

Engineer: Jon Monteith/
*Structural Consulting
Company*

Consultants: Carlton Cook
*Company (cabinetry);
Richard Dryer (lighting)*

General Contractors:
Joe Larrow/E. J. Brann

Manufacturer Sources:
See Contents page



Manhattan Mosque

*An Islamic cultural center
uses modern technology
to express ancient traditions.*





*Islamic Cultural Center
of New York
Skidmore, Owings & Merrill
(New York), Architects
Swanke Hayden Connell
Architects (minaret)*

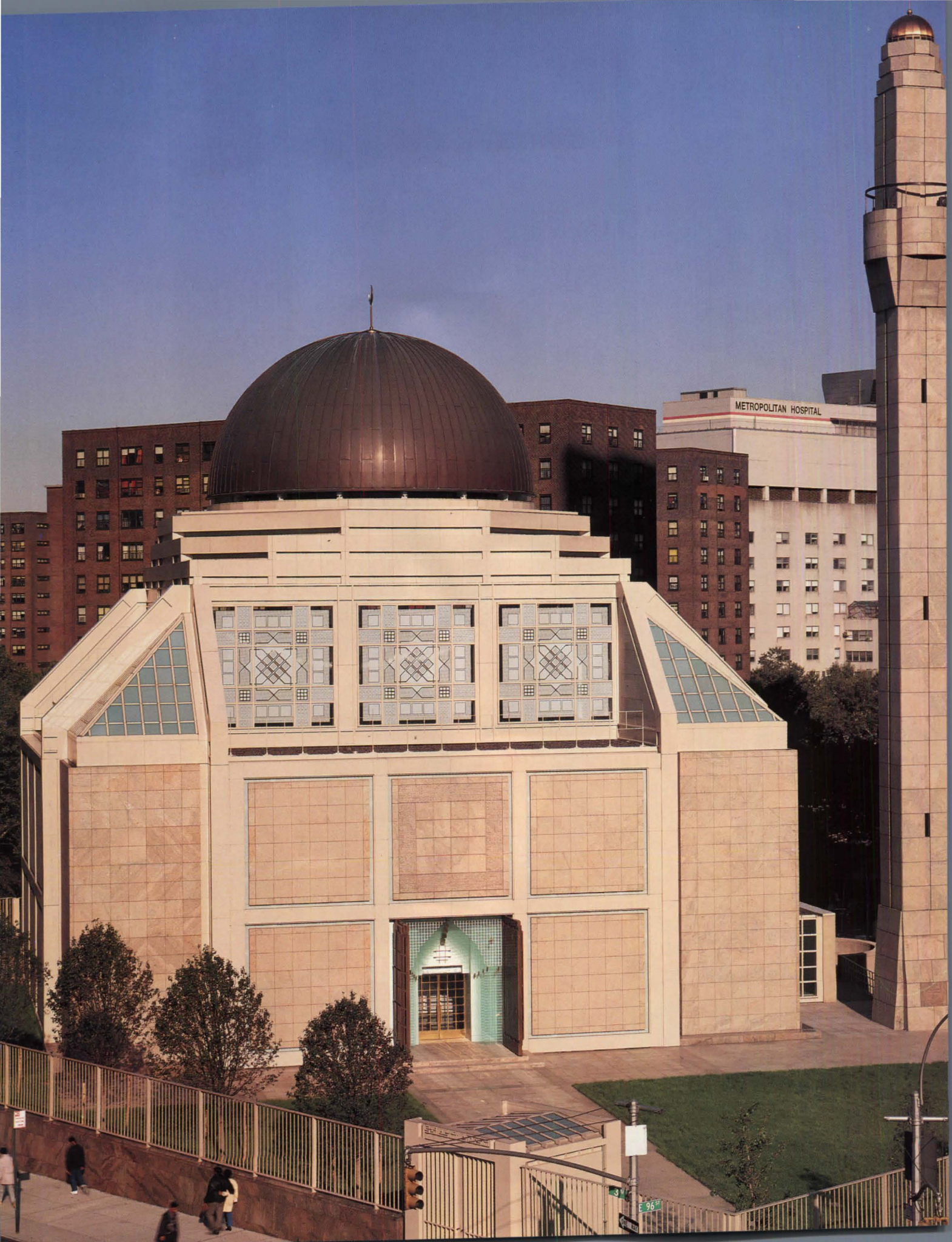

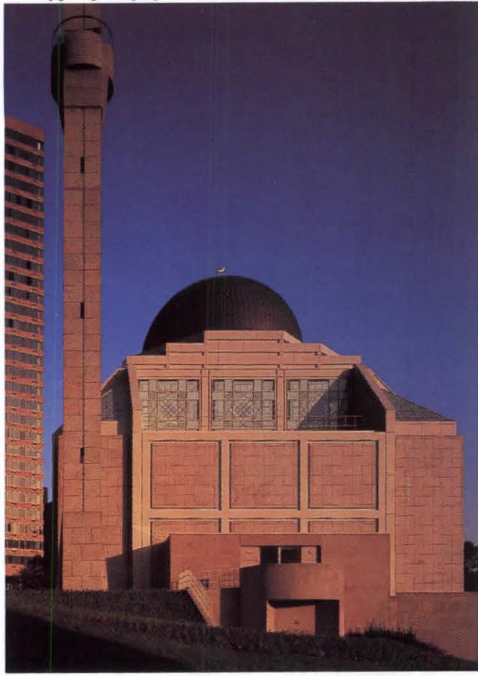

The mosque is placed at 29 degrees off the Manhattan street grid to face along the shortest route to Mecca, creating a big open forecourt where worshippers traditionally gather before prayers (opposite). The non-loadbearing outside wall panels are of pink Stony Creek granite bordered by thin strips of glass. Major openings comprise glass patterned with fired-ceramic surface decorations. The copper-clad dome is topped by a gilded crescent pointing to Mecca. A 1-ft-high strip of glass separates dome from wall and admits natural light to the prayer hall.

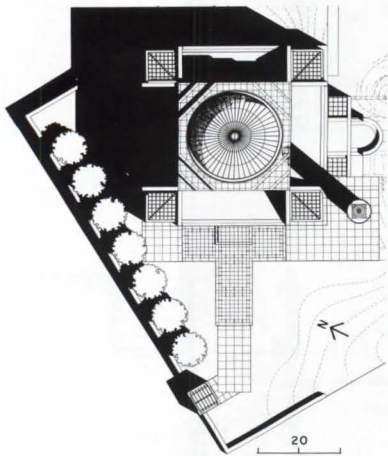

Every Friday at 1 P.M. the muezzin summons the faithful to prayer. But instead of Cairo's ancient mosque of Ibn Tulun or the elegant Shezad mosque in Istanbul, the voice comes from the top of a 130-foot minaret at the intersection of Third Avenue and 96th Street in Manhattan, where it competes with the sound of buses, the scream of fire engines, and the noise of jets approaching La Guardia airport.

It's the site of the new Islamic Cultural Center, built for the Islamic community of greater New York—diplomats at the United Nations and the other faithful not served by the storefront mosques throughout New York's five boroughs. Despite its place and time at the threshold of the 21st century, the building, its siting, configuration, materials, and finishes honor a tradition started over 1,370 years ago in a simple, partly roofed mosque of brick and stone built at Medina by the prophet Mohammed.

The physical requirements actually demanded by Islamic theology are few. Chiefly, the *mihrab*, or altar niche, must face, not east necessarily, but along the shortest route to the Kaaba shrine at Mecca—a directional concept known in Arabic as *qiblah*. Second, natural forms of any kind are forbidden as ornament. Once these demands are met, Islamic architecture is largely the outcome of traditions that emerged over the centuries of Islam's expansion since the 632 A.D. death of Mohammed, east to Indonesia and west to Spain, and now to the new world. Dictated by available materials and the skills of local craftsmen, these traditions came to comprise simple geometric arrangements of walls, finishes, and ornament, a certain directness of approach to plan and elevation, the separation of prayer into a pre-prayer outdoor space and a ceremonial enclosed prayer hall, greater complexity inside than out, and separate space for men and women. Certain features and details, such as the horseshoe arch, which many perceive as typically "Islamic," have been adopted quite literally in much of new Islamic architecture, not always to critical acclaim.

This was the backdrop facing SOM design partner Michael McCarthy as he set about designing the new cultural center, which now consists of a mosque and social space and is to include, as mosques have through the ages, classrooms and a library. As it happens, McCarthy was advised throughout the planning process by two committees with conflicting viewpoints. One group urged on him virtually total freedom in the use of forms and motifs, consistent with general respect for Islamic beliefs and architectural tradition. The second group sought literal versions of historic motifs. McCarthy chose to follow the first path. He justified this decision by pointing out that Islam, in its vast conquests, absorbed the best of local building techniques and materials under an overall umbrella of a careful geometric ordering of mass, enclosure, and finishes. Why not meld this tradition with the best that late 20th-century technology has to offer? The result includes a 90-foot clear-span interior made up of a grid of four trusses supporting a steel and concrete dome above and suspending a women's gallery beneath; an outside screen wall of light granite panels each outlined by a strip of glass and supported by a concealed grid of tubular steel; a modern adaptation of *Kufic*, a form of Arabic calligraphy used here as ornament over the main entry portal, the *mihrab* and at the apex of the dome; and a modern circle of steel wire-supported lamps, a motif dating to the circles of oil lamps at Ibn Tulun and elsewhere.

Above all, the architects captured the unaffectedness that marks most periods and places of Islamic architecture, a kind of directness that is also the mark of this latest descendant. *Stephen A. Kliment*



The 15-ft-high main entrance portal seen from inside (above) shows layers of glass cut in steps to evoke the traditional stalactite arch. The building is on two levels: the prayer hall (with the women's gallery suspended by rods from trusses), and a lower level consisting of a social hall and sumptuously appointed ablution facilities for men and women. The mihrab, or altar niche (opposite) faces Mecca, and is bordered by a frieze consisting of verses from the Koran in modern Kufic, a form of Islamic calligraphy. To the right of the mihrab is the mimbar. From its summit the imam delivers his sermon. A grid of four trusses creates a two-way tabletop supporting the domed roof above and the

women's gallery below. The central sections of each truss are Vierendeel panels that create clerestory windows admitting light to the prayer hall. The exterior wall is divided into granite panels floating within a prefabricated welded grid of steel tube shapes. The dome (overleaf) consists of 16 radial curved steel ribs whose interstices are filled with 4-in. precast-concrete panels, like segments of orange peel. Hvac is a 28,000 cfm low-pressure, constant-volume, air-cooled direct expansion system. Carpet, suspended lights, and wall geometry combine to provide human scale in the 90-ft-high space. Women's gallery is at left of photo on page 97.

- | | |
|---------------------------|----------------------|
| 1. Mihrab | 6. Men's toilets |
| 2. Mimbar | 7. Men's ablutions |
| 3. Prayer hall | 8. Women's ablutions |
| 4. Shoe storage | 9. Women's toilets |
| 5. Women's gallery (over) | |

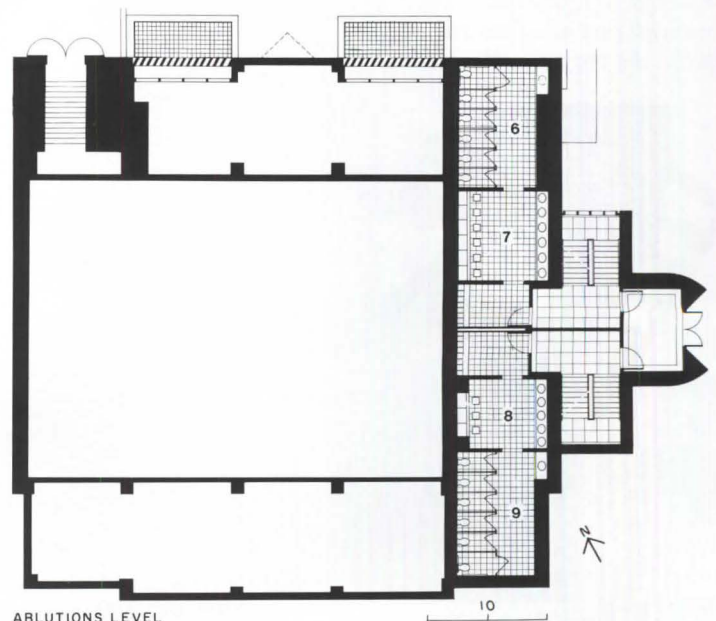
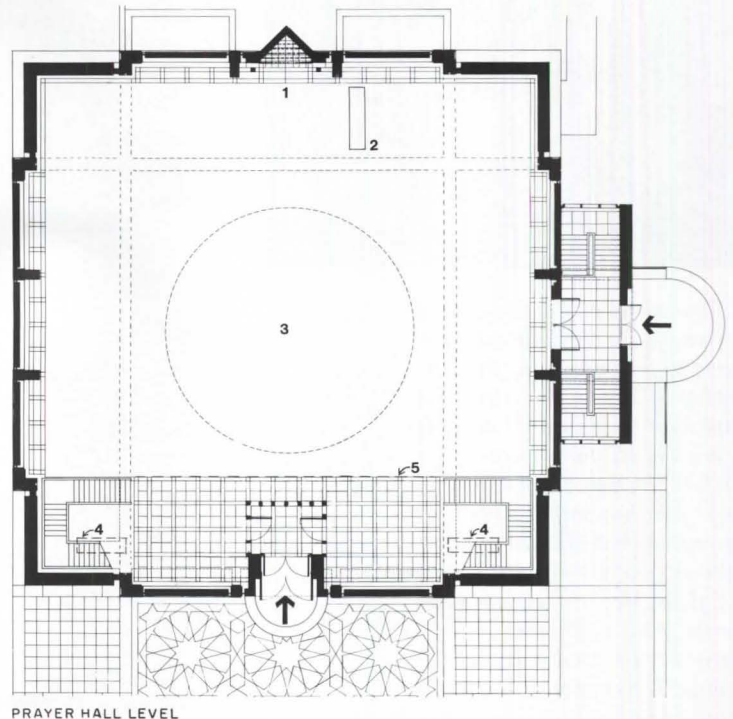

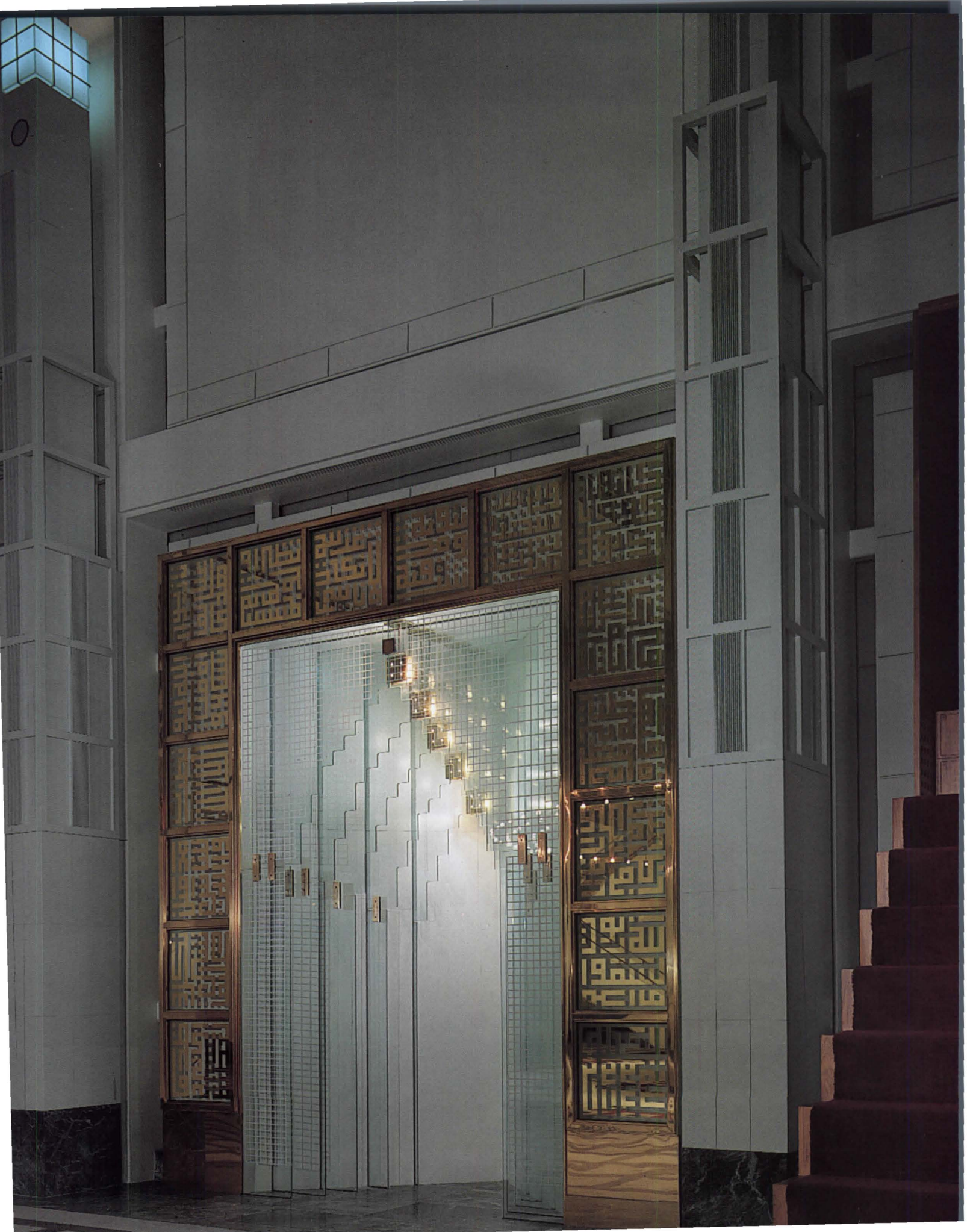

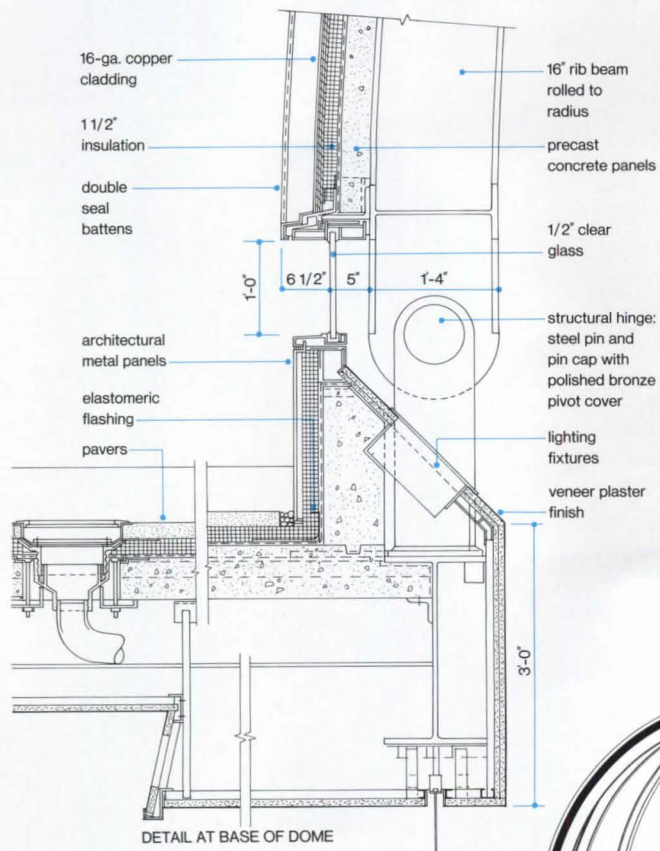

Credits

The Islamic Cultural Center, New York City
Owner: *The Islamic Cultural Center of New York, Religious Trust (His Excellency Mohammad Abulhassan, board chairman; Ziad Monayair, representative of the chairman)*

Architects: *Skidmore, Owings & Merrill (New York)—Michael McCarthy, design partner; John Winkler, administrative partner; Michael Keselica, project manager; Mustafa K. Abadan, senior designer*

Architects for minaret: *Swanke Hayden Connell*
Consultants: *Richard Rowe, structural engineer; Davis Allen, interior designer; Scott McIntyre, landscape/civil engineer (all SOM); Jaros, Baum & Bolles, mechanical/electrical engineers; Jules Fisher & Paul Marantz, Inc., lighting; Manuel Keene, calligraphy; Cerami and Associates, acoustical*

General Contractor: *Koren-Di Resta Construction Co., Inc.*

Manufacturer Sources:
See Contents page

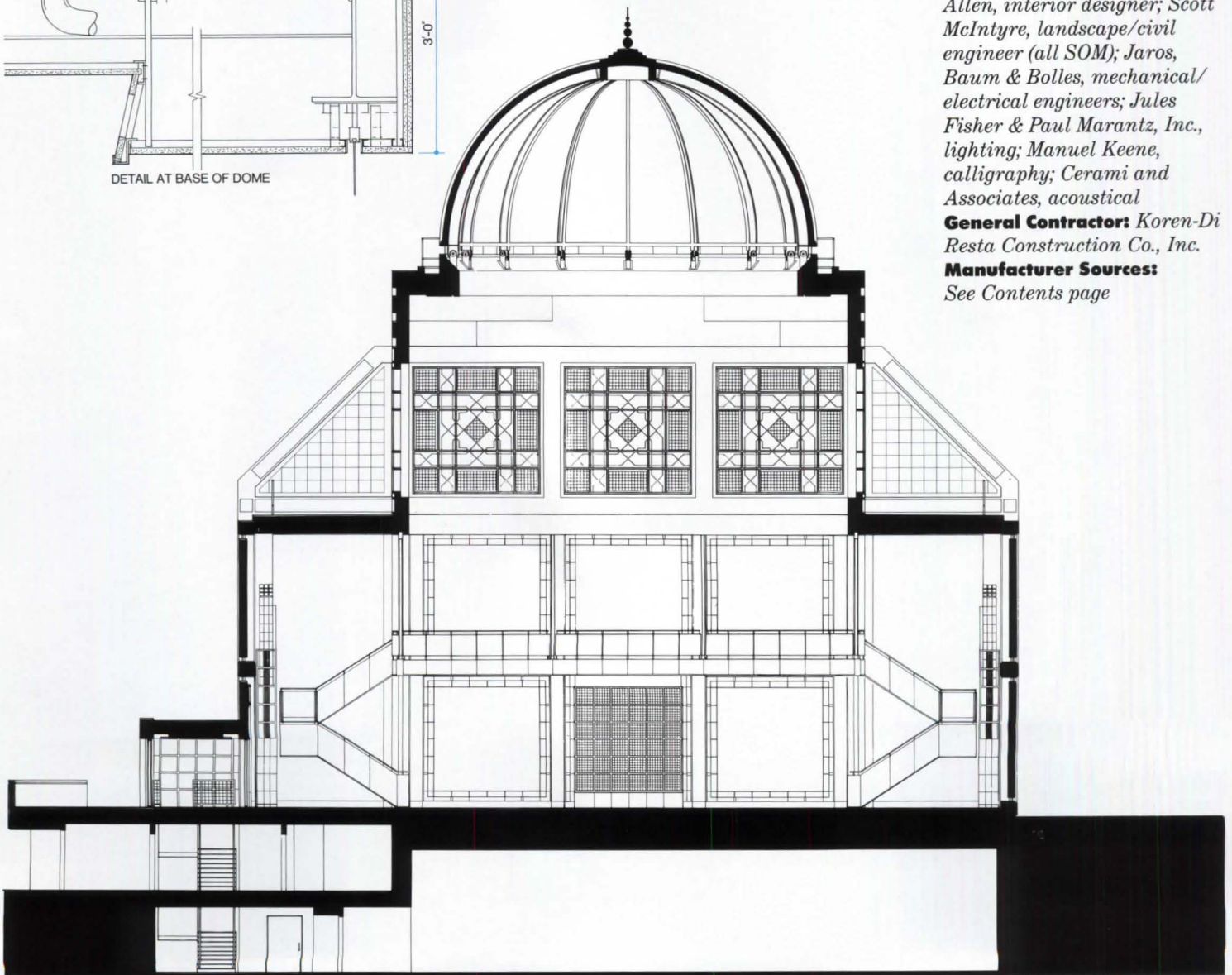



Spain's Year: Barcelona and Seville

To mount an Olympic games and a universal exposition in the same year is a form of brinksmanship for any country. Each is an enormous treasury-draining undertaking fraught with the danger of world-scale embarrassment should glitches develop. For Spain, though, the risk seemed justified: 1992 not only is the 500th anniversary of Columbus's voyages to the Americas, it is the year of economic unification in Europe. It has turned out to be a year when East-West cold-war concerns gave way to developed- versus developing-world issues.

Spain's position in the European community is in some ways analagous, since it has historically been considered part of the continent's poorer southern flank. With its enormous commitment to the Olym-

© Richard Bryant/ARCAID



Montjuïc Olympic sites, Barcelona

pics and to Expo '92, however, Spain has asserted its technological, organizational, and cultural parity with northern Europe, and has presented definitive evidence—if the world needed it—that the country has thrown off the straitjacket of Francoism.

The chief legacy of this brave leap is the bold and dazzling remaking of two of Spain's most important cities. RECORD presents on the following pages only a sampling of the Olympics architecture, the Expo pavilions, and the restructured cities. Spain's effort also raises a question for the U. S. At what cost do we continue to ignore *our* urban infrastructure and its design potential? Finally, there is a question for Atlanta, home of the 1996 Olympics: can you top this?
James S. Russell and Karen D. Stein

© van der Vlugt & Claus



Expo '92 site, Seville

Building Barcelona

Olympic Fever grips Barcelona. Spain's second largest city, with a metropolitan area population of three million, Mediterranean port, and capital of the province of Catalonia, Barcelona has used the Olympics as a springboard for international self-promotion and internal reform, all vigorously directed by Mayor Pasqual Maragall (for a profile on the Mayor, see pages 112-113). The Games are a glittering showcase for the city's architectural talents; at the same time, they have stimulated over \$8 billion in public and private investment, more than half in public funds. It's a capitalist "Great Leap Forward" designed to position the city for the heavy competition of the European Economic Community.

To an ambitious program of urban improvements launched in 1980, the Olympics have added a coastal/inland urban highway ring, an airport expansion by Ricardo Bofill, a \$500-million telecommunications network crowned by Norman Foster's 875-foot-high Collserola Tower, four city Olympic competition areas, and the Olympic Village, a new seaside residential district linked to major improvements in the city's infrastructure and waterfront.

The heart of the Games is the Olympic Ring (pages 102-105), site of the Olympic Stadium and other facilities, which is situated on Montjuïc, a tree-covered acropolis that overlooks the Mediterranean. The Diagonal area to the west makes use of existing soccer stadiums and polo fields near the University of Barcelona. To the north, against the mountains that girdle the city, the Vall d'Hebron area contains a Press Village and competition areas for tennis, cycling, archery, volleyball, and jai alai. Finally, the Olympic Village (pages 106-109) houses 15,000 athletes in 2,000 apartments, and hosts the sailing competitions from its port. Other Olympic events are scattered about the city and in 15 neighboring towns (pages 110-111). The nearby industrial suburb of Badalona sponsors the basketball competition, while some of the soccer games take place as far away as Tarragona and Zaragoza. A long list of other projects inspired by the Olympic rendezvous has been delayed in the rush of work: Gae Aulenti's Museum of Catalan Art, Richard Meier's Museum of Contemporary Art, a Rafael Moneo concert hall, a Meteorological Center by Alvaro Siza for the Olympic Port, hotels, and more.

The cost of the Olympic effort has been high. Expenses have exceeded original 1985 estimates of \$2.37 billion (at current rates of exchange) by more than 300 percent. Not only has the scope of work increased, virtually every project has come in over budget. Arata Isozaki's Sant Jordi Sports Palace on Montjuïc is one of the worst offenders; using technology new to Spain and built over sloping fill, it cost \$89 million after an initial budget of \$30 million. The highway cost about \$1.5 billion, instead of \$1 billion and the Olympic Village went from \$1.4 to over \$2 billion.

The scale of work has taxed local construction capacity. Many projects were built on round-the-clock shifts to meet deadlines. Shortages in specialized trades and the threat of paralyzing work stoppages combined with spiraling price increases and quality-control problems. To make matters worse, a post-Olympic building recession is already on hand, with builders scrambling for scarce contracts and architects facing empty drawing boards. The frenetic activity the Olympics inspired cannot be understood without reference to Francisco Franco's dictatorship (which lasted from 1936 to his death in 1975) and the first municipal elections of 1979. The frustration provoked by the suppression of political rights (and the local Catalan language) have been converted into enthusiasm—the feeling that, at long last, the future of Barcelona is in its own hands.

Architecture has key role

Architecture plays a key role in this scenario. Rarely in recent memory have works of architecture been so symbolically potent. In the housing blocks of the Olympic Village, the sight of so many of Barcelona's best architects at work for their city—some waited half a lifetime for the opportunity—is politically and emotionally charged. That's why the city's Socialist administration had to overcome resistance to its Olympic planning. The regional government of Catalonia is controlled by the *Convergència i Unió*, a rival political party of conservative Catalan nationalists, who delayed construction of the urban highway and blocked efforts to bring a subway line to the Olympic Ring.

Barcelona is a design-conscious city, with a sense of style closer in spirit to Milan than to Madrid. Its internationally known industrial and interior designers, such as Carlos Riart, Jorge Pensi, Oscar Tusquets, and its high-design boutiques and nightclubs reflect the city's industrial and mercantile economy and its large upper-middle-class of patrons and consumers. This background also explains the importance of cultural projects in initial Olympic plans. Recent additions to the city's stock of cultural facilities include the Tàpies Foundation, dedicated to artist Antoni Tàpies's work, which has been installed by architects Lluís Domènech and Roser Amadó in a 19th-century building by *modernista* architect Lluís Domènech i Montaner; and Oscar Tusquets's addition to Domènech i Montaner's flamboyant Palau de la Música Catalana concert hall.

The Olympic Village is a good introduction to the city's architects, a group closely linked with the Barcelona School of Architecture. The housing commissions were awarded to past winners of the local FAD (*Foment de les Arts Decoratives*) architecture prizes, spanning three generations. The more established architects were given oceanfront sites, while others worked in the blocks behind. Oriol Bohigas, 67, with his firm MBM, is responsible for the Village mas-

Barcelona has used the Olympics as a springboard for international self-promotion and internal reform.

ter plan, as well as most of its parks, and the Olympic Port and its first block of seafront housing.

Federico Correa, who works with Alfonso Milà, is of the same generation as Bohigas. His seafront housing adjacent to MBM's is better than his team's master plan of the Olympic Ring. The Olympic Village also contains housing by Tusquets (with Carlos Diaz) and Lluís Clotet (with Ignacio Paricio), both 51. They lead a generation that became active in the late 1960s, marking a passage through the tumultuous '70s to a restrained, eclectic Postmodernism in the 1980s.

Bofill also first appeared in the late 1960s, but his international stature has distanced him from local architects, as the location of his housing at the rear of the Olympic Village suggests. The central government in Madrid and the regional Catalan authorities are his principal patrons: a Physical Education Institute on Montjuïc, the airport, and the upcoming National Theater of Catalonia.

Another group of architects, born at the same time, has only emerged into public view with the commissions of the new democracy. The teams of Esteve Bonell/Francesc Rius and Elias Torres/José Antonio Martínez Lapeña occupy the last seafront sites, with housing by the more controversial duo of Albert Viaplana and Helio Piñón behind them. Josep Llinàs, Jordi Garcés and Enric Sória, and Jaume Bach/Gabriel Mora, designers of the nearby Telephone Exchange, are among several others who make up this group. They represent the best of Barcelona's current architectural renaissance, with an elegant, restrained, expressive Modernism.

Finally, a new generation is hard on the heels of their elders. Innocent of the sacrifices of the Franco era, these architects came of age in the pre-Olympic mood of expansion and optimism. Enric Miralles, 36, architect with Carme Pinós of the Vall d'Hebron Archery Range, has also contributed a dramatic sculptural arcade to the Avenue of Icària in the Olympic Village. Architect-engineer Santiago Calatrava, 41, a native of nearby Valencia, already rivals Bofill on the international scene. His expressive biomorphic forms recall the curving concrete vaults of Spanish engineer Felix Candela, who worked in exile in Mexico, continuing a formal tradition that also includes Barcelona's most famous architect, Antoni Gaudí. Calatrava sparked the major architectural scandal of the Olympics with the relatively late addition of his giant Communications Tower to Correa's master plan of the Olympic Ring. Backed by local politicians, the design was denounced by 58 public figures, with Bohigas and Correa heading the list—proof that Barcelona's Olympic fever is as much about architecture as good sportsmanship. *David Cohn*

David Cohn is a freelance writer based in Madrid.

- BELTWAY
- VALL D'HEBRON OLYMPIC AREA
- MONTJUÏC OLYMPIC RING
- DIAGONAL OLYMPIC AREA
- OLYMPIC VILLAGE

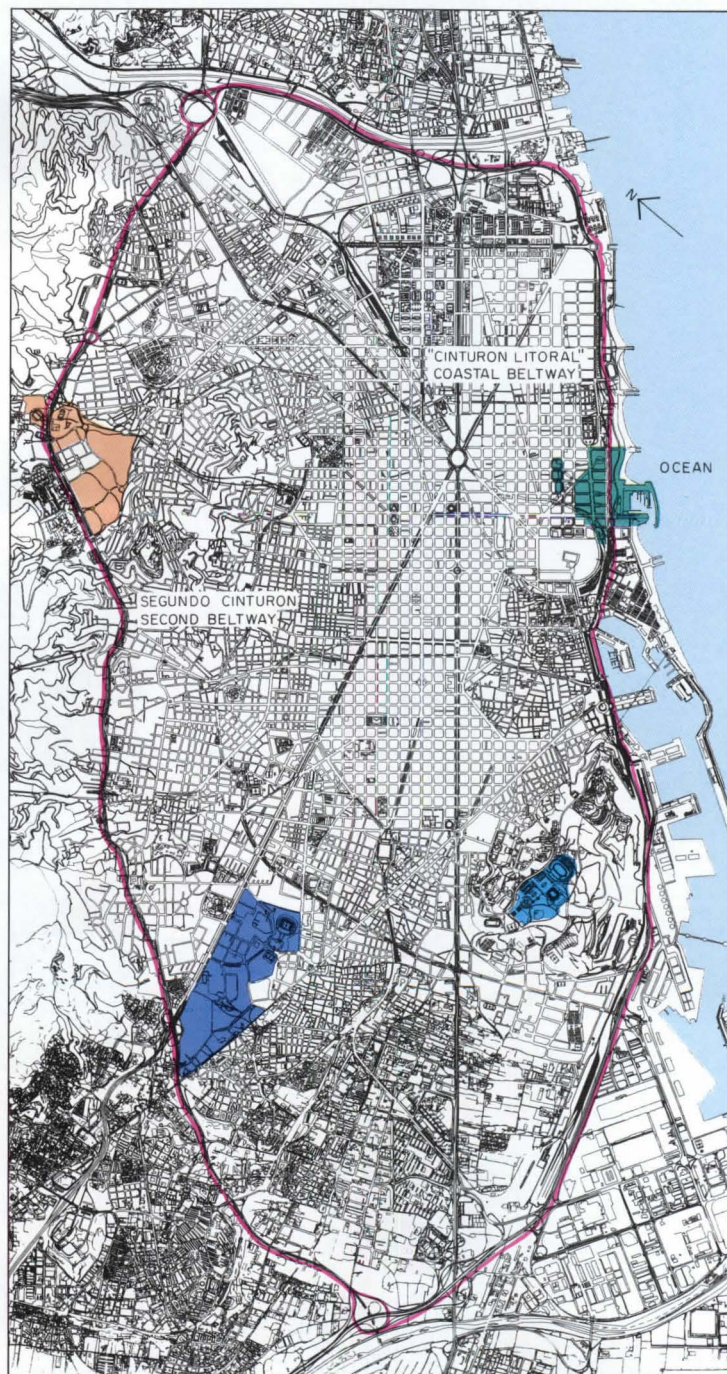

Olympic Ring

The Olympic Ring is on the summit of Montjuïc, behind the neoclassical pavilions of Barcelona's 1929 International Exposition, which climb the hill on axis. Its design was divided among several winners of a 1983 limited competition, the opposite of the tightly controlled Olympic Village designs. The results are, predictably, mixed. The complex is missing a clear sense of direc-

tion; Federico Correa and Alfonso Milà's team, authors of the general plan and central "Olympic Esplanade," lacked the authority to orchestrate the whole. The intentions of the Esplanade design itself seem muddled. The architects claim that their model was a suave modern classicism similar to New York City's Lincoln Center complex. Axial views across the space are given a degree of

closure by lines of illuminated light columns, scaled like smokestacks, although their rhythm is purposely broken by the descending levels of the plaza and at the forecourt of the Olympic Stadium. The other end of the Esplanade inexplicably turns its back on Ricardo Bofill's National Institute of Physical Education (2 in site plan), whose main entrance faces instead a lower

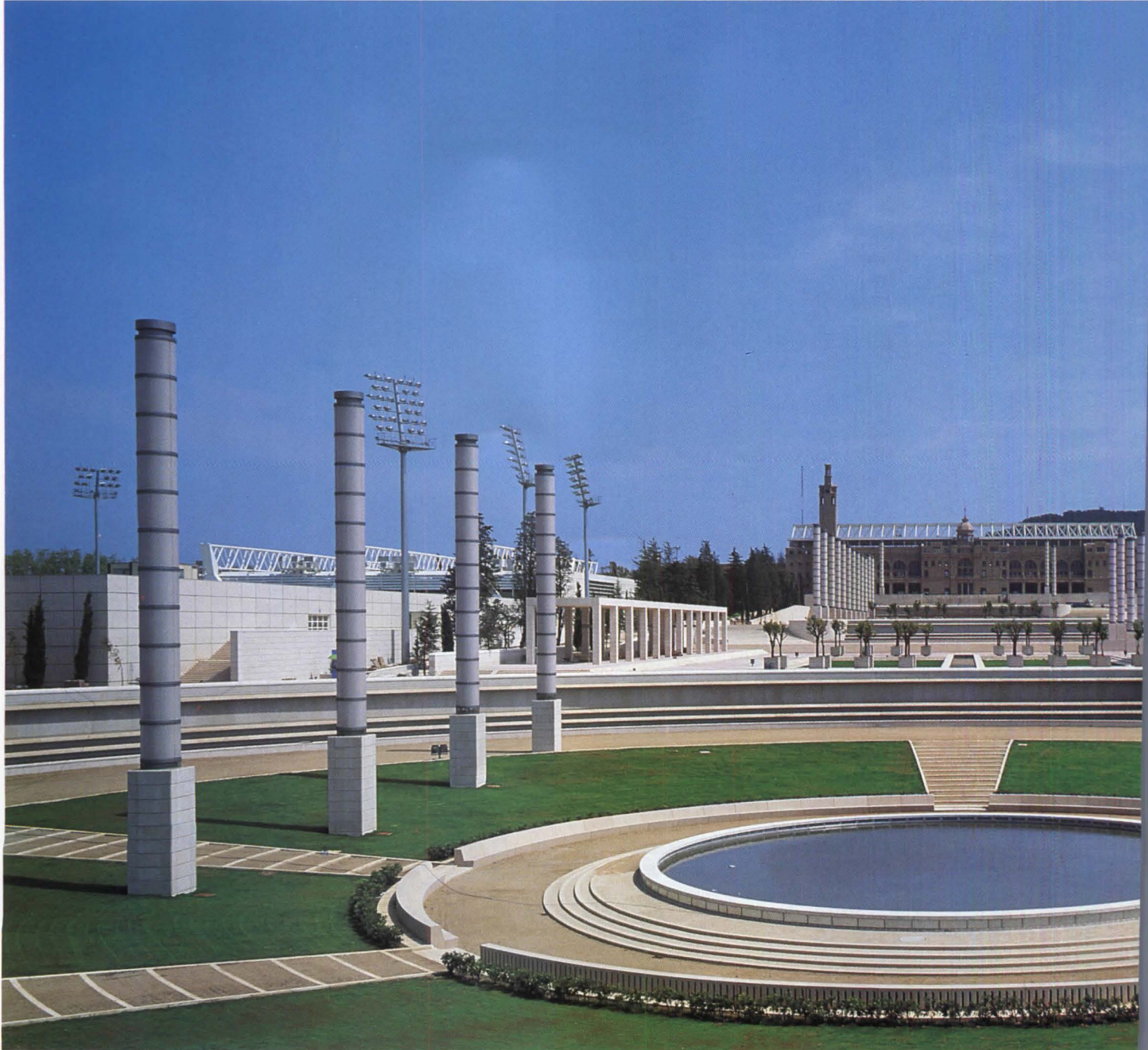

adjacent street. The Esplanade ends in a circular loggia over an underground cistern, which very nearly overlooks the roof of Bofill's building. The Olympic Stadium (1 in site plan) was originally built for the 1929 Exposition and Barcelona's bid for the 1936 Olympics. The Italian architect Vittorio Gregotti, working with the Correa-Milà team, was asked to increase the stadium's capacity

while preserving its Baroque tower and domed facade (below center). He lowered the playing field 36 feet, inserting new steeply raked stands in the stadium's shelltop (photos page 104). He also cantilevered a large canopy over the principal grandstand. Its large white truss, as seen from the Esplanade, curtly resolves the fussy details of the original facade in a single horizontal sweep.

Olympic Ring
Master plan by Federico Correa, Alfonso Milà, Carles Buxadé, and Joan Margarit



Studio Lluís Casals/Ferran Freixa photos

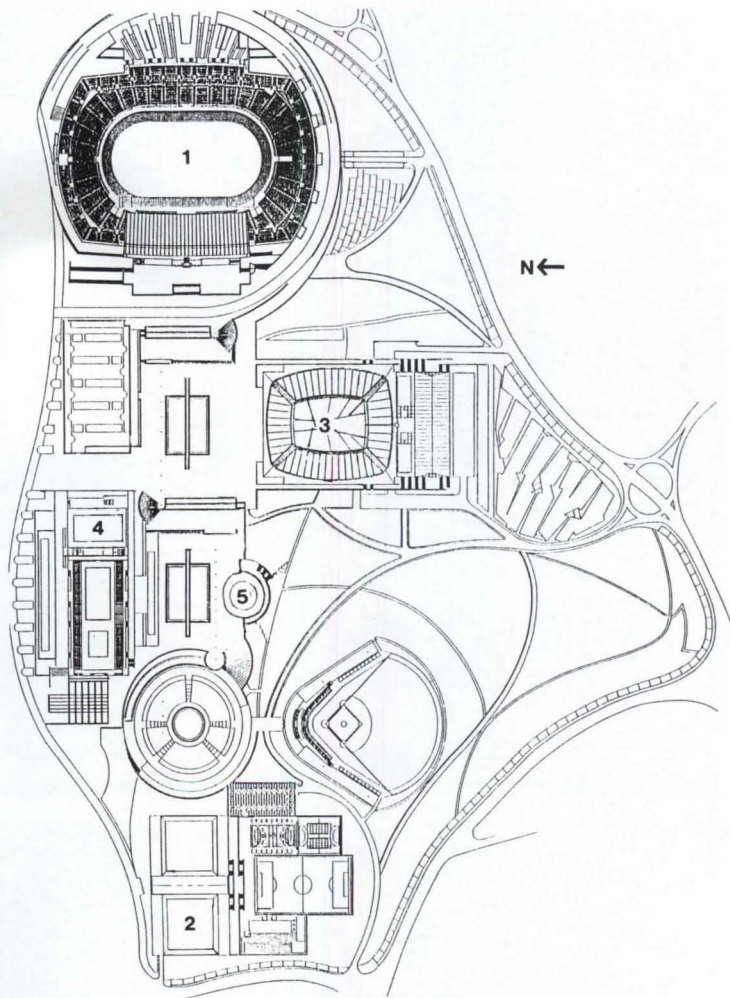

1. Olympic Stadium by Vittorio Gregotti & Associates
2. National Institute of Physical Education of Catalonia by Ricardo Bofill/Taller de Arquitectura
3. Sant Jordi Sports Palace by Arata Isozaki & Associates
4. Bernat Picornell Swimming Pools by Moisés Gallego and Francesc Fernández (not shown)
5. Telecommunications Tower by Santiago Calatrava

Arata Isozaki's multi-functional Sports Palace (3 in site plan on page 103) is the finest work in the complex. Its space-frame dome, the largest in Europe, was erected on the ground and jacked into position 140 feet above a 17,000 seat arena (opposite). The noisy forms and colors of some of Isozaki's American work is quieter here, in keeping with Spain's more structural ap-

proach to architecture, although his playfulness is evident in the lopsided shape of the dome (for acoustical reasons) and the undulating skirtlike roof of the surrounding lobby. The Physical Education Institute (bottom), which houses a press center and wrestling meets during the Games, is another Bofill essay in academic Classicism, executed in precast concrete with

an acid-etched stonelike finish, a technique Bofill developed in his French housing projects. The handsome, low-key reconstruction of the Bernat Picornell Swimming Pools (not shown), originally built for a 1972 Olympic bid, was designed by Moisés Gallego and Francesc Fernández. Finally, Santiago Calatrava's painted steel Communications Tower (5 in site plan on page 103 and far

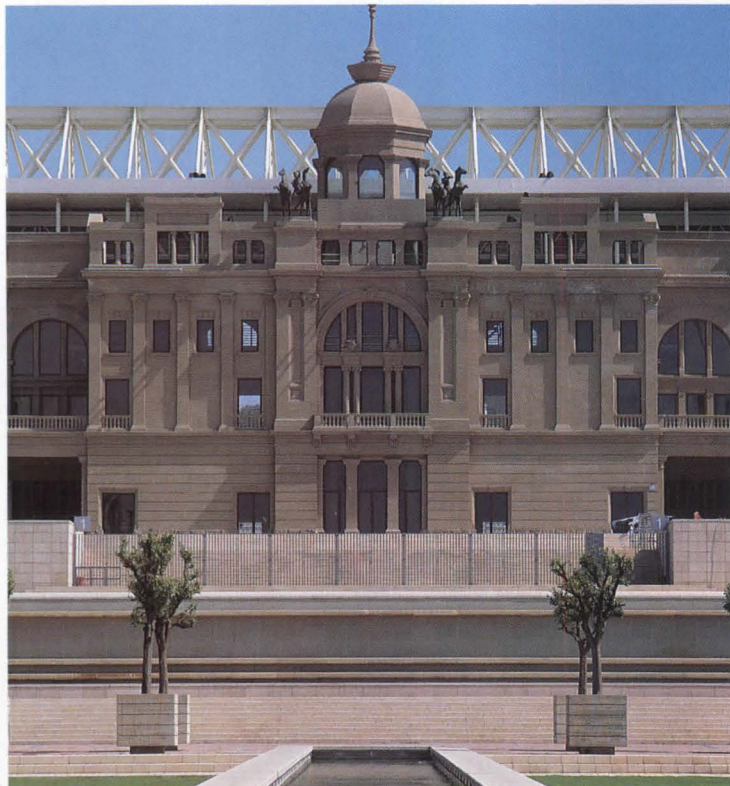

1



1a

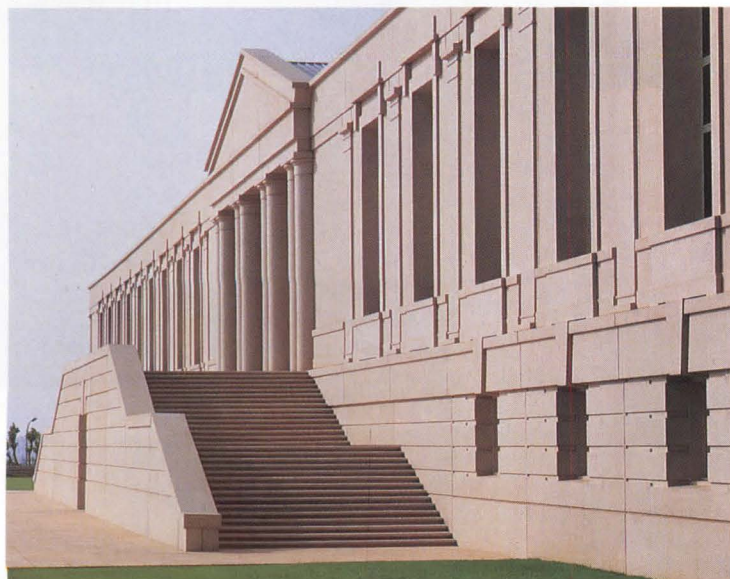

2

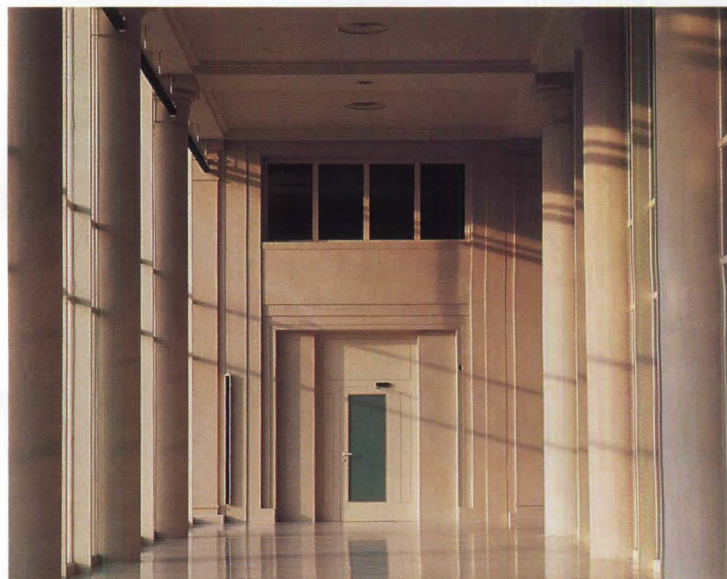

2a

right photo pages 102-103), a relay station for television and other transmissions, was added to the Ring program midway in 1988. The 386-foot spire, which tilts so as to double as a sundial, fills the sky from all angles. Seen from the city, it competes with the monumental 1929 axis up Montjuïc, rising brashly behind the summit of the hill.

1., 1a. Olympic Stadium by Vittorio Gregotti & Associates
2., 2a. National Institute of Physical Education of Catalonia by Ricardo Bofill/Taller d'Arquitectura
3., 3a., 3b. Sant Jordi Sports Palace by Arata Isozaki & Associates

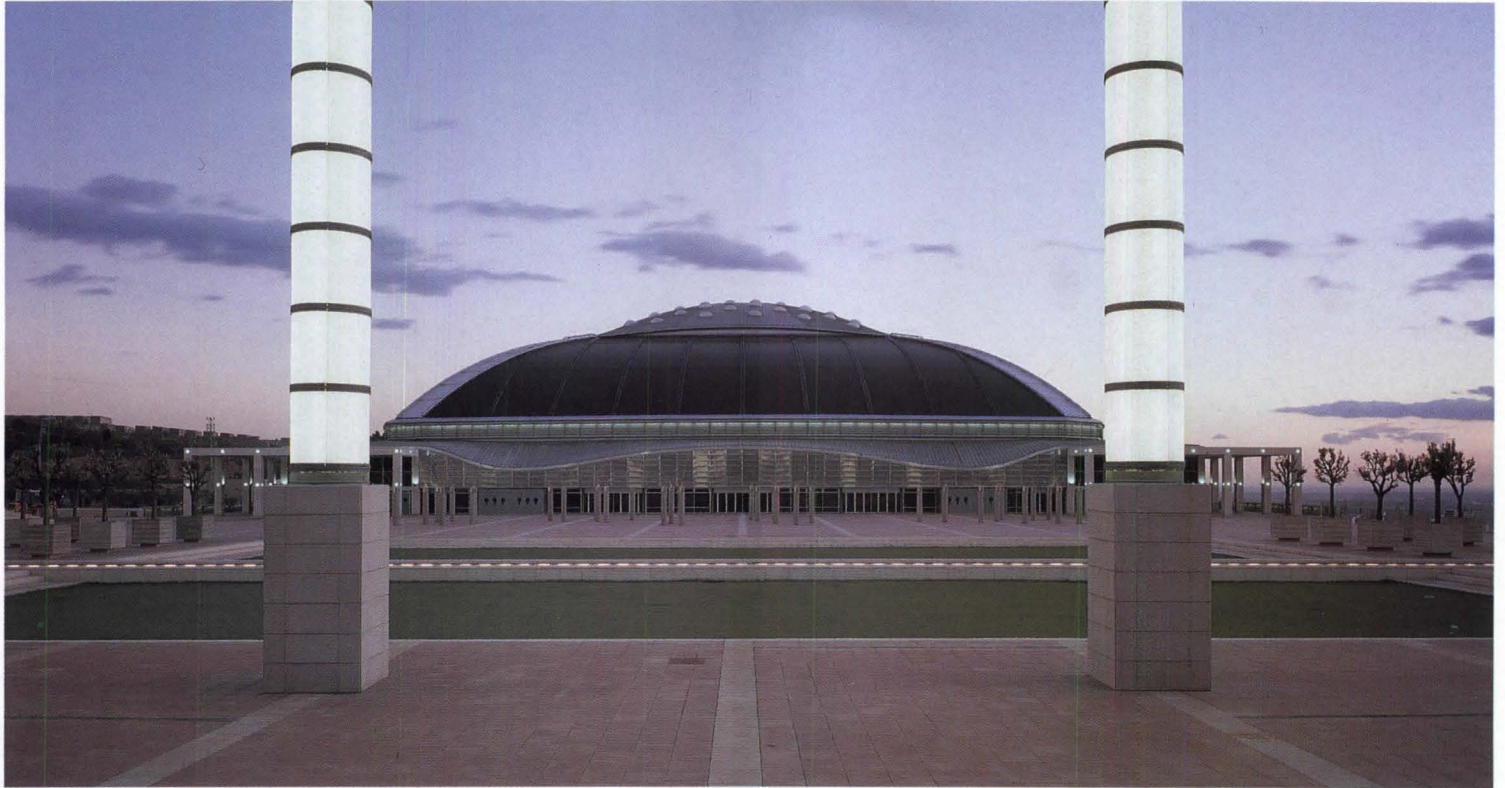

3



3a

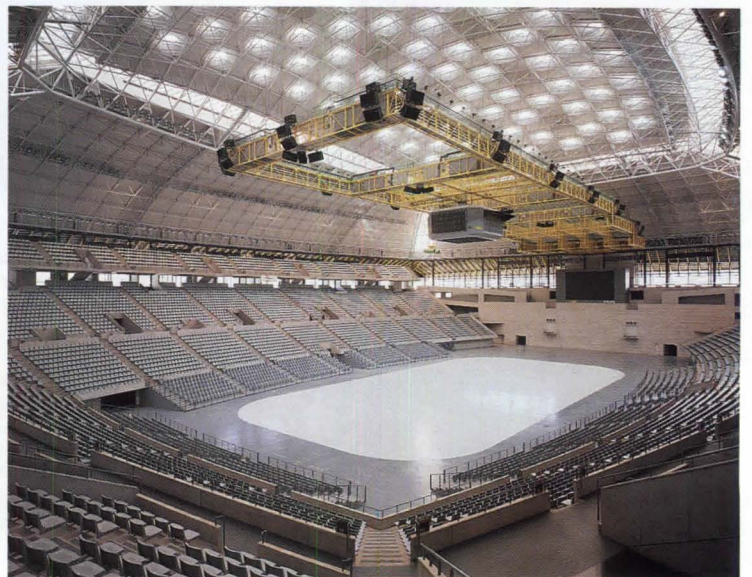

3b

Olympic Village

A large part of Barcelona's architectural community, 38 firms in all, joined in Oriol Bohigas's great experiment, a prototypical urban neighborhood for the 21st century. It's called the Olympic Village. Bohigas, the chief theorist behind Barcelona's urban policy and unofficial leader of the local architectural community, is the vital link between the Barcelona School of Architec-

ture, which he headed from 1977 to 1980, and City Hall. Bohigas is a many-sided activist—teacher, architect, polemicist, and politician—and the ambitious project required all of his talents. The site was ideal but difficult: underused shipping and railroad yards along the Mediterranean coast and close to the center of the city, which were expropriated and cleared in 1987-89.



Before construction could begin, a rail line along the coast was dismantled and another one was buried. The citywide sewage and runoff system was modernized and expanded within the site to prevent floods and halt water pollution. Three miles of beach were rebuilt and integrated with the new Olympic Port (left) and a wide range of parkland behind them—nearly 50 percent of the

site is now dedicated to parks. A new urban highway was partially buried behind the beach or sunk in trenches crisscrossed with pedestrian bridges that overlook surrounding greenery. Finally, the resulting prime beachfront real estate was developed by a public/private consortium with 40 percent government ownership. The master plan by Bohigas and his colleagues

Josep Martorell, David Mackay, and Albert Puigdomènech of their firm MBM was followed by a second stage of design at the scale of the block (by the teams of Amado & Domènech, Bach & Mora, Bonell & Rius, and MBM) before individual buildings were assigned to architects. The aim was to reproduce in a compressed time span both the variety and co-

herence of a traditional city. MBM saw the large number of participating architects as a test of “the dominant value of the urban design, and its capacity to absorb differences and even mediocrities,” although each architect’s signature is evident in the results. MBM’s thesis was to combine modern housing typologies—the linear apartment building with through



Studio Lluís Casals/Ferran Freira photos

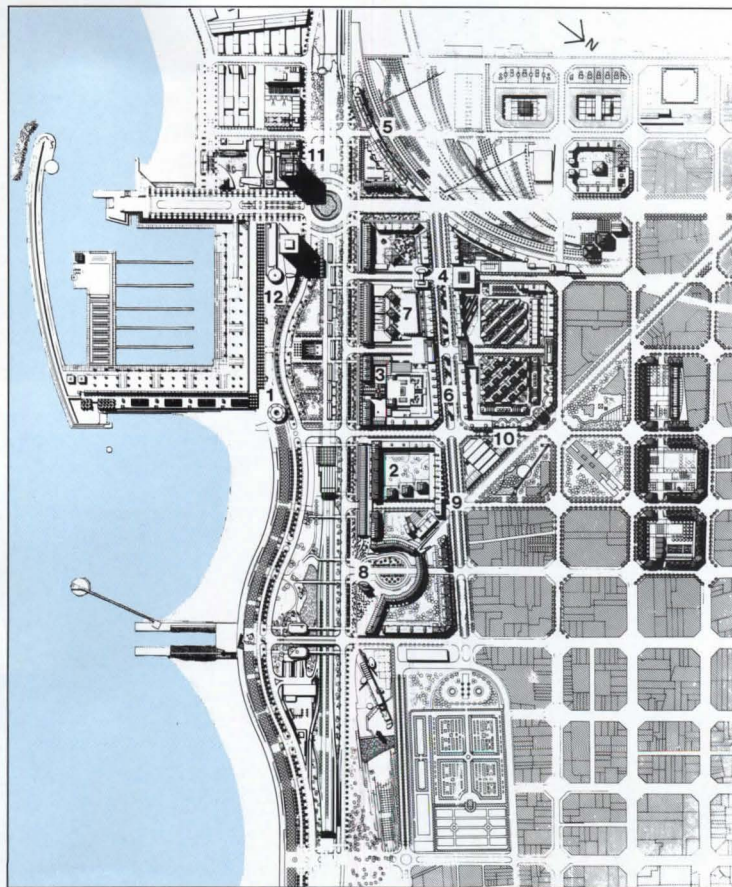

1. Meteorology Center by Alvaro Siza
2. Housing by Esteve Bonell and Francesc Rius
3. Housing/offices by Oscar Tusquets and Carlos Diaz
4. Telephone Exchange by Jaume Bach and Gabriel Mora
5. Housing by Josep Martorell, Oriol Bohigas, David Mackay, and Albert Puigdomènech (MBM)
6. Housing by Fullem Giráldez, Xavier Subias, and Pere López and trellis by Enric Miralles and Carme Pinós
7. Housing by Lluís Clotet and Ignacio Parico
8. Housing by Elias Torres and José Antonio Martínez Lapeña
9. Housing by Albert Viaplana and Helio Piñón
10. Sports pavilion by Moisés Gallego and Francesc Fernández
11. Hotel by Skidmore, Owings & Merrill and commercial complex by Frank O. Gehry & Associates
12. Office building by Iñigo Ortiz and Enrique León

exposures for the unit plans and vertical circulation cores—and the traditional blocks of Ildefons Cerdà's 19th-century expansion of Barcelona. The result combines traditional boulevard housing with such amenities as light, air, and open space. The six- to seven-story housing blocks lining the streets leave block interiors open; in seafront blocks, low towers and a com-

mercial center stand in gardens, while inland blocks are filled with housing. Streetfront massing is broken to produce what the architects call "almost corridor streets" and "almost closed blocks." In their insistence on the super-block, MBM bridged certain secondary streets with "gateway buildings," which, while remarkable designs in themselves, at times crowd the

adjacent buildings. The Avenue of Icaria, which bisects the Olympic Village, in particular feels too closed; the unvarying height and horizontal extension of the buildings becomes monotonous. The MBM plan works best when its traditional massing comes with eccentricities, as in the Torres/Martinez Lapeña housing or Ricardo Bofill's corner towers, and when it is seen as a whole from

the adjoining parks. Cerdà's blocks form a handsome seafront facade of a continuous portico lined with commercial spaces, while from the inland side a curving line of housing follows the buried rail line and screens the approach to the Olympic Port. The two monumental 44-story towers of the Olympic Port—a hotel designed by Bruce Graham and Skidmore, Owings & Merrill



1



2



3



4

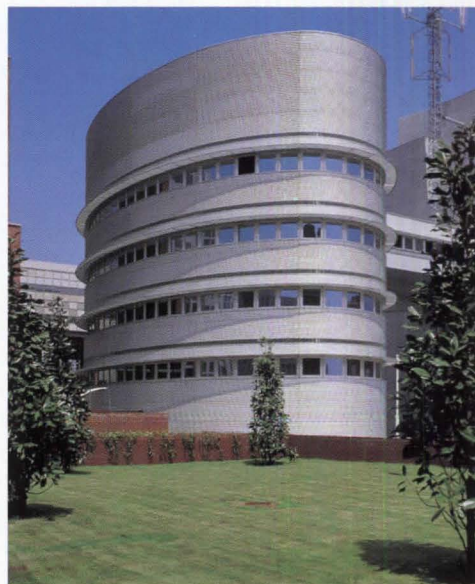

4a



5



5a

with a plaza-level commercial complex by Frank O. Gehry & Associates and an office building by Iñigo Ortiz and Enrique León—are meant to visually connect the Olympic Village to the city as a whole. In fact, they establish a new superscale gateway to the sea, forever changing the image of the city.

1. Meteorology Center by Alvaro Siza
2. Housing by Esteve Bonell and Francesc Rius
3. Housing/offices by Oscar Tusquets and Carlos Diaz
- 4., 4a. Telephone Exchange by Jaume Bach and Gabriel Mora
- 5., 5a. Housing by Josep Martorell, Oriol Bohigas, David Mackay, and Albert Puigdomènech (MBM)
6. Housing by Fullem

- Giráldez, Xavier Subias, and Pere López and trellis by Enric Miralles and Carme Pinós
7. Housing by Lluís Clotet and Ignacio Parico
 - 8., 8a. Housing by Elias Torres and José Antonio Martínez Lapeña
 9. Housing by Albert Viaplana and Helio Piñón
 10. Sports pavilion by Moisés Gallego and Francesc Fernández



6



7



8



8a



9



10

More Olympic Highlights

Esteve Bonell describes his work with Francesc Rius as a search for simplicity. "Can't we do this with less?" is their quest. But with the elegance of simple means, Bonell and Rius also create emotion and surprise. The closed elliptical form of their Badalona basketball stadium (below), set like an egg in a tough urban plaza, contrasts vividly with its wide entrance mouth, where the el-

lipse opens in two flanking wings. The drama continues in the passage to the arena. The absence of structural muscle on the outside—we see only the thin metal struts over smooth marble walls—and the confined space of the galleries contrast with the soaring volume under the sawtooth skylit roof, with its deep metal trusses and bracing. The roof rests on a concrete drum, its

vertical supports disappearing behind the stands. There are also contrasts in the details: the delicately constructed exit stairs deployed around the stadium's ample flanks, the play of curves, horizontals, and vertical; of light and dark materials; of sun and shadow. In the hockey stadium by Jaume Bach and Gabriel Mora (opposite left) for the nearby city of Terrassa, the search for

Studio Lluís Casals/Ferran Freixà photos



1a

simplicity led to a facility broken down to its essential components. The playing field is a depressed bowl, the stands bermed into the earth. Four spectacular light towers define the overall space like the minarets of a mosque. The canopy over the main grandstand is as light and taut as tent fabric. The secondary facilities appear likewise effortless. Simplicity also underlies the disorienting

complexity of Enric Miralles and Carme Pinós's work. The locker rooms for the competition and practice fields of the Olympic Archery Range (below right) are banked into a terraced slope. The main elements of the competition field facilities are inclined precast concrete slabs. Some are retaining walls, but others shelter cavelike interiors lit by skylights and small triangular

openings in the slabs. The concrete slabs of the adjacent practice field facility are tilted horizontally, and poured in place over ceramic formwork. They are independent of the walls below; an intermediate structure, composed on site, bridges roof and walls with clerestory windows and drainage channels that end in riveted spouts. There are echoes here of Barcelona's most fam-

ous architect Antoni Gaudí and his nearby Park Güell.

- 1., 1a. Municipal Sports Pavilion, Badalona by Esteve Bonell and Francesc Rius
- 2., 2a. Hockey Stadium, Terrassa by Jaume Bach and Gabriel Mora
- 3., 3a. 3b. Archery Range, Vall d'Hebron Olympic area, Barcelona by Enric Miralles and Carme Pinós



2



3



2a



3a



3b

Pasqual Maragall, Mayor of Barcelona



For Pasqual Maragall, the 1992 Summer Olympics culminate a 12-year effort to transform the city, in which architecture and urban design have been the chief protagonists of an ambitious campaign of economic, civic, and cultural renewal. I met with Maragall, Mayor of Barcelona, to discuss the philosophy and lessons of the city's program last year, after the city received Harvard University's Prince of Wales Prize for Urban Design.

Maragall is only the second democratically elected mayor of Barcelona since the end of the Spanish Civil War in 1939. He took office in 1982, succeeding Narcis Serra, who was elected in 1979. Like his predecessors and Spain's President, Felipe Gonzalez, Maragall is a Socialist, and he governs in coalition with an alliance of communist and leftist parties. He belongs to the younger generation of Spanish leaders (he is 51) who entered politics secretly in the Franco years when all political parties were illegal. Before entering politics, he was a professor of urban economics at the University of Barcelona.

Beginning with a parks and plazas construction program encompassing over 100 projects in the early 1980s, the city rapidly increased the scale of its buildings plan after it was selected as Olympic site in 1986. The selection called for the collaboration of state and regional authorities and private developers to fund the construction of the Olympic facilities and infrastructure.

One of the most impressive aspects of the city's effort has been the innovative thinking behind it, largely the inspiration of Oriol

Studio Lluís Casals/Ferran Freixa



Maragall has overseen the completion of a new ring road around Barcelona (1) and Norman Foster's 875-foot-high Collserola communications tower, set on a hilltop overlooking Barcelona (2).

Bohigas, who served as City Councilor for Urban Design from 1980 to 1984 (he presently serves as City Councilor for Culture). Bohigas's motto has been "to substitute the project for the plan"—to reach beyond the abstract criteria of planning and zoning, realizing urban design objectives through concrete architectural solutions. As a part of this philosophy, Maragall's administration is currently decentralizing the planning process itself, giving ten neighborhood councils full control over local planning initiatives.

Maragall explains that the early program of parks and plazas was conceived after the elections of 1979, when the city council had to respond—with scant resources and time—to the high expectations and skepticism created by the Socialist victory. Projects in the city's outer working-class neighborhoods, for example, addressed the urban chaos generated by uncontrolled development in the 1950s and '60s. Before money could be spent on schools, recreational facilities, or other essential services, relatively inexpensive paving projects were built such as the Plaza de la Palmera (3), a small park divided between zones for children and the elderly by artist Richard Serra's curving concrete walls.

The idea behind the program is, says Maragall, "to restore a lost sense of dignity to the urban landscape." He argues for urban design as an essential city service: "Sections of the city which are the product of uncontrolled speculation or decay tell a story of misery, alienation, and abandonment. There is a loss of sense. Youngsters shouldn't have to grow up in a landscape which isn't meaningful."

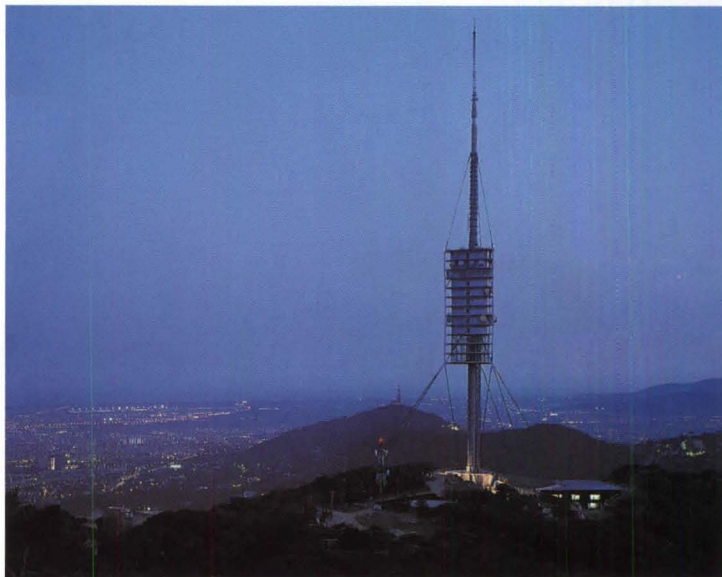

During his tenure as mayor of Barcelona, Pasqual Maragall has overseen an unprecedented effort to transform the city.

Maragall also sees the concept of “dignity” as the key to economic growth and the battle against crime and poverty. The city’s projects were designed to stimulate and manage market forces. “Misery is a self-feeding phenomenon. And wealth is, too. You have to mix them. You have to convince people that they have a stake in their neighborhood—and I mean middle-class people. You need a minimum critical mass to create that spontaneous expansion of wealth necessary for a certain level of vitality.”

The results of this policy are now visible all over the city, from the medieval quarter, where nine private development projects are currently under way along the *Ramblas*, the quarter’s colorful pedestrian street, to outer zones like the Via Julia, a popular shopping area created out of leftover spaces between developments.

In developing this policy, Maragall abandoned positions formed in the first years of the Socialist mandate. He now sees his early pledge to renovate the crowded slums of the medieval quarter without expelling their mostly poor and elderly residents as “a mistake.” “You have to admit a certain amount of gentrification,” he now says. “Because for a place to maintain its essential character, it has to change. It’s a paradox. Otherwise, instead of expelling people from the area as it becomes more expensive, you have people leaving because it is, in effect, too cheap.”

The larger projects made possible by the Olympics have been executed with the same attention to detail and local community needs.

The new highway (1) provided the occasion for the Moll de la Fusta, Manuel de Solà-Morales’s pedestrian promenade that opens the center of the city to its ports as well as the parks and beaches of the Olympic Village, and new recreational facilities on the road’s inland side. The project has been considered an “architectural” problem, an issue of “urbanity,” as much as traffic flow. Views from the roadway have been studied and designed; low-speed mixers buffer neighborhood streets from high-speed traffic, and a system of accessible underground galleries houses utilities along the route.

Maragall’s administration is now making plans for 1993 and beyond. Architects Jordi Garcés and Enric Sória’s five-block master plan for office buildings along the central Calle de Tarragona is one of several notable city-sponsored commercial projects currently under construction; a harborside World Trade Center by Pei Cobb Freed is another. Rafael Moneo’s Municipal Concert Hall and Ricardo Bofill’s National Theater will be the anchors for a vast redevelopment scheme intended, along with the Olympic Village, to shift future growth to the eastern half of the city. Richard Meier’s Museum of Contemporary Art is one of several cultural facilities contained in architect Lluís Clotet’s redevelopment plan for the medieval quarter of the Raval.

At the same time, Oriol Bohigas is working with his firm MBM on an urban design project for Paris’s La Défense and studies of Berlin: Barcelona’s dynamic example clearly has not been lost on other European capitals. *David Cohn*



Stadio Lluís Casals/Ferran Freixa

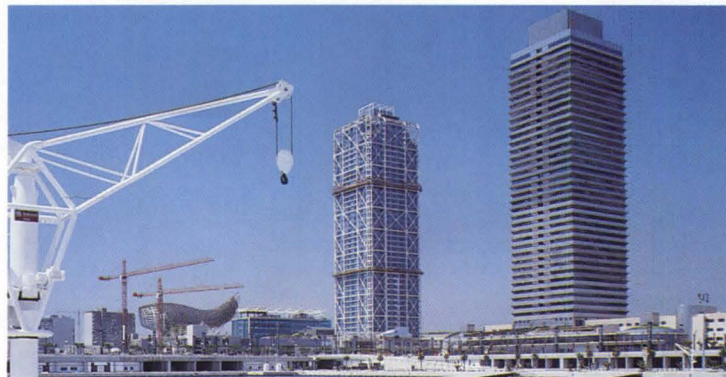

Maragall’s program of urban parks includes Plaza de la Palmera, which contains curved concrete walls by artist Richard Serra (3). Two 44-story towers, a hotel designed by Bruce Graham of Skidmore, Owings & Merrill (4, at right)



with a plaza-level commercial complex by Frank O. Gehry & Associates and an office building by Iñigo Ortiz and Enrique León (4, at left), are a new gateway to the city. Gehry’s giant fish (5) is still under construction.

Expo '92 Seville

© van der Vlugt & Claus photos

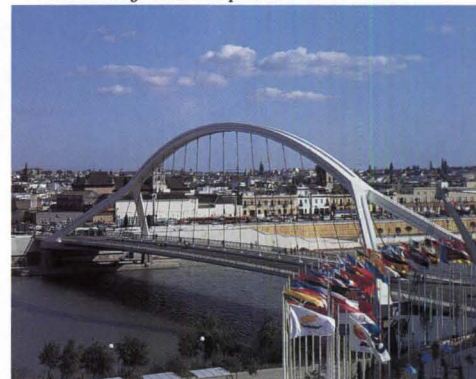

1



2



3

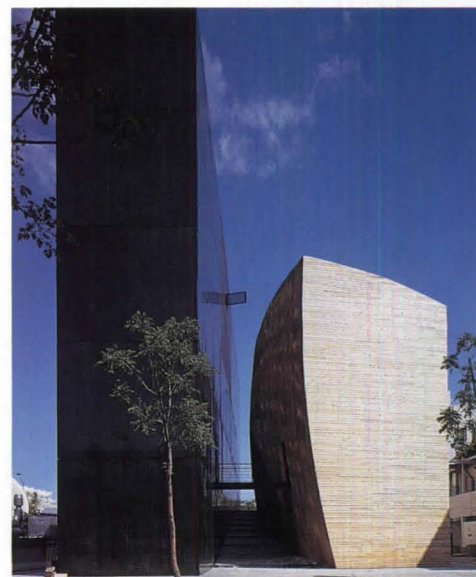

4

Has the world outgrown world's fairs? It's a question worth asking when you consider that at least \$8 billion has been spent on Expo '92, an event lasting just six months with its attendant boom-bust economics and enormous commitment of nonrenewable resources (this in the year of the Rio conference). Through its impressive execution and sheer exuberance, Spain's fair shrugs off this question and some other ideological baggage, too. Though nominally celebrating the fifth centenary of Columbus's voyages to the Americas, Columbus himself is virtually a nonperson in deference to native peoples who didn't ask to be "discovered." The fair also has an environmental line, inventive, but unmistakably grafted onto the usual paean to technology and national achievement (pages 40-43).

Typical of such gargantuan undertakings, Seville's fair has had its difficulties, including a major government reorganization. The sponsor dropped Emilio Ambasz's competition-winning design for the site on Cartuja Island, across from the city's historic center, which, with its conversion of the channelized Guadalquivir River into vegetation-lined bays, might have sent a much stronger environmental message. The current site plan (opposite) was cobbled together by the sponsors. The site scheme doesn't engage the historic city across the river, the river itself, or the Expo's centerpiece, the restored monastery of Santa Maria de las Cuevas, which drifts in a sea of manicured greenery. Each of the bridges that connects the fair to the city is by itself, however, a spectacular episode.

Individual elements of the fair are executed with tremendous élan, the work of many talented but not widely known Spanish architects (lighting by Santiago Miranda with Perry King of London; benches by Gabriel Teixid; litter bins by Pedro Miralles). The photos right and opposite hint at the fair's diverse wonders; on the following pages, we look more closely at two standout pavilions. The primary legacy of the fair—and possibly its key justification—is the astounding rebuilding of Seville's urban infrastructure. Various public entities built highways, bridges, an airport (by Rafael Moneo), bus station, and opera house; restored streets, parks, and historic structures throughout the old city; and tore up riverside railroad tracks for a vast esplanade. Two superb examples of this rebuilding are also shown on the following pages.

There is some U. S. participation in the fair (SITE most prominently). The U. S. pavilion, however, is so bungled that even Arnold Schwarzenegger (our "ambassador" to the fair) may be unable to save it. With its feeble echoes of a perfectly respectable though unadventurous design by Barton Myers and its anachronistic recycled geodesic domes, the pavilion's message is either that we don't know what face to present to the world or that we're incapable of presenting it. *James S. Russell and David Cohn*

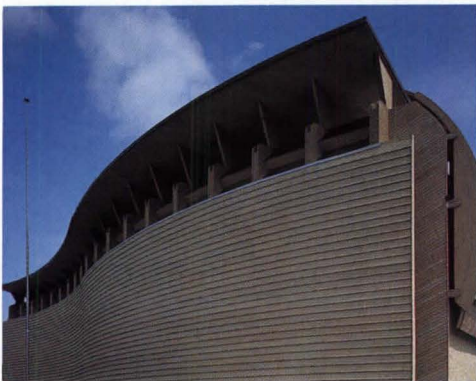
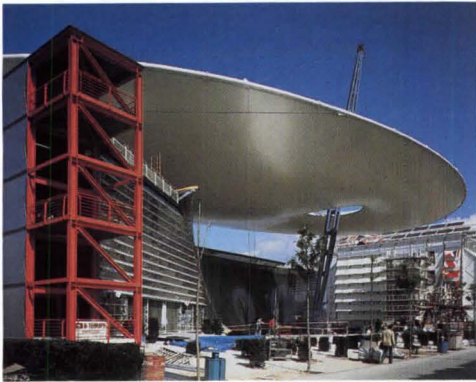

Expo '92's site plan, developed by the fair's governing authority, devotes much of the riverfront to gardens (some of which explore environmental themes) and gives pride of place to Spain's pavilion on a small lake (a vestige of Emilio Ambasz's dramatic competition-winning but unexecuted site design). Provincial pavilions circle the lake; national pavilions straddle

themed avenues. The Monastery of Santa Maria de las Cuevas (9 on map) presides over its own greensward. It is being renovated in stages in recognition of its long history by a team of architects. (It was supposed to have contained Columbus's remains.) South of the monastery are three themed introductory pavilions.

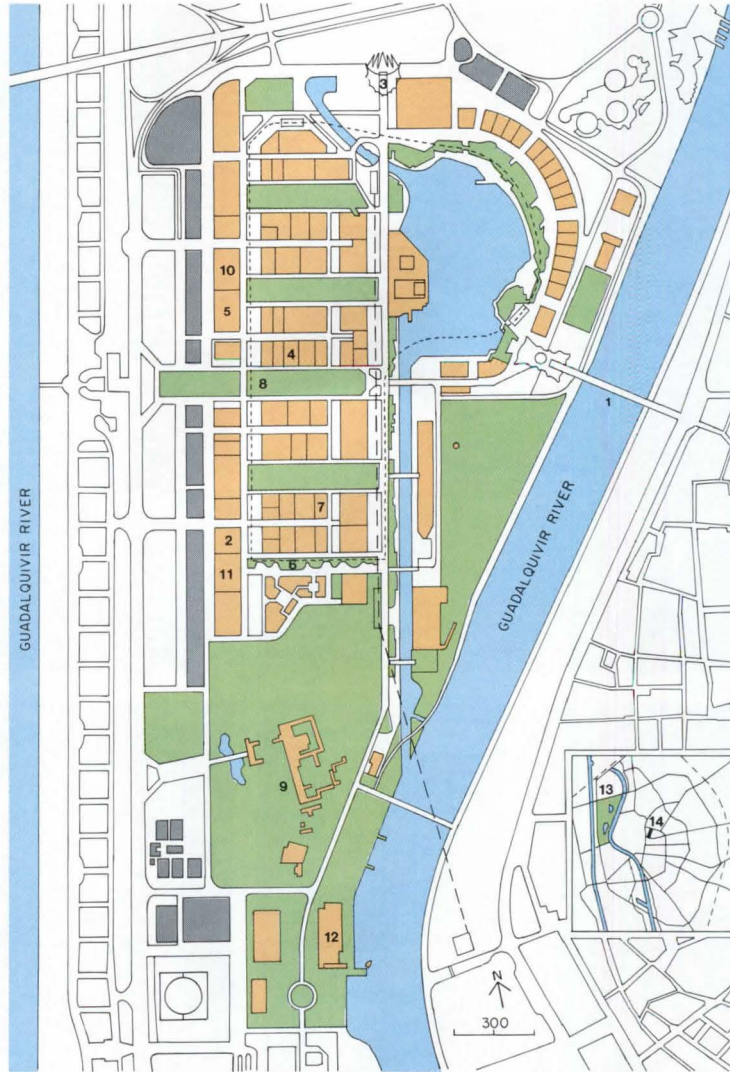

Projects shown on following pages:
 10. United Kingdom (Nicholas Grimshaw & Partners, pages 116-117)
 11. Japan (Tadao Ando, Architect, pages 118-119)
 12. Navigation pavilion (Guillermo Vázquez Consuegra, pages 120-121)
 13. Alamillo Bridge (Santiago Calatrava, architect and engineer, pages 122-123)
 14. Santa Justa rail terminal (Cruz and Ortiz, pages 124-125)

Photos left and opposite present an Expo sampler. (1): Barqueta Bridge (Juan Arenas and Marcos Pantaleon, engineers); (2): Saudi Arabia (Fitch Benoy with SITE); (3): Canopy, Puerta de Itálica (Harald Mühlberger); (4): Finland, a competition-winning design by

a collaborative of students (Monark Group); (5): Germany (George Lippsmeier, architect); (6): Avenue 5 (SITE, with Luis Calderon); (7): Chile (German del Sol and Jose Cruz); (8): Bioclimatic sphere (Antonio Cano, Pedro Silva, and Manuel Alvarez).

United Kingdom

Nicholas Grimshaw is the latest British architect to use high-tech means to "green" ends. [See also *RECORD*, June 1992 pages 82-83, 96-99, and 110-113]. Each elevation of this steel truss-framed shed responds to Seville's hot, dry climate. On its eastern entrance elevation (opposite), hundreds of water nozzles emit a 65-meter-wide stream of water onto a glass wall (bottom

left), reducing solar-heat gain. A stainless-steel gutter converts the stream into a 5.5-meter-high water spray, so that evaporative cooling lowers internal temperatures. (The architects collaborated with the William Pye Partnership on the water feature.) The water forms a pond at the base of the structure, further dropping temperatures within a zone behind the entrance wall, which

© Richard Bryant/ARCAID photos

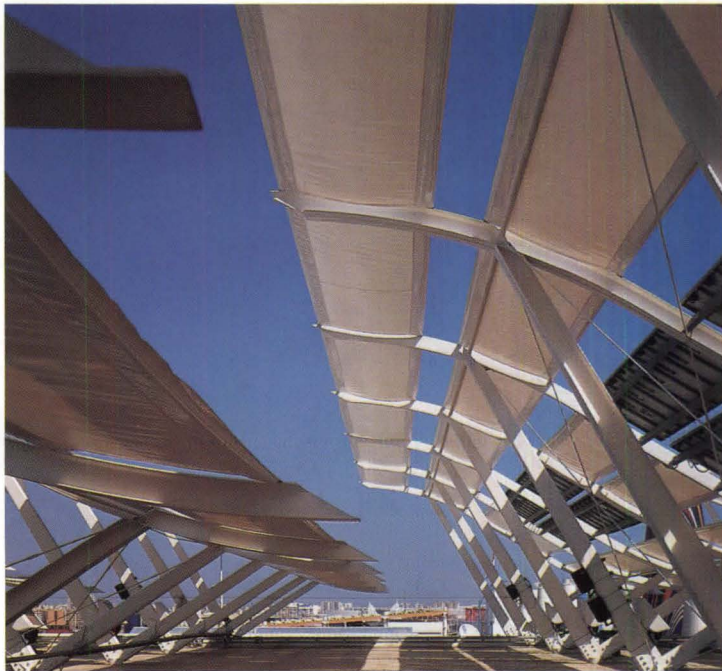
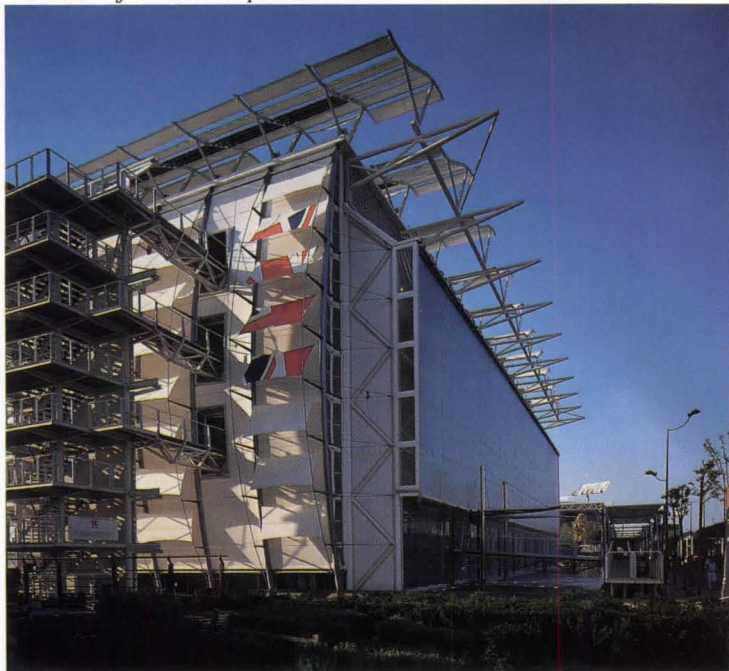

is open to the three-level interior (opposite bottom right). The west elevation is a Trombe wall made of membrane-lined, steel cargo containers filled with water. They absorb daytime heat, and radiate it during the cool nights. The north and south walls are enclosed by translucent PVC-coated polyester fabric stretched over a framework of yachtlike spars tensioned by spreaders and ca-

bles (opposite top left). The highly insulated roof is protected by elegant armatures supporting fabric sunshades and solar panels that power the water-feature pumps (opposite top right). Inside, the sculptural effect of the waterwall, visible from suspended walkways and moving ramps, competes with the tripartite plan, which is divided into loftlike pods containing exhibits. J. S. R.



Japan

Amidst the architectural cacophony of Cartuja, Tadao Ando's pavilion for Japan presides serenely. It is recognizably an extension of Ando's work in its austere simplicity. Its use of wood and its evocation of traditional Japanese architectural themes, however, are a departure for this architect. The building's design concept is completely revealed on the exterior. Glu-lam

beams support tentlike concave walls of unfinished African Iroko wood siding, which are tensioned by metal-pipe elements. Corbelled, glu-lam wood beams (visible in the central, entrance opening) underpin metal ribs that stretch a translucent roof of Teflon-coated fabric. Laminated-wood piers supporting these "capitals" evoke traditional construction techniques as does the arched

© van der Vlugt & Claus photos

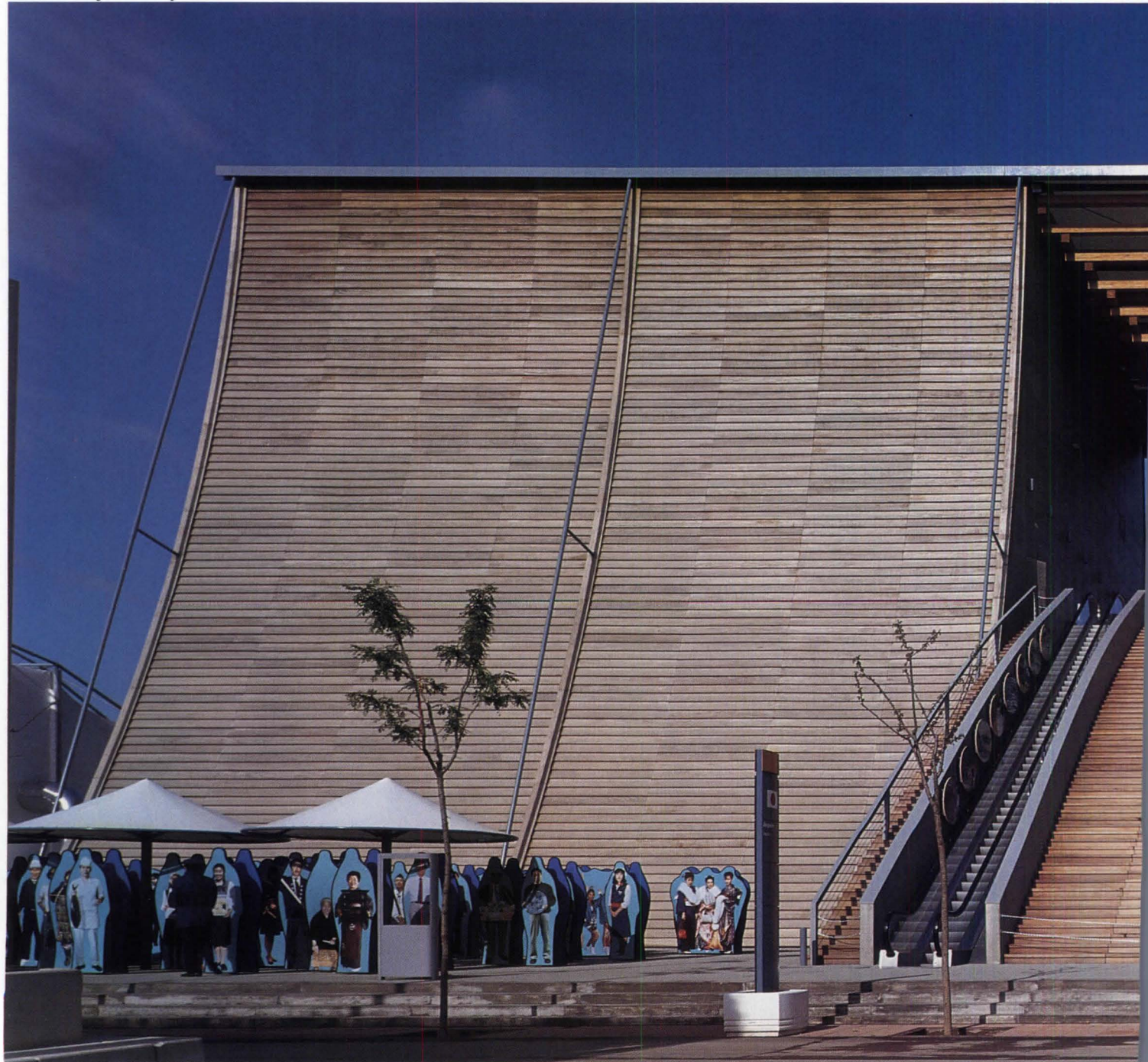

entrance bridge which takes visitors up to the fourth-level entrance. Such bridges in history symbolized passage from this world to the next, a sensation that seems palpable here when the setting sun shines through the opening. From this level, visitors descend through exhibits depicting the relationship between Japan and Europe since the 16th century. A collection of photosilhouettes

grouped under parasols in front of the pavilion is an off note. These curious figures show Japanese people engaged in typical occupations. Possibly added to soften this very large pavilion's arguably forbidding appearance, they trivialize the design instead. J. S. R.



Navigation Pavilion

Though in his late 40s, Guillermo Vázquez Consuegra, based in Seville, is one of a new generation of Spanish architects whose work is drawing increasing attention. (He has also designed an offsite telecommunications center and well-regarded social housing.) His largest work to date is this "pavilion of navigation," one of Expo's general-theme buildings. Its prominent location

flanks the southern entrance of Expo's site, closest to the historic center of the city. The low, curved, metal-roofed exhibition pavilion is framed with enormous glu-lam wood ribs (opposite bottom right), evoking the framing of ships. (The re-created ships of Columbus are moored in the river, opposite top). On the land side, the roof overhangs a sunshaded vertical facade. Visitors enter

© Duccio Malagamba photos



from this side through a layer of dense, closed services to an expansive mezzanine overlooking the pavilion's main space. Glazed monitors punched through the side of the roof admit light to the interior (bottom left this page and bottom opposite). A monumental ramp, roofed in concrete T beams divided by light slots, links the site's main pedestrian

(opposite top), a landmark that beckons visitors from the historic city. The tower, named for its sponsor, a maker of elevators and other conveying systems, counterpoints a concrete pier with a metal-framed vertical armature supporting an external stair and glass-clad elevators. A crowning bridge links the two parts and offers views over the Expo site and the city. J. S. R.

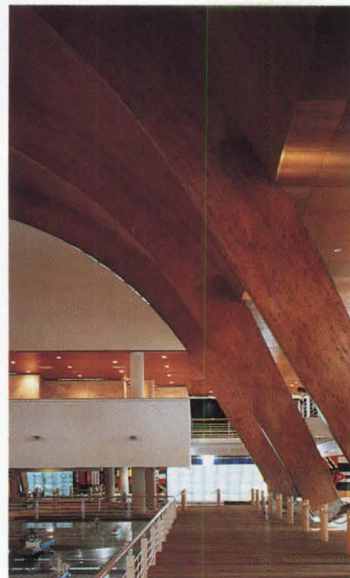

Alamillo Bridge

Santiago Calatrava's Alamillo Bridge and its connecting causeway (opposite top left) is just north of the Expo site and part of Seville's new 44-mile ring-road system. It is one of eight new bridges (any one of which would be an award-winner in the U. S.) carried out in conjunction with Expo. The sloped 140-meter-high concrete-and-steel composite tower supports cables without using

backstays. The cable stays run between the two roadways (opposite top right) to a nine-foot-wide steel-box stiffening girder. The roadways are supported by cantilevers from this central spine. Though the bridge's tower is Seville's tallest structure, it is surprisingly unassertive, and so does not upstage the city's historic symbol—the medieval Giralda tower. J. S. R.

© van der Vlugt & Claus photos



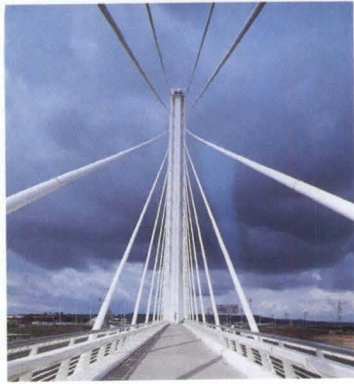

Santa Justa Station

Antonio Cruz and Antonio Ortiz are Sevillian contemporaries of Vázquez Consuegra. Like Vázquez Consuegra's Navigation Pavilion, the mammoth Santa Justa station is this firm's biggest project yet. It is the Seville terminus of a new high-speed line that originates in Madrid's Atocha station [RECORD, July 1991, pages 222-229]. The new terminal site

contained an abandoned station and acres once occupied by warehouses. This urban wasteland divided adjacent neighborhoods from each other. In a masterplan prepared by the architects, new streets and plazas will knit the neighborhoods together while an encircling perimeter of new commercial structures will buffer the parking and intense traffic of the station from residential areas. Framed in

© Duccio Malagamba photos, except as noted



concrete with brick infill, the station itself makes grand gestures with minimal means. It is set on an artificial rise, so that tracks may pass beneath the streets. The entrance elevation (opposite top) faces the city. A curving concrete slab forms a suave porte cochere (middle left), which leads to a tall waiting hall reminiscent in its proportions of the Beaux-Arts terminals of rail's golden

age (middle right). Moving walks (bottom left) convey passengers under clerestories down to track level. Metal-roofed canopies framed in light-gauge steel and incorporating skylights and ventilation louvers cover platforms (bottom right). Opposite bottom: track-side elevation. J. S. R.

J. S. R.



J. S. R.



Technology Focus

A Finely Tuned Tower

747 South Flower Street Tower
Los Angeles, California
Wolf + Architects

It's hard to know how the office tower of the '90s will evolve, but an economy of means is likely to loom large. This factor is in accord with Harry Wolf's method. In such projects as Tampa's NCNB Bank, he continued the Modernist tradition of synthesizing structure and architecture through a classic, modular resolution of geometry: architecture as the *embodiment* of efficiency. This is not so easy in Los Angeles, where tall buildings must resist wind *and* high seismic loads. For 747 South Flower Street, shown here, the design team makes its case for a return to structural expressionism. "You have to use the means at hand," Wolf explains.

To achieve an economical structure for the 46-story, 665-foot-tall tower meant "putting as much material on the outside as possible," explains Guy Nordenson, partner at structural engineer Ove Arup & Partners. "Then you can carry all the dead weight on the outside of the building, which also serves as windbracing." The structural scheme uses what Nordenson calls a modular megatruss approach in which the most prominent elements are three-story diagonal braces. They pass lateral and gravity loads to the corners, not on columns but through corner vertical trusses formed by the folded diagonals of the outer bay (following pages). This innovation frees corner offices of columns while providing enormous resistance to overturning forces at the most efficient location. The trusses descend to the ground as massive piers, while the central bays are left open at grade as a monumental through-block open space.

The unusual alternation of narrow and wide bay spacing (even on the prismatic east elevation, opposite left) was done for structural reasons. "Fusible" elements—ductile members that fail in extreme earthquake motions in order to absorb seismic energy—span the narrow bays visible in the elevations (right). This approach, based on an analysis called capacity design, permits "damage to occur where detailing can be very carefully controlled," says Nordenson. Code officials agreed with the engineer that the design permitted the partial elimination of a normally required backup moment frame. According to the design team, both the structural and facade designs are highly economical (the weight of steel, for example, being some seven pounds per square foot below comparable buildings).

Tying these elements together was Wolf's achievement. The design team has calibrated the bracing and corner trusses in a syncopated pattern of large and small diagonals. Wolf worked out the curtain-wall module so that all of the bracing intersections occurred at the centerlines of either spandrels or glass. There is a rare composure, even a sense of effortless inevitability in the way the components fit together ("born of enormous hard work," says Wolf). Such a project needs all the inevitability it can find: its construction awaits an improved market. *James S. Russell*

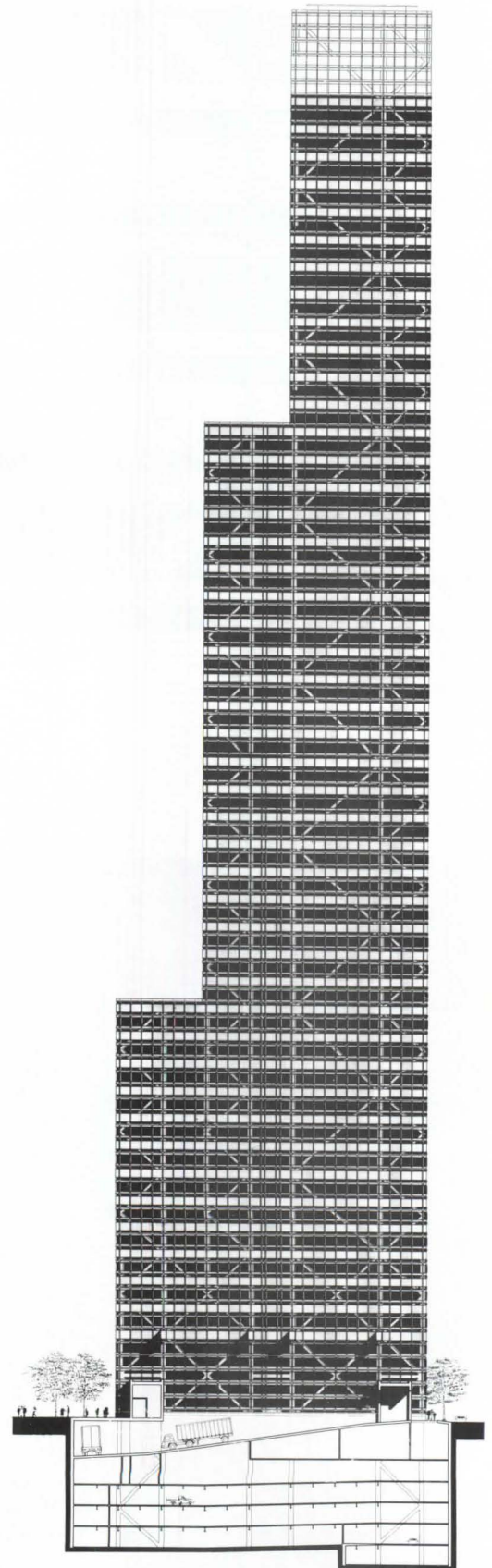

SOUTH ELEVATION

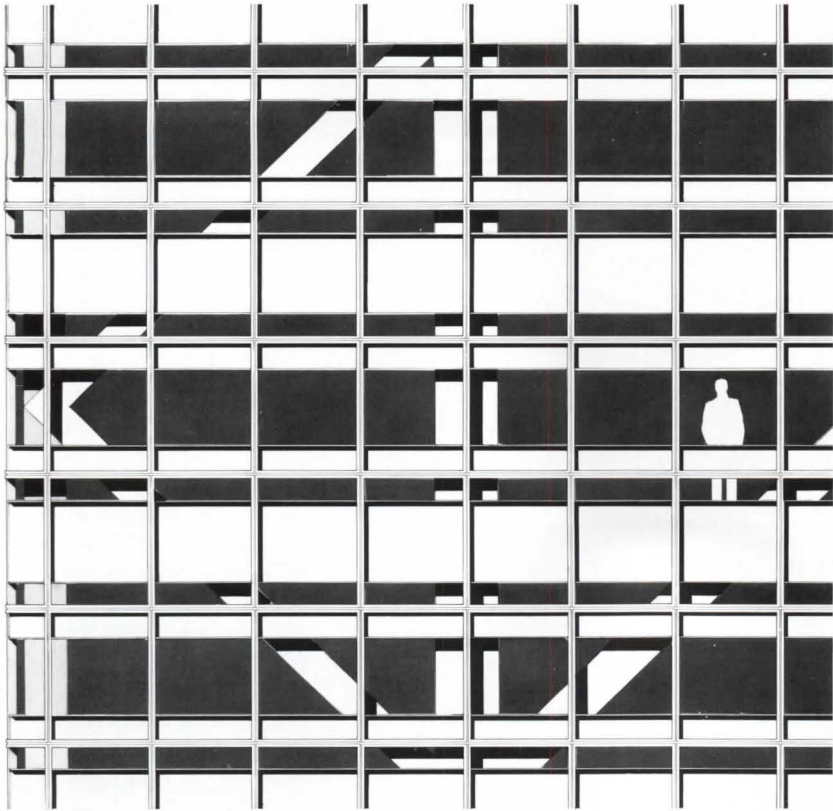

PARTIAL ELEVATION

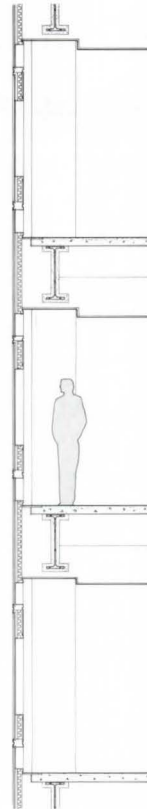

SECTION

Using diagonal trusses at 747 South Flower Street frees the corners of columns, though every third level features the potent image of a truss's apex (model view bottom). Wolf floats spandrels by inserting a foot-high vision-glass panel aligned with each story's ceiling and floor. The spandrels' opaque surface is recessed behind glass, creating a shadowbox effect (left).

Credits

*747 South Flower Street Tower
Los Angeles, California*

Owner: Ahmanson
Commercial Development
Company

Architect: Wolf + Architects—
Harry C. Wolf; E. Jonathan
Frishman, Christopher Coe,
project architects; Carl
Hunter, Madelaine Fava,
Lester Yuen, Ken Turner,
Mary Sager, Paul Kinley, Toni
Lewis, Matthew Gammel,
Larry Bisson, Genevieve Yee,
Michael Rominske, project
team

Associate Architect:
CRSS (schematics)

Structural Engineer:
Ove Arup & Partners

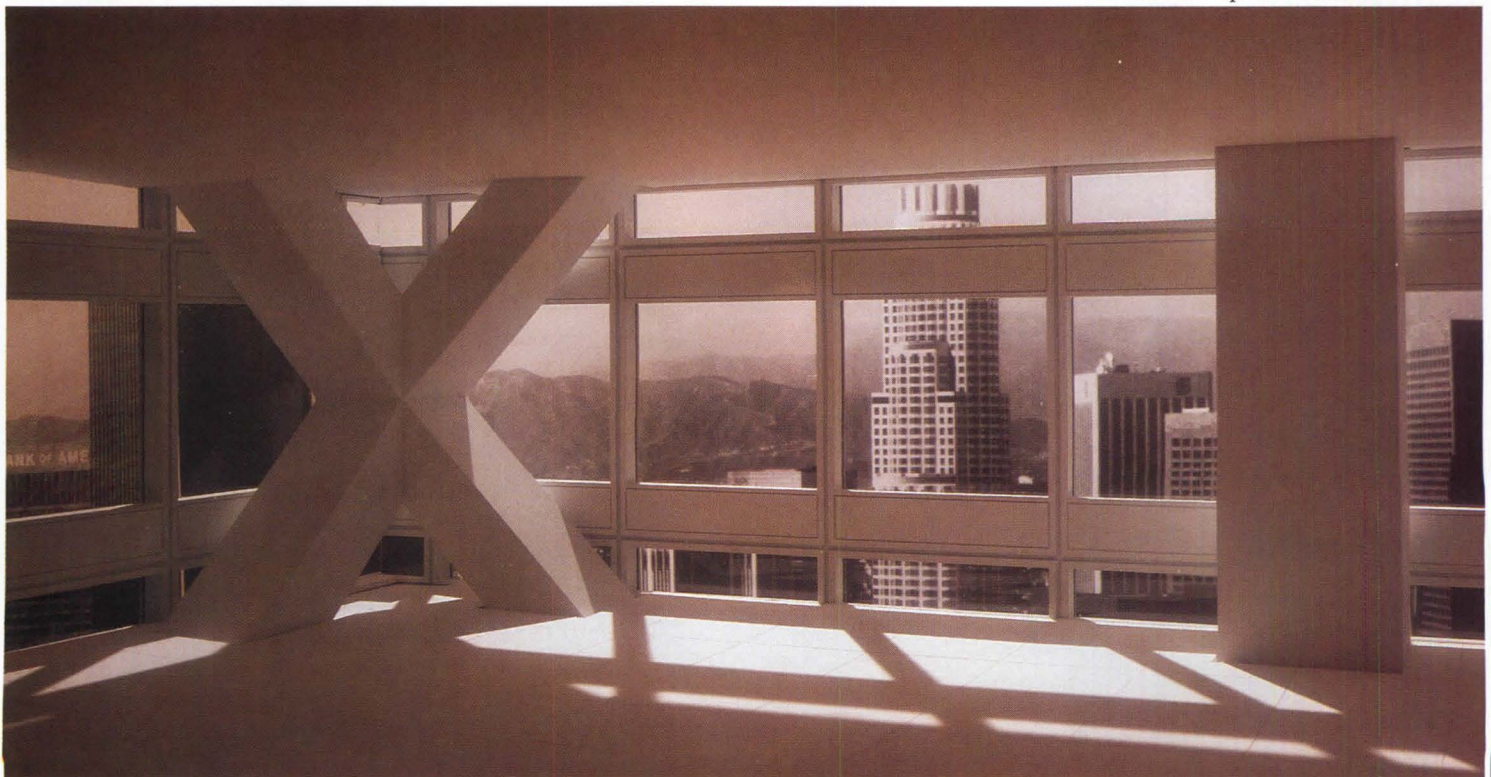

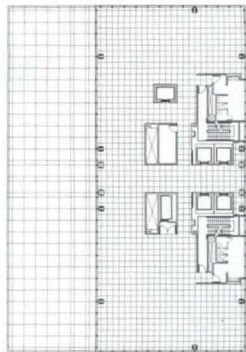

HIGHRISE PLAN



HIGH MIDRISE PLAN

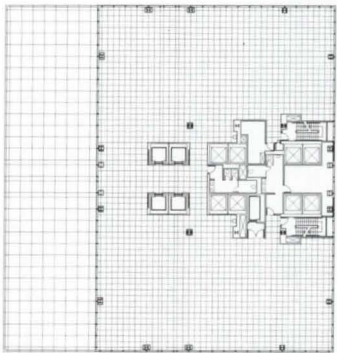

LOW MIDRISE PLAN

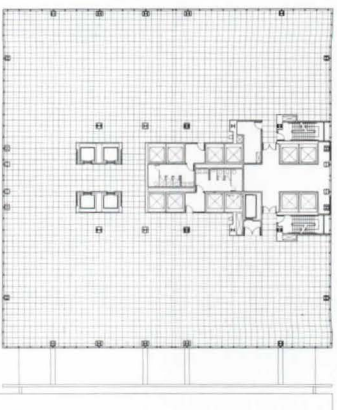

LOWRISE PLAN

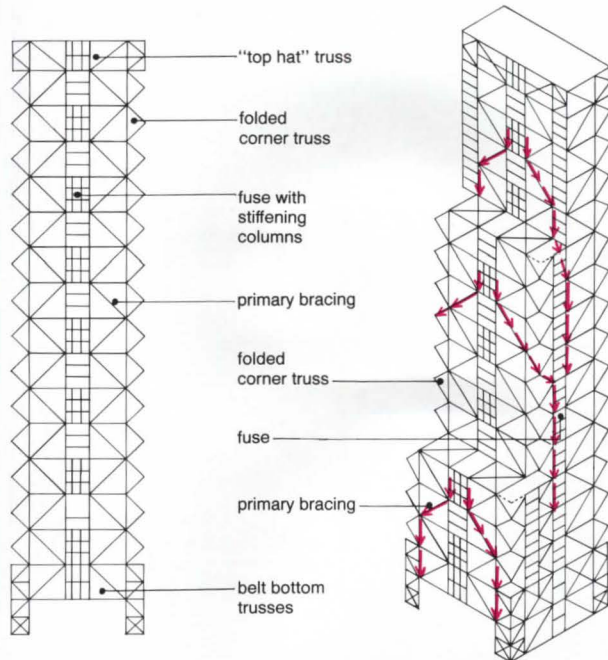

STRUCTURE—EAST ELEVATION

TRANSFER OF SETBACK LOADS

The two setbacks in 747 South Flower Street provide tenants with floor-leasing options and leave an adjacent public plaza free of shadows. The diagonal bracing creates paths to carry loads from the narrower upper levels to the wider base (near left). Elevator cores align with column bays, permitting up to 50-ft clear spans from exterior to core (plans far left). Wolf created syncopated elevations by resolving the geometries of structure and glazing (bottom drawings). Glass mullions fall on either full five-foot-wide modules or partial modules of two or three feet. Even mechanical needs play a part in the articulation of the facade: translucent glass on the east elevation reveals the building's core. White stamped-metal louvers mark fun rooms.

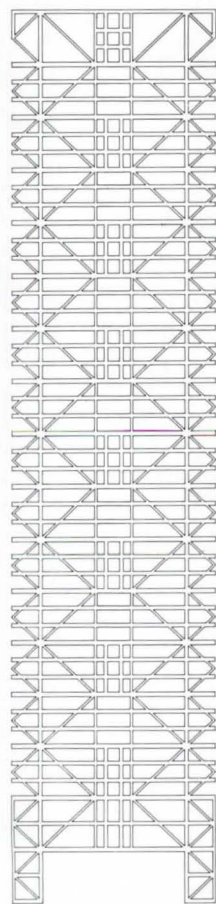

STRUCTURE



MECHANICAL LOUVERS



VISION GLASS



TRANSLUCENT GLASS

"The CAD Experts RAVE, Now I know Why.."

Jim Scalise finds FastCAD®'s speed and ease of use gives more than an increase in quality production time... "We found other systems difficult to learn, but FastCAD enabled us to get up and running in short order. Architects that need the fastest CAD system have to see this to believe it. FastCAD really lives up to its name. Without FastCAD it would be tough to compete and we wouldn't have time for the extensive detailed work we consider standard on all construction documents.

Jim Scalise
Jim Scalise
 Nickels + Scalise Architects



Plus, paper storage would be overwhelming and we'd still have 'draftsman's cramp' in our fingers and graphite on our forearms. After winning two National CAD Drawing Contests and elating our clients with FastCAD, it's as easy for me to endorse as it is to use."

If you want to be more competitive, but find yourself short on time, don't delay! Call Evolution Computing today for a free demo at 1-800-874-4028. Free technical support for registered users.

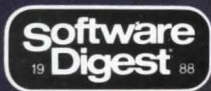

FREE Hands-On Demo, Call 1-800-874-4028 Now!

EasyCAD and FastCAD are registered trademarks of Evolution Computing © 1992 Evolution Computing.

Circle 30 on inquiry card

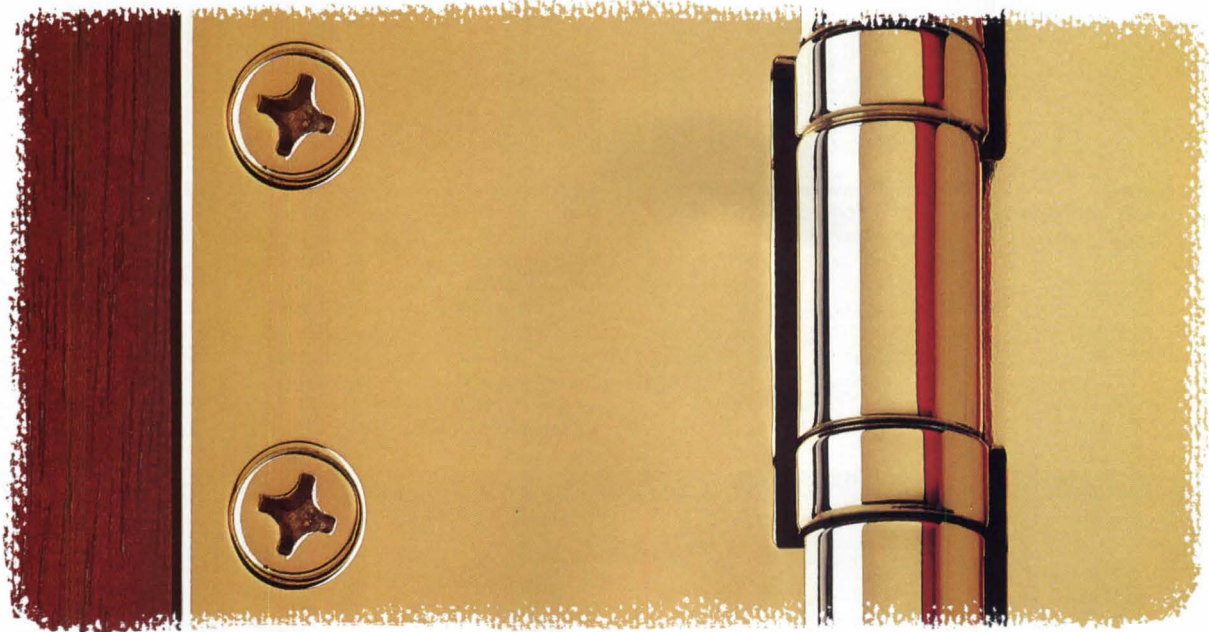

This is one of the few times you'll ever notice a McKinney hinge.

To paraphrase an old saying, a hinge should be seen and not heard. Because the only time you hear about a hinge is when something goes wrong.

A hinge should get to your site on time. What good is a high-quality hinge if it's not where you need it when you need it?

A hinge should be part of a full line. A line that includes the only two-knuckle, three-knuckle, and five-knuckle hinges available for any application. Including a five-knuckle concealed bearing hinge.

A hinge should be available in a wide variety of finishes, bearings, and functions.

A hinge should work perfectly day after day, year after year. In both new construction or retrofit.

In short, a hinge should be a McKinney hinge.

Call (717) 346-7551 for the ESSEX salesperson or McKinney distributor nearest you. You can also ask about Curries hollow metal doors and frames, Graham architectural doors, and Sargent locks. McKinney Products Co., 820 Davis Street, Scranton, PA 18505.

McKINNEY

ESSEX INDUSTRIES, INC.

Circle 31 on inquiry card

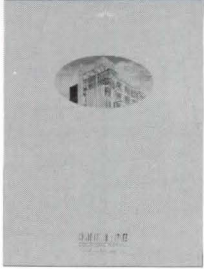

400. Spectrally selective
California Glass is a clear, very-low-reflection laminated configuration that incorporates heat-reflective film for solar control in architectural applications. Said to admit "cool daylight," the glazing transmits 73 percent of visible light while reducing the heat load by 30 to 40 percent. Southwall Technologies, Palo Alto, Calif.



401. Electromagnetic windows
Brochure describes how composite-panel technology enhances the security and clarity of microwave communications, while helping the architect maintain the design integrity of a structure. Electromagnetically transparent materials can be custom colored to match other components, such as roofing. Chemfab New York, Buffalo.

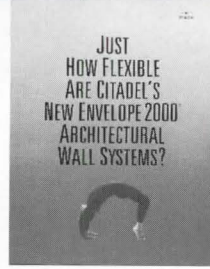

402. Exterior panels
Citadel, formerly Weyerhaeuser, offers cladding options that fit a range of budgets and applications, including curvable composite-core metal-face panels, fire-rated BlazeGuard sheathing, and an economical phenolic-core laminate from Europe that can be worked with regular carpentry tools. Citadel Architectural Products, Federal Way, Wash.



403. Pressure-treated wood tips
Fasteners for Treated Wood discusses the importance of selecting the right nail in exterior applications, where the wood itself will outlast a poorly galvanized nail or screw. Matches nail size and shank pattern with holding capacity and lumber dimension. Hoover Treated Wood Products, Inc., Thomson, Ga.

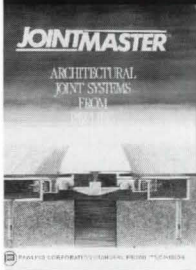

404. Fire-rated joints
Color brochure describes the new JointMaster line of fire barriers for floors, walls, roofs, and ceilings. Product features include a unitary tension/centering bar, a one-piece device said to improve joint strength without loss of easy movement. Pawling Corp., Standard Products Div., Pawling, N. Y.

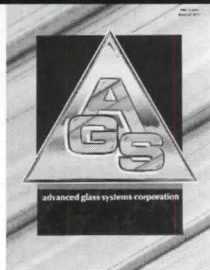

405. Security glazing
Specialty glass and glass-clad laminates are described in a technical catalog. Noviflex-BR offers several levels of ballistic performance suitable for banks, prisons, high-value retail, and other applications requiring extra security. Advanced Glass Systems, Trumbauersville, Pa.

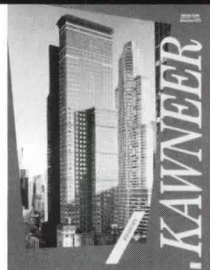

406. Architectural aluminum
All Kawneer heavy-commercial and commercial-grade window products are detailed in a comprehensive, full-color catalog. Illustrations include the custom vertical-pivot windows designed for New York City's Carnegie Hall Tower by Cesar Pelli & Associates/Brennan Beer Gorman. Kawneer Co., Inc., Norcross, Ga.

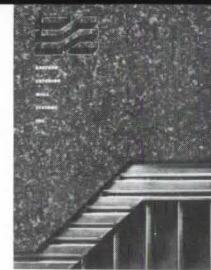

407. Prefabricated panels
A capabilities folder describes a range of plant-fabricated enclosure options, including Cygnus panels for ceramic tile, glass, or stone; composite metal-faced panels, and thin brick set in mortar beds. Advanced CAD programs facilitate the design and testing of custom wall panels. Eastern Exterior Wall Systems, Inc., Bethlehem, Pa.

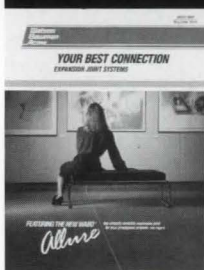

408. "Invisible" controls
Expansion-joint catalog features the Allure system, a low-profile device that minimizes the amount of visible metal. Suitable for carpeting and other flexible floor surfaces, it can also be used in vertical applications. The 12-page brochure also details all Wabo standard and fire-rated expansion joints. Watson Bowman Acme, Amherst, N. Y.

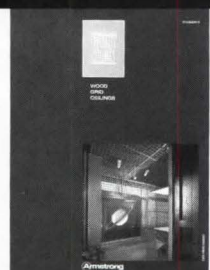

409. Specialty ceilings
Modular and continuous natural-wood grids for lay-in and concealed installation provide a decorative, fire-rated interior option. Four-page brochure gives design and dimensional data on the ceiling line, formerly offered by Forms + Surfaces. Armstrong Contract Ceilings, Lancaster, Pa.

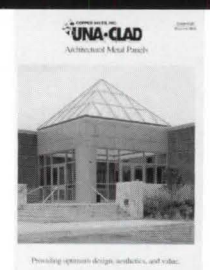

410. Architectural metal
An eight-page catalog highlights decorative, functional, and structural elements made of Una-Clad aluminum, steel, and other metals: roofing, fascia, canopies, solar-control louvers, column covers, and honeycomb- and composite-core cladding panels. Copper Sales, Inc., Minneapolis.

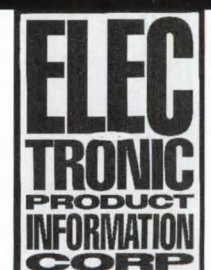

411. Electronic product data
Colorful flyer explains software programs specific to the building products industry, with functions that include object-oriented analysis and coding exportable to Windows, DOS, Macintosh, and UNIX systems. A new product offers an easy-to-use standard format for manufacturers and specifiers of windows. EPIC, Nashville, Tenn.

WE'RE NOT THE ONLY ONES BEHIND LAMINATED GLASS.

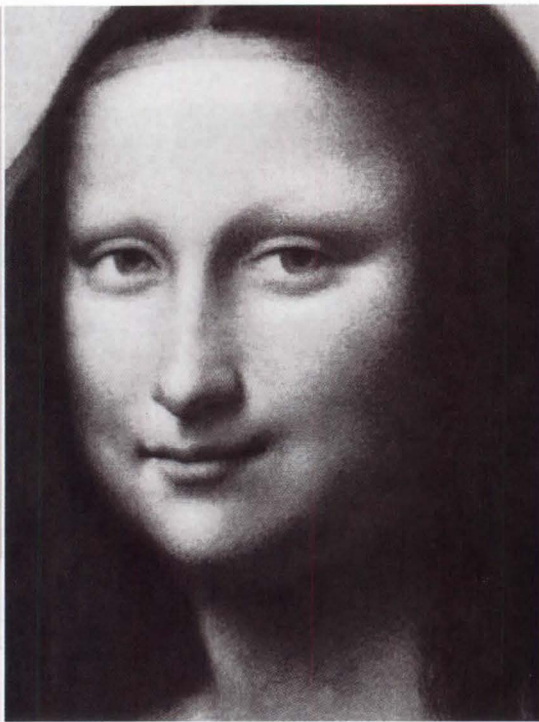
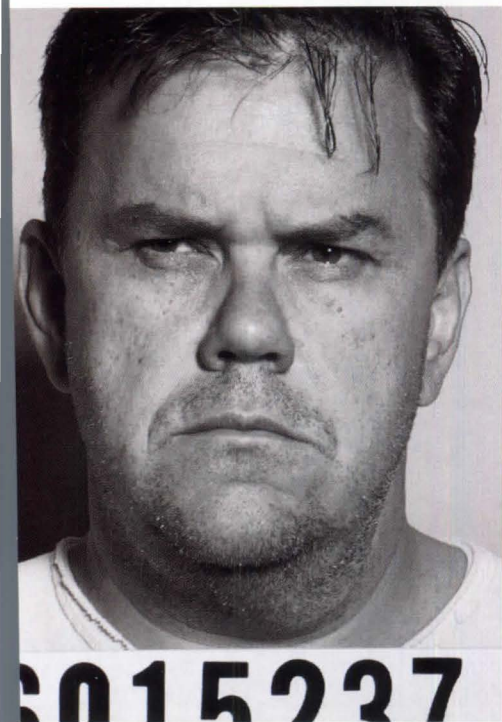

For years now, experts in safety and security have relied upon, trusted and specified laminated glass made with Saflex® plastic interlayer.

They know laminated glass made with Saflex can stop bullets, bombs, blunt objects and just about anything else you might happen to throw against it. For security, for protection, for detention applications, for value, for aesthetics, nothing else performs quite like it.

For a free Security Glazing Design Guide and an accompanying IBM-compatible software program (or for a free informational video) complete and return the coupon on the right. Or just call us at **1-800-248-6844**.

Because whatever (or whoever) you need to protect should be standing behind glass that can stand up to anything.



Name _____
 Title _____
 Company _____
 Address _____
 City _____ State _____ Zip _____
 Telephone _____

Send me the free Security Glazing Design Guide and software.
 Check one only: 5¼" disk _____ 3½" disk _____

Send me the free informational video. AR-8-92

PLEASE SEND COUPON TO:
 MONSANTO COMPANY, Dept. 204, 800 N. Lindbergh Blvd.,
 St. Louis, MO 63167.

© Monsanto Company 1992. *Registered trademark of Monsanto Company





412. Tile-selection aids

A new marketing program combines ceramic-tile samples, installation photography, and technical data in a notebook-format Master Sample kit. Material explains the unique nature of flashed tile, a product that offers a random color variation from tile to tile, produced by a reduction-firing process. Metropolitan Ceramics, Canton, Ohio.



413. Complete line

A 24-page catalog provides descriptions, application recommendations, standard specification data, and durability ratings for each of 17 different product groups for residential and commercial use. Includes tile for walls, floors, counters and tub surrounds, and exterior pavers. Mannington Ceramic Tile, Lexington, N. C.

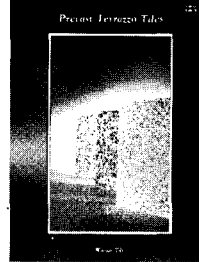

414. In-stock terrazzo

Design brochure illustrates eight colors of 12-in.-sq cementitious-terrazzo tile, now available from stock at a factory price of \$1.79 per sq ft. Polished wear surfaces come in micro-, standard-, and shot-blast finishes; edges are beveled. Wausau Tile, Inc., Wausau, Wis.

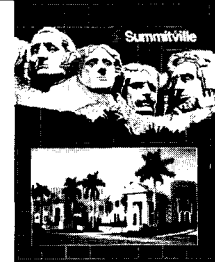

415. Indoor/outdoor tile

A colorful catalog has 40 pages on quarry tile, floor brick, smooth and raised-pattern porcelain pavers, and glazed tile, for all types of architectural applications. Includes specialty products such as tunnel tile, sculptured shapes, custom murals, and signage. Summitville Tiles, Inc., Summitville, Ohio.

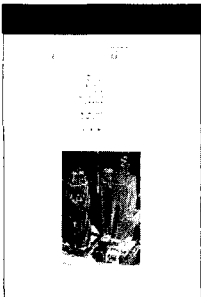

416. Single-source granite

New 20-page brochure describes quarrying, design, fabrication, and erection services, reproduces over two dozen colorations, and illustrates granite applied in homes, churches, landscapes, and high-rise buildings. Drawings included for typical spandrel, curtain-wall, and anchor details. Cold Spring Granite, Minnetonka, Minn.



417. Colored grouts

A grout-color palette features 32 shades, including new quarry red, terra cotta, pink, teal, forest green, and silver; grouts offered in sanded, unsanded, and epoxy formulations. MAPEI Corp., Elk Grove Village, Ill.

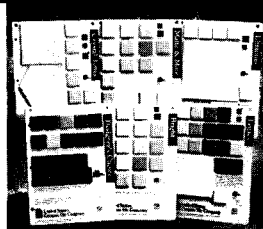

418. Sample boards

Contractor/specifier sample boards hold 1 3/8-in. chips that represent each tile line's color palette, with silhouettes indicating all available sizes and shapes. Each field-tile collection is referenced to coordinating accent and trim tiles. United States Ceramic Tile Co., East Sparta, Ohio.

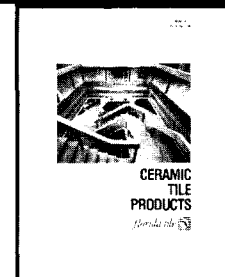

419. Tile-design reference

Illustrated with color photography of ceramic tile used in residential and commercial settings, a 52-page catalog covers 26 product lines for floor and wall. Technical data, pattern, and color information is associated clearly with each tile collection. Florida Tile Industries, Inc., Lakeland, Fla.



420. Limestone facades

Jura limestone is shown installed in traditional European, curtain-wall, and Cygnus panel systems. The stone is said to offer excellent resistance to environmental pollutants and weathering, with a surface that can be honed, polished, bush-hammered, sandblasted, and striated. Solnhofen Natural Stone, Inc., San Francisco.

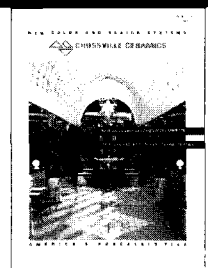

421. Color-coordinated tile

A new, whiter porcelain-body formulation permits a clearer, more defined range of colorations designed to cross-reference each other. A new catalog displays all of these Cross-Colors, offered in mineral-looks and splash-patterns as well as solids. Crossville Ceramics, Crossville, Tenn.

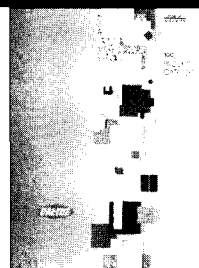

422. Architectural ceramics

A design catalog describes professional services offered by this tile source, including product-presentation seminars, technical and installation assistance, and sheet-mounted custom murals in porcelain or glazed tile. Installation photographs include elaborate mosaic-pattern floors. Dal-Tile, Dallas.



423. Glazed wall-tile program

Offered to the qualified professional, a 14- by 18-in. chest holds glazed-ceramic wall tiles in over 90 different colors from 12 lines. Also available is a kit holding 50 different colors of porcelain mosaics. Monarch Tile, Inc., Florence, Ala. ■

New Products

Continued from page 35



316. Wright task. Designed in 1937 for the S. C. Johnson Wax Company's offices, FLW's desk has three cherry-wood work surfaces: writing level, typewriter height, and a raised shelf that conceals a task light. Licensed reproduction by Cassina S.p.A. Atelier International, Ltd., New York City.

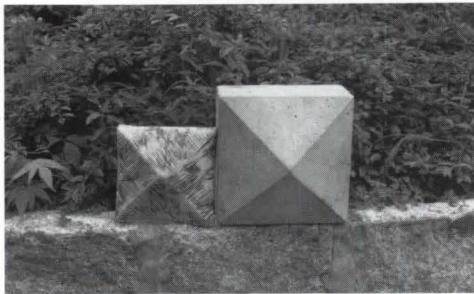

317. Three-dimensional. Frost-proof Pyridium units give a decorative accent to flat masonry walls. The 6- by 6-in. tile (left) comes in different colors and patterns; the 7 5/8-in.-high block, modular with most bricks, can also be ordered in glass block. Pyridium Block & Tile, Stamford, Conn.

Manufacturer Sources

For your convenience in locating building materials and other products shown in this month's feature articles, *RECORD* has asked the architects to identify the products specified.

Pages 78-83

Center for the Arts, Albright College
 Adèle Naudé Santos and Associates, Architects
 associated with Jacobs/Wyper, Architects
 Tan brick: Belden Brick Co. Glazed block: Stark
 Ceramics (Millenium Series). Windows: Modu-Line
 Windows, Inc. Butt-glazed curtain-wall: designed
 by Jacobs/Wyper, fabricated by National Glass.
 Membrane roofing: Firestone Building Products
 (Rubbergard). Fascia: custom design, fabricated
 by Merchant & Evans, Inc. Tempered glass: Fal-
 coner Glass Industries. Expanded metal screens:
 McNichols Co. Cylindrical downlighting:
 mcPhilben. Recessed downlighting: Lightolier,
 Inc. Entry: Lupton, Inc. Door pulls: Hiawatha,
 Inc. Colored concrete columns: M.A.B. Inc.
 Sealants: Pecora, Inc.

Pages 84-89

Lynn Goode Gallery
 Carlos Jimenez Architectural Design Studio,
 Architect
 Exterior and interior acrylic stucco finish: Thoro
 System Products (Thorocoat). Galvanized-steel
 panels: Berridge Mfg. Co. Shingle roofing: Owens-
 Corning Fiberglas Co. Aluminum windows:
 KaiserHoff Windows. Doors: Lone Star Door Co.
 Locksets: Schlage. Hinges, closers: Stanley. Pulls:
 Forms+Surfaces. Paints: Benjamin Moore & Co.
 Exterior fixtures: Hubbell; Red Dot. Low-voltage
 suspended lighting: TransLite Systems. Elevator:
 Inclinor Co. of America.

Pages 90-97

Islamic Cultural Center
 Skidmore, Owings & Merrill, Architect
 Copper dome, elastomeric roofing, and tile pavers:
 A. Munder & Sons. Fencing: County Fence. Archi-
 tectural metal panel system: Eastern
 Architectural Systems. Fritted and other glass:
 Falconer Industries. Bronze-clad entrances: East-
 ern Architectural Systems. Ceramic and Stony
 Creek Granite tile: Atlas Tile & Marble Works.
 Prayer-hall chandelier: designed by Fisher
 Marantz, fabricated by Bergen Art Metal Works.
 Light sources: MR16s. Column-top fixtures: de-
 signed by Fisher Marantz, fabricated by Bergen
 Art Metal Works. Sources: 24W compact fluo-
 rescent. Gold leafing: Polly Wotherspoon.

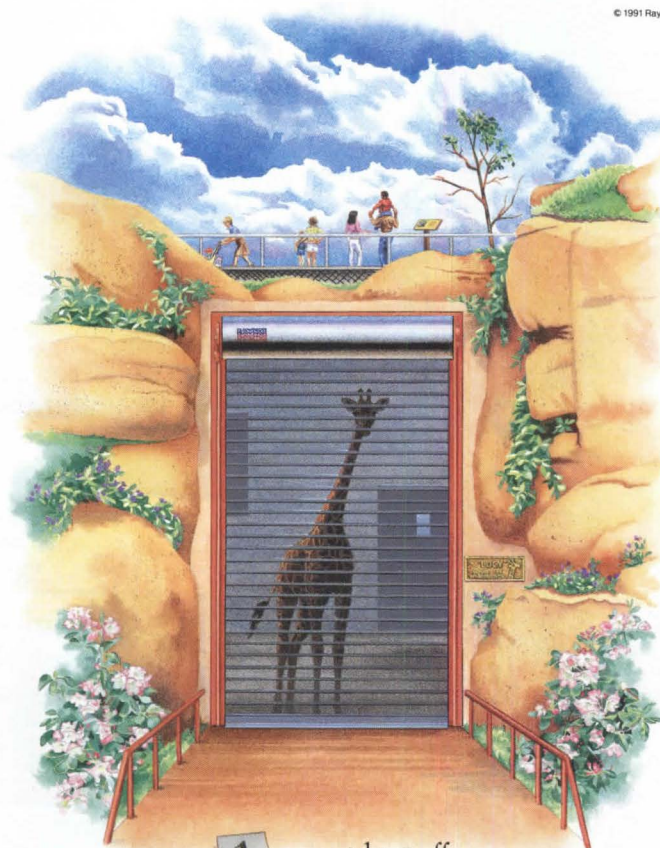

1 year, eight giraffes,
 one Raynor Perforated Slat Service Door,
 one Raynor Distributor.

RAYNOR PERFORATED ROLLING DOORS

There's no way to predict what unusual things will go behind a perforated rolling slat door. So it's smart to specify Raynor...because nothing stands as tall behind a Raynor Door as a Raynor Distributor. To locate the one nearest you, call 1-800-545-0455.

Circle 37 on inquiry card

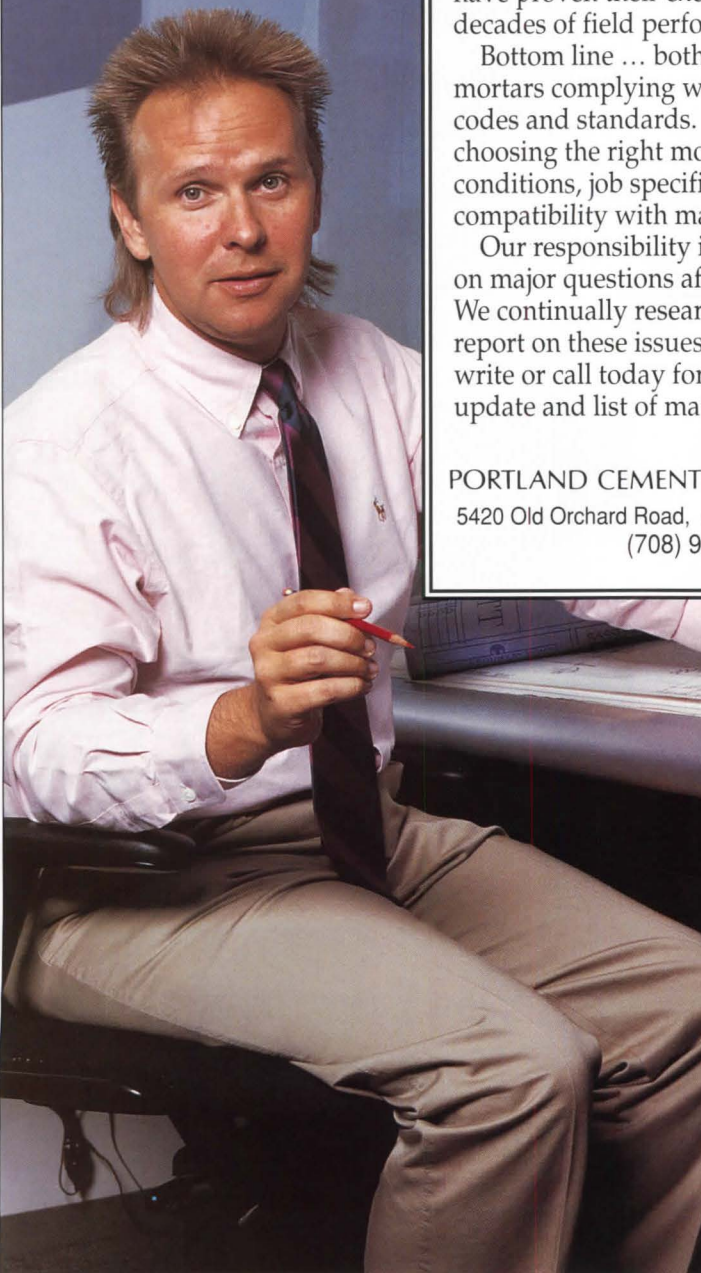

"I specify portland cement-lime mortars for strong, watertight walls."

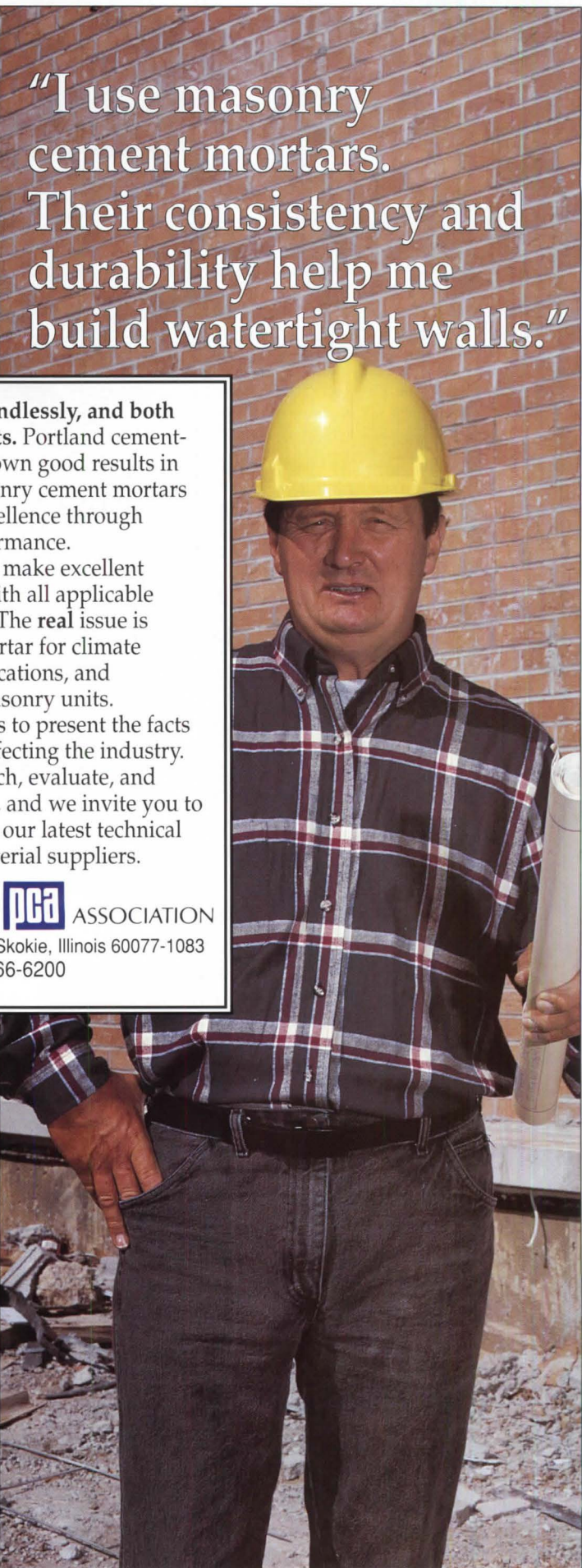

"I use masonry cement mortars. Their consistency and durability help me build watertight walls."

The debate goes on endlessly, and both sides have their points. Portland cement-lime mortars have shown good results in laboratory tests. Masonry cement mortars have proven their excellence through decades of field performance.

Bottom line ... both make excellent mortars complying with all applicable codes and standards. The **real** issue is choosing the right mortar for climate conditions, job specifications, and compatibility with masonry units.

Our responsibility is to present the facts on major questions affecting the industry. We continually research, evaluate, and report on these issues, and we invite you to write or call today for our latest technical update and list of material suppliers.

PORTLAND CEMENT  ASSOCIATION
5420 Old Orchard Road, Skokie, Illinois 60077-1083
(708) 966-6200

INSTALLING VELUX® ROOF WINDOWS AND SKYLIGHTS IS SO SIMPLE EVEN A MOUSE CAN DO IT.



The new VELCAD™ software is not only easy to use, but also quick, efficient and flexible as well. Operable with or without AutoCAD®, this new software enables users to edit our drawings and specifications with the touch of a button. And with standard features such as built-in editors and a memory like that of an elephant, it's the only software your firm will need for specifying the best roof windows and skylights made in the world. VELUX®. For more information call us at our toll-free number, 1-800-283-2831.

VELUX®

The World Leader in Roof Windows and Skylights

With SHEETROCK First Coat

Without SHEETROCK First Coat

See the beautiful difference that SHEETROCK® First Coat can make.

SHEETROCK First Coat has a unique latex formula designed to provide a superior prime coat in drywall decorating. To keep joints and fasteners from showing through decorated surfaces, both porosity and texture differences between the gypsum panel face paper and the finished joint compound must be minimized. Most primers and sealers will equalize either texture or porosity, but not both.

SHEETROCK First Coat does equalize both, minimizing joint banding, photographing and costly callbacks. To get the job done right the first time start with SHEETROCK First Coat—the fast, economical drywall prime coat.

For more information, call 1-800-USG•4-YOU or write to:

United States Gypsum Company
P.O. Box 806278
Chicago, IL 60680-4124



Pictured above are two gypsum panels with a vertical joint in the center properly finished with a conventional joint treatment system. The top half was primed with SHEETROCK First Coat and painted with one coat of a quality paint. The lower half was not primed with SHEETROCK First Coat but was painted with two coats of the same quality paint. Notice the "joint banding" or "photographing" of the joint in the lower half of the photo.



United States Gypsum Company

©1992 United States Gypsum Company

Circle 64 on inquiry card



It Took A Little Doing, But We Final

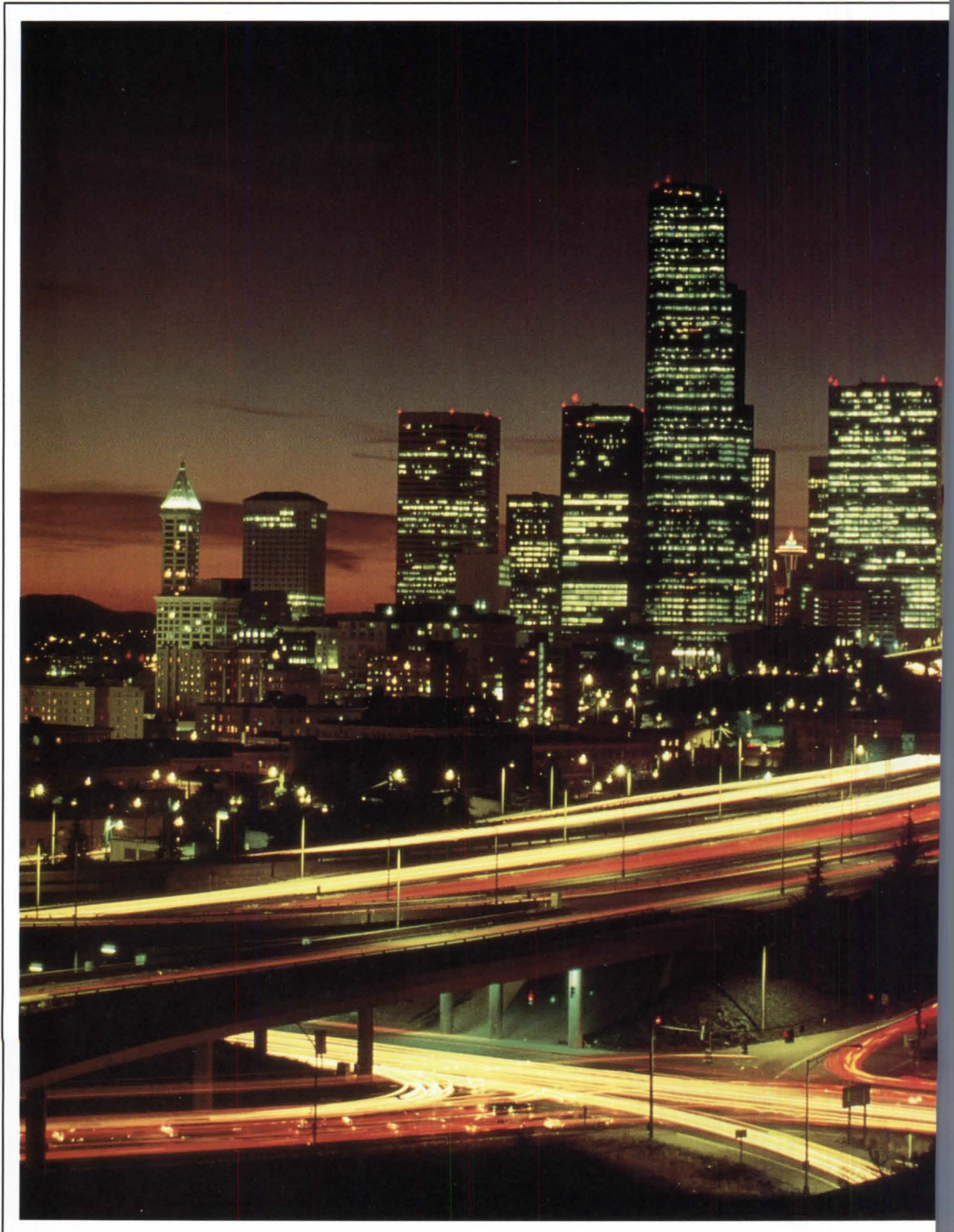

C-945 †Compared with standard F-40 white fluorescent lamps.

Architect Offices, Los Angeles 26

Altoon & Porter Architects
 Wheel Gersztoff Friedman Shankar Inc.,
 Lighting Designers

National Cathedral, Washington, D. C. 32

C. M. Kling & Associates, Lighting Designer

Three Nationwide Plaza, Columbus, Ohio 34

NBBJ Architects
 S. Leonard Auerbach &
 Associates, Lighting Designers

Family Dental Clinic, Reading, Massachusetts 40

Lawrence Man, Architect and Lighting Designer

Planet Hollywood, New York City 44

Charles Daboub Design, Inc.
 Lighting Designer

Lighting 2-D Art 48

Fine-art lighting requires a knowledge of equipment, sources and their characteristics, contrast and aiming angles. But nothing works like experience. *By James R. Benya*

Lighting Design News 9

Models Cry Out for Experiment/Low-Maintenance Emergency Power/Indirect Glow Drags Exhibits Out of Cave/Low-Light Levels Shield Infants' Eyes/E-Lamp Excitement/Lighting Designers' Group Honors Projects in U. S., Japan, Norway, Guam/Silent Light (from HID Sources) Shines Throughout Harold Washington Library Center/Cage of Light Tops Tallest Building

Lighting Product News 12

Decorative Elements/Linear Indirect

Lighting Technology and Design 14

Getting Objective Information to Lighting Specifiers, *By Russell P. Leslie, AIA*
 Landscape Lighting: Avoiding Voltage Drop, *By Jan Moyer*
 Compact HID—No Longer an Oxymoron, *By Lindsay Audin*

Editorial 25
Product Literature 54
Manufacturers' Sources 57

Advertising Index 60
Reader Service Card 61

Cover: *Family Dental Clinic, Reading, Massachusetts, Lawrence Man, Architect and Lighting Designer*
Lucy Chen, photo

Nike



CRYSTAL GAZING

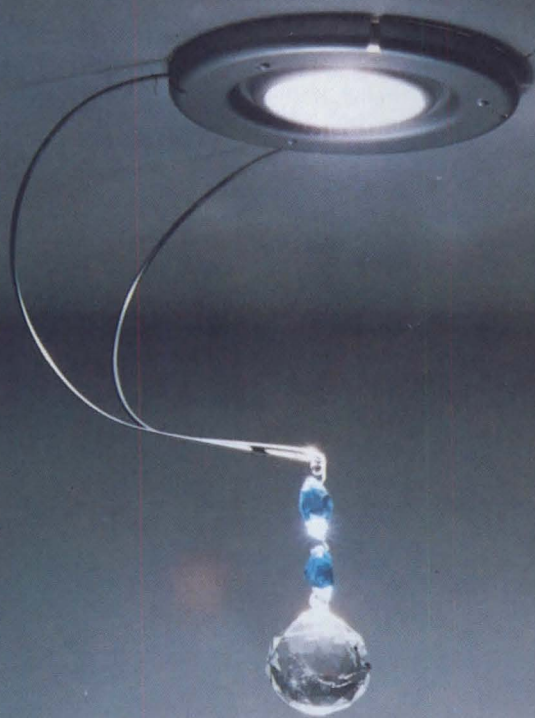

Recessed MR16 low-voltage halogen.
Part of the Milano-Torino Collection
by Toni Cordero and Pietro DeRossi.

Dite

Chicago 312. 644. 0510
Los Angeles 310. 837. 0179
New York 516. 694. 9292

Artemide®

The Netherlands

Models Cry Out for Experiment

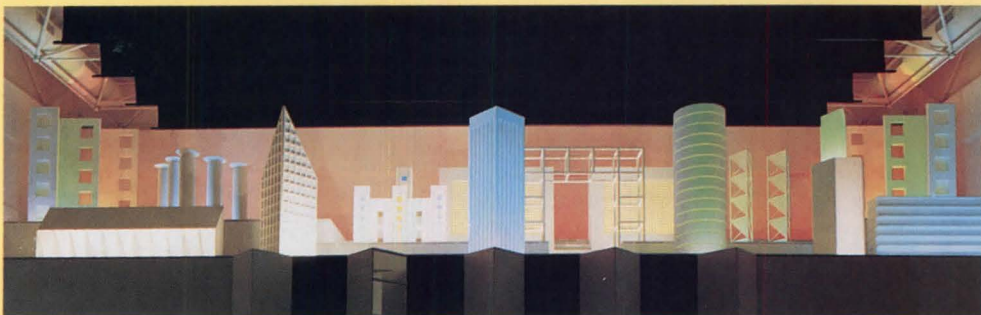
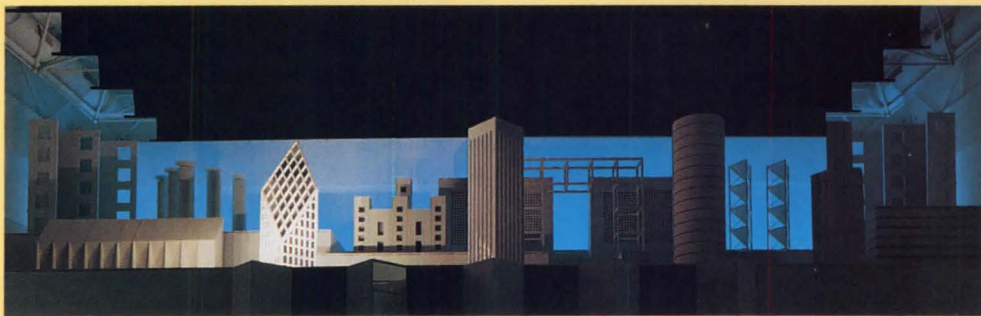

Europe's reputation for valuing fixture design over lighting design received a serious challenge with the recent opening of Philip's Lighting Application Center (LAC) in Eindhoven, The Netherlands. The center is packed with models that cry out for lighting experiment—full-scale retail shop and display window, supermarket, hotel lobby and guest room, restaurant and bar, offices, sports arena, factory workstation and storage, car-on-the-road, and a mini-skyline (above, showing three approaches to the same basic shapes). Many of the installa-

tions demonstrate light's ability to push a project up or down market. Geared toward multicountry design professionals, and away from product promotion, the LAC features a theater where the basics of vision and light are "performed." A lamp room contains sample cases of pop-up origami shapes for explorations of color, texture, and form. The sports facility provides fixtures for both on-site viewing and TV cameras. Throughout the LAC, surface colors of white, gray, and black insure that light remains the subject rather than merely a medium. ■

Atlanta

Low-Maintenance Emergency Power

To help bring in an ambitious design on a tight budget, Atlanta's Roswell Library employed a self-monitoring, self-testing central inverter system powered by real lead calcium batteries to provide emergency back-up power for security lighting fixtures and exit signs. Inverters use frequency-stable, low-power oscillators to convert battery DC to emergency power AC. For a mid-size facility like the 22,000-sq-ft Roswell, an inverter system fills the gap between individual battery packs and independent generators. A continuously self-monitoring feature performs routine diagnostic/discharge maintenance cycles in accordance with specifications programmed into the system's logic circuitry. Audio and visual alarms signal if the unit exceeds tolerances or fails. An electromechanical relay controls start-up and shut-down. A low-voltage disconnect circuit protects the batteries from damage during prolonged utility failures, and a time-delay circuit holds the unit in emergency operation for 15 minutes after resumption of utility service. While initial costs for the inverter system were higher than for unit equipment, a cost analysis showed the inverters require far less routine maintenance. "Battery packs and generators would have required significantly more regular maintenance," says Sizemore Floyd partner-in-charge Thomas M. Sayre. "The inverter system also offers greater flexibility in fixture options." ■



Indirect Glow Drags Exhibits Out of Cave



Before Lighting Integration Technology, Inc. got to work, the San Francisco Fashion Center exhibition hall was a dingy cave (above left) with uneven pools of color-shifted metal-halide light. With a six-week schedule and a \$1.25 per-sq-ft budget, LIT

© Jay Graham



used existing electrical feed points and suspended indirect tri-phosphor bix lamps on 30-ft centers in 250-ft runs (above right). Lighting power density is 1.5 watts per sq ft. The lamps should save \$10,000 a year in replacement and maintenance. ■

Philadelphia

Low-Light Levels Shield Infants' Eyes

Indirect and low-level lighting protects the vulnerable eyes of premature infants at the new intensive-care nursery at Pennsylvania Hospital. The general light level averages 30 fc—half the level recommended to avoid retinopathy of prematurity, said to blind between one and two percent of all premature infants each year.

Double-switched six-lamp pendant fixtures that provide illumination at one-third, two-thirds, and full strength, can reduce the level another 50 percent. A continuous headwall system incorporates uplights and separately switched downlights that provide 70fc of task illumination adjacent to warmers and isolettes for use only when someone is attending to an individual child. Portable luminaires provide supplementary lighting for special procedures. Window shades control daylighting. To avoid color reflectance that could interfere with observation of the infants' skin tones, neutral colors cover the walls nearest them. Lighting design principal Al Borden of the Lighting Practice says the calm atmosphere also avoids aggravating the anxieties of parents. ■



© Tom Bernard

E-Lamp Excitement

The 20,000-hour E-Lamp that captured media attention back in June is basically a fluorescent using an electromagnetic energy coupler to produce high-frequency radio signals to excite internal mercury vapor. Developed by InterSource Technologies of Sunnyvale, California, the electronic package converts 115 VAC at 60 hz to 13.56 mhz, an efficiency that makes possible a small globular shape to capture light energy more compactly for a brighter appearance per lumen. Similar to compact fluorescents in price and energy use, it also eliminates darkening electrodes, separate ballasts, and will be available in up to 150W equivalents. Demonstration models have been used on dimmers, but the first generation of A- and R-lamps, to be distributed by Magnatek starting early next year, will not be dimmable. And despite publicity successes, the company still needs another \$50 million and hasn't signed any manufacturers. Nor are established lamp sources conceding the market. GE showed a radio-wave stadium lamp in Germany last year, and in May Philips introduced a 60,000-hour commercial "QL" lamp, which is due on the market early next year. . . "Electronic Ballasts," the first report in a series exploring lighting technologies, costs \$30 from Rensselaer Polytechnic Institute in Troy, New York (518/276-8716). The 1992 series—on fluorescent-power reducers, specular reflectors, occupancy sensors, and parking lot luminaires—costs \$90 a set. . . Lighting Research Institute funding has enabled the Illuminating Engineering Society of North America to donate its 53-volume Lighting Library to 11 IES student chapters and 19 lighting-education programs. . . Edison Avery Price received the New York Illuminating Engineering Society's first lifetime-achievement Richard Kelly Award. Price, who began designing and fabricating fixtures in 1935, worked with Kelly on the Seagram building lobby and the Four Seasons restaurant. He founded Edison Price, Inc. and Nulux. Kelly Grants went to Carrie Meinberg Burke to explore the dynamics of human subjects and objects; to Tina Fong to study the impact of daylight, dusk, and moonlight on consciousness, semiconsciousness and unconsciousness; and to Hank Forrest for a study on the effect of air pollution and moisture on the color of daylight. ■

New York

Lighting Designers' Group Honors Projects in U. S., Japan, Norway, Guam

IALD awards of excellence recently went to Jerry Kugler and Thomas Thompson for the Corning corporate headquarters, New York City (right), and Lauri Tredinnick and William Blanski of Hammel Green and Abrahamson for the 3M atrium, Maplewood, Minnesota (below, left). Citations went to Patrick Gallegos for the Puro Village theme park outside Tokyo (below, right); Francesca Bettridge and Carroll Cline for the Ohrstrom Library at St. Paul's School, Concord, New Hampshire; Craig Roeder for Health Park Medical Center, Fort Myers, Florida [RECORD LIGHTING, May 1992, page 56]; Jonathan Speirs, Graham Phoenix, Mark Majo of Scotland's Lighting Design Partnership for the Tower of Time (below, center), Oslo, Norway; and Lesley Wheel and Allan Leibow of WGFS Lighting Design for the Guam Okura Hotel, Tumon, Guam. ■

© Wolfgang Hoyt



Atlanta

Cage of Light Tops Tallest Building

A signature cage spun of aluminum and high-pressure sodium light tapers to a 90-ft gold-leafed spire atop Atlanta's—and the Southeast's—tallest building, Kevin Roche's recently completed 55-story Nations Bank Plaza. Newcomb & Boyd designed the lighting, using 88 wide-flood lamps of 1,000W each directed upward to shine through the aluminum tubes of the stepped-pyramid structure and pick out the soaring spire on the evening skyline. The tubes are painted "Atlanta Rouge," a custom color that matches the building's granite cladding. ■



Chicago

Silent Light (from HID Sources) Shines Throughout Harold Washington Library Center

HID lamps (far right) can be a noisy bunch to let into a library, but 4,500 fixtures, from 100W to 400W, provide silent light, at the Harold Washington Library Center, capturing the shadowless point-source glow common during the heyday of Chicago School architecture. Distracting HID buzz is cut by 2,500 ballasts (near right) that embed electromagnetic components in a sound-absorbing polyester-silica compound; each is modified to handle two fixtures. Richard Mailloux, A. Epstein & Sons, was lighting designer. ■

Beach & Barnes photos



Decorative Elements



308-a



308-b



310-a



309-a



309-b



309-c

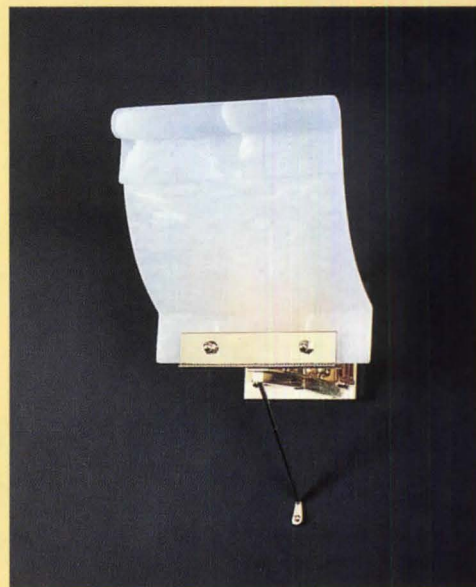

310-b

308. Snap in. Lamphoods by architect Matteo Thun work with King & Miranda's Expanded Line Network. These Archetto fixtures are aimable over a 360-deg horizontal/180-deg vertical arc, and accept color, UV, and infrared filters, diffusers, and Fresnel lenses. Lamping is bi-pin halogen and MR-16 dichroic. Flos, Huntington Station, N. Y.

309. Cabinet illumination. Low-voltage Magic halogen lights are designed to fit easily into kitchen cabinets and other furniture, adding sparkle as well as task lighting.

Plated reflectors minimize heat buildup, permitting direct recess into cabinetry panels (a); all components are UL-listed. Fitted spotlights come without trims (b) or with decorative face rings. Surface-mounted spots (c) pivot up, down, and around. Power from compact transformers is distributed via a universal surface-mount rail or concealed leads. Hettich America, Charlotte, N. C.

310. Alabaster sconce. Michael Graves based these small-scale fixtures on motifs derived from the Villa Kerylos in Beaulieu-sur-

Mer, France. Alabaster curved (a) and cornice profiles (b) about 8-in. high diffuse light from candelabra lamps. Baldinger Architectural Lighting, Astoria, N. Y.

311. Sconce-as-art. Visa's new wall lights (a) project only 3 3/4-in. and offer an interesting range of custom punchout-pattern and graphic options. The housing is like a shadow box, with a laser- or die-cut metal face set in front of the decorated backplate, illuminated by two 13W or 26W compact fluorescents. Sconce (b) is a more traditional style, with a

For more information, circle item numbers on Reader Service Cards.

Linear Indirect



311-a



311-b



312

shade of acrylic or glass held in a grid made of solid aluminum, brass, bronze, or copper. Lamping is one 27W Biax, or two 13W compact fluorescents. Visa Lighting, Milwaukee.

312. Chandelier. A glassblower's tour de force, VeArt's Gaia Parete 3 comes in shades of blue, red, and ruby. The seven-arm suspension light takes 60W clear or opaline bulbs. Artemide, Long Island City, N. Y.

313. Standing. Part of a new collection

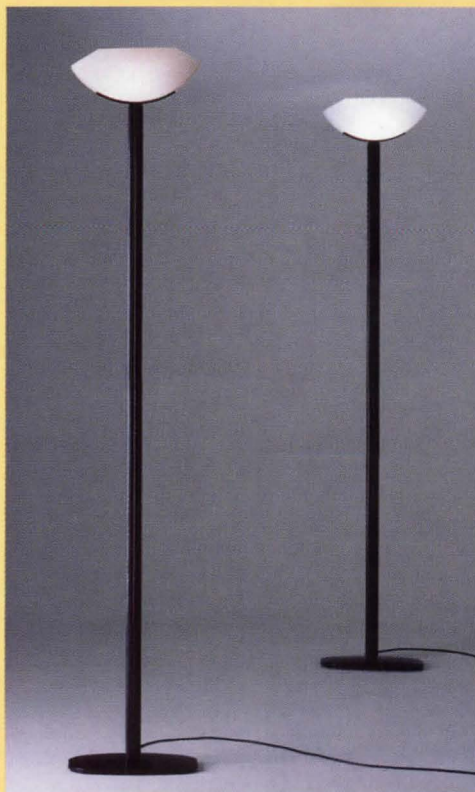

313



314

from PAF (renamed Italiana Luce in Italy), the Fenice floor lamp stands tall on a cast-aluminum base. Shade is Murano glass in white, pink, and wisteria; lamp is a 300W halogen. PAF USA, Stratford, Conn.

314. Art light. Targetti's new Picture Wand holds Minitondo lampheads in position to wash walls with light or accent artwork. Sturdy wands can be set at any point on the horizontal track. Fixtures take MR11s, MR16s, or bi-pin lamps. Illuminating Experiences, Highland Park, N. J.

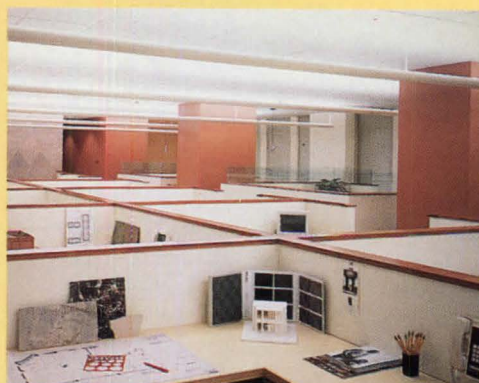

Huntsman Associates, Architect

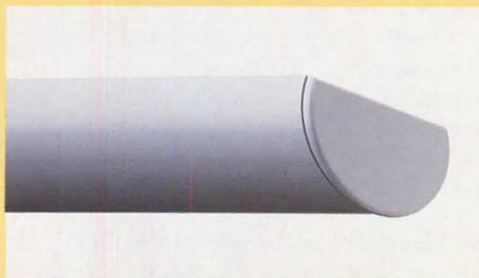
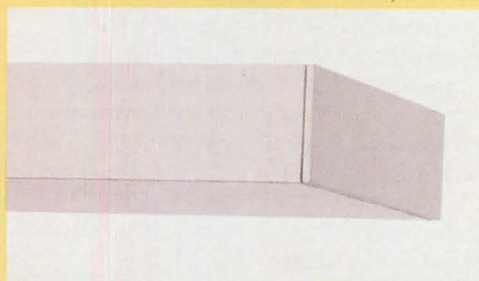

315. Cost effective. Peerless Lighting says its new Envision line is intended for those applications that require high-quality indirect illumination, but where budget constraints preclude specification of the manufacturer's top-of-the-line lensed-indirect product. The linear fixture is made of extruded aluminum in slim rectangular and rounded shapes only 3-in. deep. Cast-aluminum X, T, and L connectors allow right-angle configurations of 4-, 8-, 12-, 16-, 20-, and 24-ft-long modules; sections extend to any length with concealed internal fasteners. Finish options include eight paint colors offered for five-day shipment, with six others available. Five lamping systems, using T8s and F40BXs, address different illumination requirements; a lay-in dust cover can be supplied for healthcare applications. Peerless Lighting Corp., Berkeley, Calif. ■

Getting Objective Information To Lighting Specifiers

By Russell P. Leslie, AIA

Quality, energy-efficient lighting can mean opportunities for architects. Not only can appropriate lighting-product selection render spaces we design in the best possible light, but it can save our clients significant operating expense and provide environmental benefits for everybody. Electric-utility incentive programs, the U. S. Environmental Protection Agency's (EPA) Green Lights program, and the new energy codes demand efficient lighting installations.

But architects and lighting specifiers have been bombarded with information about lighting products from manufacturers, salespeople, utility representatives, advocacy groups, and lighting-service companies. The information comes in many forms, but it is often fragmented, incomplete, or not conducive to making product-to-product comparisons. What we need is help in navigating through this maze of data.

Help is here

In February 1991, at the request of government and electric utilities, the Lighting Research Center (LRC) at Rensselaer Polytechnic Institute convened a national roundtable of 26 experts from academia, research laboratories, manufacturers, consumer-advocacy groups, government, and electric utilities to address the need for efficient lighting-product information. The roundtable recommended the formation of the National Lighting Product Information Program (NLPIP), with the goal of dispensing complete and up-to-date information on efficient lighting products to lighting decision-makers. The roundtable also concluded that, to be effective, the information must be manufacturer-specific and in a format that can be easily understood by lighting specifiers, many of whom are not lighting experts.

Under the sponsorship of EPA, LRC, the Lighting Research Institute, the New En-

Russell P. Leslie is a practicing architect with Tect Associates, Shaftsbury, Vermont. He is also Project Director of NLPIP, Associate Director of the LRC, and Associate Professor of Architecture at Rensselaer Polytechnic Institute, Troy, N. Y.

gland Electric Companies, the New York State Energy Research and Development Authority, Northern States Power Company, and the Wisconsin Center for Demand-Side Research, NLPIP was started. This research and technology transfer effort is administered by the LRC, a not-for-profit academic institution dedicated to the advancement of lighting knowledge.

The usefulness of NLPIP depends on the objectivity of its publications. Several checks have been implemented to ensure the accuracy of NLPIP information. First, NLPIP is guided by a national steering committee. Second, a rigorous risk-management process has been implemented to guide the testing protocols. Text and testing procedures are developed by leading experts in the field, and both the testing protocols and the test results undergo extensive peer review before publication. Finally, no manufacturers may serve as sponsors or members of the steering committee.

NLPIP publications

NLPIP publishes information in two formats. The *Guide to Performance Evaluation of Efficient Lighting Products* cross-references performance issues, testing methods, regulations, and standards for products such as fluorescent lamps, reflectors, ballasts, and occupancy sensors. A glossary of lighting terms includes definitions for nontechnical readers. Product-performance-information sheets are provided for use in compiling information from manufacturers. Also included are directories to independent laboratories, other relevant lighting publications, and organizations and societies that develop and maintain lighting standards.

Specifier Reports are 10- to 12-page reports that provide an in-depth educational text and a combination of generic and brand-name performance information for a particular efficient lighting product. Performance data are displayed in tables, allowing easy comparison of different manufacturers' products. *Specifier Reports* on nondimming electronic ballasts, power reducers (or current limiters), and specular reflectors are available. Reports on compact-fluorescent lamps, parking-lot luminaires, occupancy

Photo courtesy of RPI Lighting Research Center



Lamps being tested for power quality through the National Lighting Product Information Program, administered by the Lighting Research Center, Rensselaer Polytechnic Institute, Troy, New York.

sensors, and exit signs are in progress.

Evaluation of lighting products is complicated. Product performance must be considered on three levels: the product itself, the way the components interact together, and at the architectural level where conditions such as building geometry, surface reflectances, and air-distribution systems may impact on the product's performance. Performance issues range from power quality to occupant satisfaction.

As the *Guide* clearly indicates, standardized tests do not exist for many of these performance issues. During preparation of a *Specifier Report* issue, the NLPIP project team develops interim testing protocols where no standardized tests exist. Data are gathered from manufacturers' literature, spot-checking, independent laboratory testing, field studies, computer modeling, mock-ups, and bench-top tests.

Manufacturers have been supportive of NLPIP, recognizing the importance of having their products listed in *Specifier Reports*, which are distributed to Green Lights Partners and many electric utilities. Some utilities use *Specifier Reports* as a basis for determining which products will be included in their lighting rebate programs.

For more information on NLPIP publications, contact the Lighting Research Center, Rensselaer Polytechnic Institute, Greene 115, Troy, New York 12180-3590 (fax: 518/276-2999). ■

Landscape Lighting: Avoiding Voltage Drop

By Jan Moyer

A previous column extolled the virtues of compact, low-voltage incandescent lamps for low-brightness landscape lighting. One of several reasons it is sometimes preferred over line-voltage lighting equipment is that its wiring doesn't give as great an electrical shock as line-voltage wiring if it is accidentally contacted. Because it is safer, low-voltage cables can be buried directly in the ground without conduit protection, although this makes the cables vulnerable to being cut.

The other slight drawback is that wiring for low-voltage circuits must be properly sized in order to avoid problems with voltage drop. Voltage drop is just what it sounds like: the voltage in a cable is at its peak where it connects to the power source (a transformer in low-voltage circuits) but starts decreasing as it moves toward the end of the cable. In low-voltage systems this can decrease the light output so much that it spoils the visual composition that is the very purpose of the lighting system.

For example, a 10 percent voltage drop between two lamps on a 12V circuit of improperly sized wiring would cause the lamps to have noticeably different color and brightness: the lamp closer to the end of the cable would give off dimmer, more orange light than the other. If voltage drop became truly excessive, there might be virtually no lumen output from a lamp at the end of a cable.

Loads and wire types

To determine the amount of voltage drop in a circuit, three things have to be determined first: the total wattage to be fed through the cable, the wire type and gauge, and the maximum distance from the power source to the end of the cable.

The first step is to choose a type of cable that is suited to the application: exposed above-grade, below-grade, in-conduit, or underwater. The simplest and least-expensive type is wire rated for in-conduit use and

Janet Lennox Moyer, IES, ASID, is principal of Jan Moyer Design, a Berkeley firm specializing in landscape lighting.

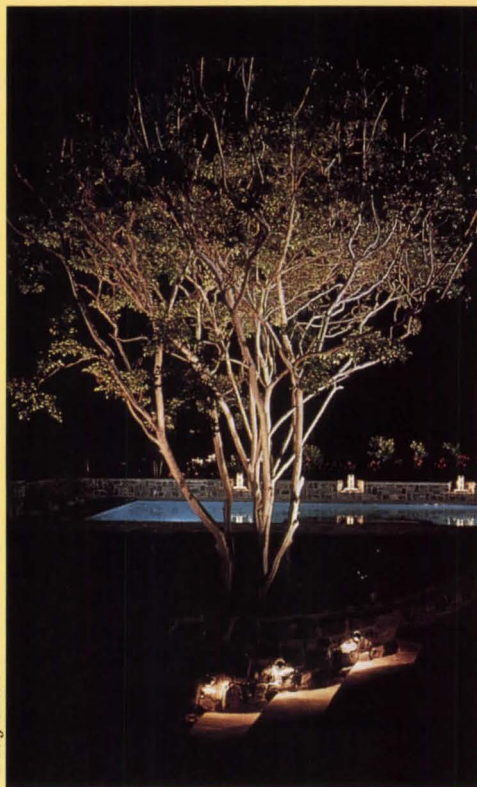

© Doug Stalin

Landscape lighting by Jan Moyer

would not be suitable for exposed use, like a cable feeding a fixture in a tree. All cables that are exposed above-grade must have insulation that is UV-resistant; below-grade wires need insulation that will protect it against biological attack, water, and corrosion.

The NEC rates maximum possible load on a wire based on wire size, temperature rating, and the material used for the wire and insulation. A 12-ga. copper THHN cable can carry 30 amps, a 12-ga. copper UF cable is rated for 25 amps, while a 12-ga. copper-clad aluminum cable can carry only 20 amps. Also, as the wire-gauge number decreases, the diameter of the wire increases, and can carry a larger load. Thus, a 14-ga. copper UF cable is rated for 20 amps, while an 8-ga. cable can take up to 40 amps. Ratings for various cable types can be found in NEC Tables 310-16 through 310-19, and Table 400-5(a).

Finally, once the transformers have been installed, determine the lengths of cables,

Calculating Voltage Drop:

The electrical load in watts times cable length in feet divided by the cable constant from the chart below equals the drop in volts, regardless of whether the circuit is 12V or 120V. For best results, voltage drop should not exceed 3 to 5 percent.

$$\frac{\text{Load in Watts} * \text{Cable Length in Feet}}{\text{Cable Constant}} = \text{Voltage Drop}$$

Cable Constant*	Wire Gauge
1380	18
2200	16
3500	14
7500	12
11920	10
18960	8

*Double cable constant for twin circuits.
Table data courtesy of Hadco Landscape Manual.

including the horizontal and vertical distances that may be involved. Don't try to size cable at the working drawing stage; field conditions may vary considerably from what you're expecting. Once you've determined the cable length, use the total wattage of each circuit and calculate the voltage drop using one of the guides listed in the references or the simple method shown above. Using one of the more conservative methods allows for future system expansion, when the owner wants to add fixtures to highlight a new sculpture or compensate for plant growth.

References:

"Electrician's Vest Pocket Reference Book;" Prentice Hall

"The Landscape Lighting Book," by Jan Moyer; John Wiley and Sons

"National Electrical Code;" National Fire Protection Association

"Ugly's Electrical References;" United Printing Arts ■

Compact HID: No Longer An Oxymoron

By Lindsay Audin

High-intensity discharge (HID): it conjures up images of industrial fixtures suspended from roof trusses of aircraft hangars. Now this efficient family of light sources has spawned diminutive offspring known as "compact HID." When properly integrated into new downlights, trackheads, and retrofit kits, they can replace incandescent lamps having three or four times their wattage, with little or no loss in illumination levels.

While no lighting lexicographer has ruled on it, what distinguishes a compact source from others seems to be wattage, under 175 watts per lamp, as well as the use of an external starter or ignitor. Most larger HID lamps have built-in starters. Therein lies one of this system's design limitations: the ballast powering the lamp that holds the starter, due to the high voltage involved, can't be more than a few feet from the lamp.

All the major lamp manufacturers have contributed new choices for the lighting designer's palette. High color rendering "white" high-pressure sodium lamps use 100 watts or less, and metal-halide lamps are found in the 70W to 150W range. Other members of the HID family—mercury vapor and low-pressure sodium—are excluded because of limits in efficacy or color rendering in these lamp types.

As with all sources, interaction with the fixture and the space must be considered during the design phase. While color rendering is good, color temperature choices are limited and may not be suited to merchandising, unless supplemented by other sources. Compact HID is fast becoming an option, however, as designers begin to meet new energy codes.

As with other HID sources, a ballast is needed to condition line voltage to the needs of the lamp. Their size—some are larger than fluorescent lamp ballasts—may limit location or require extra installation labor. A compact HID sconce may require excavation into a wall to hide the ballast, or a decorative enclosure may be needed. Several smaller

Lindsay Audin is energy manager for Columbia University.

electronic ballasts are coming to the market, and one is available for 70W double-ended metal halides. In a few cases, the ballast components—starter, transformer, and power controller—are separate. This allows some latitude in location and fixture design.

When locating the ballast, carefully consider maintenance, fire codes, and ballast temperature requirements. NEMA enclosures are available for most ballasts, but are rarely acceptable without an architectural covering. Note also the allowable noise level of the space: not all magnetic HID ballasts are rated Type A (the accepted fluorescent noise rating). Those containing a starter should have an automatic cutoff that stops firing the lamp after a burnout. Otherwise, the ballast may self-destruct in a few days.

When replacing high-wattage incandescent fixtures, look closely at the glare potential. Be wary of HID fixtures smaller than those existing. Compact HID lamps generally have a bigger luminous source, requiring a deeper fixture to shield it from view and a larger reflector to focus the light. HID track heads are larger and heavier than their incandescent ancestors because they also contain their ballasts; be sure the track is well secured. Was the fixture designed to handle this source? Some manufacturers have simply loaded HID lamps into existing incandescent housings instead of designing appropriate chassis. The result: a high-efficiency lamp in a low-efficiency fixture—with high glare, poor control, and insufficient lumen output to do the job.

As with larger HID sources, color will shift over the lamps' lifetime. This shift is minimized when the 70W electronic ballast is used. Other ways to minimize this problem:

- Replace lamps at 70 percent of rated life.
- Use indirect fixtures that mix their light with other sources having more constant color output.
- Avoid mixing different color temperatures near one another (e.g., use metal halides near "cool" fluorescents, and white HPS near "warm" incandescents). Any variations will then be less noticeable.

All HID sources, large and compact, take time to come up to full output, and some-

HID fixtures have spawned diminutive offspring—compact HID lamps.

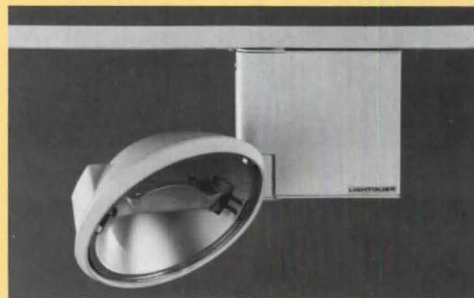

Courtesy Lightolier, Inc.

times longer to restrike after a power interruption; include "instant on" sources in the same area or fixture. Instant restrike HID is becoming available, but is limited—and expensive.

Metal-halide lamps can burst under certain circumstances, and routinely emit a high level of ultraviolet light, which is detrimental in some applications (e.g., museums). Damage to the lamp's envelope may result in UV severe enough to harm eyesight, so choose a lamp designed with a safety envelope or a fixture with a lens that limits UV output.

While lamp life of compact HID sources is longer than the incandescents they replace (5-12,000 hours versus 1-2,000 hours), HID lamps are considerably more expensive. Savings in relamping labor will exceed the increased lamp cost, but prepare the client for "sticker shock" when it's time to buy a new batch: compact HID lamps cost over 10 times as much as high-wattage incandescents. Include a few replacements with the job; few lamp vendors stock every new lamp.

Forget about dimming; it's limited to about 40 percent, and at a relatively high cost (some users have also detected early color shift, but the jury is still out).

As with all new technologies, there has been a "break-in" period for compact HID. One lamp was temporarily withdrawn due to technical problems, and others lack a sufficient track record to convince hardened skeptics. But we have had good success with two types of white HPS lamps and smaller metal halides, cutting wasted watts by 65 percent and burnout rates by even more. ■

Anybody Got a Light? (Preferably a 3000K 13W in Compact Fluorescent?)

One of the biggest risks a lamp manufacturer takes is in introducing a new, specialized-application lamp. They share this risk with luminaire manufacturers, who have to be convinced there is a big enough market for fixtures that will incorporate the lamp. And finally, lamp manufacturers share the risk with the most important people of all, the customers, designers, and building owners. These are the people who risk designing or owning a project that will become a lighting disaster if specified lamps become obsolete.

I bring this up because it would have appeared that the risks in specifying compact fluorescent lamps had virtually vanished due to falling cost, energy codes, and ever-increasing market acceptance. Yet recently, one manufacturer discontinued its 3000K 13W twin-tube compact fluorescent lamp due to slow sales. This has upset lighting designers who have built large, highly visible projects around that manufacturer's family of 3000K fluorescent lamps. Now the owners of these projects will have to substitute 2700K or 3500K lamps, whose color obviously doesn't match the rest of the lamps in the buildings. Designers say these replacements are inferior, especially in retail. With the 3000K lamp gone (check it out—it truly was the best complement for quartz halogen lighting) one wonders, what other great lamps might be on their way out, too?

Evolution in lamp technology proceeds at a rapid pace. And surely we will see many favorite energy-hungry incandescent lamps going the way of the dinosaur during the coming years as energy codes eliminate them. One even has to wonder with the dawning of the E-lamp if the 13W 3000K twin-tube is only the first of its kind to go?

The business pressures that put lamps on the market and pull them off again are extremely intense, so intense that designers can probably do very little to keep a lamp they like from being phased out if demand never develops or drops below a certain level. But because getting designers to take a chance on a new lamp is part of the process of gaining market acceptance for it, manufacturers must encourage the risk-taking behavior of designers and owners. That, in its very essence, means not burning them by suddenly phasing out a lamp type like the 3000K 13W twin-tube that by all appearances is going to be around for a while. For designers, the flip side of the coin is this: if you like it, spec it.

Otherwise, it might be gone. *Charles Linn*

Paper Clouds



Drywall, seemingly as insubstantial as paper, reflects light in these architect offices.

*Architect Offices
Los Angeles
Altoon & Porter Architects
Wheel Gersztoff Friedman
Shankar Inc.,
Lighting Designers*



By Gareth Fenley

Altoon & Porter's design for its own offices makes clear that the firm is quartered only as a tenant. An interrupted ceiling of suspended drywall panels is one element establishing the separation of interior from structure. "We were moving into a Class A office building that was culturally as far away as possible from the impression we wanted to create," recalls Ronald Altoon, partner-in-charge of design. "Therefore, we had as a parti that the space would be detached from the building. But we wanted a fairly disciplined and obedient scheme. We didn't want to apply the by-now tiresome clichés of angles and curves arching through the space that architects use when they are their own clients—and sometimes impose on others."

Thus arose the idea of the detached ceiling floating overhead. To make it come alive, as well as to serve the function of providing superior ambient light for work in a design studio, the architect made the ceiling integral to a custom indirect-lighting system. Lighting consultants Wheel Gersztoff Friedman Shankar (WGFS) were called in to collaborate on its development.

The system as built uses very few custom-fabricated elements, according to project architect James Auld. "There was originally a more complicated scheme that evolved through countless generations," says Altoon. "In the process of negotiating the tenant allowance, the lighting scheme had to become much more succinct. I think that improved it by making it irreducible."

To create a vaulted effect, many of the 10-foot-wide ceiling panels of 5/8-inch gypsum board are curved. The designers studied the material and selected a curvature very close to that which it would take under its own weight. Appropriate support members were custom fabricated of 1 1/2-inch cold-rolled channel steel. They were suspended from the ceiling deck and made rigid with supports every 12 inches on center, with panel edges to be cantilevered 8 inches all around. The contractor then lifted the panels into place and secured them with drywall screws every 4 inches. The finished panels were painted white below and black on the upper surface of a 45-degree beveled edge; as a result, they look paper-thin. "People can't guess what the ceiling is," comments Auld. "They think it's fiberglass or some kind of fabric."

Achieving the insubstantial effect was costly. In contrast, to install the panels flat required no custom parts, half as many supports, and an even smaller fraction of labor. Thus, it is not surprising that project cuts included flattening the panels in the spacious design studio. "I'm not at all disappointed in the result," says Altoon. "It creates a crispness in that room, because the flat panels relate well to the walls." (Continued on page 30)

Alan Shaffer



A functional indirect-lighting system in this architectural office also makes an esthetic statement. Above is the main entrance as seen from outside in the public corridor. Panels in the reception area and gallery (right), conference rooms, and partners' offices were curved as shown in the concept sketch below, but were hung flat in the design studio to reduce cost. Custom valances (fluorescent wall fixtures) designed by Allan Leibow of WGFS were introduced by the lighting designer to improve the balance of brightness in rooms such as the gallery.

reflector
continuous
fluorescent uplights

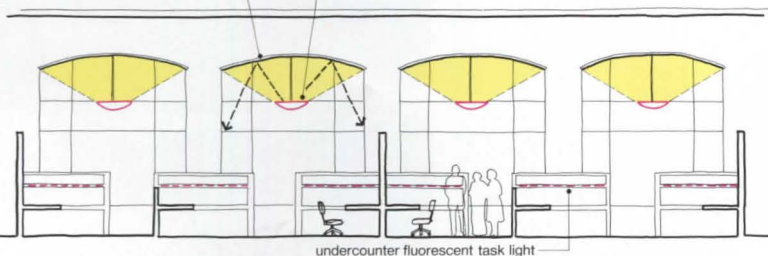



Whether flat or curved, the ceiling panels serve as reflectors to distribute 3500K triphosphor fluorescent light. The custom fixture's functional parts could hardly be simpler: an industrial four-lamp strip, a steel channel, rods, and bolts. The only high-ticket item was a decorative, custom-perforated aluminum scrim. In some of the fixtures, the scrim has apertures for fully adjustable MR11 low-voltage accent spots. An unusual, attractive iridescence is created by the light refracting out the back of the lamp's dichroic filter and onto the scrim.

After collaborating with the architects on conceptual development, WGFS designers worked out the distances between lamps, reflective panels, and room surfaces to get just the right amount of indirect light. "We took cues from the geometry and form of the architecture as we studied and restudied the optical performance of the lighting system. The lighting is integrated within the architecture rather than applied," says Allan Leibow, project designer for WGFS. "The composition is what's so wonderful. I don't know that any single part of the design is highly special, but the composition of lighted walls, lighted ceilings, and accent lights makes a superb total design."

Gareth Fenley is an Atlanta-based writer and a frequent contributor to ARCHITECTURAL RECORD LIGHTING.

The office's lighting fixtures are built of simple, standard components augmented by custom shrouds for the valances and custom decorative scrim for the uplights. The indirect system spreads uniform light even into private offices, since partitions are glass from 9 feet up. Opposite are the gallery (top left); entrance to a partner's office (top right); design studio (middle left and bottom left); a partner's office (middle right); and a senior associate's office (bottom right).

Credits

Architect Offices
Altoon & Porter Architects
Los Angeles
Architect: Altoon & Porter Architects—Ronald A. Altoon, partner/design; Harvey R. Niskala, partner/administration; James C. Auld, project architect; Hendra Kusuma, CADD manager
Lighting Designer: Wheel Gersztzoff Friedman Shankar Inc.—Babu Shankar, partner-in-charge; Allan Leibow, project designer
Mechanical Engineer: Tsuchiyama & Kaino
Electrical Engineer: Frederick Russell Brown & Associates
General Contractor: Howard Rosenfeld Inc.

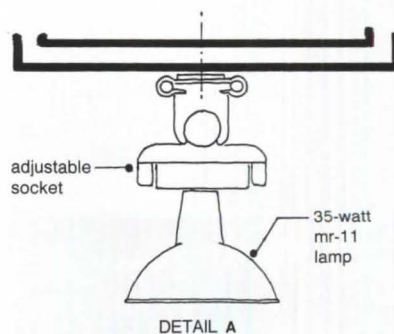
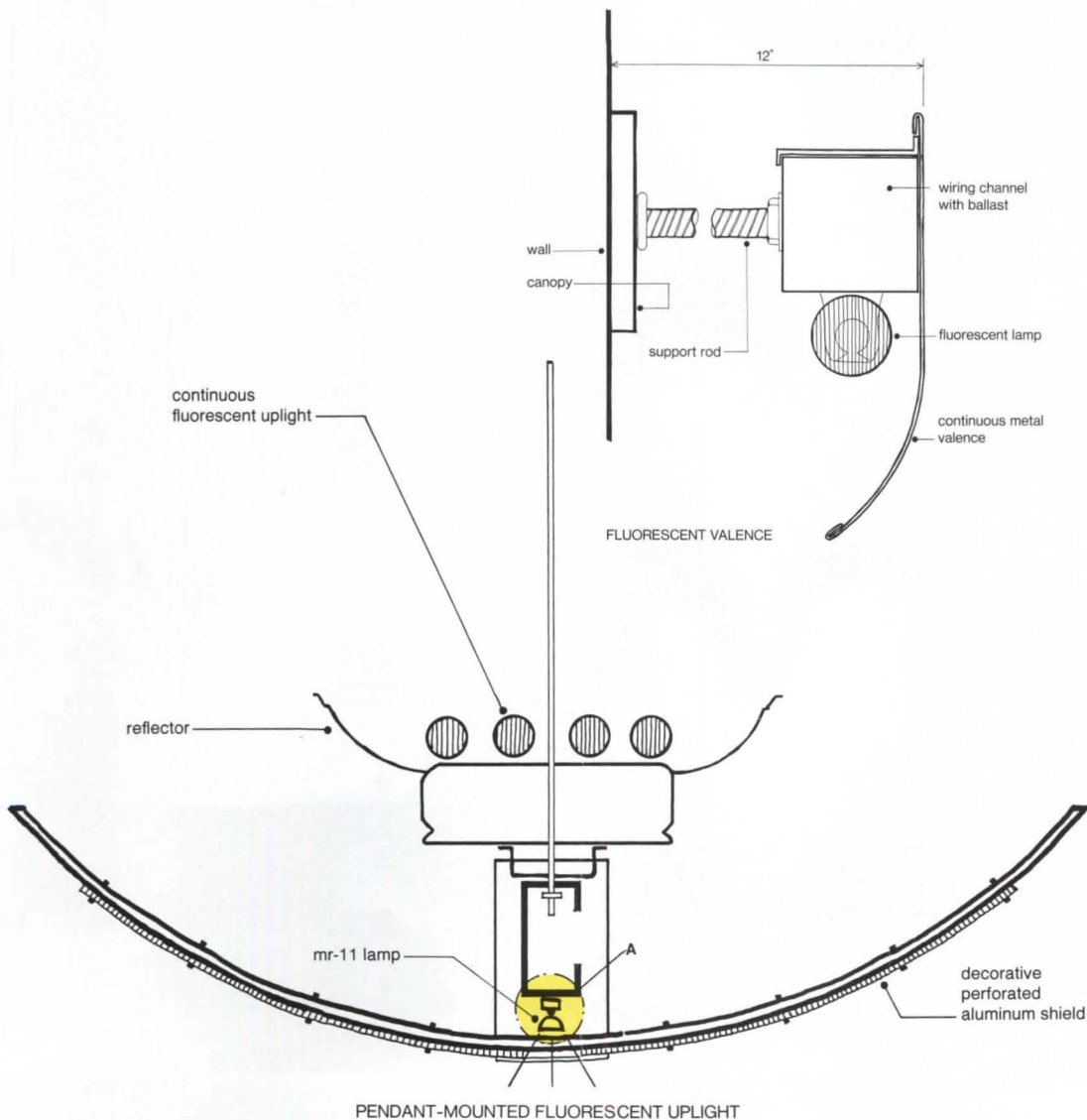



High Lighting

*National Cathedral
Washington, D. C.
C. M. Kling & Associates,
Lighting Designer*

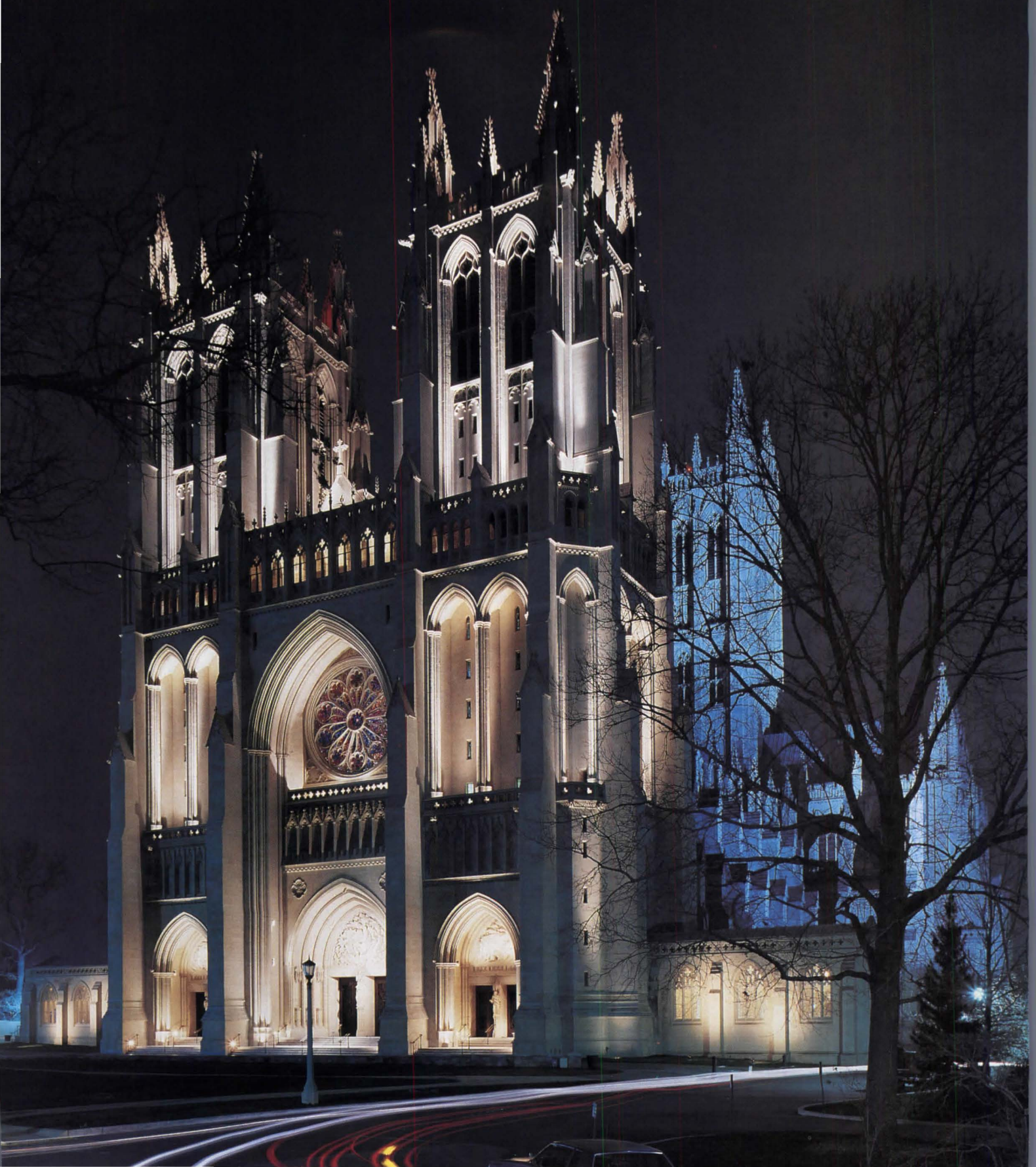

An eternal sunset in October lights the west entrance front of the National Cathedral every night of the year. Except the sun is not shining down as the client originally wanted, but up. "We're not God," observes C. M. Kling head Candace Kling, whose firm had to cope with a number of daunting restrictions and requests in its illumination of this second-largest Gothic-style structure in North America. Among them: drama with subtlety, concealed but not remote sources (all fixtures on or immediately adjacent to the building), easy and minimal maintenance, low energy use, and a budget of \$125,000, which included drilling through stone to hide wires.

An anonymous donor funded the project in honor of the building's recent completion after some 85 years of construction. George Fredrich Bodley and Henry Vaughan produced the original plan. Frohman, Robb & Little picked up the work in 1907 and Philip Hubert Frohman, long surviving his partners, continued the work until recently. An early illumination of the entire structure was done with metal-halide lamps, which lack any attempt at color correction and produce a harsh blue light (background of photo opposite).

The October evening was the idea of the now-retired Canon Clerk of the Works, Richard T. Feller, who represented the Episcopal Bishop. To achieve this effect, the designers first directed Feller all over the Capital to examine the most popular outdoor illumination techniques: high-pressure sodium, which was too yellow, and metal halide with colorcorrection, which still lacked warmth and was difficult to keep stable in color and to dim. "The bright lighting on the Washington Monument was not properly spiritual," notes Kling. The final decision: incandescent. Next came a mockup (complete with orange extension cords dangling over the facade) to test fixture locations for effect and the desired concealment. This resulted in 121 lamps of just three types (120PAR56VNSP, 90PAR/FL/H, Q150-PAR38FL), most in standard can-on-stem fixtures, all dimmed a minimum of 50 percent from their average 126-watt maximum brightness. Not only did this produce the desired subtlety, but a favorable operating and initial cost comparison with other types of light that could not be dimmed without reduced bulb life. (Lamps need be replaced only in two-year cycles; most access is without ladders.) Estimated energy costs for the 7.63-kw-per-hour, five-hour nightly operation is \$1,043 annually.

The prohibition on remote lighting meant that the only outward wall faces that could be lighted were those at the base of the building (from flush-mounted uplights below grade) and those on the towers (from cans behind the parapet). Much of the lighting is within the tall recesses, which answered an initial design problem: While the light could not shine down as initially thought necessary to produce a desired dramatically spiritual effect, it could emphasize verticality and give an increased sense of depth. Interior lighting behind the 60-foot-diameter rose window and in the viewing gallery above (affording views of several states) is coordinated to go on with exterior lights. The lighting program has been such a success that a campaign is now under way to raise funds for relighting the entire structure. *Charles K. Hoyt*

Credits

*National Cathedral
Washington, D. C.*

Lighting Designer: *C. M. Kling and Associates, Inc.
Michael Janicek, Candace Kling, Peter A. Hugh, designers*

Electrical Engineer: *Leach Wallace Associates, Inc.*

Electrical Contractor: *Primo Electric Contracting*

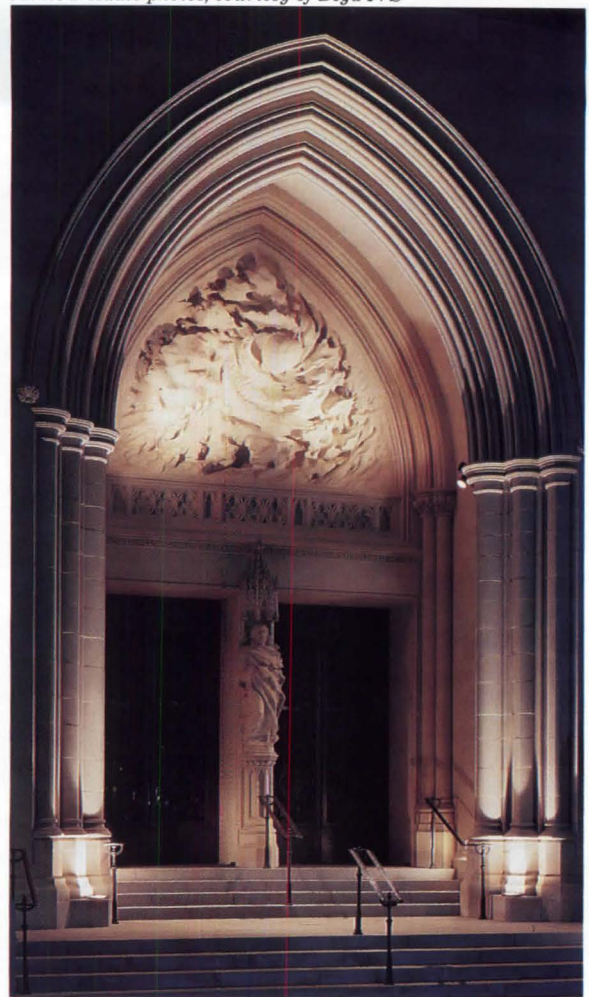

Occupying the highest point in the Capital, the cathedral is visible for many miles. Until recently, when the current lighting program was started, it was bathed in an unmodulated blue light (background) that was neither welcoming nor celestial. Above: new lighting around the 15-foot-high main doors where two of the few visible sources are recessed into the stone.

Tropical Light



*Three Nations Plaza
Columbus, Ohio
NBBJ Architects
S. Leonard Auerbach &
Associates, Lighting Designers*



The owners of Three Nationwide Plaza wanted to create an extraordinary tropical garden in the atrium of their new office building that could be used for lunch and relaxing breaks during the day and for social functions at night. Patricia Glasow of S. Leonard Auerbach & Associates designed two lighting systems for the space. One is a horticultural lighting system that floods planted areas with the massive amounts of light needed to maintain the plants' health. The second is an incandescent system employed when the atrium is used for after-hours events.

Keeping the tropical plants healthy was a top priority. "We started by working with the landscape architects and the horticultural consultant, establishing zones that would be lighted according to the footcandle-hour requirements for the plants there," says Glasow. "You can't just say, 'this plant needs so many footcandles,' because the duration the light is on is just as important as the lighting intensity."

Providing high light levels to the plants without creating severe glare demanded an intense, spectrally balanced light source in a fixture with tight beam control. Metal halide is typically used, but this can create a problem in fixture selection. "Usually people will go in with metal-halide high-bay fixtures or downlights, and just blast the whole atrium, because it's hard to find metal-halide fixtures that have narrow beams," says Glasow.

That requirement led Glasow to design a custom fixture. "First, we wanted it to be nice looking, because it's hanging out in the open, and we wanted it to have an architectural look," says Glasow. "We took the idea of a theatrical beam projector, which has a very compact beam, and found a tiny 400W double-ended metal-halide lamp to design the fixture around. That was the trickiest part, because you practically need a point source for a beam projector, or the reflector gets huge." The resulting fixture has a 20-degree beamspread, and provides 115,000 center beam candlepower. The fixtures are mounted on gantry rails parallel to the skylights in the atrium, and may be reached for relamping by means of a trolley used for washing the skylights.

Photometers placed throughout the atrium measure the amount of day- and electric light provided to the plants each day. This information is fed into a computer, which calculates how long the different fixture groups must be energized to give the plants enough light to thrive. Once enough footcandle-hours have been delivered to a plant zone—or the sun is delivering sufficient light—the computer will turn off that group of fixtures. To extend lamp life, the minimum on-time is four hours, and the minimum off-time is two hours. The computer can produce printed reports that detail the number of hours the fixtures are on, how many footcandle hours have been delivered, and the amount of kilowatt-hours consumed.

A second system of PAR 64 incandescent fixtures hung from the rails was also custom made. These match the metal-halide fixtures in appearance, and each has a lock-down feature that prevents the beam orientation from shifting when relamping occurs. This system shows off the planted areas and walkways at night. A low-voltage lighting system highlights water features, and adjustable spots are concealed in the atrium ground cover. A preset dimming system controls the incandescent fixtures, and is activated by an astronomical time clock. It is capable of providing 200 preset scenes.

Charles Linn



Artlog/D. G. Olshansky photos

Bringing the tropics to the Three Nationwide Plaza atrium in Columbus, Ohio, also meant designers had to come as close as possible to importing the tropical sun. The horticultural lighting system drenches the light-hungry species planted there with up to 12,000 footcandle-hours daily.





The custom metal-halide beam projectors (above, and drawings below) and PAR 64 spots are mounted on gantry rails that also support a trolley, which can be used for relamping or washing the skylights. The 400W beam projectors produce a 20-deg beam spread, and 115,000 center beam candlepower.

Credits:

Atrium

Three Nationwide Plaza

Owner: Nationwide Companies

Lighting Designer: S. Leonard Auerbach & Associates—Len Auerbach, principal-in-charge; Patricia Glasow, designer

Architect: NBBJ

Landscape Architect: Sasaki Associates

Horticultural Consultant: Chuck Powell

Electrical Engineer: Meyer, Strong & Jones

Electrical Contractor: Romanoff Electric Corp.

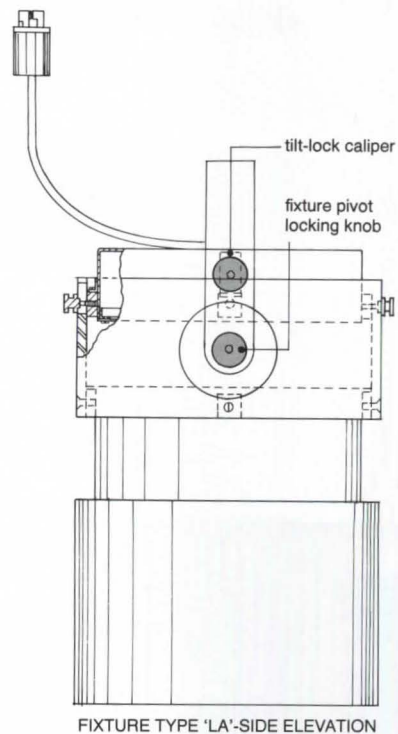
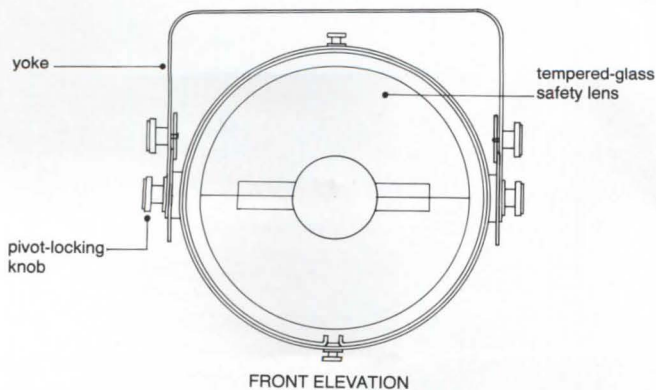
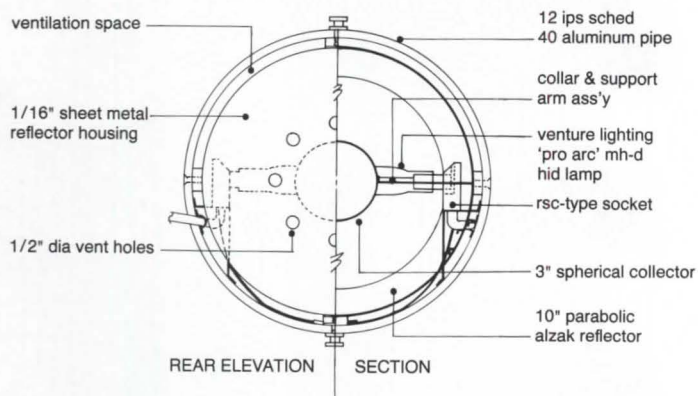



Pain Reliever

*Family Dental Clinic
Reading, Massachusetts
Lawrence Man, Architect*





Architect Lawrence Man carefully blended color and light to help relax patients in the reception room (opposite).

Inexpensive fluorescent lights, hidden below the receptionist's desk and above the door to the rest of the clinic, shine on painted surfaces to acquire warmth. Recessed incandescent lights above the receptionist's desk provide task lighting while drawing attention to the wood worksurface. Low-voltage incandescent lights accent an architectural composition made of a wood coat closet, glass door, and metal surrounds (above).

Not many people look forward to going to the dentist's office. But just as the high-speed drill has reduced the potential for pain, a new generation of office design has eliminated the cold clinical atmosphere that all too often made even waiting for the doctor an unnerving experience. As Lawrence Man proves with his Family Dental Clinic in Reading, Massachusetts, lighting is a critical element in creating a relaxed, comfortable setting.

Combining two adjacent spaces into one 1,200-square-foot office, Man retained a touch of history in his floor plan. By treating one side of the new clinic differently from the other—carving out volumes for specialized functions along one end, while opening up an area for semiprivate operatories along the other—the architect reminds us that these two halves were once separate offices. Lighting reinforces this message. To emphasize the sculptural quality of the special-function rooms (such as reception, accounting, dental hygiene, laboratory, and darkroom), Man hid warm-white F20 and F40 fluorescent strips in niches along the corridor to create a glowing light-box effect. At both the beginning and end of the central corridor, the architect installed PAR-36, 50-watt incandescent accent lights that focus attention on elements of particular interest: a striking composition of a wood closet floating in a wall of glass (photo left) at one end and a painting at the other.

Because dentists today often work on more than one patient at a time, Man created a series of four partially enclosed operatories by dividing a large space with custom-designed cabinets. Not only do these cabinets define the operating spaces, they also supply an ingenious triad of lighting. For ambient illumination, fluorescent tubes on the top of each cabinet wash the ceiling, eliminating any chance that glaring light might shine into patients' eyes while they lie in the dental chairs. At the same time, a deflector redirects some light onto the cabinet face itself and provides visual relief. Hidden under the upper cabinet, above the work counter, small-diameter, tubular incandescents (either 35 or 60 watts) provide needed task lighting. Again, Man carefully positioned the lights so they wouldn't shine in patients' eyes.

In the reception area, the architect orchestrated materials, colors, and lighting to create a soothing environment. Ambient light here is provided by incandescent sources recessed in the ceiling and natural light coming from windows. Incandescents above the receptionist's counter provide task lighting and draw attention to the warm wood. Underneath the counter a fluorescent tube shines down along the pastel-blue wall, offering what the architect describes as a calming accent. In a similar manner, fluorescent lighting above the glass door and wood coat closet picks up a mauve cast from the painted surface below the ceiling and highlights the transition from reception room to the rest of the clinic.

"My strategy was to use lighting to reinforce the spatial changes found in the clinic," explains Man. The strategy worked and the result is a refreshingly pleasant series of architectural experiences. Although few patients may want to schedule extra appointments for root-canal work, business has almost doubled since the new offices opened. *Clifford A. Pearson*



The 1,200-square-foot clinic was assembled from two offices, a fact that can be seen in the slightly skewed layout and the forced-perspective corridor (floor plan below). The four semiprivate operatories are separated by cabinets that hold a variety of light sources: fluorescent uplights, deflectors that redirect fluorescent light onto the face of the cabinets, and incandescent task lights that shine on the work surface (section bottom, photos left and opposite). The architect made sure that lights would not shine directly into patients' eyes as they lie in dental chairs. Colors and materials work with lighting to create a relaxed atmosphere.

Credits

*Family Dental Office
Reading, Massachusetts*

Owner: *Family Dental Associates*

Lighting Designer:
Lawrence Man

Architect: *Lawrence Man, Architect—Lawrence Man, designer*

General Contractor: *Nashoba*

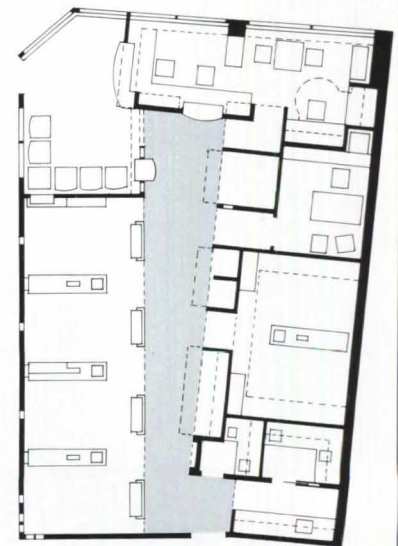
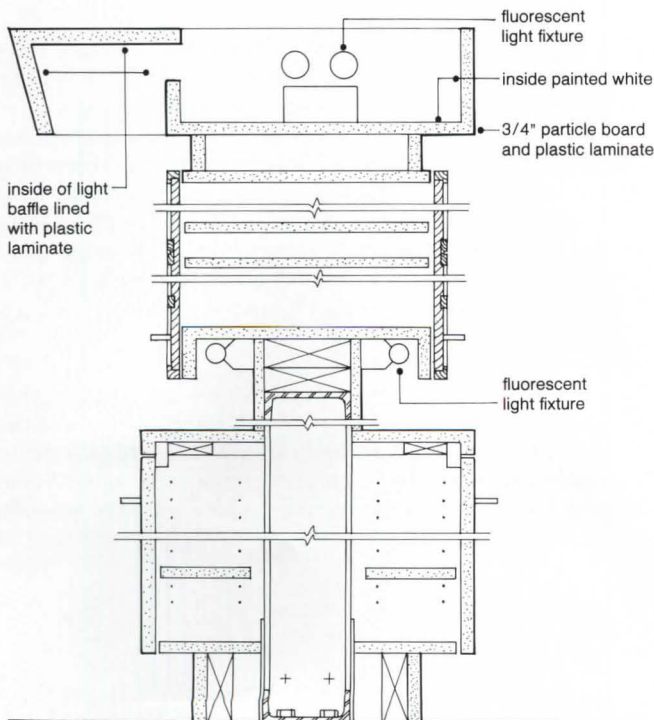



Lighting Another Planet

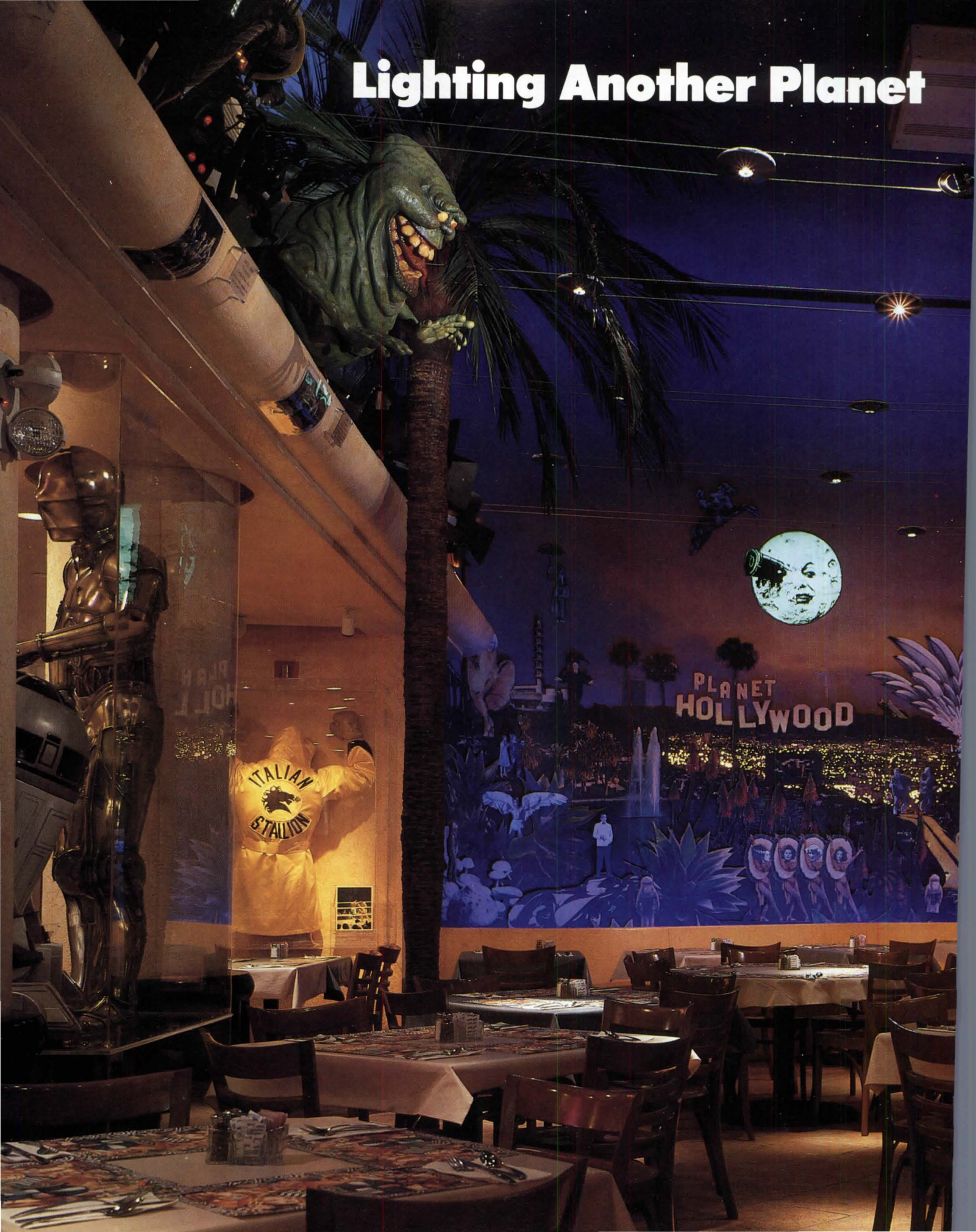

Ordinary dining-room lighting techniques won't do when dinner is served on the back lot.

*Planet Hollywood
New York, New York
Charles Daboub Design, Inc.
Lighting designer*



Spotlights seize significant artifacts from a California netherworld: The gingham dress that Dorothy wore to Oz hangs on a wall in the main dining room, no more than 20 feet away from the frock coat and breeches Laurence Olivier wore as Mr. Darcy. The rebellious James Dean's motorcycle dangles from the ceiling. The Terminator menaces those who evade their vegetables. The knife from the Bates Motel is here, along with Kathy Bates's sledgehammer, Freddy Krueger's glove, Spartacus's spears, Elvis's yearbook, and an exit that spells out in brilliant pink neon script, "That's All, Folks!"

The peppering of ape regalia notwithstanding, this is Planet Hollywood, the year-old New York eatery/celluloid museum that manages to cater to families, tourists, and matinee-goers as well as the late-night crowd. The \$15-million hot property belongs to Arnold Schwarzenegger, Sylvester Stallone, Bruce Willis, director John Hughes, producer Keith Barish, publicist Bobby Zarem, Hard-Rock-Cafe inventor Robert Earl, and actor Bryan Kestner (who originated the idea but wanted to locate it in Manassas, Virginia, and call it Hollyrock). It was the late film designer Anton Furst, who won an Oscar for the original "Batman," who spun authentic movie costumes and props, and real objects owned by stars into an East Coast fantasy about a West Coast fantasy.

It is always midnight in the main dining room, where brilliant fiber-optic points create a twinkling sky on the double-height ceiling, as well as a busy tinsel town nestled on a huge wall-size mural of the Hollywood Hills. Gradations in fiber diameter help create the illusion of varying distances. Long beams of opening-night spotlights play continuously across the mural from floor-mounted pinspots on motorized bases shielded behind bench settees. The settees also conceal black-light tubes that pick out selected features in the mural. Column-mounted PAR cans with barn doors shine on the mural from above. Projection screens and a multitude of TVs add an eerie glow.

Even if Hollywood is a planet unto itself, people still have to eat, and lighting techniques normally prescribed for earthly diners might have destroyed this otherworldly atmosphere. Dallas-based architect and interior designer Charles Daboub specified a parallel-cable system suspended well below the ceiling where it detracts neither from sky nor from cityscape.

With the "real" Hollywood churning out film memorabilia at a prodigious rate, this satellite presents a major logistical headache for anyone who assumes a lighting scheme should last as long as the project. On this planet, each time a new treasure arrives, a new light source has to be added to the script. As one of the owners has conceded, Planet Hollywood, like a movie, is in constant rewrite.

Daboub laid low-voltage track end to end in ceiling coves around the perimeters of all the rooms so that wire could be fished through the plenum and emerge wherever a new hole is punctured to accommodate a new fixture. The dropped ceiling screens the wires. "They can puncture the ceiling at any place," Daboub says. "They can plug in any kind of light anywhere." The extravaganza is controlled by a flush-mounted dimmer pad preset to simulate daylight, dusk, evening, and the atmosphere of a private club. *Judith Davidsen*

Judith Davidsen is a New York City-based free-lance writer and a frequent contributor to ARCHITECTURAL RECORD LIGHTING.



It is always midnight in the main dining room (preceding spread), where a suspended double-cable system illuminates tables without detracting from the fiber-optic brilliance of ceiling galaxy and cityscape. The quartz halogen fixtures on the double cable can be adjusted for up, down, or directional lighting. In the futuristic Blimp Room (opposite and top), the swiveling globes are not light fixtures at all, but oversized versions of the individual air-conditioning outlets found on airplanes. Behind the wave-shaped bar (bottom), an upended Hockney-esque pool, complete with tile surround and metal ladder, replaces the usual display of massed liquor bottles. Refractor-lensed floods shine through a transparent trough of dripping water to fill the pool with the illusion of wet ripples.

Credits

*Planet Hollywood
New York City*

Owners: *Arnold Schwarzenegger,
Sylvester
Stallone, Bruce Willis, et al.*

Interiors: *Anton Furst*

Lighting: *Charles Daboub Design, Inc.*



Lighting 2-D Art

Fine-art lighting requires a knowledge of equipment, sources and their characteristics, contrast and aiming angles. But nothing works like experience.

By James Robert Benya

There are a number of ways to light vertical surfaces and the artwork on them. Some of the methods involve the use of wallwashing and wall slot lighting which, by illuminating the entire wall, illuminates the art, too. But what if the desired effect is the accent lighting of a single painting, poster, or photograph? Too often, designers specify accent lighting that works but is disappointing somehow. By better understanding accent lighting layout, lamps, and accessories, designers can assure that artwork is sensitively illuminated.

Types of equipment

Accent lighting for art can be achieved with any of the following:

- *Track lighting.* The flexibility of track makes it the only choice for lighting in galleries, museums, and private rotating collections.
- *Recessed-accent lighting.* Recessed accent lights appear as downlights to the untrained observer. They are suitable for relatively fixed collections and are especially good for fine homes and other elegant facilities.
- *Picture frame-mounted lighting.* Although the least desirable way to light art, recent improvements in picture-frame lights have made this technique acceptable when no other will work.

Light sources

Lighting art is highly dependent on the quality and effect of the light source. Directional light consists of three components: the beam, which is the concentrated center of the light; the field, which is the area of lesser brightness surrounding the beam; and the spill, which is the relatively uncontrolled light given off by the source.

Generally, the beam is the part actually used to illuminate the artwork itself. It is generally defined as that portion of the light which is between 50 percent and 100 percent of maximum beam candlepower. The eye has great difficulty detecting any brightness difference within the beam. Manufacturers' data for directional lamps give beam angles, or spread.

The field is the portion of the light between 10 percent candlepower and 50 percent candlepower. The eye can detect a lower light level in the field. Nonetheless, field can be used to illuminate the space surrounding the artwork. For example, the field from a luminaire lighting a painting can illuminate the furniture below. The spill is generally considered glare and contributes little to the scene being illuminated. It is usually a good idea to eliminate it.

The quality of the beam itself varies tremendously from light source

Jim Benya heads the Lighting and Daylighting Group of Proven Alternatives, Inc., San Francisco, parent of Luminae Souter.

to light source. Qualities which should be considered include:

- *Beam flatness.* Does the beam appear even ("flat") from edge to edge, or bright in the center with softer surround ("pointed")?
- *Beam edge.* Does the beam change to field abruptly ("sharp edge") or is the transition smooth ("soft edge")?
- *Beam shape.* Is the beam round, elliptical, or some other shape? Is it a nice geometric shape or is it imperfect?
- *Beam smoothness.* Does the beam have streaks, flares, striations?

Glare control

Glare is caused by uncontrolled light not contained within the beam or field. It is generally the light emitted by the front of the filament or arc tube, and not managed by the lamp or luminaire's reflector. One means of glare control is the use of lamps with internal filament shields. Most PAR-36, AR-70, and AR-111 lamps have internal filament shields.

Although these shields reduce the efficiency of the lamp or luminaire, they serve to eliminate most of the spill. All other lamps, including MR-16s, PAR-38s, and all smaller PAR lamps, have unshielded filaments. To control their glare, consider either: a "snoot," a long cylindrical black tube which confines the field; or a louver, especially a honeycomb louver, which is fairly flat by comparison and also confines the field.

Other lamp types

Reflector lamps, or R lamps, are the softest lamps of all directional sources. They generally don't have sufficient candlepower "punch" to create contrast. With the right equipment, they can be used for broad pieces of art, but glare control is important.

Line-voltage PAR lamps are good for retail display, including sales galleries. PAR lamps have distinct beams. Incandescent PAR lamps have high-quality, sharp-edged, round or elliptical beams, but require glare control.

Halogen PAR lamps, including all sizes, generally have striated, pointed, sharp-edged round beams, and often need both lens and glare control. But considering the energy efficiency and whiter light of the halogen lamps, they are usually preferable to incandescent.

Low-voltage PAR- and AR-lamps with both a filament shield and a reflector and lens designed to produce elliptical, sharp-edged, high-quality beams, low-voltage PAR and AR lamps are among the best lamps to use without accessories. A great application of the low-voltage PAR and AR lamps is for lighting artwork over long distances. A PAR-36 VNSP or NSP could be used to light a painting on a cathedral ceiling, for example.

Below: Lighting scheme by D. Witte and J. Benya consists of recessed MR-16 accent lights; 50W NFL with soft focus over artwork; 50W NSP with linear spread lens highlights sofa; 50W NFL with honeycomb louver lights rug. Bottom: Recessed MR-16s 50W FL with diffuser shed light under drop ceiling; other light is monopoint MR-11 NSP 20W. J. Benya design.

J. Benya photos except as noted



MR-16 lamps

I have often called these the "Ferrari" of lighting. In the hands of a skilled professional lighting designer, the MR-16 offers more performance with less visual intrusion than any other lamp. However, if MR-16's can't be used with properly selected lenses and glare control, a more forgiving lamp source should be employed.

The bare MR-16 has a pointed, sharp-edged, striated, and flared roundish beam, and with its unshielded filament, desperately needs glare control and lensing for artwork lighting. Moreover, the lamp-to-lamp color shifts and dreadful quality of discount off-brand lamps dooms most MR-16 installations. If all of these factors are not resolved, an MR-16 installation will become an expensive visual nightmare.

Contrast as technique

The principal design decision is the amount of contrast to be employed. Contrast is the ratio between light and dark. The designer must decide how bright the art will be, how bright the surrounding scene will be, and the sharpness of the line between light and dark. Consider choosing one of the following strategies:

- High Contrast-Sharp Line. When lighting very important artwork, it is often desired that the piece be virtually "framed" in light. This effect is only created by framing projectors.
- High Contrast-Distinct Emphasis. Most clients want their important artwork to "stand out," as in a museum or gallery. This effect is created when the beam matches the art and the field is minimized so that the artwork is *almost* framed in light. Naturally, for this to work it is important to have a space with fairly low ambient light. This approach is more practical since it can be accomplished with less expensive lighting equipment than the previous example.
- Medium Contrast-High Ambient. Often it is desirable to illuminate a painting or poster brightly and with emphasis, although the ambient light surrounding the piece is very high. The high ambient level makes field and spill control a minor issue, allowing for very inexpensive equipment to do the job.
- Medium Contrast-Low Ambient. This is the condition found in many homes at night. The designer often wants to illuminate the painting and the immediate scene, such as the furniture below, or to gently spill on the wall finish. This is the hardest of all to do, but the effect helps prevent homes and hotels from looking like museums.

Proper lamp aiming angles

A previous article [ARCHITECTURAL RECORD LIGHTING Supplement, February, 1992, page 16] explained the simple use of a 30-60-90 triangle to determine the proper location illumination for artwork with an angle of about 30 degrees off vertical. This applies to most



Assorted low-voltage lamps.

Diffuser and louvers for PAR-38 fixture.

Typical accessories for MR-16 fixture.

equipment except framing projectors, which work best between 45 and 90 degrees off vertical.

Fixture spacing becomes important when it takes more than one luminaire to light a single artwork. Often a wide piece will require two or three luminaires. By making the luminaires' distance from the wall the same as the distance between the luminaires, an acceptable beam pattern will result.

Lenses

Adding a lens to the front of the luminaire often improves the performance of the equipment. The most commonly-used lenses are:

- *Diffuser Lens.* Softens the beam edge, smooths and rounds the beam, but changes the beams spread and reduces efficiency. Diffuser or sandblasted-type lenses are often too "soft" for artwork lighting.
- *Prismatic Lens.* Glass prismatic lenses have many of the same effects as the diffuser but don't spread the beam as far nor do they reduce efficiency as much. A good lens for large pieces or scenes.
- *Soft-Focus Lens.* A slightly etched glass lens that softens the beam edge and smooths the beam. This is particularly good for most art lighting since it eliminates the common problems of most modern halogen lamps.
- *Linear-Spread Lens.* A lens comprised of linear prisms, this lens is also called a beam elongator. These lenses work especially well with MR-16 lamps, making "slashes" of light from narrow spots and definite ellipse shapes from flood lamps. Also softens the beam edge.

Framing projectors (ellipsoidals)

All framing projectors are "ellipsoidals," meaning the initial reflector creates a "refocus" of the light in front of the lamp. This refocus point can be equipped with a combination of optical lenses, shutters, irises, and pattern projections to project a shaped razor-sharp flat-edge smooth beam with no field and no spill. It is the "perfect" beam for framing effects.

But framing projectors cost three to 10 times the total cost of a properly equipped low-voltage light creating a similar effect. And framing projectors require careful adjustment. The cheaper the projector, the easier the adjustment can get "out of whack." Premium projectors use custom-cut patterns and rock-solid mounting gear to minimize adjustment problems.

Another disadvantage to framing projectors is that they are extremely inefficient. The optical-lens assembly reduces light so significantly that it takes about three to five times as much wattage to create the same level of brightness with a framing projector as with a properly lensed and glare-controlled low-voltage light source.

Protecting the art from light

When lighting fine art and antiques, deleterious lighting effects called "photodegradation" can occur. Most museums have lighting experts well versed in minimizing photodegradation, but many private collections are carelessly displayed. The principal cause of degradation is ultraviolet light. UV must be eliminated.

But it is important to remember that daylight contains many times the amount of UV of most incandescent and halogen lights, so protecting art from the daylight should be the designer's first concern. Assuming that the art isn't exposed to daylight, then UV-absorbing glass filters should be obtained for the lighting equipment. A standard option of most MR-16 fixture manufacturers is a 2700K color warming filter, which in most cases is a UV-absorbing dichroic lens product. Lensmakers such as Bausch and Lomb manufacture this product for lighting fixture and lamp companies.

Some art is also sensitive to the heat of incandescent light, so heat-reduction filters are used. The MR-16 lamp itself has a built-in heat-reduction effect by its internal dichroic reflector, in most cases. It is also possible to obtain "cool beam" lamps with dichroic filters in many PAR-lamps. Add-on heat-reduction filters, like UV filters, are commercially available.

Frame-mounted lights

Traditional frame-mounted "picture" lights are dreadful. They light the art poorly, use inefficient incandescent "T" lamps, and often cause glare. Don't use traditional frame lamps unless their traditional appearance outweighs all other considerations. Converting these lamps to fluorescent will improve the light-source efficiency, but will also introduce significant amounts of UV light.

The new halogen frame lamps, on the other hand, are an excellent compromise when other forms of light aren't possible. These systems use a series of low-voltage halogen lamps. Because there is not room for UV control, you may wish to avoid this type of luminaire with particularly old or precious artwork.

The final word

Fine-art lighting, like any other art form, cannot be taught completely. To understand which combination of lamp, lens, louver, and adjustment works for what circumstances, nothing replaces hands-on experience. If you specify art lighting, be prepared to adjust it yourself for your client. To train yourself, put track and different luminaires in your own studio or living room and try them out until you learn the nuances of fine-art lighting for yourself. ■

1. Recessed MR-16s are used throughout dining room. Spot-lighting art: 50W NFL with soft-focus lens; on table: 50W NFL with honeycomb louver; fill light: 20W FL and diffuser. Designed by C. Bolton-Kavasik and J. Benya.

2. In music room, keyboard is illuminated by 50W NSP with linear spread lens; fill light

with 35W NFL and diffuser. D. Witte and J. Benya design.

3. Bedroom lighting consists of track MR-16 with 50W NFL and soft-focus lens on art; 50W NSP on plant. J. Benya design.

4. The high-ceilinged living/dining room was especially difficult to light, says designer Benya. Used over living-room

photos: recessed 50W MR-16 NSP with linear spread lens; highlighting dining-area photos: 42W NSP with soft-focus lens; over-table lighting: 42W NSP and snoot; fill light with 50W NFL and honeycomb louver.



© Doug Sutin photo

TARGETTI THROWS YOU NEW CURVES

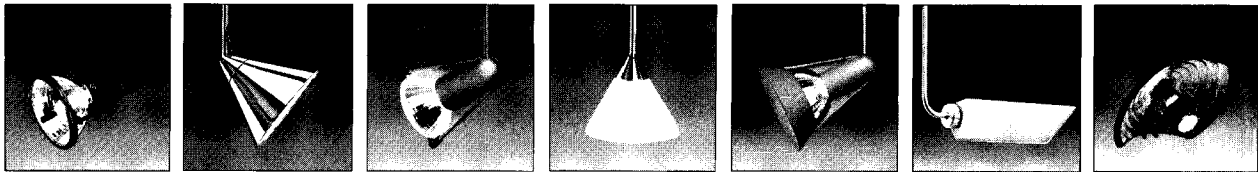
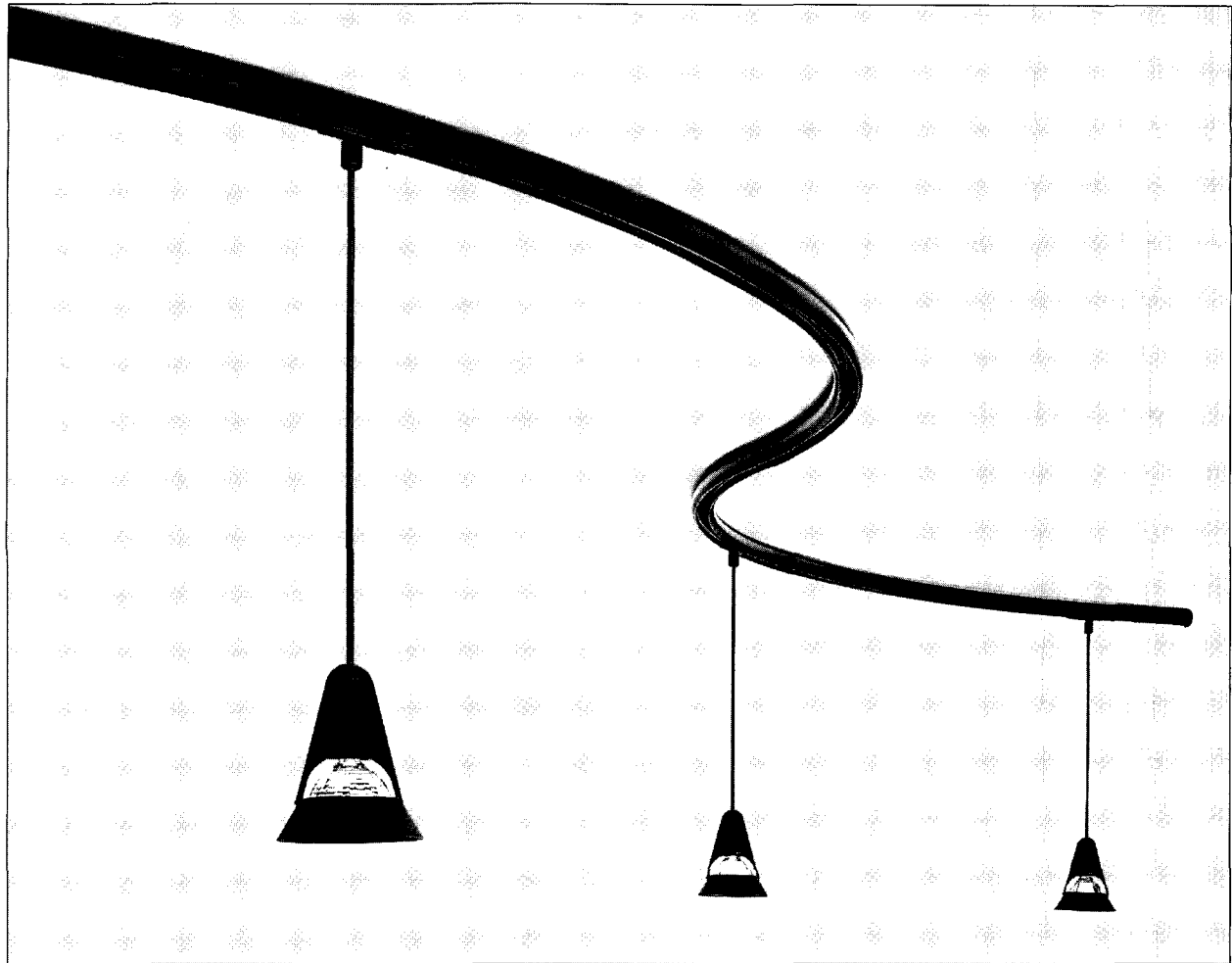

Targetti introduces its new "Minicurvo", UL listed, low voltage curved track, a shapely addition to the Minitondo system. Break away from the straight and narrow to create arcs or sinuous, fluid lines of light with wall, ceiling or pendant mounted systems. Minicurvo is available in black or white, sectioned into 45° curves, with 4 sections comprising a 38" radius semicircle.

targetti®

distributed by

illuminating experiences, inc.

Circle 79 on inquiry card

233 Cleveland Avenue, Highland Park, New Jersey 08904 - Telephone: (908) 745-5858 / 800-526-6990 - Fax: (908) 745-9710

NEOLUX ©

Higher perceived illumination with lower perceived brightness. Ideal for office, classrooms, conference spaces, or any areas utilizing VDT's and where visual comfort is paramount. Uniform ceiling luminance from wide spread indirect distribution. Luminaire and ceiling luminances and ratios meet IES RP-24. Perceived brightness, low glare from parabolic louver for controlled direct lighting. Fixture efficiency is greater than 82%. Variety of lamping options. One two or three T8 or T10 lamps, one or two T12 lamps.

Series 13

LOW LUMINANCE
DIRECT/INDIRECT
ILLUMINATION

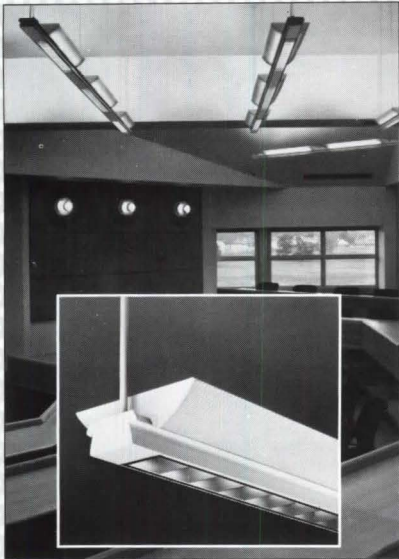

neoray
NATURALLY

537 Johnson Avenue
Brooklyn, NY 11237

Tel: 718/456-7400 • Fax: 718/456-5492
Circle 80 on inquiry card

SOME DIM

Finally! Dimming for compact fluorescent. Down to the 5% level. Available now on Duplux®/8-DM, our most powerful quad lamped downlight. Efficiency over 70%, precise distribution, shallow recess depth, interchangeable wall-wash reflectors, anti-iridescent color finishes. Duplux®/8-DM: one of a family of dimmable compact fluorescent **Standards**. For more information and the name of your local representative, call 212-838-5212; fax 212-888-7981.

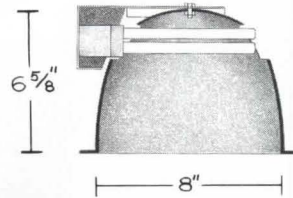
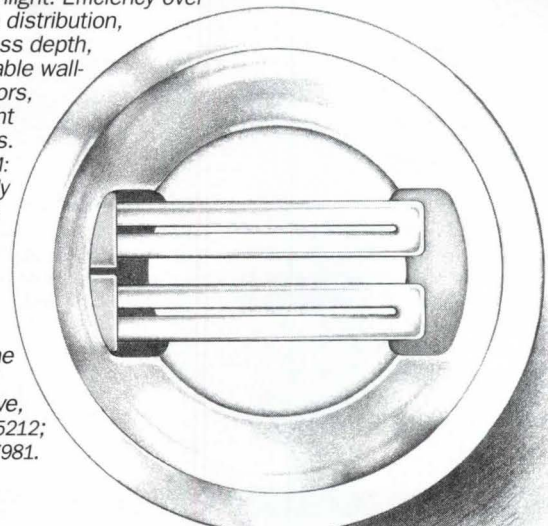

Circle 81 on inquiry card

EDISON PRICE
LIGHTING

ARCHITECTURAL LIGHTING AT ITS BEST

Thinking Tracklight? Think Inlite!

Pictured here are just two models from Inlite's European Styled EPIQUE COLLECTION... Designed for our 3000 Series DUO-TRACK.

THE ECLIPSE

Model 5112G
150WQCL
T3-Halogen

THE GEMINI

Model 5026BP
50/75W PAR30 or
50W PAR20 Halogen

Please call or write for further information and free literature.

 **inlite**
CORPORATION

939 Grayson St., Berkeley, CA 94710
1-800-346-5932

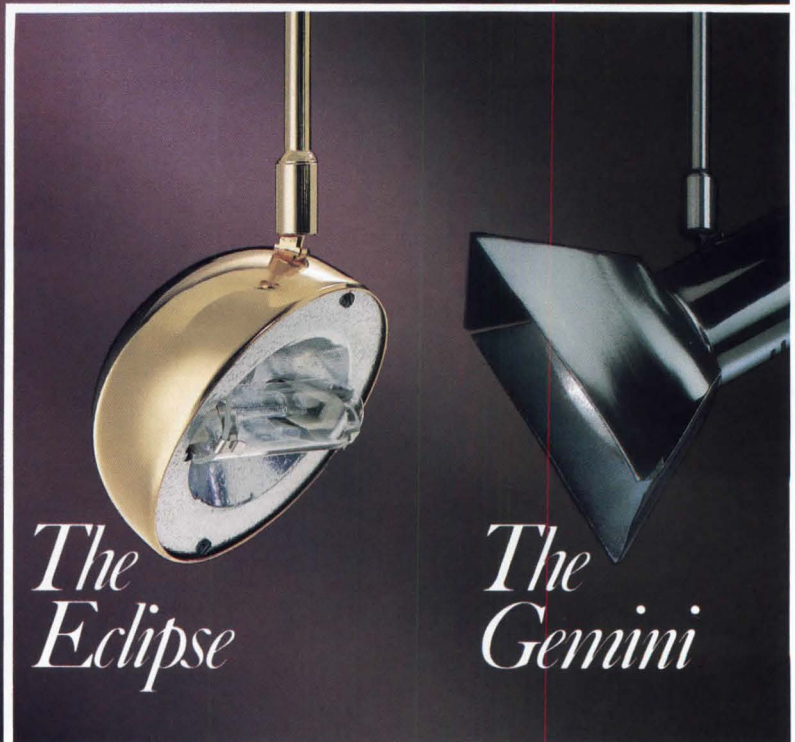

*The
Eclipse*

*The
Gemini*

Circle 82 on inquiry card

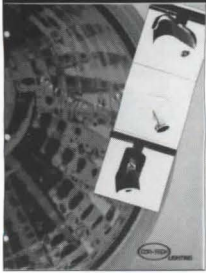

424. Track lighting

All Con-Tech styles are available for low-voltage as well as line-voltage operation. A 24-page color catalog illustrates Flat-Back, Round, and Step Cylinders; Bell, Baffled Sphere, Universal, and Gimbal lampholders; and New Decade and Micro/Lite styles for track mounting. Con-Tech Lighting, Deerfield, Ill.



425. Recessed wall light

New outdoor wall and aisle lights permit wider spacing with a very compact (5 1/2-in. wide) unit. Offered in louvered-faceplate models for vertical and horizontal mounting, luminaires accept twin- and quad-tube compact fluorescents to 28W, and HID lamps to 50W. mcPhilben Outdoor Lighting, San Leandro, Calif.



426. Lighting: short course

An informative 50-page booklet written for the design professional as well as the client, *An Introduction to Light and Lighting* explains the physics of light and vision, color, and electrical illumination, and the importance of good fixture design and application. \$24 charge. Illuminating Engineering Society, New York City.

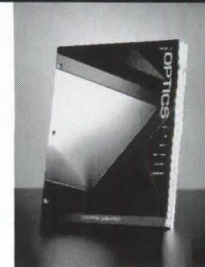

427. Outdoor lighting

Controlled Optics is a 30-page guide to achieving precise nighttime illumination of building facades, signage, columns and monuments, and pedestrian areas. Several approaches are presented for each application, where appropriate. Cooper Lighting, Elk Grove Village, Ill.



428. Architectural

Brochures illustrate various styles of High Performance Quad fixtures, square and rectangular indirect and direct/indirect luminaires said to optimize the performance of the Biax lamp. Standard or custom seamless steel housings and finishes can match architectural details. Architectural Lighting Systems, Inc., Taunton, Mass.

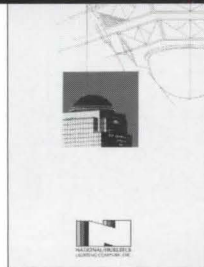

429. Custom and replica

Capabilities brochure outlines expertise in the fabrication of custom lighting fixtures and in replicating period luminaires. Color photos highlight recent projects, including New York City's World Financial Center. National/Horlbeck Lighting Co., Inc., Belleville, N. J.

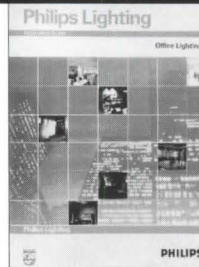

430. Office-lighting guide

One of a series of industry-specific application manuals developed as part of a lighting-education program for specifiers and end-users, an office-lighting-application guide has 36 pages on the selection of optimum lighting systems for settings such as reception areas, conference rooms, hallways, and all types of offices. Philips Lighting, Somerset, N. J.



431. Overseas connections

Catalogs from three major sources—ERCO of Germany, Thorn/ALI of Australia, and Yamagiwa of Japan—are available from their American licensing partner. These firms offer incandescent, compact fluorescent, and low-voltage fixtures based on Edison-Price designs. Edison Price, New York City.

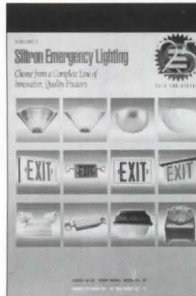

432. Emergency lighting

Siltron's 25th-anniversary catalog explains the benefits of using high power factor ballasts (or corrective capacitors) for all compact-fluorescent fixtures. Products include standard exit signs and decorative sconces that work as both circulation and emergency lighting. Siltron, Rancho Cucamonga, Calif.



433. Residential light control

Brochure on the LiteCom control system gives homeowners innovative ways to use lighting to express individual style, while making homes safer and more comfortable. Controls up to 256 individual lighting points, as well as fans, electric blinds, and other motorized devices. Honeywell, Inc., Golden Valley, Minn.



434. HQI fixtures

Four-color catalog inserts feature interior and exterior luminaires designed to make best use of Osram's HQI metal-halide lamps. Styles include asymmetric wall- and floor-mount fixtures and accessories such as barn doors and baffles. Complete photometrics supplied for each fixture. Mirofactor Co., Inc., Inwood, N. Y.

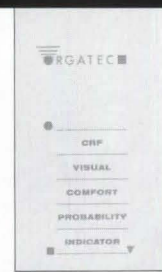

435. Glare gauge

Orgatec's glare indicator, a tri-fold card with a series of gray scale viewing windows, helps estimate the amount of glare in actual lighting installations, and to position tasks in order to improve the contrast rendering factor. Orgatec America, Beverly Hills, Calif. ■

All the Code rules on LIGHTING explained in a single book!

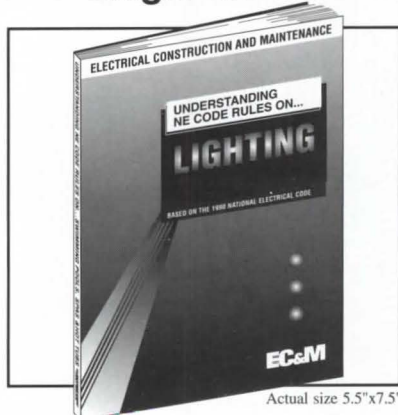

Actual size 5.5"x7.5"

Here's an amazingly convenient reference that pulls together the many lighting-related rules scattered throughout the NE Code. In a clear, concise way, this new book analyzes and interprets rules pertaining to design, installation, and maintenance for all kinds of lighting installations. *Understanding NE Code Rules On... Lighting* simplifies the hard-to-understand language of the Code, and brings all the lighting rules together into one book. It's the ideal designer's desk reference and training manual, and the perfect size for carrying to the job site. Over 75 illustrations; soft cover, 152 pages.

#4562 \$15.95 ea.

MAIL ORDER TO:



EC&M Books
P.O. Box 12901
Overland Park, KS 66282-2901

Please send me _____ copies of the book *Understanding NE Code Rules On... LIGHTING* at \$15.95 each (#4562).

Shipping & Handling: Add \$3.00 for the first book, 50¢ each additional book, plus sales tax shown below.

Sales Tax: Residents of: CA-7.25% (LA & SF-8.25%), CO-3.8%, IL-6.25%, KS-6.5%, MI-4%, MN-6.5%, NJ-6%, NYC-8.25%, NYST-4%, OH-5%, PA-6% please add tax shown.

Check or M.O. must accompany orders of \$50 or less. Charge orders of more than \$50 may be made by company P.O. or charge card, and may be placed by telephone at 1-800-654-6776

Payment enclosed: \$ _____

Or charge to: Amex VISA MasterCard

Account # _____

Exp. Date _____

Signature _____

SHIP TO:

Name _____

Company _____

Street _____

City _____ State _____ Zip _____

Telephone (____) _____

Please allow 3-5 weeks for delivery. Source RLTG-792

Manufacturer Sources

For your convenience in locating lighting fixtures shown in feature articles, RECORD has asked the architects and lighting designers to identify the products specified.

Pages 9-11

Lighting Design News

Atlanta, Roswell Library, inverters: Dual-Lite (Spectron). **San Francisco**, Fashion Center, internal optical system: Peerless Lighting Corp.; Biax lamps: GE Lighting. **Atlanta**, NationsBank, flood-lighting: Infranor. **Chicago**, Harold Washington Library Center, ballasts: Advance Transformer Co. (78E Series).

Pages 26-31

Architect Offices, Los Angeles

Altoon & Porter, Architects
Wheel Gersztoff Friedman Shankar Inc.,
Lighting Designer; partner in charge: Babu Shankar, IALD; project designer: Allan Leibow, IALD

Indirect fluorescent uplight with reflector: Lithonia. Perforated aluminum scrim and fixture fabrication: Metalmorphosis. Low-voltage MR11 accent: Ardee Lighting. Fluorescent valance: Illumination Concepts and Engineering. Undercounter lights: Lithonia.

Pages 32-33

National Cathedral, Washington, D. C.
C. M. Kling & Associates, Lighting Designer
Exterior luminaires: Bega/FS.

Pages 34-39

Three Nationwide Plaza
NBBJ Architects
S. Leonard Auerbach & Associates, Lighting Designers
Metal-halide beam projector, custom PAR 64 fixture; horticultural lighting-control system, and custom incandescent lighting: Sterner, Inc. Pool and water lighting fixtures, landscape uplights, and accent lights: Hydrel, Inc. 400W double-ended metal-halide projector lamp: Venture Lighting.

Pages 40-43

Family Dental Clinic
Lawrence Man, Architect
Recessed incandescent downlights and low-voltage accent lighting: Lightolier, Inc. Surface-mounted fixtures: Poulsen Lighting, Inc. Tubular incandescent task lights: Alkco. Linear fluorescent fixtures: Columbia; Day-O-Lite; Alkco. Emergency lighting: Chloride.

Pages 44-47

Planet Hollywood declined to contribute to this source list.

Corrections

In credits for HealthPark Medical Center ["Kindly Light," RECORD LIGHTING, May 1992, pages 58-61] the name of Jonathan Bailey, project designer, was spelled incorrectly.

Boogies Diner ["Let the Good Light Roll," pages 64-67] was designed by Mark Kruger while a principal with Wheel Gersztoff Friedman Shankar Inc. The credits incorrectly listed Kruger's own firm as the firm of record.

BRINGING THE PAST INTO THE PRESENT

"LIGHT ETHEREAL,
FIRST OF THINGS,
QUINTESSENCE
PURE..."

MILTON



Beautiful form.
Faithful to

detail. Practical in function. Fine reproduction lighting in a quintessential array of authentic designs. Request our catalog.



REJUVENATION LAMP & FIXTURE CO.

1100 S.E. GRAND AVENUE
PORTLAND, OREGON 97214
(503) 231-1900

Circle 101 on inquiry card

Product & Literature Spotlight

Here are some lighting products, catalogs, brochures and technical literature available in the architectural lighting market today. To receive your copy of any of them, just fill out and return one of the special Reader Service Cards bound to this issue.

ALTAIR by INLITE



Pictured above is one of the new Trigon models by INLITE—the ALTAIR, Model 5110/5113 in 24K gold finish. The use of 20-50W MR16 lamps is recommended. The exclusive Snapjack® Seismic plug-in assures positive electrical connection.

For more information:
INLITE Corporation
939 Grayson Street
Berkeley, CA 94710
510-849-1067
1-800-346-5932

Inlite Corporation

Circle 85 on the inquiry card

Dynamic Modeling with Lighting Software

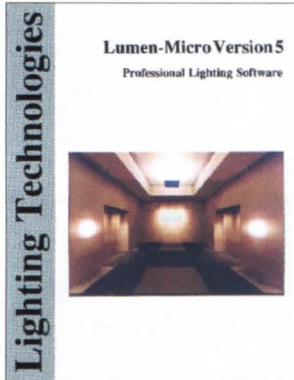

Lumen-Micro 5 is a graphics-oriented, PC-based, indoor lighting design and analysis program. Key features include point-by-point calculations, the ability to specify partitions for architecturally accurate modeling, 3D perspective renderings for near-photographic quality presentations, luminaire aiming, DXF file format output providing compatibility with various CAD programs, and complete daylighting analysis.

Lighting Technologies, Inc.

Circle 86 on the inquiry card

Nostalgic Post-Top Ornamental Luminaire

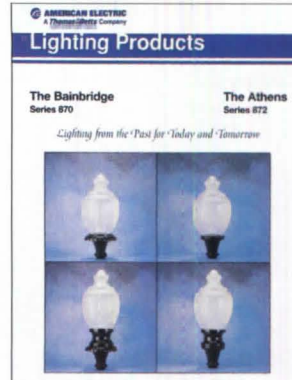

AMERICAN ELECTRIC is introducing a new luminaire to the ornamental/nostalgic lighting market. The ATHENS/BAINBRIDGE luminaire features old-fashioned style & grace with modern performance & materials. These luminaires are available with a variety of globe styles, ornamental accessories, colors, and a range of wattages of High Pressure Sodium, Mercury Vapor, & Metal Halide light sources.

American Electric

Circle 87 on the inquiry card

An Unequaled Design For Landscape Lighting

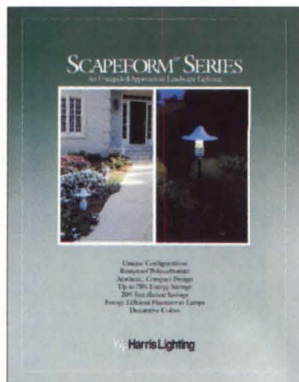

W.F. Harris Lighting presents the SCAPEFORM™ SERIES—the next generation of landscape lighting. Constructed of impact-resistant polycarbonate, these fixtures are virtually unbreakable & rustproof. Designed around energy-efficient fluorescent lamps, the luminaires offer a compact silhouette. The SCAPEFORM™ SERIES offers many different styles, & is available in an array of molded-in colors.

W.F. Harris Lighting

Circle 88 on the inquiry card

Flexible Lighting Control System



Distinctly elegant & easy-to-use, the LiteTouch 2000 is a residential or mid-range architectural lighting control system designed for flexibility & reliability. The LiteTouch 2000 includes advanced features such as master controls, scene presets, wireless RFI & infrared control. Owner programmable, this master dimming system can be interfaced with telephones, motion sensors, & security systems.

LiteTouch Inc.

Circle 89 on the inquiry card

Limited Numbered Edition

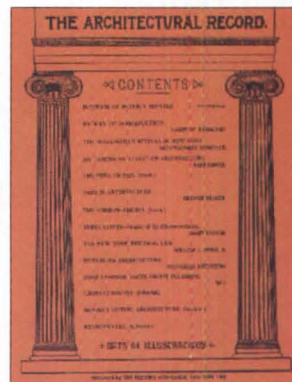

ARCHITECTURAL RECORD'S first issue (1891) is reprinted to celebrate our centennial. 150 pages, 64 illustrations. Every architect should have this collector's issue. Only \$16.95 ppd. For more information call: 212-512-3443. ARCHITECTURAL RECORD, Circulation Department, 1221 Avenue of the Americas, New York, NY 10020.

Architectural Record

Circle 90 on the inquiry card

PHOENIX 100™ PROJECTION LUMINAIRE

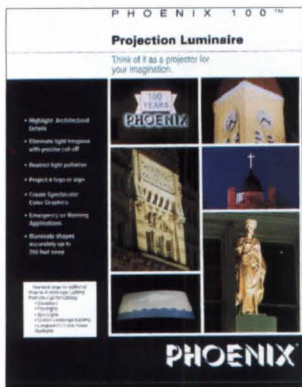

Designed for nighttime special effect lighting needs, Phoenix Products Co. introduces the Phoenix 100™ Projection Luminaire. It allows the precise control of unlimited light patterns, logos or messages over the coverage area with no light trespass on adjacent surfaces. Available in a variety of wattages with quartz or metal halide lamps, it is designed for easy daytime relamping. Mounting options include pedestal, pole or wall mounts. **FREE** brochure 414-438-1200, fax 414-438-0213.

Phoenix Products Co., Inc.

Circle 91 on the inquiry card

ALKCO UNDERCABINET LIGHTING

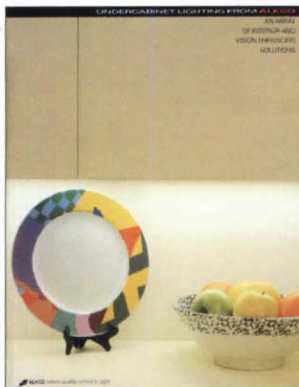

A new 24-page, 4-color catalog displays Alkco's improved/expanded line of undercabinet lighting fixtures and design options. The catalog includes a host of new task-optimized models. Featured in the Little Inch 1" thin miniature fluorescent with a new, proprietary high performance ballast made exclusively for Alkco by Radionic Industries.

Alkco

Circle 92 on the inquiry card

Altman Stage Lighting Highlighting & Framing

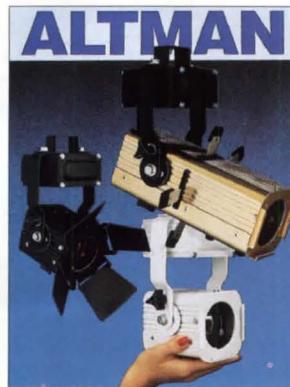

Altman's Micro Ellipse incorporates a lens system, shutters, pattern slot & holder for framing and/or pattern projection situations. The Micro-Flood produces a soft edged beam of light which is controlled by lamp selection & barn doors. Both units come with mounted external dimmable transformers & are track adaptable. Primarily constructed of extruded aluminium these lights are available in an array of anodized colors.

Altman Stage Lighting

Circle 93 on the inquiry card

New StoneForms for the Site



WoodForm, Inc. has introduced an all new product line of architectural precast outdoor lighting fixtures. Contemporary and traditional designs never before presented in this tough medium are offered as "StoneForms". Several surface treatments plus a choice of Incandescent, fluorescent, high intensity discharge, and low-voltage luminaires are available. All are U.L. approved. (800) 624-5091

WoodForm

Circle 94 on the inquiry card

AC & DC Power Switching and Control Solutions



Douglas Randall's 1992 product catalog provides detailed electrical & mechanical specs covering a broad spectrum of power switching & control devices. The wide range of devices available from advanced design solid state relays, proportional controllers & converters to miniature reed relay & coil products have been designed to meet the most demanding design requirements. (800) 447-6799, fax: (203) 599-1754.

Douglas Randall, Inc.

Circle 95 on the inquiry card

In Grade Up Lights

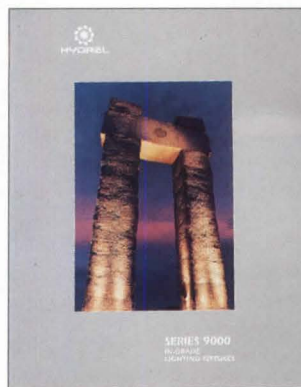

This 36 page catalog covers the new, innovative 9000 Series Ingrade Lighting fixtures. See how modular design makes a difference in performance, installation, maintenance, & durability. Available in a variety of configurations, this series accepts lamps to 175W HID, 250W Incandescent. Architectural & landscape illustrations include recommendations for the most common applications. Hydrel, Sylmar, California.

Hydrel

Circle 96 on the inquiry card

Introducing U.S. Architectural Lighting

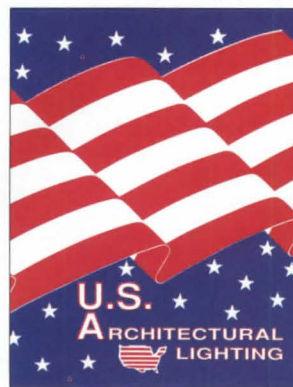

Extensive offering of quality, outdoor luminaires and poles featuring durable, cast aluminum construction. Standard product offering includes roadway and parking area lighting, area and site lighting, low level bollard lighting, wall and pier mount luminaires. U.S. Architectural further designs and manufactures custom lighting products.

U.S. Architectural Lighting

Circle 97 on the inquiry card

Aluminum Light Cove



Gordon stocks a low cost solution to light cove and radius drywall conditions. Pictured is part 1076, a 6" radius aluminum cove that is more economical than traditional methods of cove construction.

Gordon, Inc.

Circle 98 on the inquiry card

Advertising index

For detailed data, prefilled catalogs of the manufacturers listed below are available in your 1992 Sweet's Catalog File as follows:

Bold face—page number
Italics—Reader Service number

A
Artemide, 4; 67
(800) 359-7040

B
BEGA/FS, 5; 68
(805) 684-0533
Beta Lighting, 18; 73
(414) 886-2800

C
CSL Lighting Mfg., Inc., Cov. IV; 103
(805) 257-4155

E
EC&M Books, 57
(800) 654-6776
Edison Price, Inc., 53; 81
(212) 838-5212
Elliptipar, Inc., 21; 76
(203) 932-2266

G
General Electric - C&I
Lamps, Cov. II-1; 65 [G-E-I]
(800) 523-5520

H
Hydrel, 55; 83
(818) 362-9465

I
Inlite Corp., 53; 82
(800) 346-5932

K
Kim Lighting, 2; 66
(818) 968-5666

(G) General Building & Renovation
(E) Engineering & Retrofit
(I) Industrial Construction & Renovation
(L) Homebuilding & Remodeling
(D) Contract Interiors

L
Leviton Mfg. Co., 8; 71
(800) 323-8920
Lighting Services, Inc., 56; 84
Lutron, 24; 78
(800) 523-9466

N
Neo-Ray Lighting, 53; 80
(718) 445-5492
Noral Lighting, Inc., 6; 69
(800) 676-3945

P
Peerless Lighting, 20; 75
(415) 845-2760
Philips Lighting, Cov. III; 102 [E]
(800) 631-1259
Poulsen Lighting, Inc., 17; 72
(800) 342-2310

Q
Quality Lighting, 23; 77
(800) 375-7632

R
Rejuvenation Lamp & Fixture
Co., 57; 101 [G]
(503) 231-1900

S
SPI Lighting, Inc., 7; 70
(414) 242-1420

T
Targetti, Inc., 52; 79
(800) 526-6990

Z
Zumtobel Lighting, 19; 74
(201) 340-8900

Sales offices

Main Office

McGraw-Hill, Inc.
1221 Avenue of the Americas
New York, New York 10020

Director of Business and Production
Joseph R. Wunk (212) 512-2793
Fax: (212) 512-4256

Publisher
Roscoe C. Smith III (212) 512-2841

Classified Advertising
(801) 972-4400

Administrative Assistant
Anne Mullen (212) 512-4686

District Offices

Atlanta
4170 Ashford-Dunwoody Road
Atlanta, Georgia 30319
Gregory Bowerman (404) 843-4781
Fax: (404) 252-4056

Los Angeles
Media Sales Associates
1493 Temple Hills Drive
Laguna Beach, Calif. 92651
William Hague (714) 494-8419
Sherylen Young
Fax: (714) 497-7261

Chicago
2 Prudential Plaza
180 N. Stetson Ave.
Chicago, Illinois 60601
Thomas P. Kavooras, Jr.
(312) 616-3338
Fax: (312) 616-3323

New England/New York
1221 Avenue of the Americas
New York, New York 10020
Louis Kutscher (212) 512-2814
Frank Rose (212) 512-2409
Fax: (212) 512-4256

Cleveland/Philadelphia/Pittsburgh
1221 Avenue of the Americas
New York, New York 10020
Frank Rose (212) 512-2409
Fax: (212) 512-4256

New York
1221 Avenue of the Americas
New York, New York 10020
Laura Viscusi (212) 512-3603
Fax: (212) 512-4256

Dallas/Houston
2 Prudential Plaza
180 N. Stetson Ave.
Chicago, Illinois 60601
Thomas P. Kavooras, Jr.
(312) 616-3338
Fax: (312) 616-3323

San Francisco/Seattle
Media Sales Associates
9017 Peacock Hill
Gig Harbor, WA 98332
William Hague (206) 858-7575
Fax: (206) 858-7576

The Marketplace/Product Literature Showcase

Kevin Beatty
John Haddock
1-800-544-7929
Fax: (212) 512-4256

Introducing the **MASTER** *line*™ Collection from Philips Lighting.

A stroke of Halogenius.

The innovative Masterline Collection of high-performance halogen lamps answers the growing market need for premium quality halogen lamps that offer energy savings, increased light output, and greater efficiencies from existing lighting fixtures.

Masterline Square MR-16 lamps use substantially less energy than comparable MR-16 lamps, with the same lighting results. Masterline Round MR-16 lamps offer as much as 33% more light output than



standard MR-16s without increasing energy use. New Masterline Collection PAR 30 and 20 halogen lamps replace standard PAR and reflector lamps. They deliver more light out of recessed fixtures through an exclusive **long neck** design which allows retrofit without adapters.

Put some Halogenius into your accent lighting sales with the new Masterline Collection. For details on this innovation, call the Philips Lighting team at **1-800-631-1259**.

OFFICIAL SPONSOR
1992 U.S. OLYMPIC TEAM



Philips Lighting



Circle 102 on inquiry card

PHILIPS

It took  to make the Lamp...
It took CSL to Turn It On!

...and on!



...and on!

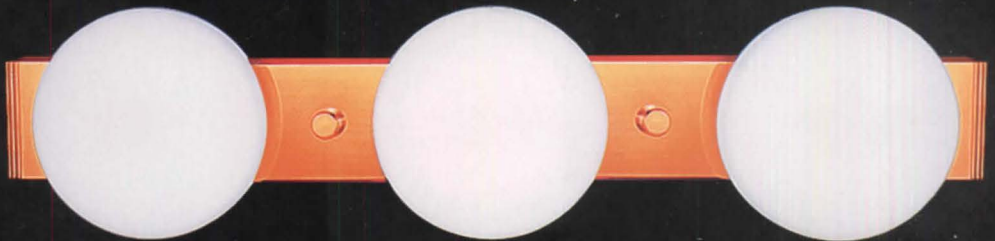

...and on!



Meeting the lighting challenges of the nineties...
a bold new concept in Corridor, Room Entry, Bath/Vanity,
and Recessed fluorescent illumination.

- Corridor / Room Entry fixture meets all requirements of Americans With Disability Act. (3-1/2" Projection)
- All surface mounted fixtures are available in Polished Brass, Polished Chrome, or White, and utilize either 10 watt or 21 watt 2D lamp(s).
- High power factor electronic 'instant-on' ballast.
- Triplex Glass or Acrylic Diffuser
- 8,000 hr. lamp life - 15,000 hr. with continuous burn.

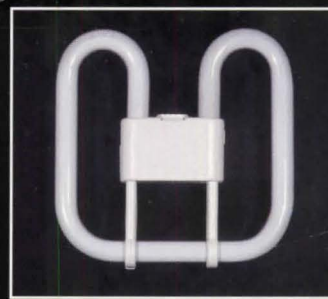

- 10 Watt 2D = 50 Watt Incandescent
- 21 Watt 2D = 100 Watt Incandescent
- 2700° Kelvin Same as Incandescent!
- 82 CRI - 65 Lumens per Watt

CSL LIGHTING MFG.®

25070 Avenue Tibbetts, Valencia, California 91355-3447

Telephone: (805) 257-4155 • FAX: (805) 257-1554

Circle 103 on inquiry card