

May 1952

house+home

edition

Marcel Breuer

Some lessons for everybody from an "architects' architect" (below and p.102)

Garden apartment

16 ideas to give more for less (p.128)

Remodeling

Good modern gives good Regency a lift (p.152)

Instead of a company town

Employer helps workers save \$5,000 on good homes of their own (p.122)

Mortgage crisis

Will money be easier and cheaper soon? (p.116)

A lesson for big builders

Small tract builders get individuality at low cost (p.118)

Builders' flattops

Some architect suggestions to better their design and appearance (p.146)

For defense workers

A big Northern builder challenges the South to build better (p.156)

CHAS. W. CONNELLY
ARCHITECT & ENGINEER
CHARLOTTE, N. C.



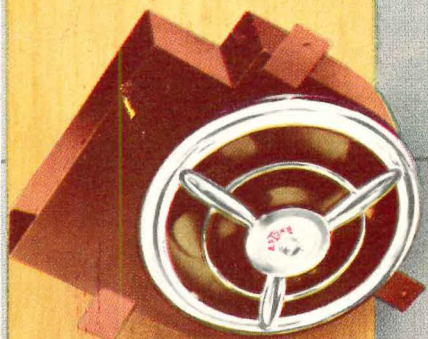

NUTONE VENTILATING FAN
MODEL 830 • \$26.50 LIST
15 Wall and Ceiling Models



NUTONE DOOR CHIME
MODEL K-16 • \$7.25 LIST
14 Models for Kitchen,
Hallway or Living Room



NUTONE HEAT-A-LITE
* U.S. and Foreign Patents Pending
MODEL 900 • \$49.95 LIST
A revolutionary new electric ceiling
heater and overhead light.
One of 10 Models

NUTONE'S
\$84.95*
OR LESS
AT LIST
PACKAGE

NUTONE

* The NuTone package includes Model 830 NuTone Ventilating Fan at \$27.75 list (or Model 830 NuTone Ventilating Fan at \$26.50 list); a NuTone model K-16 Door Chime at \$7.25 list; and a NuTone Heat-A-Lite Model 900, at \$49.95 list — ALL INDIVIDUALLY PACKAGED.

Even the Lowest-Priced Houses Can Afford These Three NuTone Products

Let these 3 NuTone Products make YOUR low cost homes MORE ATTRACTIVE, MORE COMFORTABLE, and MORE SALEABLE!

For only \$84.95* or less (at list prices) . . . you can include . . . A NUTONE VENTILATING FAN to eliminate kitchen grease and cooking fumes . . . A NUTONE DOOR CHIME, for a friendly musical greeting at the front door . . . and A NUTONE HEAT-A-LITE, the revolutionary new Electric Ceiling Heater for "toasty-warm" bathrooms, and other hard-to-heat rooms.

FREE

Get complete details, including free literature, diagrams, specifications and data for installing NuTone Ventilating Fans, Door Chimes, and Electric Ceiling Heaters.
NUTONE, INC., Dept. HH-5, Cinti. 27, O.

Heat-a-lite
NUTONE
Door Chimes Ventilating Fans

May, 1952

Published by TIME Incorporated

EDITOR-IN-CHIEF Henry R. Luce
 PRESIDENT Roy E. Larsen
 EDITORIAL DIRECTOR John Shaw Billings

THE MAGAZINE OF BUILDING
 ARCHITECTURAL FORUM Edition
 and
 THE MAGAZINE OF BUILDING
 HOUSE & HOME Edition

EDITOR AND PUBLISHER
 P. I. Prentice

EDITORIAL CHAIRMAN
 Douglas Haskell, AIA

EXECUTIVE EDITORS
 Joseph C. Hazen, Jr.
 Suzanne Gleaves

ART DIRECTOR
 Paul Grotz

ASSOCIATES: W. C. Bixby, Peter Blake, Gurney Breckenfeld, Louise Cooper, Virginia Forsythe, James P. Gallagher, Mary Jane Lighbown, Walter McQuade, Harry J. Middleton, Carl Norcross, Boyce P. Price, Vernon Read, Richard Saunders (Washington), Ogden Tanner, Warren Unna. (In military service: Wilson Dizard.)

ASSISTANTS: Rosalind Klein Berlin, Marilyn Grayboff, Henry T. Martin, Alice O'Connor.

ART STAFF: Associate Directors: Amnon Rubinstein, Madeleine Thatcher, Nina Rittenberg. Assistants: Martha Blake, Linn Ericson, Jan V. White, Hannelore Teddie Wolf.

MARKET RESEARCH DIRECTOR: Arthur S. Goldman.

CONSULTANTS: Miles L. Colean, Ruth Goodhue.

CIRCULATION MANAGER: Walter F. Gruening.

PRODUCTION MANAGER: Lawrence W. Mester.

GENERAL MANAGER
 Robert W. Chastaney, Jr.

ADVERTISING DIRECTOR
 George P. Shutt

ADVERTISING MANAGER
 Richard N. Jones

THE MAGAZINE OF BUILDING, HOUSE & HOME Edition, is published monthly by TIME Inc., Time & Life Building, 9 Rockefeller Plaza, New York 20, N. Y. Yearly subscription payable in advance. To individuals or firms (and their employes) engaged in building—design, construction, finance, realty; material distribution, production or manufacture; government agencies and supervisory employes; teachers and students of architecture and trade associations connected with the building industry; advertisers and publishers: U.S.A., Possessions and Canada, \$5.50; Pan American Union and the Philippines, \$9.00; elsewhere, \$12.00. To those not connected with the building industry; U.S.A., Possessions, and Canada, \$9.00; elsewhere \$17.50. Single copies, if available, \$1. All copies mailed flat. Copyright under International Copyright Convention. All rights reserved under the Pan American Copyright Convention. Entered as second class matter January 11, 1952 at the Post Office at New York, N. Y. Copyright 1952 by TIME Inc.

TIME Inc. also publishes TIME, LIFE and FORTUNE. Chairman, Maurice T. Moore; President, Roy E. Larsen; Executive Vice President and Treasurer, Charles L. Stillman; Executive Vice President for Publishing, Howard Black; Vice Presidents, Allen Grover, Andrew Heiskell, C. D. Jackson, J. A. Linen, P. I. Prentice; Vice President and Secretary, D. W. Brumbaugh; Comptroller and Assistant Secretary, A. W. Carlson; Manager, MARCH OF TIME Division, A. R. Murphy.

VOLUME 1, NUMBER 5

53 NEWS

74 LETTERS

94 BEHIND THE BLUEPRINTS

101 EDITORIAL

102 Marcel Breuer, teacher and architect

His plans are subdivided according to use

His materials soften a stern geometry

His color accents are bright

His stairs and fireplaces are sculpture

His detailing is consistent; his open spaces are intimate

His houses reach for a view of nature

116 Money for mortgages, by Dr. Marcus Nadler

118 Small builders create small neighborhoods

122 Instead of a company town . . .

128 Open plan apartments: 16 ideas for multistory living

134 No beams in the roof

138 A monumental study of today's architecture, a review by Frederick Gutheim

142 Good design sells the low cost market

146 An architect designs (1) for builders, (2) for clients

150 Bookkeeping for the small builder, by R. L. Brummet and D. A. Thomas

152 Regency remodeled

156 The South—new building frontier

160 Brick for the price of frame

168 REVIEWS

182 PRODUCT NEWS

206 TECHNICAL PUBLICATIONS

NEXT MONTH HOUSE & HOME WILL PUBLISH:

A special section on what is new in heating and air conditioning.

It will include the first field survey ever made of how summer cooling is helping builders to sell houses.

Another feature will be: "How to design a house for central air conditioning."

Cover: House by Marcel Breuer, Architect. Photo: Ben Schnell



AN INVITING PATIO, window walls, wide overhanging eaves, a "garden cabaña" for storing tools, and eye-level windows in bedrooms are a few of the many features that won title "Best for Family Living" in a national contest by Parents' Magazine.

TYPICAL "AMERICANA" FLOOR PLAN illustrates "open" arrangement that makes the most of available space. Paneled fireplaces and completely equipped kitchens are standard. Architect was Arnold Kronstadt.

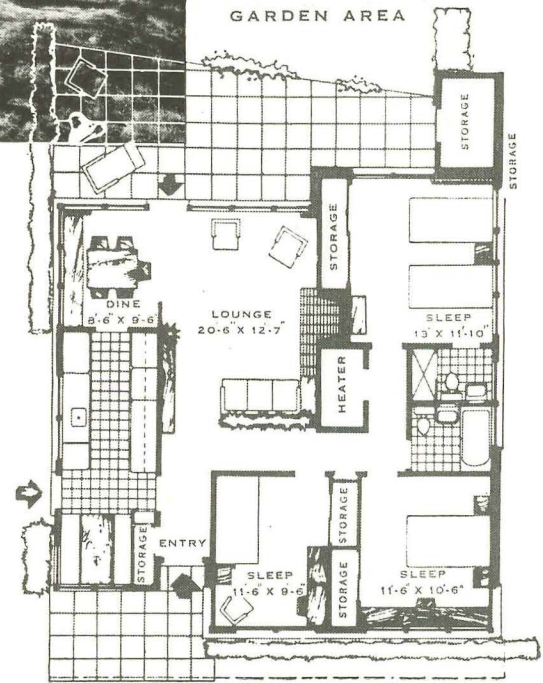

NEW WAY TO LIVE..PROVED WAY TO SELL

Contemporary design and the comfort of adequate insulation turn Freeman buyers into enthusiastic salesmen

Take a good look at the house above and the floor plan at the right. See why over 60% of Carl Freeman's new home prospects are referred to him by present owners?

Everything about his "Americana" homes at Bethesda, Maryland, bears the hallmark of quality. Take insulation, for example . . .

Buys in large quantities. Freeman says, "Like most operative builders, we buy in volume. And that's one of many reasons we like Fiberglas® Building Insulation. It's compression packed. So, we store a lot in little space. It's also fire safe, tops in efficiency, easy to install. And—based on our experience—a definite selling feature for our homes.

"We've used it in our Alta Vista and other developments and plan to use it for our Parkwood project now under construction."

Good advice for any builder. Build your sales talk into the house, too. Insist upon Fiberglas Building Insulations—available nationally from dealers of these firms:



Owens-Corning Fiberglas Corp., Dept. 67E, Toledo 1, Ohio. Co-sponsor Housing Research Foundation, Southwest Research Institute.

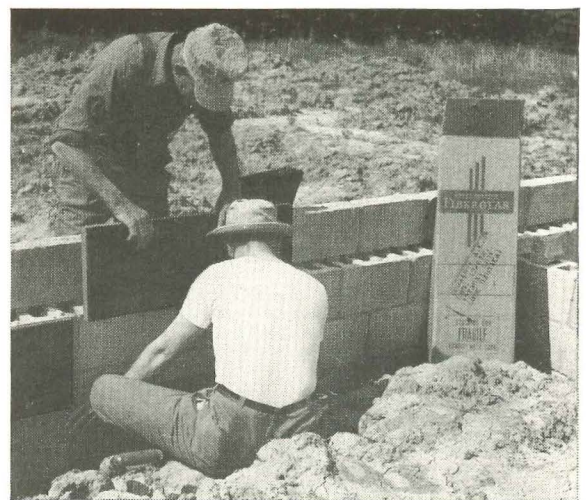

BASEMENTLESS MODELS ARE PERIMETER INSULATED. States Mr. Freeman, "Uninsulated concrete slabs feel cold and damp, waste fuel. Make sure of more comfortable floor and you make sure of happier, more satisfied buyers." Best solution: Fiberglas Perimeter Insulation! It meets FHA requirements, is highly efficient, does not rot or decay.

*Fiberglas is the trade-mark (Reg. U.S. Pat. Off.) of Owens-Corning Fiberglas Corporation for a variety of products made of or with fibers of glass.



OWENS-CORNING
FIBERGLAS

is in your life..for good!

Summer Easing of Reg. X Seen; Steel Squabble May Extend CMP

Economic controls began crumbling. Even though the steel strike lasted only three days, the uncertainties arising out of it could well delay prospective further relaxation of materials' controls on steel for homebuilding and the end that was in sight to the ban on recreational construction. But the long range outlook was still for less and less strait-jacketing of the building industry.

Likeliest candidate for early relaxation seemed to be Regulation X, long damned by NAHB and NAREB as unnecessary. The Federal Reserve Board, having revoked the Regulation W requirement for a 10% down payment on home modernization loans and ended installment buying controls on purchases up to \$100, last month started restudying the over-all impact of its credit brakes on buying. Within two months, predicted one federal official, the board will take "at least some action to ease the (Regulation X) situation."

Signs of slumping business prodded the Board along. For instance:

- ▶ Both General Electric and Westinghouse cut back refrigerator production, blaming poor sales.
- ▶ In Los Angeles, builder S. V. Hunsaker advertised a price cut on his three-bedroom homes from \$25,000 to \$20,000.
- ▶ In Chicago, Vice President T. V. Houser of Sears, Roebuck gloomed: "If there's an increase in steel prices, metal goods (like appliances) will be priced right out of the market."

How much cutback? One informed Washington forecaster predicted: "Credit controls are certain to be substantially relaxed sometime during the summer. The prospect is that Regulation W will go off entirely; that a 2/3 loan-to-value ratio will be permitted on commercial building; and that a similar limit will be applied to houses over \$15,000 with perhaps some further reduction below \$15,000."

Other Washington prophets agreed that if the Fed slashes Regulation W, pressure to do the same to Regulation X would be irresistible. If the Federal Reserve didn't, Congress would, in extending the Defense Production Act.

Consumer plans. On the other hand, Commerce Department economists viewed housing (with synthetic textiles and defense-related industries) as the "hard spots" in an otherwise soft economy. Backing up

IN THE NEWS

Among the next 14 pages are reports on these important developments:

Senate reports examine FHA, PHA . . .	p. 54
New bill asks \$1.3 billion for FNMA . . .	p. 55
Mortgage bankers see market easing . . .	p. 56
California court upholds public housing . . .	p. 56
Lumber, plywood prices firm again . . .	p. 59
HHFA bids to take over VA home loans . . .	p. 61
Builders turn to low-cost market . . .	p. 63

this outlook was the Federal Reserve's own 1952 survey of consumer finances:

"The number of consumers expressing fairly definite intentions to buy houses (new and existing) in the coming year was about the same as a year earlier. There was, however, some decline in the number of people tentatively considering such purchases. Buying plans suggest that the number of new houses that will be purchased in 1952 is about the same, or slightly less, than last year, provided that material, price, quality and credit factors do not change significantly. There is some evidence that the middle-income groups (\$3,000-\$7,500) constitute a larger proportion of the new house market in 1952 than they did in 1951. . . . Altogether, the findings point to continued strength of demand in the housing market."

Steel strike impact. The threat of a steel strike averted by government seizure of the industry combined with the three-day walk-out that ended May 2 had cost the nation the better part of two weeks steel production. Two weeks lost production, most experts figured, was about what it would take to make DPA review its allocations. Moreover, with the legality of the seizure still under review by the Supreme Court, the possibility of a strike later was not erased. About the best the industry could do was hope that DPA would stand by Administrator Manly Fleischmann's prestrike promise that CMP will be "substantially relaxed" for steel and aluminum about the end of the year. But approval of a flood of deferred commercial building projects, which was about ready for announcement when the strike began, might be postponed. So might prospects for an increase in amounts of materials obtainable for homebuilding by self-certification.

Copper eases. Fleischmann insisted copper was still too scarce to raise hopes of dropping CMP in the fall, substituting a simple priority system for defense work.

HOUSING STARTS

IN THOUSANDS OF UNITS

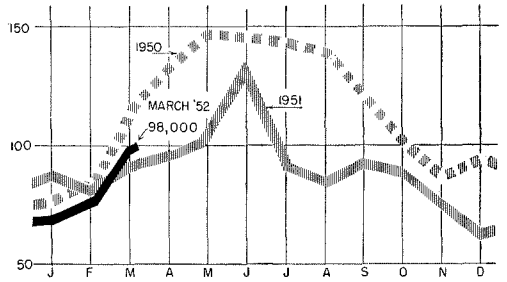

Source: Bureau of Labor Statistics

A 27% RISE in starts from February to March was smaller than usual increase for that month but the total was exceeded only by March, 1950. Private housing rose 16% to 86,000 units, promising another million-unit year for that category alone. HHFA Administrator Foley agreed his 800,000 starts "ceiling" could be "considerably exceeded."

IN THOUSANDS OF UNITS

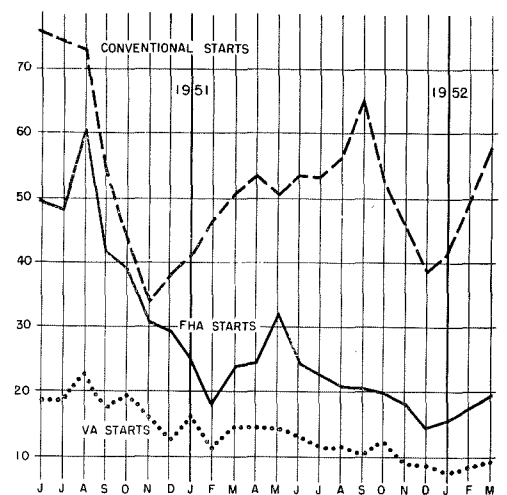

STEEPER CLIMB of conventionally financed house starts in 1952 reflected action of free vs. controlled money market. Unattractive pegged interest rate of government-insured loans depressed volume of FHA and VA's.

But the peak pinch on the red metal seemed to have slipped past, too. Premium prices of 50 to 54¢ a lb. once paid abroad had toppled to around 37¢ (still a good bit above the U. S. ceiling on imported metal of 27½¢). Flow of scrap to smelters was rising. NAHB Technical Director Leonard Haeger reported that in his monthly survey covering 15,000 housing units, the number of builders reporting copper tubing hard to get had plummeted from 28% in February to 6% in April. NPA even thawed its grip on inventories a little. It gave manufacturers permission to use copper and copper-base alloys that were in stock last July 1 for 30 building materials, including ornamental metalwork, pipe hangers, door frames.

Whatever the steel settlement might be, it would spell the end of even a good pretense at wage and price controls. From the defense stretch-out, the U. S. was moving rapidly into a twilight zone of controls.

Senate Reports Rap FHA for Tardy OK On New Ideas, Air Public Housing Costs

To keep abreast of the housing programs it has sired, the Senate Banking Committee had sent staff researchers scurrying back and forth across the country in a comprehensive scrutinizing operation. Last month its research team of Joseph P. McMurray and Raimond Bowles* reported their findings on FHA and public housing.

Gumshoers McMurray and Bowles tossed principally bouquets on FHA's prim doorstep. "Glance out of a plane window as you are about to land in any American city," they wrote, "and you will observe for miles in every direction, dotted over the landscape, the homes that FHA helped make possible." Without such aid, they figured, less than half of the three million families who have bought FHA insured houses since the agency was born in 1934 would have taken the plunge. In this same period, reflected the two researchers, FHA has given tenants a better break by paving the way for the construction of 561,000 rental units at monthly charges within pocketbook reach.

Housing costs too much. Not all the findings were laudatory. The staffers still felt there was too much of a "gap between the income of the average worker and the cost of modern housing." As an example, they cited the case of a diemaker in a Naval shipyard in the San Francisco Bay area who they said receives take-home pay of about \$81 a week counting overtime. Such workers, they charged, could not find a modern two-bedroom apartment within reasonable commuting distance of the Navy yard for less than \$105 a month.

This rent level, they concluded, was beyond the range of the average worker. Moreover, they complained, no existing housing was available in the area. Dismissing the alternative remedies of pay boosts and subsidized public housing, they ended with what they felt was the only feasible suggestion: reduce housing costs through new materials and techniques plus code standardization and modernization.

Old mistake. To builders who scanned the report, it seemed clear that the research team had fallen into the fallacy common to housing critics of assuming that all families needing shelter should be accommodated in new construction. The industry fully agreed that it should try harder to drive down costs. It nonetheless felt that the banking committee should keep its

* Bowles has since relinquished his post with the committee to lend his talents to the Eisenhower campaign.

thinking straight in the matter; should realize that if millions of families can satisfy their daily transportation needs with used cars those in the lower income brackets should look to older (and cheaper) housing rather than brand new apartments for at least a temporary solution of their housing problem.

For FHA: a needle. What evoked the loudest cheers from the private building fraternity was the researchers' mild reproof to FHA for being too poky in accepting innovations and changes. McMurray and Bowles had fired persistent questions at FHA field officials on subjects like prefabrication, use of new materials and methods, co-operative housing ventures. Their conclusion: "Too frequently we got responses of 'you can't tell yet,' or 'it will need a lot more improvement,' or 'we need much more experience with it,' or 'people won't accept it.'"

Admonished the report: FHA was established not merely for the purpose of insuring the ordinary risk the average mortgagee would not take; "it should pay more attention to its social responsibility of providing better, more efficient, and more economical housing for an ever increasing number of citizens." Other conclusions:

▶ The 608 wartime program was sprinkled with abuses although there were mitigating circumstances.

▶ Urban redevelopment has not been given much of a tumble.

AN INFLUENTIAL AUTHOR

Joseph P. McMurray, staff director of the Senate Banking Committee and co-author of the two provocative reports on housing reviewed here, is a figure of increasing importance in the high councils of U.S. housing policy. Committee Chairman Burnet Maybank leans heavily on McMurray's judgment and fact. The simple explanation is that McMurray is 1) a human dynamo with a keen mind, 2) the rare gem of a staffer who can bring out of a committee wangle a speedy report on which all sides can agree. Result: McMurray finds himself courted by every organization with an interest in housing, from NAREB to the CIO. A modest man, McMurray would probably deny that he is a power behind the scenes, but he is.

Background: born in New York in 1912, graduated from Brooklyn College in 1936. Before coming to Capitol Hill in 1945 as technical consultant to the House Labor Committee, he was with the Bureau of Labor Statistics, and the National Resources Planning Board. He has been with the Senate Banking Committee four years.

▶ A good start has been made in applying Section 8 of Title I—the minimum house section involving 95% mortgages on houses costing up to \$5,000.

For public housing: praise. To the Public Housing Administration, McMurray and Bowles addressed much praise, less criticism. In most cities, they found, total development cost of public housing projects ranged from \$9,000 to \$13,000 per family unit. The nation-wide average was \$10,600.

Looking around for the reasons for these too-high costs, the researchers were given a variety of alibis. One was that most projects were located in the central more densely populated areas where land costs were high. In most cases, the land had to be cleared of slums or run-down commercial buildings. Another explanation: the average public housing unit ran a little larger than comparable private housing. Said the researchers: "Every project we visited had a good number of three and four bedroom units, whereas most private projects had few, if any."

The Senate investigators observed critically that some costs inherent in public housing in the central sections of cities could have been written off if there had been better co-ordination between the public housing and urban redevelopment programs. They also flung caustic comments at the law which makes projects oust "over-income" families. "The tragedy of it," the report complains, "is that there are few if any accommodations which these over-income families can afford."

FHA FIRES appraiser, clerk for private apartment deal

For the fifth time in five months, the ax fell on FHA personnel.

Edward A. Dwyer, \$5,000 a year appraiser in FHA's Binghamton, N. Y. office, was dismissed for "outside activities." At first FHA Buffalo Chief William Denne defined this as working as a private architect on the side. Later Washington FHA spokesman Donald Alstrup insisted Dwyer was fired for owning stock in two FHA-insured Binghamton rental housing projects. Earlier FHA casualties: Frederick D'A. Carpenter, director for Puerto Rico; the late R. Earl Peters, state director for Indiana, both fired; and Herman E. Bailey, South Carolina director, who resigned while under investigation. The new Puerto Rico director, as of May 1, is Ogden C. Wilkerson.

Also fired was Ruth B. Finney, a stenographer-clerk in the Binghamton office. FHA asserted she assisted in showing Dwyer's apartments to prospective tenants and helped collect rents.

FHA APPLICATIONS, PERKING UP, FORGE AHEAD OF VA

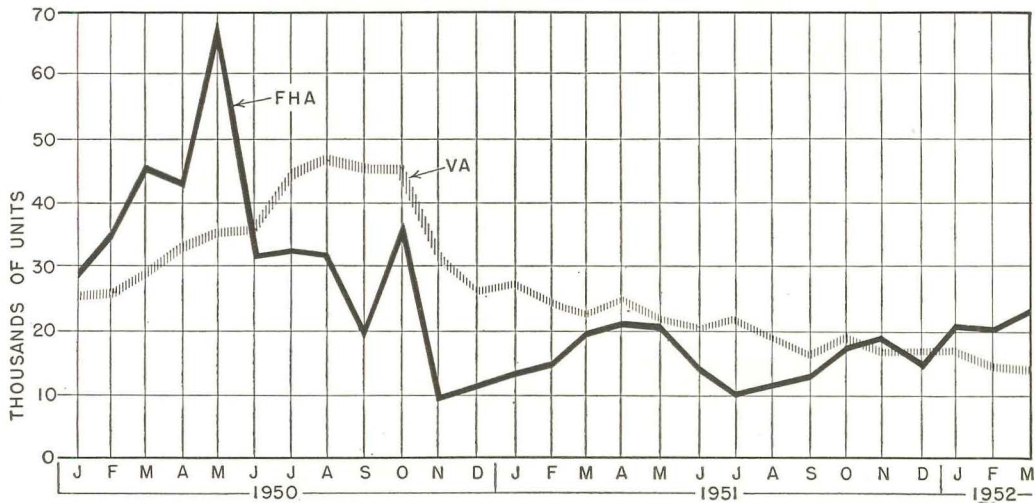

RECENT RECOVERY in volume of FHA applications for new one to four family units reflects spotty re-entry into market of some lenders (e.g. insurance companies), who prefer these to

answer was that they had just allowed for cuts.

Opposition seen. Moreover, some segments of the private building industry would offer stiff opposition to Maybank's omnibus bill. NAHB was unhappy over the boost for Title III public housing. Mortgage bankers were not expected to protest the Fanny May increase, though in principle they don't like it. The American Bankers Association and U. S. Savings & Loan League, however, will. There was a serious question whether the House would go along on Fanny May, too.

The \$2.6 billion that appropriation committees can't touch will, if enacted, put an extra load on the U. S. budget. Even HHFA officials conceded it was inflationary. But so, they argued, is the whole defense program.

WHO BOUGHT 1951's MORTGAGES

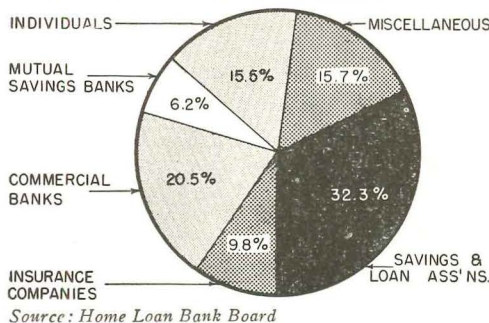

MORTGAGE RECORDINGS for 1951 underscore the increasing volume of home loans made in recent years by mortgage bankers and trustees, grouped under "miscellaneous." Obscured is the large volume of mortgage loans made for insurance companies but recorded by local mortgage bankers, enough to almost double the 9.8% insurance company share. Insurance firms increased VA holdings in 1951 more than any other type of lender, now hold the largest portfolio of GI loans. Savings and loan associations, responsible for nearly a third of the nation's housing mortgages, invest mainly in conventional and VA loans, largely ignore FHA's.

lower-interest-bearing VA's Appraisal requests for VA's are rising, but these mirror builders' expectations, rather than condition of money market.

MORTGAGE CONFERENCE: interest rates show signs of drop

In the year since the Federal Reserve yanked its support away from government bonds, lanky mortgage banker Will A. Clarke of Philadelphia has been in the front of his industry's fruitless fight for higher FHA and VA interest rates. Last month in Manhattan, at the Mortgage Bankers Association's annual eastern mortgage conference, Expert Clarke threw in the towel. "I hate to admit it because I hate to get licked," he told a mortgage outlook panel (see photo, page 55), "but . . . the only thing that would upset the trend to lower interest rates is if the government tries to finance a big deficit with long term bonds." There was lots of evidence that canny Quaker Clarke was right again:

► Yield on long-term nonbank government bonds, sinking since a January peak of 2.74%, fell to 2.63% in the third week of April.

► Mortgage recordings for February (latest tabulated) set a new high mark for that month at \$1.2 billion. Even more significant, February was the first month since last May to show a gain over the corresponding month of 1951.

► Yields in the corporate bond market—as Clarke noted—have dropped "10 to 25 basis points since January, in the face of what is a seemingly tight money market."

► Increasing pressure of the greatest saving spree since World War II was beginning to force investors to look for mortgage outlets. One sign of it: mortgages available for immediate delivery were again commanding a small premium around New York.

Clarke offered mortgage brokers this advice: "I wouldn't sell VA loans at 96 and 97 . . . That's hysteria. They have to sell at a discount, but not that much. A VA loan at 98 equals the FHA rate. The market for FHA's? Some at par or better, some at 99, none lower."

Watch the Treasury. A double-barrelled

prediction came from Dr. Marcus Nadler, finance professor at New York University (see p. 116): 1. The buyer's market that already had struck textiles and hard goods will spread throughout the U. S. economy—including homebuilding—no later than next year so "1953 may be a repeat of 1949 business conditions;" 2. The future supply of money seeking mortgage investment will hinge chiefly on the Federal deficit. If Congress trims \$6 or \$7 billion out of Truman's budget (as seems likely), the Treasury can avoid going into the long-term money market for the cash it will have to borrow. "In this case," concluded Nadler, "the demand for mortgages is bound to be very great. So the increase in money rates is temporary . . . should ease at the end of this year or first of next."

Boost for private FNMA. The two-day session also produced a new spate of endorsements for creation of a private central mortgage bank—long an industry goal to help balance the concentration of money in New York and New England against the lack of it in the West and South. Assistant HHFA administrator Neil Hardy, bemoaning the "close correlation" between Fanny May takeouts and defense housing starts, spoke of a central bank as "more fundamental answer to the problem" than Fanny May. Agreed panel moderator Clarke: "(a central bank) is a spot where there needs to be a change in our over-all thinking and handling of mortgage situation." Director T. B. King of the VA's loan guaranty division, who in February challenged MBA to concentrate on forming a private mortgage bank, summed up the argument: "The flow of mortgage money will continue to be spotty areawise until a central mortgage bank is established by private industry."

PUBLIC HOUSING: court upsets Los Angeles vote to end contract

April's round of public housing battles looked like a draw.

► Last Dec. 26, Los Angeles' city council voted 8-7 to break its \$110 million contract with the L.A. Housing Authority for 10,000 public housing units. Within hours, public housers petitioned California's supreme court for a writ of mandate compelling the city to live up to its contract, originally signed in 1949. Their argument: the council's resolution breaking the contract was illegal because the contract was approved by an ordinance. Late last month, the court agreed, unanimously ordered Los Angeles to proceed with the projects. Slapping down the city council's argument that public needs had changed since 1949, the court noted that the 1950 census showed "there were 69,000 families in substandard homes" in Los Angeles.

► The California decision—first high court ruling of its kind in the U.S.—could well produce a chain reaction. Following Los Angeles' lead, the city council of Indianapolis had voted to kill

COFAR

... Combined reinforcement and form for concrete floors and roofs in a single product.

CORRUFORM

... the light-weight permanent steel form for concrete floors and roofs.

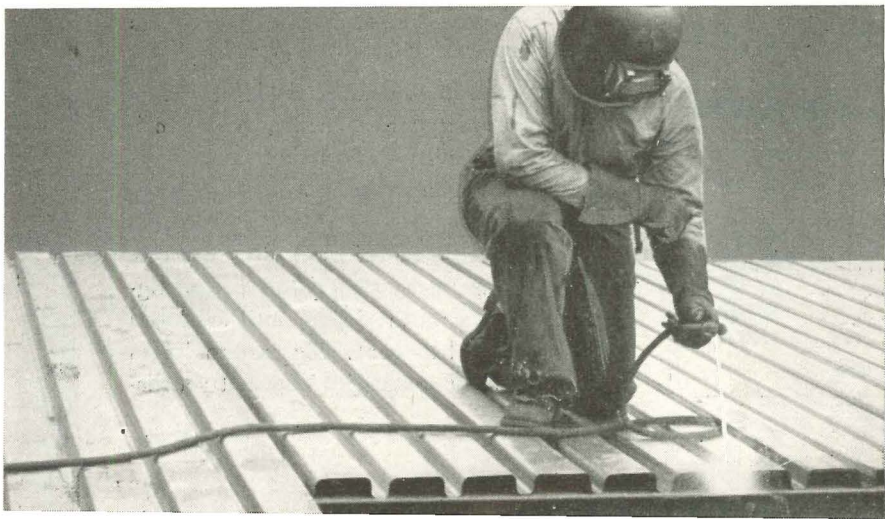
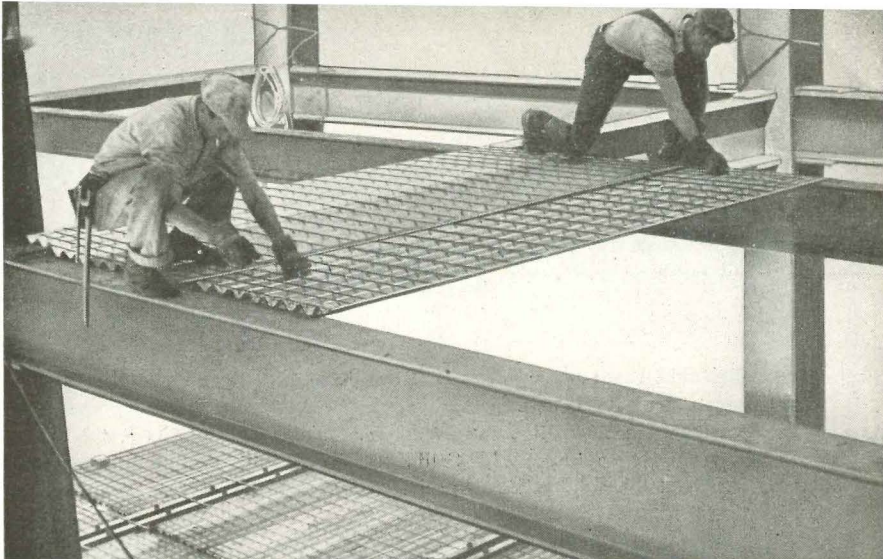

THEY'RE ALL IN THE FAMILY

Here are Four Granco Products for Your Needs—Pre-formed Steel to make your jobs stronger, better . . . faster

And "tough-temper" steel is the answer. Yes, high-strength, light-weight steel is one of the reasons that the Granco family of four building aids do a better job for you. For Granite City Steel, parent-company of Granco Steel Products Company, has developed a specialized steel to fit right in the building products picture.

Because it's manufactured from a low-carbon steel to begin with, Granco "tough-temper" does not require critical alloying to gain its high tensile strength. Instead, controlled cold-rolling, with strain hardening as the result, gives high and unusual physical properties. The structure of the steel itself actually changes . . . the crystalline elements realign . . . to produce a steel with a *minimum* yield point above 80,000 psi; and an ultimate of over 100,000 psi. This is *tough* steel!

Steels like this, fabricated into products like those illustrated on this page, mean more than marks on a blueprint. For construction people they mean simplified and more economical construction, savings in materials and labor. To your clients they mean better structures as an end-result.

We'll be glad to tell you more about any Granco product you are interested in, just write Department 11-3, you will get a speedy answer. For helping you is the most important part of our job. It's our way of saying "thanks" for specifying Granco.

TUF COR

... the ideal long-span permanent steel base for light-weight insulating concrete.

GRANCO ROOF DECK

... the rotary-press formed flat-top roof-decking.

GRANCO STEEL PRODUCTS CO.

(Subsidiary of Granite City Steel Co.)
Granite City, Illinois

See our listing in Sweet's Catalog

playing eagerness to buy, either. Explained Vice President John J. Scully of Chase National Bank: "It always takes a while for the institutions to get into a new FHA title. They have to kick it around six or seven months, consider it, weigh it, and then they plunge."

The \$52 million precommitment authority for Federal National Mortgage Association (signed into law by President Truman April 9) would bail out builders in southern and western states who were left without takeouts on their defense homes when Fanny May ran out of money Dec. 27. But that would provide mortgages for only 6,385 of the 80,000 homes so far programmed. The real relief promised by Sen. Burnet Maybank's bill adding \$1.3 billion to Fanny May's precommitment authority looked many months more away. Meanwhile, financing would remain defense homebuilders No. 1 headache. And with only 12,600 homes started because of mortgage problems, lack of community facilities and wrangles with FHA over valuations, builders would do well to build 70,000 units this year. Another \$300 million on top of what Fanny May has already would finance that.

PROBES: Rains group finds shoddy housing in Oklahoma, Texas

Conscientiously keeping its sleeves rolled up during its Easter vacation, the House's Rains sub-committee carried its hearings on shoddy VA and FHA housing to the Southwest. It found the same story: a few bad builders bringing discredit on all the rest.

▶ In Oklahoma City, Congressmen discovered that VA, relying on fee appraisers who only looked at individual sites, had approved a development at nearby Bethany which had no over-all drainage plan. Result: 16 GI homes were flooded during a May '51 storm, forcing their owners to build mud dikes around them, Boy Scout-style. Developer Floyd Payne, an ex-grocer, testified he took the building sling "to send the kids through college." (From 35 homes, he netted \$10,500, he said.) He had never heard of over-all site planning. Engineers estimated it would cost \$418,000 now to construct proper sewers, boosting the Bethany tax rate by a prohibitive \$15.76 per \$1,000. The once-buried local VA now requires site planning, drainage data for an entire subdivision.

▶ In Corpus Christi, the VA told the Congressmen it had had its problems with Hulen H. Hunt and his Driscoll Village. Owners complained of everything from cracking floors to baseboards separating from the walls. For Mrs. H. L. Corkill, Hunt "jacked up the foundation with some rocks." To F. W. Avery, Hunt suggested: "Sell the house." Owner Brooks Lindsey testified his foundation went down only 3", that the center piling was so loose "I could stick my hand under it." An embarrassed VA official confessed VA had relied entirely on FHA inspections. After Hunt refused to repair the houses, VA last June denied him further loan certificates. FHA soon did likewise. Hunt, the South Texas

Home Builders Association pointed out, is not a member.

▶ Rains committeemen made a hasty inspection of New Orleans projects on a Sunday, were sufficiently satisfied to cancel a scheduled hearing. Next stops on the probe itinerary: San Diego, Chicago, possibly Los Angeles and Detroit. The committee has already been to New Jersey, New York and Florida.

Since adverse testimony on GI homes was brought before the Rains Committee at its New Jersey hearings, the New Jersey Home Builders Assn. has been hastily self-policing. In March, the association and the VA announced a "responsibility agreement" (H&H, Apr. '52, p. 37) providing a year's guarantee on septic tanks and heating units, a year's maintenance of roofs and basements against leaks and a 30-day repair period for such items as cracks and paint blistering.

Last month, the association, meeting in Atlantic City, voted to study certification of its member homebuilders. This answered demands by the AFL Building Trades and the New Jersey Assn. of Real Estate Boards for state licensing of builders. Cried Harold Goodley, president of the Home Builders League of South Jersey: "The builder is, if anything, overregulated now. If the present inspections could not insure good homebuilding, the mere fact that a builder was licensed would not make him a good homebuilder. Laws in New Jersey, if enforced, would protect buyers from fraud."

CONDENSATION: researchers say houses must handle more humidity

Condensation has become a big new problem in homebuilding. With just as many occupants, today's house is smaller so water vapor per cubic foot is greater, and tighter built, so water vapor has a more difficult time escaping; washing machines and dishwashers have joined showers as vapor producers; the greater use of glass in the modern home doesn't increase condensation but does make it more noticeable.

In March, Building Research Advisory Board called some 135 technicians to Washington to study the problem. Biggest need, delegates agreed, was better correlation and distribution of data already available. Messages they felt needed more telling:

▶ Houses have to be built to handle more humidity inside. Said one participant: "Up to now, the proper humidity has been defined as the level that doesn't damage the house . . . and to hell with the people."

▶ Vapor barriers are essential on most new houses (on the warm side so vapor doesn't soak into insulation).

▶ Forced ventilation (even in cold weather) will take care of condensation with little heat loss.

Discussing the permeability of various materials, BRAB Director William Scheick suggested an assembled wall be given a "W" (for water) rating, similar to the "U" value in insulation comparisons. Architects at the conference indicated they thought it was a fine idea.

MATERIALS, COST TRENDS

INDEX: 1926-'29=100

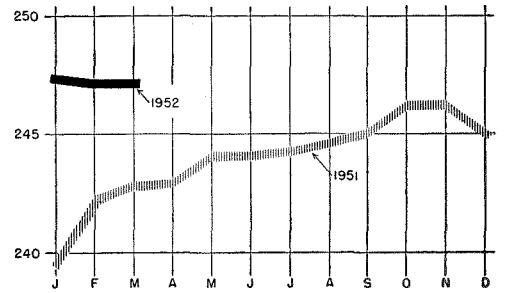

Source: E. H. Boeckh & Associates

MATERIALS PRICES (below) inched upward slightly last month while housebuilding costs (above) remained steady. But the calm may be disturbed shortly by spring construction labor pay increases and a steel wage and price rise. By next winter, however, steel production is expected to drop, suggesting softer prices eventually.

INDEX: 1947-'49=100

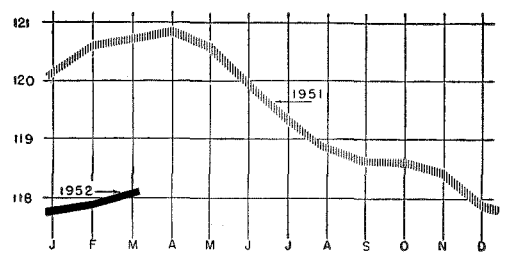

Source: Bureau of Labor Statistics

LUMBER: fir studs go up \$12, take wholesalers by surprise

It was time for a seasonal price upswing in the nation's lumber and plywood markets, but last month's \$12 boost on green fir studs (to \$71.50 per thousand feet) and \$4 to \$5 in most other green fir dimension for framing surprised wholesalers. Upper grades remained soft, but they usually pick up a few weeks after framing items.

Even the dormant door market showed signs of life in April. Producers could see at least four or five months of good business. Door production in the Pacific Northwest, source of 90% of softwood plywood doors, was hampered by a shortage of shop lumber. Mills balked at cutting shop or clears because of an "unrealistic" OPS dollars and cents price ceiling. April was wage negotiation month in western softwoods, plywood and doors. Plywood men freely forecast a price hike if higher wages were granted.

Lumbermen attributed the abrupt end of market doldrums to a combination of causes: prospects of a one million house year. NPA's unfreeze of commercial construction, a log shortage caused by last summer's long fire-season shutdowns, bad winter weather in western lumbering regions.

... from the INSULUX sketch book

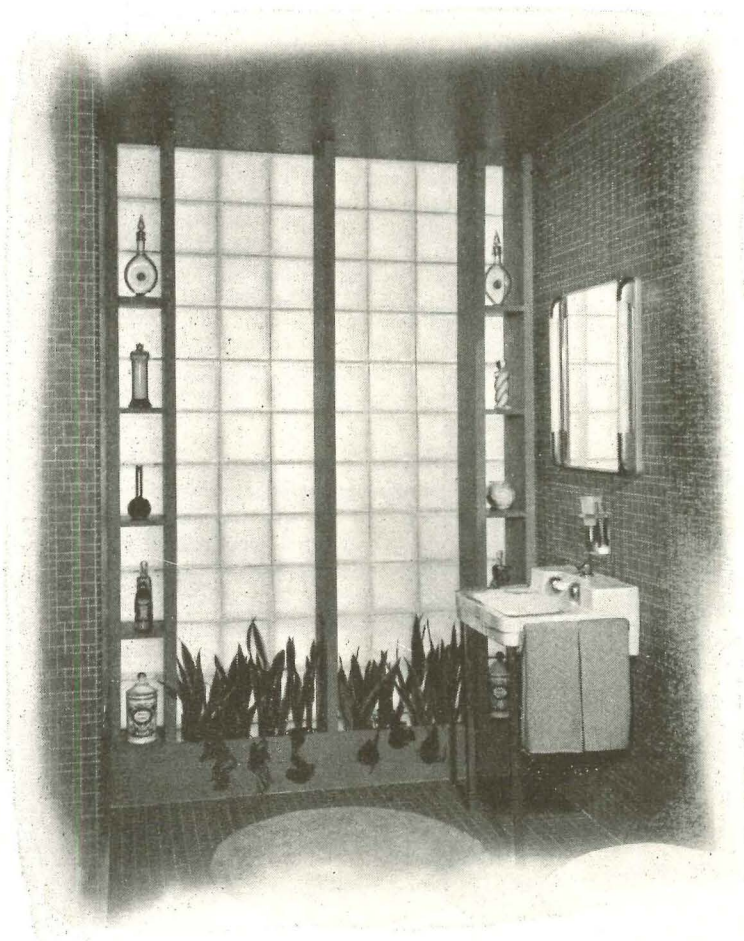

Bathroom.
8"x8" glass blocks in panel with wooden shelves and decorative flower box.

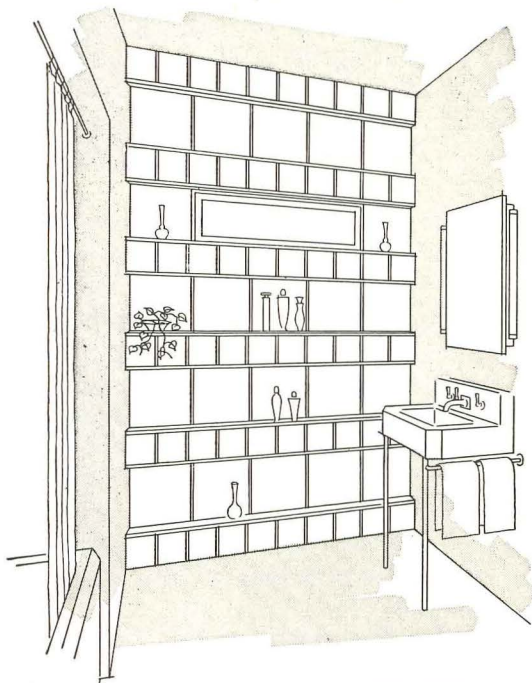

Bathroom exterior wall. Alternate horizontal courses of 6" and 12" glass blocks staggered with horizontal wood shelves between. Stock ventilating sash is set in 12" row between 5' and 6' level.

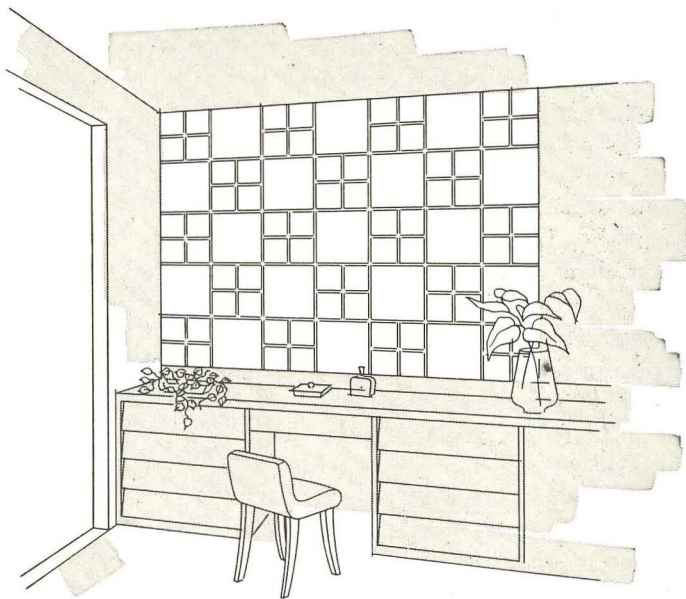

Dressing table wall. 12" and 6" Insulux glass blocks in combination.

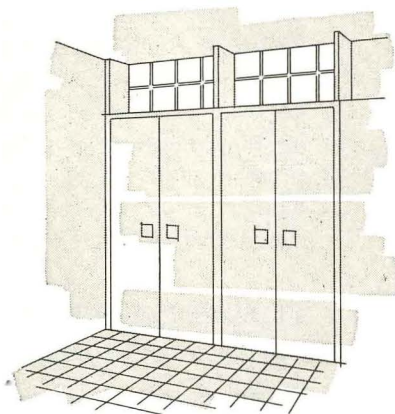

Clerestory over closet wall. 8" glass blocks above cabinets to ceiling.

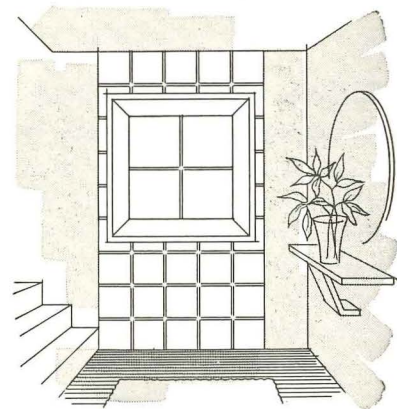

Stair Hall.
A panel of four 12" glass blocks with a frame in a wall of 8" glass blocks.

Bring daylight into homes with privacy and beauty

TO KEEP the most private room *really private* yet bright, specify attractive panels of Insulux Glass Block®.

Write to Insulux Division, American Structural Products Company, Dept. MB5, Box 1035, Toledo 1, Ohio, for specifications using Insulux Glass Blocks in these or other designs.

INSULUX GLASS BLOCK



A product of the Owens-Illinois Glass Company

Korea Vet Housing Eyed by HHFA; New Program Will Probably Go VA

Although he is already the Pooh-Bah of federal housing officialdom, HHF Administrator Raymond M. Foley seldom feels too weighted down with work to try to build his empire a little bigger. Last year, he took on the extra duty of federal flood relief co-ordinator. In December, when Rent Stabilizer Tighe Woods criticized officials planning critical areas as "second echelon moles," Foley emerged from the row with the added title of special assistant to the defense mobilizer for housing.

Bigger plum. Last month, Foley made a bid (with the potent backing of the Budget Bureau) to take over the next prospective big expansion of the veterans' home loan program: its extension to cover Korean veterans. Foley uncorked his pitch in a letter to the House Veterans' Affairs Committee, which was on the verge of reporting out an omnibus GI benefits bill including a new ten-year program of home loan insurance for persons who entered the armed forces after June 27, 1950, the cut-off date in the original GI Bill of Rights. Wrote Foley: "It has been the consistent policy of the Administration that any new housing programs authorized by the Congress should be placed within the HHFA, which was established by Congress to provide a single agency with responsibility and accountability for administration of government activities concerned with housing. . . . The Bureau of the Budget advises also that enactment of provisions of the bill extending the present housing loan guarantee program to Korean veterans would not be in accord with the program of the President unless responsibility is vested in HHFA."

Prospects dim. Although Foley's suggestion bore the logic of not having two agencies do a job that could be handled by one, few Capitol Hill observers gave it even a slim chance of being voted into law. Most veterans' organizations are cool to FHA, which presumably would get the nod from HHFA to run any veterans' loan program. Moreover, FHA missed its chance to grab the GI loan program during the reign of Commissioner Abner Ferguson (1940-45). At that time, during preliminary discussion of the Veterans' Home Loan Program, there was a plan to set up a separate title under FHA. Ferguson cried so loud on Capitol Hill that it would be awful to make FHA foreclose on veterans that Congress set up the separate veterans' program.

'Beware warranty law.' Foley would probably score better in Congress with his

other advice: tread warily at attempts to write a requirement into the new veterans' bill that homebuilders guarantee their product. "Unless the warranty is specific and clear in all respects," warned Foley, "the seller would be submitting himself to the possibility of an indefinite amount of litigation involving expense, time and inconvenience." Result, he added, would be to drive up the price of GI houses unnecessarily or drive builders out of the GI market, either of which would "defeat the purpose of the warranty." Moralized Foley in a thinly veiled dig at VA's much criticized fee appraiser system: "There is no substitute for an adequate inspection program to safeguard against shoddy construction."

The "go slow" approach had a strong Congressional champion in Chairman Olin E. Teague of the special committee that

has been investigating veterans' home and educational loans (H&H, Jan. '52, p. 50). He announced he will demand public hearings before any builder warranty clause is written into the new VA home loan program by the House Veterans' Committee. Moreover, Teague argued, no legislation at all should be introduced until after his committee and the Rains sub-committee investigating shoddy FHA and VA construction filed reports. That will be at least another month.

It looked as if this summer would be a lively time for housing legislation.

KOREAN BUNKERS PREFABBED

Assembly-line tricks of housing reached Korea last month. Prefabricated bunker kits, with lumber cut to specification in rear-line platoons, were designed by 1st Lt. Henry D. Hoyle Jr., of West Kensington, R. I. An infantryman digs a hole to meet specifications, the assembly crew brings the kit up front and the bunker provides battlefield comfort in jig time.



Reni Photos

MILITARY FAMILY HOUSING: Director Coogan measures the hurdles

After four months on his new part-time job as director of the Armed Forces Housing Agency, Ex-NAHB President Tom Coogan broke a self-imposed silence to tell HOUSE & HOME why the Pentagon still cannot provide nearly as much housing as it wants for families of the U. S.'s citizen-fighting men.

Coogan (shown above in the first group picture of the Defense Department's Family Housing Council of which he is chairman) complained that in defense areas where housing has been programmed for both civilian workers and military families, military families get the tail end of the pickings because landlords know they are likely to be transferred. So Coogan would like to see HHFA carry its programming of housing a step further, give priority on defense housing to men in uniform qualifying for quarters allowances.

Another sore spot, said Coogan, is that where FHA can be persuaded to insure homes in a military area under Title IX, it often refused to approve sites much beyond the edge of the nearest town, often 15 mi. away from the military base. FHA cannot be blamed for wanting its units close to the nearest town in case the base is closed, but military commanders fret at such long-distance commuting.

Most troublesome of all is the problem of attracting private financing to housing around

bases the Pentagon is not willing to certify as permanent, and where, therefore, no Wherry Act housing can be erected. Argues Coogan: officially permanent or not, such camps are likely to last ten years or more. So he is urging Congress to re-enact an FHA Title akin to World War II's Title VI. Under Title VI, FHA waived the requirements of permanent marketability. Under Title IX, it must consider long-range value and permanent marketability in its underwriting. But there seemed little hope Congress would vote such a change. Meanwhile Coogan is trying to persuade FHA that some of the more attractive spots in no man's land promise enough long-range stability to justify Title IX financing.

The Family Housing Council is the top level machinery for making Pentagon housing policies. The Armed Forces Housing Agency carries them out. Seated (l. to r): Lt. Col. N. Morgenthal, USMC; Stephen J. Angland, Navy; Chairman Coogan; Robert H. Richards, Air Force; John W. Mitchell, Armed Forces Housing Agency; Col. E. V. N. Schuyler, Air Force; standing: G. T. Morink, Navy; Capt. R. B. Davey; Col. A. J. Wehrell, Air Force; Marsh Cunningham, Navy; Lt. Col. R. F. Toomey, Army; Jack L. Stempler, Office of Counsel; F. C. LeGost, and W. F. Todd, Armed Forces Housing Agency.

**You can
sell houses
faster
with pretty
bathrooms**



You can add a great deal of sales appeal to your houses at very little extra cost by offering a bathroom that can double as a powder room.

In this bathroom, much of the powder room charm that appeals so strongly to the feminine prospect is achieved with the floor of Armstrong's Linoleum. A simple custom floor design, built-in fixtures, a cantilevered dressing table, and an unusual wallpaper vista give the room an appearance of luxury far beyond its actual cost. For all its feminine appeal, this bathroom has sound design features that a man will appreciate. There's ample light, an oversize shaving mirror, plenty of space to lay out accessories.

Both husband and wife will recognize the advantages of Armstrong's Linoleum as a bathroom floor. Splash-proof, easy to clean, comfortable underfoot, it's a natural choice for an area where both beauty and practicality are important considerations.

Whether you're building one house or a multiple unit project, you'll find that a colorful bathroom floor of Armstrong's Linoleum will help close sales quickly.

SEND FOR FREE ROOM PLAN. For a floor plan of this bathroom with fixture layout, color scheme description, and a complete list of furnishings, write Armstrong Cork Company, Floor Division, 1405 State Street, Lancaster, Pennsylvania.

ARMSTRONG'S LINOLEUM FLOORS

\$3,000 Homes Open 'No Man's' Market To Private Builders; Loans Are Scarce

"No man's land"—that 20% of the housing market which is served by neither private enterprise nor public development—has become a battle cry for builders seeking more business.

Said Philip M. Klutznick, founding father of the giant master-planned community, Park Forest, Ill., in a recent address to the City Club of Cleveland:

"Selfishly, the private developer must face a dual reality: Unless he soon undertakes the 'no man's land' market he may face the loss of this logical and performable assignment while he prates about a market he long ago defaulted; and unless we start moving families out of slums, the redevelopment market and the 'no man's land' market, the private homebuilding industry will have to content itself with 600,000 to 800,000 units a year instead of 1.2 million to 1.5 million."

Otherwise—"The alternative," continued Klutznick, "is to overbuild the market presently available to the private builder and bring down the whole house of cards." FHA Commissioner Franklin D. Richards agrees: "If the industry doesn't get much more into the mass market it will not be able to continue at this high level of production."

The people of builder Klutznick's "no man's land" are not just families in the low-middle-income bracket. This group of potential home buyers includes the large middle-income family; the family that can afford monthly home ownership charges but can never muster enough for a down payment; and the high-middle-income Negro family which has a tough time obtaining mortgage funds.

What's available? In recent months builders have come forth with low cost houses that should not only provide a tantalizing plum for the dwellers of "no man's land" but also for some of the low-income group. ▶ \$3,000 "San Angelo" house by builders John Moss and A.L. Turner, of San Angelo, Tex. (Nov. issue '51, p. 45) and pushed throughout the state in \$100 blueprint kits by the Lumbermen's Assn. This 550 sq. ft. house has slab floors, solid masonry side-walls. Financing of the first 52 units was planned on a \$300-down payment, ten-year payoff basis. At 6% interest, monthly payments cost \$46.40 the first three years, \$31.40 thereafter. The two-bedroom house does not include a lot, which builders offered for \$500 extra.

▶ \$3,000 San Angelo-type house by Houston builder F. W. Fuller. Also 650 sq. ft., this

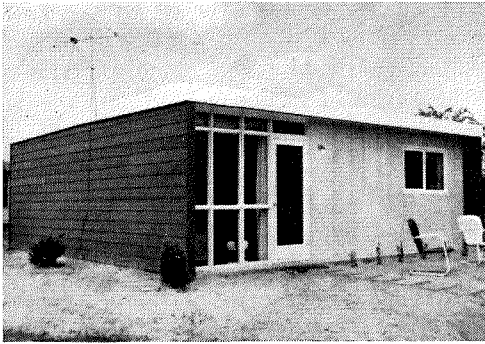

Owens Johnson

\$3,000 IN HOUSTON

house has redwood siding, 56 sq. ft. of living room glass area, a slab floor. Fuller sold 50 houses on conventional 65% loans with \$800 down payments the beginning of last month, said he could sell 300 units if the down payment were as low as \$300 to \$500.

▶ \$4,950 "Little Gem" Tropical Park Estates house by Miami's Mackle Co. The 584 sq.

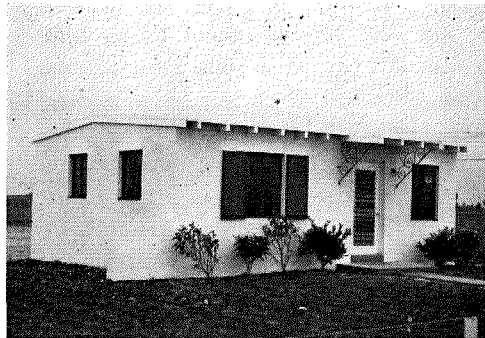

\$4,950 IN MIAMI

ft. house on a 75' x 125' lot included in the purchase price) requires a \$250 down payment, \$29.44 monthly payoff on the VA 4% plan.

In the price range just over \$5,000 (a loan under the National Housing Act's Title I is limited to \$4,750) are other low cost offerings:

▶ \$6,000 Tinker Town house by builders Dotson and Cunningham just outside Oklahoma City. This house has 600 sq. ft. plus an attached garage. The house was originally built to sell for \$5,500 under Title I. Then the builders, finding buyers had

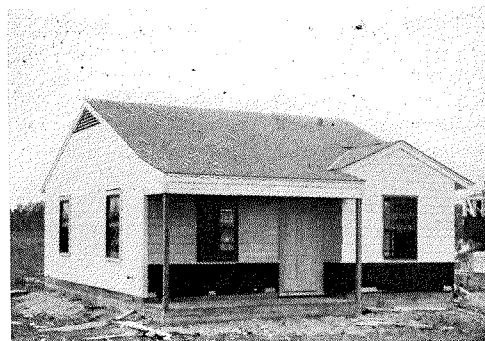

Woodallen Industrial Photographers

\$6,000 IN OKLAHOMA CITY

trouble making the down payment, brought the house up to VA standards to earn GI financing.

▶ \$5,325 Clover Leaf Addition house by Houston's Whipple Construction Co. This requires a \$575 down payment under an FHA-insured loan, \$37.50 monthly payments on a 20-year basis. The 52 units have from 624 to 672 sq. ft., carports, separate kitchens with breakfast nooks. "These are for the man earning from \$200 to \$300 per month who can now pay less monthly for his own home than one he would rent," said Whipple's builder, G. A. Dunham.

▶ \$6,000 houses by Hoag and Kimbrough, of Norman, Okla. These have 720 sq. ft., a 50' wide lot. Of the 26 units sold, all but three were financed with GI loans. Reason: the GI loan required only a \$150 down payment; the Title I's (even though their sale price was \$400 less) required the buyer to provide \$850 in cash above the \$4,750 loan ceiling.

Crowds. In almost every area where the low cost models have been shown the demand has been enormous. Some 7,000 turned out opening day to see F. W. Fuller's house in Houston. Mackle Co. had to call on Dade Co. patrolmen to handle the crowd jostling to see their "Little Gem" in Miami. And there is no denying the low cost housing market is profitable—on a volume basis. Builder Durham, in Houston, expects to make \$400 per unit on 800 units. "Eight hundred \$400's is a lot of money," he says.

The hitch. But the big hurdle in low cost housing is financing. Builder R. C. Hughes, of Pampa, Tex., has put up a number of houses selling at \$5,300, plans to build no more because it is so much trouble to sell the mortgages (one New York bank even declined to send representative to look things over). There is a big market in Portland, Ore. for \$5,500 houses under Title I, but, again, nobody in Oregon wants to buy the mortgages. Houston's Dow Zabolio is all ready to put up 75 \$5,200 to \$5,500 units but finds: "It is hard to get investors to buy mortgages even though the houses are FHA insured." Hugh Askew, Oklahoma State FHA director, who had planned a statewide series of meetings to interest builders in the low cost housing field, says: "Now we've stopped pushing the program because of credit restrictions and are concentrating on critical area defense housing."

Chicago's builder Klutznick, in planning the attack campaign on no man's land, called for a more "realistic" mortgage finance pattern—little or no down payment and the extension of amortization periods to as much as 60 years. "Mortgage bankers need a little more backbone in making such undertakings," he declared.

Jobs in Jeopardy: Truman Exit Means Shake-up in Federal Building Officialdom

When Harry Truman bowed himself out of the Presidential race he probably yanked the rug from underneath some high-ranking government office holders concerned with the construction industry. If there is a change of the party in power there obviously will be many new faces on the Washington scene. But even if the Democrats stay in, a new President will mean substantial reshuffling.

All shades of tenure. In a gigantic government payroll, like that which has been multiplying for the past 20 years, there are all shades of tenure. Not even civil service officials and personnel experts can read off the cuff the names of those who are im-



Remi Photos
FOLEY



RICHARDS

mune from the ax. Jobs, generally, fall into four categories:

- ▶ The appointive positions, like the general services administrator and the HHFA and FHA chiefs, which require Senate confirmation. Like cabinet officers, such job holders serve at the President's pleasure.
- ▶ The appointive jobs with definite terms, such as members of the Home Loan Bank Board. Courts have held that such office holders cannot be removed until their term expires except for misconduct.
- ▶ The special aides and department heads, who, through a bureaucratic code of ethics, are expected to submit a courtesy resignation when their own boss goes.
- ▶ Lesser fry whose jobs either had civil service rating (and thus antidischage insurance) to begin with or who gained it for themselves with the Ramspeck Act.

Despite the degree of tenure, the whole bureaucratic apple cart could be toppled over by a trick introduced by President Harding: a co-operative Congress first legislates the abolition of the particular office or department, then, with the personnel all brushed off, legislates its re-creation.

HHFA affected. The majority of light building agencies fall under the Housing & Home Finance Agency:

HHFA Chief **Raymond M. Foley**, who was appointed to his \$17,500 job in Dec. '47, is expected to bow out no matter what

happens to the Administration. Those close to Foley say he is tired of dodging brickbats from both public housers and private enterprise and of trying to hold onto the reins of all housing agencies at once without the power to overrule any of them. Because HHFA's constituent agencies are so much on their own, Washington dopesters figure it's not unlikely that a Republican administration would scrap HHFA entirely to save money. If Foley goes, most of the top HHFA hierarchy could be expected to resign also. Many have civil service status, but few have such protection in their present jobs. Affected will be **B. T. Fitzpatrick**, deputy administrator; **Neal J. Hardy**, assistant administrator; **Nathaniel S. Keith**, director of the division of slum clearance; and **Joseph Orendorff**, director of the division of housing research.

Chief subordinate of the HHFA is the Federal Housing Administration. Through longevity and absence of political domination, the FHA is just about as popular with Republicans as a New Deal agency can get. Because of earlier horse-trading with Congress, the bulk of its technicians—appraisers, underwriters, architects—enjoy civil service status. In a more precarious situation are the top men: FHA Commissioner **Franklin D. Richards**, appointed by President Truman August 11, 1947; Deputy Commissioner **Walter L. Greene**; Assistant Commissioner for rental housing **Clyde L. Powell**; Assistant Com-

missioner for underwriting **Curt C. Mack**; Assistant to the Commissioner **Donald M. Alstrup**; and the 72 district FHA heads, all appointed. (One is Harry Truman's brother, Vivian.)



Harris-Ewing
WOODS



Eli Aaron
EGAN

Another HHFA subordinate agency whose future seems to depend on the elections is the Public Housing Administration under **John Taylor Egan**, also appointed by President Truman. His chief aides are: **Warren Jay Vinton**, first assistant commissioner; **Marshall W. Amis**, general counsel; **Roy M. Little**, assistant commissioner for war emergency housing; **Herbert L. Wooten**, assistant commissioner for administration; **Lawrence N. Bloomberg**, chief economist.

A third HHFA subordinate agency, but one in a relatively safe position because its members have definite terms and because it always contains at least one member of the minority party, is the Home Loan Bank Board. Members are **William K. Divers** and **Kenneth G. Heisler**, whose terms expire in June '53, and **J. Alston Adams** (Republican member) whose term expires in June '54.

In the most precarious position of all housing officialdom is Rent Stabilizer **Tighe Woods**. Since Congress last year put rent control under the defense economic stabilizer, the life of the entire agency now depends on war and politics. Moreover, it seemed inconceivable that Woods, who now serves at the pleasure of the economic stabilizer, would survive a change of party.

In the Veterans Administration, all loan guaranty section personnel are blanketed under civil service, including chief **T. B. (Bert) King**. A topside VA shake-up could scramble things willy-nilly but an abrupt personnel change in anything so technical as guaranteed home loans promises so formidable a hassel as to discourage it.

On balance, 1953 will blow something between a tornado and a zephyr through the top brackets of federal construction bureaus, especially in housing, the building industry's most political segment. At the moment, some jobholders had a good case of jitters. As one said: "How can we tell what's going to happen? We've never had a change of government in the lifetime of this agency."



Black Star

FDR HOUSE, acreage at Hyde Park sold to subdivider

"Top Hill Cottage," the late President Roosevelt's self-designed nine-room field stone "dream house" retreat where he hoped to someday write his memoirs, was sold by son Elliott last month for \$150,000 to William H. Kay Jr., a construction equipment dealer of nearby Netherwood, N. Y. Kay also acquired 500 acres of Roosevelt family woodlands and an option to buy 250 more. The area, 5 mi. east of the Hyde Park national shrine, will be used for residential development.

PEOPLE: Pinza's chimes chant his theme song; McLaughlin new Princeton dean; Breuer to design \$75,000 class houses

At Stamford, Conn., **Ezio Pinza**, the opera-goers dream man, built himself a ten-room, \$60,000 dream house combining colonial and contemporary design. The door chimes peal the first six notes of "Some Enchanted Evening." The game room has a built-in electric train. On the acre of surrounding ground Pinza planned to bridge a brook and develop a picnic area. Local stonemasons promised to make him an honorary member, donate materials for an outdoor barbecue.



Halsman

Princeton's architectural school will have a new director next fall, **Robert W. McLaughlin**, 52, a member of the Class of '21. A pioneer in prefabricated housing, McLaughlin founded American Houses, Inc. in 1932, was board chairman until 1945. His firm, Holden, McLaughlin & Associates, served as its consulting architect.

Another McLaughlin achievement: establishment of a research laboratory in Bedford Village, N. Y. for the study of building techniques. McLaughlin has designed some 30,000 housing units (many of them for the low cost market but some for such clients as the DuPonts), holds more than 30 patents for building construction improvements. He succeeds Prof. **Sherley W. Morgan**, who is retiring after 32 years on the faculty, all but eight of them as director of Princeton's architectural school.

Named: Admiral **Edward L. Cochrane**, head of the Federal Maritime Board, as Dean of Massachusetts Institute of Technology's school of engineering; **Duncan Campbell**, former chief mediator for the Federal Works Agency, and **Laurence E. Seibel**, former Labor Department attorney, as members of the 12-man Construction Industry Stabilization Commission; **Gilmore Clarke** and **Michael Rapuano**, of New York City, as winners of the Architectural League of New York's gold medal in landscape architecture—for their contribution to housing site development; architects **Frank Lloyd Wright**, **Eric Kebbon**, **Eero Saarinen**, **Charles W. Walker** and **Robert Wheelwright** as associate members of the National Academy of Design; **Philip Will Jr.**, of the Chicago architectural firm of Perkins & Will, as president of the Midwest capital's AIA chapter; **Earl T. Heitschmidt**, Los Angeles architect, as president of the California State Board of Archi-

tectural Examiners; **George L. Googe**, of Atlanta, vice president of the AFL Printing Pressmen's Union, as assistant to the defense mobilization director; Seattle builder **Albert Balch** as recipient of the Seattle Chamber of Commerce's Paul Bunyan Award—for doing the most to "create a favorable impression of Seattle"; **Albert W. Butt Jr.** as president of the Architectural League of New York; **Dr. Maria Telkes**, M.I.T. metallurgical research associate and designer of a solar-heated house in Dover, Mass., as recipient of the Society of Women Engineers' first meritorious service award; **Arthur J. Benline**, Manhattan superintendent of the Department of Housing and Buildings and vice president of the Building Officials Conference of America, as technical director of the New York State Building Code Commission.

George Nakashima, onetime architect, now operator of a New Hope, Pa. furniture designing plant (H&H Mar. '52, p. 80), as

recipient of the AIA's 1952 craftsmanship medal.

Reversing the trend toward the smaller home, New York's Paragon Equities last month decided to subdivide a 360-acre parcel (including an 8-acre lake) in Connecticut's posh Fairfield Co. into 10- to 15-acre sites. Architect **Marcel Breuer** has been commissioned to have a model residence ready by summer. Price tags on the Paragon palaces will average \$75,000.

As the most urgent need dwindled, DPA belatedly edged closer toward creating a top-drawer construction co-ordinator. In a



MARTIN

job reshuffle, **John H. Martin**, 39, president of United Lumber Yards, Modesto, Calif., was named deputy DPA administrator in charge of construction and resources expansion. Said DPA: Martin will be the key policy man on all industrial construction.

Martin succeeded trouble shooter **James F. King**, who was named DPA representative to the International Materials Conference, the 30-nation board which theoretically divies up the free world's supply of key minerals. A good guess: King's appointment foreshadows developments (perhaps a change of U. S. policy) in the government's attitude toward copper ore imports.

Peter Knox Jr., president of the Thomson, Ga. prefab company bearing his name, will be the first housing man to join a Mutual Security Agency technical team. Knox and a group of fellow businessmen will visit Belgium this month to answer questions and offer advice on American production know-how.

A. Frederick Smith, 46, for the past six months executive director of the Defense Production Administration's advisory committee on defense areas, was boosted up a notch to committee chairman. A native of Sheridan, Ill., Smith has had 11 years of government service, a good part of the time as an HHFA economist. The committee's job: designating critical defense areas under Public Law 139. Smith succeeds Ivan D. Carson, who had been on loan from the HHFA plans and programs division.



Changing states and jobs, **Milton T. MacDonald**, president last year of the Mortgage Bankers Association, bought a con-

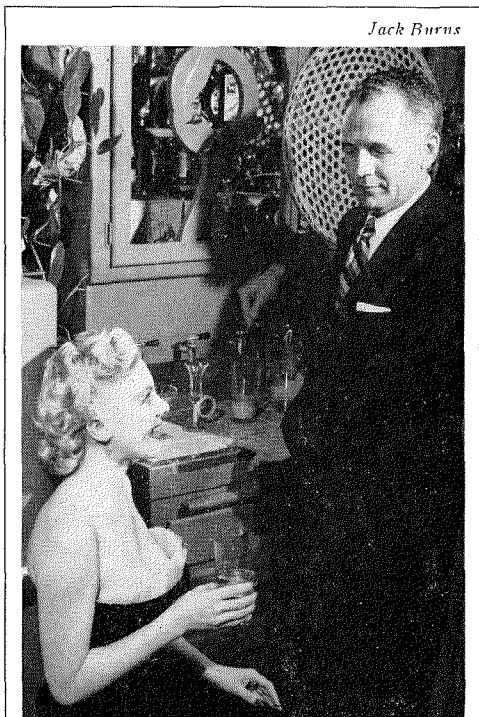

Jack Burns

OWN NIGHTCLUB cuts cost of entertaining for builder

Economy-minded Hal B. Hayes, Los Angeles builder (some 1,750 concrete houses for military installations last year), found his 1950 business entertaining cost \$70,000. So he shifted operations to his own nightclub. The result: a \$400-a-month Sunset Strip apartment with rugs running all the way up the walls, dance floor, waterfall, TV set encased in a tree trunk and a glass-enclosed garden in the ladies' powder room. Hayes (above with friend) also bought out a warehouse-full of liquor, now dispenses bourbon, scotch, champagne and beer from spigots.



win cheers with Flor-Ever[®]

vinyl plastic floor covering!

The customer who moves into your next house will tell friends what's good, and bad, in your houses. If you give her Flor-Ever she will say some wonderful things. She will throw away her scrub brush and tell everyone

FLOR-EVER CUTS CLEANING CARE

This vinyl plastic floor covering is non-porous. Dirt and dulling film can't soak or grip into it—and therefore is wiped clean faster and easier.

FLOR-EVER'S SHINE LASTS LONGER

Flor-Ever never needs waxing for protection, and because dulling film is wiped off so easily by occasional buffing or mopping, the plastic-bright glow lasts longer.

FLOR-EVER IS AMAZINGLY STAIN-RESISTANT

No grease or oil used in a kitchen will stain or harm Flor-Ever. This floor covering cannot be damaged by harsh soaps containing caustic lye or alkali, nor even by household chlorides or bleaches.

FLOR-EVER WILL WEAR LONGER

Flor-Ever, compounded of pure vinyl clear through to its Permo-Seal back, is guaranteed to outwear old-type composition floor coverings 150% as thick.

FLOR-EVER'S COLORS CAN'T RUB OFF

Flor-Ever's vinyl-bright colors are not on the surface. They go clear through the entire long-wearing material.

FLOR-EVER OFFERS MORE DESIGNING

*—made by the **TILE** and **YARD!***

Flor-Ever's 17 unique colors can be combined with versatility never before known, because all colors are available in:

Seven widths by the Yard—

Standard—6 foot (72")

For counter tops and special effects:

42"—36"—30"—24"

Borders—9" Feature Strips—1"

Two sizes by the Tile—

9" x 9" 6" x 6"

DELAWARE FLOOR PRODUCTS division of Congoleum-Nairn Inc. WILMINGTON, DEL.

Flor-Ever[®]
vinyl plastic
FLOOR COVERING

GLAZED BASEMENT WINDOW,

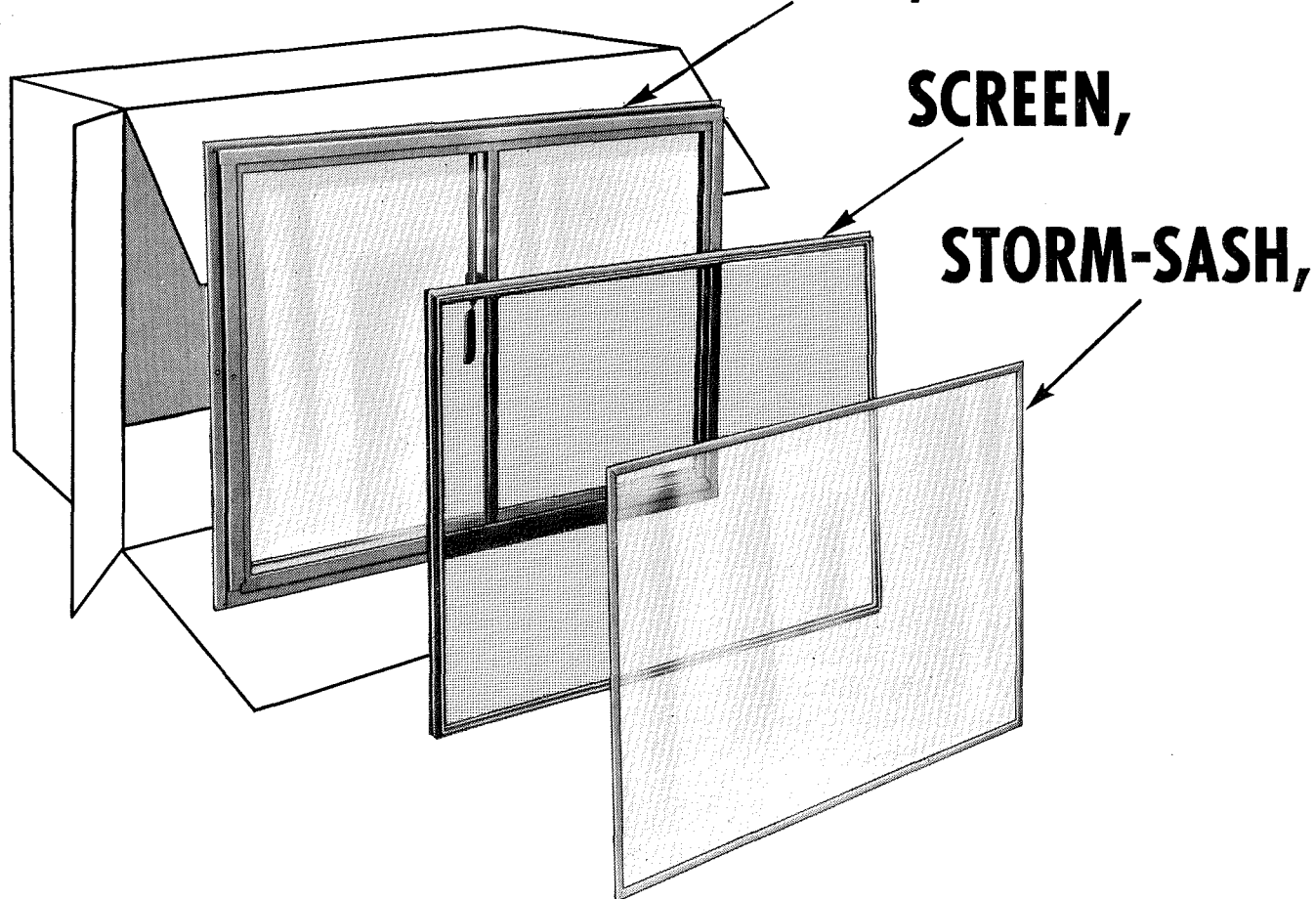

... all in one MONEY-SAVING package!

Fenestra* Packaged Basement Windows come already glazed and complete with Screens and Storm Sash—all packed in a protective easy-to-handle carton. Protected on the site . . . no loose parts to handle or lose.

All the modern Basement Window features are here. Strong steel construction. Vermin-proof, leak-proof, weathertight. Easy to operate . . . lever action, no hinges to get out of order. Opens in from top for protected ventilation. Locks tight. Vent easily removed—from inside only.

Fenestra Basement Windows are available three ways

1. **Package A**—as illustrated.
2. **Package B**—Glazed Basement Window, with screen only, in carton.

3. **Unglazed Basement Window**—screen and storm sash also available separately.

All are available in three popular, two-light sizes: 15" x 12", 15" x 16", 15" x 20".

Also check on Fenestra Utility Windows for garages, shops, dairy barns, building areaways, etc. Sizes: 2'9³/₈" wide by 3'6⁵/₈" high. Construction and quality features same as Fenestra Basement Windows. Package "A" has Glazed Utility Window with screen, plus Vent Side Guards. Package "B" has Glazed Utility Window with screen only. Also available: Unglazed Utility Window—screen and side guards available separately also.

For further information, call your Fenestra Representative. Or write Detroit Steel Products Company, Dept. MB-5, 2251 East Grand Boulevard, Detroit 11, Michigan. *®

Fenestra 3 IN 1 METAL BASEMENT WINDOW UNIT

Dear Subscriber:

There are now over 100,000 of you—and I wonder if you realize how fully **the future of the American house and home lies in your collective hands and depends on what you do about it?**

Among you are the architects who will design those homes—more house architects, we believe, than ever subscribed to any architectural magazine. Among you are the builders, developers, and realtors who will sponsor and erect those homes—more homes, we believe, than the readers of any other building magazine. Among you are the bankers and lenders who will finance those homes—far more bankers and lenders than have ever read any housing magazine. Among you, in perhaps unequalled numbers, are the makers and suppliers of building parts and materials—the men who more and more must provide the predimensioned and industrialized parts from which tomorrow's better house will be assembled.

Overnight you have made HOUSE & HOME the one big professional magazine of home design and home building. That is a sobering thought—but the real challenge to our editors comes not from your numbers but from this:

Now, for the first time, your interest in HOUSE & HOME makes possible one central exchange of ideas and understanding for all the leaders responsible for giving America better homes.

For us your common interest creates at least a fourfold opportunity and challenge:

1. To help broaden the field of architecture to cover that great majority of homes that have heretofore had no benefit of architectural service.
2. To help speed the acceptance of good new ideas, methods, and materials—and most particularly to close the gap between architect, builder, and lender which has so often made it hard to finance homes which incorporate new ideas
3. To help architects, builders, lenders, and suppliers watch together the exciting experiments in fresh design and better living that are being worked out in the laboratory of the custom-designed house—the proving ground in which the most successful features of today's houses were first tried out, the proving ground in which the design of tomorrow's house is now taking shape
4. To help speed the industrial revolution in housing—with all its promise for better living at lower cost—a revolution possible only by co-ordinating the architects' contribution of simplified modular design, the builders' contribution in assembly line construction, and the suppliers' contribution of standard parts presized to the new basic dimensions jointly urged by AIA and NAHB.

All that adds up to quite a challenge. I hope we can measure up to it.

Cordially—*P. I. Prentice*

P.S. *Would you like to help us meet this challenge? We are always looking for writers who combine a gift for vivid, concise, provocative writing with a rounded understanding of design and construction and a sincere interest in house and home economics and economics.*

marcel breuer
teacher and architect

do his simple lessons mean anything to the

Breuer House, New Canaan, Conn., 1951 (cover picture shows its living room)



building industry at large?

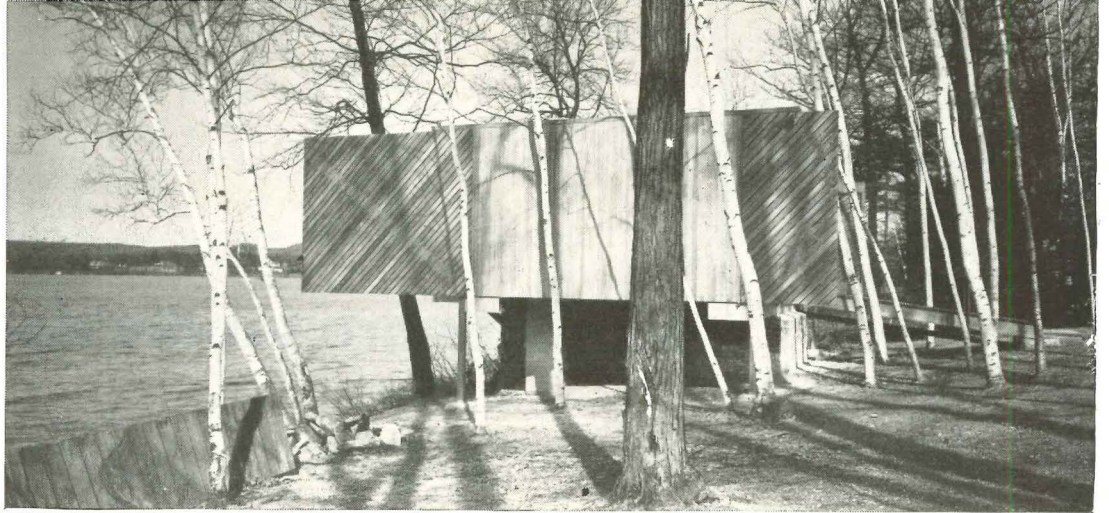

Caesar Cottage, Lakeville, Conn., 1952

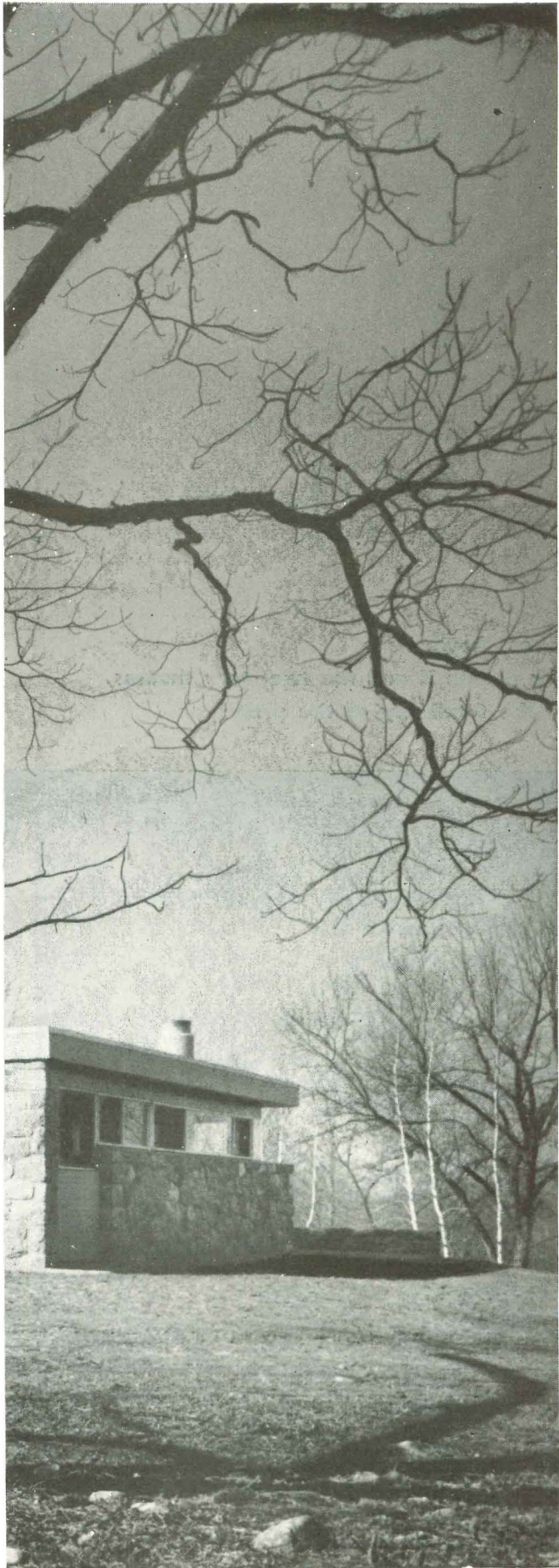

All photographs by Ben Schnall unless otherwise credited

Marcel Breuer is an architect's architect; but this story about Marcel Breuer is not just a story for architects—for Breuer's uncanny gift for making architecture *seem* simple could help anyone concerned with the planning of better houses to see his problems more clearly, and to seek their solutions more directly.

Breuer has ardent followers and severe critics. There are some who think that he oversimplifies architecture and follows too cut and dried a formula. However that may be, his systematic thinking has made him an outstanding teacher; and on the following pages will be found what he has to say about:

Connie Breuer



**plans, and where to put the children;
use of color, inside and out;
use of natural materials;
forms of stairs and fireplaces;
construction of windows and doors;
combination of openness with privacy;
and the place of buildings in nature.**

Breuer's appeal (as we have indicated) is based primarily on his gift for making architecture seem clear and solutions seem simple. His houses are made up of certain logically conceived, repeated and eminently copyable ingredients. These ingredients are made to jell by what Breuer likes to call "that 1% which is art and which tips the scale"—and a very important "1%" it is, as many bad copies of Breuer Houses demonstrate only too clearly.

Yet the ingredients are worth studying for their own sake; and the fact that they have caught on with a very large group of younger architects and designers means that even the most unsympathetic observer can no longer summarily dismiss them. On the next 12 pages examples from half a dozen recent Breuer houses show what these ingredients are. Closer study should clear up some puzzles and reveal the thinking that produced these forms.

marcel breuer
teacher and architect

his plans are subdivided according to use

The most important thing Breuer has to say about the plan of the house is that certain functions are so incompatible that they should be kept clearly separate. Specifically, he thinks it is important to keep the spaces for daytime living quite distinct from the space for sleeping, and he thinks it is most important to give the children an area of their own.

To divide daytime from nighttime living, Breuer's most common solution is to build the house as two clearly separated units and then connect them in an H-plan with the connecting link serving as a hallway. This plan has the added advantage of creating two little patios inside the H which can be developed to great advantage, especially on a small lot.

To separate the generations Breuer usually likes to locate his houses on a sloping site where he can provide a ground level indoor-outdoor playroom for the children underneath the daytime-nighttime living area used by the adults. Where this is not possible, he usually provides a play area for the children in the rear leg of the H, in such a way that they can be supervised from the kitchen window.

The two houses shown here are variations on the H and the two-story themes, demonstrate the flexibility of the prototypes.



In the Breuer House (1951) in New Canaan, Conn. (Ernest R. Rau, Gen. Contractor) the plan is in the shape of a U—with one leg containing the child's area, the other the parents' living, dining and bedroom, and the link containing service and utility rooms. The gap in the U is an entrance patio. Plan is thus divided into areas of noise and of quiet.

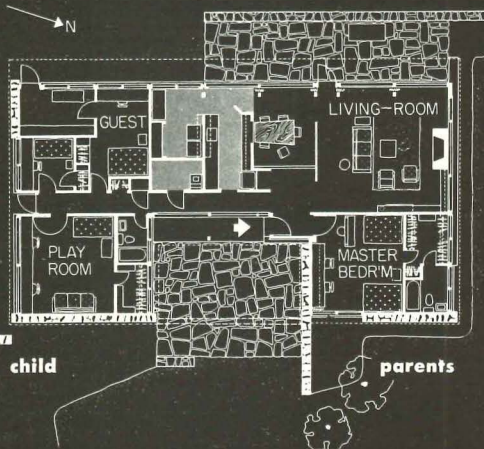

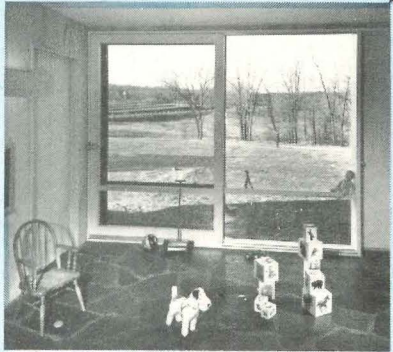
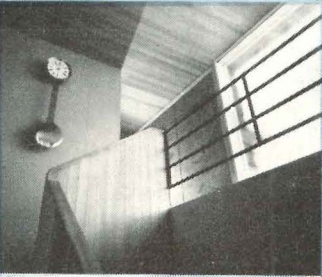

parents' floor

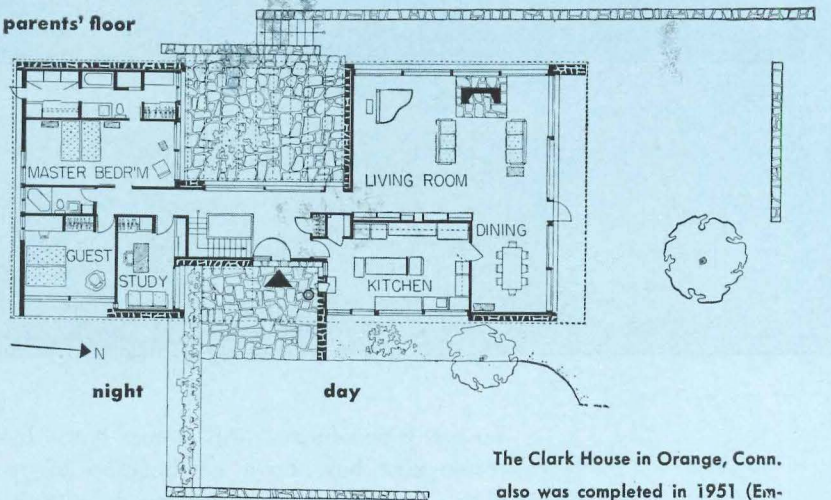

children's floor

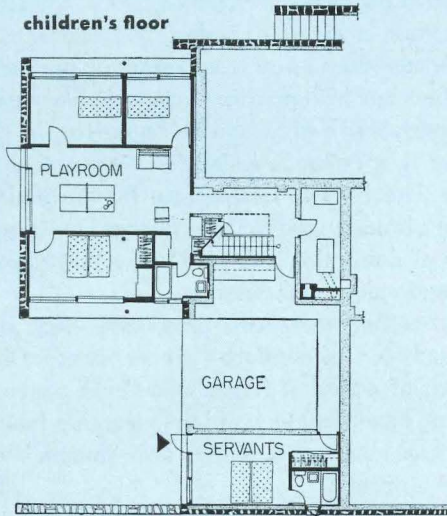

The Clark House in Orange, Conn. also was completed in 1951 (Emerson A. Daniels, Gen. Contractor). Its plan is a combination of the H and the two-story schemes. Upstairs, the H-plan divides the house into a daytime and a nighttime area for the parents; the downstairs portion (beneath the parents' bedrooms) is allotted to the children, with a separate apartment for their nurse.

Upstairs, the H produces two patios: one a formal entrance, the other a trellised porch. The slope of the land is such that the children have access to the outdoors at the lower level to the north, the parents can walk out of their bedroom and onto grade through the east patio, and the living room has direct access to the grounds at its south end.

Although this is a large and complex house, the logic and orderliness of its plan, together with the continuous roof fascia line, give the building unity and coherence.

The three pictures above illustrate the logic of the Clark House plan. From top to bottom, they show, first, a view of the parents' floor looking from the living room past the glazed entrance link toward the parents' bedrooms; second, the dramatic stairway leading from the entrance link down to the children's floor; and, third, the children's playroom with its sliding glass panels opening up toward the lawn. Some of the furnishings in the Clark House are antiques, were placed against plain interior surfaces with excellent discrimination.

marcel breuer
teacher and architect

his materials soften a stern geometry

Pack House, Scarsdale, N. Y., 1951 (Woodle Const. & Supply Co., Gen. Contractor)

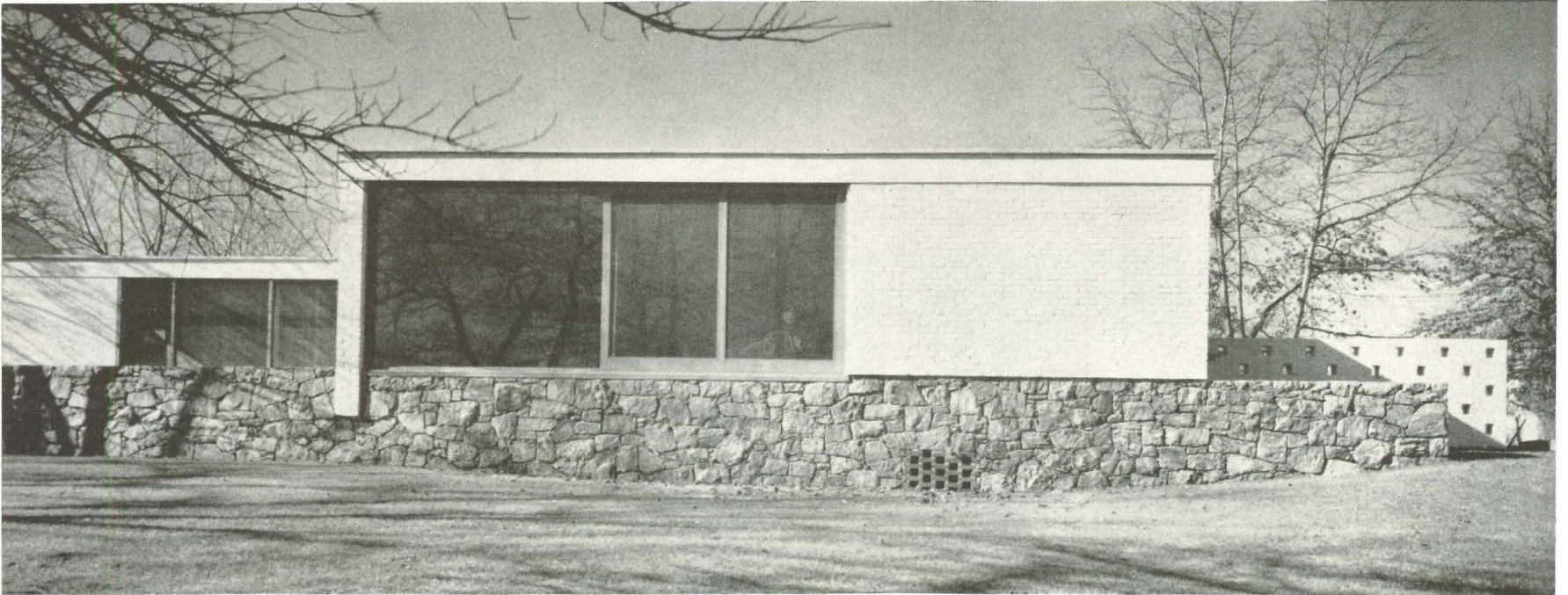
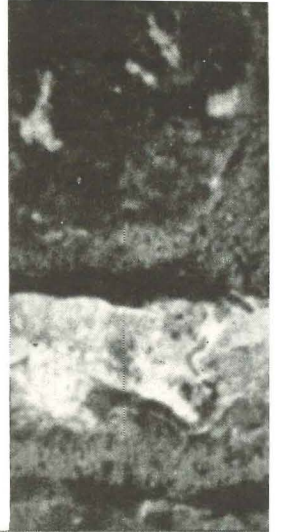

To many people a typical Breuer house looks like a rectangular box, or a combination of rectangular boxes. Breuer frankly subscribes to an esthetic based on the crisp geometry of machine forms: the rectangle is the module of his plans and of his facades.

But Breuer shies away from using the hard surfaces people associate with machine forms. He likes to use natural materials like wood and fieldstone for the warmth they lend to a house intended for comfortable living. Moreover, he likes to compensate for the plain (and sometimes brutal) simplicity of a large box form—and one way of doing this is to give his rectangular shapes texture and small-scale interest.

In reconciling these two tendencies—love of simplicity and love of comfort—Breuer manages both to steer clear of a kind of Hansel-and-Gretel romanticism on the one hand, and to avoid the gleaming laboratory look on the other. His houses are “human” without being “sentimental.”

Table on Breuer House terrace: bluestone top on concrete block base

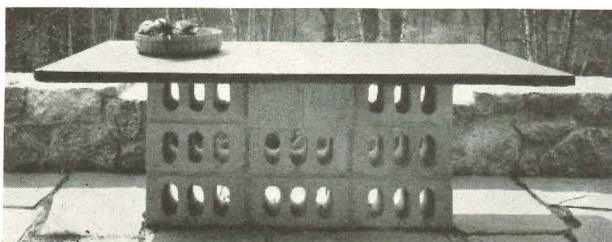



Caesar Cottage, Lakeville, Conn., 1952 (George J. Switzer, Gen. Contractor). The blinders on either side of the view-facade protect living area and balcony from neighboring cottages close by. These blinders are diagonal cypress siding bolted to cantilevered floor and roof girders, form a parallel, cantilevered truss 10' in height.

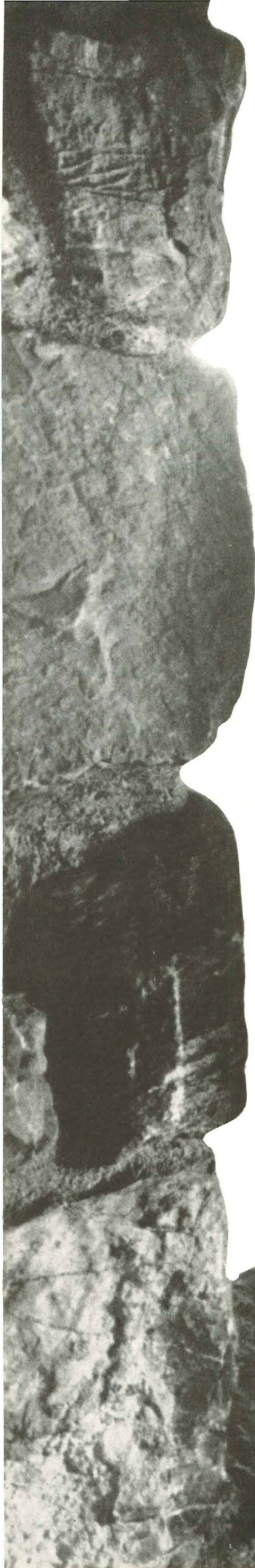

marcel breuer
teacher and architect

his color accents are bright

Breuer has five things to say about color:

1. Stick to the primary colors—red, blue and yellow—for they will contrast strongly with the warm and indefinite tones of natural wood and stone, and bring out the best in them;
2. get these colors to blend by introducing an occasional warm gray and by holding the red to a near-vermilion shade and the blue to an ultramarine mixed with white;
3. don't be afraid of using the resulting sky-blue on large interior surfaces: it will make a wall appear like a section of the sky, and a room more spacious;
4. don't use greens in the country: they will look dead by comparison with the lively hues of nature outside; and
5. don't be afraid of using several bright colors on your exteriors: they may help to turn an irregular window wall into a gay, abstract checkerboard—a small-scale element in agreeable contrast with large expanses of wood or stone.

However, when in doubt Breuer still prefers a pure white to almost anything else. He thinks that it gives a "plastic quality" to a wall that no other color can match.



Dining area in Breuer's own house is screened from entrance by sky-blue partition which gives illusion of spaciousness to a compact plan. The blue, together with the brilliant yellow wall in the rear and the soft gray sliding panels between kitchen and dining table, helps to bring out the warmth of the matchstick bamboo screen and the cypress ceiling. Dining table has splayed top of oiled teak. Paintings are by Josef Albers (rear) and Alexander Calder.

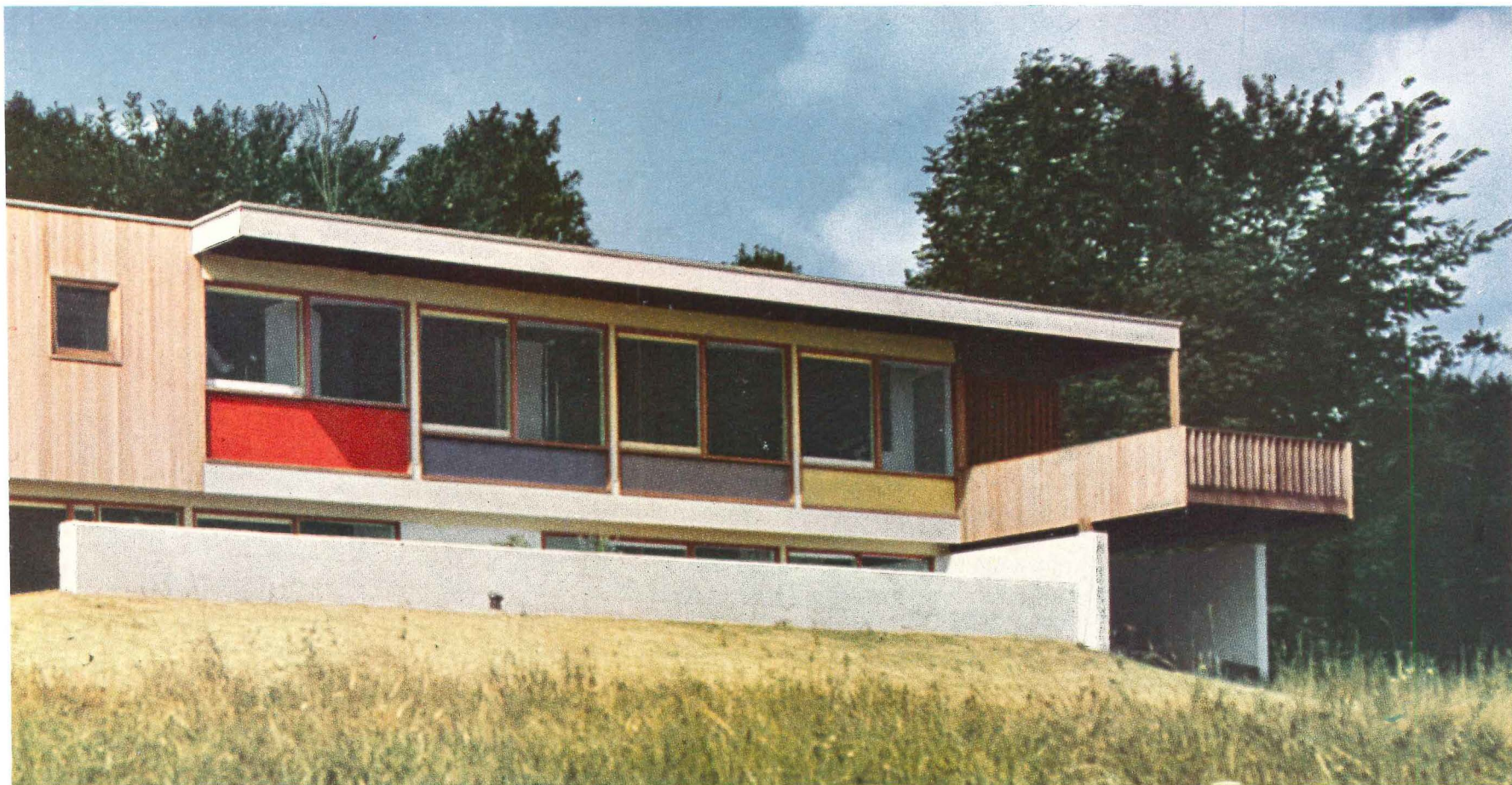

Stillman House in Litchfield, Conn. was built in '51 (George J. Switzer, Gen. Contractor), is very similar to Breuer's first New Canaan house. Long window-wall panels are treated as one-piece abstract composition, show Breuer's favorite colors. Small scale of this composition contrasts agreeably with large expanse of cypress siding at left. Colors are here in shade, thus appear darker than they are. Parents' rooms upstairs, children below. (Photo: Breuer)

marcel breuer
teacher and architect

his stairs and fireplaces are sculpture

Breuer compensates for the stark simplicity of his architectural forms by turning the "accessories" of the house (fireplaces, stairs, canopies) into decorative pieces of sculpture. The resulting contrast of large, plain, rectangular forms with smaller, complex elements gives many a Breuer facade its interest, many a Breuer room its focal point.

Breuer's suspended, cantilevered and gracefully articulated stairs are well known. Fastened to the plain sides of his buildings like giant praying mantises, these stairs serve as dramatic (and useful) outdoor sculpture; his fantastic entrance canopy in the Stillman House (*opposite*), rigged up like some nautical contraption, is another example of a useful building element turned into a sculptural accent to draw the visitor to the main entrance.

Indoors, Breuer uses fireplaces in much the same manner. Realizing that a living room needs a focal point, Breuer likes to make as much of a feature of the traditional fireplace (often free standing) as the Renaissance builders of piazzas used to make of the free standing campanile. Thus the sculptured fireplace becomes the center of attraction, the rallying point in an open space.



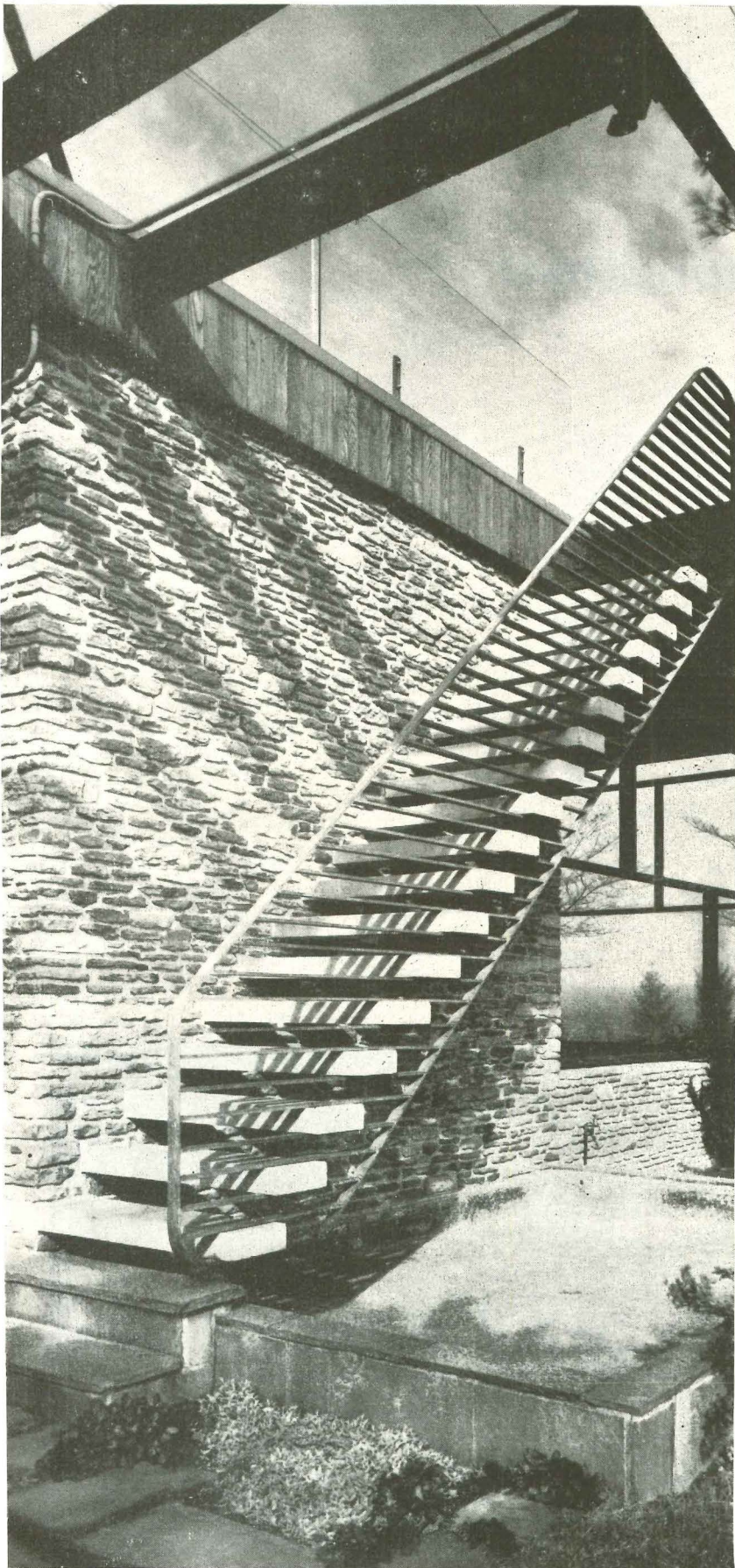

Exterior stair in Thompson House at Ligonier, Pa. (William Carstensen, Inc., Gen. Contractor). Partly cantilevered and partly hung from above, this stair is typical of much of Breuer's recent "useful sculpture." This house was completed in 1948. Right: the Museum of Modern Art's Exhibition House by Breuer (1949) had a similar stair leading from master bedroom balcony down to the garden terrace.

Opposite: fireplace in Caesar Cottage is made of bush-hammered concrete, with two asbestos flues mounted on top. The smaller of these serves heater in narrow stone base under living room floor. Chair is a Breuer design originally produced in England in the '30s, may soon be available in the U.S.

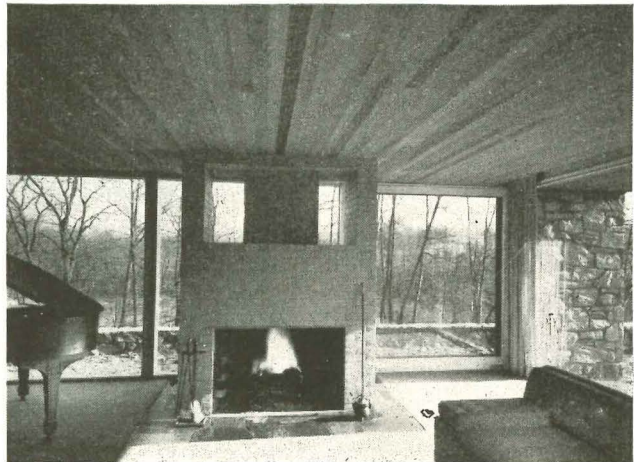

Fireplace in Clark House is freestanding, opened up to reveal flue

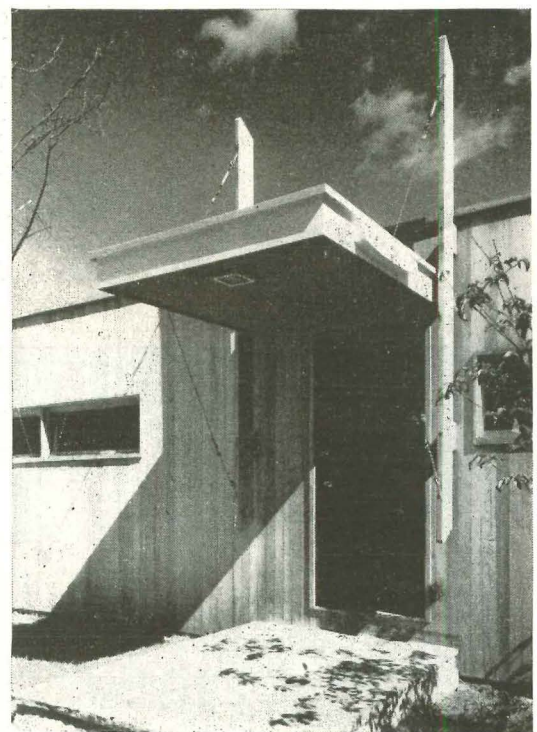

Entrance in Stillman House is rigged up like nautical contraption

Ezra Stoller

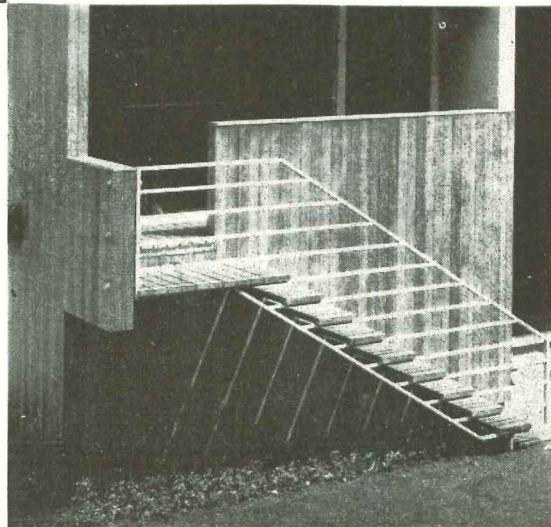

marcel breuer
teacher and architect

his detailing is consistent

Breuer's admirers never cease to praise his wood detailing—the way he puts together windows, doors, post and lintel joints, etc. While some critics have said that Breuer's neat and precise millwork depends too greatly on expert carpentry, nobody has denied the consistency and logic of his detailing, the slim elegance of his trim.

On this page is shown a typical example of a Breuer structure detailed all the way through with consistent sill, mullion, head and trim sections. The house is the small Caesar Cottage in Lakeville, Conn. It is not an inexpensive house, but with certain changes its details could be adapted to inexpensive construction. For example: like all recent Breuer houses, the Caesar Cottage uses sliding windows only—some of them wall sized, operating on standard hardware; others a mere 10 sq. ft. in area, *built entirely without frames!*

These latter windows are a Breuer innovation, consist of $\frac{1}{4}$ " thick, plate glass sheets sliding in a milled groove and operated by a wood pull along one vertical edge. Breuer has found the design to be weatherproof, tested it in his own Cape Cod Cottage four years ago.

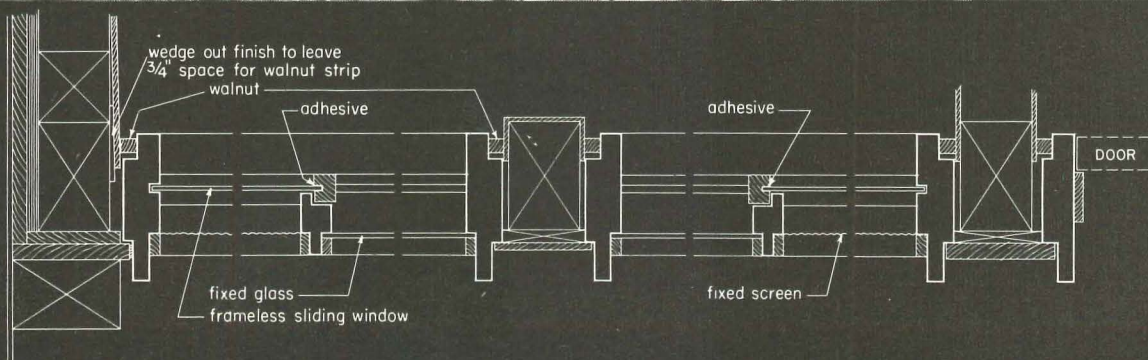
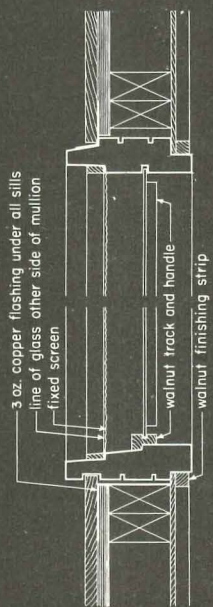
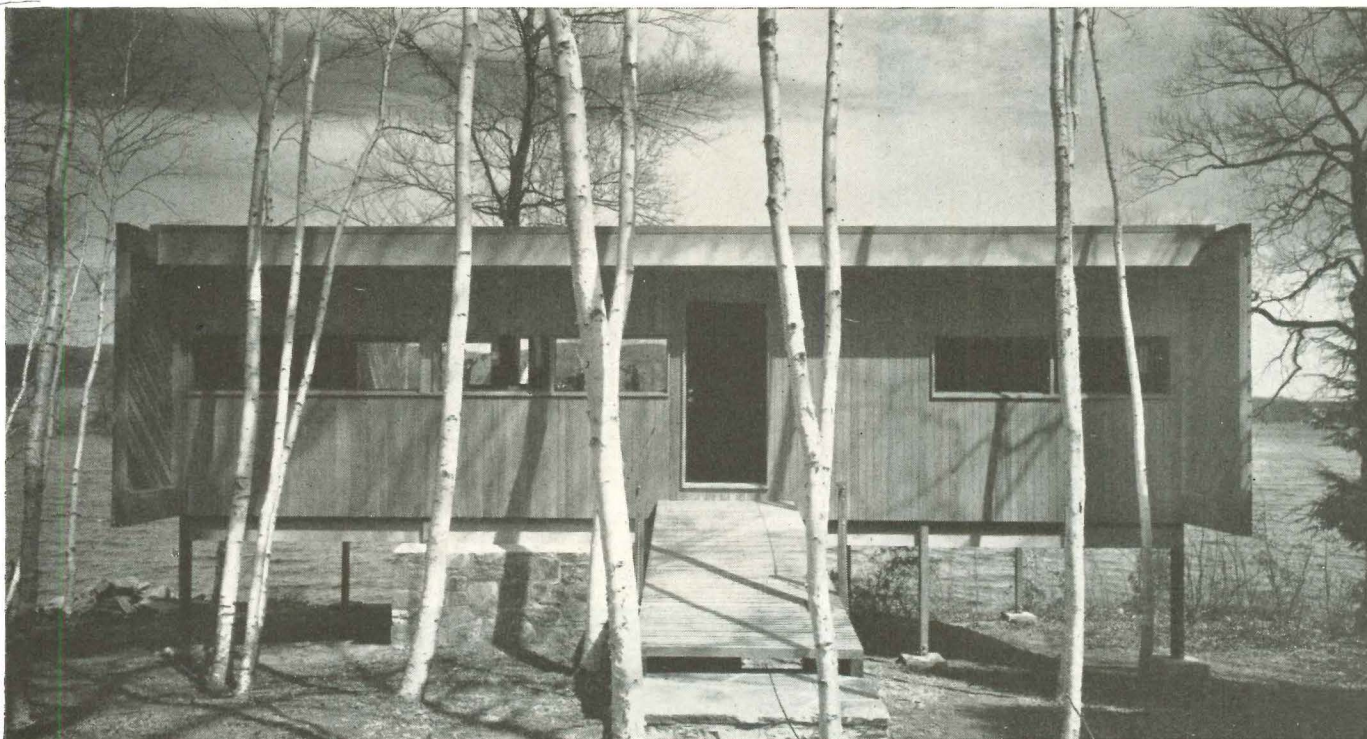

Details at left are plan sections of left half of Caesar Cottage facade, show frameless sliding window and repetition of walnut finish strips around sills, jambs and heads. Above: vertical section of frameless sliding window.

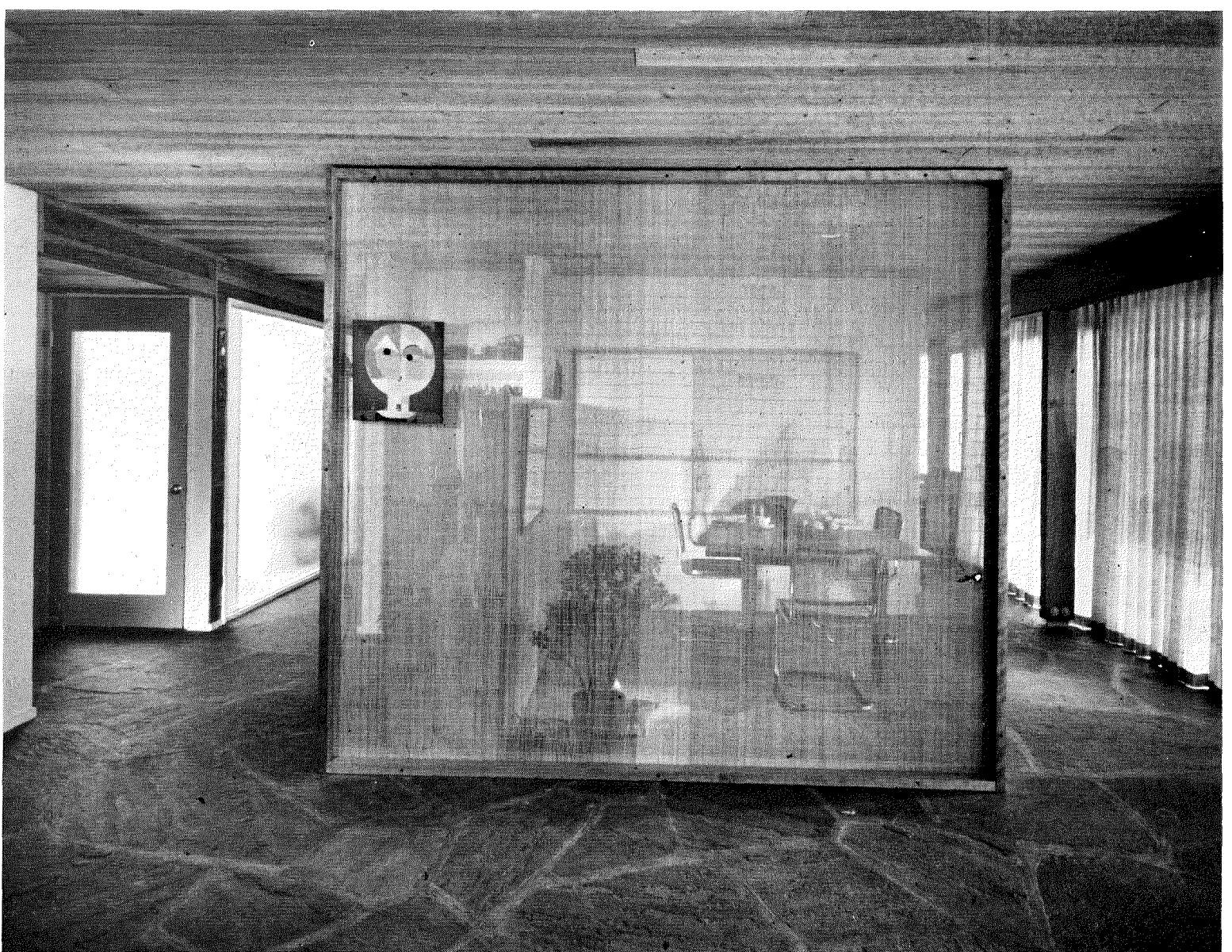

Bamboo screen shields dining area in Breuer House. Painting is by Paul Klee

his open spaces are intimate

By definition, the chief problem posed in the open plan is that of intimacy and relative privacy for some of the areas in it. Breuer uses various devices to keep his spaces open and flowing, and yet give some areas a sense of privacy.

In the living area of his own house, Breuer used a semi-transparent bamboo screen (*above*) to shield the dining space, to give it a sense of intimacy and to hide the clutter of tableware after meals. At the same time, the semitransparency of the screen suggests a continuous space extending beyond the actual confines of the living room; in fact, the haziness of this view beyond the screen makes the flowing space appear larger than it really is.

The dining area in the Stillman House (*right*) is also screened (but not cut off) from the living area. Here a combination of low partitions with the freestanding fireplace wall surrounds the dining area in such a way that it appears enclosed, especially when you sit down; yet the airiness of the composition keeps the total living space from being cut up into cubicles, retains the freedom of the open plan.

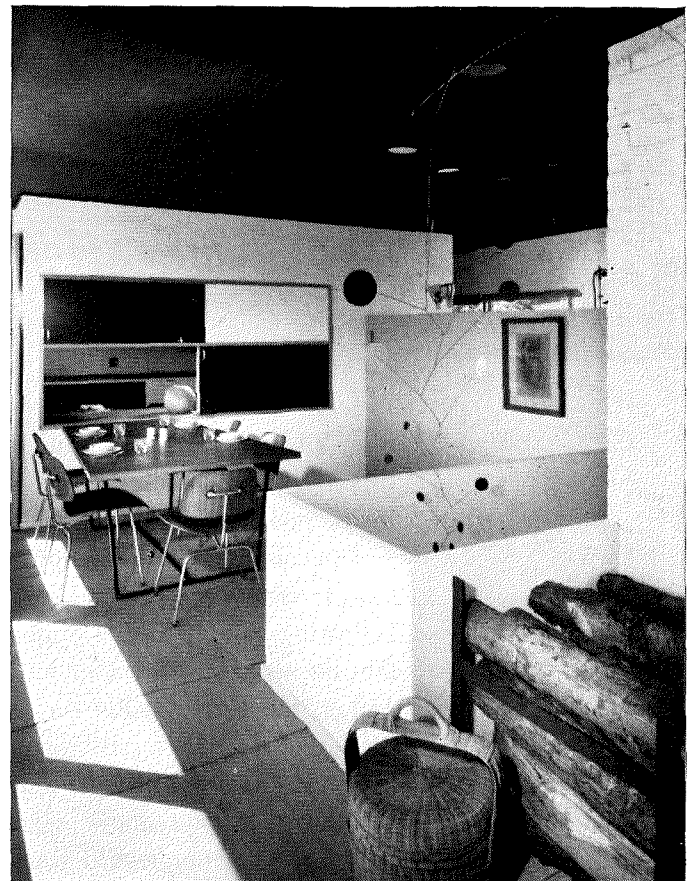

Dining area in Stillman House is surrounded by low partitions

marcel breuer
teacher and architect

his houses reach for a view of nature

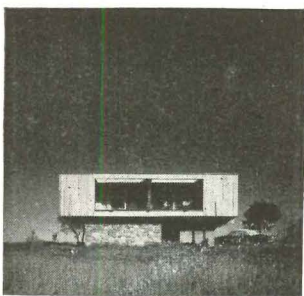

A lot of Breuer houses look like cameras: rectangular boxes perched on a small stone base as if on a tripod, one large glass wall focused straight at the view. This disarmingly simple idea seldom fails; for the view changes as the weather and the seasons change, and as the earth turns in the sun.

Breuer's attitude toward nature is that of an observer, of the man behind the camera: he likes to look at it. And if he has trouble getting a good look, he will reach for a better view. His houses are observation posts from which to admire what no man can imitate.

For Breuer will never try to imitate nature. He doesn't mix into her affairs, and he doesn't permit her to mix into his. Architecture, to him, is one thing—nature another. His houses never merge with their natural settings: they are always crisp, clean cut, man made. Sometimes they are raised on stilts so as to leave the slope of a hill undisturbed; sometimes they are used to frame a tree in the simple geometry of their structure.

To Breuer, this aloofness is a very real way of paying your respects to the trees, the hills, the water and the changing skies. His houses are modern, civilized homes for modern, civilized men—not burrows in which commuters can pretend to be like Tarzan.

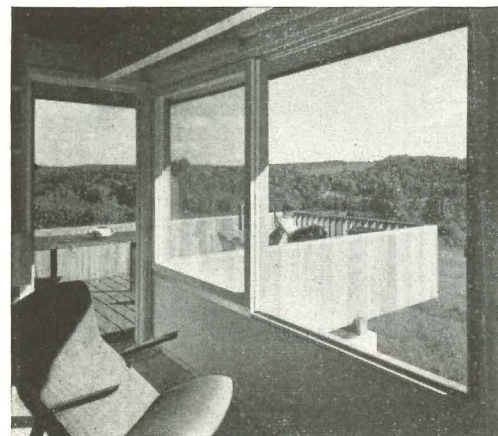

Stillman House has parents' quarters upstairs, children's below. View from upstairs living room is across valley to distant hills. Low walls in front outline children's play area.

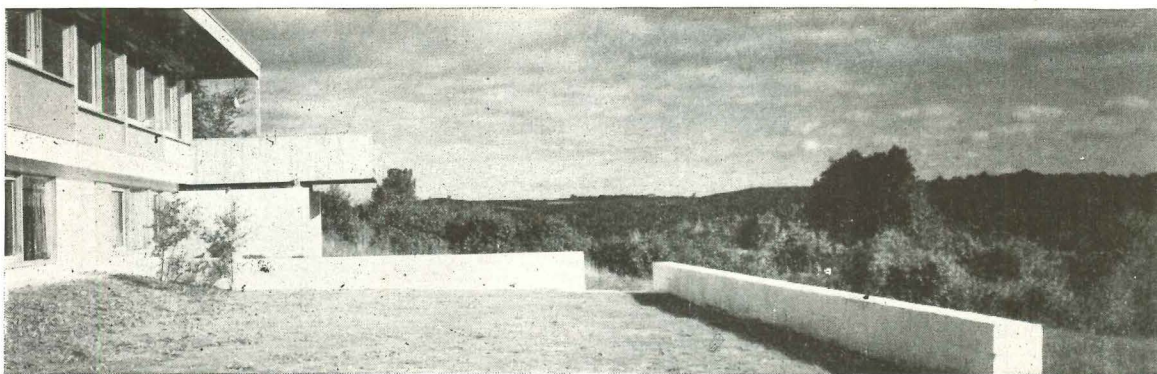

Breuer's houses, then, are many things—articulated plan and structure, colorful painting, playful sculpture, simple combinations of seemingly simple ideas, good examples of a logical mind at work.

They have influenced enough of the younger architects to create a large and easily recognizable Breuer following (and a Breuer opposition); they are important by now for a broader building audience.

Yet, the final verdict on these houses can not be rendered merely by adding up the bright ideas, the neat solutions. With all their precise logic, these houses are meant above all to be places for good living and Breuer would want them to be judged in just those terms.





Perched on top of a narrow stone base, the Caesar Cottage is focused at a magnificent view. It is located on a very narrow lot, among a cluster of young birch trees, and between rows of summer cottages. The diagonally sheathed blinders on either side of the house shield it from its neighbors. Cantilevered structure frames a small oak tree.

Caesar Cottage (opposite) overlooks lake and distant hills

Prospects for mortgage money by Dr. Marcus Nadler

Professor of Banking and Finance, New York University

Will mortgage money be easier to get this fall? Will interest rates be lower or higher?

Don't look for your answer in a crystal ball. Look in the money market, which is something quite different from the mortgage market and responds much faster to changes in business and changes in Federal Reserve monetary policy. And if you can, look *beyond* the money market to the forces which create those changes in business and in monetary policy.

If builders and lenders had been watching the money market early last year they would not have been caught napping when the Federal Reserve changed its open market policy and stopped buying government bonds at a pegged price, and they would not have been surprised by the tremendous change the new monetary policy caused in the mortgage market, for both changes were almost inevitable.

Another change in Federal Reserve policy is now in the making, a change which is almost equally inevitable, a change which will have a major effect first on the money market and then on the mortgage market.

Already the picture is so clear that there is only one important uncertainty: Will Congress cut the budget enough to avoid a cash deficit of more than \$5 billion? If the deficit is much bigger than that, mortgage money may continue scarce and interest rates firm. If the cash deficit is held to \$5 billion, mortgage money will be much easier.

The Federal Reserve policies which so largely influence the money market are not formulated in a vacuum. They are guided by (1) the state of business, and (2) the needs of the U. S. Treasury, and the present prospects of both must be analyzed before we can prognosticate what the money market will do.

The outlook for business

The sellers' market is coming to an end. The pent-up demand for many commodities has been largely met, and people today are more interested in saving than in spending. The productive capacity of the country has increased materially, while the living standard of many people, particularly those with fixed incomes, has decreased. Therefore, unless unforeseen events occur or defense expenditures are speeded up beyond what is now envisaged, or unless government stockpiling is resumed on a large scale, the transition from the sellers' to a buyers' market from now on will be rapid. By the end of this year or early next year practically all industries will be in a buyers' market and encountering keener competition than has existed at any time in the last ten years. This is bound to influence the policies of the Federal Reserve authorities.

Economic conditions now are very different from early 1951

Then there was a mad rush to buy. Everyone from the smallest merchant to the largest manufacturer was trying to accumulate inventories, partly for fear of sharply rising prices, partly for fear of scarcities. The volume of bank loans was increasing rapidly and commodity prices were rising steadily. The popular psychology was dominated by fear of inflation. Under those circumstances the Federal Reserve governors were bound to take some such action as they did take to prevent inflation.

Today, on the contrary, merchants and manufacturers are trying to liquidate inventories, and many wish they had never heard the word. In many industries, particularly soft goods and most particularly textiles, certain types of merchandise are selling below their cost of production. The volume of bank loans, despite the very substantial increase in taxes and the acceleration of tax payments, has not increased. Commodity prices have leveled off, and many commodities are selling somewhat lower than before the Korean war began. Instead of inflation, businessmen in many industries now fear a serious recession accompanied by large-scale unemployment.*

In this changing climate of business sentiment a corresponding change in the policies of the Federal Reserve authorities is almost as inevitable as was the change in March 1951.

**This should not be interpreted as meaning the country is headed for a serious decline in general business activity. Military expenditures are increasing; capital expenditures during 1952 are likely to be higher than in 1951, and these two factors combined give assurance that business activity will be maintained at a high level for the remainder of 1952.*

In fact, experience has shown that Federal Reserve policies are more sensitive to a decline in business activity and to a decrease in commodity prices than they are to inflationary developments.

Under these circumstances it would not be surprising if Regulation X were modified or actually repealed before the end of the year, nor would it be surprising to find a change in the attitude of FHA or VA to permit much smaller down payments and, in the case of VA, no down payments at all.

In my opinion the volume of homebuilding this year will depend not so much on the availability of building materials (the supply of which I believe will prove ample) as on the prospective changes in the policies of FHA, VA and the Federal Reserve.

How much new money will the U. S. Treasury have to borrow in the next fiscal year to finance the federal deficit? These borrowings will have an important *direct* bearing on the mortgage market. They will also influence the policy of the Federal Reserve authorities, for the record of the past nine months shows clearly that the Reserve authorities are still bound to assist the Treasury in its refunding operations and its raising of new funds.

According to the President's budget estimate submitted early in January, the fiscal year 1952-53 will end with a cash deficit of about \$10 billion. If the Treasury should have to raise this \$10 billion in the open market it will be forced:

1. To modify its terms of the E bonds in order to induce more people to buy and hold them. (In recent months the redemption of E bonds has actually exceeded their sale.) If now, for example, the Treasury should increase the interest on E bonds to make them yield 3% to maturity and offer a return of 2% to 2½% from the first year, this might have an important bearing on the movement of savings deposits and thus on the amount of money that savings banks and savings and loan associations would have available to invest in mortgages.

2. In order to sell new long term bonds to investors, it also follows that it must offer a higher rate of interest on these long term obligations. A long term Treasury offering at 2¾% or 3% might be quite attractive to institutional investors, who would know that in the not distant future these bonds would sell at a premium. And to the extent that institutional investors bought these bonds, they would have less money available to buy mortgages.

An entirely different situation would prevail if Congress cut government expenditures enough to reduce the cash deficit to about \$5 billion. In that case the Treasury's deficit financing problem would not be pronounced. It has already raised \$800 million through the sale of Treasury bills and in all probability these sales will continue. The modification of E bonds (which was actually started on April 29) will undoubtedly increase their sale, and the rest of the deficit could be met through the sale of medium or long term government obligations without any pronounced effect on the money and capital markets.

At present the policy of the Federal Reserve authorities is a neutral one,** aimed neither at inflation nor deflation and, in all probability, this neutral policy will continue for a time. However, as soon as the sellers' market has given way to a buyers' market, as soon as unemployment begins to develop, and particularly as soon as it becomes evident that the forces of inflation are giving way to the forces of deflation, this neutral policy of the Reserve authorities is bound to undergo a change.

There are still important inflationary forces at work in the economy. The action of the Wage Stabilization Board on the demands of the steel workers' union (which will undoubtedly be followed by similar action by other unions) gives rise to fear that the spiral between wages and prices will be renewed. Moreover, there is still no concrete evidence that Congress will materially reduce federal expenditures and thus make it unnecessary for the commercial banks to absorb substantial additional amounts of government obligations.

Assuming no unforeseen events, however, it is reasonable to believe that the increased productive capacity of the country, the heavy burden of taxation, the increase in savings and the resistance of buyers will prove themselves more potent forces than the inflationary dangers emanating from the actions of Congress and the Administration.

If such should prove to be the case, we may expect towards the end of this year or early next year a modification of both the qualitative and quantitative controls of the Federal Reserve authorities.

This will undoubtedly be reflected in the mortgage market.

The needs of the Treasury

Inflation or deflation

***Too few mortgage lenders and too few mortgage borrowers understand the basic aim of the changed Federal Reserve open market policy which touched off the present mortgage crisis in March 1951. The new policy was not adopted in order to increase interest rates. This was only incidental. The prime purpose was to make it harder and more risky to borrow from the Federal Reserve and to prevent the further monetization of the public debt. Its purpose, in other words, was to return the initiative in the creation of reserve balances to the Federal Reserve banks, an initiative which lay with the holders of government securities as long as the banks were obliged to buy those government securities at a fixed price.*



SMALL BUILDERS CREATE SMALL NEIGHBORHOODS

but give their houses an individuality that few big builders can equal

To the buying public, the trouble with many builders' houses is that they look like builders' houses. A visitor knows immediately that an entire block, or even a whole community, was built by one firm. In Knoxville, builders Stuart Fonde and Martin Bartling have skillfully overcome this criticism. They have built a score or more of pleasant neighborhoods—small groups of houses so attractive that people are enthusiastic about living there. The good will they get from their bargain-packed houses and their good neighborhoods helps them to sell their houses quickly.

Fonde & Bartling's trade secrets are these:

1. They design neighborhoods for the buyers

Like other small builders who haven't enough capital to buy 100 acres or more and put in streets and utilities, they buy land in a given area for 6, 12 or 20 houses. They never use a grid pattern but take advantage of terrain with curving streets. As plot plans

opposite show, they like short streets ending in turn-arounds.

At Blackberry Circle, for example (*bottom drawing*), they had a 1,000' x 300' strip where they might have put ten houses on long, narrow lots facing a highway. Instead, they built two groups of four houses. They sell three-bedroom houses on $\frac{3}{4}$ -acre lots for \$12,325—which any visiting builder is quick to admit is a real bargain. For this price, buyers get a big lot, privacy and play space for their children which in most cities cost twice as much.

Much of the charm of their neighborhoods is that they always fit the houses to the contours, never ruthlessly bulldozing their land. They always locate houses on the lot to save trees. In their informal arrangements, they can twist a house for best orientation.

In fairness to other Knoxville builders it must be added that county zoning (outside the city) requires that lots be a minimum of 15,000 sq. ft., usually 100' x 150', but Fonde & Bartling often go beyond this on the principle they give a better value. In some of their projects there are no sewers, and septic tanks are installed.

2. They use many different house designs

Over the years their designs and good neighborhoods have so favorably impressed Knoxville banker John W. Conner that he



Paul T. Fogarty, Jr.

LOCATION: Knoxville, Tenn.
 FONDE & BARTLING, Builders
 WM. A. SLOAN JR., Architect

says, "They have consistently improved floor layout designs. These and other features have developed an increased buying appeal. Consequently such houses definitely have a greater resale value and are worth more money."

On their staff they have a full-time, registered architect, William A. Sloan Jr. For a firm building around 50 houses a year it is unprecedented to have an architect, but Sloan also is the purchasing agent and a construction superintendent. He graduated from college a few years ago and is an example of one way a builder can use a young architect. Along with the partners, he contributes design ideas, draws plans and is a real asset to the business.

The firm never builds the same house more than a few times and there are never exact duplicates in the same project. While they may repeat a basic floor plan, each house seems to be different because of garage or carport location, window arrangements, etc.

Using many different plans is not as extravagant as might appear. Sloan has a set of standard details which he uses over and over. He can whip up a new plan with little trouble. House sizes, room sizes, windows, storage walls, kitchen and bath details are designed around standard units. A simple rectangular floor plan

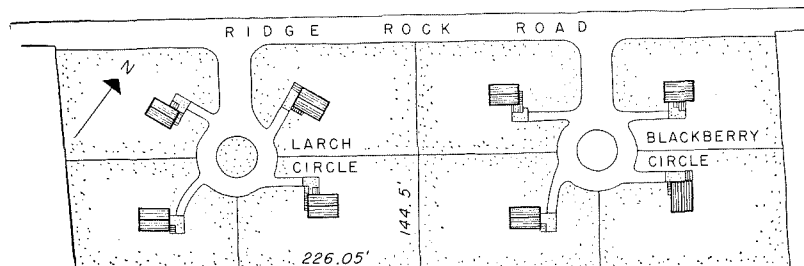
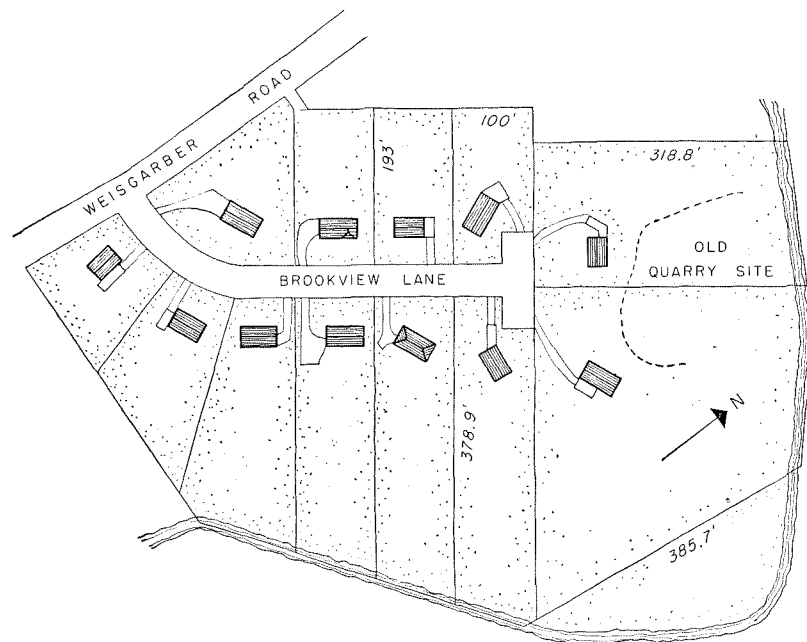
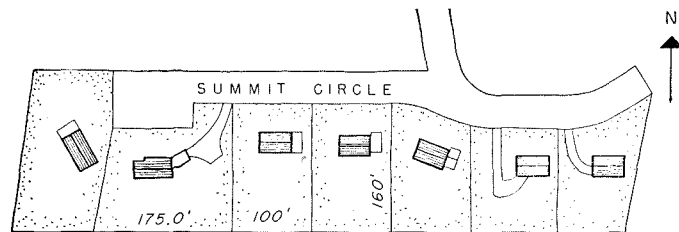

Plot plans show three ways houses are arranged to give individuality and to orient each house for sun, wind and view. Bottom plan is latest and is far better than long thin lots facing thoroughfare. Photo shows large lots, many trees.

is almost always used which takes standard framing and trusses.

The rooms are arranged to permit easy traffic patterns, good relationship between garage, kitchen and front door. Bedrooms are located to catch summer breezes and living rooms are usually put on the south side to let in winter sunshine. The builders never block out the southern sun by a garage or carport, as is frequently done. They also plan for outdoor summer living by providing porches and terraces. The trees they save give summer shade.

Because they use electric radiant heat in the ceiling (which a subsidiary of the firm makes and which will be discussed further next month), they design tight, well insulated houses. In addition to their storage cabinets, described below, they usually include a disappearing stairway to the attic for storage purposes and additional storage space in garage or carport cabinets.

Many Fonde & Bartling houses are sold by word of mouth by owners satisfied with well thought out designs of earlier houses.

3. They keep construction simple

While most builders of 25 to 50 houses a year believe that simplified construction is only for the big firms, Fonde and Bartling

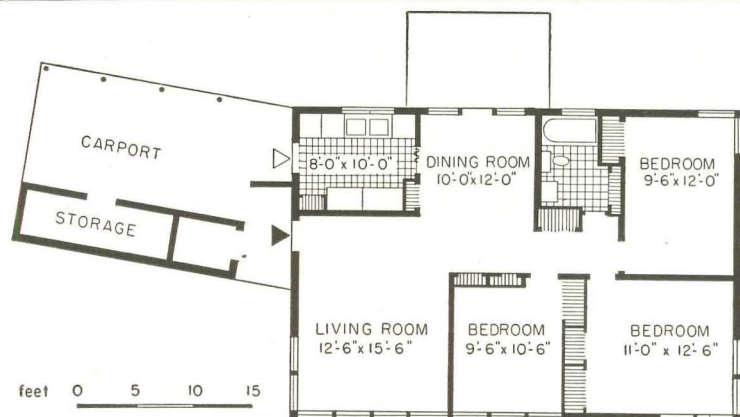

Good lines of this house, wide overhangs, large windows and its pleasant site make it stand out among merchant builders' houses. Floor plan shows the firm's trademark which is large storage areas, including two in carport. In addition, entire attic is accessible by folding stairway.

know better. They try to keep their carpentry work so simple that they can use unskilled labor for most of it. Their rectangular designs with no offsets (except garages or carports) permit a truss roof and eliminate load-bearing partitions. They can buy trusses from a subcontractor cheaper than they can make them. When the house is roofed the interior is one big room, and plasterboard goes rapidly on walls and ceiling. Several inside walls are made up of storage cabinets, built in their own shop and quickly moved into place. In two days, two carpenters set all the cabinets and trim the house. Trim is the same size for all purposes and is designed so that a corner block eliminates mitering. Doors are assembled and hung in the shop, with 2 x 3's forming the frame, jamb and header. Windows that open have aluminum awning sash. Large window walls are bought from a northern manufacturer.

Most houses are built on a slab. Fonde & Bartling use a wide variety of exterior materials including cement block with a slightly beveled side so that each block projects over the one below it to give a horizontal shadow line. They fill hollow block with insulation which is so effective in the Tennessee climate that some of their houses are not furred or otherwise finished on the inside. Most interiors are 80% paneled or papered so there is not much painting. In the future they will spray paint (which they can do because they are open shop). Low voltage wiring saves 3 lbs. of

copper per house but costs \$20 more than when they used ordinary wire because now they put in a lot more switches. They try to locate switches on their storage wall because they can easily run the lightweight wire through the cabinets.

4. They install storage walls—a big sales feature

Every house that Fonde & Bartling build has a generous amount of storage space, as the two floor plans here show. Cabinets are prefabricated in their own shop, a few being sold to other builders. They are \$6 to \$10 cheaper per cabinet than an ordinary closet, or \$12 to \$20 cheaper for a complete wall. Plasterboard is used for sides, back and top, mounted on a 2 x 4 frame which is exposed on the inside. Bottom is plywood. Sliding doors are of hardwood, plywood or other sheet materials. These cabinets are one of the firm's best sales features. (For drawings, see Dec. issue '51.)

If the mark of a successful builder is to have two Cadillacs in his garage, then Fonde & Bartling are not yet among the elite. But they turn out a house from which many a two-Cadillac builder could learn a lesson. There are few builders in the country who give their buyers as much livability, individuality and so many of the qualities that create a good neighborhood.

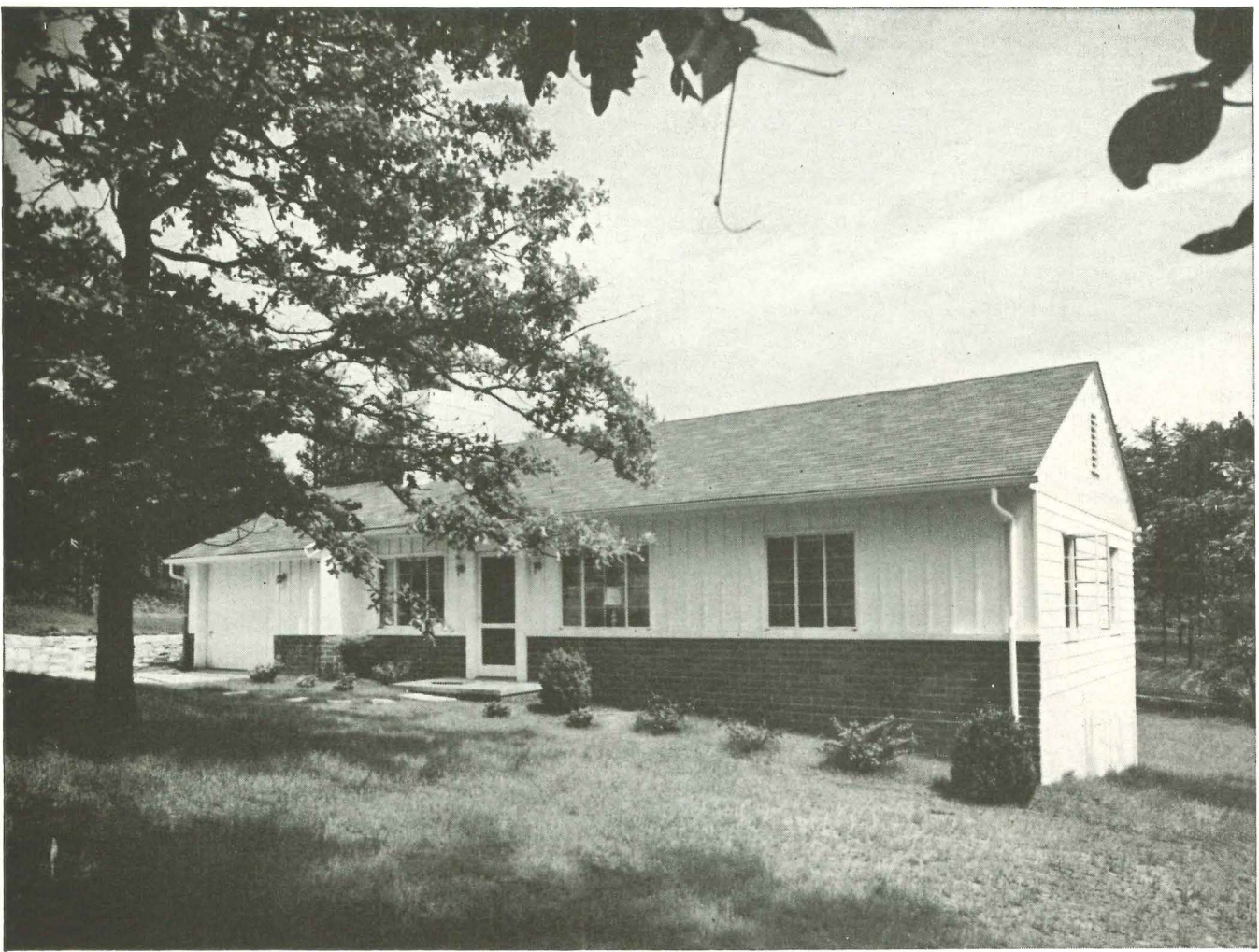

Fonde & Bartling usually build rectangular houses with no offsets except garage or carport, which permit use of truss roofs and nonload-bearing storage walls. A house like this sells for around \$12,325 on a three-quarter-acre lot.

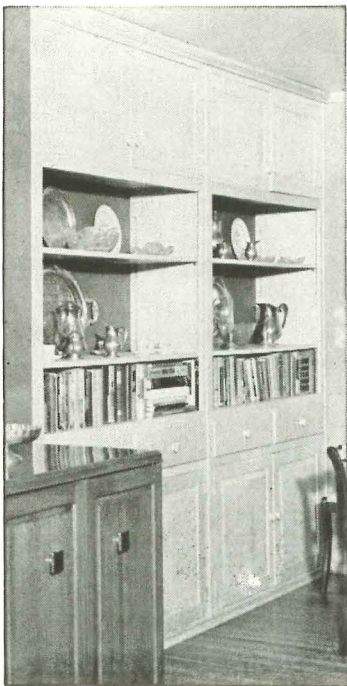
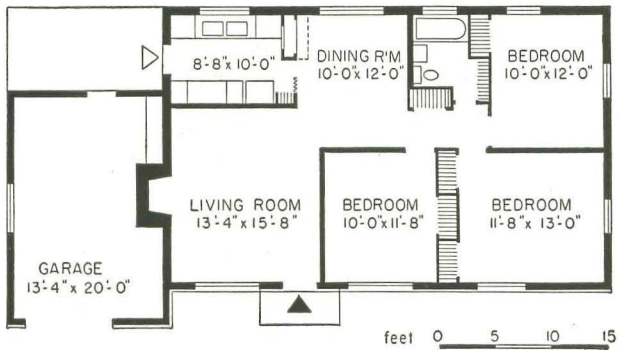

Storage wall at left is one of many styles the firm builds in its own shop. Because the sides and back are plasterboard, prices are from \$10 to \$15 a running foot.

Three houses at right show features a project has in common but reveal why each buyer feels he gets individuality. Large fixed window in house at bottom has ventilating lowers beneath it. Corner windows (top photograph) are popular with buyers.

Photos: Skeet Tallent Studio; Thompson's



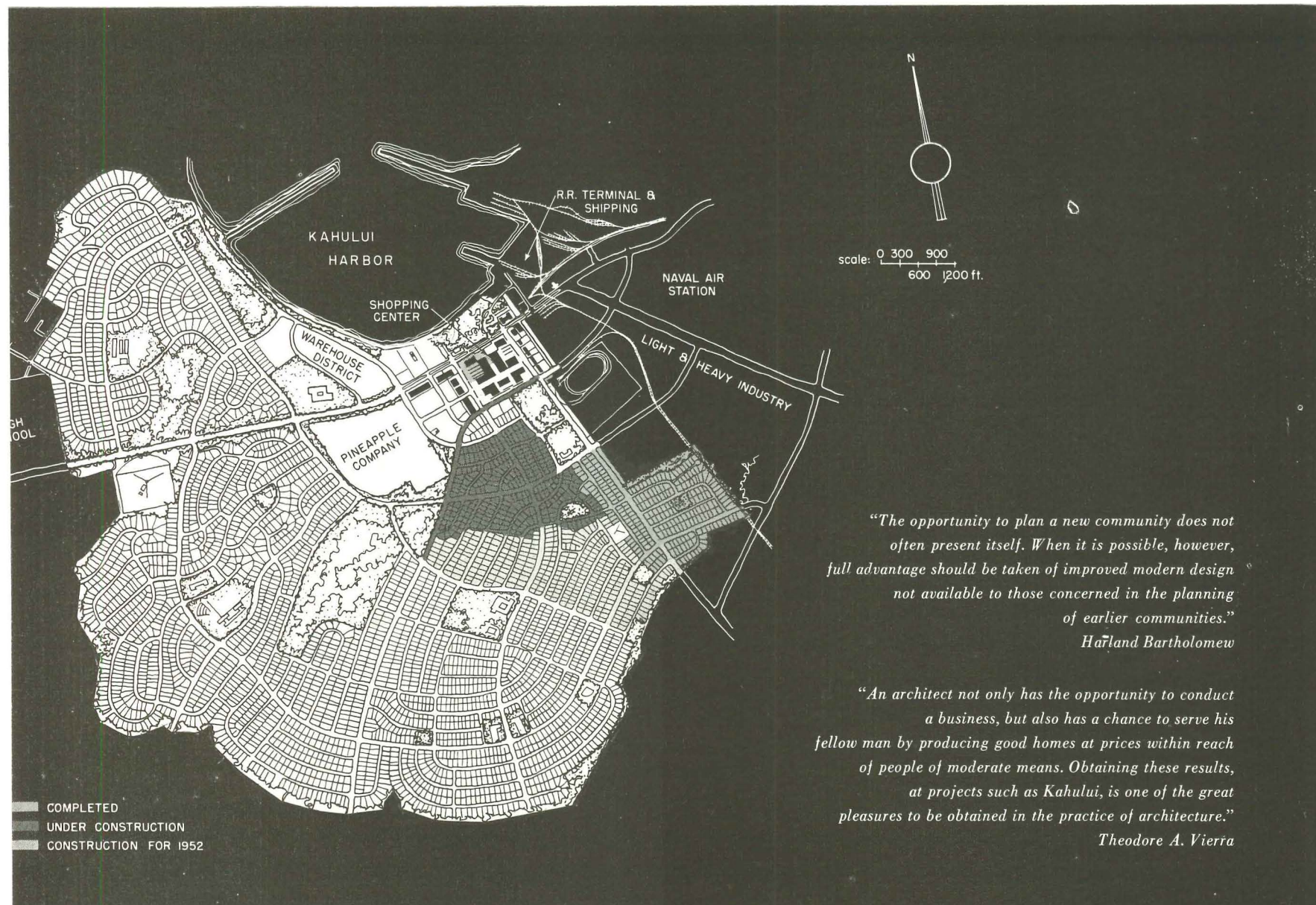

"The opportunity to plan a new community does not often present itself. When it is possible, however, full advantage should be taken of improved modern design not available to those concerned in the planning of earlier communities."

Harland Bartholomew

"An architect not only has the opportunity to conduct a business, but also has a chance to serve his fellow man by producing good homes at prices within reach of people of moderate means. Obtaining these results, at projects such as Kahului, is one of the great pleasures to be obtained in the practice of architecture."

Theodore A. Vierra



Instead of a company town...

LOCATION: Kahului, Maui, T.H.
THEODORE A. VIERRA, Architect
HARLAND BARTHOLOMEW & ASSOCIATES, Land Planners
KAHULUI DEVELOPMENT CORP., General Contractors

What steps should an employer take if it wants to give its workers the steadying pride of owning good homes of their own?

The steps the Hawaiian Commercial & Sugar Co. took might well be tacked over the desk of any industrialist concerned with labor unrest or plagued with a "company housing" bogey. Those steps were:

1. *Get a good town planner*
2. *Get a good architect*
3. *Set up a nonprofit development company*
4. *Make 2,200 acres available at no mark-up over its farm land value.*

This program paid off fast

The planned community, with its winding streets, wide lawns, its parks and its shopping center proved an eye opener to the sugar workers, though it stuck to tried and true practice. The modular design worked out by the architect and the volume building methods imported to the island by the development company made possible a house for as little as \$7,100 which, though conventional, compares favorably with most \$10,000 to \$12,000 houses in Hawaii—a dramatic demonstration of the tremendous economies inherent in architect and volume builder collaboration.

For that \$7,100 the worker gets (1) a wide (70' to 80') lot which the development company would be glad to help the purchaser landscape; (2) a three-bedroom, 1,090 sq. ft. house. Every bedroom is oriented to the prevailing trade winds which alone make tropical Hawaii cool and comfortable. But the row pattern is given variation by a carefully worked out scheme for shifting the living room and the carport.

Perhaps more important, he gets a chance to be a property owner in a 4,000-house community which his employer will make no effort to control but where orderly future development of parks, schools, utilities, commercial and industrial land is assured.

A plan for action

The sugar company operated over 3,000 houses for its workers on the island of Maui, in 25 villages scattered over 30 sq. miles. The war made proper maintenance impossible and most dwellings needed some repair. Housing, fuel and medical care were furnished to all workers as part of their wages. Then the system underwent a revolution: unionism came to the sugar fields. One provision of the union contract was that these "perquisites" be paid in cash, and the worker be permitted to buy his shelter wherever he chose. The Hawaiian Commercial & Sugar Co. wanted out of its rental housing and wanted to avoid any solution that would add to the employees' dependency on the company.

← R. Wenkam

"Our hope is for a modern community to provide progressively better housing and living for residents of central Maui. The sponsoring companies will have to put thousands of dollars into the enterprise. We know that investment in community welfare is good business for all of Maui. We will not let this project become a land speculation deal in any respect." Asa F. Baldwin, manager, Hawaiian Commercial & Sugar Co.
A. K. Kim



When the second group of 250 houses was announced for sale many employees stood in line all night and all day for nearly 48 hours for fear of missing a chance to buy.

Harland Bartholomew & Associates of St. Louis, Mo. were engaged to recommend a course of action with four major goals:

1. Develop the best possible living conditions for the company's employees
2. Encourage a sense of civic responsibility on the part of employees
3. Eliminate, if possible, the subsidization of housing and related utilities
4. Eliminate the landlord-tenant relationship between company and employee.

It was a dream assignment. All the land was under one control; the site had a natural hub, the harbor of Kahului; it was well drained, sloping to the sea. Bartholomew could lay out a town of 4,000 houses, complete with parks and sites for schools, churches and shopping facilities. He could plan the utilities. But co-ordinated city plans are gathering dust in almost every city in the U. S. The difference in Kahului is that the plan was immediately implemented and two years later the first 500 houses are built or under construction, and the plan is developing just the way Bartholomew wanted it to. The rental housing was torn down.

HAWAIIAN COMMUNITY

Shopping center will be expanded slowly to avoid dislocation of town merchants. Preference in new center will be given retailers in present commercial area. Parking area holds 11% of all Maui vehicles.

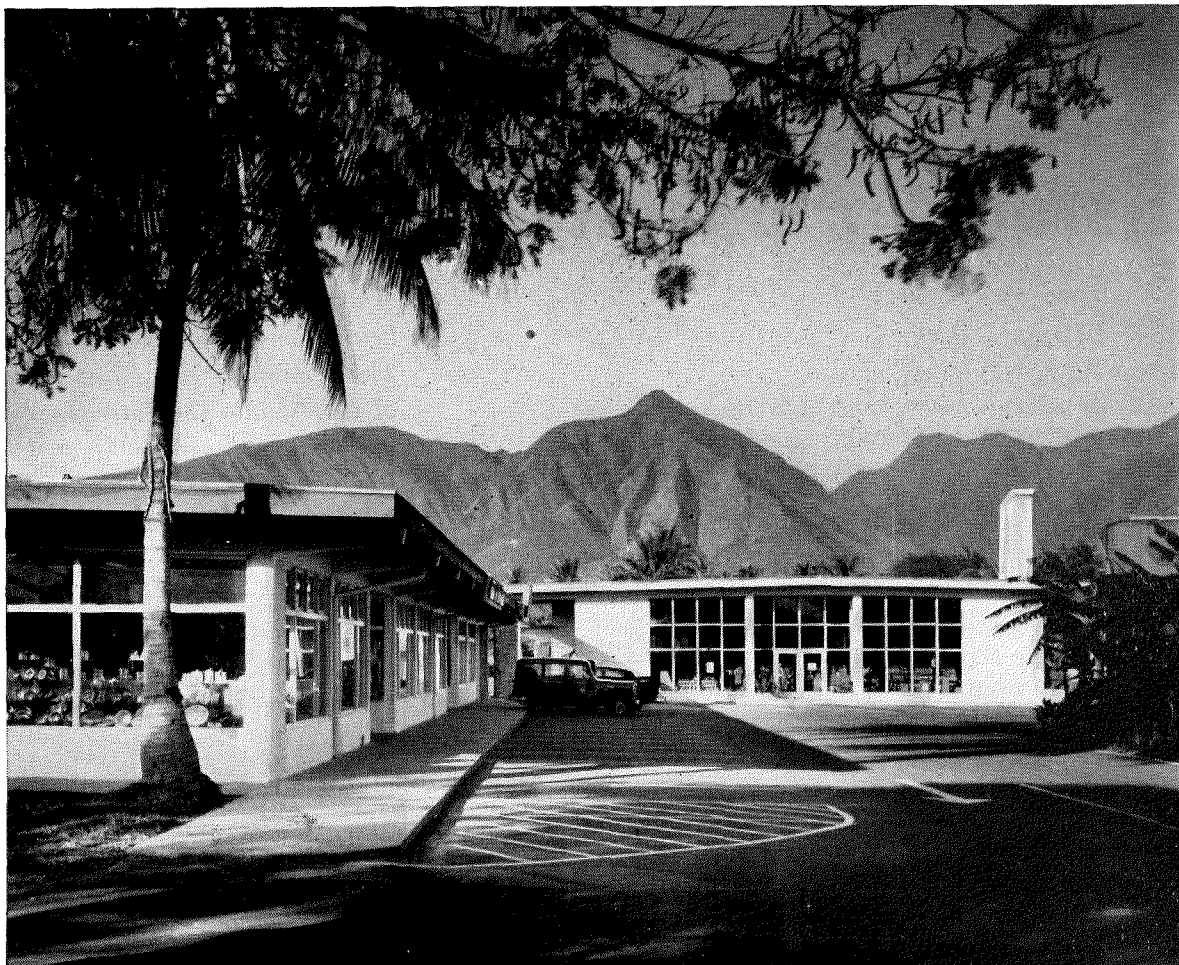

R. Wenkam

Main traffic arteries are from 80' to 100' wide, radiating from the business district like the spokes of a wheel. In residential areas, lawns slope to curbless 50' wide avenues, giving the effect of pleasantly rolling countryside. Residential tributary streets minimize through traffic. For orderly developments, the residential area was split into three sections, each with a 15 to 20 acre park near the center. Five acres of this is reserved for elementary schools and playgrounds, the rest for picnicking and games. No child has to go farther than ½ mi. to school or ¼ mi. to a playground.

Putting the plan to work

The sugar company did its part. It created a new separate limited-dividend company, the Kahului Development Corp., to handle all planning, financing, construction, sales and management. The parent company turned over 2,200 acres of land. Money for utilities was lent to the development company by local banks (guaranteed by HC&S) to be repaid as the land was sold.

The house for the plan

Then Harvard-trained architect Theodore Vierra was given the job of designing a house for workers whose annual wage averages \$2,400. What he came up with is a 1,090 sq. ft. reinforced hollow masonry house, ranging in cost from \$7,100 to \$7,500 (newest models go as high as \$8,900), including 70' and 80' x 120' lots and all utilities. With the usual 10% (before Regulation X) down payments, monthly charges averaged \$47.50.

There are several keys to Vierra's successful solution:

1. A basic unit of three bedrooms, bath, laundry, kitchen, dining alcove and storage room, identical for each house
2. Living room and carport that can be shifted so that three of the four exterior elevations may be used on the street side

3. Utilization of all possible local materials, i.e. cinder block, fiberboard panels made from cane stalks, local millwork
4. Elimination of all unnecessary site fabrication.

Variation on a theme

Three types of roof—hip, gable and a combination of the two—give different roof lines. In addition, the ridge line of the basic unit is higher than that of the living room. Thus, high points of the roofs fulfill the current builder ideal of varying the perspective when viewed from the street.

Bathroom storage closet, linen and broom closets are one unit, built at the mill and moved into the house like furniture. Partition and ceiling panels were used as they came from the factory, with no cutting. Laundry and bath are back-to-back, share plumbing. No blocks need be broken to fit angles and openings.

Citizens with a stake in the community

But what the house has mainly given buyers is a home that they could not even have dreamed of before mass production. To duplicate it elsewhere in the Islands would cost as much as \$12,500, a sum far out of reach of the average worker. It graphically demonstrates what the U. S. takes for granted: the merchant builder and his methods are the highroad to low cost housing in the volume necessary to house a nation.

The first section of 200 houses was completed in 1950, and immediately another tract of 250 was opened. The response was overwhelming. Though the houses were to go on sale at 10 o'clock one Sunday morning, buyers started lining up at the sales office Friday, almost 48 hours in advance. They brought cots, bedding and tents to make their stay comfortable. The scene resembled the beginning of an old-fashioned land rush. When the sales office closed Sunday afternoon, 170 houses had been sold. In the first 2½ hours, one house had been sold every 3 mins.

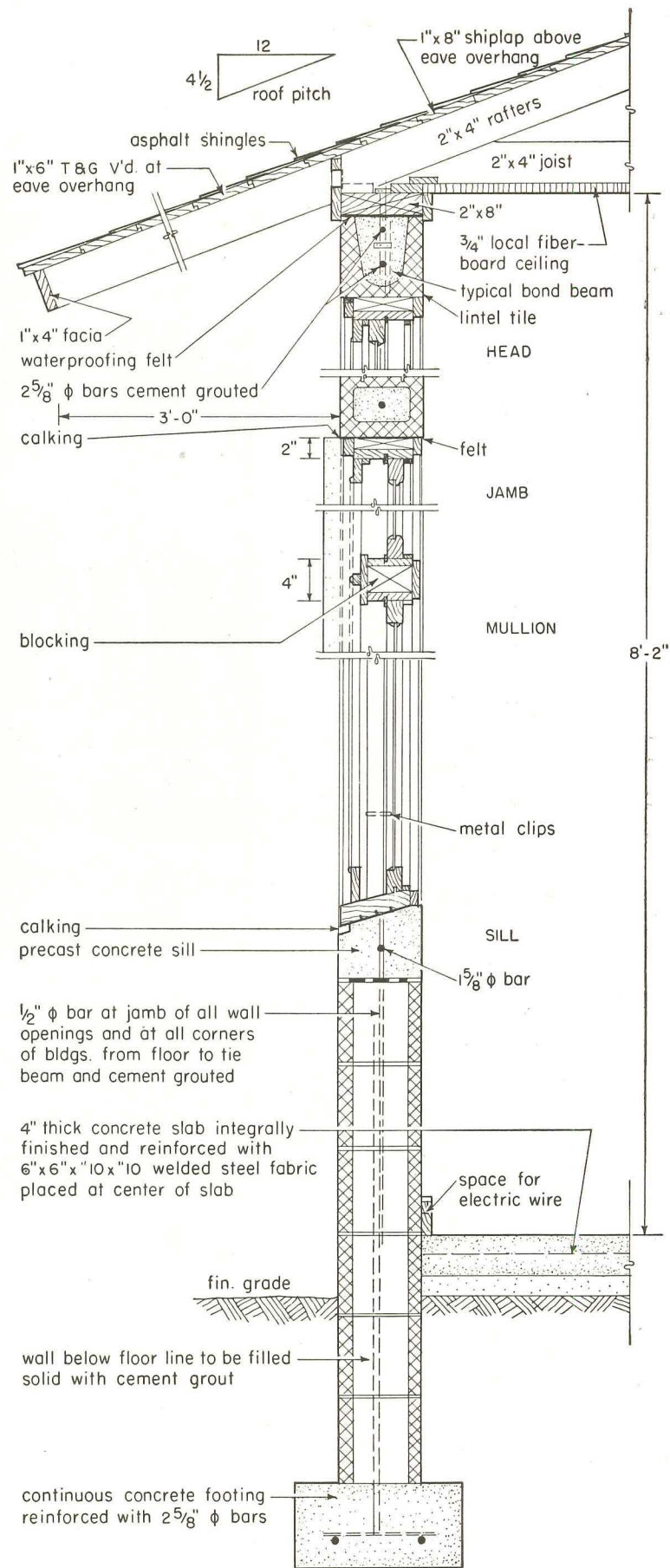

Not "company housing"

There is nothing about Kahului that smacks of charity or paternalism. The \$1,300 per lot for improvements is included in the sales price. The only concession: raw land given to the project was assigned an arbitrary value of \$100 per lot (its value as farm land) in figuring the sales price. Any deficit the development company assumes in residential areas will be more than repaid by profits from commercial and industrial land.

Neither the Kahului Development Corp. nor the sugar company enter into the financing, which has been handled entirely through two local banks on FHA and VA insured mortgages. Nor does the purchase of a house obligate the buyer to HC&S in any way. Sale is not limited to employees. In fact, to avoid the disadvantages that go with a "company town," one of the strong points of the Bartholomew report was that sale of houses be open to all buyers.

Town of the future

The Kahului shopping center is being developed, with a grocery supermarket and a drug and variety store as the first units. Two hundred thousand sq. ft. are being reserved for the retail shopping area since the natural hub location of Kahului makes it the inevitable shopping center for the whole island. All main roads lead through the town. The adjacent harbor, the only good one on Maui, brings more people and business. Service trades, other allied commercial enterprises and semi-industrial firms will be located on the edge of the retail area. Profits from the shopping area can be plowed back into improvements for the entire project.

The present commercial area will be replaced by a harborside park and modern hotel, and displaced merchants will be helped in establishing new stores in the shopping center. The company will put up buildings in the central area, while those on the perimeter will be built by individuals on long term leases.

A summing up

"As we enter the fourth year of the Kahului project, we are more than ever convinced that a stable community, comprised of people who have a stake in its welfare, is the most wholesome in which to conduct a successful business. We feel that the money, time and effort invested in this project have been well spent."

Herbert Jackson, manager, Kahului Development Corp.

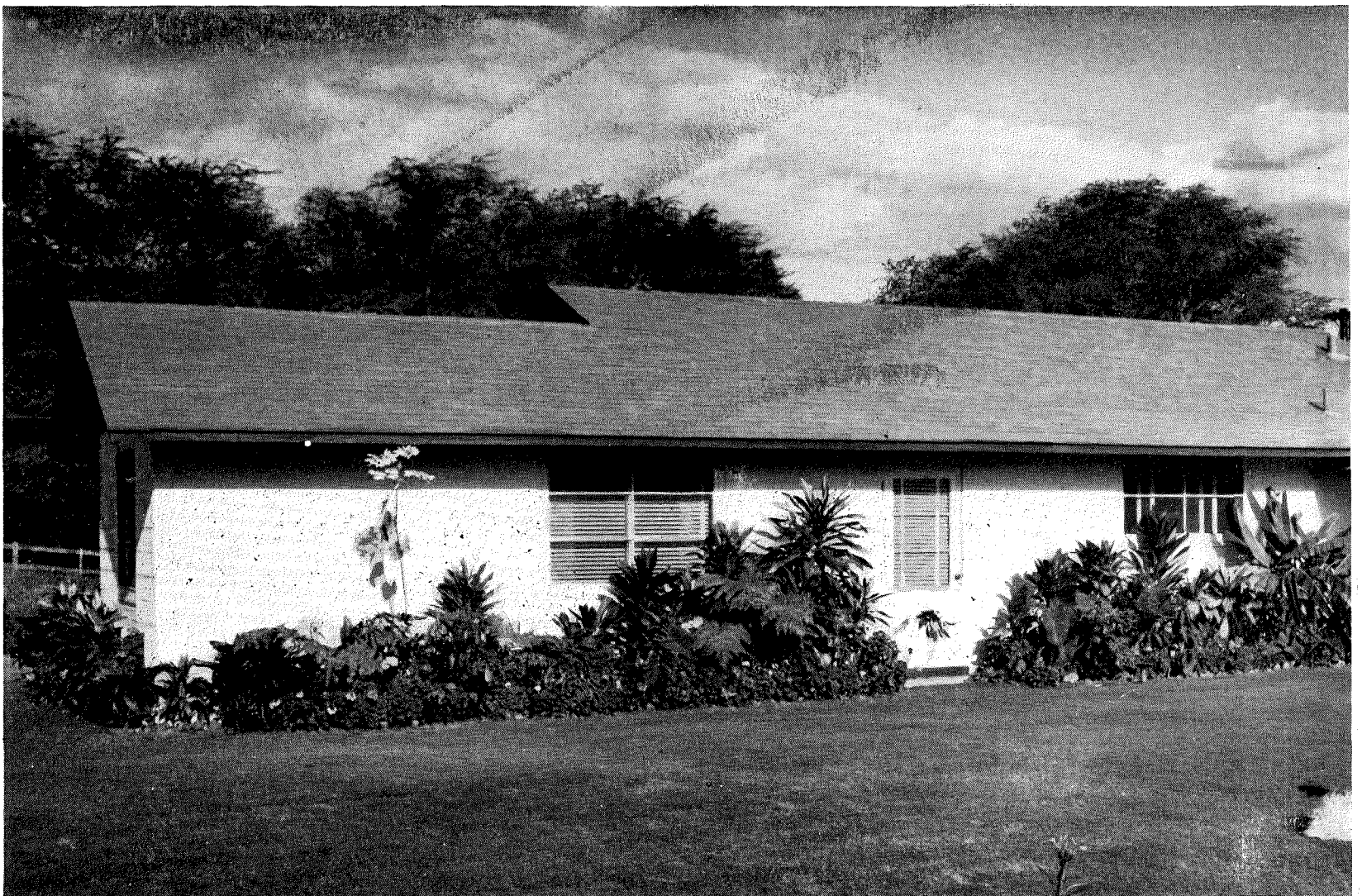

Second tract of houses keeps original design but gives longer front elevations and adds sliding glass doors in living room to open onto lanais (covered verandahs or patios), important to Hawaiian outdoor living. Site improvements represent 17% of housing costs. Conservative planning of project did not take into account many families with more than one wage earner, or with savings to give a greater than 10% equity in the house. Average adult wage in 1951 was \$9 per day, with all-year employment.

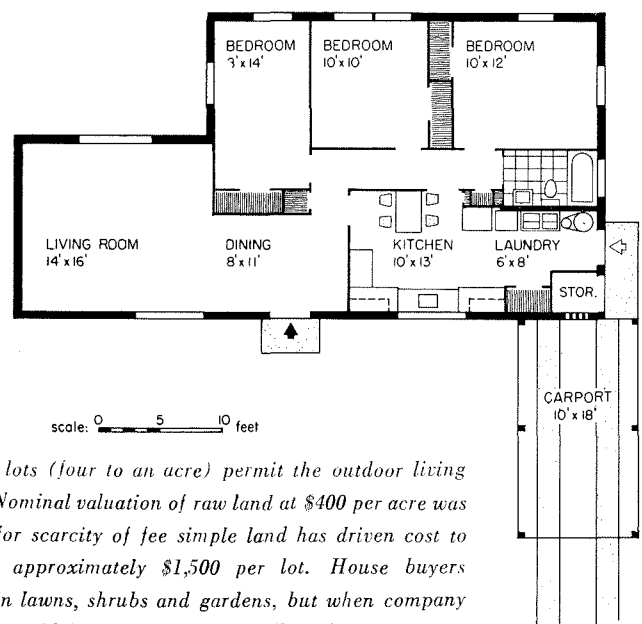

Generous 70' and 80' lots (four to an acre) permit the outdoor living that Islanders enjoy. Nominal valuation of raw land at \$400 per acre was essential to success, for scarcity of fee simple land has driven cost to \$4,500 to \$5,000, or approximately \$1,500 per lot. House buyers couldn't wait to put in lawns, shrubs and gardens, but when company offered free trees, it couldn't give them away. Vierra's house cost \$5.21 a sq. ft.; individually built houses on Maui ranged from \$8 to over \$10 a sq. ft.

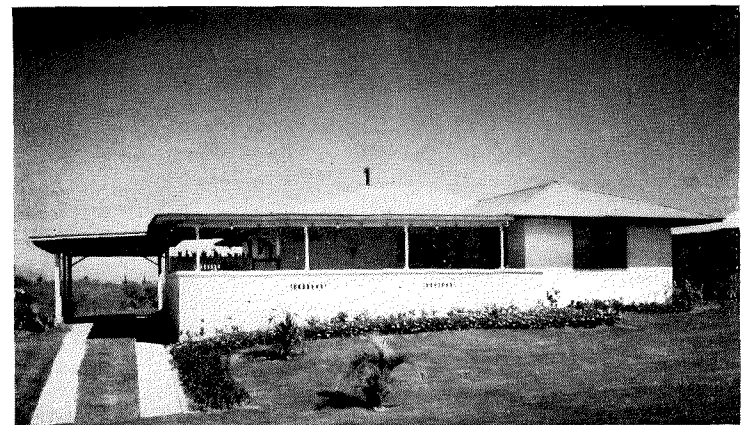
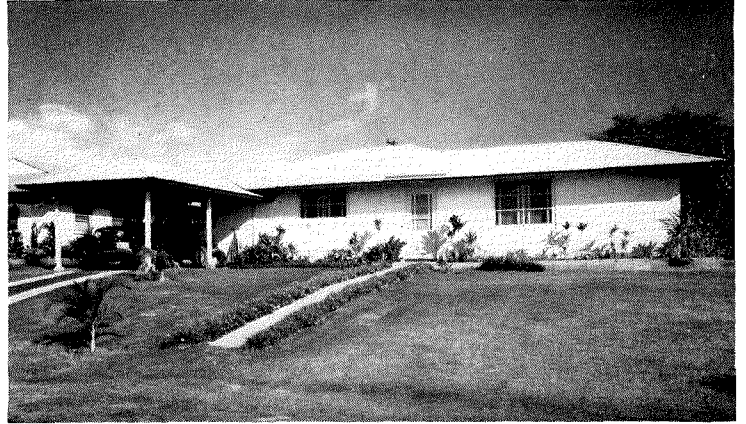
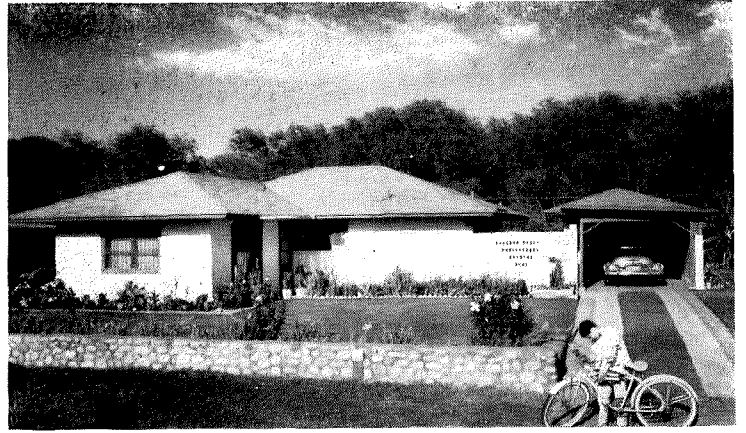
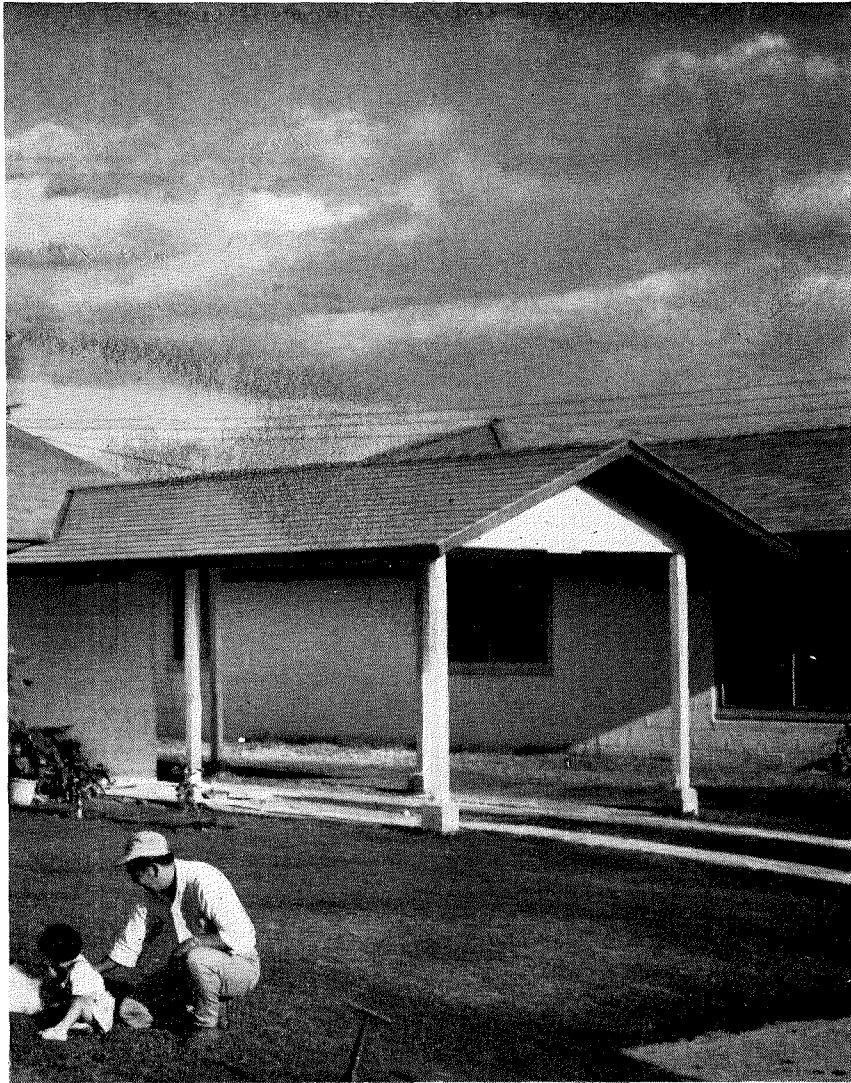

Photos: R. Wenham

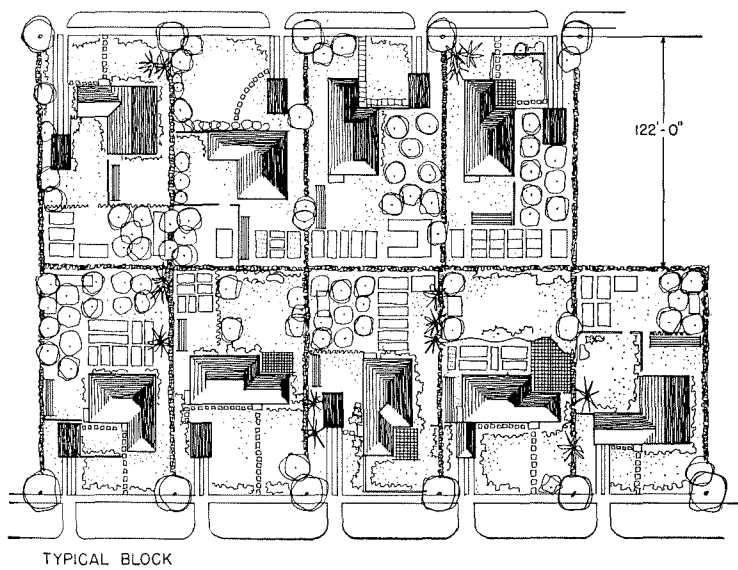

Interior and exterior of concrete block walls are painted, the latter with waterproof paint. Color is integrated into concrete floors, which are then waxed, but many purchasers preferred to pay premium to get asphalt tile or wood block floors. Building trades (nonunion) wages range from \$1.50 to over \$2, which means that men who build houses are also able to buy them, thus making potential market even wider.

OPEN-PLAN APARTMENTS

16 ideas for multistory living

LOCATION: Honolulu
JOHNSON & PERKINS, Architects
K. D. PARK, Structural Engineer
MANSFIELD CLAFLIN, Landscape Architect
CONSTRUCTORS OF HAWAII, Contractors

This four-story walk-up, built just off Waikiki Beach for a low \$7.83 per sq. ft. (and currently bringing rents as high as \$145-\$150), challenges many of the traditional practices accepted in small apartment planning. A number of the ideas it incorporates might profitably be adapted to apartment design on the mainland, notably:

- ▶ A concrete frame so designed as to act as an efficient sound-deadener between apartment units, laid out so as to eliminate virtually all ceiling-high partitions inside, and poured to look like a rough-textured wood finish.
- ▶ Compact floor plans that can be thrown completely open from front to back: inside to increase a feeling of space in close quarters, at both ends to catch view and trade winds.
- ▶ Versatile sun-shading balconies that double as entrance porches and insect screening on the front, fire escape access in the rear, and as areas for sunning, tending small gardens of potted plants, drying laundry, and washing all windows.

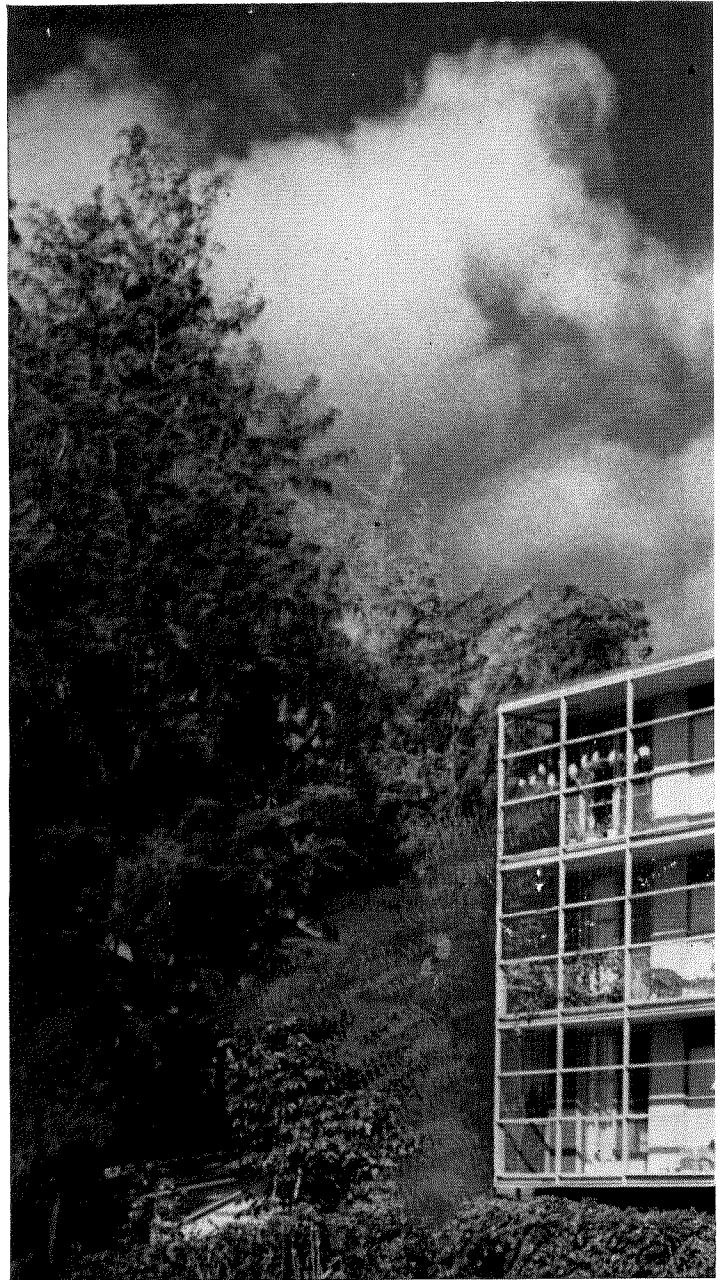

1. Triple-duty porch. On rear of building, above, four continuous overhangs act as (1) partial sunshade, (2) porch for sitting, plants, window-washing, (3) access for all apartments to fire escape ladder at right.

2. Window-washer's walk (left). Front entrance porches are carried around to side, forming ledges just wide enough to stand on while washing side windows. Railings add safety.

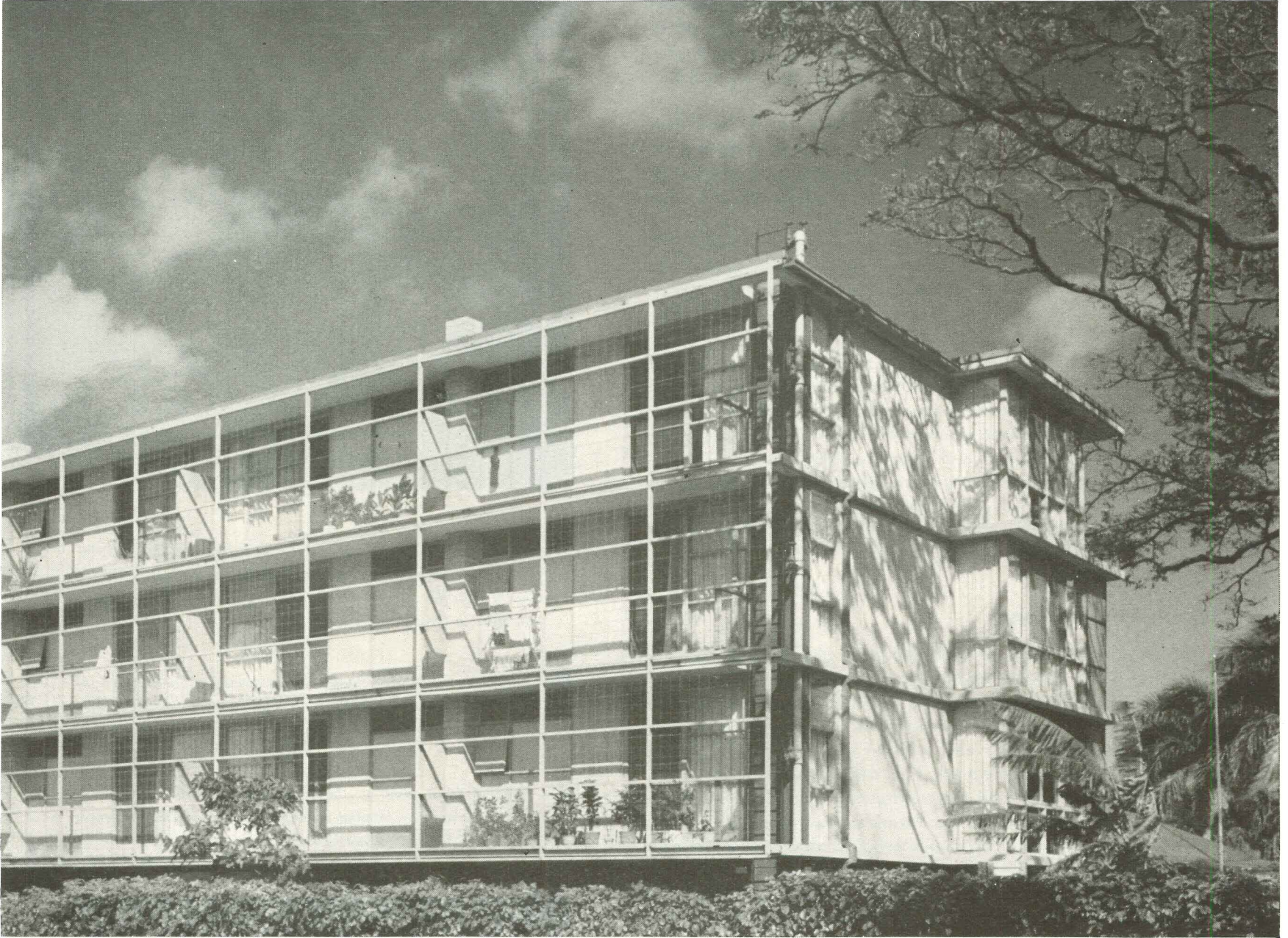

Photos: R. Wenkam

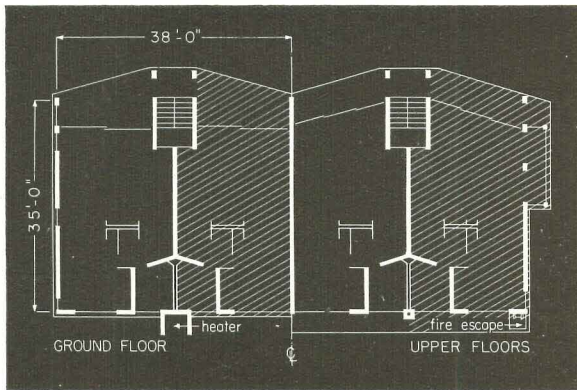

3. Soundproof concrete walls. Bearing walls act as solid sound-deadeners between apartments.

4. Split bearing wall. Central core of each bank of apartments is a bearing wall which splits at front to form stair well, at rear to form "Y" around bathrooms; plumbing wall is nonbearing tile.

OPEN-PLAN APARTMENTS

What price privacy?

The layout and construction of this 16-unit building raise several questions, among them: just how much internal privacy, either visual or acoustical, do the one or two occupants of any one-bedroom apartment need between the rooms *within* their apartment? Some standard one-bedroom 608's go to great lengths to wall off kitchen and bedroom completely from other rooms, but often fail to reduce noise transfer from one apartment to the next.

In contrast, architect-owners Johnson & Perkins have spent their money on concrete floors and bearing walls *between* apartments to keep out noise but have made no expensive attempt at creating internal privacy—a necessity in two- or three-bedroom units but hardly needed with a single bedroom.

By running closets, casework and movable screens to a height of 7' (allowed by Honolulu building code in a first class building) and the kitchen "stall" to 4½', ceilings are left uninterrupted and all rooms, with the exception of the bathroom, can be shared visually from the others.

To throw the bedroom open to the living room and create natural ventilation from the front of an apartment to its back, a tailor-made sliding panel of plastic-coated screening was used. Known locally as a *susuma*, it is translucent, not excessive in cost (\$25 each installed) and the screening is available in rolls as a stock item. As a living-bedroom partition, it was paint-sprayed lightly on one side for greater opaqueness. Set in a light, thin frame, it slides easily into a recess between bookcase and closet. It was also used in a sliding door for the bedroom wardrobe.

Open-ended plans

Front and back walls of each apartment are virtually the only exposures to the outside, and to give the living room and bedroom the advantage of these wide-open end walls, the kitchen was relegated to the deep interior. In this position it is convenient to the dining area, can double as a bar and, with an exhaust fan instead of a window, is adequate for the quick, light cooking requirements of two people. The 4½' high stall that separates it from the living room shields sink, refrigerator, stove and work surfaces from view, allows only a glimpse of unobtrusive wood cabinets which harmonize with the rest of the apartment's millwork.

Pivot point of the plan is a small hall which uses up 16 sq. ft. of floor space, but in return provides an important circulation feature: direct access to the bath from *either* kitchen and living room *or* bedroom without going through another room. When desired, the door of the small storage closet in this hall can swing to full open position to do double duty as a door to the kitchen.

Plumbing risers and stacks for back-to-back kitchens and baths are carried in a nonbearing plumbing wall of tile between each pair of bathrooms.

Placement of the outdoor stair well slightly in front of the building resulted in an angular plan that gives the illusion of a little more space inside each living room (and a splayed street facade whose forms and ornamentation are purely a matter of taste). Notable is the entrance lanai provided each apartment by this planning: permanent insect screening is put on the outer face of the building's front, leaving the glass doors of the living room to slide freely without the nuisance of sliding screens as well. As it is, tenants leave the glass doors open about 90% of the time, which gives them a larger living area, more breeze and a place where plants can grow. To provide the first-floor entrance lanais with more privacy from the street, panels of plastic-coated screening were installed across the front from knee to shoulder height.



- 5. Open plan** (below). With an open kitchen and sliding screens to bedroom, each apartment can be thrown open from front to back. Movable glass walls of living room and bedroom open to create a through breezeway.
- 6. Bathroom hall** uses 16 sq. ft. of floor space but provides access to bath from kitchen-living room without going through bedroom. Hall closet door can swing over to shut off kitchen
- 7. Splayed front wall** on the "lanai" gives living room more floor area and, by forming an angle with other walls, relieves right-angled, boxy feeling of the average apartment.

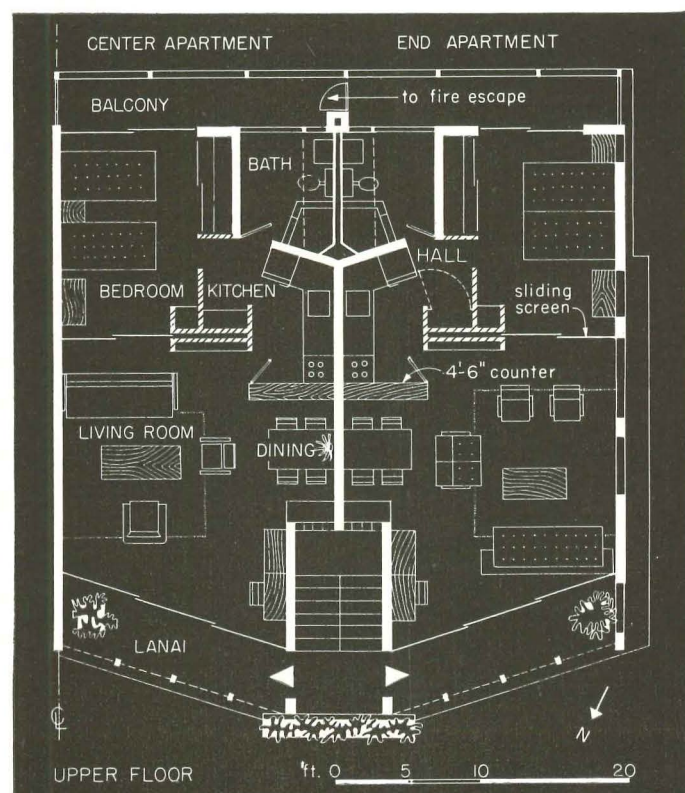

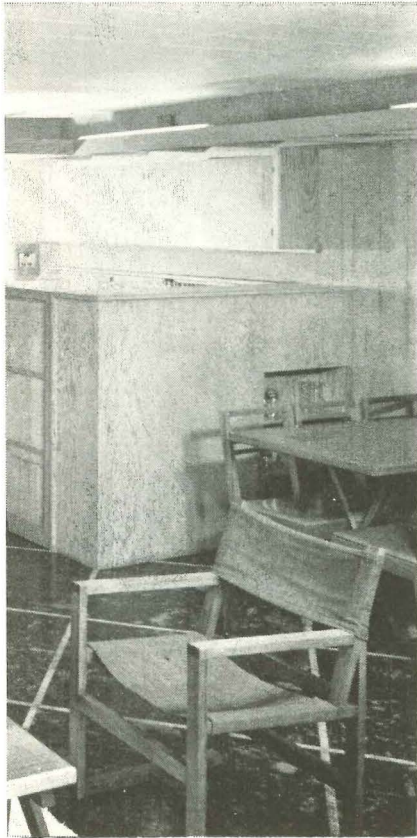

8. *Open interior kitchen (left) is adequate for light cooking. Its 4½' high counter wall is high enough to hide work surfaces and appliances yet allows kitchen space to be shared by living room.*

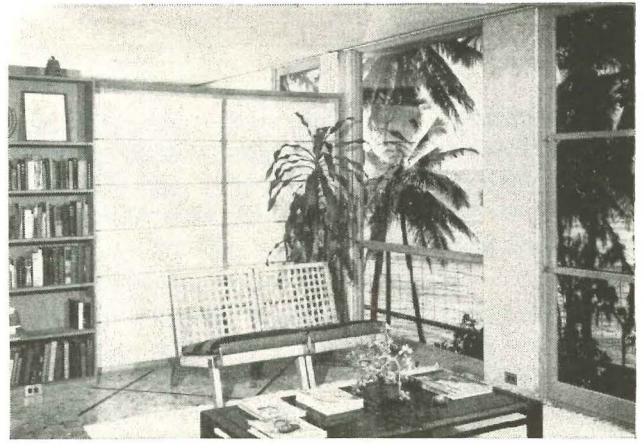

9. *Sliding screens (right) of plastic-coated screening are opaque enough for privacy needed in a one-bedroom apartment, translucent enough to filter light through to both rooms. Below, they slide easily into slot behind 7' high bookcase.*



10. *Acoustic ceiling, similar to those used in noisy offices, deadens sound, helps concrete slab prevent noise transmission from apartment above. Stock acoustical panels were cemented directly to underside of rough slab.*

11. *Porch entrance (right) utilizes overhang to create a plant-filled foyer. With sliding glass doors open, this increases apparent size of living room.*

12. *Fixed independent screening made possible by porch entrance relieves glass doors of weight and cumbersomeness of sliding screens.*

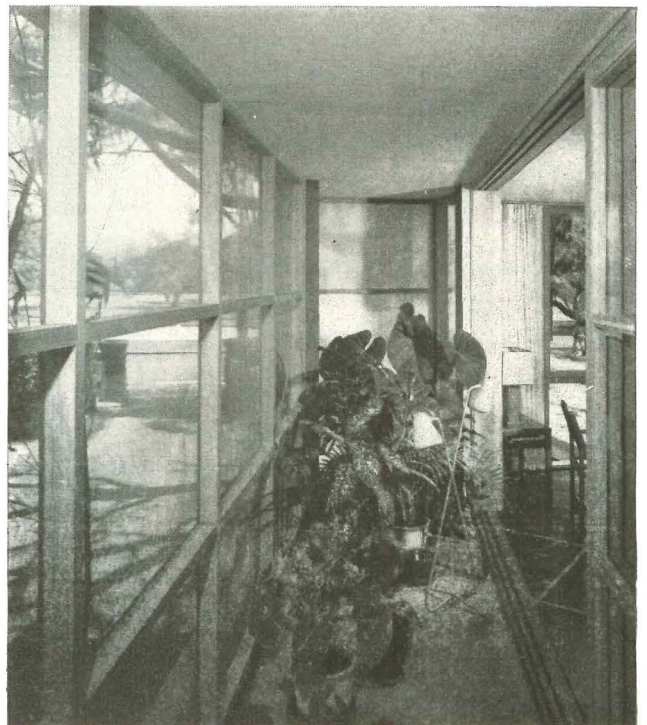

OPEN-PLAN APARTMENTS

The structure: To achieve unobstructed interiors, open end walls and acoustical insulation between units, floor slabs and bearing walls of poured reinforced concrete were used. The building started out to be three floors at approximately \$25,000 per floor, but it soon became clear that a fourth floor at \$17,000 was a good buy. The ground floor is a 12" slab that serves as a floating foundation on the solid, sandy soil. Eight-foot room heights plus 6" floor slabs in the upper stories (spanning 18'-10") bring the whole building height to some 34', little higher than most three-story buildings.

The concrete work for the walls was done so carefully that the end result looks surprisingly like the wood forms it was poured in, so much so that many Honolulu people look at the patterned surface of the concrete walls and are sure it is an all-wood building. By using 1x4 T&G clear fir planks, treating them with water repellent and cleaning and oiling them after each use, the builders were able to get the clear imprint of rough, vertical grained wood, as precise in detail on the top floor as on the first. This attractive texture was left exposed on both exterior and interior walls and painted two shades of lush green, thus by-passing more costly wallpapering, wood paneling and above all plastering, the most expensive trade in the Islands. Plywood forms were used for the floor slabs, and unpainted acoustical tile cemented directly to the ceilings for added sound insulation.

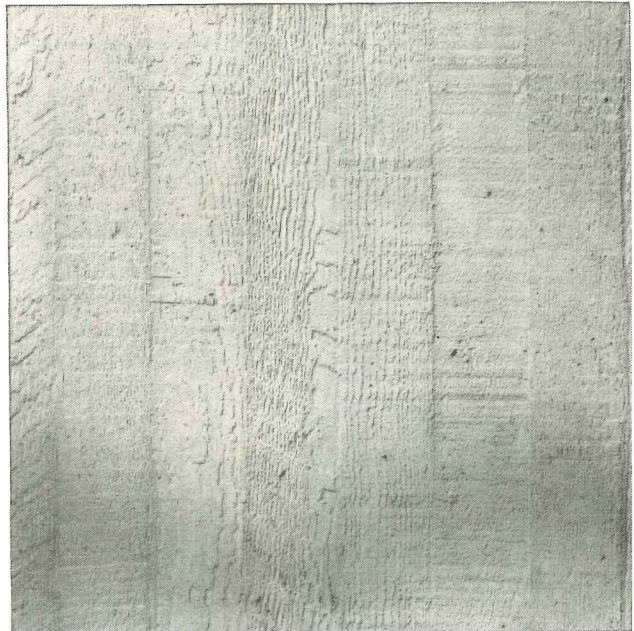

13. Board-finished concrete retains attractive texture of wood forms in which it was poured. This surface, used on both inside and outside walls, was merely painted, bypassing costly wall finishes.

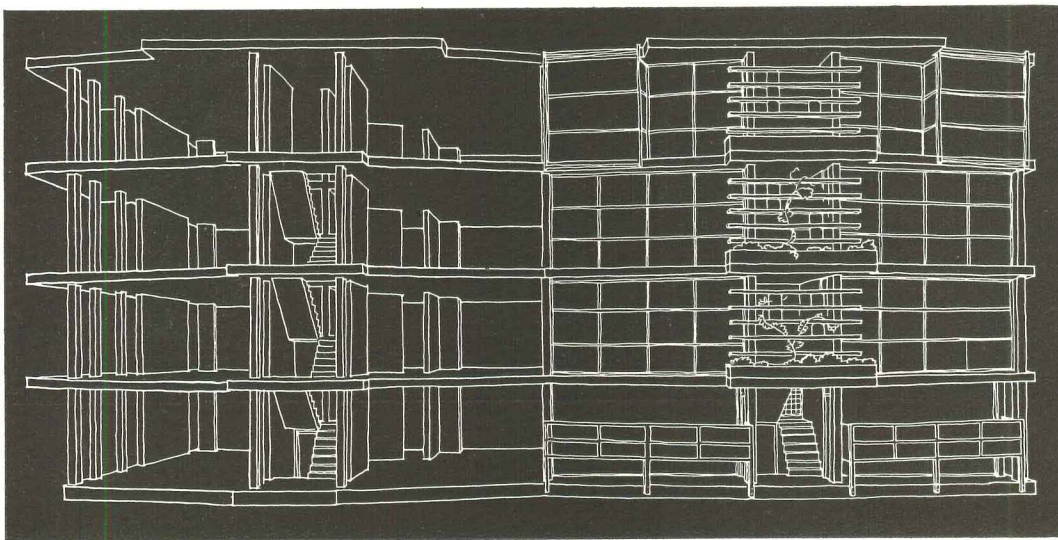

14. Open stairway (above), suitable to warm climates, eliminates cost of front wall, is easy to maintain. Concrete bearing wall construction left ends of apartments open to light and air, interiors virtually free of solid partitioning.

15. Stairway "skylight" of glass block (right), on landing between the floors, admits light to inner dining areas of apartments.

16. Stairway pass-through (out of sight above glass block) connects with a wooden cabinet inside each apartment for deliveries.

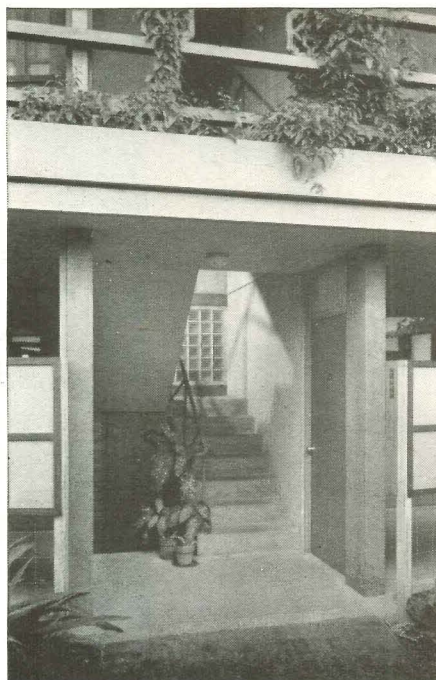

COST BREAKDOWN:

Mobilization	\$2,000
Forms	12,186
Concrete	15,773
Reinforcing steel	8,849
Carpentry and millwork	22,688
Acoustical tile	2,871
Metal lath and channels	526
Ceramic tile	2,977
Electrical work	3,232
Electrical fixtures	639
Electrical fans	356
Plumbing and flashing	6,697
Stainless steel sinks	1,708
Plumbing fixtures	2,010
Shower doors	309
Two gas heaters	850
Glass block	386
Wrought iron and pipe rails	262
Mirrors	231
Asphalt tile flooring	2,045
Painting	3,600
Tar and gravel roofing	418
Hardware	954
Miscellaneous extras	1,282
Landscaping	732
Rent for adjoining lot during construction	753

TOTAL\$94,334
 Gross area of building: 12,000 sq. ft.
 Floor area per apartment: 750 sq. ft.

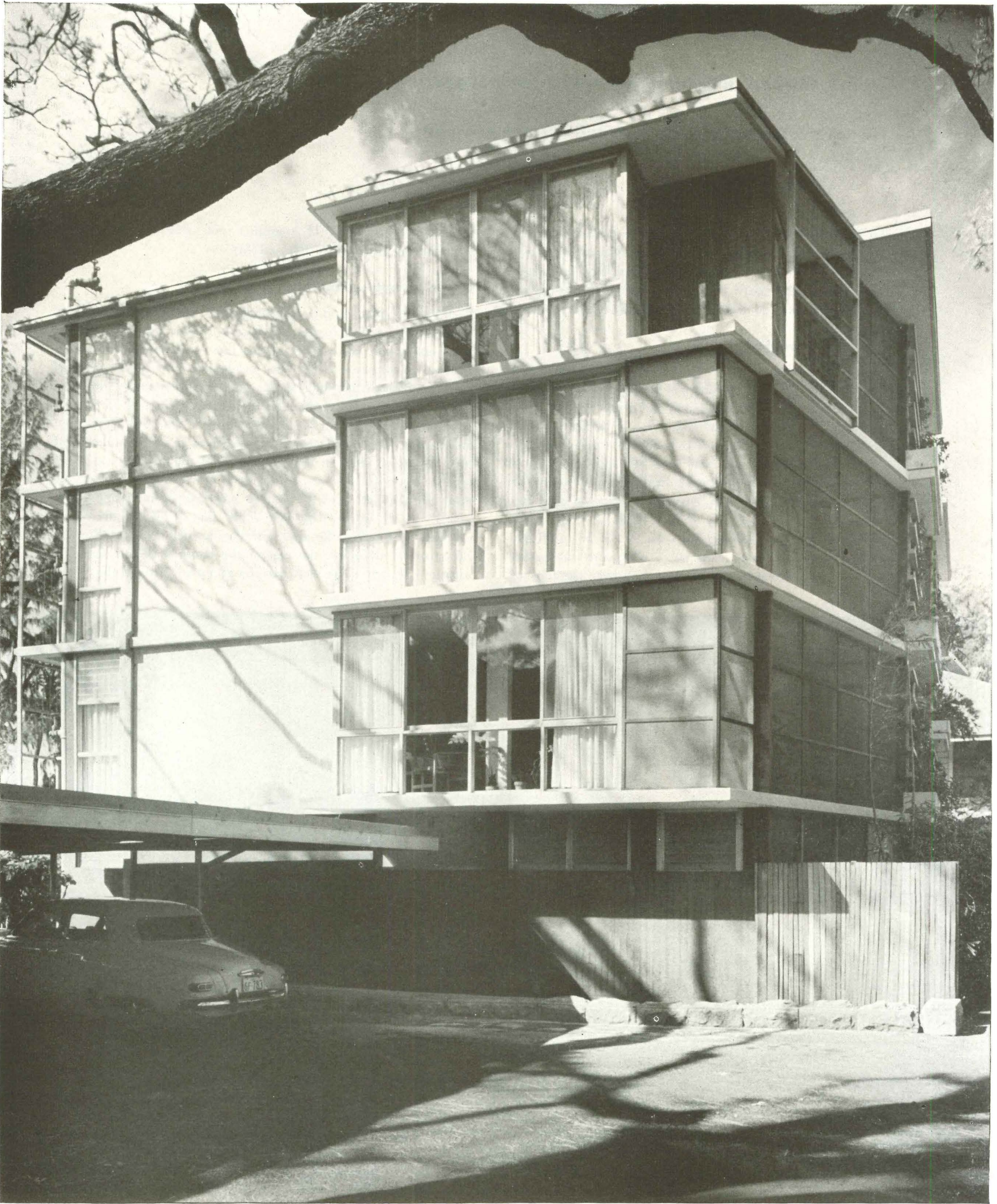

NO BEAMS IN THE ROOF

This laminated, mill-type roof construction suggests a method

for achieving an unbroken sweep of roof in wood

LOCATION: Portland, Ore.
VAN EVERA BAILEY, Architect

Northwest architect Van Evera Bailey has a rare talent for delighting the average customer and exciting his architectural cohorts at the same time. This house in Portland, Ore. is typical. It has charm aplenty to beguile the laity, plus a structural innovation that gives architects and builders something to think about.

New construction method

The roof over the main portion of this house is laminated out of rough-sawn 1" or 3" by 4" lumber set on edge. The 16' spans rest on 4" x 8" purlins at the ridge and side walls. Although at first glance the 4" laminate seems like a lot of lumber, Bailey points out that it takes the place of four separate components—beams, sheathing, insulation and ceiling finish—and it goes up in one operation instead of four. (In the Northwest this lumber is comparatively cheap.) The flush, structural plane makes carpentry at the side walls extremely simple (*drawing, page 136*). There are no beams, and therefore no need to "let in" or frame around them. Bailey suggests using strips of sponge rubber between members to prevent air leaking up and over the tops of

exterior bearing walls. (For another roof using this type of construction see H&H, Mar. '52, p. 138.)

Charm without schmaltz

Bailey's particular brand of hard-headed, warm-hearted acumen endears him to his clients. He has built some two dozen rental units out of his own pocket, so his interest in economical, long wearing construction is far from academic. Clients also respond to his unaffected handling of the rambling, low-slung Northwest idiom. A native Oregonian, he thoroughly enjoys the informal outdoor-indoor life and his design shows it (his own home is a houseboat). This particular house squeezes every advantage out of a handsome site. In the glass prow of their living room, the owners are virtually suspended over a triple-threat view: the river and the city are 1,100' below, snow-capped mountains form a wall 40 mi. away. However, since this is toward the blowy northeast (and even the most eye-riveting view needs contrast to be appreciated fully), the rest of the house bends to shelter a southerly terrace. The view may be glimpsed through the house.





A sunny terrace, above, fills the sheltered space at the bend of the house. Through parallel windows you glimpse the view.

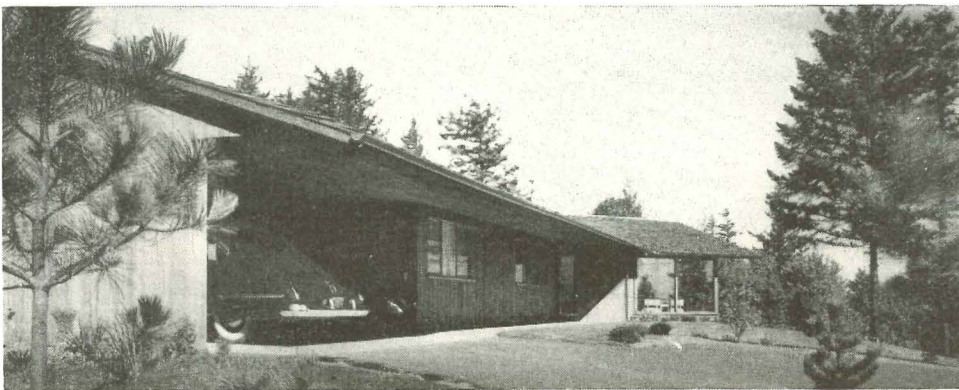
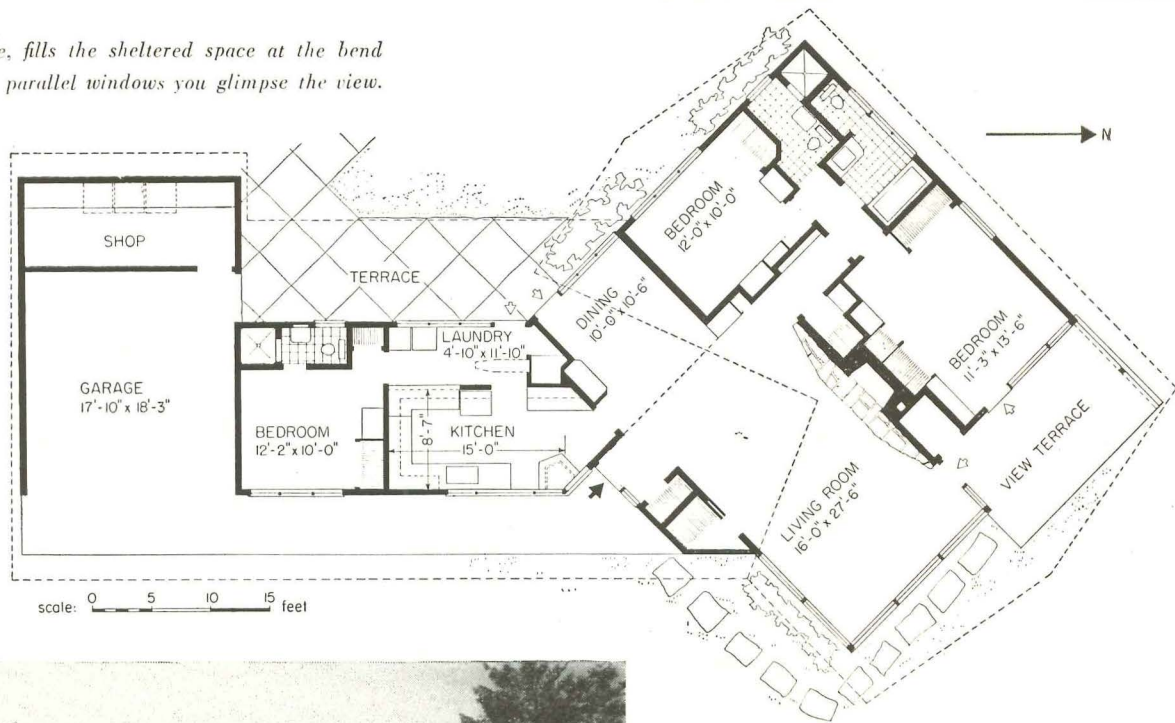

On the entrance side, left and opposite, the long wall of the service wing is like the shaft of an arrow directing you toward the living room which is the arrow's head. Where the two forms meet, you enter the front hall. A 7' overhang shelters the long entrance walk.

NO BEAMS IN THE ROOF

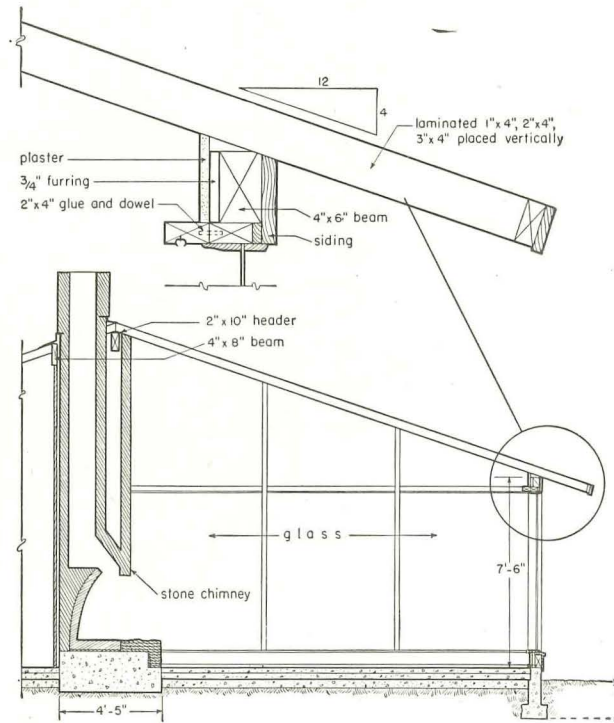
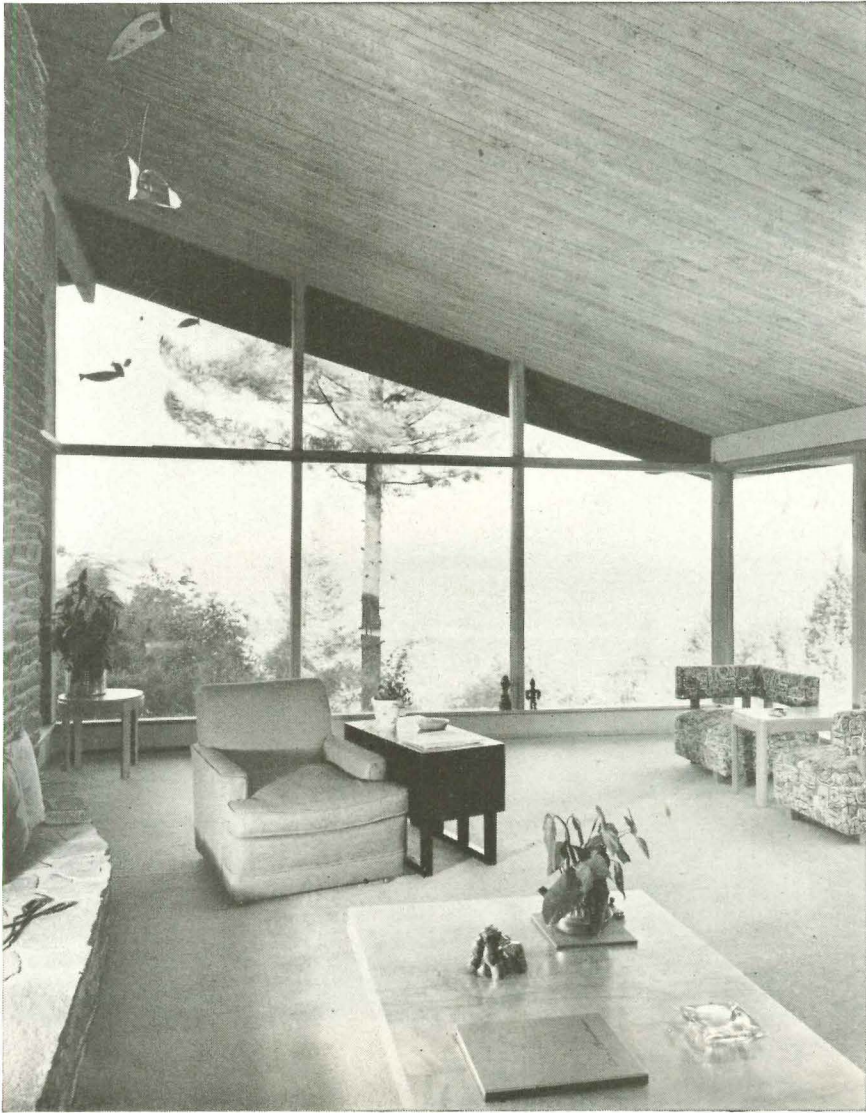

The living room ceiling, above, is laminated in the same way as a mill floor from 4" lumber set on edge. The boards are rough sawn and vary from 1" to 3" in thickness. Drawing shows how this simplifies carpentry. The cedar shakes are nailed to the laminated roof.

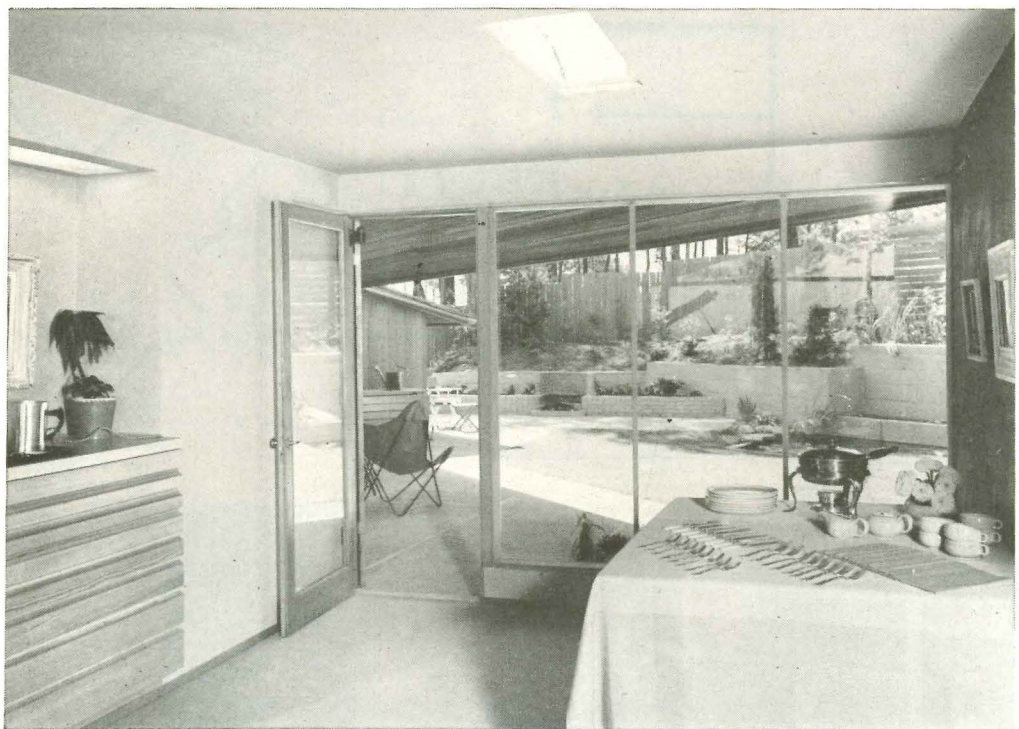

For a change of pace, the dining room ceiling, right, is set at a lower height. The view outdoors is intimate, enclosed by garden walls and the rise of the hill. When it rains, the wide eaves shelter the outdoor furniture.

Outside, right, the laminated roof spreads out like a rigid canopy slung between the projecting 4" x 8" purlins. This terrace overlooks the same view as the living room.



FORMS & FUNCTIONS OF 20TH CENTURY ARCHITECTURE

Edited by TALBOT HAMLIN

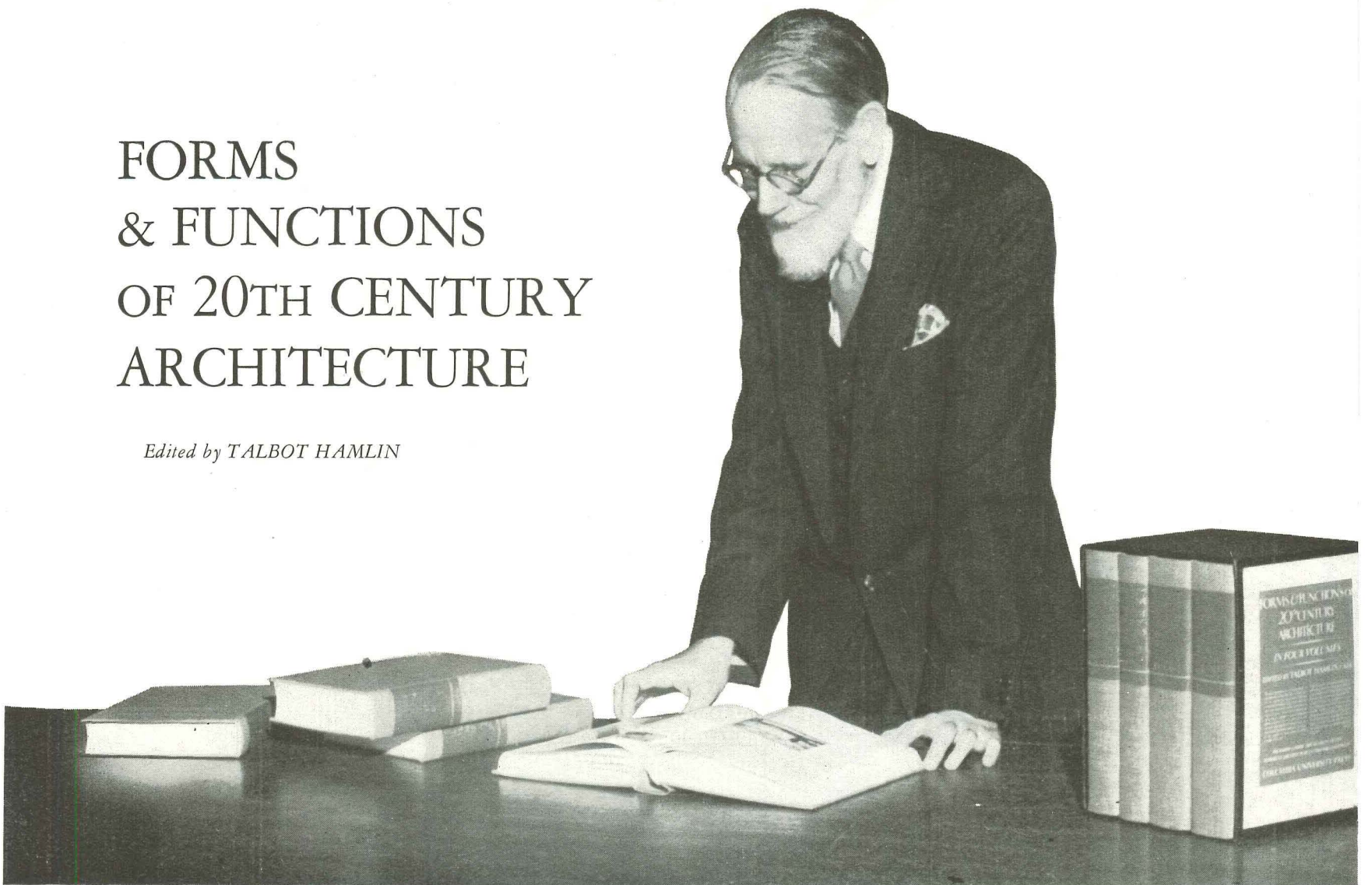

A MONUMENTAL STUDY OF TODAY'S ARCHITECTURE

A review by FREDERICK GUTHEIM, Assistant to the Executive Director of AIA

This vast, encyclopedic survey of modern architectural theory and practice,* a survey unequalled in the history of American publishing and unparalleled anywhere in our time, takes the measure of architecture at the mid-point of the century. Decades may pass before we see its like for breadth and authoritative treatment of all aspects of the art which tries to make the most of what we build.

Its four volumes cover every facet of its many-sided subject, and every major building type is treated by a special authority in the field. No one with serious pretensions to scholarship or practice in architecture, or who finds himself dealing with the building types involved—as builder, equipment specialist or any one of scores of other interested members of the building-producing team—is likely to find himself able to ignore this monumental and practical work. Those who are responsible for the investment of the \$30 billions which last year made building our largest national industry have a moral obligation, to say nothing of a practical business necessity, to understand the best which architects can produce and take nothing less. Here is the book of all books to which they can turn in their search for the information and ideas upon which to base their decisions.

Under the leadership of Prof. Talbot Hamlin, of the Columbia University School of Architecture, former Avery Librarian,

* *Forms & Functions of 20th Century Architecture*, edited by Talbot Hamlin. Four volumes, Columbia University Press, 1952. \$80.

critic and author of numerous architectural works, eminent authorities have here pooled their efforts to survey the panorama of architecture from a generally accepted common ground—the social basis of architecture. The analysis, bearing in every part the stamp of our foremost architectural historian, is thus a mirror of the ideas and criticism of our time as well as of its architecture.

In a sense it is also a companion piece to Prof. Hamlin's great survey, *Architecture Through the Ages*, his immense, one-volume history of architecture which was less a work of reference than an easily read synopsis for the layman. Many characteristics of the earlier work are here, too: the thorough-going librarianship, which gives us so much documentation and such good bibliographies; the ease in handling enormous masses of factual material; the thousands of illustrations; the good indexes with their excellent classifications—details fundamental to any really valuable work of reference but too often sacrificed to the demands of slipshod publishing and commercial production schedules. Under Prof. Hamlin's firm editorial hand, moreover, the individual authors have not been allowed to lose themselves in special enthusiasms. The forest, not the trees, is still our impression after four volumes. The love, devotion, cultivation and enthusiasm of the editor for his subject have infected his collaborators and infused themselves into the entire work.

(Continued on page 141)

The detached house, symbol of respectability

Like many emotional attitudes, the very strong general desire for individual detached houses is not always solidly based. Often the houses are so closely spaced on their small plots that the advantages of privacy are all but lost; better living could be provided at lower cost by row houses. To the average lower-middle-class citizen, however, the row house presents connotations he does not like; it is the detached dwelling which stands in his mind as an incontrovertible symbol of successful respectability. This prejudice is reinforced by the activities of the home magazines and the speculative builders.

Houses for Pilgrim Fathers

To anyone interested in studying domestic architecture from the socio-psychological point of view, the popularity of the pseudo-Colonial small house is as-

tonishingly revealing. That the generation which concocted the atom bomb and shot radar impulses to the moon should choose to inhabit dwellings reminiscent of the time of Cotton Mather cannot be explained in any but emotional terms. And, though the full answer is complex, it boils down to an inability to comprehend the world as it is, a lack of faith in the path along which our technology is taking us, and a deep fear of the insecurities inherent in our economic order. On no other basis is it possible to comprehend the amazing contradiction of the twentieth-century U. S. businessman returning each night to a home whose entire appearance has been calculated to produce the impression that he is one of the Pilgrim Fathers.

The Colonial house, magnificently functional

Actually the Colonial house, whose meaning has been so thoroughly degraded by present-day builders and architects, was in its time a magnifi-

cently functional dwelling. Its small rooms and low ceilings were a necessary consequence of inadequate heating facilities. Its small-paned windows reflected the cost and difficulty of obtaining large sheets of glass. Materials, whether New England wood or Pennsylvania stone or Virginia brick, were always used with a sensitive appreciation of their limitations. Moreover, a slow progress, covering generations, gradually developed in the woodworkers and masons a high degree of competence and taste, and the few basic designs then current were worked over again and again until the houses reached a high degree of refinement. The dwellings of that period also show that fundamental living patterns have not changed as much as might be expected in two hundred years: any number of people have found that these houses convert with unexpected ease to present-day use. One major difference is that the kitchen was used both as a living and dining room as well as food preparation center.

... with some pointed paragraphs from George Nelson's chapter on today's houses

For servantless houses, easier maintenance

During the period covered roughly by the two World Wars and the time between, the upper-income groups were deprived of their servants (through the development of more attractive job opportunities for women and the restriction of immigration) and of much of their income (through taxation). As a result, for this class large houses have become unmanageable and consequently unfashionable. When Le Corbusier announced that a house was "a machine for living" he deeply shocked the sentimental but he also expressed a feeling, which had already become fairly widespread, that houses had to become more efficient in terms of maintenance.

For smaller houses, larger outlooks

A small house does not necessarily mean an uncomfortable house. Josef Hoffmann observed, toward the beginning of the century, that the constricted area of a box at the opera was tolerable because the box opened onto a vast in-

terior. The same principle has been applied to the small house; a room may be small, but with a large window opening on a garden it feels bigger. Again, it is not uncommon to see several small rooms so designed that they can be merged into one large room—a similar method of achieving a sense of increased space.

In the living room, a variety of activities

The contemporary living room is always as large as the owners can afford to make it. More often than not it includes dining space. In some extreme instances it is even merged with the kitchen, and it is frequently linked by means of a plate-glass wall to a porch, terrace, or garden. This room houses an astonishing variety of activities. It is used for games (from bridge to ping-pong), for study, reading, and lounging, for cocktail parties, family meals, and formal dinners, and even for teen-age dancing. Its furniture includes storage units which contain the needed paraphernalia for changing from one set of activities to another,

lightweight chairs (the dining chairs are also pressed into service for card games and extra seating), and rather bulky upholstered pieces (since modern man prefers sprawling on the end of his spine to sitting up straight).

The kitchen: to contract or expand?

Two important trends may be noted with respect to the size of the kitchen. Contributing toward its reduction is the twofold fact that people eat less than they used to (gout is now as unfashionable as antimacassars) and that more foods are being sold in semiprepared form. Obviously, if dinner comes out of two or three cans, one wax container, and a frozen cube, there is relatively little need for any elaborate or bulky cooking apparatus. Within the last few years the technique of preparing and distributing frozen foods has been developed even to the point where precooked, frozen meals are becoming available. If this is carried to its logical conclusion, it will follow that the housewife will be able to store complete meals in a deep freezer

Excerpts from chapter on today's houses continued

and to serve them with virtually no preparation at all. It would seem reasonable to predict, therefore, that the kitchen will become even smaller as time goes by. On the other hand, several factors point to a tendency in the other direction. One is the development of semiautomatic laundering equipment, which housewives prefer to have located in the kitchen. Another is a feeling that the kitchen is a logical place for the housekeeper's "office." Still another factor is the growing idea that, if many family meals are to be served in the kitchen, the room should be made somewhat more ample and less hospital-like in appearance. In other words, we have here a picture of two concurrent but divergent trends: one to reduce the kitchen to a cubicle; the other, to convert it into a secondary living area not greatly unlike the kitchen of Colonial New England.

Room to make beds

Traditionally the bedroom is a rather large room, an area of 12' x 15' being considered by no means extravagant. One reason for the amount of space devoted to sleeping and dressing can be traced to the number of pieces of furniture normally purchased for these rooms. As much as 800 cu. ft. can be saved in one bedroom through more efficient planning, and when cubic-foot costs run from 80¢ to \$1.25 (as they did in 1947) the argument is more impressive than ever. Nevertheless difficulties have developed because life does not always conform to rational theorizing.

For one thing, the need for privacy has been steadily increasing. With the dining room gone and the living room developed as one large area designed to serve a great variety of family uses, the bedroom has become the last refuge in the house for anyone desiring quiet. Thus, at the same time that attempts are being made to shrink the size of the bedroom, there has also developed the concept of the bed-sitting room—a space with the functions of a well equipped but secondary living room, the purpose of which is to allow parents and children to carry on their own activities without any overlapping or interference.

Even in children's rooms the tendency to reduce space has been countered by a desire to make these rooms sufficiently large for use as playrooms and for homework and hobbies. In addition there is a small but practical point to which the housewife attaches much importance: in any minimum sleeping chamber the bed

inevitably gets placed in a corner or even in an alcove. The difficulties of making a bed so placed are considerable. That objection can only be answered by providing space enough for a freestanding bed with only its head against the wall.

No bed at all?

Even here, however, the architects have not given up the search for a satisfactory solution. One interesting experimental proposal was that the bed should be eliminated. It was argued that, in a cubicle containing only a mattress, the combined use of radiant heating and air conditioning could provide ideal sleeping conditions and that bedclothes could be dispensed with entirely. The average citizen will no doubt be inclined to throw up his hands in horror at such a proposal; nevertheless such a scheme may ultimately develop, for the currently popular electric blanket, eliminating the need for the usual blankets, marks a step in this direction. To meet public prejudice it is being disguised as a conventional wool blanket, with the heating element concealed within it; actually, however, a much lighter and thinner cover—and one which could be cleaned more easily—would function with equal effectiveness. It is possible that the next step will be an electric mattress cover to warm the sleeper from below, supplemented by infrared lamps or radiant-heating coils in the ceiling above. To the extent that these experiments are accepted by the public, bedrooms may approach a minimum size. It seems more likely that supplementary uses for the space will be discovered as rapidly as technical improvements are made and that the space may continue to be relatively large although the equipment for sleeping may become all but invisible.

Irreducible minimum

The modern bathroom is the one room in the house that has been squeezed to an absolutely irreducible minimum, and the reason is that bathrooms are usually designed for the fixtures instead of for the people who use them. Since the room's largest fixture is barely 6' in length, it is a simple matter to reduce the entire space to an area of about 30 sq. ft. What is generally overlooked by clients and architects alike, of course, is that the costly part of the bathroom is not the amount of air enclosed but the fixtures and plumbing.

With an idea of determining how closely the minimum space conformed to actual preferences a survey of the most

casual sort was launched. People were asked, what, if anything, they objected to in their present bathrooms . . . so few complaints were encountered that one might draw the conclusion that here at last the minimum idea had worked out in a completely satisfactory way. At this point, a new series of questions was presented, including, "What kind of bathroom would you like if money were no object?" and "What would you put into the ideal bathroom?" The replies were astonishing in their length and variety.

Concealed desires

Many of those questioned wanted telephones and built-in radios. Some thought that the ideal tub should be located next to a full-size picture window (assuming, of course, a pleasant outlook and complete privacy). Other desires included built-in ashtrays by the tub, reading lights, a place to put a highball glass, a shower as well as a tub, a chaise longue covered with waterproof fabric, sun lamps, larger medicine cabinets and counter space, materials and equipment for exercise, and so on. A few people hesitantly confessed that they would like a tub big enough for two. In other words, it seemed that when free rein was given to the imaginations and normally concealed desires were expressed, the bathroom tended to assume a rather elaborate and unconventional form.

It would have been possible, on the basis of these answers, to design a bathroom that would be the last word in begadged elegance. The survey, however, was not interpreted in this way. What seemed fairly clear was a genuine feeling on the part of people that the bathroom should be used for a far wider range of activities than are normally carried on in it. The requests for a radio, a telephone, and even a picture window, for example, suggested that the pleasant relaxed feeling that comes with taking a bath creates a desire for social and aesthetic communication. Equally clearly, the listing a chaise longue and an oversize tub suggested that, given the space, people might use the bathroom for sexual activity. Other replies showed that care of the body through exercise was logically connected in some people's minds with getting the body clean.

Disapproval of community services

The individual house can solve the living problems of a family only up to a certain point; beyond that it is clear

that the solution has got to be social.

The presentation of trends of this kind (and they have been accelerated by conditions which developed during the Second World War) is often received with violent disapprobation. Outside care of children is considered a symptom of moral disintegration, and the idea of meals delivered from a community kitchen is held to be an attack on the dignity of the housewife. It may be that socialization of certain kinds of work carries with it certain dangers to the structure and moral fiber of both the family and the community; nevertheless the tendency has existed from the beginning of time, and our whole industrial development when viewed from one angle might be described as a continuous series of attempts to reduce the amount of labor required of man. There is no reason to believe that these attempts are going to be discontinued when they affect family life in the individual house.

Unbearable standardization and modern design

The similarities which make the modern house a recognizable entity in any part of the globe are often attacked. We are heading for the most unbearable kind of standardization, it is asserted, and if all houses look alike our communities will become a horror of conformity. Of "unbearable standardization" we already have a great deal. But the New England village, the houses of which are basically alike, has never produced this reaction; nor have the villages in France or England. On the other hand, such communities as Lake Forest and Scarsdale, where every known style of building has been used, for some reason give no impression of a lively variety; nor do they begin to approach the charm of, say, Litchfield, Conn. The difficulty, perhaps, may lie not in the fact of standardization but in the basic integrity of the units employed. As Buckminster Fuller once pointed out, a group of 500 three-year-olds would be a delightful sight, although the children would appear as identical as 500 peas—but the effect of 500 cripples would be quite different. Certainly the universal mutilation of earlier designs which characterizes practically all United States residential building can hardly be described as a practical way of achieving a desirable prototype. And there is reason to believe that the modern house, with its honest attempt to provide a genuinely useful framework for contemporary living, may yet provide it.

Review continued from page 138

Rethinking the fundamentals of architecture in the light of modern thought and architectural experience led Prof. Hamlin to organize his work in two basic parts. In the first the editor himself has written of the Elements of Building and the Principles of Composition. He has thus laid a firm foundation for later special treatments and establish a framework from which he can command the enterprise as a whole. The third and fourth volumes are devoted to building type studies. This arrangement allows the editor to make the best use of his specialists.

Orientation: America

While the perspective is the broad panorama of international architecture (and no advance anywhere in the world has been ignored because of its geographical remoteness), the orientation of nearly every author in these four volumes is distinctively American. The values they have applied are those of American architectural offices and their distinctive types of practice, the builders whose work they shape and guide, and the building industry which they serve.

The most fascinating architectural subject, the houses in which our people live, is dealt with by George Nelson, architect and critic and former editor, in the first of the series of articles on building types.

Both the merits and shortcomings of George Nelson's treatment of individual dwellings are paralleled in the essays on other building types. The psychological insight and its practical application in design add up to a distinctively American approach to architecture. If this approach neglects formal esthetics, humanistic values, and is somewhat lacking in cultural breadth, perhaps its weaknesses are counterbalanced by keen business sense, an appreciation of publicity and merchandising, design ingenuity and begadged practicality. These were also the qualities which distinguished that best of the postwar books on housing, *Tomorrow's House*, written by Nelson in collaboration with Henry N. Wright. They are qualities we find in the best writing in this set of books.

Aftermath of the revolution

There is a strong tendency for authority to describe what it finds in terms of such finality as to preclude future development. Yet ours is the age that now looks back upon the revolution in architecture that was accomplished in the 1920's and is today an accepted fact. It is the day that sees architects agreed on the fundamentals of that revolution, but commencing to divide into separate camps, as different as glass from wall, light from shadow, white from black buildings. It is the day that looks forward to the universal application of electric power, the internal combustion motor, the vacuum tube, nuclear fission, interplanetary communication—and asks itself whether this technology offers any solutions to the architect or merely embarrasses his efforts to understand and solve the human problems they accentuate.

Faster and yet faster must architecture move if it is to keep up with the demands made upon it, and one reflects after looking into the pages of Prof. Hamlin's book that there is little here that will help the men who must make architecture progress. For that information, that inspiration, they must seek elsewhere.

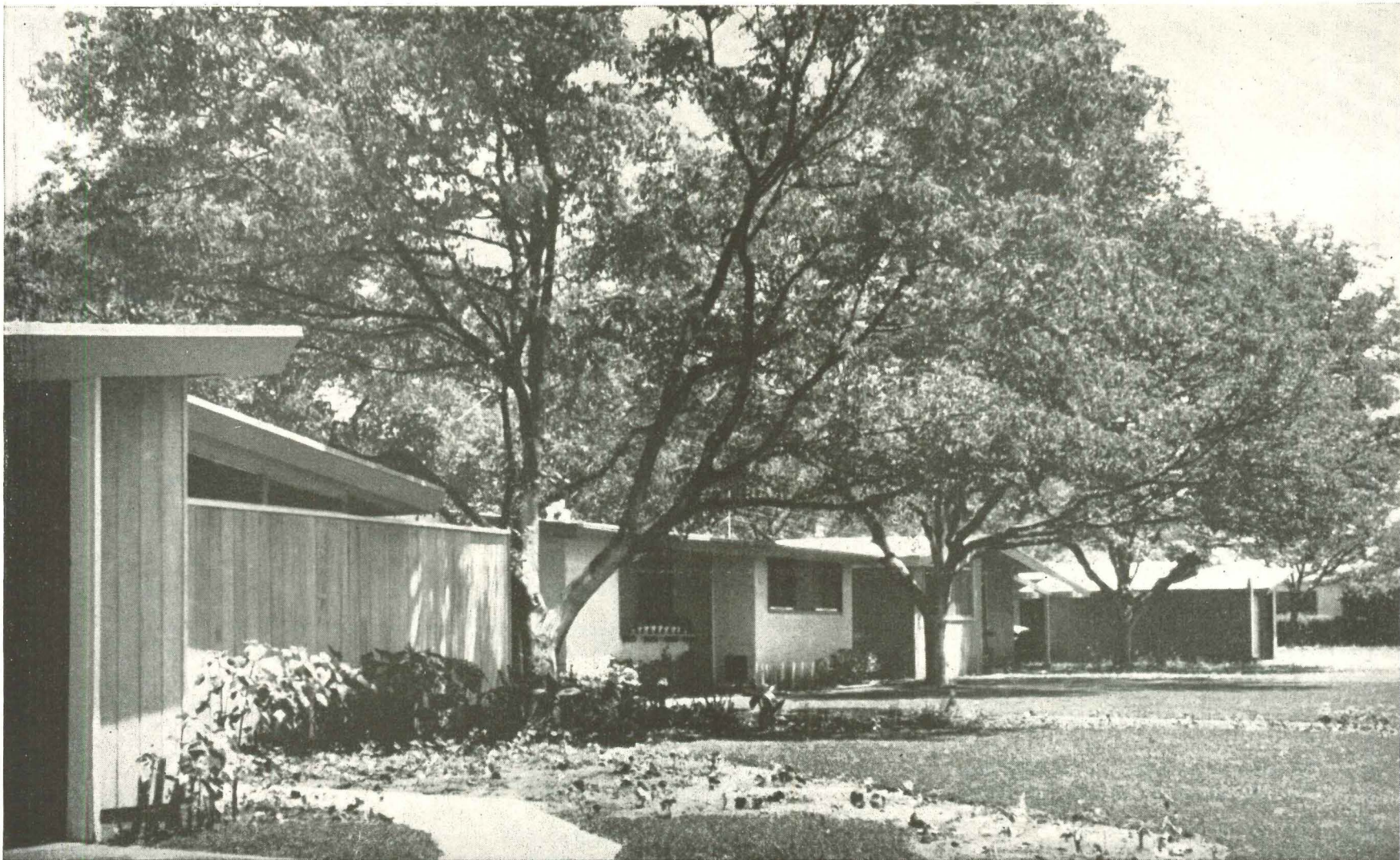

Above: general view of Westmont subdivision. Below: the three floor plan types

LOCATION: Pomona, Calif.
 ARTHUR L. MILLIER, Designer
 GEORGE M. HOLSTEIN & Sons, Builders
 EDWIN A. TOMLIN CO., Developers

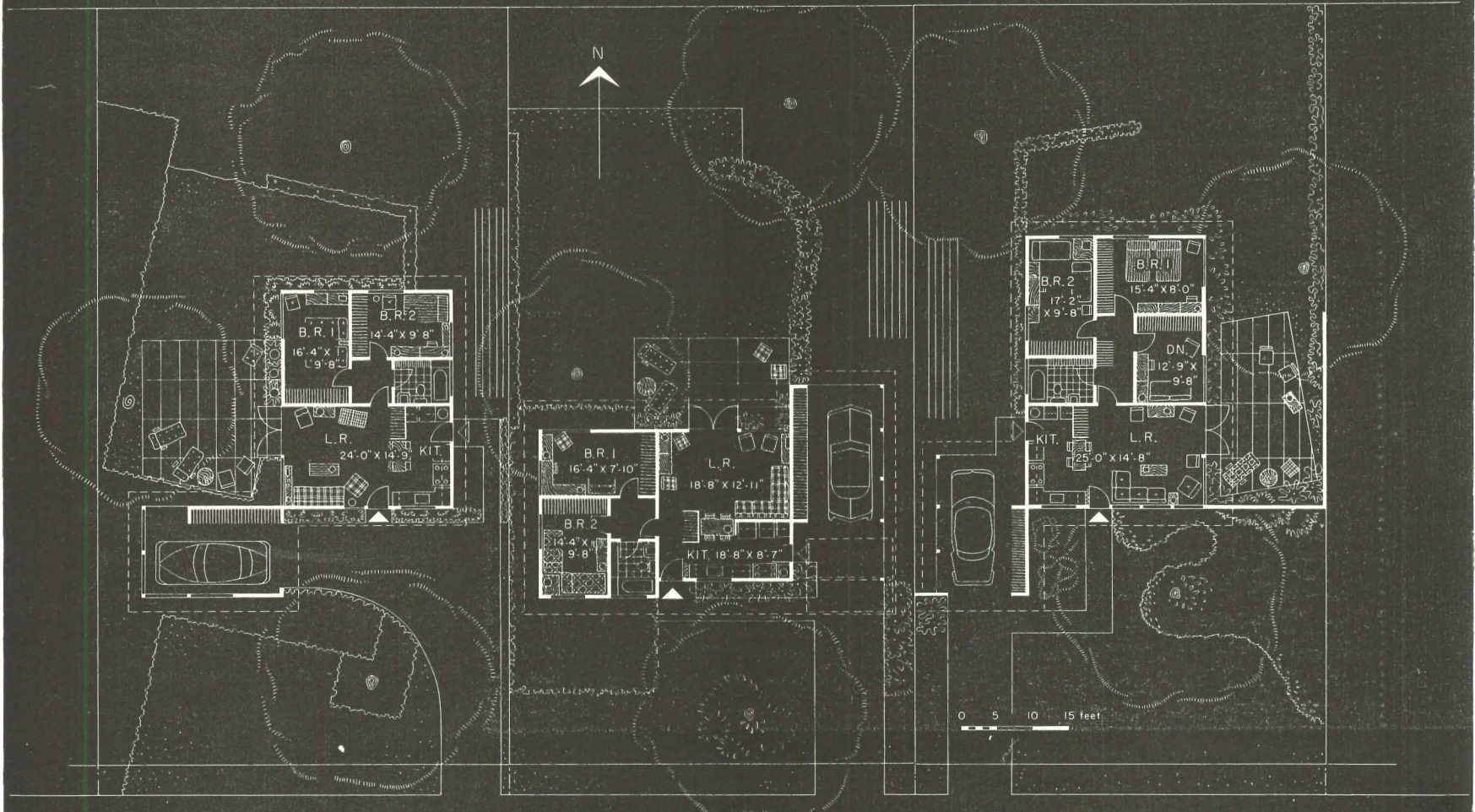

GOOD DESIGN SELLS THE LOW PRICE MARKET

A pioneering builder finds an up-to-date \$8,000 house sells fast, stays sold

Westmont, a 48-home development near Los Angeles, offers fresh evidence that good contemporary design for builders can be both economical and highly salable.

▶ *All 48 were sold in a matter of weeks without sales pressure, so fast the builder never bothered to advertise.*

▶ *Of the 48 buyers, questioned one year after purchase, only two said they would buy another type of house—"Ranch," "Cape Cod," "Colonial"—if they had it to do all over again.*

▶ *The builder is confidently erecting a similar tract of 59 homes 3 mi. away, incorporating a few changes suggested by Westmont owners.*

Until recently the Angeleno of moderate income, like many home-seekers elsewhere, had small choice: the postwar seller's market offered him little more than an assortment of boxy, conventional bungalows lined up window to window in a gridiron tract.

To meet the dwindling market and the growing competition, however, a small handful of builders has started to offer more livable, up-to-date products—and with marked success.

A case in point is that of builder George M. Holstein, who had done a brisk business with some 1,500 conventional homes built and sold in the area. Then sales started to slow up discouragingly in his 700-home project at Pomona, a suburb northeast of Los Angeles. He called in his sales agent, who suggested a "radical change" to attract customers.

For Holstein, Westmont was in the nature of an experiment, and like many experiments ran into difficulties at the outset. Designer Millier's * plans were hashed and rehashed and, after sev-

eral months on the boards, presented to FHA's Los Angeles office. FHA's first reaction: don't bother to submit them; they don't conform to our standards—e.g., the side-sliding aluminum windows are not acceptable. (Levitt had used the same type on FHA jobs in New York.) After three weeks and some minor design alterations a working agreement was reached.

Next the VA appraised the house at \$200 below actual costs and would give no credit for contemporary design. It required several weeks to work out a \$470 increase in valuation, which barely gave the builder a 3.2% return on his investment. (See cost breakdown on next page.)

The model house was completed in the record time of three weeks, and initial sales were gratifyingly faster than in any of the conventional tracts in the vicinity. Three house types were offered: two bedrooms with 750 sq. ft. at \$7,300; two bedrooms with 812 sq. ft. at \$7,800, and three bedrooms with 960 sq. ft. at \$8,500. The price, Holstein readily admits, was a large factor. Seventy-five per cent of the mortgages were VA-guaranteed, the balance backed by FHA.

Recently, to investigate public reaction with an eye to future operations, the Westmont company sent out a questionnaire to each of its residents, just one year after occupancy. The 100% response was enlightening: (next page.)

* Millier's total fee for Westmont's 48 houses was \$1,920, plus an additional \$110 for minor design changes—a fee of \$43 per house. Millier, who figures his remuneration at only \$1.65 per hour after expenses and draftsmen's salaries, believes that \$50-\$75 would be a fairer price per house for complete service for tracts this size.

Photos: Robert C. Cleveland Co.

The three basic plan types have more ASSETS

Sheltered patio off living room

Open plan: kitchen and living room borrow space and light from each other when folding partition is pulled back

Good general circulation

More storage than most basementless houses:

10½' and 9½' wardrobes (deaden sound between rooms)

A 13' storage wall in carport. Bathroom storage cabinets

Gable windows in living room and bedrooms, high enough for privacy and unrestricted furniture placement

Kitchen convenient to front of house and carport

Economy in plumbing: bath and kitchen adjacent, grouped toward street utilities

. . . than DRAWBACKS

Entry direct into living room without baffle or entrance hall (plans 1 and 3)

Cramped dining space

Wall heater insufficient, though well located for best heat distribution.



Living room side of three-bedroom plan opens on terrace sheltered from street by high solid fence. Through careful site planning, large walnut trees of former orchard were preserved as scenic asset. Lots average 55' x 110'.

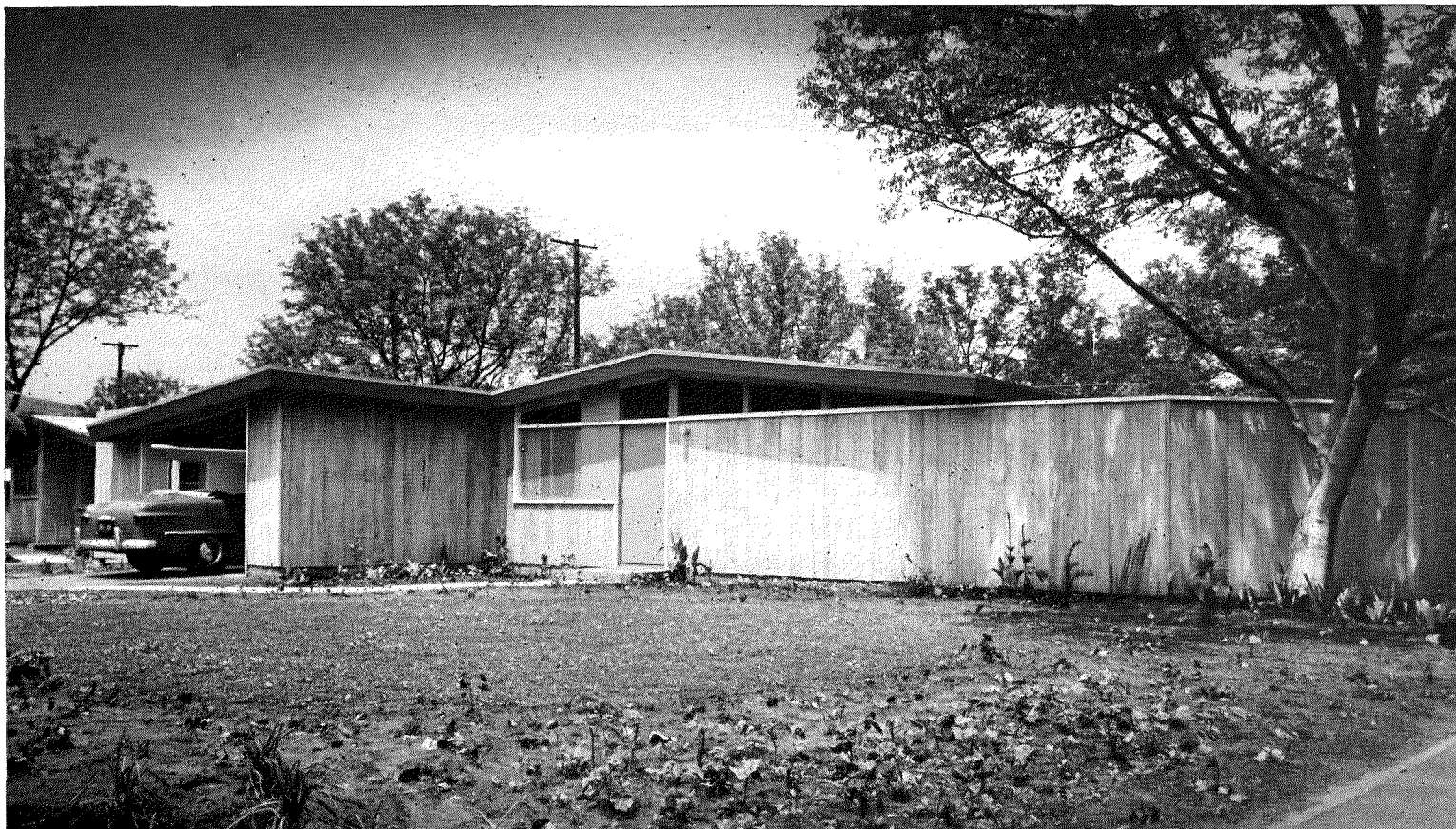

Street side: carport and storage wall, high gable windows for living room privacy. Solid siding extends to form terrace fence, right.

- All 48 preferred their open beam ceilings to a plastered ceiling.
- All 48 were satisfied with the sliding windows.
- Four owners were dissatisfied with the slab floor; the rest commented that it was easier to maintain, freed them from termite worries.
- To the question "Which of the following would you want in a new home if you were to buy again?":

- 48 checked garbage disposal unit (included in present house)
- 43 checked kitchen eating space
- 40 checked fireplace
- 5 checked dining room

One owner wrote in on his questionnaire: "You are to be congratulated on making contemporary styling available in homes under \$15,000. We searched years to find this." The builder reports owners putting up fences, laying patios, planting and improving their properties to a greater extent than in conventionally built projects nearby.

There were unfavorable reactions too: in many cases the buyers thought the 40,000 Btu wall heaters inadequate for the climate and for the large glass areas of the house. Some objected that the kitchen, when not closed off by its folding partition, looked like an appliance store display from the living room. Most felt that dining space was not ideal, and 40 of the 48 would have preferred fully enclosed garages to the carports.

In their next tract, Holstein and Tomlin are altering plans for 59 houses in the \$9,000-\$10,500 bracket to incorporate some of the owner-suggestions, notably better eating space and more satisfactory heating. Says Holstein, "Our next step *before* building any more contemporary homes will be a series of conferences with FHA and VA." Since completion, FHA has commended Westmont

as "good, forward-looking architecture," adding that future evaluation for houses of this type would be "as good as the best conventional design."

Construction

Foundations: 20" footings; 3½" floor slab poured over one layer 15 lb. felt sprayed with asphalt emulsion; slab laid on 4" gravel, earth puddled and tamped underneath.

Walls: standard 2 x 4 stud construction with let-in diagonal braces, plastered inside and out (except for redwood siding on street side). Redwood posts, 4 x 6, used for carport and living room glass wall.

Roof: 4 x 10 and 4 x 12 purlins and rafters 8' o.c.; 2 x 6 T&G roof sheathing topped with three layers of 15 lb. felt, white aggregate to reflect sun. *Roof pitch:* a low 1½ in 12.

COST BREAKDOWN

Designer's fee	45	Wire	186
Permits and meters	38	Driveway	62
Concrete and walks	536	Glass	237
Cabinets and millwork	706	Folding partition	72
Cleanup and grading	40	Garbage disposal unit	87
Plastering	534	Financing, interest, escrow	
Flooring	151	sales expense, FHA fees,	
Hardware	62	VA fees, etc.....	331
Heating	105	Cost of lot	1,352
Lumber and carpentry	1,782	Sales commission	150
Paint	370		
Plumbing	495		7,708
Roof	139	Sales price	\$7,965
Misc. and overhead	168		
Tile	60	Builder's profit	257



Dining area, near front door (right), straddles kitchen and living room, which can be separated by closing folding partition at right.



View from living room shows openness of plan, with kitchen and dining a part of the main room. Roof is lifted visually by open ceiling, high windows, open space above partition.

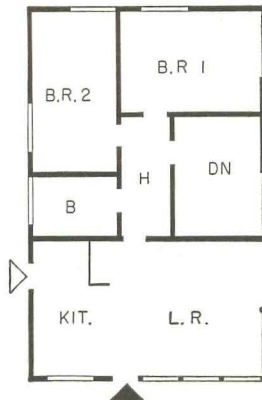
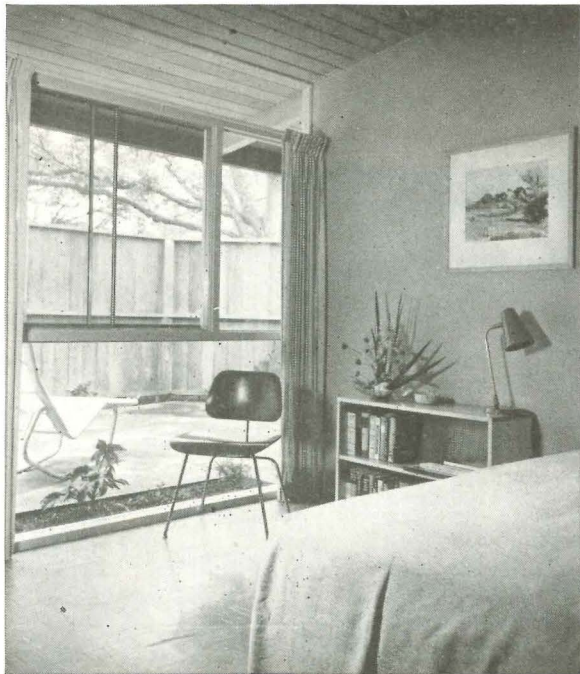

Den-bedroom has floor-to-ceiling glass on enclosed patio. Note side-sliding aluminum windows above fixed glass, exposed T&G ceiling extending out into 4' sunshade overhang.

An architect designs

1. FOR BUILDERS, A MODULAR TRACT HOUSE—with flat roof,

single walls, and a traffic conscious floor plan

Both the builders' house on this page and the custom design on page 149 were done by San Francisco architect Roger Lee. The contrast between them serves to illustrate an almost self-evident thesis: that a trained professional can adapt his talent both to the challenge of the merchant builder's low cost assembly line and to a unique client problem.

When West Coast architectural shop talk turns to "coming" young designers, Roger Lee's name is sure to come up. William Wilson Wurster, among others, thinks Lee is one of the two or three best young talents in California. One of his latest efforts is a flat roofed builders' house, built for the California International Home Show, under the sponsorship of the East Bay Homebuilders Association, few of whose members have heretofore been conspicuous for their interest in architects or in contemporary design.

Lee's foremost task was to insure that the house, not the surroundings, would get the most attention. His design, with its suggestions for improving the plan and appearance of the merchant builder's flat roofed house, was aimed directly at tract operation. He had to avoid the thinking that too often turns Home Show houses into mere showcases for the furniture of co-sponsoring department stores. Also, he was told to use every possible alternate noncritical material. Lee met all the conditions with a job that set many of the Home Show viewers to asking: "Why don't builders give us more houses like this?"

The question could well have been pointed at builders who doubt that an architect's services can mean more salable houses. Here are some suggestions for improving the plan and appearance of the builder's flat roof house, as developed by Lee:

1. **Take advantage of the perimeter flexibility** made practical by a flat roof in order to achieve a wasp-waisted plan. Then put the entry hall right in the center.
2. **Make the overhang wide enough (4')** so that the flat roof plane will be strong and no one will miss the pitched roof.
3. **Plan the house on a module** that will permit full utilization of the strength of the materials.
4. **Supply a partly covered play area** where children may be supervised through a wide kitchen window.
5. **Open the kitchen** to the adjoining living room so the meal-getter can enjoy family and guests while heating their soup.

Photos: (below) Herrington-Olson; (others) Larry Kenny

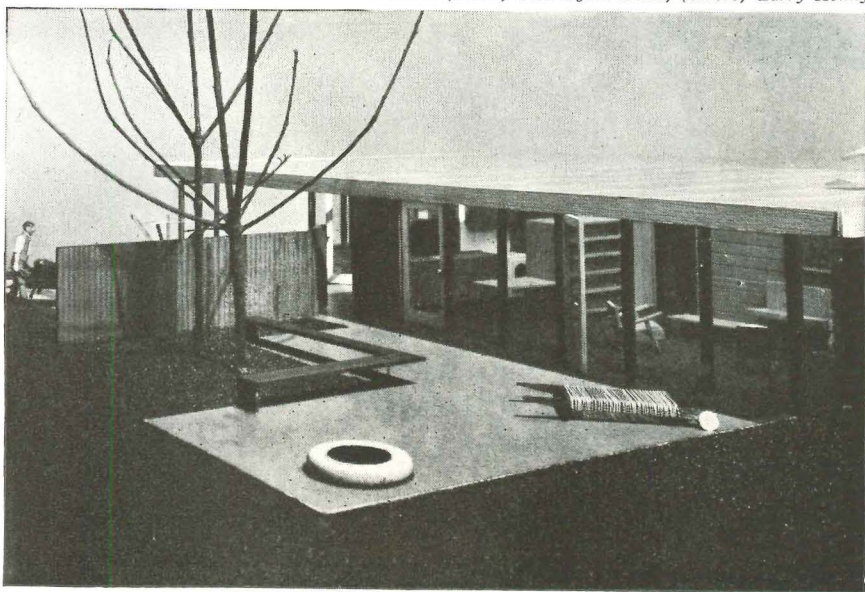

Model shows how 4' overhang protects glassed living area from sun's rays. Close quarters at exposition made over-all exterior photograph of completed house impossible.

LOCATION: Oakland, Calif.
ROGER LEE, AIA, Architect
FRED F. CHOPIN, Builder
OSMUNDSON & STALEY, Landscape Architect

Lee's plan emphasizes storage space, adding 48 sq. ft. by walling in carport posts with cement board panels. Every room may be reached from entry hall without passing through any other room.

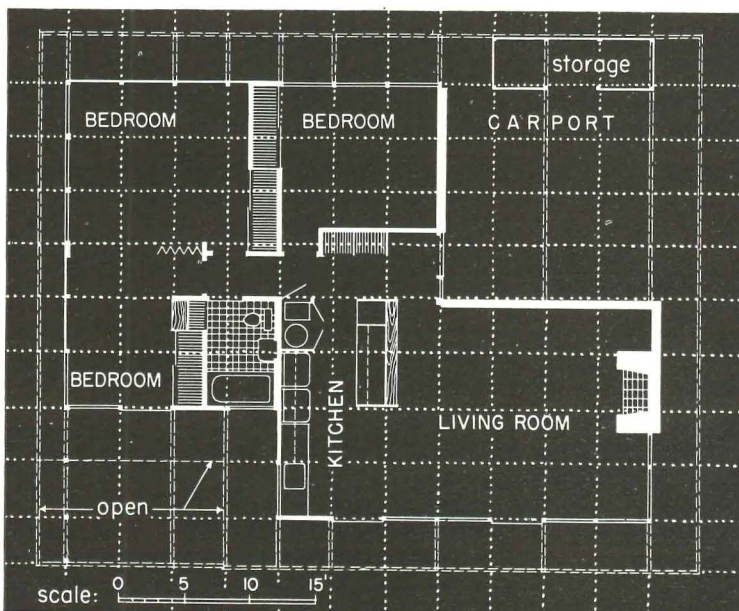



Finished ceiling is underside of 2" x 6" tongue-and-groove roof planking. Brick fireplace was thought to give better color and pattern than concrete blocks originally planned.



Open kitchen puts best face forward with Philippine mahogany cabinet fronts. Wide window overlooks play area. One "wet wall" holds plumbing lines for both the kitchen and the adjacent bathroom (see plan, left).

Storage wall planned between rear bedrooms gave way to folding door to accommodate heavy Home Show traffic. Child's bedroom, below, opens directly on outdoor play area. Inside of cement board is painted.

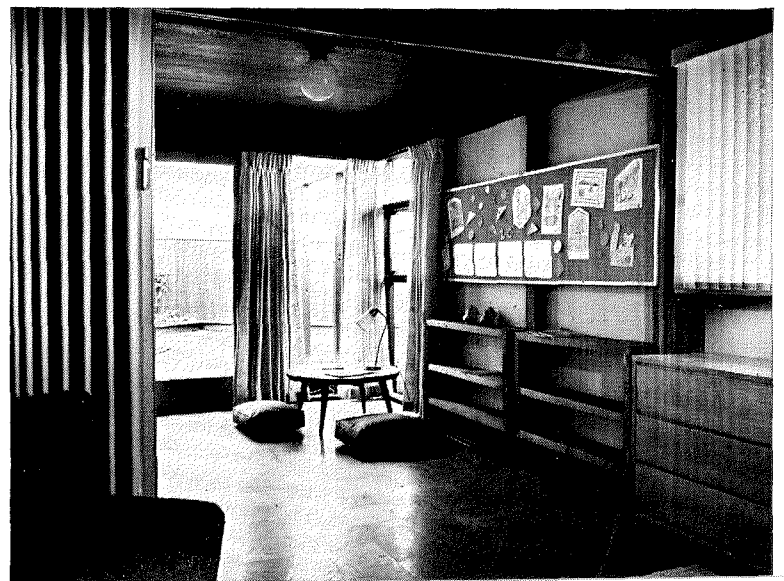

MODULAR TRACT HOUSE

Built-in traffic cop

Lee's hallway acts like a cloverleaf intersection on a busy highway, routing traffic to any room in the house without making the rooms into pass-throughs. Key to Lee's skillful use of the entrance hallway lies in the fact that it is located almost exactly in the geographical center of the house. This is one of the rewards of the flat roofed design which facilitates the use of an irregularly shaped plan. With a conventional pitched roof, departures from the parallelogram entail extra expense, and sometimes complications, in the roof structure. The flat roof leaves the planner with a fluid space which he can arrange as best fits his purpose.

Further ease of indoor-outdoor movement is gained through doors opening onto the patio from living room, kitchen and child's bedroom/playroom. A blackboard wall serves as a divider between the play area and adults' patio.

The strong horizontal

Too often antipathy to the flat roof is based on the fact that the overhang is not wide enough. Without an overhang, or with one that is too narrow, a house can look as if it had no roof. Lee's 4' overhang gives his relatively small house a strong horizontal plane so that the roof seems to be more than just the top of a box. The living area expands under this plane; it doesn't huddle.

Lee uses his 4' module well, obtaining rooms of pleasant proportions (with the exception of the third bedroom, only 8' wide), and avoiding odd dimensions (10', 14', etc.) that would involve

cutting and make only partial use of the beams. His 16' x 20' living room is far pleasanter than the 12' x 20' room too often found in builder houses. One-piece cement asbestos panels fit cleanly between the posts.

The brick wall, located on two sides of the carport and extending into the house to form the fireplace wall, furnishes lateral stability and serves as a firebreak between garage and living area. It also supplies color and texture contrast to the wood paneling, curtains and glassed areas.

Can builders use it?

What this house would cost in tract operation would be interesting to know. Because it was an exhibit, with much material and equipment furnished by suppliers, precise cost data was unobtainable. But when Roger Lee asked for construction bids he got one of \$12,500. By removing such luxurious touches as Philippine mahogany, cork floors and built-ins, Lee estimated that the cost of the 1,050 sq. ft. house could be cut to \$11,000. Volume construction would undoubtedly lower this much further.

Like many another designer of a model house, Lee's job was complicated by the fact that he was expected to incorporate the products of many exhibitors into his house. As he himself said: "Along toward the end, things sort of got out of hand." But if his problems in diplomacy did get overwhelming, his sure sense of design didn't suffer. The homebuilders who found that the public likes this house can now decide whether or not they want to go ahead and build others like it.

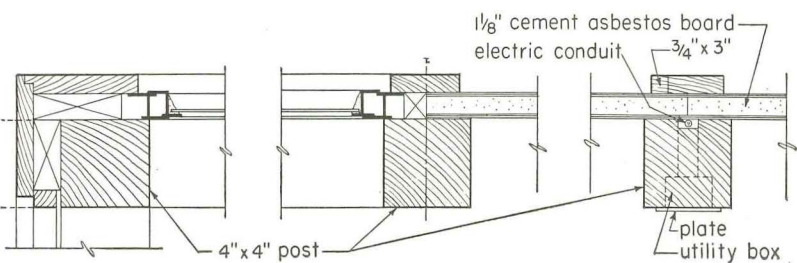
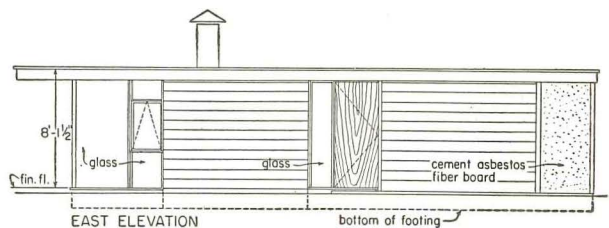
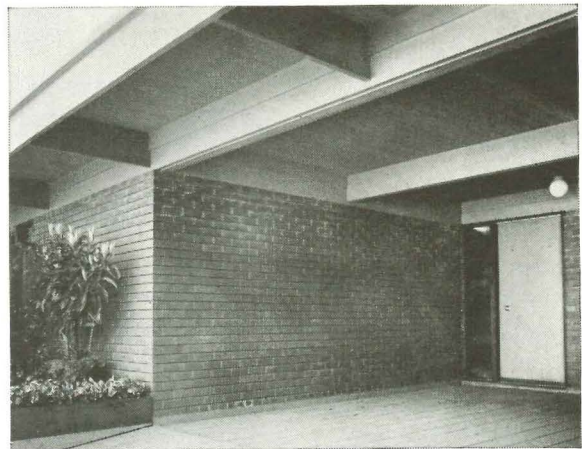
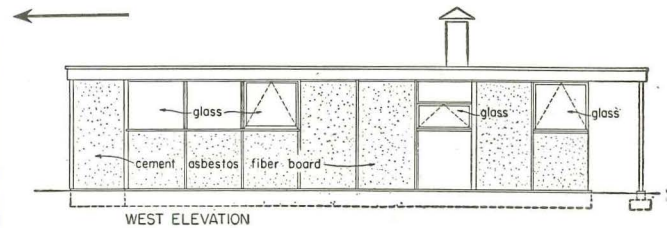

Carport view shows deep recessing of entrance, which assisted floor planning. At show's end, house was removed intact, trucked to a prepared site, and sold.



Photos: Roger Sturtevant

An architect designs

2. FOR CLIENTS, A ROUGH-HEWN RETREAT—as personal as his builder's house is popular

This Roger Lee house illustrates to an extreme the other, and far more familiar, side of the architect's coin—the personalized custom architecture commonly identified with his profession.

In contrast to the builder's house shown on preceding pages, this Berkeley home is very much of a to-order job. It is a house with a lot more hair on its chest, rough, extroverted, slightly self-conscious, but expressive of the owners' personalities. Here stone is unmistakably stone, wood asserts its essential character and nature come indoors with a flourish—a plant box straddling the glass wall, tree trunks and trailing vines adorning the interior. If the mood borders on the Wagnerian, the owners like it that way.

The big (672 sq. ft.) living room shown here is an addition to the original house, built years ago as quarters for a group of laborers who worked on the rock quarry a hundred feet away. When the present owners bought house and quarry site, they decided to remodel and build out toward the view of San Francisco Bay, keeping the new room closely related in feeling to the existing house. This was accomplished with heavy wood beams and 12" fir planks and battens reminiscent of early California mining construction, abetted by rough stones from the quarry. Arizona flagstone flooring, with radiant heating coils beneath, was laid by the owners, who also completed bit by bit the wall masonry, electrical and insulation work, wallboards and painting. With this owner-labor, an estimated contract price of \$7,500 was reduced to \$3,500, for the basic structure.

LOCATION: Berkeley, Calif.
ROGER LEE, Architect
WILLIS FOSTER, Contractor

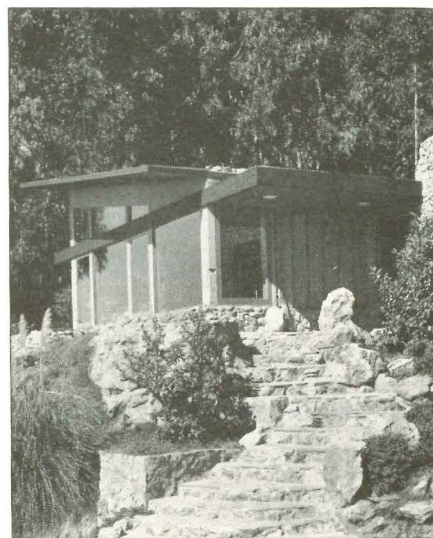
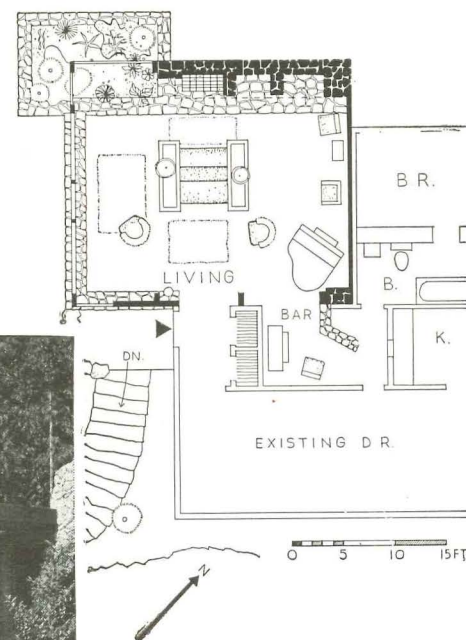

BOOKKEEPING HELP FOR THE BUILDER

by R. L. Brummet and D. A. Thomas

School of Business Administration, University of Michigan

A new, simplified financial system

that will interest builders

and help architects

understand their clients' problems

For the first time a simplified bookkeeping system has been designed for the small builder. It is called *Record Keeping for the Small Home Builder* and it was prepared by the authors of this article with funds from HHFA.

The 86-page booklet may be secured for \$1.25 from the Supt. of Documents, Government Printing Office, Washington 25, D. C.

In simple language the manual shows a builder how to record his financial affairs. Newly designed forms eliminate most of the mystery of ordinary accounting systems. Architects, too, will be interested in the new system for it is refreshingly simple compared with the ordinary maze of accounting procedures. The book's practical approach grew from many sessions the authors had with builders—ED.

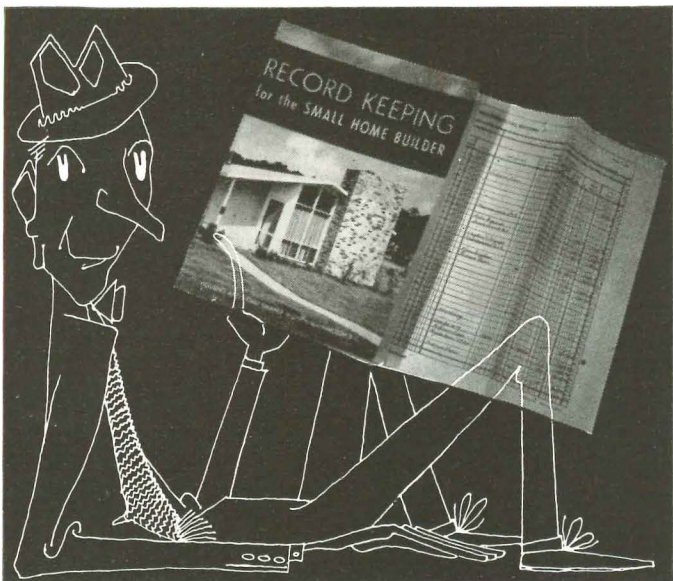

Probably no other manual

a small builder could buy would be of more help to him . . .

Record Keeping for the Small Home Builder, though prepared to give the small-volume builder a simple but integrated system of record keeping, provides the same basic information as any detailed accounting system. The problems of estimating costs of purchasing, tax reporting, and minimizing costs are common to all builders. The record-keeping system should be flexible enough to aid in the solution of all of these problems. Although one builder may subcontract all of his work while another may hire his own carpentry or masonry labor, or both, each should seek the same basic information from his records.

A record-keeping system should be composed of a basic framework with flexible estimating and costing procedures so that the builder can choose the parts which best fit his operation. The basic system comprises procedures for (1) estimating costs, (2) classifying and recording financial transactions, (3) analyzing costs, and (4) reporting. For builders who desire to keep a minimum of records only the essential parts need be used. For others who feel they need more detail, further procedures should be provided which can become an integral part of the system.

Estimating

Accurate cost estimates are required for:

1. Setting of selling prices
2. Determining cash requirements
3. Planning financial operations
4. Submitting minimum bids
5. Setting yard sticks for measuring operating efficiency

First form to compile for the estimate is the **summary cost estimate**.

It has spaces for 24 operating classifications:

1. Permits, plans, specifications, etc.
2. Excavation, backfill, and finish grading masonry
3. Masonry
4. Concrete and cement finishing
5. Structural steel
6. Carpentry labor
7. Lumber, millwork and other carpentry materials
8. Plumbing
9. Electrical
10. Heating and air conditioning
11. Sheet metal
12. Roofing
13. Insulating
14. Lathing and plastering
15. Painting and paper hanging
16. Floor covering
17. Floor finishing
18. Glass and glazing
19. Tile and mosaic
20. Blinds, appliances and furniture
21. Screens, storm doors and storm windows
22. Landscaping
23. Extras
24. Miscellaneous

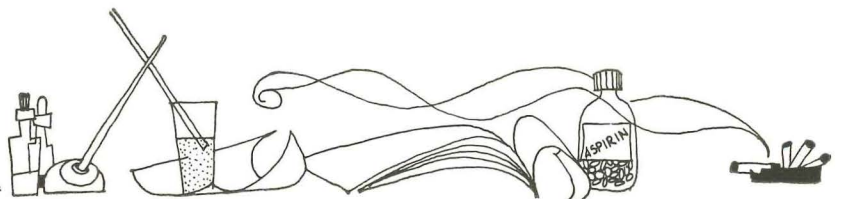

On the summary cost estimate, estimated costs of material and labor for self-performed operations and amounts of bids for subcontracted operations may be entered in separate columns. As soon as the estimated costs for the 24 direct cost classifications have been determined they can be entered in spaces provided on the job cost records. This facilitates a comparison of actual costs with the estimated costs.

The second form which it is advisable to use in estimating is the **component-type estimate** form, intended for a detailed listing of estimated costs of **self-performed** operations. Components are suggested on this form into which costs for a given classification may be broken down. Carpentry labor classification, for example, may be divided into the following components:

- a. Building layout
- b. Forms and screeds
- c. Wood floors and framing
- d. Exterior walls
- e. Roof framing and sheathing
- f. Exterior trim
- g. Interior rough carpentry
- h. Windows and exterior doors
- i. Dry wall construction
- j. Interior trim
- k. Roofing

The total of the estimated costs for the components should be transferred to the appropriate classification on the summary cost estimate.

A list of possible items of cost on the back of each estimating form will help prevent costly omissions.

In the estimating section, procedures are outlined for use in determining the estimated indirect building costs and the selling and administrative costs to be included on each summary cost estimate.

Classifying and recording

A form designated as a **columnar financial record** is recommended for recording financial transactions by builders not familiar with traditional bookkeeping procedures. The results of any business transaction may be recorded here in such a way that all information needed for financial statements may be taken. Such financial transactions as the payment of cash and other property for materials, supplies and labor, and the receipt of cash for draws and settlements, are recorded in appropriate classifications on this record.

Twelve vertical columns accommodate the classifications which are arranged horizontally across the top of the form. By employing the words "increase," "decrease" and "balance" the use of accounting terminology is avoided and a common-sense interpretation of the financial meaning of the transactions is developed. In using the columnar financial record it is necessary only to supplement it with job cost records to make up the formal set of records. the days when a builder

Analyzing costs

To provide a means of cost control, provision made on job cost records allows for the comparison of accumulated *actual* costs with *estimated* total costs within each of the cost classifications during construction. The estimate serves as goal or yardstick for measuring the effectiveness of material usage and the efficiency of labor. The comparison of estimated and actual costs necessitates the use of identical cost classifications for estimating and cost keeping. Both forms, therefore, are best arranged with exactly the same 24 cost classifications. Under each heading on the job cost record, estimated costs for each classification may be entered. As actual material and labor costs are incurred and entered in the columnar financial record, they can be entered in the correct classification column of the job cost record. Thus actual costs of individual jobs accumulate below the total cost estimate for each classification.

Since it is natural for the small-volume builder to think of his total operation in terms of individual houses, columns on the job cost record provide for the entry of receipts and draws, in addition to those used for accumulating costs. In this way costs incurred may be compared with receipts and draws for each house. The last column on the job cost record is headed "balance" and amounts entered here represent the excess of costs incurred over receipts and draws for each job. Where the costs recorded have all been paid for in cash (if no amounts are owed to suppliers on a particular job), the balance indicates the amount of the builder's funds tied up in each house. In cases where the advances received exceed the costs incurred, the amount in the balance column is shown in red or in parentheses. After a job is closed and after all receipts and draws and the final settlement are entered, the amount in the balance column represents the gross margin on that job.

Payroll methods provide for the simple determination of amounts due to employees at the end of each pay period, the allocation of direct labor costs to the jobs, the accumulation of information to be used in the preparation of reports to federal and state taxing authorities, and the calculation of payroll taxes, income tax withholding,

(Continued on page 90)

could keep records
in his head
or on the backs of envelopes are gone.

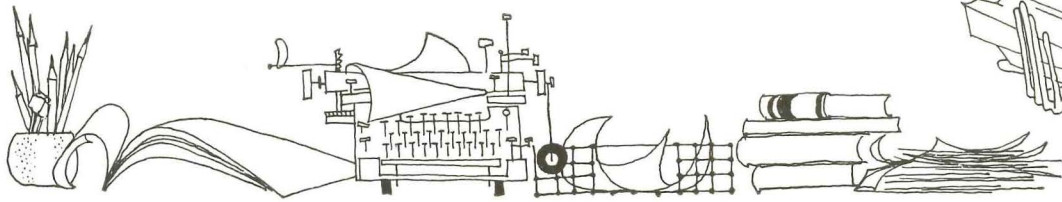

LOCATION: Los Angeles, Calif.
 WILLIAM S. BECKETT, Architect
 WALLACE F. McDONALD, Contractor
 VAN HERRICK'S, Landscaping

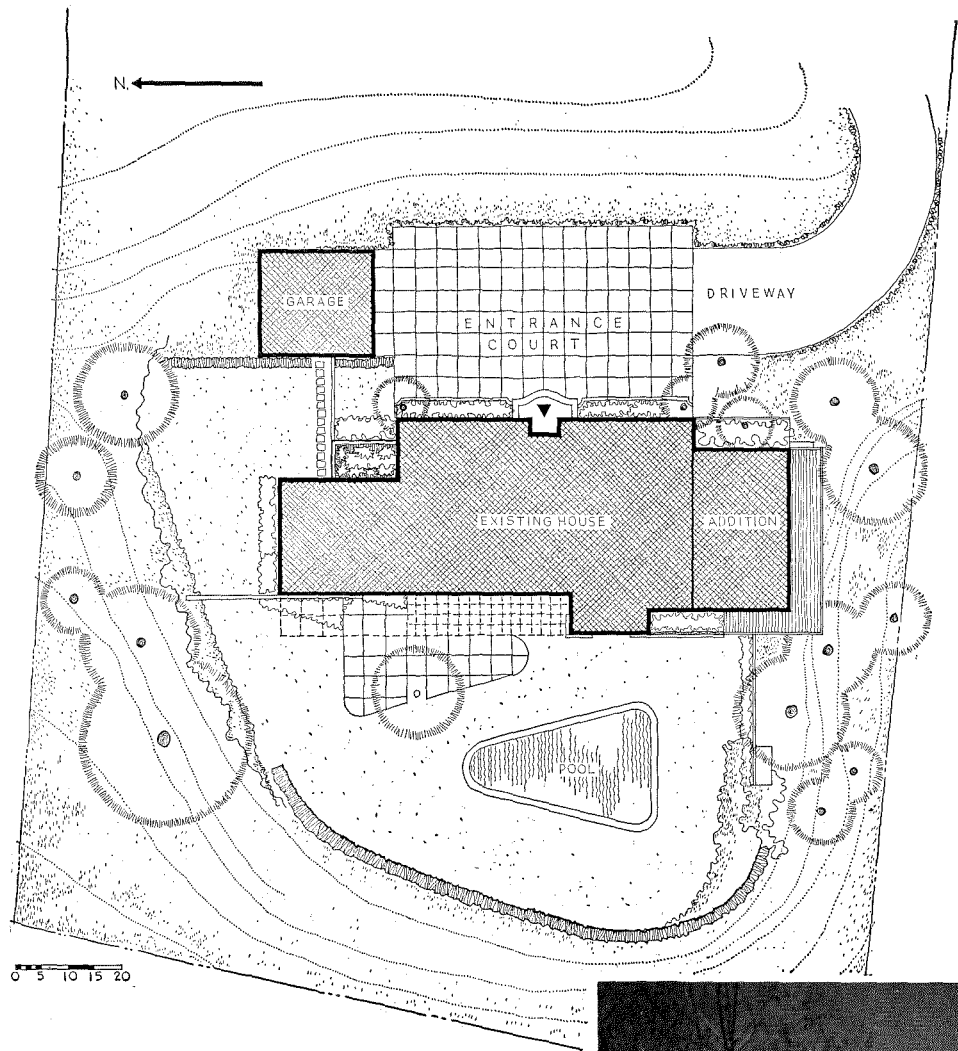

REGENCY REMODELED

A modern architect treats the past

and the present with respect

When California architect William S. Beckett needed a house for himself and his family, he could not wait to design and build one, could not bring himself to buy a modern house designed by somebody else. So he decided to buy and remodel. What he found was this well built, well proportioned French Regency house near Los Angeles. His first thought had been to settle for one of the ubiquitous Spanish leftovers which deck the California hills. But the Spanish accent proved just too thick. Analysis of a number of examples revealed such drawbacks as heavy, dangerous plaster and lavender-tiled bathrooms—both abhorrent to the Becketts. The best way out seemed to be to find a good basic house and make it better.

Basis for remodeling

What the Becketts particularly liked about this house, its dignified front facade, they decided not to alter. Nor did Mr. Beckett feel driven to demolish partitions in order to have continuous space in the modern idiom within the original frame. He kept the small rooms intact as he likes their proportions and the 10'-6" ceilings ("We're tall people").

The photograph of the entrance facade is in effect both a *before* and *after* shot . . . it has remained virtually unchanged (a new bedroom added a wing to the left). But in the rear, which is also the view side, Beckett replaced a far from happy arrangement of windows and a door, with

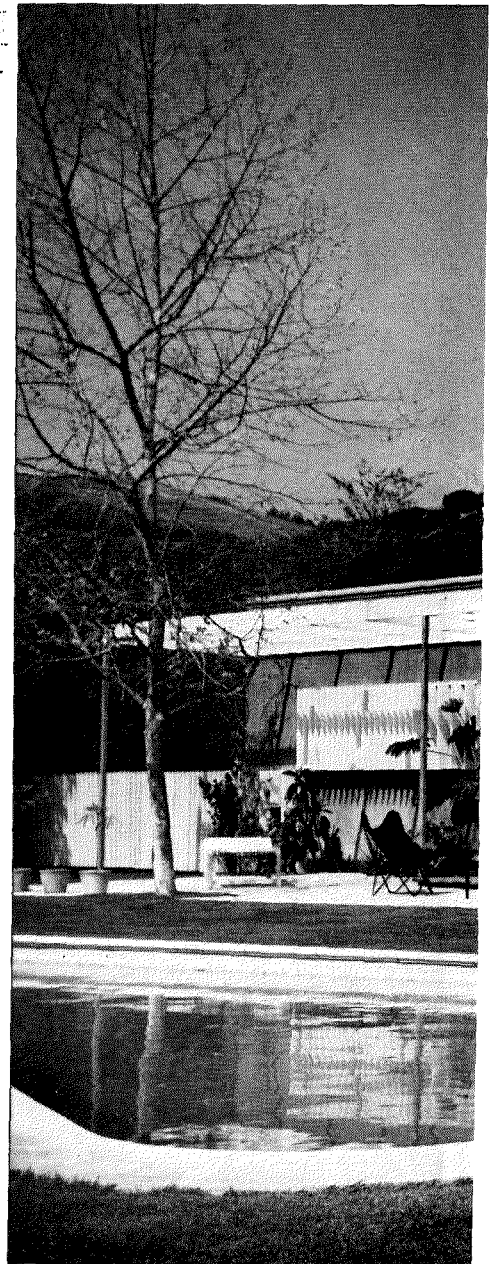



*Balanced front facade architect Beckett left unchanged.
Planting masks the new bedroom wing at the left side.*

Photos: Julius Shulman.

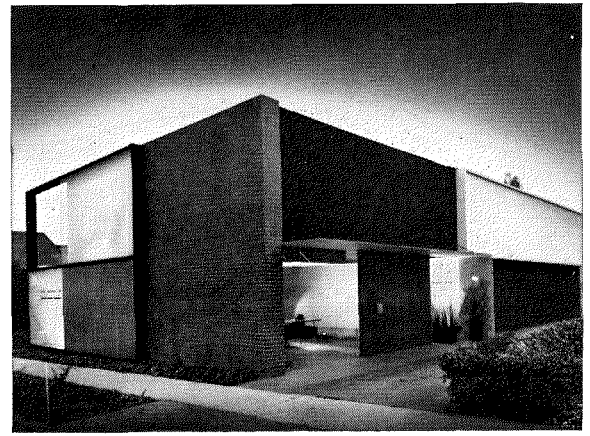

Beckett's office, a remodeled Boys' Club (June issue '51), shows his taste for modern design, high ceilings, balance.

Greatest change in Regency house, below, was opening up the rear facade with glass areas and woven plastic.

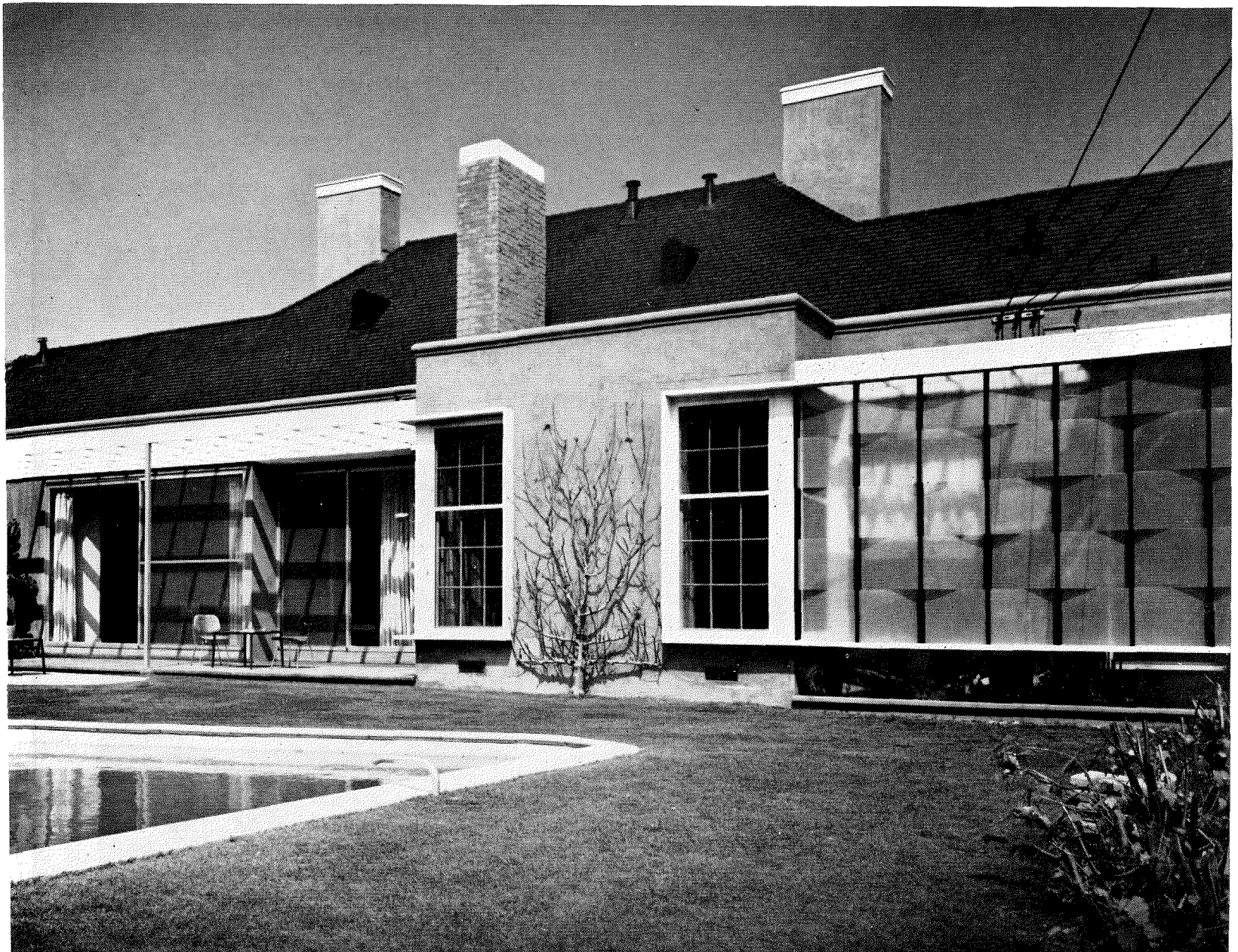

REGENCY REMODELED

woven plastic strips and an egg-crate overhang shading a terrace which overlooks lawn and pool. The plan is about as it was except for the addition of one bedroom and a lavish, Roman style bath which the Regent himself would have liked. The faults of the plan (complicated circulation patterns) the Becketts accept because of its virtues (a series of completely private bed-and-bath apartments). They like, too, the "constantly pleasing opportunity to go either one of two ways."

Architect Beckett decided that the molded doors, trim and moldings could remain. Room by room these are the changes he made:

The living room got a sheet of plate glass to demarcate the entrance to a lath house, and night lighting was installed in the lath house.

The dining room was relieved of its bay window, sliding glass panels substituted. This opened an easy path to outdoor dining.

The library lost a small window and door, a colonial fireplace, gained a wall of bookshelves, storage space, a Roman travertine chimney breast, paneling and built-in desk (Beckett uses built-in furniture frequently).

The master bedroom is an entirely new wing comprising 600 sq. ft., dressing space and a 5' square bathing pool, screened from outdoors by wide translucent strips. These are 3' wide wire screens covered with plastic.

Outside the Becketts, as noted, took pains "to handle the sun problem" and developed strong lines where the house didn't tie together well in the rear. The planting was restudied, simplified, to take best advantage of the country nature of the site.

Lath house, seen through arched doorway in the living room, below, lengthens room, is protected by a sheet of glass.



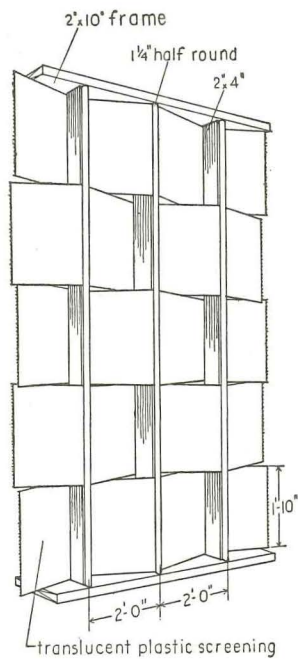
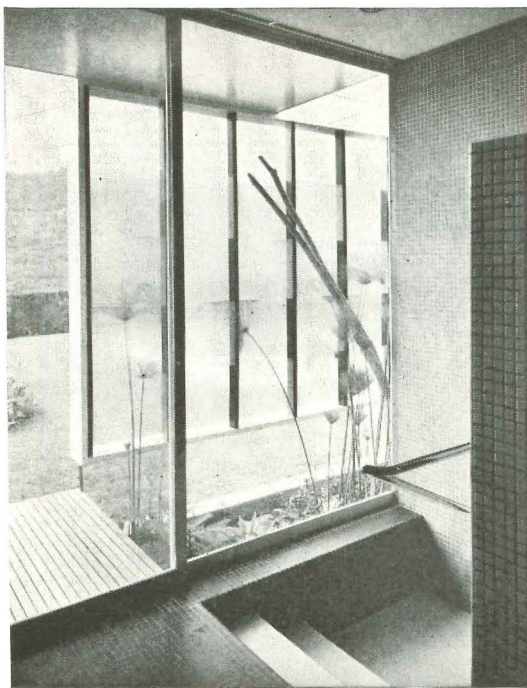

Plastic strips woven between wood members screen 5' square bath and built-in plant box.



Built-in desk is set into new library bookshelf wall. Paneling, and marble mantel breast at extreme right, are also new.

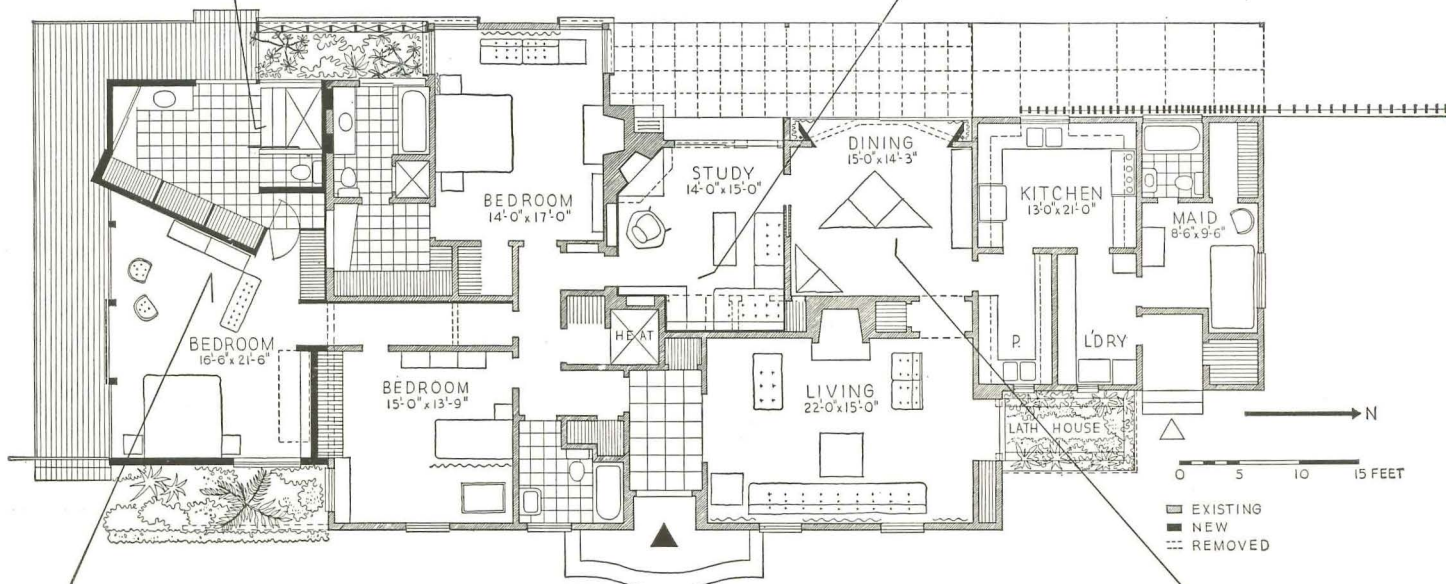

Master bedroom wing, below, was added to house. Double desk is built in.



Sliding glass doors, in the dining room, replace a bay window, give easy access to the terrace for outdoor meals. Beckett designed dining and service tables.



Photos: Jack Holmes

THE SOUTH—new building frontier

A New York firm goes South to play a leading part in the U. S.'s smoothest-running critical defense area

LOCATION: Aiken, S. C.
 WILLIAM G. LYLES, BISSETT,
 CARLISLE & WOLFF, Architects,
 R. EMORY HOLROYD JR., Associate
 GROSS-MORTON CO., Builders



Important part of vice president Ed Dennis' (2nd from l.) job is passing on of building "know-how" to third Gross-Morton generation. In an impromptu outdoor meeting are (l. to r.) Richard Morton, 26, Dennis, James, 28, and Allen, 24, Morton, and Robert Gross, 25. Still to join firm are Jerry Gross, 22, in Air Force and Peter Gross, 14.

Just north of Aiken, S. C. on U. S. Route 1 is a homebuilding operation that rivals the most efficient on Long Island. The newest project of New York's Gross-Morton Co., composed of 550 houses being built for rent or sale to employees of AEC's Savannah River H-bomb plant, represents the firm's first step in establishing a Southern beachhead.

This is no hit-and-run carpetbagging operation, no try at a quick "killing." To win the South, Gross-Morton have become as Southern as pecan pie. Vice president and general manager Edward J. Dennis now owns an Aiken home and has become a South Carolinian in everything except his New York accent. So has the entire new generation of Grosses and Mortons, the four boys whom Dennis is teaching the building business. It was the AEC, with its critical housing area classification, that brought the company South, but Ed Dennis emphasizes:

"If they move the whole AEC plant to Montana or Maine, we're still staying. We think the Southeast has a growth possibility unequalled anywhere. Anyone who thinks that all the frontiers are gone ought to come down here and look about him."

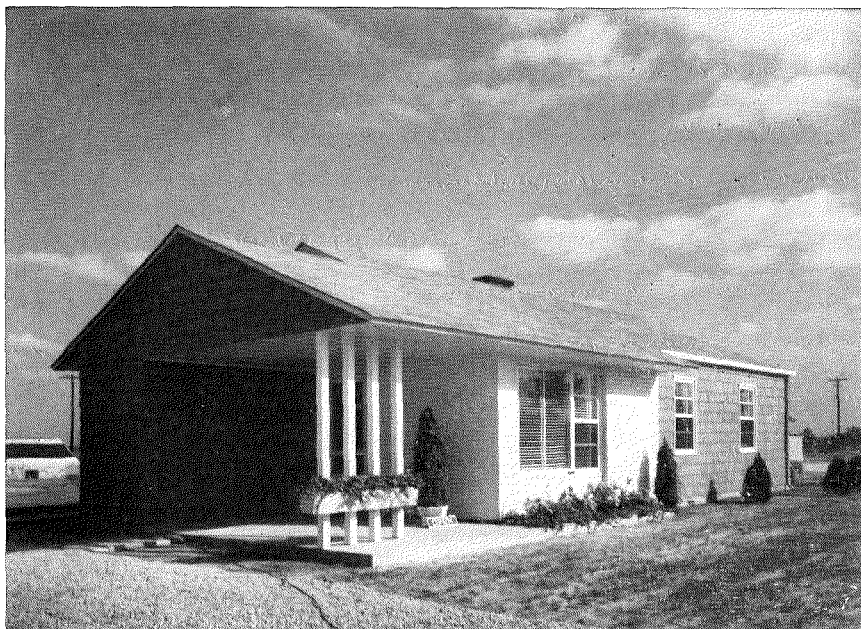

Floor plans show distressing traffic bottleneck, which will be eliminated in next models. Inclusion of appliances, Venetian blinds, etc. in finished house is innovation in Southeast and made immediate hit with young couples in AEC personnel.

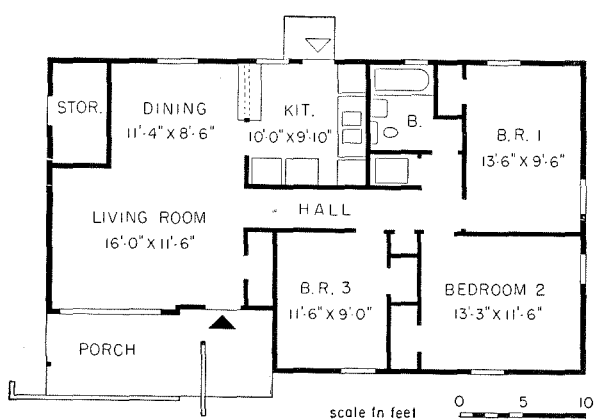
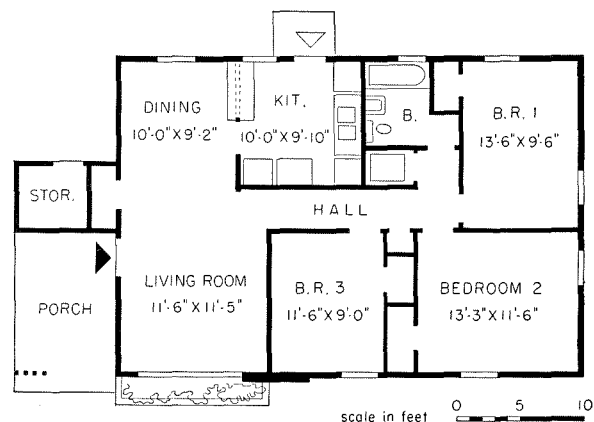

All plots will be seeded, and a small number of shrubs furnished, but care will be up to tenants. Gross-Morton think better-than-average occupants will reduce maintenance to minimum in 337 homes to be rented. There are no garages or carports.



The enthusiasm that Aiken feels for his houses, though, is based on more than Ed Dennis' genial personality:

1. A three-bedroom, 1,100 sq. ft. brick and shingle house that rents for \$75 a mo. and sells for \$9,990, including a kitchenful of appliances
2. Good land planning that combines small town spaciousness (three houses to an acre) with all city conveniences
3. One hundred per cent use of subcontractors, thus employing and making friends of local labor
4. An assembly line building system that has kept houses ready for incoming AEC personnel and has taken some of the housing heat off that harried group

Pioneer in a strange land

Reason why Gross-Morton succeeded in an area notoriously unfriendly to outside builders setting up shop was stated succinctly by an AEC official: "He (Dennis) had the guts to stand up and slug it out." Before the company got their HHFA and FHA commitments, they had contracted for half a million dollars' worth

of land, building materials and architectural plans. And it was big enough so the partners could do some desk pounding at FHA in Washington, where they could get fast results in the form of increased valuations for their houses (H&H, Mar. '52, News).

One of Dennis' first moves was to set up a local office, deposit money in an Aiken bank and make himself a legal resident. He bought land and got the city council to endorse the project. These were little things, but things no other builder thought of doing. They qualified him as a local builder, in accordance with FHA demands. The 198 acres of Crosland Park (named for the former farmer-owner) were just outside the Aiken city limits, but the city voted to extend these limits to include the tract and make water available. Laid out in curvilinear streets by Atlanta land planner Eugene R. Martini, the project gains an undulating perspective from the rolling character of the land. Trees are sadly lacking in Section One (formerly cultivated land), but are being preserved in the second area (sale houses).

The assembly line system is impressive to behold. Trenchers dig out foundations, forms are placed, then a mobile concrete mixer drives up between two house sites, pours foundations and

NEW BUILDING FRONTIER

floor slabs and moves into position between the next two. Water and waste lines, embedded in the floor slab, are entirely pre-assembled. A closet flange spacer, resembling an empty coffee can, automatically cuts out a circle for the toilet bowl, saving 1½ hours of concrete chiseling.

Exact amounts and sizes of framing lumber, plywood sheathing, roof trusses and shingles are delivered to each site on a tight schedule that keeps crews busy.

In a former peanut factory a few hundred yards down the road, Gross-Morton attempt to prefabricate every possible item. Stacked up in the yard outside are piles of aluminum windows, wooden eaves troughs and soffit plywood, awaiting prime coats of paint. In the main body of the building are appliances, nails and other valuable materials that, as Dennis says, "might get liberated." At the rear are plumbing, heating and electrical "factories" where assemblies are made, then trucked to the sites as needed. An inventory control permits a rapid check on the state of any job.

Across the road from the factory and adjoining the project is the carpenter operation. In an open field, roof trusses and window frames are put together in jigs. Lumber is pre-cut to size at the mill, eliminating all waste.

Render unto the sales force . . .

Dennis recently transferred control over all finishing details (paint, appliances, cupboards, fixtures, etc.) from the construction department to the sales department. He felt that these were the things that sell a house and that the sales force was the best judge of what they should be.

R. Emory Holroyd Jr., associate in the architectural firm of William G. Lyles, Bissett, Carlisle & Wolff, has given the houses at Crosland Park three floor plans and 11 different elevations. Wall areas of painted brick area contrast with shingle walls and help prevent a stereotyped look. Hip roofs and gables are interspersed.

Rentals are handled through the AEC office. Gross-Morton notify this office when houses are ready, and so have none of the headaches of determining who is eligible. Certificates of eligibility permit holders to rent any house available, but the majority prefer a Gross-Morton house. Rents were deliberately set \$10 under the HHFA permitted figure for a three-bedroom house, on the theory that "we're willing to take the minimum return on our rental, expecting that the original tenants will want to buy."

When the sale of houses was announced, 4-5,000 people poured through the models each week end. Requests to build the house came from three states. Orders for 450 houses were taken in three

weeks, more than double the number of houses in the first tract. Purchasers must have certificates of eligibility to buy programmed houses. So far, the Aiken office has issued 460 certificates of the 630 allotted. A new list of eligibles is being prepared to include those engaged in "defense supporting activities."

Room for the youngsters

A corollary task is the teaching of the building business to the third generation of the firm, founded in 1896. Four boys, grandsons of the founder, have their own spheres of authority and responsibility under the over-all generalship of Dennis.

With their fathers still very active in the apartment and commercial interests of the firm in New York, a new challenge had to be found for the boys. In effect, they're betting their future on the ability of a forward-thinking, aggressive building firm to make a success of building houses for the new South. They're sure the chance is there because:

- ▶ Capital is pouring back into the South
- ▶ Power projects under way will add millions of kilowatts for incoming industries
- ▶ Land is plentiful and cheap and water is abundant
- ▶ Nonunion labor is very productive.

Aiken is conspicuous in the defense housing program

Though April figures show that nationally only one out of seven units programmed in critical areas is under construction, over 3,000 of the 3,320 rental units programmed in the Savannah River area are being built. A large share of the credit for this is given by builders and AEC to McClellan Ratchford, HHFA director for Aiken, who had the job of paring promises of 29,141 units down to the 3,320 allotted. His success at weeding the good from the bad is measured by the fact that "very few units will be built by other than the original sponsors."

Gross-Morton have just announced the purchase of 190 acres adjoining Crosland Park for their 1952-53 program. Architects are busy on drawings, which will include a plan much more open than that of the present models and "maybe heat pumps, maybe air conditioning; we're looking around." This is all that will probably be built in the immediate area, for Dennis feels that the South will not go for the supercommunities of the North. He envisions tracts of 350-500 houses—tracts large enough to support small shopping centers but not so large as to overwhelm the towns to which they are attached. One thing he's sure of:

"The boys will still be building houses here 30 years from now."

Venetian blind in pass-through can screen off kitchen. All cabinets are factory built.



Demand for houses was so strong that one couple moved in before water line was in. Rich's of Atlanta did interior of model.

All houses have three bedrooms; Dennis thinks two-bedroom house is out of date.

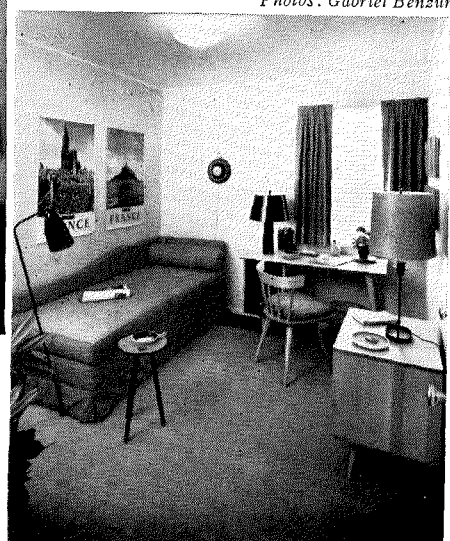

Photos: Gabriel Benzur



Simple water and waste lines are assembled in factory, hooked up on site. Closet flange spacer (foreground) saves 1½ hrs. of chipping concrete.



Photos: Jack Holmes

Mobile mixer pours two complete floor slabs, then moves on. In filled areas, foundations go down to original grade, sometimes as deep as 6'.

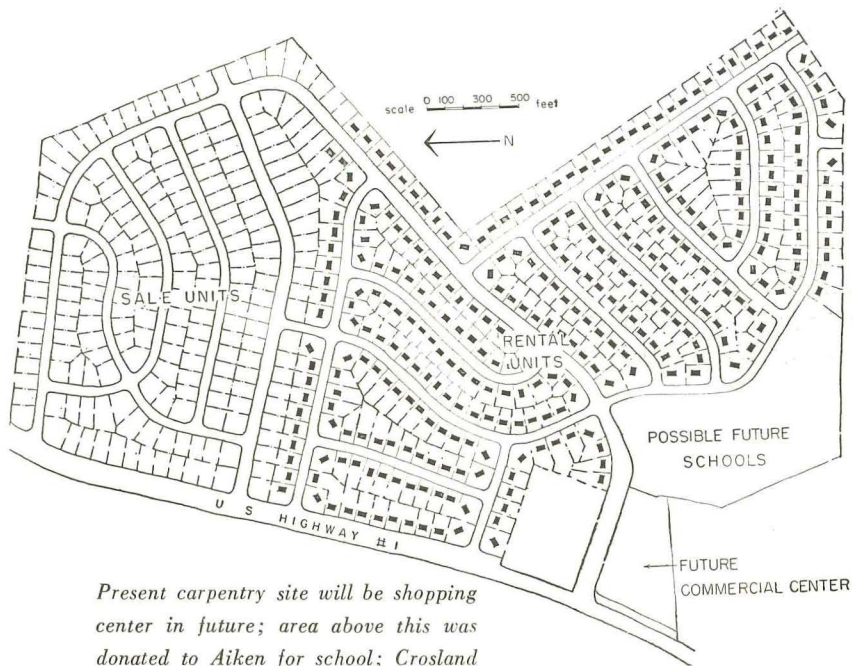

Present carpentry site will be shopping center in future; area above this was donated to Aiken for school; Crosland Park retained 5 acres.

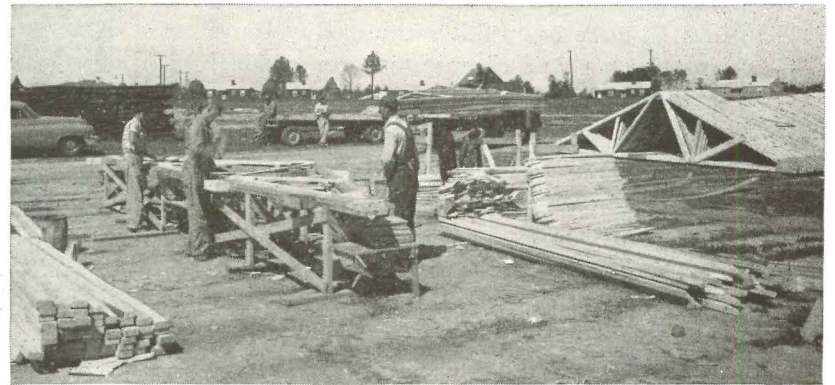

Gussets and 2 x 4s for roof trusses are all pre-cut at mill. Simplification and repetition of building processes are the basis of mass production.

Percentage cost breakdown

Architecture and survey	1.21	Grading and fill	2.25
Concrete	9.33	Landscaping	0.96
Lumber, rough and finish	11.90	Septic tank	1.86
Metal windows	3.37	Metal bucks	0.77
Carpentry	7.91	Attic and kitchen fan	1.02
Brickwork	1.03	Chimney	0.64
Shingles	1.28	Appliances	5.05
Plumbing and heating	11.33	Labor	0.89
Electric wiring	2.55	Watchman	0.31
Hardware	0.94	Supervision	0.64
Dry wall	5.15	Insurance	0.08
Roofing	2.05	Payroll taxes	0.07
Insulation	0.33	Sundry materials	0.32
Flooring	1.93	Miscellaneous	1.93
Water	0.71	Land	2.51
Tile	1.24	Land improvements	5.92
Painting and decorating	4.64	Selling expense	2.63
Calking and weather stripping	0.25	General expense	2.57
Kitchen cabinets	1.92		
Blinds	0.51	TOTAL:	100%



Prefabricated aluminum chimneys are light, easily installed. Favorable weather conditions make outdoor storage feasible, save warehousing expense for stockpiled items.

Brick for the price of frame

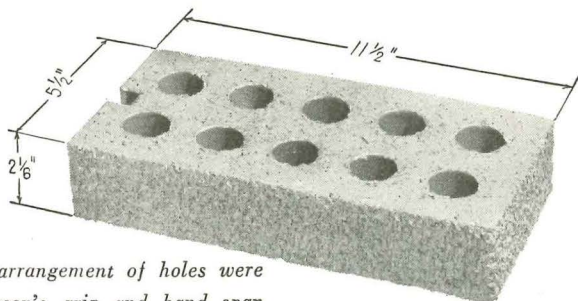

Core size (1 3/8") and arrangement of holes were planned to duplicate mason's grip and hand span (a bowling ball manufacturer assisted!). Mortar squeezed into coring gives exceptionally strong "key" and resists "floating." "SCR" brick weighs 8 lbs. It is now available in all major markets.

A new through-the-wall brick unit, one of the first fruits of the Structural Clay Products Institute's \$1 1/4 million research program, looks like a blue ribbon specimen. The first pilot models indicate that a solid brick-walled house can be made competitive with quality frame construction, and cheaper than conventional backed-up brick or brick veneer.

To get honest, on-the-job cost comparisons, the American Community Builders of Park Forest, Ill. built a five-room pilot house using the "SCR" brick. Where backed-up brick walls were costing \$1.05 a sq. ft., the new units were only 81.1¢ a sq. ft. Translated into a complete house, this means a saving of almost \$240. As Joseph Goldman, American Community Builders vice president, said: "A better brick for less money is quite a find."

Time and motion studies show that masons can build 60-100% more wall area per day with the "SCR." An average of 450 units daily will give 100 sq. ft. of wall per day per mason. And though many products come to grief on the shoals of labor unacceptance, the "SCR" has the endorsement of the bricklayer's international union.

Conventional looking in the wall (same face size as the popular Norman brick), the "SCR" conforms to all major building codes, which permit 6" masonry walls for single family one-story residences (9' walls, 15' at gables). A patented clip permits easy attachment of 2" x 2" furring strips, which serve as a base for any desired interior finish. The 2" cavity thus provided prevents moisture penetration and permits easy insulation and wiring.

A shot in the arm for the brick industry is long overdue. Since 1910, brickmakers have watched capacity drop from 12 billion units to a low of 8 1/2 billion today. Latest HHFA figures showed that brick goes into only 18% of the nation's new houses, but SCPI feels confident that the savings made by their new brick will give them a share in the other 82%.

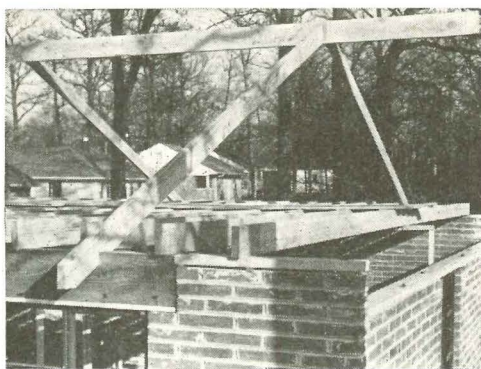

Head plates are anchored to brick wall by embedded bolts. Furring strips are nailed to head plate, eliminating one furring clip. Flashing and weep holes are necessary with brick gables.

Three-inch width of furring clips makes exact alignment unnecessary. Anchoring 2 x 2's at top, middle and bottom is adequate. Clip design keeps 1/4" space between brick and wood, foils condensation.

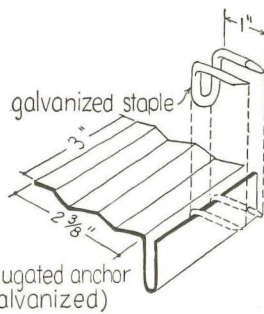

Any moisture which penetrates the masonry will run down the inner face and drain through continuous flashing and weep holes. "SCR" brick and furring need only 8" foundation.

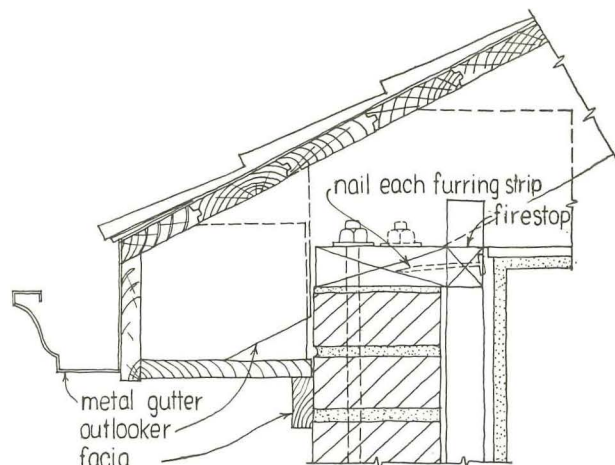

3/8" dia. anchor bolts - 4'-0" o.c.

