

May 1953

house + home

id sell your next house

At a House & Home Round Table, top builders and top builders' architects agree on ways to give America a better house (p. 120)

t house for tomorrow?

Solutions of the problems of better living space (p. 132), the open-plan kitchen (p. 136), comfortable bedrooms (p. 142), efficient baths (p. 140), and dual-purpose garages (p. 170)

Use land well

Wise orientation (p. 128), indoor-outdoor planning and fences (p. 172) add living value to the lot and the community

Fastest selling houses

Six more in House & Home's cross-country roundup of houses that are chalking up record sales (p. 160)

Display houses

A good decorating job can boost sales — a bad one can kill them (p. 144)

The graphic is a green rectangular area containing a grid of text. It is organized into four main columns. The first and third columns each contain two identical lists of factors, separated by a plus sign (+). The second column contains a list of factors, followed by a plus sign (+), a list of factors, a plus sign (+), a large dollar sign (\$), a plus sign (+), a list of factors, and a plus sign (+). The fourth column contains two identical lists of factors, separated by a plus sign (+). The lists of factors include: CONSTRUCTION MATERIALS, NEIGHBORHOOD DESIGN, PLAN, ORIENTATION, FINANCING, MERCHANDISING (in yellow), COLOR, LANDSCAPING, COMFORT, EQUIPMENT, PRICE, APPEARANCE, and SIZE. At the bottom of the graphic, there are two yellow circular icons, each containing a stylized 'S' shape.

NEW

BUILDERS ASKED FOR IT!
ARCHITECTS DESIGNED IT!

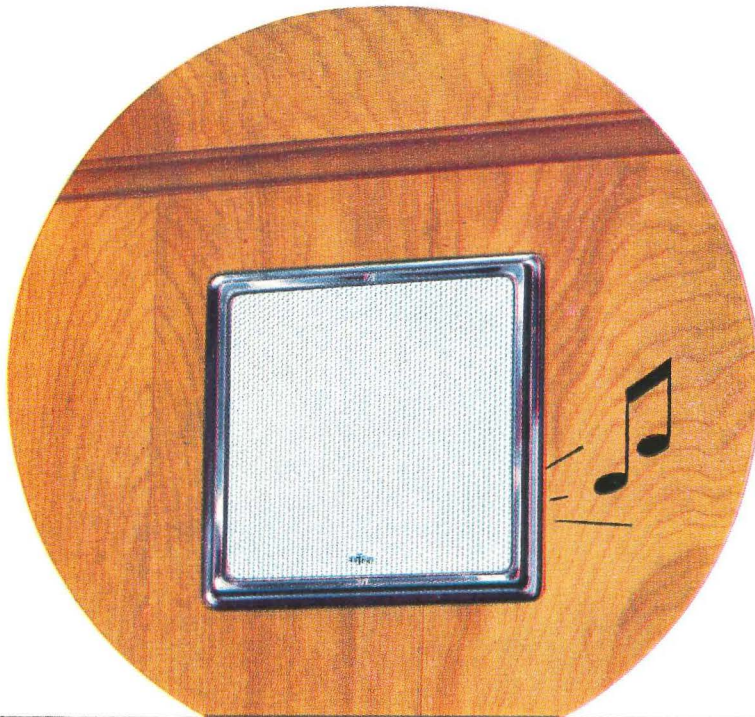

NuTone RECESSED Chimes

MODERN DESIGN . . . FLUSH WITH WALL

Here's modern simplicity in a NEW 2-door chime . . . a functional design to blend with any room — any decoration.

NuTone's Model K-15 Recessed Door Chime can be installed flush with wall and ceiling . . . or surface mounted. Only 7 $\frac{1}{4}$ " square, 2" deep. Smart chrome bezel and white grille . . . Chime can be painted to blend with wall or ceiling colors.

Gives a loud, clear signal . . . Can be used as a single chime for average homes . . . or as an extra chime with other NuTone models for 2-floor plans or larger Ranch-type homes. Two musical notes for front door, one for rear.



EXCLUSIVE FEATURES NOT FOUND IN ANY OTHER CHIMES

NEW completely enclosed power unit . . . Protects mechanism from dirt or grease.

NEW double resonator . . . chime tone bar is resonated from BOTH ends . . . Clearer, Louder, Longer Tone.

NEW bezel and grille . . . Contemporary design . . . blends with any interior — in keeping with modern appearance of recessed fixtures.

NEW luxury chime to fit any budget — price is \$9.95 List.

FREE . . . Completely illustrated literature, specifications, and installation data is yours without obligation. Write NUTONE, INC., Dept. HH-5, Cincinnati 27, Ohio.

Design and Mechanical Patents are Pending.

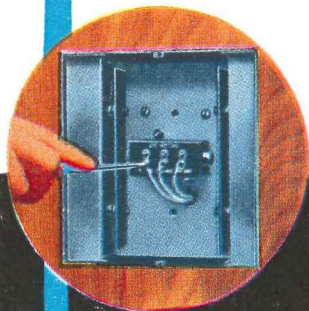

NUTONE

Every Modern Home Needs The 3 NuTone Products



VENTILATING FANS • DOOR CHIMES • ELECTRIC CEILING HEATERS



BEHIND BEDROOM



IN LIVING ROOM C

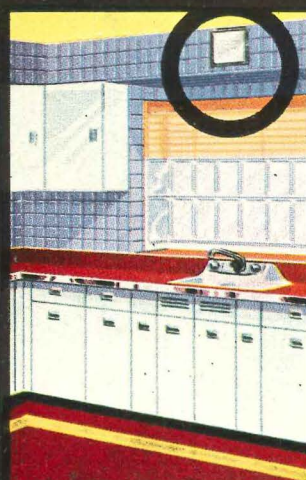

ON KITCHEN WALL



ABOVE HALL BASE

house+home

May, 1953

Published by TIME Incorporated

EDITOR-IN-CHIEF Henry R. Luce
PRESIDENT Roy E. Larsen
EDITORIAL DIRECTOR John Shaw Billings

HOUSE & HOME

EDITOR AND PUBLISHER

P. I. Prentice

EDITORIAL CHAIRMAN

Douglas Haskell, AIA

EXECUTIVE EDITORS

Joseph C. Hazen Jr.
Suzanne Cleaves

ART DIRECTOR

Paul Grotz

ASSISTANTS: Edward Birkner, W. C. Bixby, Peter Blake, Eckenfeld, James P. Gallagher, Marilyn Jane Jacobs, Mary Jane Lightbown, Walter Carl Norcross, Vernon Read, Richard (Washington), Ogden Tanner, Arthur McK. (Thompson), Arthur Watkins.

ASSISTANTS: Rosalind Klein Berlin, Gwen Hodges, Martin, Alice O'Connor, Adam Ooms (S), Dorothy Stone O'Shea, Olive F. Taylor.

ASSISTANTS: Associate Directors, ARCHITECTURAL FORUM: Einstein, Ray Komai; HOUSE & HOME: Mad-ber, Nina Rittenberg. Assistants: Lily H. artha Blake, Mary Villarejo, Paula K. Obsatz. service: Jan V. White.)

RESEARCH DIRECTOR: Arthur S. Goldman.

ASSISTANTS: Miles L. Colean, Ruth Goodhue.

ADMANAGER: Lawrence W. Mester.

GENERAL MANAGER

Robert W. Chastaney Jr.

ADVERTISING DIRECTOR

Richard N. Jones

TIME is published monthly by TIME Inc., Time Building, 9 Rockefeller Plaza, New York 20, N. Y. Subscription payable in advance. To individuals or their employes engaged in building—design, finance, realty; material distribution, production; government agencies and super-tyes; teachers and students of architecture associations connected with the building in-teresters and publishers: U.S.A., Possessions, American Union and the Philippines, \$6.00; Canada, \$7.50. Single copies, if available, \$1. All copies Copyright under International Copyright Convention. All rights reserved under the Pan American Copyright Convention. Reentered as second class matter on March 3, 1952 at the Post Office at New York, N. Y. Post Office of March 3, 1879. Copyright 1953 by TIME Inc.

TIME also publishes TIME, LIFE, FORTUNE and THE FORUM. Chairman, Maurice T. Moore; President, Roy E. Larsen; Executive Vice President, Charles L. Stillman; Executive Vice President, Publishing, Howard Black; Vice President, Andrew Heiskell, J. A. Linen-berger; Vice President and Secretary, Robert G. Laugh; Comptroller and Assistant Secretary, John G. Mason; Manager, MARCH OF TIME Division, TIME Inc.

37 News

68 Events

76 Letters

111 Modern mortgages

119 EDITORIAL

120 HOW TO DESIGN AND SELL YOUR NEXT HOUSE

A Round Table tackles ways to house America better and keep the market at its present million houses a year.

128 THE HOUSE AND ITS LAND

How the project can be integrated to its community successfully and how the house can make best use of its site.

132 THE LIVING ROOM

Center of family life, it must be related to the way people like to live, informal and as spacious as possible.

136 THE KITCHEN

The acceptance of the Trade Secrets house open-plan kitchen points to a new, important trend.

140 THE BATHROOM

Most neglected room in the house, this can add sales appeal at little extra expense.

142 THE BEDROOM

Built-in furniture helps to make the most of its small dimensions.

144 HOW TO GET SALES FROM DISPLAY HOUSES

Can the furnished model pay its way? Most builders think it essential but it must be done well.

150 FACTS AND FIGURES ON MERCHANDISING

Two Long Island builders pinpoint ideas that could be used in all parts of the country.

156 WHAT'S WRONG WITH SALESMEN?

His "front man" can make or break the builder's operation.

158 NEWS

160 FASTEST SELLING HOUSES IN THE US

Second in a series reporting what people are buying and why.

166 ADEQUATE WIRING AND GOOD LIGHTING

How to keep pace with the astronomic buying of electrical appliances and give the householder first-class lighting.

170 GARAGES AND CARPORTS

They can add cheap storage and living space if they are handled well.

172 FENCES AND PORCHES

Indoor-outdoor living is essential to today's small house; fences add privacy, porches add indoor-outdoor rooms.

176 SURVEYS

To help them meet competition, builders can get planning tips and warning from customers.

196 IS YOUR ROOF LEAKING DOLLARS?

A comparison of truss vs. conventional construction.

200 Reviews

216 New products

windows

for all

the world

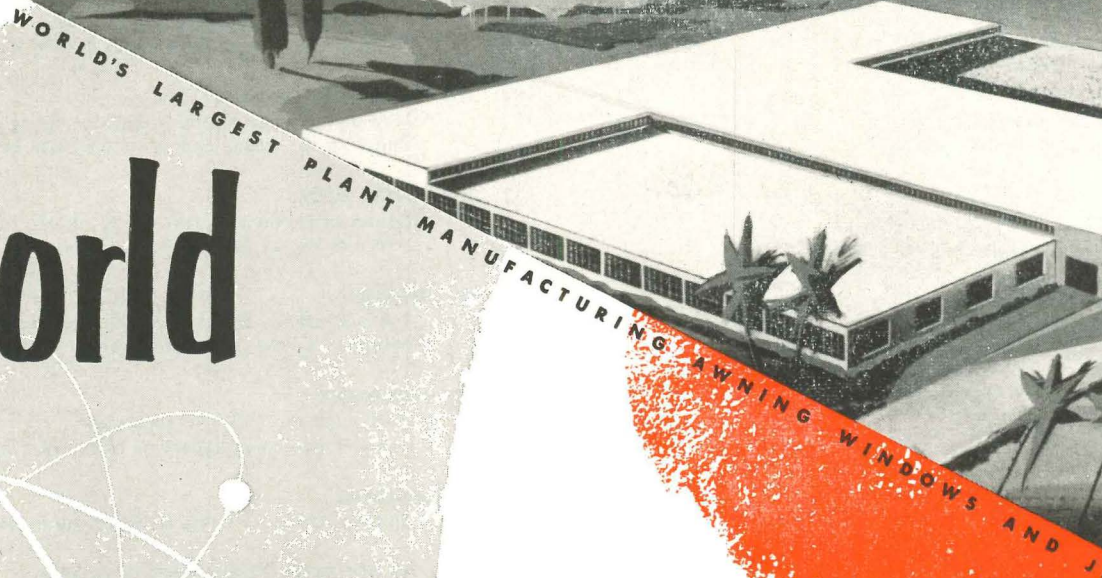

The result of unrivaled research, design and craftsmanship, Ludman window products in a few short years have forged into national dominance. This huge new plant emphasizes **Ludman's proven window engineering leadership**, and provides facilities for continued product creation and perfection, **and production** . . . without equal.

The "growing pains" of production schedules, which taxed old facilities to the limit, have been solved.

TODAY, Ludman is in a position to meet world-wide demand.

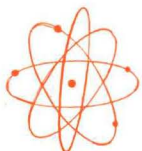

NEW YORK • BOSTON • WASHINGTON, D.C. • CHICAGO • ST

Use bans public housing starts, threatens forced FNMA liquidation

Annual demonstration of how deep-
g is involved in politics began last
Washington.

the administration wrestled with
rozen VA and FHA interest rates
(58), Congress became, amidst the
an economy drive, the battleground
major fight over the Independent
appropriation bill, which provides
or HHFA, FHA, public housing
Federal National Mortgage Assn.
23 other nondepartmental federal

Public housing: no starts. In the
ousing agencies and programs took
re cuts that even GOP leaders pro-
e appropriations committee was
rewrite basic legislation. The No.
to the private building industry's
was public housing. Ever since
of the 1949 Housing Act authorizing
public housing units over a period
ars, the strategy of private housers
to choke public housing by throt-
appropriations. Last year, the
ed to impose a 5,000 unit ceiling
ally subsidized starts, but the
ld out for 35,000 and won.

ne, the House voted to bar all pub-
ng starts after June 30, trounced
106 vote a motion to keep public
at the 35,000 level recommended
Administrator Cole. Defending the
starts, House Majority Leader
A. Halleck (R, Ind.) insisted it
holds the program in suspense"
udies of the government's role in
which both President Eisenhower
ressional leaders have asked.

Los Angeles: support. The House bill
to prohibit the Public Housing Ad-
on from starting or continuing
on in any community where
representatives or a popular refer-
ive "indicated they do not want
proviso was aimed squarely at Los
where voters rejected the idea of
using overwhelmingly last year.
y PHA's action in advancing \$8
ore to the Los Angeles Housing

Authority after Congress told it to bow to
local rejection, the House sought to nar-
row community responsibility for repaying
federal funds to wriggle free of a public
housing program. It provided that cities
need repay "only such money expended
prior to the vote or other formal action
whereby the community rejected such hous-
ing project."

Whether the tighter wording would ac-
tually let Los Angeles off what is now a \$20
million hook appeared doubtful. Some Con-
gressmen predicted the snafu would even-
tually wind up in the courts. But most
agreed that it would make PHA tread care-
fully in the future. Spokesmen for the ap-
propriations committee said 19 other cities
wanted to cancel public housing contracts.
But they were unable to name them.

In a final crack at public housing, the
House slashed its administrative budget
35½%. This applied not only to the
permanent public housing program, but to
all other PHA activities—subsistence home-
steads, Greentowns, public war housing
management, veterans' reuse housing and
defense public housing. It ordered PHA to
"refund" with private money "insofar as
possible" its holdings of local public hous-
ing bonds. Appropriations committeemen
estimated \$271 million of these could be re-
funded during fiscal 1954.

For FNMA: liquidation. While the pub-
lic housing rumpus was more spectacular
(it put housing back on the front pages of
the nation's newspapers where it had been
long absent while GOP leaders gave first
attention to other problems), an economy
maneuver to cash in part of Fanny May's
holdings was of graver concern to private
building. As the appropriations bill came
from the committee, it ordered the govern-
ment mortgage agency to sell up to \$1 bil-
lion of its \$2.4 billion portfolio within a
year, even if it had to do so at a discount.
It ordered FNMA not to commit itself to
buy any new mortgages after June 30.

To Chairman Jesse P. Wolcott of the
House banking committee as well as alarmed
builders, such forced liquidation of Fanny
May looked unsound. Not only would
Fanny May have to sell at discounts which
could cost the government up to \$50 mil-
lion (thus wiping out Fanny May profits),
but the sales would siphon off a big chunk
of financing needed to spark new home-
building.

Even the threat of Fanny May liquida-
tion, plus the imminence of an interest

rate boost for VA and FHA mortgages,
promptly scared most of the nation's big
lenders out of the market (see p. 158). Most
of them would not be back in until both
questions were settled.

Rescue by Wolcott. Through off-the-
floor conferences, Wolcott persuaded his
appropriations committee colleagues to
soften the blow. The compromise adopted
by the House would let Fanny May use its
judgment about how much to sell and when
—a power it already had. The door would
not be closed to new purchasing, but the
policy would be to do as little as possible.
"There will be no question of dumping,"
Wolcott assured. "I believe the market can
absorb something like \$250 million annual-
ly." By adding the proceeds of sales to re-
captures from unused amounts set aside for
buying in defense and nondefense areas
and to regular amortizations, Wolcott
thought Fanny May could turn back \$900
million to the Treasury in a year. New
purchasing, he believed, would be confined
to the one-for-one plan, except for out-
standing commitments in defense areas.

For research: full stop. For HHFA it-
self, the House's most drastic cut would
scuttle the research program created in
1949. If the complete elimination of HHFA
research funds stands, HHFA would be hard
put to compile and distribute information
on research already under way, since the
staff under Joseph H. Orendorff would have
to be disbanded.

The House handed slum clearance and
urban redevelopment a Mickey Finn. The
law now permits cities to count the cost of
facilities like schools and parks in its ½
share of redevelopment costs. The House
ruled out such contributions, despite pleas
by Congressmen from cities like San Fran-
cisco, Pittsburgh and Detroit that this would
jeopardize many a pending redevelopment.

In only one minor respect did the House
overrule its appropriations committee. It
nearly doubled HHFA's college dormitory
loan program by moving up the date for
drawing on HHFA's \$21 million current
fund to June 30.

As usual, the House gave FHA its most
lenient treatment. It left the \$27.5 million
for FHA field operations unmolested. But
it trimmed the agency's administrative bud-
get from \$5.6 million to \$5.04 million. FHA
promptly cried this would cut its Washing-
ton staff so low (to 800) the agency could
no longer do "a proper supervisory job."

Cries of outrage. The cries of FHA were
muted compared to the howl that arose
from public housers. Stopping public hous-
ing, said Sen. Burnet R. Maybank (D,

ON THE INSIDE:

and FHA mortgage market goes in-
spin as lenders pull out to await
rate increase, FNMA decision.
control is extended three months
tical area controls another year.

(pp. 158-159)

S. C.) was a slap at "downtrodden people." "Murder," screamed the National Housing Conference—the public housing lobby group. New York's Mayor Vincent Impellitteri wired New York Congressmen that it would "cut the heart out of the city's efforts to clear slums." State Housing Commissioner Herman T. Stichman of New York called it a "costly mistake," which would thwart "efforts to lessen future deteriorating in our cities." The *New York Times* asserted eliminating public housing would be "a disaster for . . . large urban centers."

Amid the furore, reporters seized the chance to quiz President Eisenhower on his views. His comments proved so mild they underscored the widely held belief that the Chief Executive is no friend of public housing. Asked a newsman: "There seems to be some question where you and the administration stand on public housing in view of the appropriations action of the House. Some of the Democrats charge that you during the campaign had pledged public housing would be continued . . ."

Eisenhower's views. Replied the President (direct quotes are banned under White House rules unless specifically au-

thorized): He didn't like to be too positive when he depends completely on memory, but he didn't recall ever saying he was in favor of the continuation of federal public housing, but he would say this: he was quite concerned that the federal government perform the function that was proper for the welfare of our people as well as for its purpose in the world and all of the other things which fall to the federal government. Consequently, at one of his earliest press conferences, he pointed out that he proposed, among other things, to ask for the establishment of an official commission which would be made up of people representing the public, the executive department, the legislature, and so on, which would determine the proper division of functions between the federal government and the state governments, and he was not certain in his own mind where that dividing line falls, but he had also said that pending the meeting of such a commission and finding of such responsibilities and establishment of division of authority that he thought we should go ahead with the programs now in existence and in effect mark time. His own idea of marking time was to take the number of housing units

in the current bill and let them go but there has been no pressing of a moment of the point because no major principle is involved. We are going to depend on this commission to tell us how much the federal government should do and how much the state government

Asked whether he approved of the cut on public housing, the President replied: It did not agree with his personal view of what would be the best thing and the convenient way of handling this matter in the status quo until it could be decided on a bipartisan, objective basis. Now that did not mean, though, that he asked these people as a matter of fact for possible party leadership to support his position. He made no attempt to do that. It did not sense in any way that they defied him and he certainly did not go to get up and criticize them. He said they were all voting their consciences.

SOS to the Senate. Saving public housing, if it was to be saved, was thrust up to the Senate. As the Senate appropriations committee began hearings, Housing Administrator Cole urged it to restore housing to 35,000 starts, and reinstatement of the House cuts.

Cole called 35,000 starts "a simple, sensible solution" which "would avoid an endless amount of argument and demerit money." He disclosed that by a quirk the House had actually outdone itself and paved the way for starting as many as 70,000 units. In its zeal to get public housing off June 30 by prohibiting PHA from entering into any more annual grant contracts after that time, the House changed the restriction in the law written last session that limited starts to 35,000 a year. House debate indicated that *bona fide* contracts already in the pipeline would be in the clear in the absence of statutory limitation on the number of contracts. Since PHA had 70,000 units in the pipeline, it could start them before the House bill.

Asking restitution of the administrative cuts in FHA and PHA, Cole was seconded by FHA Commissioner Gunderday and PHA Chief John Taylor.

Egan said PHA "would have to cut one third of our employees," if the budget cut stood. Cole asked that the money be provided to hold the housing search staff together even if the program stopped in its tracks. The amendment restoring public housing in Los Angeles and other places that have changed their minds would be omitted, he said. He promised that with such situations administrative action that the will of Congress and the cities was carried out.

HOW THE REPUBLICANS ARE TRIMMING HOUSING APPROPRIATIONS

AGENCY AND PROGRAM	TRUMAN BUDGET	GOP BUDGET	HOUSE ACTION
Office of the administrator			
Supervision and coordination.....	\$960,000	\$929,000	\$722,100
Slum clearance	2,185,000	1,985,000	1,585,000
Housing research	950,000	800,000	0
Advance planning	210,000	195,000	195,000
Programming	245,000	221,000	85,000
Total—salaries and expenses.....	4,550,000	4,130,000	2,587,100
Housing loan programs			
Alaska	85,000	78,000	63,750
College housing	450,000	400,000	225,000
Prefab	245,000	162,000	122,500
Total—housing loan programs.....	780,000	640,000	411,250
Construction of defense community facilities....	115,000	115,000	112,500
Capital grants, slum clearance and urban redevelopment	20,000,000	20,000,000	20,000,000
Maintenance	60,000	60,000	60,000
Nonadministrative under limitation.....	670,000	570,000	500,000
Federal National Mortgage Association.....	4,600,000	4,200,000	2,300,000
Home Loan Bank Board			
Board proper	775,000	775,000	775,000
Examining division (nonadministrative)	2,085,000	2,085,000	2,085,000
Federal Savings & Loan Insurance Corporation..	455,000	455,000	455,000
HOLC liquidation (nonadministrative).....	24,661	24,661	10,000
Federal Housing Administration			
Administrative	5,900,000	5,600,000	5,045,590
Nonadministrative	28,050,000	27,500,000	27,500,000
Public Housing Administration			
Appropriations	11,300,000	9,600,000	4,948,000
Authorizations	4,300,000	4,300,000	4,025,000
Annual contributions	39,700,000	39,700,000	32,500,000
Nonadministrative	38,826,300	35,963,000	35,963,000
Number of low rent units.....	75,000	35,000	0

remnants of Reg. X are wiped out by A, restoring nothing-down VA loans

rebuilders tied to government-financing and thus hogtied by the VA interest rate mess (p. 158) as jobs fell from the table last month: vestiges of Reg. X were canceled Administrator Cole.

FHA or VA loans could still be as might make sales a little easier. loans, it restored the pre-Korea no ment. It paved the way for lower carrying charges by authorizing 25 rs amortization of FHA loans and payoffs for GI mortgages instead ear limit on both.

HB moaned that "these theoretical savings will be possible only if lenders are willing to extend credit longer periods." It labeled this a noted that "most lenders insist ment in even less time than render the old FHA and VA rules."

Rate savings. Despite money homebuilding was still booming big year. And builders could consume new statistics pointing up ability to buy.

instance, SEC reported that conade money faster than they spent it set aside record postwar liquid of \$14.6 billion, compared with ion in 1951. The US Savings & gue and the National Association Savings Banks reported continued wings through the first quarter of too (\$1.3 billion ahead of their it increases in '52's first quarter). eant more funds available for pering to buy houses themselves, or for mortgage loans to finance pur- other buyers.

Too. Total outstanding consumer up \$10 billion last year, the Compt. reported, to a new \$32 billion he net increase in mortgage debt n one- to four-family houses, how- ned to \$6.3 billion, compared with 1 and \$7.6 billion in '50. At the '53 home mortgage debt stood at on.

month brought the start of the h new home in the US since V-J HB symbolized the event by pick- '50, two-bedroom, Cape Cod dwell- lorida Springs, erected by Rhue- ilders, as house No. 7 million. rado Springs HBA staged cere- the house April 12. President Smartt commented: "If other had such a good record of

home production there probably would be less world unrest. Good homes and full stomachs go a long way in relieving tensions in this atomic age."

No peace fear either. To reassure "some people in this country [who] are talking as though they were afraid of peace" Treasury Secretary George M. Humphrey, architect of the Eisenhower administration's fiscal policies, went on record before the annual Associated Press meeting in New York that the United States is virtually slump-proof. Said Humphrey: "There is no reason to fear peace. We are not headed for depression."

Labor was not so certain, stumbled all over itself on the peace or prosperity issue. With CIO economists concurring, AFL Research Director Boris Shishkin said "some production cuts and some factory layoffs can be expected as early as next fall" regardless of the outcome in Korea. Deflationary, "hard-money" Eisenhower policies are a mistake, they argued, will make home buying and construction more difficult, mortgage money scarcer and more costly, construction loans harder to get.

Oblivious to Shishkin's pitch, AFL President George Meany only two days later told a New York dinner in his honor that the AFL has no postdefense worries. He said there is such a backlog of undone work

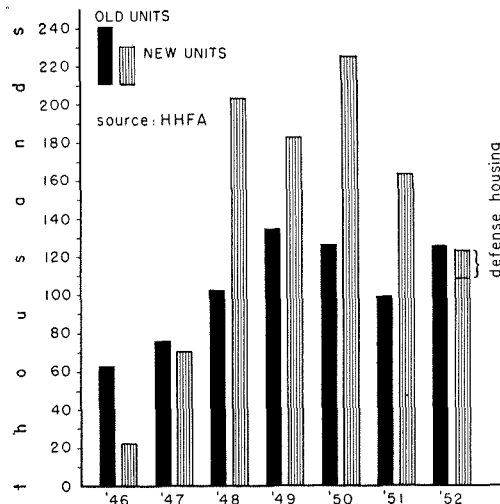

FHA MORTGAGES covered 286,033 units last year, a 14% drop from 1951, the agency reported last month. For the first time since 1946, FHA insured fewer new homes (122,849) than existing units (123,345). And the new housing included 14,449 units of defense housing. FHA was not yet sure what caused the change. (The number of FHA apartments fell, too.)

there should be no unemployment from reduced defense orders. Meany said the country urgently needs great volumes of new schools, hospitals, roads, factories, low-cost housing and slum clearance.

Design for selling. For builders uncertain of how to keep up sales come peace or continued cold war, there were two encouraging suggestions. One came from former NAHB President Tom Coogan:

"The properly designed house is half sold when you start it. We are moving into an



New York crowds jam Gimbels for co-op apartment sale

In January Gimbels' Philadelphia store met success in the nation's first department store effort to sell cooperative apartments. Last month, Gimbels tried it again in New York with spectacular results. After newspaper stories and full-page ads, the store one Monday morning put on display two completely decorated four-room and five-room model suites for an FHA 213 development planned in Bayside, Queens. Prospects were waiting outside at 8 a. m., an hour and a

half before opening. Before the day ended, 10,000 persons had flocked to the sales exhibit pictured above. The store signed up 150 couples the first day, took \$5 deposits from several hundred others for interviews later. Sponsors of the proposed 3,700-family project, billed as the largest cooperative apartment community in the nation, were Norman K. Winston-Holzer Associates. Winston also announced a 213 project of about 2,600 units last month for Chicago.

5 GOOD REASONS . . .

WHY AIR CONDITIONING HELPS SELL YOUR HOUSES!



1. You sell modern living when your homes have Chrysler Airtemp Year 'Round Air Conditioning. You sell better health, more comfort and less housework in every room in the house!
2. Your prospects will find the cost of Year 'Round Air Conditioning is surprisingly low when included in the mortgage.
3. Your selling job is easier because customers have confidence in the well-known Chrysler Airtemp name.
4. A *time-tested* package developed through 15 years of residential experience is important to you and your prospects.
5. Chrysler Airtemp stands behind its product! A nationwide network of authorized dealers is ready to render prompt attention and courteous service, should it ever be required.

Get all the facts today. Mail the coupon below and sell Modern Living to your prospects . . . sell YOUR homes quicker!

Chrysler Airtemp

HEATING • AIR CONDITIONING
for HOMES, BUSINESS, INDUSTRY

Airtemp Division, Chrysler Corporation, Dayton 1, Ohio

Airtemp Division, Chrysler Corporation
P.O. Box 1037, Dayton 1, Ohio

H&H-5-53

Please send full details about the Chrysler Airtemp Comfort Zone.

Name _____

Address _____ Phone _____

City _____ Zone _____ State _____

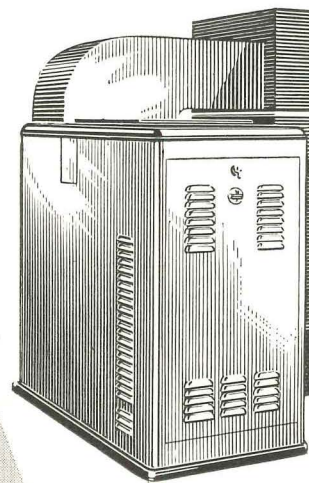

Comfort Zone

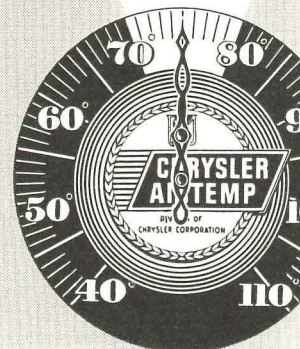

Baltimore ex-FHA chief indicted on bribery count; FHA industry advisory board named

The first thing Guy T. O. Hollyday did after he was sworn in as FHA commissioner April 16 was to appoint his predecessor, Walter L. Greene, as deputy commissioner—a post Greene held five years until last June.

Then Hollyday, a Baltimore title insurance executive and former (1946-47) president of the Mortgage Bankers' Assn., settled down amid the rich green leather of the commissioner's triangular office on the fifth floor of Washington's FHA building for a try at giving the 20-year-old housing agency a shot in the arm.

Industry advisors. Two weeks later, the first Hollyday change appeared. HHFA announced appointment of an adroitly balanced six-man industry advisory committee for FHA. Its members included some of housing's brightest thinkers: Chairman James W. Rouse, Baltimore mortgage banker; Builder-Realtor Fritz Burns of Los Angeles; Builder Phil Klutznick of Chicago, former chief of the federal public housing administration; H. J. Mendon, vice president of the California Bank in Los Angeles; President Walter Gehrke of Detroit's First Federal Savings & Loan Assn.; and E. A. Camp Jr., vice president and mortgage specialist of Alabama's Liberty National Life Insurance Co. The committee's job: propose changes in FHA rules and procedures to help it serve the housing industry better.

Actually, some other imminent FHA changes would not be much of Hollyday's making. By long custom, FHA's 72 district directors are political appointees. Many of the Democratic incumbents could look forward to being replaced by Republicans who got the nod of those in control of political patronage. Even before Hollyday's nomination, Republican appointees were named to head FHA offices in Philadelphia and Grand Rapids, Mich. (H&H, Apr. '52, News).

Two new directors. Two more district FHA directors were named last month.

► For New York: dapper Realtor William Adam Schulz, 49, a veteran civic and Republican organization worker in Queens who twice ran unsuccessfully for Congress. Schulz, twice president of the Queens division of the Long Island Real Estate board, succeeded Harold M. Clay. Clay, a Democrat, who had held the post since 1948, resigned in March to enter private business.

► For Baltimore: Attorney Stratford Eyre McKenrick, 39, slow-spoken ex-lieutenant colonel who has specialized in realty and

title law since returning from the Army five years ago.

Baltimoreans considered McKenrick's appointment standard politics. Although a Democrat, McKenrick headed the Baltimore County Citizens' Committee for Eisenhower (Guy Hollyday—also a Democrat—headed the Baltimore city committee). Last December, McKenrick switched his registration to

Fabian Bachrach



McKENRICK



SCHULZ

Republican. His appointment was sponsored chiefly by GOP Sen. John Marshall Butler, approved by Sen. J. Glenn Beall and Gov. T. R. McKeldin.

McKenrick's chief job would be to restore confidence in the integrity of FHA in Baltimore. His predecessor, E. Lester Muller, 63, who resigned under a cloud in February, was indicted by a federal grand jury last month on charges of accepting a \$1,000 bribe from two builders to influence "matters then pending before him in his official capacity."

Two other former FHA officials and the two builders were indicted with Muller. J. Hamilton Walker, former Baltimore chief architect, was accused of falsely telling FBI agents that he never gave preferential treatment to builders, and did not know that preferential treatment had been accorded to contractors by FHA employees in Baltimore. Builders Harry Bart and Albert Stark were accused of depositing \$1,000 in Muller's bank account to influence him. Bart also was charged with perjury in telling FBI agents under oath that he never gave any money to an official or employee of FHA. Raymond M. Miskimon, former FHA inspector, was charged with falsely swearing he never had contacts with Stark.

21-day Florida row. A problem that did land in Guy Hollyday's lap involved Florida sanitary officials and state FHA men. Late in March, without warning, State Sanitary Engineer David B Lee canceled a 15-year-old policy of approving percolation tests, septic tank or sewer systems and individual water supply systems for FHA projects. Without the health board certifi-

n the builder has to give a new every year or the word gets out that improving the house. I don't know it's good or bad. But it's getting the auto industry where you have the grille and radiator and hub every year or you can't sell your prod-

second was the repair and remodel-market which the US Chamber of Commerce said might total \$6.5 billion a year, 10% more than government figures said the Chamber: "Here is one area where the industry need have no fear of a big demand."

Los Angeles mayor loses election over public housing

Los Angeles, although Los Angeles voters rejected public housing by a sizable margin (59%), Mayor Fletcher Bowron did not act in support of the city's \$10,000 unit public housing project. At one point, the rhubarb grew so hot that Bowron landed a swing on a heckler (Oct. '52, News).

Last month, as the mayor sought re-election for his fifth term, his opponents made public housing the chief issue—and won. For the first time in 20 years, a Los Angeles candidate running for office again failed to win a plurality in the primary balloting. Results:

Walter Poulson (R, Calif.)	211,247
Fletcher Bowron	178,362
Walter Lloyd Aldrich	70,459

Aldrich threw his support to Poulson. Los Angeles politicians figured anti-public housing Poulson was way out in front in the May 26 general election.

Public housing race ban OK; equal facilities are equal

The National Association for the Advancement of Colored People to prohibit discrimination in public housing (H&H, Oct. '52) stopped short last month in US Supreme Court in Washington. Judge Alexander Holtzoff ruled that Negroes may be excluded from US aided projects provided equal facilities are available. The NAACP's suit, which had posed a serious threat to public housing anywhere in the country, was brought in the District of Columbia to join top PHA officials from Atlanta and Savannah on a site from which Negroes were to be evicted. PHA requested that the suit be dismissed only on jurisdictional grounds, but the land is still uncleared, tenants have not yet started. But Judge Holtzoff ruled that Savannah Negroes were not denied constitutional rights because that state provides all-Negro public housing.

Prize-winning kitchen and utility room from Crane's architectural competition

New room ideas that help sell homes



First Prize Kitchen for home in any price range—Richard C. Brigham, Cambridge, Massachusetts. Crane fixtures include counter-top sink, Duraclay laundry tub and Crane-Line wall, base, and utility cabinets.

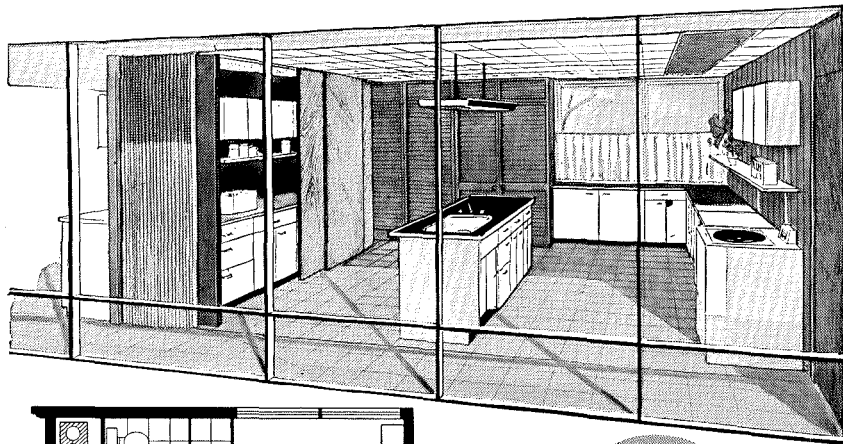
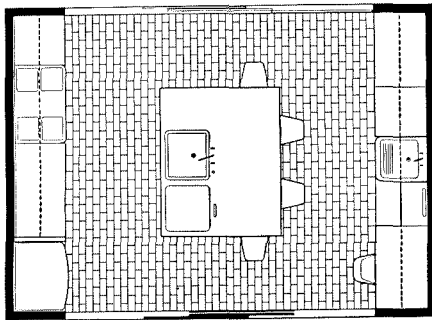
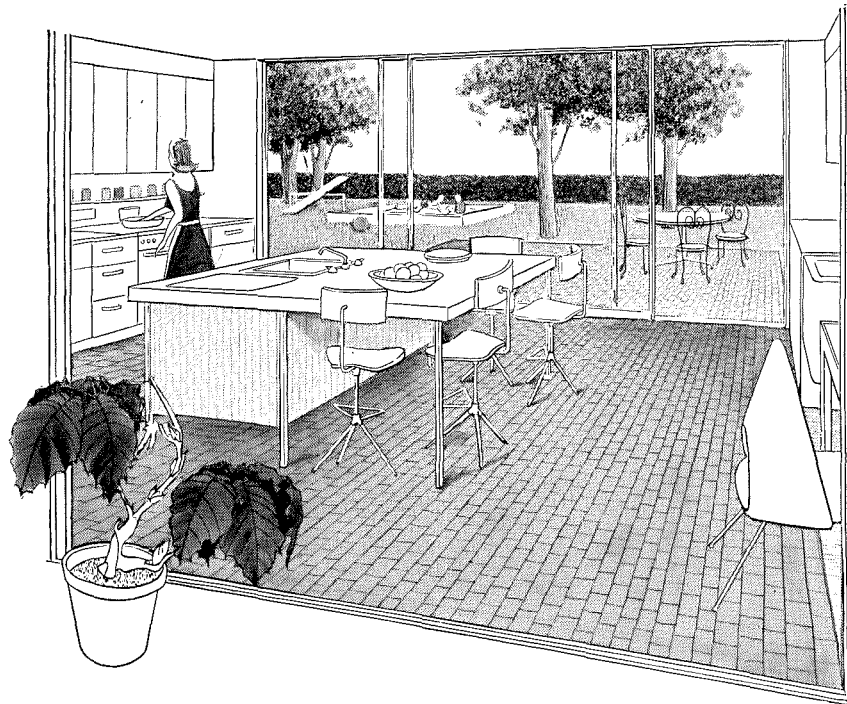

First Prize Utility Room for home in any price range—Donald H. Panushka, Birmingham, Michigan. Crane fixtures include Duraclay Laundrette, Crane-Line Superior water heater, Crane cabinets, and Crane water closet.

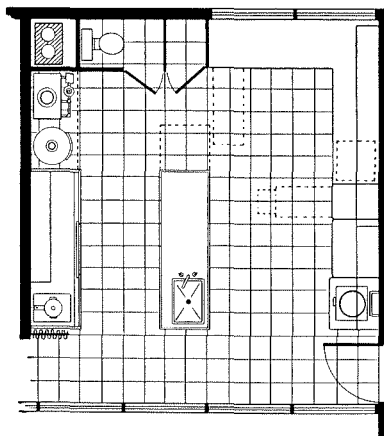

Crane's national architectural competition was held to bring out new ideas in room planning—ideas to make homes more attractive and appealing to buyers, easier to sell.

Working for generous cash awards, nearly 500 architects and draftsmen applied their best thinking to the job, turned in dozens of prize-winning ideas like those illustrated here.

Right now, the best of these ideas are being set up as actual rooms, with all equipment in its proper place and all decorating done. As soon as possible, full details of these rooms will be provided for your use.

Meanwhile, 46 similar room ideas are already available in the big Crane Sketchbook of Ideas... a valuable and helpful book that is free—yours for the asking—at the office of your Crane Branch or Crane Wholesaler. Get *your* free copy today.

CRANE CO.

GENERAL OFFICES: 836 SOUTH MICHIGAN AVE., CHICAGO 5
VALVES • FITTINGS • PIPE
PLUMBING AND HEATING

FHA refused to issue either preliminary or final loan commitments. FHA in Florida tottered toward a standstill after 21 days of mounting protests by labor unions and merchants. In the Miami area solved the problem. Dade County commissioners ordered

the ill-equipped county health department to take over certification. Elsewhere in Florida, the tie-up continued until April 27, when Hollyday persuaded Florida health officials by long-distance phone to resume certifications pending a powwow with top FHA technicians.

air conditioning. The public wants it, but the industry is holding up the bandwagon." Cole demanded a "one-stop installation" to replace the chaotic and expensive installations that stretch on for weeks. He asked for prices lower than today's \$500 a ton, and more aid from the industry in selling air conditioning to FHA.

Air conditioning producers forecast record sales; builders ask more aid selling FHA

Does air conditioning go now? The answer seemed last month when prices soared into the stratosphere. Last year, 1.5 million central conditioning units for new homes totaled about 20,000. About 1.5 million room conditioners moved off shelves. For this year, manufacturers are talking optimistically of producing as many as 75,000 central units for homes and from 700,000 to 1 million room conditioners. In retail sales, forecast President Wampler of Carrier Corp., says, in the field, air conditioning may reach \$2 billion this year. If so, that will be a whopping 50% gain from last year when the industry's retail sales were only \$1.25 billion (including about \$100 million of ice makers, and frozen-food cabinets).

Signs of the boom: General Electric's air-conditioning division reported its first quarter on record. Chrysler's airtemp division said first-quarter

demand was so strong it was doubling a planned 25% increase in production.

Research hurdles. In *research*—the long-range key to developing the market—air conditioning still faced a lot of hurdles. A conference of 200 air-conditioning experts April 24-25 at Lehigh University heard Research Chief Walter Grant of Carrier Corp. name the most important.

- ▶ "How do you air condition the kitchen where tremendous cooking heat is generated?"
- ▶ "What has to be done with bathroom design to prevent humidity from showers, etc. from putting an undue load on the air conditioner?"
- ▶ "How do you air condition a dining room where a dozen or more people gather for dinner and concentrate a load on the air-conditioning unit for only an hour or so?"

A needle from builders. Outspoken Ned Cole, the Austin, Tex., architect-builder, needled the air-conditioning industry in behalf of builders for more help. Said he: "Homebuilders are clamoring for

Prof. M. K. Fahnestock of the University of Illinois surprised the conference by insisting that "exhaustive experiments" show people want inside summer temperatures no higher than 76° or 77°. Up to now, most air-conditioning makers have insisted equipment to reduce the temperature to 80° was adequate. Cracking back at Cole, Fahnestock urged the building industry to "make an attempt to learn a little about air conditioning." He snapped: "So far, architects and builders want everything handed to them on a platter. We have had an awful lot of trouble, especially with architects, getting them to take advantage of excellent research." Fahnestock said too many designers still use 2" and 3" insulation, when 4" is needed, costs almost no more.

BOCA adopts first code rules covering plastics

Rapid development of structural plastics of diverse physical and fire resistive properties has created an "emergency situation" requiring prompt controls according to a

Architect-engineer invents novel calculator that shows how the sun will hit a house

Among the most laborious computations architects face in designing houses is to determine how much light change in orientation will affect the amount of sun coming through a window, or calculating the size of the perfect overhang. Last year, Robert Rust, a retired Denver electrical engineer turned home architect, took the wraps off a machine that reduced the problem to push-button simplicity.

On the bearings, Rust mounted a turntable marked off in 360°, replaced the top with a sheet of glass. Beneath it, he laid translucent paper lined in 1/4" squares to correspond to the scale of a model house. Above the turntable, he arched a beam graduated into hours of the day and pivoting to denote latitude and season. On the arch he mounted a lamp to represent the sun. Under the table he set a mirror at a 45° angle. When the "sun" shines on a model house (with a translucent roof)—it also shines through the glass top and ruled paper, projects a black and white image of how the house will look at the selected hour and day,

and the distance of sunlight penetration through each window. Rust got his idea from Libbey-Owens-Ford's sun angle calculator (ENR, April '51, News), which permits quick computation of how sun will strike buildings in latitudes between 24° and 52° north. Many architects figured Rust's invention would simplify explaining solar problems to clients. Said Architect Dudley Smith: "The saving could be immense." Said Prof. Cal. Briggs: "This is the simplest I have ever seen to aid in solar orientation."



Photos: Dean Conger, Denver Post



Entrance to Mr. Henry Doelger's smart new Westlake project. One of California's largest building efforts, planned to contain over 10,000 family units, Mr. Doelger's Westlake will be an entire new "city."

HENRY DOELGER BUILDS A "CITY"... AND CROSLLEY KITCHENS HELP SELL IT!

Building a 10,000-home project—virtually an entire "city"—at one time, is nothing unusual for Henry Doelger. He's one of the biggest and most successful builders in America today.

Henry Doelger knows from experience the value of completely equipped, quality kitchens in mass-selling homes. That's why he's depending upon Crosley to help cinch sales in his new Westlake project in California.

Moreover, Mr. Doelger knows that Crosley products not only sell prospects but keep them sold as well. Crosley equipment is engineered for durability . . . "kitcheneered" to fit into compact work-saving units that buyers learn to appreciate more and more every day. And that's mighty important to a builder's reputation.

So take a tip from this "dean" of the building trade—Mr. Henry Doelger. Let Crosley's Kitchen experts help you plan a kitchen with real built-in sales-appeal and buyer satisfaction.



Henry Doelger, builder of the giant Westlake project, points out sales features in a Crosley-equipped Kitchen.

Crosley Kitchens give your Homes Real Sales-Appeal

Only Crosley Kitchens give you all these extra convenience features which help make your homes the best buys in town . . . and help give them real long-lasting value!

First, with the Crosley Shelvador® Refrigerator you can give prospects more refrigerated storage than with other makes. Crosley Electric Ranges offer such sales advantages

as two-area heating in surface units and completely automatic ovens. What's more, you provide plenty of fine storage space when you install Crosley Wall and Base units . . . and Crosley Kitchens can be designed to fit the plan you have available. And remember, Crosley will help you plan your kitchens.

FOR MORE FREE INFORMATION . . . CLIP AND MAIL

CROSLLEY

DIVISION  CINCINNATI 25, OHIO

SHELVADOR® REFRIGERATORS • SHELVADOR® FREEZERS • ELECTRIC RANGES • RANGE AND REFRIGERATOR PANTRIES • AUTOMATIC DISHWASHERS • ELECTRIC WATER HEATERS • ELECTRIC FOOD WASTE DISPOSERS • SINKS • STEEL WALL CABINETS • STEEL BASE CABINETS • VINYL-ON-STEEL CONTINUOUS COUNTER TOPS • HANDY ACCESSORIES • TELEVISION • RADIOS • ROOM AIR CONDITIONERS

Builder Sales, Dept. MB-53, Crosley Div., AVCO Manufacturing Corporation, 1329 Arlington Street, Cincinnati 25, Ohio

Please send complete information on all Crosley products to:

Name _____

Company _____

Address _____

City _____ Zone _____ State _____

ee report in March to the Building Conference of America. Result: annual convention in Dallas April 1964 adopted the first approved requirements in any major building code.

approval, plastics must "meet the requirements, durability, sanitary and fire requirements of the [BOCA] Basic Code and accepted engineering practice." Plastics must burn no faster than 2½ in. per hour when subjected to the American Society for Testing Materials standard tests. Flammability, must be listed by the American Materials Manufacturers Assn. or the American Manufacturing Chemists Assn. Inc.

Excluded. Keeping abreast of the changes in open-deck parking garages, BOCA has approved steel structures up to six stories high and 30,000 sq. ft. in area provided

fire risks are trained and fire fighting and the fire is not allowed on the ground floor. If not, it broke through. So, it broke through. Many insurance companies and municipal officials have demanded that construction be limited to 10,000 sq. ft. limits.

fire risks have been exaggerated. "The insistence on enclosed walls has been unrealistic," said outgoing President P. Wolff of Detroit. Open-air parking is just one of the steps BOCA urges to get rid of outdated, antiquated codes that hinder city growth and often cause corruption through their evasion, added incumbent Arthur J. Benline, technical director of the New York State Building Code Commission. Codes urged by the National Board of Fire Underwriters are too restrictive, Benline declared, and fire insurance companies often push through codes without regard for building costs or real fire danger. Along with 89 other changes approved in the new code was a lowering of minimum clear floor-to-ceiling heights from 8' for the first floor and from 7'-6" for upper stories.

is toward unity. After BOCA'S report to the Joint Committee on Building Code, presenting the nation's nine principal organizations held a two-day meeting, approved two statements of principles, recommending administrative and procedural changes for local building codes, and encroachments on public property authorized during construction.

Benline also was informed that American Building Assn. has incorporated some of the recommendations in its new *Standards for Construction*.



BENLINE

Coogan goes to France to begin Armed Forces housing built with French capital

Thomas P. Coogan, the armed forces housing chief, sailed for France last month to get the latest scheme for housing soldier families abroad underway.

With him, he took the necessary approval of Senate and House Armed Forces committees for the US to guarantee 95% occupancy of 2,000 apartments for five years. With that, Coogan expects to woo French capital into building two- and three-bedroom units from 750 to 900 sq. ft. at FHA-like standards in six French cities: Chateauroux, Orleans, St. Nazaire, Chaumont, Toul-Rosures and Bordeaux. He hoped for some occupancy by winter.

If all went well, the family housing might not cost US taxpayers anything except for administrative costs. Rents paid by soldier-occupants—perhaps \$125 a month for a 900 sq. ft. unit—are to amortize the construction cost to a point where the much lower level of French rents can support the projects when the US guarantee expires. But Congress last year appropriated a \$100 million rental umbrella in case of vacancies.

The three- and four-story walk-ups such as Coogan envisioned for the pilot French project would take care of US servicemen's needs at bases in populous areas. For remote spots, Coogan hoped to erect relocatable housing. Despite a protest from the Green Lumber Co. of Laurel, Miss. the Congressional committees approved pur-

chase of 200 foreign prefabs to begin that phase of the plan. But for the moment, Pentagon brass held up the prefab program.

5% escrow withholding urged as builders' warranty

Pressure for a federal warranty on new houses bought by veterans rose closer to the boiling point. After a series of hearings on shoddy construction in his home state Rep. William H. Ayres (R, Ohio), chairman of a House veterans affairs subcommittee, proposed the most drastic plan offered Congress to date.

Ayres urged a law to force VA or the mortgage lender to hold back 5% of the appraised value of the house from the builder for six months after completion, "until a final inspection disclosed no serious defects." So far, Ayres had no details.

To help stave off VA and FHA warranty legislation Miami and Milwaukee homebuilders inaugurated voluntary guarantee programs. As a condition of membership, the Home Builders of Greater Miami last month required builders to give a one-year warranty against defective workmanship and materials for plumbing, heating and electrical systems, roofs and septic tanks, provide service on other components of the house. Milwaukee Builders' Assn. members started issuing written-six-months service assurance policies.

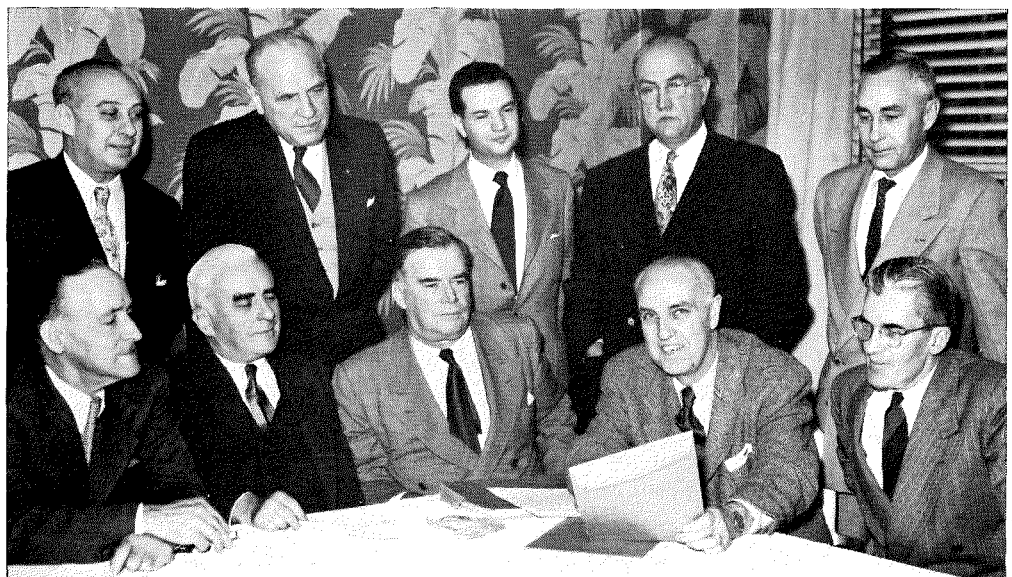

DETROIT BUILDERS joined the ranks of home-builder organizations bonding members for \$100,000 each to guarantee the public against loss of deposits by fraud (but not by business failure). Building industry and government officials examining the bonding contract between Lloyds of London and the Builders Assn. of Metropolitan Detroit were (l to r): standing, Frank Laurens, Bureau of Credit manager, Building Commis-

sioner Joseph P. Wolff, General Counsel Irving Yackness, Chief Asst. Prosecuting Attorney Ralph Garber, VA Chief Appraiser Herbert D. Benson; seated, William J. Guinan, former association executive director, President M. M. Robinson, Prosecuting Attorney Gerald K. O'Brien, Acting Detroit FHA Director Harry M. Steffey, and General Manager H. I. McEldowney of the Better Business Bureau.

Builders fret at go-slow approach to housing changes; MBA proposes sweeping reforms

Nearly everybody was getting into the housing policy act last month. As the Eisenhower administration began coming to grips with the complex problem of restudying and rewriting the nation's basic housing laws, it was confronted with more and more advice both from inside the industry and out of it. The principal developments:

▶ Realizing it will be difficult (if not impossible) to push any major housing legislation through this session of Congress, NAHB started a six-week round of meetings in 200 cities to build up grass-roots support for its 1953 program (H&H, Mar. '53, News). Chief objectives: 1) a raise in VA and FHA interest rates to make mortgage money flow better, and 2) drastic reduction of FHA down payments. (Sample: cut the down payment on a \$12,000 house from \$2,400 to \$1,200.)

▶ The Mortgage Bankers' Assn., in a 17-page pamphlet, proposed drastic changes in government housing programs. Among them: stop public housing cold pending a complete restudy of the proper federal role in slum clearance (the House promptly voted to do so—p. 37); a "complete reorganization" of HHFA; reorganize the Federal National Mortgage Assn. "looking to eventual ownership by private industry"; write a new subsection of FHA Title I for rehabilitating rundown housing with a \$7,000 insurance ceiling and 20-year maturity; merge VA and FHA appraisals, credit examination and property inspection to reduce the "enormous" needless "delay, confusion and cost" in the present parallel systems. Because bankers fill so many high posts in the Eisenhower administration, and because mortgage bankers have a direct pipeline to the White House, MBA's proposals took on significant weight.

▶ At least five official studies of how to reorganize housing activities were proposed, beginning, or underway. The President's advisory committee (the so-called Rockefeller committee) was submitting one report. Two Congressional committees were delving into the problem and one had hired the Brookings Institute to make a survey.

A fourth investigation would result from a 25-member Commission on Governmental Functions and Fiscal Resources proposed by Sen. Taft and Rep. Halleck, the majority leaders, with presidential support. The commission, certain of Congressional approval, would concern itself particularly with federal grant-in-aid programs, including redevelopment and public housing. Its final report was due next March 1. Finally, HHFA Administrator Albert M. Cole was under White House directions to study government housing agencies (though not to duplicate the work of the commission). His report was not expected before next year, either.

Though NAHB leaders had so far refrained from attacking the wisdom of Eisenhower's "let's - have - a - commission-study-the-problem approach" many of them were privately critical of the delay involved. NAHB expressed its concern in tactful language in its Washington *Letter*: "To maintain construction at or near our present volume, industry observers recognize the need for early enactment of legislation to modernize our financing tools. The 6- to 24-month time lag between initial planning and ultimate production of housing requires that such changes be effected as soon as possible in order to be reflected in starts in 1954. Some legislators and others in government have expressed the opinion that, if housing starts begin to decline, that will be the time to administer the necessary economic hypodermic. In-

dustry members point out that, if such first aid is delayed until 1954, it would not take effect until 1955. Historically, political fortunes stand or fall with the economic well-being of the country. If the \$11 billion homebuilding industry is being depended upon to help sustain the economy through the 1954 elections, legislative steps must be taken a full year or more in advance of any downturn."

Frustrated buyers. To bolster its argument that Congress should act this year, not next, NAHB polled 1,500 of its 25,000 members, reported this result: 1,440 of them had met difficulties ranging from "slight" to "critical" in the past six months in finding nonvet buyers with enough cash to meet FHA downpayments. Just over 60% of would-be buyers, charged NAHB,

were turned away for lack of cash. Builders also fired a blast at FHA appraisals—a subject on which more and more builders have been complaining to HUD & HOME in recent months. Said the NAHB: "The most frequently voiced complaint from the reporting builders was that FHA valuations on their homes were based on out-of-date cost standards used by the agency. As a result, down-payment requirements in many cases are boosted further beyond the average family's

Besides an interest-rate hike and down payments, NAHB had four planks in its 1953 platform: 1) liberalized FHA loans for renovation of old homes, 2) liberalized home repair loans to encourage modernization of old homes, 3) slum rehabilitation through code enforcement, 4) faster urban development where slums are too large for rehabilitation.

Joint MBA-NAHB policy? One of the most hopeful portents in private industry effort to revamp housing laws was the decision by NAHB and MBA leaders to reconcile their separate housing programs into a united program. So far the attempt would get remained un- seen. But if the housing industry were to overcome its splintered factions, which drives costs up and helps retard technological progress, this seemed a good place to start.

Except for its position on Fannie Mae, MBA's views on housing did not seem too far away from those of homebuilders. Some MBA opinions:

Public housing—should be restudied to see if original objectives" have been fulfilled. If they are "still valid," whether conditions have changed that "the program should be abandoned or altered."

Redevelopment—"is primarily the responsibility of the housing industry and of the state and cities." Federal aid should be "limited" to a maximum of local initiative and a minimum of federal direction and control."

FNMA—something like the present agency should be required to provide a true secondary market. Fannie Mae should sell its assets to stabilize the business, be given no more money by Congress, and be reorganized toward private ownership.

Housing research—Statistics on housing starts and characteristics compiled by the Federal Labor Statistics are the government's first responsibility. BLS should have more money to do this. "there are serious doubts as to the adequacy of available statistics now being compiled."

FHA—Title I, Sec. 8 should be revised to allow loans up to \$7,000 (present ceiling: \$4,000) in addition to a new subsection for rehabilitation. The ceiling on Title II loans should be hiked to \$10,000 and varying down-payment requirements in Title II sections should be equalized. FHA should consider higher origination and servicing f

based on its own survey of what such underwriting practices on Sec. 207 (low-) should be "simplified and made . . ." Under Sec. 203, FHA should issue . . . one on the house as is and . . . on what it will be after renovation. . . . of open-end and package mort- . . . be adapted to FHA operations." . . . FHA and VA appraisal, credit exami- . . . property inspection might save builders . . . se, which is the extra cost of working . . . ncies. Congress should require VA to . . . underwriting facilities.

ns opposed. The US Savings . . . ague demanded an end to direct . . . age lending. President Charles . . . s called "absurd" the spread of . . . s to 84% of the nation's coun- . . . Feb. '53, News), especially for . . . a that was ballyhooed as a . . . when enacted in 1950. Said . . . "With an economic interest rate . . . ration between lenders and the . . . ink GI loans would be made . . . all areas."

uld the industry expect to come . . . welter of voices? Most of the . . . y in Congress, whose leaders

Urban Land Institute urges redevelopment divorced from housing, much expanded

by the new administration's . . . housing policies, the Urban . . . ute last month suggested three . . . revamping HHFA's division of . . . ance and urban redevelopment, . . . major expansion rather than any . . . of federal grants to cities . . . I of the Housing Act of 1949.

gely, ULI's position differed . . . views of NAREB, its parent or- . . . Last November, NAREB Presi- . . . h W. Lund urged outright . . . Title I. He explained: "In any . . . nt-in-aid program 50¢ of each . . . n away in bureaucracy; it gives . . . trol over city governments."

nation. Said the realtors com- . . . : "It is through the commercial . . . ial activity of the city that the . . . es most of its strength. . . . [Un- . . . Title I's] tie to housing has . . . the detriment of urban rede- . . . Therefore, Title I "should be . . . to provide more, easier federal . . . or projects involving commer- . . . ndustrial districts. Congress . . . he rule that areas must be pre- . . . residential either before or after . . . nt to qualify for federal funds. . . . redevelopment involves far . . . for housing, federal help never . . . been incorporated in a housing

cannot farm out basic decisions to com- . . . missions. Sen. Taft was already on record . . . as doubting "whether we need a housing . . . administrator." To his views could be . . . added important clues embodied in a . . . thoughtful statement of housing problems . . . by Rep. Jesse Wolcott (R, Mich.), chair- . . . man of the House banking committee who . . . was steadily growing in prestige as the . . . chief shaper of GOP housing legislation.

Talking to the American Bankers' Assn. . . in March, Wolcott said that under the Re- . . . publican policy "to restore free enterprise," . . . it is implied that "government is going to . . . get out of the housebuilding business." . . . Said he: "HHFA is rather a hodgepodge . . . of authority emanating from conflicting . . . emotionalisms. It could easily be cut back . . . to size. . . . If it is desirable to create a . . . secondary mortgage market, we will help . . . create it; but we will not make a secondary . . . market a primary market." Better use, he . . . thought, might be made of Home Loan . . . Banks. On credit, he observed: "We don't . . . see any logic in making real estate credit . . . so easy that it finally becomes so abundant . . . we have to institute controls to restrain it."

act, said ULI. "The agency to whom they . . . [cities] look for assistance, geared as it is . . . to the field of housing, is ill-equipped by . . . either legislation, or philosophy, or experi- . . . ence to evaluate the cities' proposals in . . . any but the housing fields." ULI ventured . . . these possibilities:

- ▶1. A federal Department of Urban Affairs consolidating agencies concerned with the economy of cities. This would be a counterpart of the Department of Agriculture. "It is unlikely, however, that the nation is as yet ready or willing to move in this direction," philosophized ULI.
- ▶2. Complete reorganization of HHFA into an Urban Development Agency, in which redevelopment would be accorded "its proper place with respect to its constituent elements including commercial, industrial, residential development and public uses."
- ▶3. Shift HHFA redevelopment to the Department of Commerce, which has historically been identified with urban planning and zoning, and already has the principal agencies concerned with other urban problems: the Census Bureau, Bureau of Public Roads, Civil Aeronautics Administration.

Prices continue to rise; steel hike in the offing

Materials prices were still rising slowly the . . . third month after decontrol.

Southern and northwestern lumber were . . . both up, but the Pacific Coast producers . . . said it was a moot point whether the

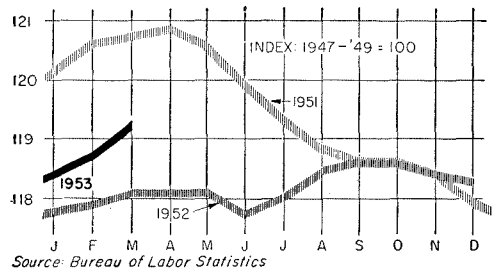

MATERIALS PRICES began to reflect effects of . . . price decontrol, rose to an average index of 119.2 . . . for March. This put them equal with the BLS' . . . July, 1951, average, although their range in the . . . entire intervening 20 months never exceeded 1.4 . . . points. The March rise stemmed from a fairly . . . wide range of increases, but mostly lumber, . . . cement, plumbing item advances.

stronger demand stemmed from the spring . . . construction pickup or extra orders based . . . on the threat of a strike by CIO woodwork- . . . ers. Two weaknesses underlay their market: . . . a mild winter kept production high; Cana- . . . dian mills have been flooding the East with . . . speculative shipments of construction . . . grades up to \$4 under domestic prices.

Basic steel prices remained unchanged, . . . but quotations for special items were being . . . advanced, and demand was heavy in antici- . . . pation of a general increase soon that might . . . average somewhere from \$4 to \$7 a ton.

Copper prices were sliding after their de- . . . control jump from 24½ to 32¢ a pound. . . . Last month, the price drifted back to an . . . average of about 30¢, was expected to de- . . . cline still further as the result of temporary . . . government stockpiling.

A very early BLS report from Atlanta at . . . month's end (based on April 15 data) said . . . building materials prices there advanced . . . "slightly," 15 of 44 items showing increases . . . from March 15, while five declined, 24 . . . were unchanged. The latest national BLS . . . index was up 0.5 points (see chart), its . . . second sharpest month-to-month gain in two . . . years.

US asks full repayment on H-bomb dormitories

Dormitory housing for Savannah River H- . . . Bomb project workers never achieved more . . . than scant occupancy (H&H, Sept. '52 et . . . seq.). Instead it spawned a plethora of . . . lawsuits. Last month Lyles & Lang Con- . . . struction Co. was suing for \$1.3 million . . . of unpaid claims from E. I. du Pont de . . . Nemours, AEC's prime contractor.

But du Pont, on behalf of the US, coun- . . . terclaimed for the entire sum of about \$1.9 . . . million paid to Lyles & Lang for erecting . . . the dormitories in 1950-52, or at least every- . . . thing over actual costs. The govern- . . . ment-du Pont suit charged Lyles & Lang . . . with an unauthorized joint venture opera- . . . tion that hiked costs unreasonably.

McGill conference studies industry integration efforts

At McGill University in Montreal, some 260 town planners, realtors, lenders, architects, engineers and builders gathered for a Construction Industry Integration Conference. Their objective: how to achieve lower costs and better structures by promoting greater coordination among the chaotically diversified interests concerned with construction?

In two days, more than two score speakers catalogued the historic disadvantages stemming from the industry's loosely coordinated nature. Sample: by Chicago Architect John T. Holsman, "The industry is a conglomeration of small units, small efforts; each project starts and ends with itself."

If stating the problem was easy, solving it was not. Almost everyone agreed that much coordination has developed where practical, and support would be forthcoming for almost any idea for more integration that promised tangible benefits.

Elusive goal. But except for unqualified approval for increased technical research few specifics emerged. The conference adopted a resolution requesting McGill, the United Nations, the Pan American Union and the Building Research Advisory Board to "take the lead" in formulating programs to spur the ideal. It appeared further integration would continue to come more by evolution and judicious marriages than by any long range blueprinted breeding programs.

House vs. auto. But if the conference worked no magic with one of construction's oldest problems it shed light on the shape of the task ahead.

Commented Gerry Golden, Sun Life Assurance Co. of Canada mortgage officer: "Since 1939 the price of a great many manufactured articles where there has been a great deal of integration has about doubled . . . whereas the price of a small house has about tripled. Whereas [today's] auto is a far better one than [1939's] . . . it is possibly open to question whether the house can claim the same distinction."

Said Detroit Planning Commission Director Charles A. Blessing: "In Detroit the average family income is approaching \$5,000. It seems that very few people have a car more than two years old. . . . In 1937 the city acquired a 300-acre tract and private homebuilders were extremely careful and active seeing that this was reserved for their [redevelopment] participation. They were going to demonstrate what pri-

vate initiative could do. There are still 100 bare cleared acres waiting for a [first] backer."

Explained President E. V. Gage of the Montreal Builders' Exchange: "The public would rather have a good car than a good home. That's all it amounts to." And from a teacher's plea for cheaper construction of

more schools of functional design was moved to report his own thoughts inspecting one of Montreal's newer elaborate high schools: "Are we right building such schools as this of the children coming to this school going to be dissatisfied with their when they go back."

PEOPLE: William A. Clarke and Wallace Moir to

MBA for 1953-'54; NAREB membership reaches 50,000

Vice President **William A. Clarke** of Philadelphia was nominated as next year's president of the Mortgage Bankers Association of America. For vice president, MBA nominated **Wallace Moir** of Beverly Hills. The nominations are tantamount to election at

Len Rosenberg



CLARKE

Cal-Pictures



MOIR

the MBA annual convention in Miami Beach next November. Clarke, president of W. A. Clarke Mortgage Co. is regarded as one of the nation's shrewdest mortgage market analysts. He was a Federal Reserve consultant on Regulation X credit controls and in recent years has often been MBA's principal spokesman before Congressional committees. He will succeed **Brown L. Whatley** of Jacksonville, Fla. Moir served with the Army Engineers in World War I, established his own mortgage business in 1927. He is a director of California Trust Co. and former president of the Los Angeles Economic Round Table.

Not often perplexed, Builder **William J. Levitt** announced he was stumped last month. As a result, he postponed plans for 1,500 \$18,000 homes in the Middletown Township portion of Levittown, Pa. Source of confusion, said Levitt, was the possibility Middletown would not cooperate with the Lower Bucks County Joint Municipal Authority, which has been taking over the water and sewage systems installed by Levitt, but would insist that its own authority operate the facilities in Middletown. Said Levitt: "I am bewildered and would like to become unbewildered. We won't go ahead until we know what's going on."

Shattering tradition, Chicago AFL plumbers appointed two youthful business

agents last month at salaries of \$10,000 each. They were **John J. O'Connell** and **James S. Finn**, 26. Both were plumbers, post-World War II appraisers.

Charles M. Mortensen, 42, manager and director of the Producers' Council since 1947, resigned to join the US Chamber of Commerce staff in Washington. He will work with **Henry P. Fowler**, manager of the chamber's trade association until Fowler retires in August. Mortensen succeeded him. Omaha-born Mortensen began his career as field engineer for the State Planning Board, later was principal relations man for Structural Clay Institute and California regional director for the American Iron & Steel Institute.

Former NAHB Executive Vice President **Frank W. Cortright** now operating in Sacramento, Calif. with Builder **Ed Egan** established a consulting service in the San Francisco Bay area and became executive director for the Mobilhome Research Institute of America. **John O'Neal**, former editor of NAHB, was named its merchandising manager.

To NAREB, **A. L. Canaday** of Astoria, Ore., was a milestone: its 50,000th member. Arkansas-born Canaday



CANADAY

first tried his hand in the real estate business in 1932-33 in Pennsylvania in 1932-33. After World War I he operated a machine shop in Newber (pop. 3,946) and then, on the other side, but in the pressure and the evening heart attack, a shift to le-

ous work. In 1948 he obtained a broker's license, on Feb. 5 joined the Hill County Realty Board "because if the profession was to really establish integrity everyone should belong to an association and make the ethics something." From his office-home he conducts a general realty business, farms and houses.

State realtor leaders, taken b

's announcement of Canaday's...
 ned an appropriate ceremony to...
 event this month. Membership...
E. Fred Kemner of Philadelphia...
 at 50,000 the NAREB member-...
 st trade group associated with...
 was now double that of 1945,...
 greater than in 1935. Next...
 AHB (26,400) which split off...
 EB 11 years ago.

President **John D. Biggers** as...
 and Executive Vice President...
MacNichol, Jr. as president of



MACNICHOL

nes-Ford Glass Co.; **William**
lano, FAIA, designer of many
 ountry houses here and abroad
 US Embassy in Paris, the Japa-
 ssy in Washington, member of
 Aldrich since it was founded in
 e recipient of the Gold Medal of
almadge C. Hughes, executive
 f the Detroit AIA chapter and
 gan Society of Architects, as
 f Michigan's board of registra-
 rchitects, professional engineers
 surveyors, succeeding **Wells I.**
 AIA, dean of Michigan Univer-
 ge of architecture and design;
 dent **George H. Schmidt** as
 Baltimore's Title Guarantee Co.
Guy T. O. Hollyday, new
 issioner; **Richard D. Hudson**,
 New Jersey and Florida home-
 NJ Home Builders Assn. presi-
 ding **Raymond E. Hanley** of
Eugene Stephenson of New
 resident and **H. Clifford Bur-**
 New Canaan, Conn. as board
 the American Institute of Dec-
lfred Sykes, chairman of the
 mmittee of Inland Steel Co. as
 the Chicago Housing Author-
 ng **Wayne McMillen**, resigned.

is ago New York City Sanitation
 er **Andrew W. Mulrain** said
 reets and sidewalks were "per-
 ty" and "in Manhattan the pub-
 a public dump." Last month,
 st **Edna Ferber**, arriving home
 e, called New York the "most
 filthy" city in the world, "a
 face of our country," Mulrain

changed his tune: an "insult" to his 10,000
 sanitation workers, the commissioner com-
 plained. Air Pollution Commissioner
Leonard Greenburg ruefully admitted Miss
 Ferber was "correct to a certain extent"
 about being unable to open her Park Ave.
 windows because of airborne soot and dirt,
 but said: "Many places are worse."

An out-of-court settlement last month re-
 solved a fee and services dispute between
 Architect **Cliff May** and San Francisco
 Homebuilders **Stern & Price** over the use
 of May's Cupertino House designs (H&H,
 Oct. '52), which won two NAHB awards
 for homes costing less than \$10,000 (two-
 bedroom model) and homes between
 \$10,000 and \$15,000 (three bedrooms).
 In cross suits May sought declaratory re-
 lief and interpretation of his contract, con-
 tended he was engaged only to design the
 prize-winning models being mass produced
 by the builders in suburban Cupertino.
 The builders sought \$1,500,000 in dam-
 ages, claimed they had the exclusive right
 to May's services in northern California.
 Under the settlement May and his Los
 Angeles associate **Chris Choate** received
 fees totaling \$45,000 for their copyrighted
 Cupertino design, were under no restric-
 tions in providing professional services to
 other homebuilders except in Santa Clara
 County and part of Alameda County.

Since January, when Harvard picked Archi-
 tect **José Luis Sert** to succeed **Joseph Hud-**
nut as dean of its school of design this fall,
 the world of design has been waiting for
 changes. Last month, it had the first
 guarded word from Town Planner Sert

himself. In his first Harvard speech, Sert
 announced that if money is available, he
 will reintroduce **Walter Gropius'** famed
 "master course" in design, scrapped in the
 conflict between Hudnut and Bauhaus-
 founder Gropius, who resigned a year ago
 as Harvard's architecture department chair-
 man. Sert said he thought three types of
 architects should be developed: the re-
 searcher, the builder and the city planner.
 "Functionalism alone is a blind alley," said
 he; instead, architecture must use the com-
 bined resources of the plastic arts to "em-
 body a way of life."

DIED: Lawrence Wolfe, 62, FAIA, de-
 signer of many Pittsburgh residences,
 churches and institutional buildings,
 former AIA Pittsburgh
 chapter president,
 March 10 in Pitts-
 burgh; **Henry D.**
Bates, 86, founder in
 1893 of *The Brick-*
builder, later renamed
 ARCHITECTURAL FORUM
 of which he was pub-
 lisher for about 10
 years, March 21 in

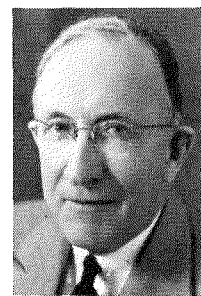

HUGGETT

Concord, Mass.; **Martin C. Huggett**, 76,
 executive vice president of the Chicago
 Metropolitan Home Builders Assn., former
 senior architectural examiner for FHA in
 Chicago, March 27 in Chicago; **J. Truman**
Streng, 56, Urban Land Institute trustee,
 Appraisal Institute governor and vice pres-
 ident of Massachusetts Mutual Life Insur-
 ance Co.'s mortgage division, April 8 in
 Fort Lauderdale, Fla.

(NEWS continued on p. 54)

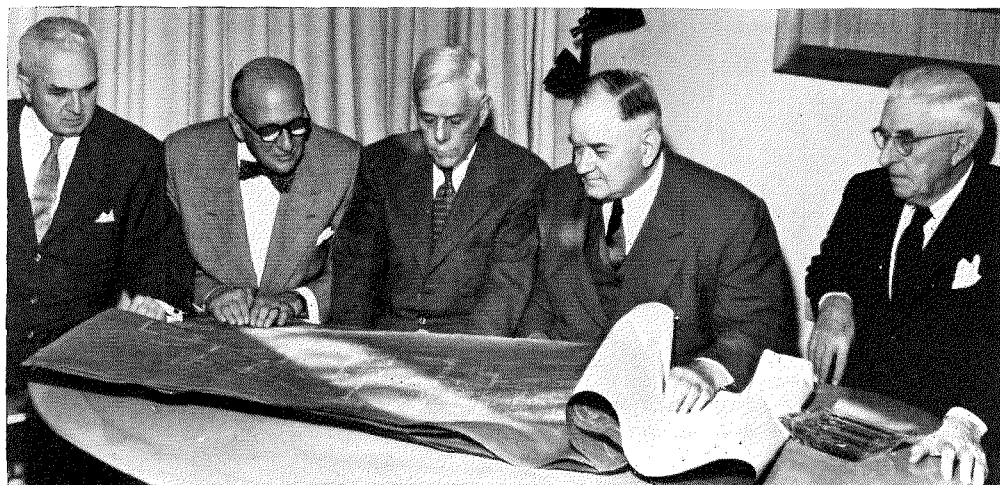

Texas leads the nation with Architects' Week celebration

To develop more public appreciation for the most
 frequently forgotten man in construction, the
 architect, the Texas Society of Architects
 started a Texas Architects' Week last year.
 It was adjudged highly successful and inexpen-
 sive public relations, and was repeated this year
 from April 13-20.

Typical local celebration: Houston's AIA

chapter named seven outstanding Houston archi-
 tects for special recognition, one for each day
 of the week. Five of these (l to r above) were
 John F. Straub, Kenneth Franzheim, Birdsall
 P. Briscoe, Alfred C. Finn and Maurice J. Sulli-
 van. Absent when the photographer called: Karl
 Kamrath and Harold Calhoun.

Philadelphia celebrated last year, not this.

KENFLEX

VINYL TILE

*combines every flooring advantage
in one beautiful floor*

PROOF THAT KENFLEX IS A TRULY SUPERIOR FLOOR

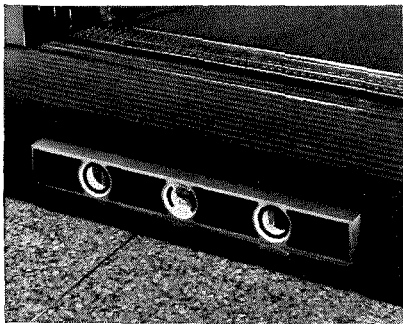

Thirteen years ago a test installation of KenFlex was made at the entrance to the elevators in New York's Union Carbon and Carbide Building.



Over 13,000,000 people have since walked over this KenFlex Floor and even with this heavy foot traffic, the KenFlex installation is still as smooth and attractive as the day it was installed.

New KenFlex is the result of years of experimenting and development at the Kentile, Inc. laboratories. It is made of asbestos, vinyl resins, plasticizers and selected color pigments . . . resulting in a long-lasting floor that is ideal for any use in any room. KenFlex increases the value of homes . . . the appearance of stores and shops . . . with its superior beauty and greater wearability. KenFlex is extremely resistant to grease . . . can't be harmed or stained by fruits, oils, and most other acids, inks and cleaning fluids. It is extremely easy and economical to maintain . . . never needs scrubbing . . . doesn't require waxing unless an exceptionally high gloss is desired.

Specifications and Technical Data

INSTALLATION

KenFlex can be installed over any smooth, firm interior surface . . . wood, plywood, radiant heated concrete slabs, even over concrete in contact with the earth . . . on or below grade.

THICKNESSES

Laboratory and on-floor usage tests have proven that vinyl has great durability and wear resistance. Therefore, standard gauge (1/16") is recommended for normal residential and commercial uses. Where ex-

ceptionally heavy traffic is expected, 1/8" gauge is recommended.

INSTALLED PRICES

Prices range from 40c per sq. ft. to 65c per sq. ft. depending on which of the thicknesses is chosen—for minimum area of 1000 square feet over cement underfloor.

SIZE

Standard tile size is 9" x 9". Also available are 9" x 9" decorative ThemeTile and 1" x 24" Feature Strip.

For more information on KenFlex consult the KENTILE, INC. Flooring Contractor, a trained and experienced expert, fully qualified to aid you in choosing the proper floor for every residential, commercial and industrial installation. For his name and address, look under FLOORS in your Classified Phone Directory.

KENTILE, INC., 58 Second Ave., Brooklyn 15, New York • 350 Ave., New York 1, N. Y. • 705 Architects Bldg., 17th and Sanson Philadelphia 3, Pa. • 1211 NBC Bldg., Cleveland 14, Ohio • Peachtree St. N.E., Atlanta 5, Ga. • 2020 Walnut St., Kansas C Missouri • 4532 South Kolin Ave., Chicago 32, Illinois • 4501 Fe Ave., Los Angeles 58, Calif. • 452 Statler Bldg., Boston 16,

from the INSULUX sketch book

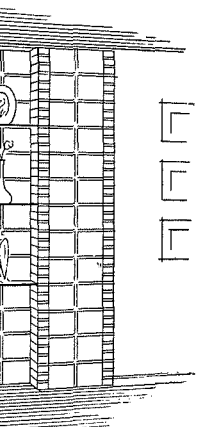

panels of 8"x8"
k-staggered
with brick
ins" between.
glass shelves
ek joints.

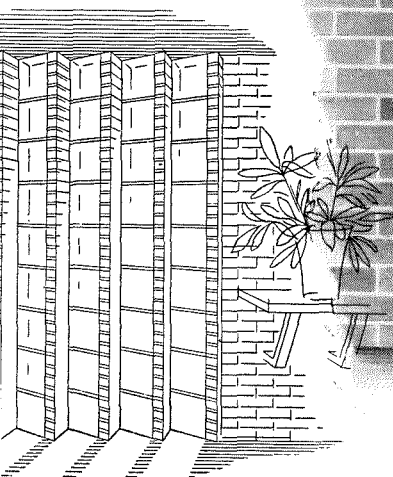

ting Light"-Interior Partition
2" glass block set at an
e with single brick "fin"
rators between each row.

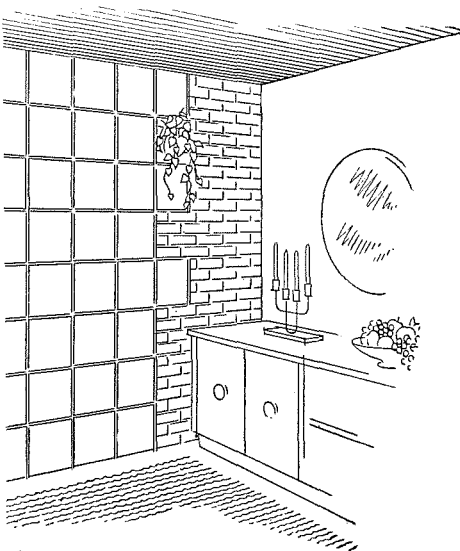

rom
ocks worked in with the
a face brick wall interior

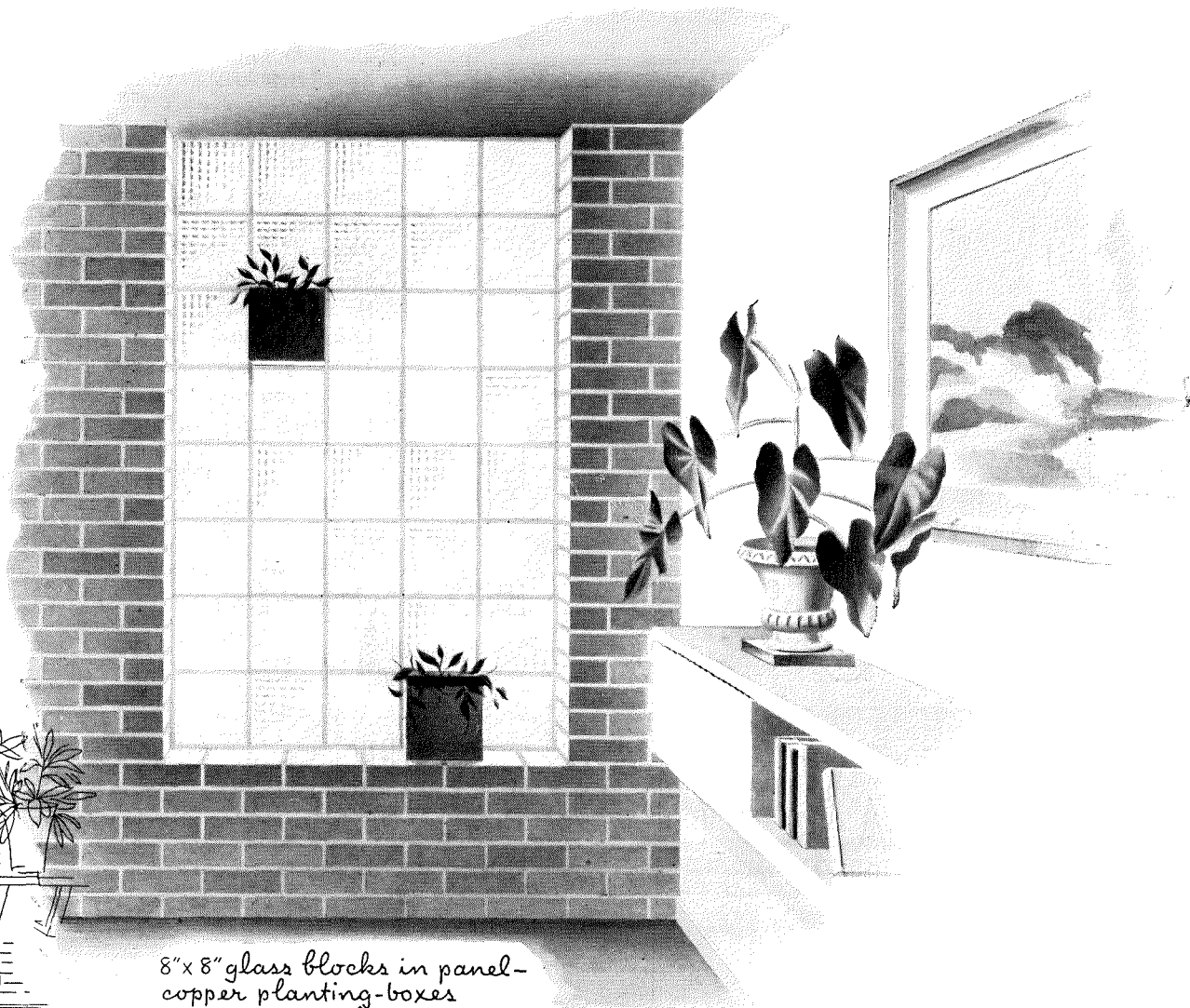

8"x8" glass blocks in panel-
copper planting-boxes
fastened to anchors in mortar joints

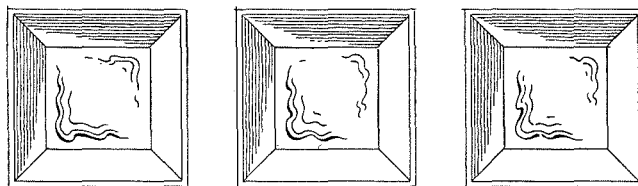

STAIR HALL
three 12" blocks with individual frames

include light...include privacy...include INSULUX

Insulux Glass Block® offers you opportunities to create new architectural designs that cannot be achieved with any other material.

For specifications using Insulux in these or other designs, write to Insulux Glass Block Division, Kimble Glass Company, Department MB-5, Box 1035, Toledo 1, Ohio.



KIMBLE GLASS COMPANY

Toledo 1, Ohio—Subsidiary of Owens-Illinois Glass Company

GUARANTEED to help you sell!

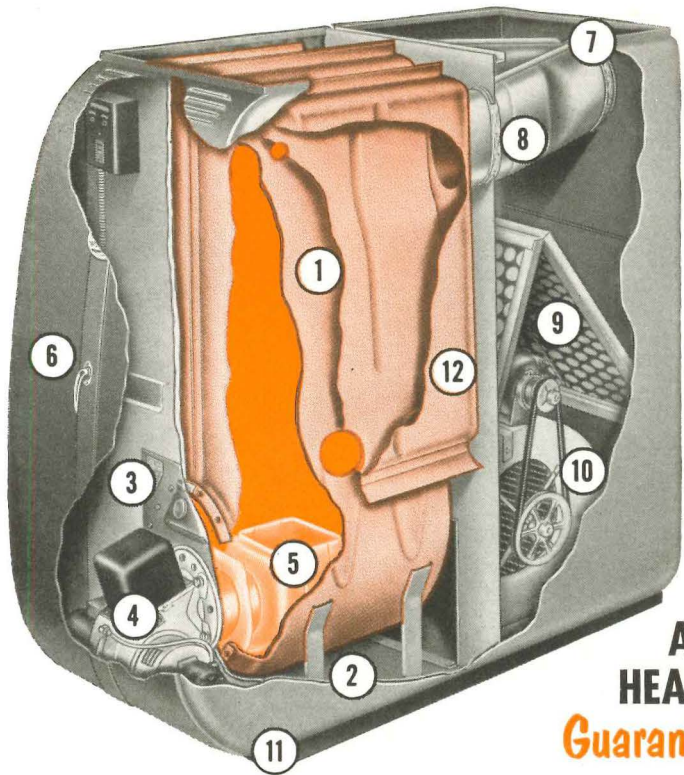

1. Improved Heat Exchanger Gives More Heat.
2. Aluminum Foil Faced Fiber Glass Insulation.
3. Burner Plate Easily Removed.
4. Oil Burner Interchangeable with Gas Burner.
5. Stainless Steel Combustion Chamber.
6. Removable Vestibule Door.
7. Single Exhaust Vent.
8. No Metal to Metal Contact at Division Panel.
9. Two Large Air Filters.
10. Quiet, Powerful Blower.
11. Solid Base with Leveling Screws.
12. Radiator Side Pans Increase Heating Surfaces.

**All MOR-SUN
HEAT EXCHANGERS
Guaranteed for 10 Years!**

MOR-SUN AUTOMATIC WARM AIR HEAT

You have no heating guarantee problems when your homes are equipped with MOR-SUN Warm Air Conditioners. You have no guarantee worries because MOR-SUN backs up the Center of Efficiency of its furnaces with a bona fide 10 YEAR GUARANTEE on all its Heat Exchangers. Other elements of the MOR-SUN Furnaces carry a one year guarantee. The improved MOR-SUN Heat Exchanger means added value, too. It is seam welded of heavy gauge steel and engineered to give top performance with MOR-SUN Gas or Oil Burners. Its larger radiation surfaces step up heat transfer — deliver more heat per fuel dollar. MOR-SUN Furnaces are the "answer" for Builders who demand *more quality* in their homes... they are guaranteed so that your selling will be easier.

Distributed throughout the United States and Canada



MOR-SUN Summer Air Conditioners

Available in two and three ton capacities with built in plenum and damper control to switch from cooling to heating when used with MOR-SUN Furnaces.

For MORE VALUE with MOR-SUN ... Mail this Coupon!



ALSO MANUFACTURERS OF ROLY-DOOR STEEL SECTIONAL GARAGE DOORS AND CARRY-ALL TRUCK BODIES

Mor-Sun Furnace Division, Morrison Steel Products, Inc.
607 Amherst Street, Buffalo 7, N. Y.

Gentlemen: Send illustrated booklet showing *inside reasons* why MOR-SUN Warm Air Furnaces add VALUE to my homes.

NAME.....

ADDRESS.....

CITY.....ZONE.....STATE.....

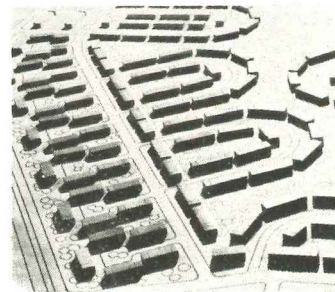

DE LUXE ROW HOUSES could be developed in patterns like the modern Philadelphia in patterns like the modern were developed with curved streets proposed new zoning classification. council zoning committee postponed plan, Builder Alfred P. Orleans for a 1,041-unit, \$10 million project. Footwalks in the rear would lead to reach a new school without crossing

Philadelphia tries to monotony in row

For years, nine out of every ten Philadelphia dwellings, gridiron block, were conventional iron block, were conventional 16' wide with a small terrace and a driveway in the rear. The city had 27% of the nation's row houses. But land zoned for row houses is low. Last year row houses were only 65% of Philadelphia homes.

Hoping to avert an impending executive Director Edmund N. Bacon, Philadelphia's Planning Commission years with architects, building groups to improve row house zoning, monotony and opening up more light, air and sun. In March, with realtor and planning, the planning commission the result for city council: Bacon: "The Philadelphia row houses of the most economical building the normal American family has been invented. The main thing here is the way it has been built. The endless monotony with no decent play space for children, are the things that have given it its bad name."

Bacon's plan would require a gap or breezeway between most of ten units, setbacks of 15 feet, rear yards of 20' instead of 10'. The direction of garden apertures, an ideal new pattern might be achieved by building throughout the courtyard.

Strife and dissension. The Philadelphia Housing Association Council on City Planning, a score of neighborhood organizations in the northeast area, which

remaining vacant land, pro-
to the city council that curved
not be mandatory, insisted
on blocks the new classifica-
result in only a minor modifica-
s row house monotony.
by the clamor, and recently
ow over construction of an in-
e council zoning committee
he plan.

**crets houses begun
es, Canada, Hawaii**

h, 206 homebuilders in the
ada were building NAHB
ts houses. A builder in
recting one with an orchidars-
s to NAHB exceeded 2,600,
sters from Greece, Italy,

a month's coaxing (and a
the city) were necessary be-
Albert Balch obtained special
build the structure—exemp-
ordinance requiring that an
nsed in Washington design
building. On Long Island,
most competitive housing
ler & Frank, began a version
sq. ft. house. All in all the
house was going up in 40

**codes spreading;
osts BOCA's rules**

three major regional building
ng last month at a paradox-
ndation of NAHB Code Com-
an E. J. Burke Jr. "to ward
oward adoption of a national
proposed adopting the basic
Building Officials Conference
as NAHB's official national

outhern Building Code Con-
M. L. Clement: "A regional
ly answer for sound and safe
construction costs . . . It cer-
ot rest with a national build-
r over 40 years we have had
(continued on p. 60)

L CODES SPREAD IN '52

Conception date	Total City adoptions	Increase since 1/52	Total Pop. (millions)
1927	660	33	22
1905	550	42	—
1945	463	71	16
9/50	125	35	5
11/49	2,000	1,355	95
6/51	726	489	5

Roly-Door helps sell these homes



MORRISON

Roly-Door

STEEL SECTIONAL GARAGE DOORS

Well known Long Island Builder says:

"There is no doubt in the minds of our sales force that Roly-Door has been beneficial in the sale of many of our homes."

Norman Kaye, Kay Manor, Inc.



The most successful builders know that their public appreciates real value so they build value into their homes. Kay Manor, Inc. is a good example. They tell us "... we have never used a product that gave us as much satisfaction as your Morrison Roly-Door. Every purchaser of a home in our Sylvia Park development has marveled at the finger-tip operation and modern beauty of this Steel Sectional garage door."

The lasting beauty of the Morrison Roly-Doors harmonizes with the modern trend to make the garage a part of the architectural design. It makes garages a very practical selling feature of the home. Roly-Doors can give added value to the homes you build and make your selling easier. Take advantage of their practical Selling Power. Their installed cost is low — their value high.

ONLY ROLY-DOORS GIVE YOU ALL OF THESE ADVANTAGES

- Four Sectional, Overhead Steel Garage Doors.
- Will not rot, warp or absorb moisture.
- Quiet, free rolling, ball-bearing operation.
- Rugged, welded steel construction.
- Low installation cost.
- Conforms to any style of architecture.
- Infra-red baked prime coat.
- Can be painted with regular house paint in your choice of color.
- Pin tumbler locks. Cylinder is keyable to fit home doors.
- Meets all Building Codes.
- Three sizes — 8, 9 and 16 foot.



For complete information see your Roly-Door Distributor or -

Roly-Door Division
Morrison Steel Products, Inc.
646 Amherst Street, Buffalo 7, N. Y.

Gentlemen: We need more information on Roly-Doors for Quality Homes.

FIRM NAME

ADDRESS

CITY.....ZONE.....STATE.....

In Canada, Roly-Door Distributors, Ltd., 1330 Bloor, W., Toronto 4.

ALSO MANUFACTURERS OF MOR-SUN FURNACES AND CARRY-ALL TRUCK BODIES



The Heart of Gunn Hotpoint

The Talisman. Based on designs by the nationally famous residential architect, Henry Hill of San Francisco.

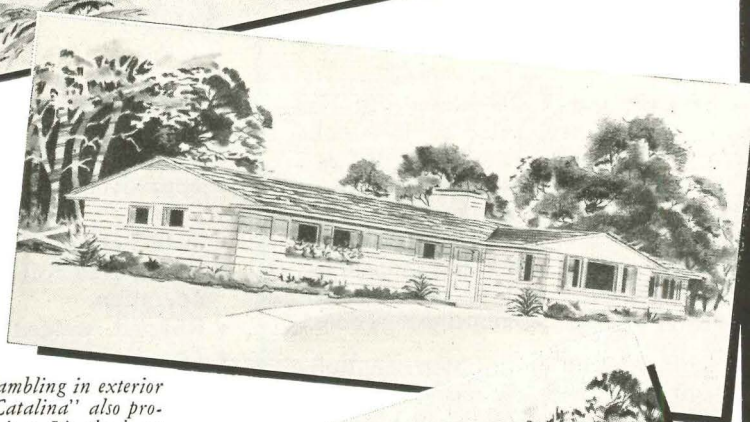
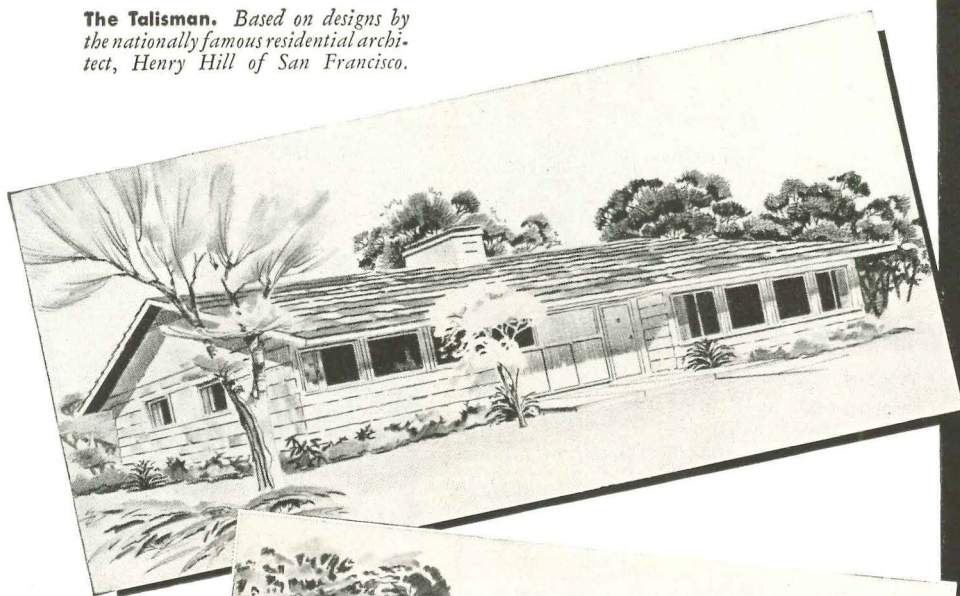

The Catalina. Rambling in exterior appearance, the "Catalina" also provides spacious interiors. It's the home with the look of tomorrow.



The Coronado. Well-planned rooms, large picture window, wide roof overhang and sweeping horizontal lines... features that are capturing the fancy of home buyers.

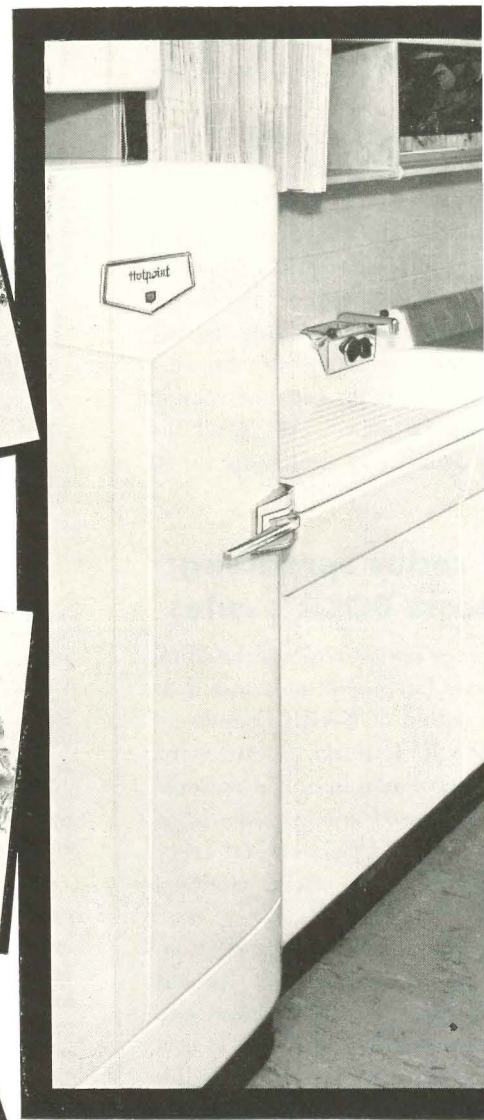

Hotpoint

RANGES • REFRIGERATORS

DISHWASHERS • DISPOSALS® • WA

It will pay you to go **copper** all the way!

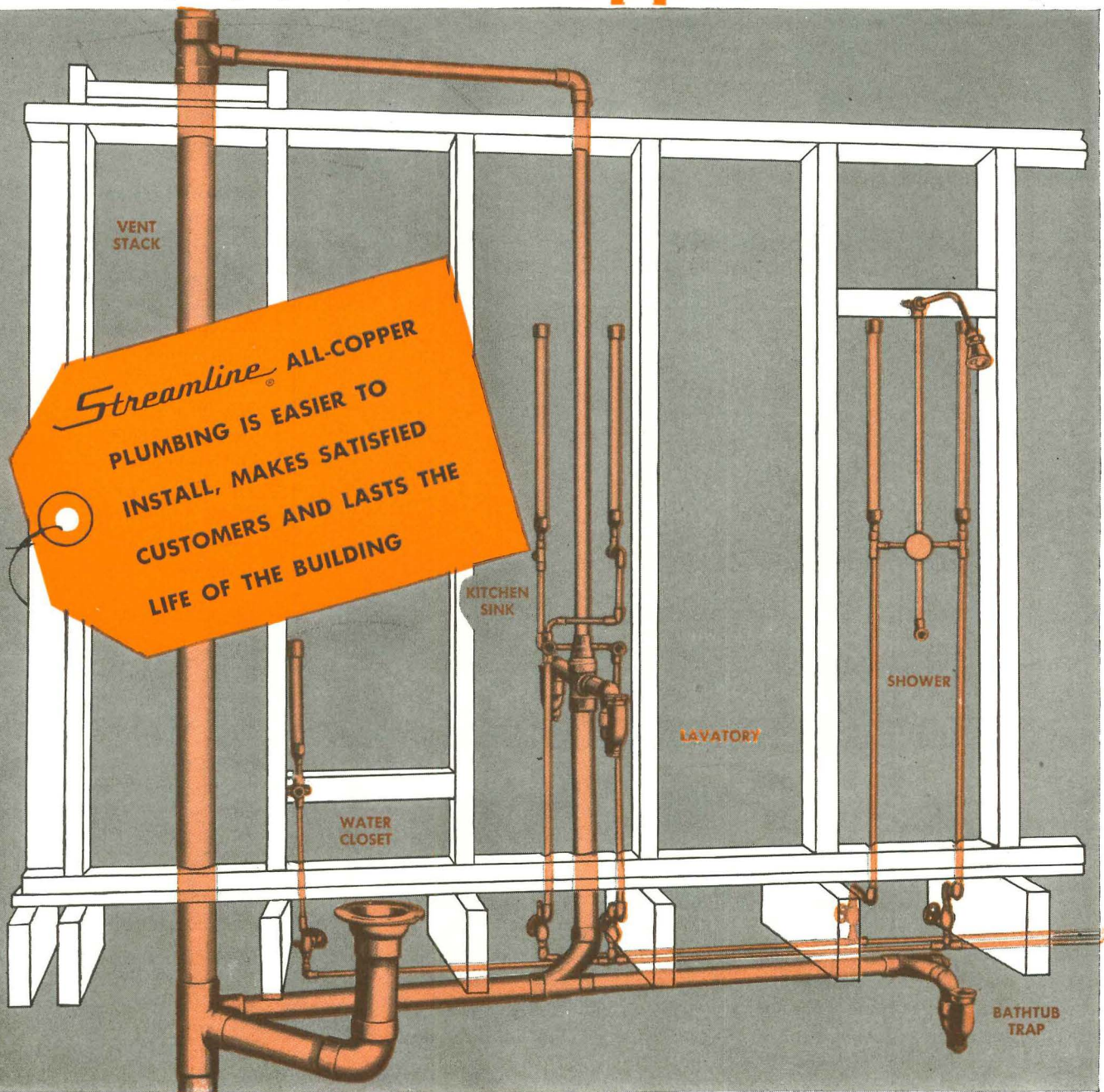

helps sell houses faster—houses sell faster and usually command better prices when they have Streamline copper drainage and supply plumbing. Home owners know that all-copper plumbing makes a neat, space saving installation and gives a lifetime of trouble-free service.

makes an efficient, lasting system—Streamline Copper Drainage Tube and Fittings make a tight, completely sanitary system with clean, unobstructed joints that withstand jars and vibrations and are clog resistant. Such a system resists the destructive effects of corrosive acids and will not rust. Ordinarily, Streamline all-copper plumbing will outlast the building in which it is installed and never need repairs.

costs no more—Plumbers can install Streamline copper supply and drainage lines in less time than a cast iron and steel system. Construction costs are also lower because all tubes will fit in a standard 2 x 4 partition—needs no furring or framing—thus actually increasing the cubical content of the building. These savings in installation largely offset the slight additional cost of copper tube and fittings and often make it possible to install Streamline all-copper plumbing for less money.

Write today for our latest catalog of Streamline Plumbing and Heating Products.



99-A

MUELLER
BRASS
CO.
STREAMLINE
PRODUCTS

MUELLER BRASS CO. PORT HURON 6, MICHIGAN

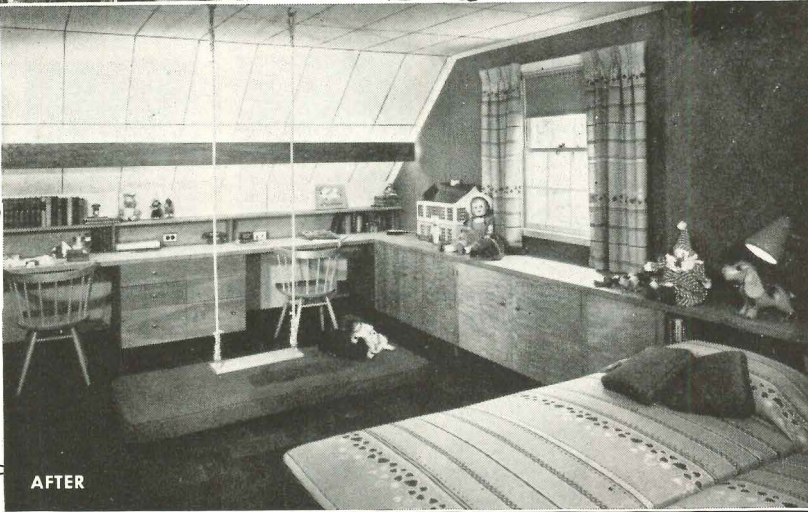
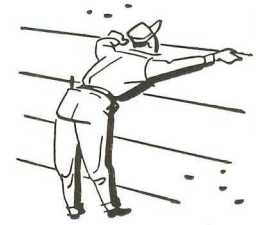

**TRANSFORM
DEAD SPACE...INTO
LIVING COMFORT**

Specify **FIR-TEX** Insulating Boards and Tile

Here is a versatile interior finish that lends itself ideally to the most exacting construction demands. Fir-Tex Insulating Boards and Tile go on fast, save time, labor, and cost. For designer, homeowner, and builder Fir-Tex provides the lasting satisfaction of a job well done. Check these qualities and you'll agree — *it pays to recommend Fir-Tex!*

- Light, easy to handle.
- Covers large areas fast.
- Insulates as it builds; reduces noise, seals buildings against heat, cold, wind and dust.
- Makes for clean, efficient application; leaves no mess.
- Practically eliminates waste.
- Termite-proof.

Asphalt Impregnated Sheathing
Seals your home against heat, cold, wind, dust, and noise. Impervious to moisture and decay. Has greater bracing strength than ordinary sheathing.



Backer Board
Fir-Tex Backer Board eliminates the slow, time-consuming job of undercourse shingling, and building paper application. It adds insulation, cuts building costs, gives a smoother, neater appearance. It adds beauty with uniform, deep shadow lines; is asphalt impregnated.

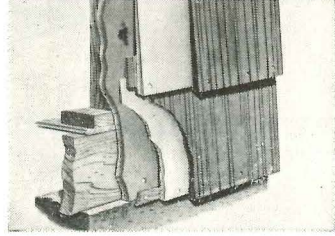

Fir-Tex Insulating Boards and Tile beautify as they finish, insulate as they build. For quality construction at minimum cost and effort, urge the use of Fir-Tex.

FIR-TEX

**Exclusive Sales Distributors
DANT & RUSSELL, Inc.
Portland, Oregon**

the same thoughts on national of them has succeeded. . . . T one basis for unification of b and that is on physical prop live loads. . . . Climatic facto portant part [making a nation practical] . . . The quicker ex izes this the better will be t the building industry."

Climate arguments. BOCA dentally belongs to the Joint on Building Codes, which view, proclaims that "climat and other factors may justif in requirements in different re in turn the Joint Committee ha by the US Chamber of Comm also urges local communities four major codes, does not si for special recommendation. I city of San Antonio, Tex. (p is the biggest operating unde Coast Building Officials Com form building code.

Mounting adoptions. Since HOUSE & HOME survey show major regional codes have ga adherents, the National Electr ing Codes 1,844 more. Highl

► **PCBOC**-All Atomic Energy Comm use the PCBOC code, which also code of Japan, according to Man Hal C. Colling. Since Jan. 195 adopted by San Diego and B Spokane; Tacoma; Tucson, Ar Alaska, and Wayne County, Mich reported adopting the BOCA code.

► **SBCC**-This code is reducing sou tion costs "beyond imagination," Clement. New subscribers: Birn Nashville and Knoxville, Tenn.; thirty-two other ratifications are pe

► **BOCA**-Basic Building Code Co E. Strehan reported distribution of the BOCA code since publicatio ratification by a total of 125 comm and St. Paul pending), and asso ship in 500 municipalities.

Fire underwriters' stand. adopting the National Board derwriters code since Jan. Charleston, S. C.; Englewoo field, N. J.; Burlington, Vt.; Bellport, Miss. In February distributed answers it gave series of questions an Americ Assn. committee asked abou fire insurance rating procedu this exchange:

"Is there any valid reason for National Building Code? Are codes equally good? Does not N

(contin

MENGEL *Mahogany*

FLUSH DOORS

WILL DELIGHT

YOUR CLIENTS—



YET COST LESS THAN MANY DOMESTIC WOODS!

Mahogany!—the very word suggests the ultimate in luxury, beauty, good taste, desirability.

Now The Mengel Company offers you the magic of Mahogany — doors of genuine African Mahogany — *at less cost than for comparable doors faced with most domestic woods!* Get all the facts today!



Door Department
THE MENGEL COMPANY
Louisville 1, Kentucky

4 MILLION

windows equipped with this
ORIGINAL sash balance



MASTER "NO DRAFT" SASH BALANCE

THE BUILDER'S CHOICE!

Builders throughout the United States, and many parts of the World—from South Africa to Alaska—insist on MASTER NO-DRAFT SASH BALANCE on all homes they build.

This "Original" combination weatherstrip and sash balance unit has been *proved and tested* on over 4 Million windows—under all atmospheric conditions—for nearly 15 years.

Builders KNOW—after many years of experience—that this MASTER unit is easy to install—efficient—durable—reliable—and superior to all others. They fit both Old and New windows. All ropes, chains, pulleys, and weights are eliminated. No more leaky and expensive box frames—simple plank frames will do the job. Mullions can be narrow and trim. Dust, dirt, sand, wind, and cold are kept out.

MASTER NO-DRAFT units MEAN—

- Simple and Efficient Windows
- Better Quality Homes
- Lower Construction Costs
- Greater Sales Appeal

Write today for full information. Learn why. Builders have accepted this MASTER unit as the *Standard of Quality!*

MASTER METAL STRIP SERVICE, INC.
1724 No. Kilbourn Ave., Chicago 39, Ill.

Please send me description and installation data about Master No-Draft sash balance and weatherstrip combination units.

Name _____
Address _____
City _____ State _____

MASTER THRESHOLDS - RIB STRIPS - CAULKING - TOOLS

the improvement of other codes
use of its own code?

"The other . . . codes are not the code sponsored by NBFU. The mental differences dealing with construction features designed to prevent fires which cause conflagration. In grading any city the NBFU item by item with existing codes enforcement is also considered. for existing favorable conditions percentage of fire-resistant roofs are poorer than those provided by the code. If the city does not meet the standards then the city will not only lose points now, but it will receive a points progressively as structures deteriorate.

"Many owners may be willing to pay for fire insurance because it is cheaper than to build or rebuild today. However, substandard construction men to risk their lives and the people working in such places to take the

Utility codes spread. San Antonio marked the spreading adoption of the National Electric and Plumbing code. The electric code was adopted in San Antonio and throughout the state of Texas (except Boston). The code was ratified in Jacksonville, Fla.; Albany, N.Y.; St. Petersburg, Fla.; Albuquerque, N.M.; Baton Rouge, La.; Phoenix, Ariz. Denver adopted the code.

Following New York's lead, New York City was completing the drafting of its new code (reported closely following the California code) that municipalities could use as a reference. California received a four-year study of conflicting building laws by a legislative committee headed by Pasadena architect A. I. Stewart. A ten-man committee including an architect, engineer and contractor was recommended. Its first task was to start preparing a state building code.

Builders convert C into housing sales

In Springfield, Mass., the Home Builders Contractors Assn. converted its president Herman Greenberg into a private housing salesman. At a recent meeting, Greenberg began to arrange for the purchase of homes priced under \$10,000 a unit. He said "I would buy every single lot of real estate people would build for \$8,000." Builders handed him a list of homes from \$8,200 to \$11,000, advertised in newspapers, said they would buy 50 numbers of homes for \$8,000 orders.

"Maybe we looked in the wrong place," said Greenberg. He began to convert builders' sales and rental to his members.

e of rapid strides made
 any industrial fields,
 better homes are being
 emphasize long-range
 design and livability.
 rebuilding that is more
 al and progressive is
 attributable to the
 s and builders who
 king in terms of the
 public's . . .

what is there in a
 home that Sells?

Pleasure"

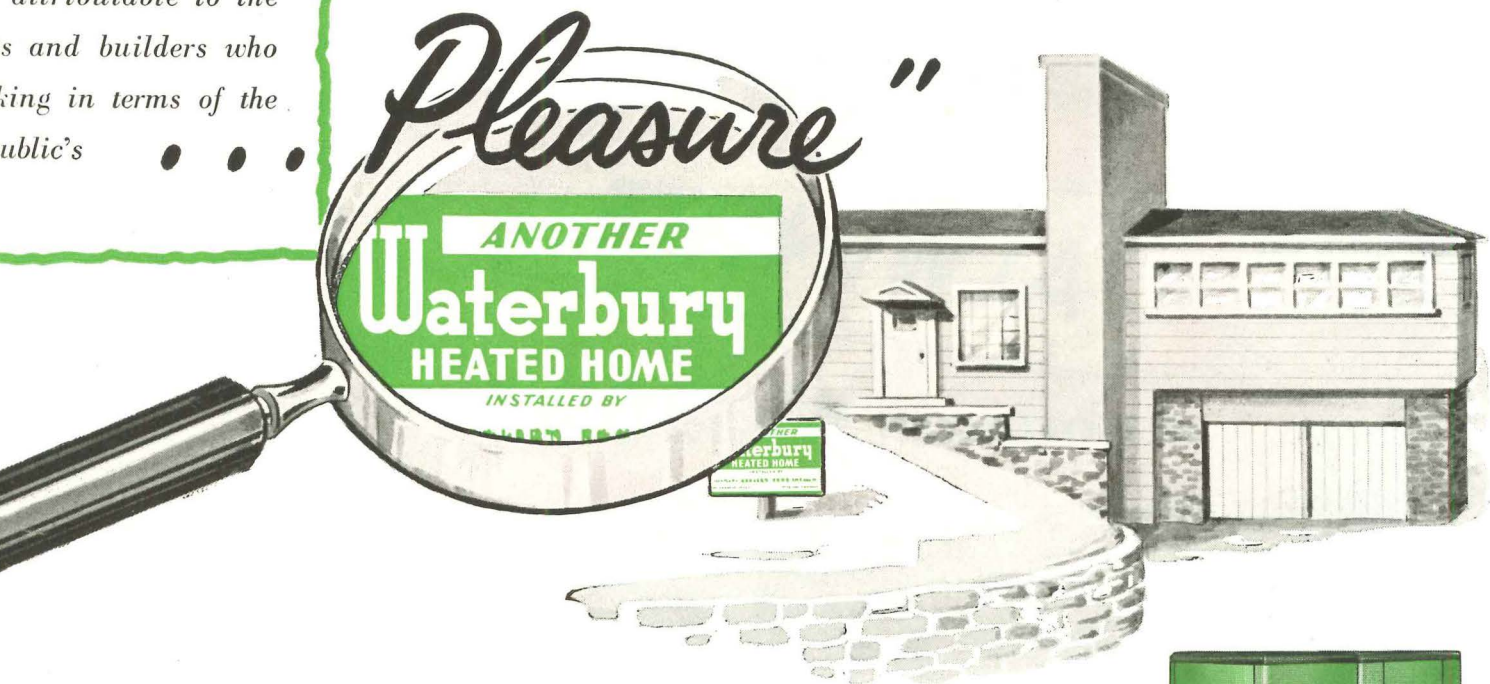

me where joy is unconfined...the year 'round

house ramble; give it style, freedom and all of the
 that contribute to the pleasure of home ownership . . .
 early Waterbury warm air heating. With Waterbury
 and winter air conditioners—balanced to a perimeter
 heating system—a flexibil-
 some design and construction
 uced that handily meets all
 r's family needs for living
 and pleasure.

a Waterbury for every
 e and every type of fuel.

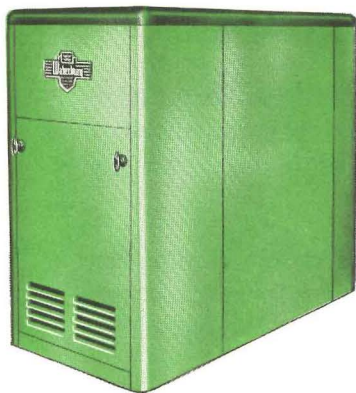

"Because of rapid strides made
 in the many industrial fields,
 new and better homes are being
 built to emphasize long-range
 value, design and livability.
 . . . Homebuilding that is more
 functional and progressive is
 directly attributable to the
 architects and builders who
 are thinking in terms of the
 buying public's . . .

what is there in a
 home that Sells?

Pleasure"



The home where joy is unconfined...the year 'round

THE Year 'round AIR CONDITIONER

brings plenty of pleasure into any lucky
 owner's home—the fresh delight of ideal
 summer climate and constant, even warmth
 for the winter.

Built in capacities up to five tons, the sum-
 mer assembly is easily added to Waterbury
 furnaces and winter air conditioners already
 installed.

46 YEARS OF



WARM AIR HEATING

Waterman-Waterbury Co.

KSON ST. N. E.

MINNEAPOLIS 13, MINNESOTA

*Trade Secrets house by Wallace Arters, Media, Pa., featuring ALWINTITE aluminum windows.

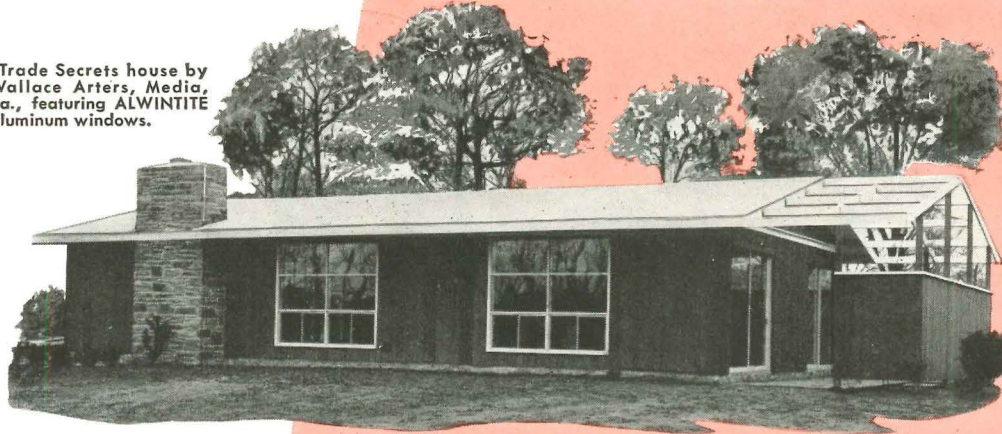

TODAY'S OUTSTANDING HOUSES

feature

ALWINTITE

aluminum **WINDOWS**

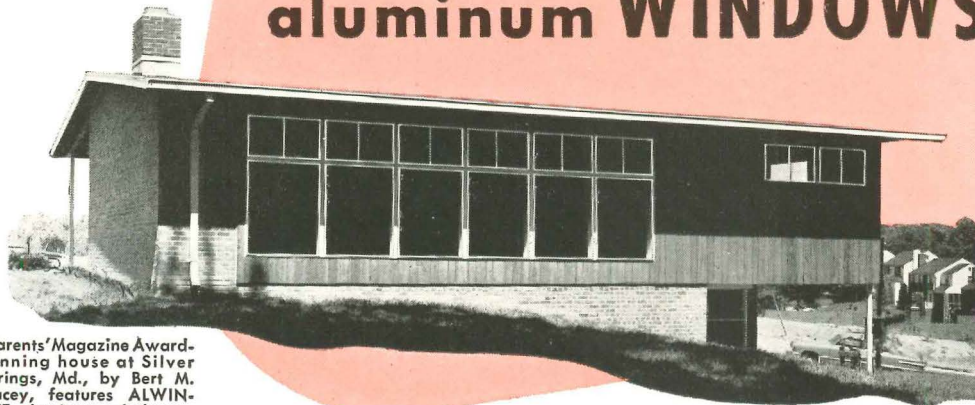

*Parents' Magazine Award-winning house at Silver Springs, Md., by Bert M. Tracey, features ALWINTITE aluminum windows.

DOUBLE-HUNG and PICTURE WINDOWS

SLIDING and PICTURE-SLIDE WINDOWS

VIEWall PICTURE WINDOWS

■ Wherever you go—east, west, north or south—you'll find ALWINTITE aluminum windows featured in many of today's outstanding houses—houses that win awards as well as customers.

ALWINTITE offers builders a complete line of modern, smart looking windows that add to the attractiveness of any house—regardless of its style, color, size or location.

Because of their design, their quality construction and their many other outstanding features, ALWINTITE aluminum windows add extra "Sales Appeal" to any house you build.

For complete information on the entire ALWINTITE line and name of nearest dealer, write Dept. HH-5.

ALWINTITE DIVISION
GENERAL BRONZE
 CORPORATION
 Stewart Avenue, Garden City, N. Y.

EVENTS

National Savings & Loan League's convention May 10-14, Chase and Hotels, St. Louis, Mo.

National Housing Conference's 22nd ing May 11-12, Statler Hotel, Wash

Heating, Piping & Air Conditioning National Assn.'s 64th annual co 13-16, Edgewater Beach Hotel, CH

National Association of Home Bu Board of Directors meeting, May 2 flower Hotel, Washington, D. C.

"Reunion of Architecture and Engine sonian Institution's traveling exhib State College, Manhattan, Kan., Joslyn Art Museum, Omaha, June seum of Cranbrook Academy of A Hills, Mich., Sept. 1-22.

National Association of Building Own agers' 46th annual convention J Pittsburgh.

Boston Art Festival for 1953, presen sculpture by leading New Englan be held on eight full days and e 7-14, on the Public Garden. Festiva Boylston St., Boston.

National Store Modernization, Build nance Show, Madison Square Garde June 9-12. Included will be exhib ning designs in nation-wide compe or modernized shopping centers, st shops, etc.

Forest Products Research Society's 7th ing June 15-17, Memphis, Tenn.

AIA Board of Directors' annual mee 19, Olympic Hotel, Seattle, Wash.

The American Institute of Architects vention, June 16-19, Olympic H Wash.

Competition—in connection with fou of the city of Sao Paulo, next wi national exhibition of architecture at the Sao Paulo Museum of Moder architects of all nationalities and to ognized schools. Awards in 11 cate special prize to a young (under and to a school. Submissions no 1 15. For information, address: I Museu de Arte Moderno de Sao de Abril 230, Sao Paulo, Brazil.

National Home Week dates set by N 20-27. Prominent among display l the Trade Secrets house developi mittee of leading NAHB builders. is a big upswing in air-condition

American Bankers Assn.'s 79th ann Sept. 20-23 in Washington, D. C.

National Electrical Industries Show Sept. 29-Oct. 2 at the 69th Reg New York.

American Gas Assn.'s annual co 26-29 at Kiel Auditorium, St. Lou

National Association of Real Estate convention Nov. 8-14, Statler and tels, Los Angeles.

Mortgage Bankers Association of A convention Nov. 13-19 at Miami junction, a home show conducted offering services or manufactur lating to homebuilding.

**ALUMINUM MAKES A
WONDERFUL
DIFFERENCE IN HOMES**

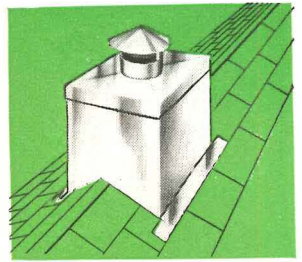
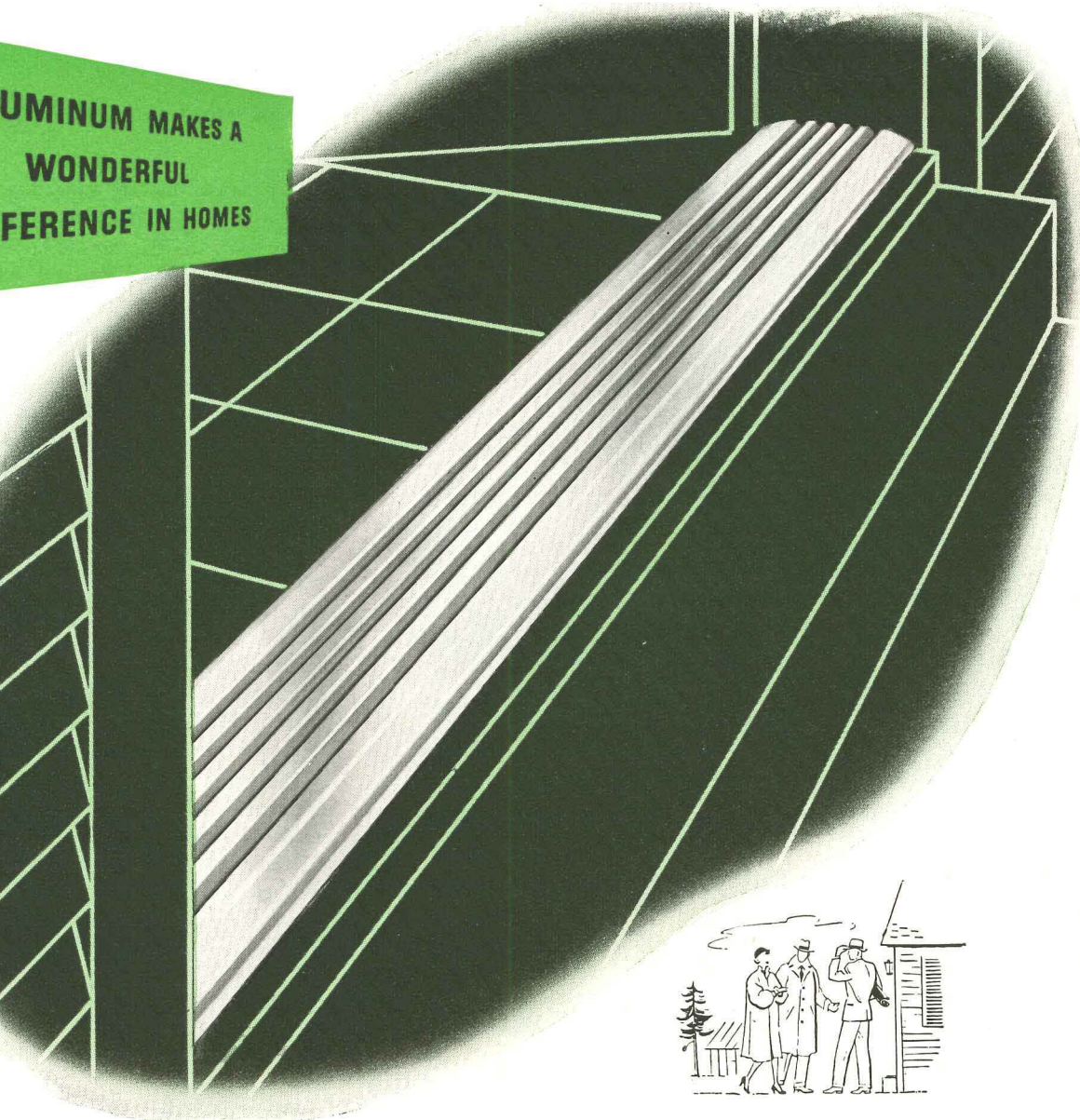

Aluminum chimneys are light in weight, easily fabricated and erected. Reflect heat and resist corrosion.

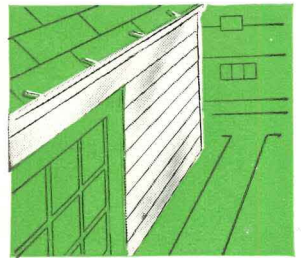

Aluminum siding is easy to work with and install. Won't rot, warp, shrink, swell or crack. Fire resistant.

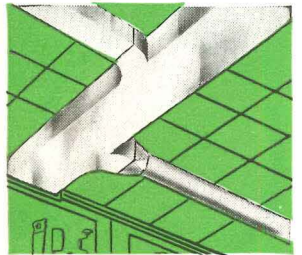

Aluminum ductwork is easy to handle and install. Won't rust, is a natural insulator, minimizes heat loss.

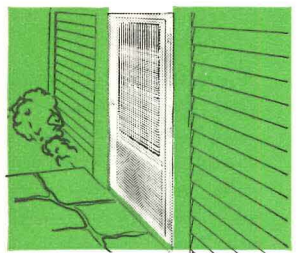

Aluminum combination doors are rustfree, rotproof, attractive, convenient. A mark of quality in modern homes.

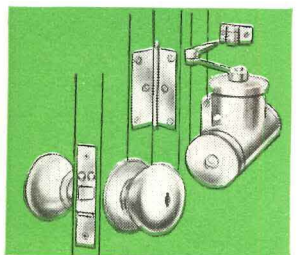

Aluminum hardware's lustrous natural color in a wide range of finishes matches all decorative schemes.

ALUMINUM THRESHOLDS HELP YOU BUILD BETTER, SELL QUICKER!

Aluminum is the modern building material with a "two-way" advantage that benefits both builder and buyer. For example—lustrous, attractive aluminum thresholds are the first assurance of quality design in entering any building. They are economical in initial cost, require no maintenance and are available in a variety of Reynolds designs that provide a type for every entrance or between rooms application—including pivot door installations.

Furthermore, aluminum's strength, light weight, ease of fabrication with regular carpenter tools, long life, availability and

other advantages—both in special designs and standard products—help you build better homes. These homes sell easier and faster because buyers quickly recognize that they are getting *more for their money*.

Remember—for help on your building material problems, call your nearby Reynolds Architectural Distributor listed under "Aluminum" in the classified telephone directory. For more information on the many uses and advantages of architectural aluminum in home construction, write Reynolds Metals Company, 2530 South Third Street, Louisville 1, Kentucky.

Send for free *Architectural Aluminum* catalog. For quick reference, see catalog $\frac{5a}{Re}$ in *Sweet's Architectural File*.

Be sure to see "Mister Peepers" every Sunday night, 7:30 EST, NBC-TV; hear "Fibber McGee and Molly" every Tuesday night, 9:30 EST & PST, NBC.

REYNOLDS



ALUMINUM

MODERN DESIGN HAS ALUMINUM IN MIND

FASTEST SELLERS

Sirs:

Welcome to the real reporting in the building field in "The Fastest Selling in the USA" (H&H Apr. '53). The construction business—like any business in a growing buyers' market—desperately needs the guidance it can get from the experienced customer. There is always room for new methods, design and ideas—but the building field needs not only this healthy competition but also to listen. And this is what your excellent article so deftly invites with its high praise from Dallas to Omaha to Boston.

Whenever one considers carefully the needs of the public does, how far it is willing to go for better are always surprises—as shown in the advanced planning in the St. Louis houses. Success so completely refutes the notion that contemporary design won't sell. The courageous use of full page color in advertising in Dallas, shows what can be done to create consumer interest on a large scale.

The total impact of this important contribution to current developments and the public's needs is bound to be stimulating and all the more so because you have withheld editorial opinion, letting the public create their own enthusiasm. Congratulations on this job of real reporting.

ALFRED STANFORD,
Benton & Bowles, Inc.
New York

Sirs:

Your report on best selling houses has raised the hackles on all good architects. Is this the best America can do?

How do you think the people who own these houses are going to feel 10 years from now? I can tell you—disgusted!

JAMES
James

Sirs:

If you are right and your best advice has any indication, we're growing up. The Codder is licked and people have learned that they want 20th Century houses for 20th Century lives. Your magazine has helped to summate this overdue revolution. For your part, one, congratulate you heartily.

GEORGE
Silver

Sirs:

Please give us more about how you have sold the fastest selling houses. We would like to know whether the houses you would like to know whether the houses you shown every day of the week, whether they were shown in the evenings and whether there were salesmen in the houses. How did the public hear about the houses? Radio advertising, road signs, classified ads? I would gather that financial terms

contin



Custom-Bilt Electric Ranges answer modern demands for flexible kitchen ar-RANGE-ments

Offer Beauty... Convenience... Freedom of Design

Today's trend in modern kitchen design with L&H Custom-Bilt, built-in, range units has taken the country by storm. These separate, self-contained cooking units answer the demand for free and easy kitchen efficiency... add exciting new beauty and appeal.

L&H Custom-Bilt units add but little to the cost of a home—provide a powerful new sales feature worth many times the original cost. And most leading manufacturers of kitchen cabinets have models designed to accommodate L&H Custom-Bilt Range units.



No. 5810 huge oven with Automatic Time Control and electric clock. Oven Temperature Control with automatic pre-heat, interval timer, appliance outlet, oven light. Heavily insulated with Fiberglas.

Inside size: 16" x 17" x 19 1/4".

Make your homes more saleable with these L&H Range Units

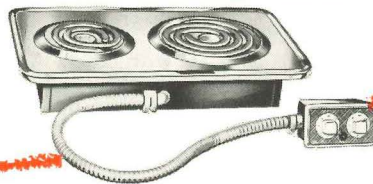

No. 5820-1 Surface Unit with two easy-cooking, easy-cleaning Monotube heating elements, one 8 inches and one 10 inches. Set in stainless-steel top for flush mounting in cabinet, bar or table. Switches may be located for most convenient access—signal light for each pair of switches. "Custom-Bilt"... the most versatile kitchen convenience ever designed.

See your L&H distributor Now or write direct

Manufactured by **A. J. LINDEMANN & HOVERSON CO.** 605 W. Cleveland Ave., Milwaukee 15, Wisconsin
Export: S. F. Appliances, Ltd. • Ridgefield, N. J.

Electric Ranges • Water Heaters • Refrigerators • Home Freezers

The finest in home appliances since 1875.



Keep your customers happy with
FLINTKOTE

COLOR

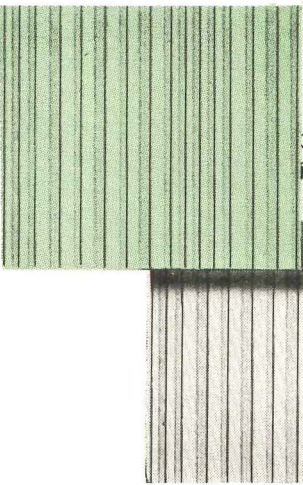

Put new life into homes!
Recommend colorful FLINTKOTE
roofing, sidings and
decorative interior board!

Are you taking advantage of the recent swing to color?

Everybody wants color . . . for modern, new construction, and for modernizing existing houses.

And we have just what they want.

Flintkote . . . *style leader of roofing for the building industry* . . . anticipating the trend, offers a wide variety of practical, pleasing colors and blends in asphalt shingles.

Also . . . popular, beautiful Flintkote Stri-Color* Asbestos-Cement Sidings have virtually revolutionized the siding industry. They have handsome, new colors for monotone or two-tone effects, or for combination with stone, brick, stucco, etc., and the famous DURA-SHIELD* water repellent, stain-resistant protective finish.

And . . . lovely new colors enhance our always popular line of Decorative Insulation Board and Tile. Use it to brighten up game rooms, attic bedrooms, libraries, etc. . . . and to hide unsightly walls and ceilings.

Get more color into your new and re-modeling jobs. You'll find it pays off well in profits and customer satisfaction.

May we send you illustrated literature?

THE FLINTKOTE COMPANY, Building Materials Division,
30 Rockefeller Plaza, New York 20, N. Y.

*A trademark of The Flintkote Company

FLINTKOTE



... *Style and Color Leader since 1901*

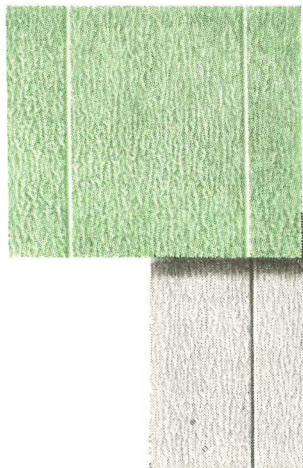

Two Good Reasons You'll Build BETTER KITCHENS WITH ELKAY...



STAINLESS STEEL



For Smart Appeal and Permanence include ELKAY *Lustertone*, the only sink guaranteed to outlast the home in which it's installed. The sterling beauty of *Lustertone* is an unmistakable mark of quality that reflects confidence in the builder—inspires a buying urge in every prospect. Find out about the new low prices on *Lustertone* stainless steel sinks—see just why it's an investment in sales appeal and permanent satisfaction you can't afford to leave out of your plans.

For Color—Convenience—Economy you can count on ELKAY *Duratone*, the all-new sink and cabinet top that combines colorful *beauty bonded* FORMICA with a permanent, rustproofed steel core. Custom-built in any size and shape—furnished with or without famous *Lustertone* sink bowls, or finished to combine with any sink. For the first time ELKAY brings you the economies of a factory-fabricated *Formica on steel* top with a guaranteed bond. Design better kitchens with *Duratone*.



FORMICA ON STEEL

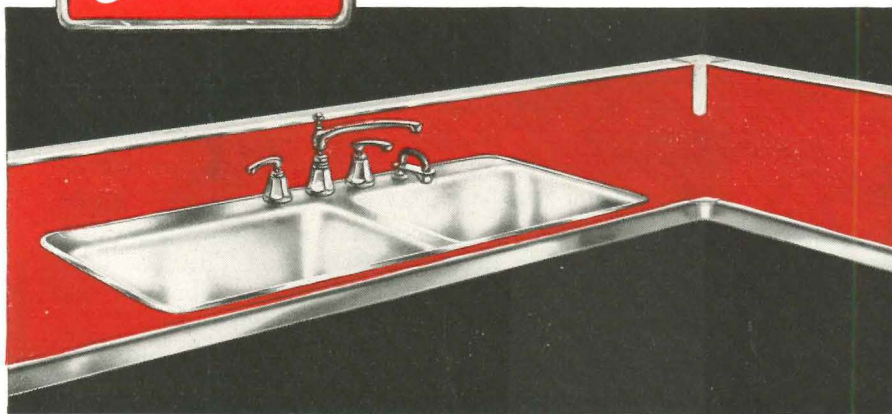

Duratone tops are guaranteed and will be made up in any size to fit any plan—with or without sink bowls. Priced competitively yet built for superiority. Public acceptance of the ELKAY name, together with consumer advertising support, brings you another pre-sold product.

Write for literature and prices on both lines.

elkay manufacturing company

1898 S. 54th Avenue • Chicago 50, Illinois
The World's Oldest and Largest Manufacturer
of Stainless Steel Sinks

real clincher in most cases. H promoted to the buyers?

PREFABS

Sirs:

There is a definite need in the world for a prefab in localities where a conventional builder is incapable of building more than one or two units per year. We have such small localities in Colorado. These are localities in the immediate vicinity of the prefab factory where there is a definite economic advantage.

In Colorado Springs and Pueblo, the demand is far more than the prefab industry can supply, as evidenced by our sales. After we entered the market in Colorado Springs, the demand for prefabs jumped in sales, because there was no conventional builder left to build. The demand for the prefab and because prefabs are pre-programmed housing and Fanny Mae money.

In other words, what the price of a prefab in Colorado Springs is not a better deal on better financial terms.

In addition Colorado Springs has the advantage of city water and sewer connections, even though they are not available in the country. No conventional builder can offer such a deal.

The prefab has made its greatest contribution to home-building on special developments. It is noted above and the Lustron house is a \$37 million of public funds on investment.

Any good merchant builder will build prefabs, if they are both competitive and under the same conditions for the public's benefit.

The proof lies in the fact that the demand for the prefab has been especially high. It is financed under our recent radical program. The conventionally-built house is a poor deal compared to the prefab.

JOHN BONFORTE
Bonforte Construction Co.
Pueblo, Colorado

NEEDED: MORE REMODELED HOUSES

Sirs:

Some of the compact houses built in the past few years need only a few dollars worth of work to tidy up and end up by never being replaced.

My mother's house with five bedrooms and a bathroom looked as mine does. It was built in 1920 and if a few things were left alone it would never be noticed. In today's small houses, you start leaving a few things alone and the place soon looks upset.

Many of the older homes, which are being remodeled, would not only provide a better home but would really give you a better home life they need.

With the help situation as it is, it is a good idea to remodel an older house that would be big

con

Gold Bond[®] ASBESTONE

PROUDLY BRINGS YOU...



THIS FAMOUS
ASBESTOS SIDING...

Chroma-Tex

SIDING SHINGLES

—now a guaranteed Gold Bond product

Rich Texture. Deep, natural-looking grain rivaling the costliest sidings on the market—at the same low price as regular Gold Bond asbestos shingles.

Fresh Colors. Poplar Green, Twilight Gray, Mellow Ivory, Pheasant Brown, Dusty Coral. Color is two-toned—dark in the valleys, light on the ridges—for a pleasing new kind of exterior decorating.

Lifetime Beauty. Made of asbestos-cement—fireproof, weatherproof, termite-proof. Needs no painting, no maintenance of any kind.

Can be applied over any sidewall surface.
Ideal for new construction.

Now... look to Gold Bond for exterior building products too!

In addition to siding, there is Gold Bond Asbestone roofing. This complete new line of materials for *exterior* use means that National Gypsum can now offer you more than 200 top-quality building products—all under the Gold Bond "undivided responsibility" guarantee. This assures you that the responsibility for performance, durability and firesafe qualities of these materials rests with one reputable manufacturer!

Write for full details.

NATIONAL GYPSUM COMPANY • Buffalo 2, N. Y.

FIREPROOF WALLBOARDS • DECORATIVE INSULATION BOARDS • LATH • LIME PLASTER • SHEATHING • ROOFING • SIDINGS • WALL PAINTS • MASONRY PAINTS TEXTURES • ROCK WOOL INSULATION • METAL LATH • SOUND CONTROL PRODUCTS

You'll build or
remodel better with
Gold Bond

vide a small one- or two-room a
a mother or aunt or friend wou
invaluable assistance.

Many small apartments for y
just starting off could be provide
ing some of these spacious home
provide income for the owner a
siderable help to our young mar

I believe that much of the f
modeling lies with the builder
been afraid in many cases to t
because many did not know how
have wanted to work on too high
of profit and often their prices an

Many jobs would be available
if they tried to understand tha
is a necessary part of housing
economy, and if they were willin
considerably less profit.

MRS. EUGEN
Coconut Gr

Sirs:

I have spent two full hours tr
the possibilities of the truss (H
detail holding up in practical co

In constructing a house for l
how can we set down rules for
placement of concentrated loa
ances?

Disregarding the fact that la
such as wind or seismic stress w
only by beam strength of the rail
the connections are anything bu
common craftsman much less
journeyman.

The nailing of so many na
areas at connections is at fault
nails being in line with the g
bers, one of the weakest construc
framing. A person with only mo
edge of framing would star-nail
tions to prevent the nails f
the wood during construction
frame settles. The failure of
would be progressive.

The framing of the ties an
not carried all across the memb
nailing room and end margin
On the lower outrigger the nail
the joist shows not more than
The so-called gusset at the pea
positioning and the lack of end
The deflection given of 1 1/8"
greater than 1/360th of span,
acceptable for plaster or most
ing material. I am sure that in
ing will sag progressively in
that sway-back barns do.

ERNEST WIL
General Contr
Orange, Calif.

Sirs:

Structural failure will result
a later date goes in and saws o
cal members in the frame in o

cont

ANOTHER GREAT CHAMBERS "FIRST" IN BUILT-IN COOKING EQUIPMENT...

THE ONLY "BUILT-IN" Broiler and Griddle THAT SETS IN A COUNTER-TOP!

CHECK CHAMBERS SELLING FEATURES!

- ✓ Completely Waist-Hi, No-Stoop Cooking!
- ✓ Gourmet Broiling at Waist-Hi Level
- ✓ No Outside Venting Required
- ✓ World Famous Cooking Performance
- ✓ Stainless Steel Construction
- ✓ Fits Standard Kitchen Cabinets-- Wood or Metal
- ✓ Can Be Bricked In Solid
- ✓ Oven Doors in 7 Decorator Colors
- ✓ Oven Doors... Bottled... Tank Gases
- ✓ For City... Bottled... FHA Approved
- ✓ AGA Approved... FHA Approved

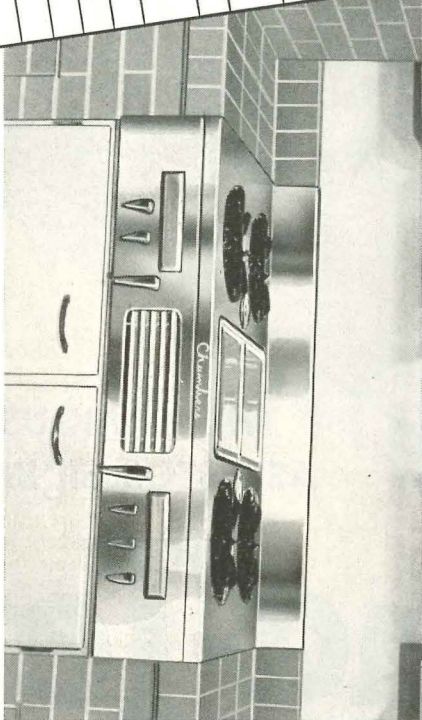

This compact unit combines 4 burners and Chambers' famous "IN-A-TOP" Broiler and Griddle in only 42" of counter! Broiler rises to counter-top with a flick of the wrist. Of lustrous stainless steel.

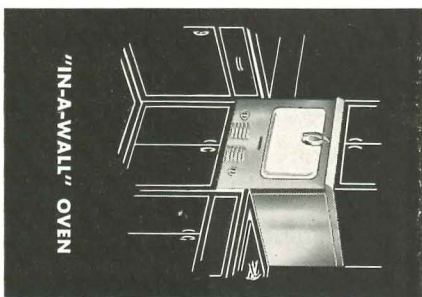

"IN-A-WALL" OVEN

Super insulated to give Chambers' world-famous performance. Requires only 24" of counter.

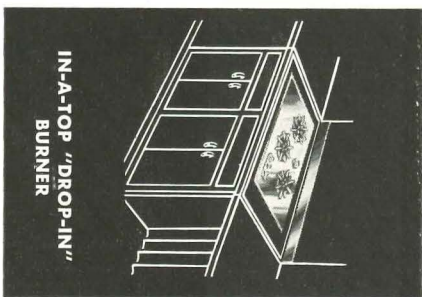

IN-A-TOP "DROP-IN" BURNER

Chromium plated steel, perfect for wall, island, or peninsula cooking arrangements.

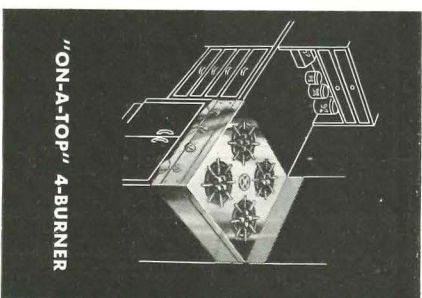

"ON-A-TOP" 4-BURNER

Big capacity, compact space. 4 burners in only 27" of counter. Satin stainless steel.

THE ORIGINATOR AND MASTER BUILDER OF INSULATED RANGES SINCE 1910

MAIL COUPON FOR MORE INFORMATION

CHAMBERS, 2464 N. Meridian St., Indianapolis, Ind., Dept. AFT-553
I am interested in: AIA Specification Sheet Dealer Franchise Information Special Builder Prices on Model Home.
I am a Dealer Builder Architect

NAME.....

FIRM NAME.....

ADDRESS.....

CITY..... ZONE..... STATE.....

Chambers

COOKS WITH THE GAS TURNED OFF



HOW GUNNISON'S HOMES'

Path to profits"

ADVISORY FINANCIAL SERVICE

To assist you in your development work, Gunnison Homes' staff includes financial specialists who will assist you in dealing with your lending institutions. You'll find their services helpful in making arrangements to finance specific development projects.

ELIMINATION OF ARCHITECTURAL AND MATERIAL PROBLEMS

When you build the Gunnison way, you offer your customers the finest, most modern architectural design from the boards of men like the nationally-known residential architect, Henry Hill, while eliminating a retainer fee of your own. And temporary material shortages cause no holdups, because everything you need is included in the Gunnison package.

HOME PLANNING SERVICE

All the decorating help you need is available from Gunnison's Home Planning Service. Paints, colors and fabrics are suggested in modern taste for these truly modern homes. And complete furnishings packages are available to you at extremely low cost for use in your demonstration homes.

GREATEST 1953 LINE IN THE BUILDING INDUSTRY

It's a line so extensive that you can build a project of 50 homes or even more without a single duplication. This great Gunnison line is based on four different models—the new "Talisman" and better-than-ever "Champion," "Coronado" and "Catalina"—each with several sizes and a choice of exterior treatments. 72 elevations in all.

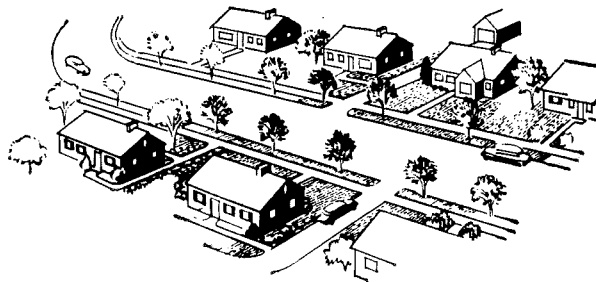
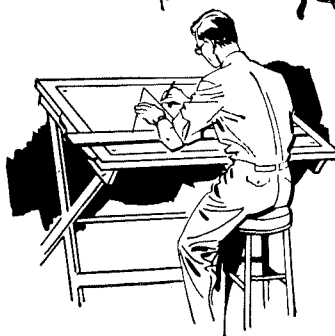

If you'd like to follow this "eight-point path to profits"

... write to us on your business letterhead. We'll send you complete information on this successful enterprise that offers today's greatest home values in the \$6,500 to \$12,000 price range.

 **Gunnison Homes**

Manufactured by Gunnison Homes, Inc., New Albany, Indiana

"Gunnison," "Champion," "Coronado," "Catalina" and "Talisman"—trade-marks of Gunnison Homes, Inc.

SUBSIDIARY OF UNITED STATES STEEL CORPORATION

"DISHMASTER helps sell my houses!"

says Donald Scholz,
prominent Ohio Builder

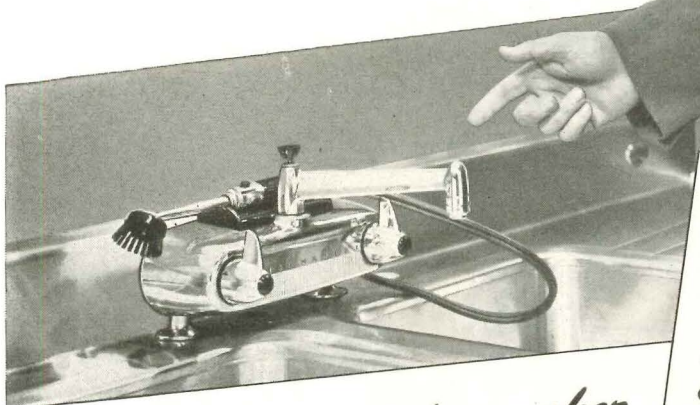

You can give your houses the added advantages of a DISHMASTER, the push-button dishwasher, for little more than the cost of faucets alone!

DISHMASTER is a sales maker ...and here's why!

- ✓ Dishmaster ... the miracle, pushbutton dishwasher, fits any sink; washes dishes, glasses, silverware, even pots and pans!
- ✓ Dishmaster retails at a price that makes sense to housewives and dollars for you—\$49.50!
- ✓ Dishmaster washes dishes faster and easier than models selling for as much as \$300—\$400!
- ✓ Dishmaster is easy to install—fits wall or deck sinks.
- ✓ Dishmaster has been proved in hundreds of thousands of homes all over America.
- ✓ Dishmaster's national advertising will reach over 85,000,000 readers of American Home, Better Homes and Gardens, House Beautiful, House and Garden, Sunset, Small Homes Guide, Good Housekeeping, Business Week, Esquire, Newsweek, Woman's Home Companion, Ladies' Home Journal, Woman's Day, Family Circle, McCalls', Everywoman's, What's New In Home Economics.

FILL OUT COUPON NOW!

DISHMASTER
puts the
big plus
in your houses

Gerity-Michigan Corporation, Merchandising Division
10 South Superior St., Toledo 4, Ohio

Gentlemen: Please send me Free descriptive booklet "Dishwashing the Easy Way". I am a Builder Architect Please send prices.

Name _____

Firm _____

Address _____

City _____ Zone _____ State _____

ample, install a dormer window failure will also occur if someone studs in a load-bearing partition.

We must rely on a degree of home owners. Possibly some day will provide the home owner with instructions regarding the house possibly include in such a book on the mechanical equipment and regarding the limitations on design.

In the trusses which we built carpenters, the nails were staggered usual fashion and there was ample nailing in all of the connections dentally, were built exactly as shown drawings. The drawings are interspersed with diagrams and no exact nail spacing was given.

It is assumed that the craftsman line up nails in the same grain. There are, as far as we know, no existing standards for nail spacing: that is, no scientific tests.

It might be interesting to note nail size recommended for use in nails should be offset or staggered of one nail diameter which, in this case, be approximately 1/8". This dimension is small to be shown on the drawing. This amount of offset between nails in the other direction can be approximately 1 1/2".

Similarly, we are confident that other portions of the frame, in the end distance at the ring connector. Without an exact mathematical analysis, we do not know how it is possible to calculate this end distance was unsatisfactory. A complete mathematical analysis of that would involve considerably more than two hours' work.

We are printing a plan sheet a portion of the Small Homes Council includes the design data and other information requested in Mr. Gommel's letter.

JAMES T. LENDINER
University of Illinois
Small Homes Council
Urbana, Ill.

WHAT KIND OF HOUSE?

Sirs:
Anent Frank Lloyd Wright's the kind of house people want (1953), this is from an ad in the *Daily News*. "What is a Ranch House? It goes deep into Western soil. Its growth has been limited. It has never known a shelter for a family so perfectly constructed and equipped, that it gives the most possible accommodation for the family shaped by needs for a special way of life, informal, yet gracious."

WM. J. ...
Farmers ...
Buffalo, ...
continues



THIS HOME, built by L. I. Combs & Sons, typifies the successful use of *Thermopane* by builders in northern Indiana. It is an \$18,000, three-bedroom house with full basement, garage and perimeter gas heat. It's all set for the cold Lake Michigan winds coming over the dunes. It has *Thermopane* insulating glass in every window.

"This sign packs a wallop for builders"

—says HENRY J. BULZA
of GARY, INDIANA



"This is *Thermopane** insulating glass." Those words in the window of a new house—or spoken to a home-buying prospect—are powerful selling. *Thermopane* is known—and wanted.

Henry J. Bulza of the Ambridge Lumber and Supply Company, Inc., Gary, Indiana, can tell you from experience that it works! Builders have bought from him over 1,000 lights of *Thermopane* in two panel window sizes. They're offering *Thermopane* in every window of houses ranging from \$18,000 to \$25,000. They give home buyers insulated windows right at the start, included in the mortgage package. There's no extra selling job for storm sash.

The use of *Thermopane* in panel windows gives builders an economical way to add the extra value and the sales appeal of *Thermopane*. Mr. Bulza says: "The panel window eliminates storm sash and cuts the builder's cost. Also, it gives the home owner more glass for less money. We can give him 82 sq. ft. of glass for about \$200. The same wall area with conventional windows would cost a lot more."

Write for full information. We'll send you full data on *Thermopane* sizes, types of windows for *Thermopane* and details on panel windows. Libbey-Owens-Ford Glass Co., 953 Nicholas Building, Toledo 3, Ohio.



Thermopane

INSULATING GLASS

LOOK FOR THE NAME ON THE SEAL BETWEEN THE PANES

For better vision, specify *Thermopane* made with Polished Plate Glass

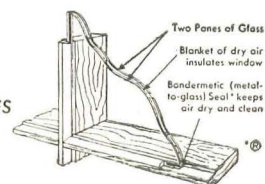

PARKAY

**PUTS *Sell*
INTO A HOME!**

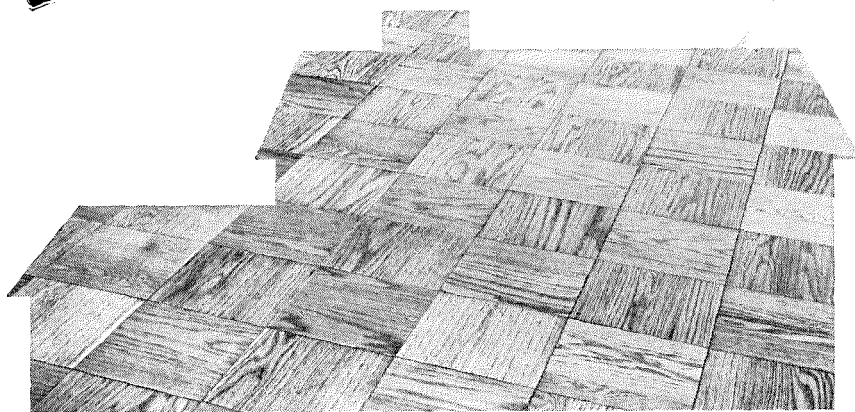

Install and feature ready-finished hardwood floors of Parkay Oak Tile

Beautiful hardwood floors of Parkay Oak Tile add a visible value to a home—one that most prospects appreciate and want. It's a low cost luxury feature, too, that's well within most building budgets.

Parkay flooring is 3/16" thick—conserving costly hardwood without sacrificing wearing surface; permitting use with other resilient floor materials without changing floor levels. Factory finishing eliminates slow and costly sanding and shellacking. Flooring is applied quickly with Parkay Adhesive over any smooth, dry subsurface—wood or cement. Final cost? Comparable to that of ordinary strip finished on the job.

Parkay 9" x 9" Oak Tile is available in brown or blond finish. Write today for sample and descriptive literature. See for yourself how Parkay gives a plus value that you can turn into a profit. Parkay, Incorporated, 5002 Crittenden Drive, Louisville 9, Ky.



PARKAY

READY-FINISHED HARDWOOD
FOR FLOORS AND WALLS

BATHROOMS

Sirs:

Our bathrooms have been completed in a 5' x 7' variety and at \$7,000 for a room house in a recently completed development, we offered ceramic tile, marble threshold, glazed clay tile, high—5'-6" around the tub—and sanitary fixtures in color. We could have offered the "20 Ways To Better The Bathroom" (H&H, Feb. '53) in that order. Specifically: (1) the full width of tile around the tub, (2) the oversize medicine cabinet, (3) the open cabinet over tank, (4) the washing facilities for items such as n

Your "5 Ways To Cut Bathroom Costs" in my opinion are all very practical. The masonry construction for our expansion and doubt if any dollar and cent could be effected by using the full width

However, we do feel that the addition of this feature will make it worth the cost if it should cost us a few dollars more. We plan to use it in our next development.

I hope in the near future you will do a similar fine job on other portions of the house such as kitchen, bedrooms and living space, etc.

JAMES M.
Albert Co.
Miami, FL

Sirs:

Based on our market, I believe that buyers will not pay extra for a large amount of anything that is added adds to sales volume. Items that up the cost reduce the volume of sales, except in higher priced homes. The cost of the appeal items are lost in the volume.

Definitely the bathroom is not the washing machine.

IRVIN A. BLIETZ, *designer*
Wilmette, Ill.

Sirs:

Many of the ideas are excellent.

We now use many of those ideas. We expect to utilize most of the rest of them. Buyers would gladly pay extra for a bath if they could. Unfortunately, it is to qualify our purchasers on an increase in sales price, even a small amount would eliminate a substantial percentage of prospects for homes at \$8,500 to \$10,000.

In these homes of 800 to 950 sq. ft. more interested in adding items to the sales appeal, the increased cost could be all or mostly absorbed, than items which would raise the sale

ROLAN
Bremer
San An

Home sales with Weldwood

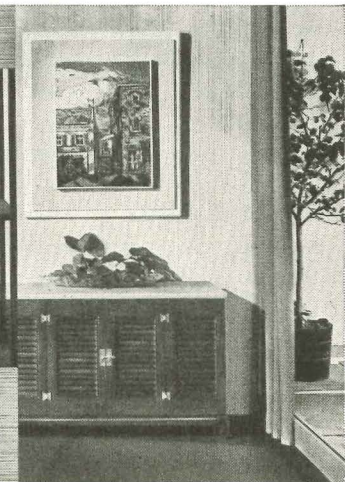

Low cost for a striking Weldtex 13-foot panel only \$27. Notice how the deep grooves add depth and personality, yet have the main purpose of hiding face nails and joints. Weldtex goes up fast and may be painted, stained or finished "natural."

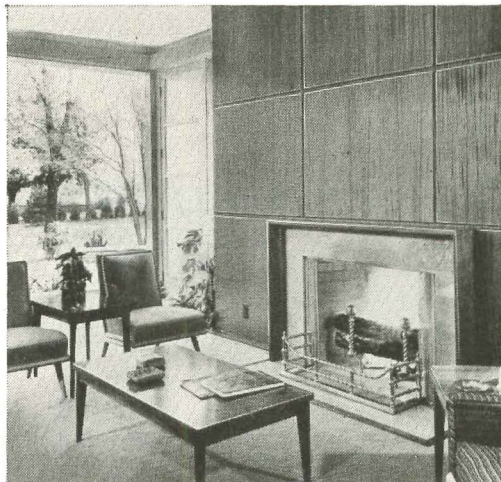

Superb African Mahogany is an ideal backdrop for either traditional or modern furnishings. For either new construction or remodeling jobs it adds character and a quiet charm. Like all Weldwood plywoods, it is guaranteed for the life of the building.



Why paint the ceiling and forget it when it can be a valuable sales asset with Weldtex pre-cut squares? Available in 12", 16" and 24" sizes, they are easy to put up, and can also be used for dramatic wall treatments. Cost—about \$47 for a 12' x 15' ceiling.



Paneling for kitchens makes extensive use of Weldwood plywoods. Light colored woods such as birch and knotty pine are particularly popular. In this kitchen, birch has been used to great advantage. Upkeep with all Weldwood plywoods is kept to a minimum.

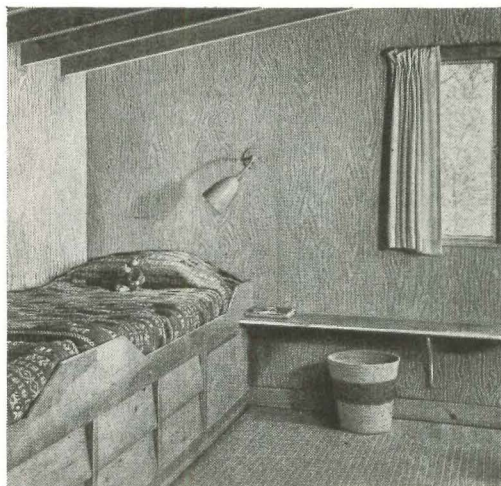

Newest Weldwood paneling is Surfwood, an exciting product for use where a rustic treatment is desired. Surfwood, in 4' x 8' panels, has the authentic "sand-blasted" effect of wood found on the beach—satin smooth with grain and small knots standing out.



Paint or enamel this Weldwood Utility Gum with no grain raise. Made without plugs or patches, these low-cost hardwood panels are highly useful for interiors, yet they cost no more than softwood plywood. Sizes: 1/4" thick in panels 6' x 4', 7' x 4', and 8' x 4'.

Weldwood is a Weldwood Product for every part of the home



Weldwood is used for:
 • Roof sheathing
 • Built-in walls
 • Siding material

- Westinghouse Micarta for counters, table tops and bars
- Doors
- Sub-flooring
- Bathrooms and kitchens

Cost figures above are approximate; for exact quotations consult your lumber dealer.

Weldwood®

United States Plywood Corporation
 55 West 44th Street, New York 36, N. Y.
 Distributing units in all principal cities • Dealers everywhere

Novoply, Weldtex, Plankweld and Surfwood are registered trade marks



VENTO

the BONDERIZED STEEL WINDOWS OF *EXTRA VALUE*

The extra value in Vento Bonderized Residence Casement Windows includes: all casements drilled and tapped to receive storm sash and screens, operator arm guide channels attached with screws for easy removal and replacement, if necessary; ventilator frames constructed from the same heavy sections as the outside frame. This provides greater rigidity and stronger ventilators.

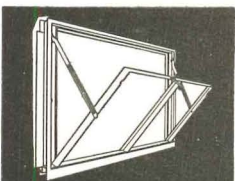
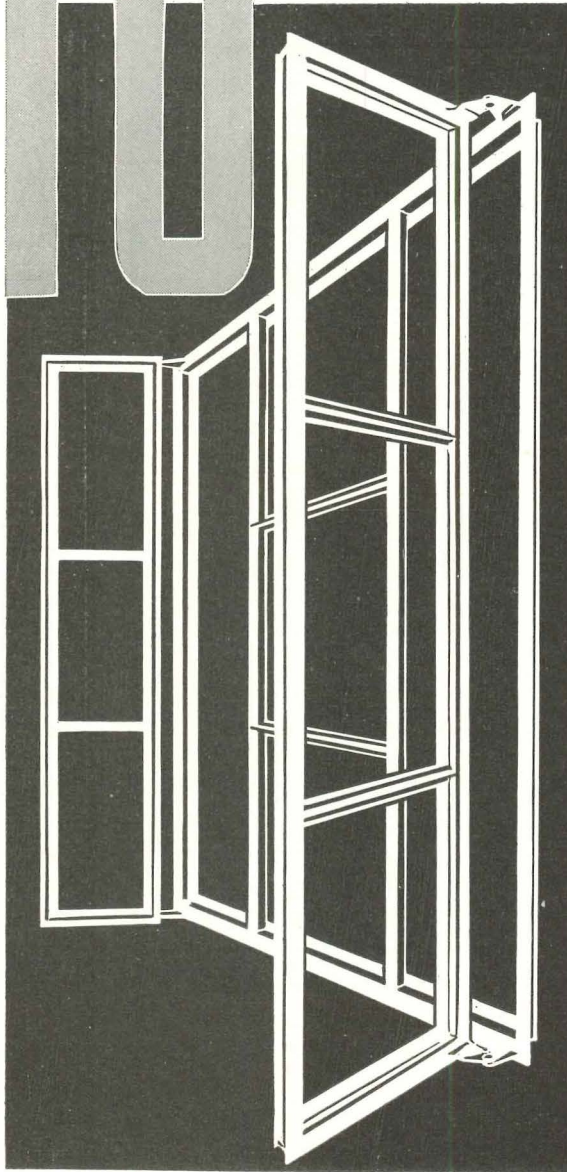

NEW IMPROVED VENTO BONDERIZED "CHAMPION" BASEMENT WINDOWS give extra value because of their 14-gauge electrically welded frame, fins welded to jamb for quick installation and double contact with leak-proof watershed sill. A plus value incorporates a redesigned latch which assures positive operation under all conditions.

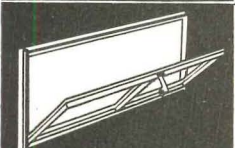

VENTO "THRIFTY" BONDERIZED BASEMENT WINDOWS give extra value because they are a real economy window especially designed for lower cost housing. Two position ventilation and easy sash removal. Fin flanges at jambs for quick installation. Three sizes, putty type only.

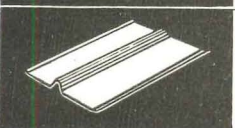

VENTO FORMED STEEL LINTELS give extra value because they permit the use of standard 8" blocks over door and window openings. Of 10-gauge steel, with stiffening crimp in center. Also formed steel lintels for brick constructions.

ALSO Vento "Champion" Barred Basement Windows; Vento "Champion" Utility and Barn Windows; Vento "Thrifty" Utility and Special Type Windows.

Write us for full information and name of nearest distributor.

Some desirable territories are open for representatives and distributors. Write for particulars.

Sirs:

We certainly agree that the "Cut Bathroom Costs" can save or more. We have used several especially where codes permit. Few permit the minimum National Plumbing standards, and in our area we have excess requirements.

It is our opinion that after we have a minimum house, people are willing to pay for extras in a larger bathroom.

We do not believe that people would like to use a washing machine in the bathroom.

LAVERNE E.
Midwest Fab
Janesville, Wis.

Sirs:

The bathroom is a splendid place for a washing machine, especially for combination washer-drier models. I believe in bigger wash basins, full-length mirrors, built-in clothes hampers, etc. I believe for themselves in added sales appeal.

I believe space for a bathing cabinet, a basin with a counter top should be included for use in bathing the children.

MENDELL M. BROOKS
Muncie, Ind.

Sirs:

I am sure that some buyers would like a larger bath, but not in our area. There is no question in my mind that wash basins, full length mirrors, and added sales appeal, but they are an added cost which would be counterproductive. We do not think that the bathroom is the best place for the washing machine, and do not think that large numbers of people would go for an open bath plan.

NELS G. SEVERIN
Severin Construction
San Diego, Cal.

INTERNATIONAL

Sirs:

I find your magazine full of new ideas. I would like more detailed features on the newest building materials and close details from the examples.

As your magazine is widely read throughout the world it seems that it does not reach the US only, but to the world. I would like to see examples of modern buildings from other countries then to appear in the magazine. I would like to help bring the different architectural ideas closer and give a broader view of what is being tried out all over the world without the American touch.

Mrs. C. ...
Istanbul,

VENTO

STEEL PRODUCTS CO., INC.
236 Colorado Ave., Buffalo 15, N. Y.

MODERN MORTGAGES

A monthly report on important developments in the modernization of mortgage credit, with particular emphasis on the expanding potential of the package mortgage, the open-end mortgage and the expandable mortgage

Package mortgage: Minnesota, Wisconsin join the parade

Two more states were opened up last month to the package mortgage: Minnesota and Wisconsin joined the majority of states that already take the package mortgage as a matter of course and include household equipment under a mortgage as standard practice. That leaves only 13 states—notably California and Texas—yet to modernize mortgage credit to cover the new types of equipment (all states now cover equipment like oil burners which was at first questioned by mortgagees). The other 11 states not yet using the package mortgage: Georgia, Idaho, Iowa, Kansas, Nebraska, North Carolina, North Dakota, Tennessee, Utah, Vermont and Wyoming.* Both Minnesota and Wisconsin became converts to the open-end mortgage as well.

It happened one night. The rapidity with which both states adopted the package and open-end mortgages suggests that still more states can be opened up for them if someone gets behind them and gives them a good push. Here is what happened to the package mortgage in the two northwestern states: a representative of HOUSE & HOME—at the invitation of builders and of lenders and mortgage lenders in Minneapolis and Milwaukee—explained the mechanics of the package mortgage, citing that many lenders still believed “what was good enough for grandpa is good enough for us.”

At the Minneapolis meeting things happened in record time: State FHA Director Harold Farley agreed to consider appliances as legitimate costs of a house along with lumber and other building materials, a short time later said FHA would allow builders a reasonable value on appliances. VA followed suit, agreed to allow the builder his cost plus 10% for appliances.

Within four days Twin City Federal Savings & Loan, Minneapolis, was running newspaper ads explaining its package mortgage plan, soon was processing the first of several package-mortgage deals.

Said G. P. Uttley, vice president of Minnesota Federal Savings & Loan, after the meeting: “I fully expect this will stimulate members of the Mortgage Bankers Assn. to use the package and open-end mortgages.”† George Maloney of the Minneapolis law firm of Maloney & Carroll (he is also general counsel for MBA) convinced skeptics at the Minneapolis meeting of the soundness of the legal bases for the package mortgage. Many local builders saw in the package mortgage a boon to the replacement market which they believe must be tapped to keep housing volume up to the million-a-year

mark that spells lower prices, better value and faster sales.

The Milwaukee story. In Wisconsin's biggest city the HOUSE & HOME spokesman made another one-night stand and convinced lenders the package mortgage was legal under the common law. FHA Director Anthony Gawronski said: “I think young house buyers should be able to get needed kitchen and laundry equipment as part of the house package rather than buying on short-term credit.”

John Cleary, vice president of the Wisconsin Savings & Loan League, said: “Our institutions have been missing a bet. We expect to have a standard package mortgage ready shortly to recommend to members.”

In both cities lenders had raised age-old objections. One: that the appliance would not last the life of the house. Yet, the H&H spokesman pointed out, lenders did not balk at writing mortgages covering oil burners, hot-water heaters, even paint applied to walls and added that the life of the average FHA mortgage is 8½ years, anyway, and well within the lifetime of most appliances.

The objection that easily removable household equipment might not be considered realty because it was not securely affixed to the premises was also scotched. The answer: parties to a contract in any state can determine between themselves what shall be considered realty; in states where, by custom, appliances are not considered real property, protection is afforded third parties and the lender by filing the mortgage under the real and chattel records. Clincher: FHA's revised waste clause (see H&H, Feb. '53, p. 77) provides insurance for all but \$100 of the total needed to replace stolen or wilfully damaged property.

Pennsylvania and Missouri have foolish inconsistencies: appliances on the approved list in Philadelphia are not on the list in the Pittsburgh area. Similarly Kansas City's FHA does not approve the same appliances for FHA loans that are perfectly approved in St. Louis.

Recently urged federal housing agencies to adopt the principles of the package mortgage.

BILT-WELL

Twin Features:



WEATHERTIGHTNESS—to save fuel
and **EASY OPERATION** to save irritation—
make both **BILT-WELL SUPERIOR** double-hung
and **BILT-WELL CLOS-TITE** casements the
outstanding windows in their respective fields.

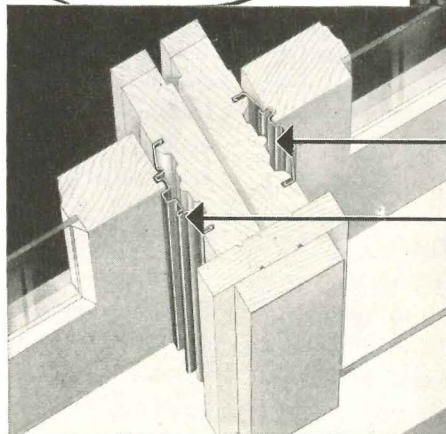

"SUPERIOR" JAMB-LINER

The Bilt-Well Patented Superior Jamb-liner provides twin functions. Its flexibility automatically overcomes sticking from expansion—also overcomes leaking from contraction. And, because it does both, Superiors fit snugly and slide easily under all weather conditions.

See Our Catalogs 16^c-CA and 23^b-CA
in Sweet's 1953 File



An entire issue on

How to plan and sell your next house

**The builders' potential market is limited only
by their ability to build a better house**

Are builders setting their sights too low when they ask how long they can go on selling one million houses a year?

Or is their true potential many, many times one million?

Nearly every American family is a potential buyer if the right house, at the right price with the right financing is offered them. Americans are accustomed to trading in the old model if a really better model is put on the market. Families will buy houses that way too if they can see the new house is far better than their old one.

To attract millions of families now living in old obsolete houses many builders will need to change their entire outlook. Too many are still saying: "My houses must be pretty good because I am selling all I build." But their houses are "pretty good" for only a very narrow portion of the real market—the newlyweds and the GI's. These houses are not truly the "improved model" that is necessary to tempt families already reasonably well housed.

A better house is more than an advertising copywriter's dream. It is here now. In recent years architects have demonstrated they can design a house that enables a family to live a far more pleasant, more comfortable life. Manufacturers have devised hundreds of new and better homebuilding products and equipment items than they used to make. Every builder who has built a new house for himself recently knows that an up-to-date house can be a better place to live.

But millions of families have never seen "the new model" house. *How can you expect them to want something better?* The only way to shake them loose is first to show them a better house—and show them why it is better for them.

The way builders can create a vast new housing market of millions of families is the two-fold theme of this issue:

Bring out a new and better house

—then sell it with the best possible merchandising techniques

Architects, builders, lenders and suppliers agree on **Tomorrow** best-selling hou

Round Table panel

HOMEBUILDERS

Emanuel Spiegel
president, National Association of Home Builders

Richard Hughes
first vice president, NAHB

John Dickerman
executive secretary, NAHB

Leonard Haeger
director, Technical Services, NAHB

Nathan Manilow
chairman, Mortgage Committee, NAHB

Earl W. Smith
chairman, Technical Committee, NAHB

Charles F. Travers
president, Richmond Builders, Inc.

Frank Zuzak
Trade Secrets Committee NAHB

BUILDERS' ARCHITECTS

L. Morgan Yost
chairman, AIA Committee on the Homebuilding Industry

Robert Anshen

Charles Goodman

Cliff May

Nicholas Satterlee

Herman H. York

HOMEBUILDING MATERIAL SUPPLIERS

George Kobick
manager, Home Bureau General Electric

Charles M. Lemperley
vice president, Sherwin-Williams Co.

Fred H. Ludwig
president, Merritt Lumber Yards

BUILDERS' BANKERS

W. A. Clarke
first vice president, Mortgage Bankers Assn.

Claire W. Grove
for the National Savings & Loan League

Harry Held
for the Mutual Savings Banks

A. D. Theobald
for the US Savings and Loan League

HOMEBUILDING REALTORS

Walter S. Dayton
president, Brokers Division, NAREB

Robert P. Gerholz
past president, NAREB and NAHB

HOMEBUILDER ADVERTISING SPECIALIST

Peter McKenna
Wm. von Zehle & Co., Inc.

GOVERNMENT OBSERVERS

Albert M. Cole
administrator, Housing and Home Finance Agency

Guy T. O. Hollyday
commissioner, Federal Housing Authority

CHAIRMAN: P. I. Prentice,
editor and publisher, HOUSE & HOME



For the first time ever, all the top officers of the National Association of Home Builders have sat down with most of the top architects planning builder houses, with official spokesmen nominated by all the big lending groups which finance builders' houses, and with representative suppliers of homebuilding materials, to determine what kind of house the homebuilding industry must plan to offer tomorrow.

This Round Table met under the sponsorship of HOUSE & HOME, in the presence of the new heads of both HHFA (see list of panel members opposite) and FHA. Here are the unanimous recommendations:

Just plain selling may well be the most pressing of all the problems homebuilding must solve the next few years. How can we go on selling 1,000,000 houses a year now that new family formation has dipped below 700,000, the war-born housing shortage has been filled, and the American people are better housed than ever before?

In the tougher and more competitive markets ahead, this is a problem each individual builder must solve for himself, and his success in meeting this problem will determine whether he continues to prosper or has to stop building. But this is also a problem which our industry must face collectively, and our industry is now such an essential mainstay of so many other industries that our continued success in selling a million or more homes a year may very well make the difference between national prosperity and a serious recession—a recession which might undermine the new Administration's efforts to halt inflation, balance the budget, and free the economy.

In a buyer's market homebuilders will find it hard indeed to sell a million houses a year without far better sales techniques and methods than those good enough for the easier markets of the past seven years. But we recognize that for our industry as for every other industry the one best way to stimulate sales is to offer a better product.

Nonsense about the good old days. All of us—architects, builders and lenders alike—are unanimous that the housing built in this country since the war is on the average the best housing ever built in America or any other country. It is just plain nonsense to talk of homebuilding being better in the good old days. But all of us are equally unanimous that most of our housing could have been better—and must be still better in the future.

The problem facing our industry is no longer how to provide good housing to satisfy a tremendous shortage. At least equally important now is how to provide housing so much better than the old that we can tap a new *rehousing* market for nearly half a million homes a year. Our problem is to help Americans not only maintain but raise their standard of housing.

As our problem changes, government policy on mortgage insurance should change with it. We cannot meet our new goals of better housing with a mortgage pattern designed only to stimulate minimum housing.

New mortgage patterns for better houses. We agree that we can offer much better values by better applications of the new construction economies worked out by the builders, the new designs for better living worked out by the architects, and the new and better products worked out by the suppliers. But we cannot put these better values within the reach of the average family without a new pattern of insured mortgages* with less discrimination against better housing and more general use of the package mortgage plan.

Here is a check list of features which will be more and more important in tomorrow's house. Some of them can be paid for by economies in other ways. All of them will add more to value and livability than they will add to cost.

Some of these features will have immediate sales appeal; others may need explaining at first to help buyers catch on to their importance. Some of them are already overdue and should be introduced at once into every house; all of them indicate trends all builders, suppliers, and builders' architects will be wise to watch:

* One panel member had reservations on this point, but about half the members considered it the most important recommendation of all





Design trends: wide overhang shades glass wall which opens up relatively small living room visually. Well-designed fence carries the eye to the boundary line and guarantees privacy for the outdoor living areas. House by Cliff May. Photo: Maynard Parker

Tomorrow's house will be bigger

Families are bigger now, and bigger families not only need more rooms to sleep in, but bigger rooms to live in.

A family big enough to need three or more bedrooms needs a larger living room, a larger eating space, a larger kitchen. It needs at least a bath and a half. Furthermore, two generations cannot always share the same living room. If there is no game room or rumpus room, then at least one bedroom should be big enough to do double duty as a sitting room for the parents or a play space for the children (p. 142).

Making the rooms a little bigger is one of the cheapest ways to add value. Most builders could add 100 sq. ft. to an 800 sq. ft. \$8,000 house for less than \$400.

Tomorrow's house can follow any style

It is perfectly possible to build a good house that will look as if it had been built in some other time or some other country—Colonial or Cape Cod, or Spanish, or French, or Dutch, or Western Ranch. What makes a house good is not its style, but the amenity and livability it offers. But—

Contemporary design offers at least three big advantages:

1. Only the new look of contemporary design can dramatize the new advantages offered by tomorrow's house. The auto makers learned long ago that the new look of their new model is essential to make people dissatisfied with their old cars.
2. Contemporary design grew out of today's new methods, new materials and new economies. Once mechanics catch on to these new methods, houses should cost much less to build. In our time of high-cost labor, the intricate details evolved in cheap-labor handicraft at times are apt to cost more than they are worth. What we need is an architecture based on simpler assembly of better parts.
3. Contemporary design expresses naturally many popular new features like roof overhangs, large window areas, etc., which are sometimes difficult to graft onto houses restricted by period styling.

Tomorrow's house should be easier to run

Cost less to maintain From now on most new homes will be sold, not to newly married veterans who have never had a home of their own, but to families with enough experience in home ownership to realize the importance of good construction and easy housekeeping.

Before he buys, the husband will ask more questions about insulation, construction, flashing, dampness, wiring, termites, plumbing and heating costs. The wife will want to know if paint is washable, if floors will scar or need frequent waxing and polishing, if kitchen counters and cabinets can be wiped clean, and whether the water is hard or soft.

Tomorrow's house will reflect

Architect-and-builder teamwork The one and only way to make a house better at no extra cost is to improve the design, for it should actually be *cheaper* to build a well-planned house.

To that end the builder must first find the right architect and then be willing to pay a fee for which the architect can afford to do a first-class job on every aspect of design, from site layout to the final selection of color. It is foolish for any builder to think he can get that kind of architectural service for less than he pays a plumber or a carpenter for a single day's work.

No architect can be much help to a builder unless he is first willing to study the economies and economics of volume construction and then work in the closest partnership with the builder to make every square foot count and to eliminate every waste. Not every architect is qualified to do this kind of product design, which is, in fact, the most exacting form of architectural practice. That makes it all the more important to make this work attractive and remunerative for those qualified architects who are willing to devote a large share of their time to the builder's house field.

**Tomorrow's house will make smarter use
of color, both inside and out**

Good color is the easiest way to introduce variety into a tract development and the easiest way to step up the attractiveness of the interiors. Paint in the right colors costs no more than paint in the wrong colors, but color selection is no job for an amateur. The color scheme should be entrusted to the architect—and most architects in turn will make use of a color specialist, perhaps on their own staff, perhaps an outside consultant. Such color guidance usually costs about \$15 a house, is well worth the cost.

**Tomorrow's house will be cooler in summer
and warmer in winter**

Double glazing, insulation and central heat all cost far less today (in constant dollars) than ever before. Small windows may have made sense to keep out heat and cold in your grandfather's time, but not today. It is high time every builder's house reflected the lessons about climate control, orientation and roof overhangs that have been learned in the past twenty years. Every house needs some solid wall space for privacy and a sense of shelter, but every house in the country also needs bigger windows to let people get more pleasure from living closer to the world outdoors. The living room should have one floor-to-ceiling glass wall shaded in summer and looking out on a planned view or a planned patio; and there is no good reason why strip windows in bedrooms should not come down to a sill height of 3½' or at most 4'. A 3½' sill is quite low enough to allow furniture below, and the very high (5' or 5½') sills in some recent bedrooms are very little help to ventilation in hot weather. Furthermore, needlessly high sills in a small room will give many people claustrophobia.

The coast-to-coast success of the Trade Secrets house proves once and for all that the desire for more light and air and more indoor-outdoor living is a basic, national trend and not just a California fad.

Tomorrow's house will have wider overhangs

Overhangs should not cost more than \$1 a sq. ft., and few features can add so much for so little in so many ways:

1. To make the house seem bigger (an added foot of overhang increases the perceived size of a house more than an added foot of enclosed space).
2. To keep the house cooler in summer (houses in Washington or St. Louis need a 30" overhang on the south and west exposures; houses in the South need 40").
3. To cut air-conditioning costs.
4. To keep rain off walls and windows and so reduce maintenance.
5. An overhang at least 2½' deep makes gutters unnecessary, lets rain run off the roof or sod where it will not spatter mud on foundations. This is actually better than downspouts, which concentrate too much rain water in one place.

**Tomorrow's house will be
better integrated with the land**

In a small house it becomes more important than ever to take advantage of the outdoors (p. 128), and the design of every house should begin with a good site plan. (This is much easier on a wider lot.) Unfortunately, local requirements and improvements are apt to be wasteful (like too-wide paving) and sometimes harmful (like putting the house 18" above the sidewalk), but standards for site planning are still far too low. A more attractive development will result from site grading following natural contours, and the one best way to avoid the raw earth of many projects is to save as many old trees as possible (many of these old trees should not be replaced for \$500 or even \$1,000).

The right house for one site will often be completely wrong for another site in another neighborhood. The house itself might best be considered as just one part of a site development, and even more broadly as part of the community development.

Tomorrow's house will include far more

**built-ins
such as beds, bureaus
dressing tables
bookcases
tables and benches
seven big reasons**

1. Young couples can afford far nicer houses if they do not have to spend thousands of dollars for furniture out of savings or on short-term, high-cost credit.
2. Most American families move frequently, often to distant cities. The more built-ins the house includes, the less furniture they will have to move.
3. Much better storage can be planned into built-ins. For example, with built-ins, the space usually wasted under beds without box springs is ideal for storing quilts, blankets, linen or clothing.
4. Cleaning around built-ins is much easier than cleaning behind or under movable pieces of furniture.
5. Built-ins can be financed over the whole life of the mortgage. FHA, VA, and the mortgage lenders should give them 100% credit in the valuation.
6. Built-ins permit more efficient space planning, make small rooms more nearly adequate in comfort.
7. Much of the cost of built-ins can be offset by savings on wall and floor finishes behind and beneath them.

At first, of course, these built-ins will have to be offered as optional features, for many families will prefer to use furniture they already own. But the trend to more built-ins is clear, and the time will come when most families will get most of their furniture as part of their houses.

Tomorrow's house will provide more

**sheltered space for
outdoor living**

What became of the covered porch almost every house used to offer—even very low-cost houses? A roofed terrace or breezeway with a concrete floor (p. 174) should not cost much more than \$2 a sq. ft. There is no better low-cost way to make a small house look bigger, no better way to make summer living pleasanter. Later on a breezeway can be enclosed to use summer and winter too.

Tomorrow's house will make far better use of

land for planting screens

The right fence in the right place is one best trick to make a small house look bigger (p. 172). It is also the one best way to let people enjoy big windows and indoor-outdoor living on a small lot without sacrificing privacy. Lenders should be glad to allow at least \$100 per house for fences.

Tomorrow's basementless house

**must have
basement equivalent
all-purpose space
above ground**

On most sites you can build a better, more livable house for the same or a little less money on a slab without a basement, but it is all wrong to think you can have a good salable house at all if you try to save \$750 to \$1,000 by leaving out the basement without making provision above ground for the storage and the activities for which basement space is so often used—like workshops or indoor play. The basement equivalent above ground need not involve anywhere near so much space. It need not necessarily be heated. It can often be provided in the garage (p. 170). In no case should it be less than 110 sq. ft. (In Canada many communities require a 125 sq. ft. minimum of added multipurpose space in all basementless homes.)

Failure to provide this basement equivalent above ground is, we believe, one principal reason for public resistance to the basementless house. The other is the builders' too frequent failure to provide adequate heat around the perimeter or to make adequate provision to keep the floors dry. There is no good reason why both these faults cannot be avoided economically.

A slab-type house rides closer to the ground, makes the house look longer, makes indoor-outdoor living easier by putting both on the same level.

Tomorrow's house will include more

split levels Split levels have been best sellers this year (notably in Long Island and New Jersey) and next year they will surely be offered in many more places.

Their advantages include:

1. Construction economy provided the site is level and provided foundations run down 3 1/2' anyhow because of frost (it may cost more if footing depths must be changed);
2. Just enough cellar space (but not too much) to provide for storage plus a play room and perhaps a garage;
3. This basement space will be shallow enough to permit full windows;
4. The garage can be tucked under the house instead of blocking windows along the whole side;
5. A bigger house can be squeezed onto a smaller lot if necessary.

Houses under 1,000 sq. ft. are too small for more than one level, and the split level is apt to be expensive on rolling country if it necessitates deeper footings.

Tomorrow's garage and carport will be

**planned to do double duty,
be for people
as well as for cars**

Already carports are being renamed carporches, garages advertised as "recreation rooms." For about the same money as a full basement, an 18' x 25' garage provides double the far more convenient storage, drier and better-lighted work space and game space. Carports will also do far more for the looks of the house by adding to its length.

Carports can be screened for outdoor living in summer. They should be designed for easy conversion to garages for all-year use later on, with one wall already in place to provide generous enclosed storage and so encourage home owners to keep their carports neat.

There is absolutely no sense to the too-frequent code requirement of a fire-resistant wall between house and enclosed garage.

Tomorrow's house is much more likely

to have an open kitchen

To almost everyone's surprise, the kitchen (p. 136) proved the most popular feature of the Trade Secrets house.

Women who spend half their waking hours in the kitchen do not want solid walls to cut them off from family and guests. Some provision should be made, however, for keeping the kitchen mess hidden from sight and for panels to close the kitchen off entirely at times (these can be installed for as little as \$42.50). All open kitchens should have powerful exhaust fans; most open kitchens would be much pleasanter with sound-absorbing ceilings; and all open kitchens would look much better if appliance makers would bring out a line in neutral gray instead of hospital white.

Tomorrow's house should include

**as many labor-saving appliances
as possible**

Women have more to say than men when it comes to buying a new house, and the kitchen makes a bigger hit with women than a kitchen fully equipped to make her work easier.

Builders seeking to profit by the proved sales appeal of appliances have a number of big advantages:

1. They can buy the equipment for much less than the home owner might have to pay for it at retail.
2. They can install it much cheaper as part of the original construction than they could install it after the house is finished.
3. In most states they can offer long-term financing for it under the package mortgage plan.

All this should save the purchaser money too.

Some builders make the equipment optional, others offer a fixed package. At the very least, all builders should provide wiring and space for all major appliances, most of which will be almost as common as bathtubs within a few years. Dishwashers and garbage disposers are particularly important, for they help make better neighbors by eliminating unsightly wash lines and garbage pails.

tomorrow's house will need

adequate wiring

Television sets plus electric ranges, automatic laundries, driers, dishwashers, attic fans, garbage disposers, refrigerators, room coolers, and all the other new electric servants require far more electrical capacity than most present houses are wired to supply safely or economically (p. 166).

It is much cheaper to provide adequate wiring (and water connections) when the house is built than to cut into finished walls to add new circuits later. At least one 220-v circuit should be included for major appliances. Low-voltage circuits will usually provide better switches cheaper.

tomorrow's house will give more thought

to noise control

In a small house with light partitions it is hard to get away from noisy talk, kitchen clatter or children's play.

That makes more noise control important. This can be achieved partly by using closets and fireplaces to create a sound barrier for the bedrooms, partly by more use of acoustic materials (for example, on the ceiling of an open kitchen).

tomorrow's house must provide

needed storage—and much more of it

The FHA storage minima are too low. Not less than 12% of the living floor area should be planned for live storage, not counting whatever provision for dead storage can be made in attic, basement or garage. The smaller the house the higher the ratio of live storage area should be. The efficiency of this storage space can be very greatly increased by the kind of intelligent storage planning that is reflected in most storage wall designs. To make these added amenities possible **tomorrow's house must**

take advantage of all the new construction economies—

Like roof trusses, precut lumber, tilt-up walls, precast plumbing stacks, prefabricated storage walls, the one-big-room plan for floors, ceilings, and perimeter plaster, modular coordination and dimensional standardization to reduce waste in fitting and permit more use of standard parts. Most builders could cut their construction costs well over 10% by training their crews to use these tested new methods.

Tomorrow's house

be designed with

more thought to how people will want to live in it

That means, for example, more thought

to how low furniture can fit the room,

more thought to how Mother can keep an eye on the children

while she works in the kitchen

and what she will see when she looks out through the kitchen window.

More thought to where people can sit to watch television,

and how people can get more fun from

indoor-outdoor living in summer.





People buy neighborhoods

And builders, to stay in competition, will have to house and community in one well-designed package

Cortlandt V. L.



Excerpts from the Round Table

HAEGER: A sense of well-being as far as shelter is concerned comes from three basic things: space, sunlight and a relationship to nature. That's where land planning should start.

GOODMAN: A big builder is capable of developing 200 acres. But the builder who builds ten houses a year can't develop 200 acres by himself, and what he does develop often isn't worth much because you can't do anything with a small land area. Why can't five builders in a community get together, through NAHB, and combine resources? Then they can afford to get the proper talent and financing. This way you could get one large tract that is well planned rather than five piddling tracts that are poorly planned.

PRENTICE: Do you agree that the developed land cost should normally be 15% of the sales price of the house? And that there is a trend for local requirements for site planning to be too low and requirements for site improvements to be too high? (General agreement on both questions.)

MANILOW: FHA's requirements average about 20%. They favor sidewalks, curb and gutter.

MAY: With wider lots, you can have just one basic house plan, twist it four ways and give more house for the same or less money.

GOODMAN: A square lot is better than a rectangular one because you can revolve the same house completely around the compass. This allows more privacy, better exposures, better use of the property by the owner. It is fallacious reasoning that you have to show the largest dimension of the house toward the street in order to sell it. Today the houses are so small you have to use the land for livability. In the old days we lived in big houses. Land wasn't as important, and people lived inside the house. Today people have learned to live outside the house.



Community character can come from trees, varied siting, rol

“Planned community” is a phrase with pulling power. But it takes more than a phrase to sell a neighborhood that hasn't yet been built, to convince a prospect that a model house and a raw stretch of potato field will grow into a neighborhood that he will be happy to live in.

Below are listed most of the earmarks of the modern, well-planned neighborhood. Builders who use these land-planning techniques actively sell them to prospects 1) by drilling their salesmen in the reasons why they offer greater livability, 2) by prominently displaying site maps, street scenes, an over-all aerial view of the community as it will appear when finished—attractive renderings by architect or artist which point out all the features the resident will find desirable for years to come.

What about the small builder who realizes the value of good land planning but doesn't control enough land to create ideal surroundings? He must pick his location carefully, for his few houses will be dependent on existing and proposed communal facilities. Or he could pool resources with two, or three, or ten other small builders, form a development corporation and control a big enough area to compete successfully with the attractions of the big builder's planned community. Largely unexplored, this joint-venture building holds potentials for more pleasant and orderly suburbs.

What makes a good neighborhood? There are books* on this broad subject that any developer, large or small, would find useful, and professional land planners, engineers and landscape architects who might be invaluable in solving local problems.

* Among the most practical: NAHB's *Home Builders Manual for Land Development*, Revised 1953 edition.

the marks of a good community, and the advantages offers the people who live there:

ION

ent communal facilities: a quick, safe walk or ride s, shopping, churches, recreation.

ent transportation: traffic artery; railroad or bus arby.

nuisances" (railroad, airport, express highway, factories, ramp): no noise, dirt, odors, unsightly views. Park strips n planting can be left as "buffers" to screen these unde- cements from residential lots.

rotection: a buyer wants clear title to his property, at will not permit future "nuisances" in the vicinity.

nd value, no slum potential: a buyer wants to know if ment will appreciate or depreciate, whether his property "right" side of town in a sound residential area or so at it can become less desirable and open to commercial trial encroachment.

le utilities and services: electricity, gas, water, sewage and paid for; no assessments. Police and fire protection.

ter table: less chance of leaky basements.

NT

ear streets, loops, short cul-de-sacs: less through- n in a grid pattern, slower-moving local traffic, hence less l greater safety for children. No long views of house-rows.

"Y" intersections: less dangerous than four-way "X" ons, smoother flow of traffic.

ocks: fewer cross-streets and intersections, less poten- affic accidents.

itted to the topography: if long streets follow con- uphill cross-streets are short and far between, residents e to do much climbing.

at parking: driveways, carports and garages not only individual resident's car in a more protected place, but ets relatively free of parked cars, which adds to ease of nd general appearance of the community.

ots: greater privacy between houses, more space at side or owners' gardens or terraces. Raw land cost per lot is ut improvements can be less: streets can be narrower are not as intensively used; drainage systems do not e so elaborate; sidewalks can be reduced or eliminated; n costs, upkeep and taxes for all improvements are lower. uch more attractive country atmosphere to offer the bdividers find people are willing to pay more for more ee "The Case for the Wider Lot," H&H, Jan. '52.)

garbage and laundry: garbage cans shielded from or eliminated by installing kitchen garbage grinders; s fenced from view or replaced by electric clothes driers ouse.

inage: grading and storm sewers that prevent possible ion of rainwater in low spots; no leaky basements or reets.

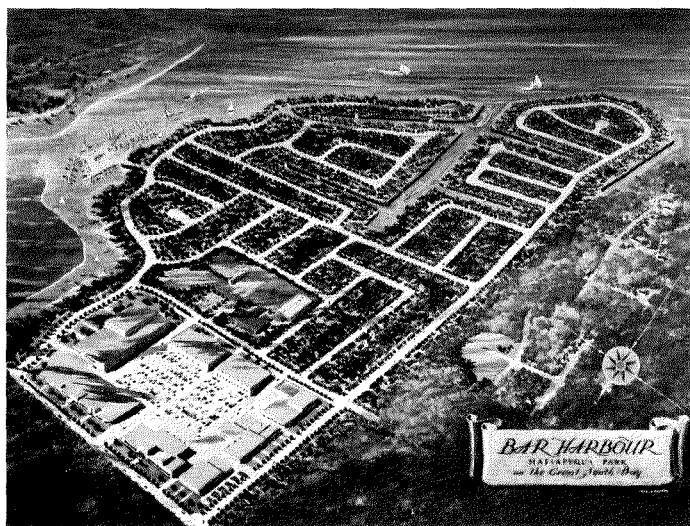

Self-contained community on Long Island (see p. 150) will have 650 homes buffered from traffic route by 30 A. shopping center, 10 A. school site. Lots are large (80' x 100' min.), widths varied, houses sited to save trees, setbacks staggered, long, straight streets and "X" intersections eliminated. Canals were dredged to increase water frontage. This mural rendering and aerial photos help sell community idea.

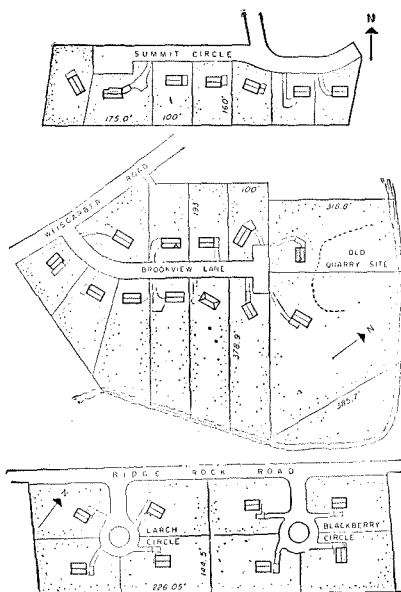

Short streets are quiet streets in this Knoxville neighborhood (above). Cul-de-sacs in bottom plan give houses square, off-highway lots rather than long, narrow lots facing thoroughfare. At right, 125-house project near Washington, D. C. uses a few garden apartments to shield homes from shopping area, highway (bottom). Contoured roads discourage through-traffic, give street scenes variety, saved cost of hill-doing.

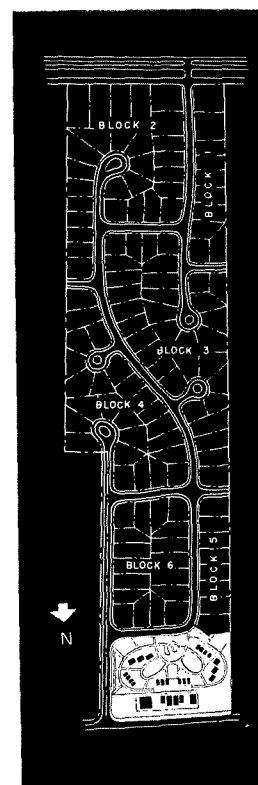



Architects: Furno & Harrison

Rolling, wooded land was a little harder to build on but added greatly to value of these East Norwich, N. Y. houses. White oak and mountain laurel were saved during construction, living rooms oriented for view, sun and summer breeze.

Architect and land planner: Eugene Sternberg. Photo: Guy Burgess

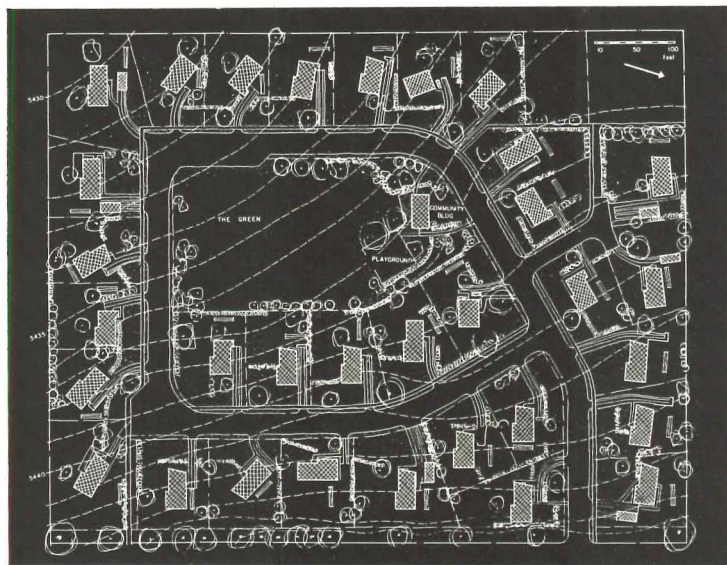
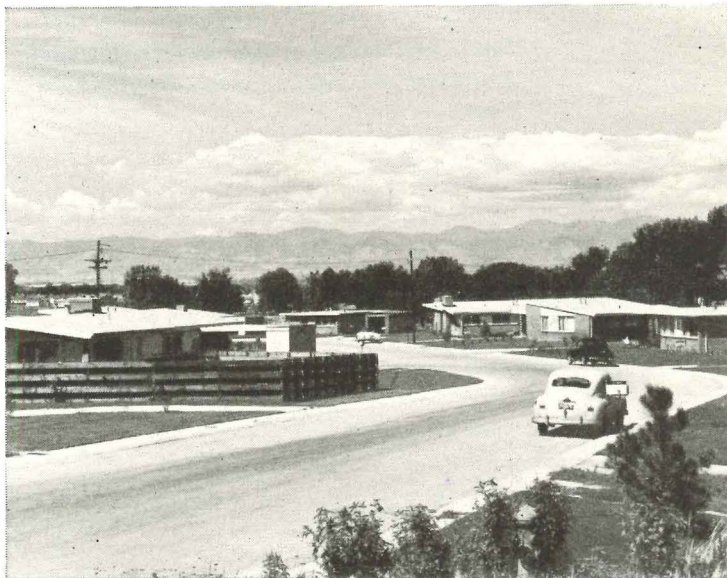

Smart siting of these 32 houses on 11½ A. near Denver gave them 1) views of the Rockies (off top left of site plan and photo) instead of each other, 2) south sun and breeze for major rooms, 3) varied appearance from street, 4) a loop layout that slows traffic, 5) a central "village green."

THE HOUSES

Proper orientation: placement of house and window to favor prevailing breeze through the interiors, especially the bedrooms in summer (or in very windy areas, placement of most windows on the lee side); roof overhangs to keep hot sun off big windows; window walls that look out on natural scenery or a private closed garden instead of the street.

Angled placement: often a by-product of good orientation, angled placement provides more visual variety than parallel rows of houses.

Staggered setbacks: further visual variety; a resident doesn't look down a line of "soldiers in a row" if some are set back by some 30', some 20'. This means privacy, too: windows aren't lined up directly across side yards.

Variety in design: enough different elevations, colors, setbacks and placements on lots to give individuality and interest, but not so many that street scenes become a hodgepodge and lose the feeling of a community.

Variety in price class: small groups of slightly more expensive homes near modest ones lend prestige and stability, help establish a community that will last longer than a big "housing project" where there are hundreds of houses of exactly the same price and appearance. Acre upon acre of uniformity often results in residents moving to a different community as soon as they can get something better.

NATURAL ASSETS

Trees and shrubs: a development that will stay attractive as greenery grows, not just a quick "prettifying up" the day before opening. Mature trees preserved carefully during construction and added afterward, have an obvious emotional appeal to most home buyers, who will pay more to get them (see "The economics of trees," H&H, Apr. '53). No so obvious: well-located trees can keep homes cooler in summer, cut down wind velocity before it builds up on wide, flat terrain, help deaden traffic and community noise, provide a pleasant smell and a little extra oxygen. Trees and landscaping at the houses themselves are as important or more important than straight lines of street trees. Instead of planting a miniature arboretum of the nurseryman's assorted surplus stock, use local varieties and ones that thrive best locally, reach a desirable size and spread without constant trimming. Flowering trees and shrubs are often overlooked as a community sales asset. Other good practices: careful stock piling of topsoil during construction for distribution during finish grading; good-quality grass seed adapted to local conditions; some sodding around model homes for immediate lawns.

Scenic features: a heavily wooded area, a brook or a pond can often be preserved and improved as a place for walks, playgrounds, swimming.

An identity as a community: most home buyers want to be proud of their neighborhood, whether it is a single street or a large development. Any community can profit by favorable word-of-mouth advertising from satisfied owners. This can be helped along by extra touches: 1) dignified, permanent architectural gateposts at the entrance to the street or community, like its name; 2) a home owners' association, started and helped along by the builder. This can assure proper maintenance of the community's appearance, enforcement of restrictions, can promote group social activities and in general build stability and permanence into a new neighborhood, to the credit of the builder.

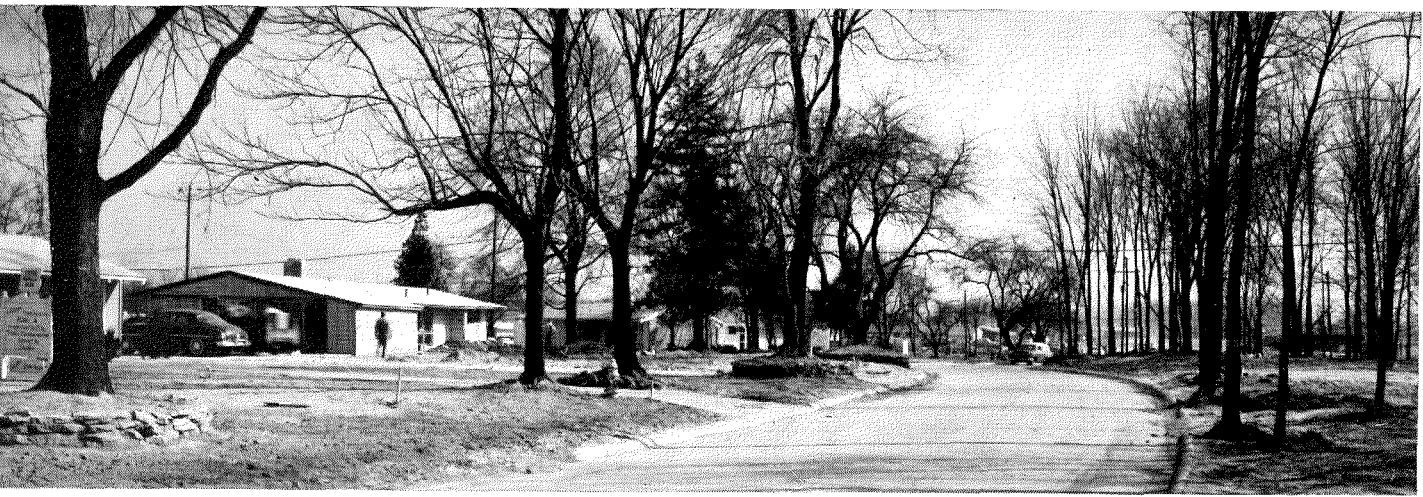

Designer-Builder: Don Scholz

Big shade trees, 80'-90' frontages and \$350 landscaping jobs helped to sell 43 of these \$17,000 Toledo houses in just nine days.

ARCHITECTS, BUILDERS AND LENDERS SAY ABOUT COMMUNITY PLANNING:

avenport, developer of Hollin Hills: "A good house in the eyes of the buyer is judged on siting, trees, lot size, exterior appearance and interior layout. One hundred feet is the premium lot width except in cul-de-sacs."

Spiegel, NAHB president: "The 'grid' pattern for subdivision is a thing of the past. Home purchasers prefer curved streets and cul-de-sacs to old-style road design. The lot for a good subdivision should be at least 75' in frontage by 125' in depth. Houses should be staggered and a serious effort should be made to conserve as many trees as possible."

Robald, executive vice president, Peoples Federal Savings and Loan Assn. of Peoria, Ill.: "To be salable at all, a good subdivision should be built in a neighborhood of similar houses accessible to major mass transportation and also to the housewife's shopping facilities. The lot must be 60' wide but 70' deep with a minimum of 12' between houses. Orientation is important for much more than it does but most people just underestimate its importance."

Satterlee, Washington, D.C. architect: "People like to live for themselves with a community when it has a character. Lot dimensions should be 70' to 80' x 120'. The best subdivision preserves the existing trees to preserve the character of the subdivision. Planting should not simply serve as decorative (as in the typical eight little evergreens all in a row) but should be placed with the same consideration for *defining space* as that partitions, etc. give indoors. The site plan should take into consideration to sun, view and breezes."

Wald, vice president, the Bowery Savings Bank, New York: "One of the most important phases in the marketability of a subdivision is that of original site and project planning. There is evidence that houses in an intelligently planned project sell for a value to a much greater degree than those which are planned or erected in neighborhoods that are nonexistent."

Yost, architect: "Good planning has to be explained, properly presented in advertising and by salesmen it can become a great sales tool. The space between houses should be 25% of the width of the lot. Planting is one of the most important things to get a builder to do, yet it gives much more value to the house. Orientation is extremely important and should be considered."

Waver, Standard Building Corp. of San Francisco, puts the emphasis in advertising on the desirability of the com-

munity which surrounds his houses. "People are looking for much more than just a house," says Schriver, "they're looking for a neighborhood, one that they and their children will be happy in for a long time to come."

Sam Russell, vice president and sales manager of Burns Realty and Trust, Denver: "Garbage-grinder units are not only a selling point, they are also an important factor in the maintenance of an orderly development, eliminating untidy garbage cans along the street." Burns emphasizes, as do many builders, that there be no extra costs to the buyer for paved streets, curbing or sidewalks, and that all utilities be in and paid for. Curvilinear streets are used throughout the subdivision.

Rodney Lockwood, 200-house-per-year Detroit builder, makes every effort to leave at least two big shade trees per house; where this is not possible large trees are transplanted. Each lot is graded and seeded front and back after adding rich topsoil, then landscaped with shrubs. The entire 80 acres are enclosed by a decorative white fence, neat lamp posts, rustic street signs.

Rossin and Ringler, Detroit, who built 250 homes last year from \$11,790-13,500: "Primarily, we do not sell houses. We develop and sell communities. The houses sell themselves." In their half-completed, 500-house subdivision of Chapoton Woods, they do "everything to foster and promote home-town pride. We have sponsored a property owners' association and help instigate community activities. We have dedicated a playground for children in a wooded area ideal for picnics. There is a private beach for the use of residents. Ask any resident where he lives; the answer is not 'St. Clair Shores' (the incorporated town in which the development lies), but 'Chapoton Woods.' Our promotions stress 'Chapoton Woods—a nice place to live.' It may be trite but it is true that the pride of ownership among the residents themselves is our best advertisement." The services of tree experts were retained to give the subdivision a parklike appearance, and the builders went to considerable expense to save as many of the trees as possible.

Sampson Bros. of Turtle Creek, Pa. offer four recreation areas in their 550-house community east of Pittsburgh, have built a sewage disposal plant and donated it to the township. Sampson stresses the community angle through talks to local PTA's and schools. In the garage of each of three model houses is a display room with pictures of all the major features of the houses, plus pictures of school, playgrounds, proposed shopping center, etc., to help prospects visualize the completed community.



Excerpts from the Round Table

PRENTICE: Architects seem to feel that one of the next major moves in the small house should be the inclusion of more built-in furniture, and that furniture can be built into the builder's house very inexpensively. One builder surveyed his buyers and found his average house furnished with two camp stools and a card table, because they literally had no furniture.

ANSHEN: I think you can take a small, very inexpensive house and put in a built-in bench and a built-in dining table at little cost. Then all they have to do is put a pad on the bench if they want to.

GOODMAN: Timber-connecting trusses give us flat ceilings and are quick and easy to put up. But they do depress the interior space. If you use beam and bridging you get a ceiling that slopes up toward the center. The same square-foot area looks larger.

MAY: In one of our models, our decorator had underfurnished the house and underscaled the furniture. This model sold 65% of the houses, and we couldn't figure out why. We started checking. We found out that the people who came in said, "You can't fool me; this is the biggest house."

ANSHEN: We have a really wonderful FHA office but it took us a long time to persuade them to let us put all our living rooms in the rear. The underwriter said, "We would go right along with you if you were going to build five or ten, but how do we know 51 people are going to want rear living rooms?" The real estate salesmen said the same thing. But we built one anyway, and sold all 51 of them in ten days, because it was so reasonable, when the public looked at it, to have your living room in back and your private backyard right outside. It created a trend, and now it is difficult for local builders to sell front living rooms.

LEMPERLY: We are making a survey of builders' opinions on color, both exterior and interior, and up to now 96% of the replies say that color is a positive factor in selling a home. Over one-half thought that color would be more important as a selling factor in the days ahead than it has been to date.

Are you giving your up-to-date buyers a big, ple well-arranged space they can use and enjoy? Or are the storing their prize Chippendale in it and most of their living in the rumpus room or the kit

Not so long ago the living room was the major room in the house. In some of this year's houses, however, it looks as though it has been trampled in the rush toward breezeways and back porches, all-purpose kitchens and double-duty garages. The more glamorous sales features has in more than one case squeezed the living room down to a mere dog-trot with a "patio window," or a highway traffic circle connecting the rest of the rooms in the house.

Whether or not you increase the actual floor area of your present living room, there are a dozen good ways you can make it *look* bigger—and *live* better:

Square it off—a long and narrow space is rarely as useful as a squarish one. A 10' x 25' living room would be greatly improved by being made nearer 16' x 16', which would not increase its area.

Open it up—throw living, dining and kitchen areas together so they can borrow space from one another. The effect of an open room, if handled well, is better than that of three small rooms.

Give it bigger windows to extend the apparent size of the indoor living room to an outdoor living room—a porch or terrace. With large glass areas properly placed, the fourth wall of the living room can become, visually, the fence on the far side of a garden or terrace. *Two* exposures will help any living



Architect: Joseph Miller. Builder: Bert M. Tracy. Photo: Robert C. Lautman

... and a real view. A picture window is next to useless if it frames nothing but a busy street or a rear-yard vista of someone else's garbage cans and laundry. Take advantage of a scenic view of the site, if there is one, or create a private garden for each house by using opaque fences. (See story p. 174.)

Inside, the well-planned living room can make use of:

An entry hall, which is the first good or bad impression a visitor gets of a house. The front door should not open directly into the living room; it should be shielded by a wall, a cabinet or space divider that creates some sort of entry area

living space—the floor plan of the living room should accommodate a reasonable amount of furniture arranged in several conversation groups. Major traffic should never go through these areas, but hug one of the short walls where no door is placed, or go in a straight line directly between living and dining. The “dead end” type of living-room plan can be avoided by keeping circulation out of sitting space. To test a living room before it is built, builders and their architects could well use a technique from some of the big mortgage appraisers: set out a set of miniature templates to 1/4 scale representing chairs, tables, etc., arrange them on the proposed floor plan to analyze circulation and furniture placement.



Architects: Anshen & Allen. Builders: Cavello & Perego. Photo: Roger Sturtevant



Architect: Fickett. Builder: Ray Hommes. Photo: Maynard Parker

—the more furniture you can “get off the floor and onto the walls,” the bigger a room will look and the more square area will be usable for moving around. All of these living- and dining-room furniture can be, and often are, mounted into the wall: bookshelves, buffet sideboard, chests of drawers, desk, couch, bench, bar, radio-TV-phonograph, some lamps, storage for card tables and games. A living room can have all the same amenities with built-ins, do a better job of it and be a lot less cluttered to a customer. Built-ins shown in a house could be included as optional “extras” to buyers.

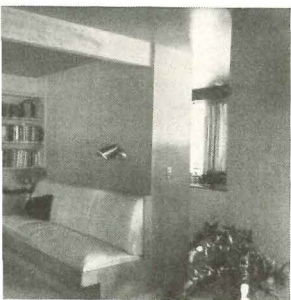

Architect: Richard Neutra. Photo: Ann Rosener

Architects: Butterlee & Lethbridge. Builders: Luria Bros. & C. Lautman



Photo: Monsanto Chemical Co.

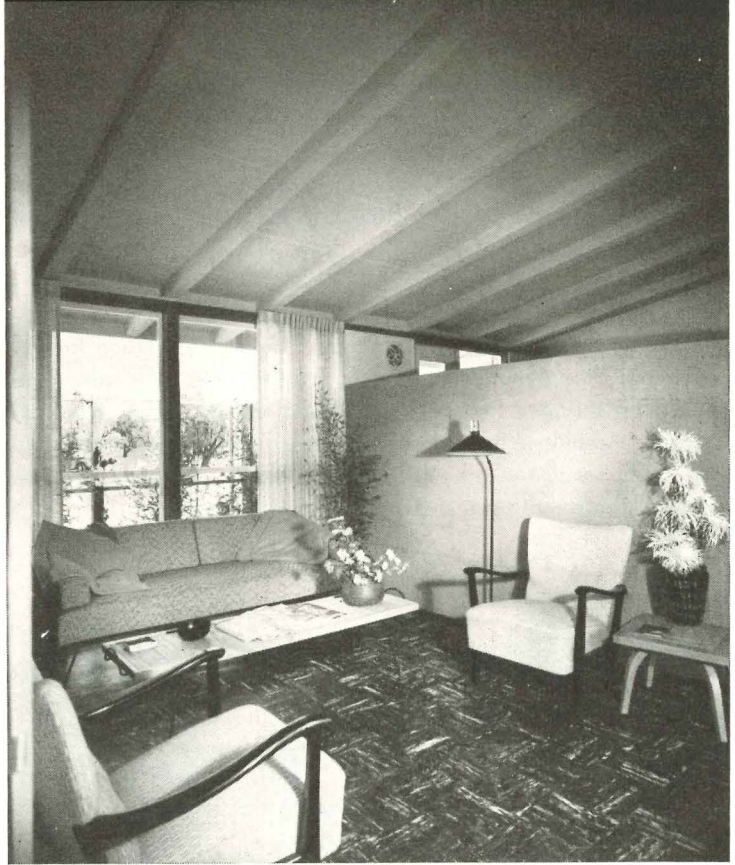

Architect: Cliff May. Builders: Stern & Price. Photo: Maynard Parker

Sloping ceilings give greater actual height and a more spacious feeling than flat ceilings. Exposed ceiling beams are decorative and yield still more height. The monotonous, heavy expanse of any ceiling can be broken up by the texture of roof decking.

“Through” ceilings—interior partitions that stop short of the ceiling allow the eye to carry across the top of one room into the next, which adds space and more through ventilation to each. The high opening above the wall can be filled with glass to cut down sound transmission if desired.

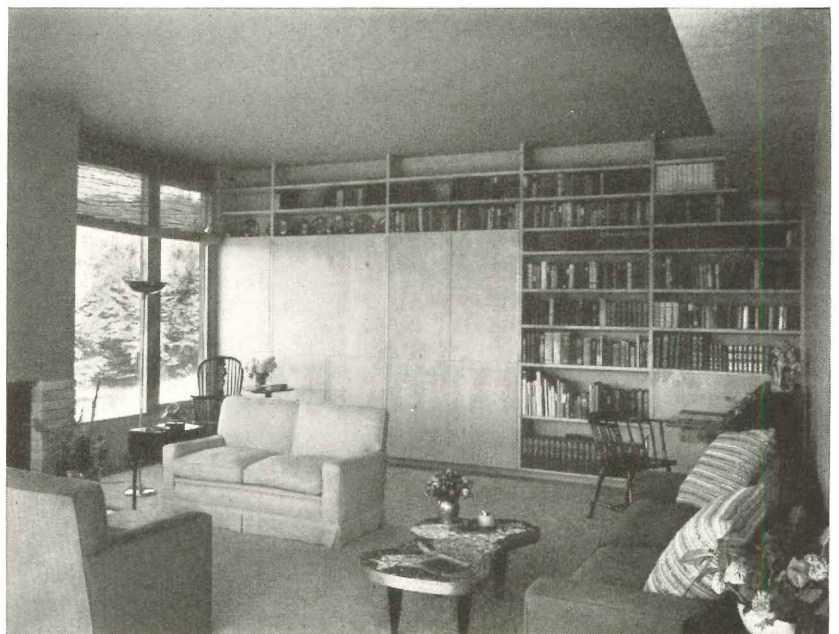

Architects: Clark & Beuttler. Photo: Roger Sturtevant

Thin furniture—what movable furniture a builder uses to demonstrate his model can also suggest spaciousness. Many modern pieces are strong and comfortable without being big, and if they are small in scale, without high backs, overstuffed arms and slip covers that reach the floor, they will leave a lot more apparent light and air around them.

Change in level, either in ceilings or floors. A higher formal ceiling in a living room can provide a feeling of space when contrasted with intimate lower ceilings of adjoining dining area, hall or study. A sunken living room or hearth area can achieve the same effect, but can also be a hazard unless two or more steps are used and protected against falls. (Photos below and right.)

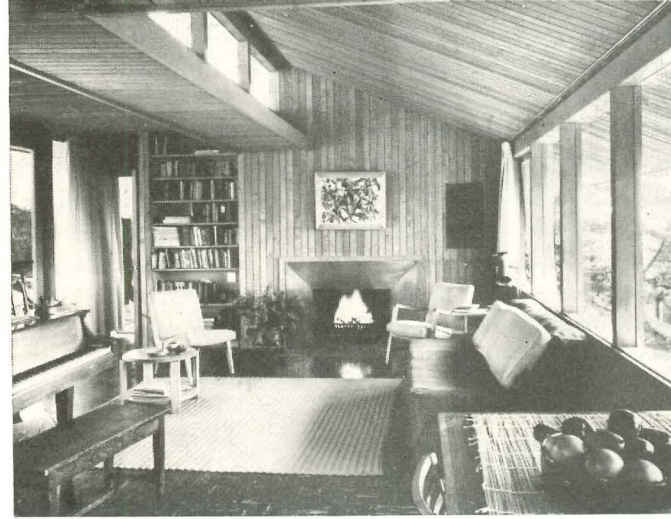

Architect: Roger Lee. Photo: Theodore Osmundson

Top lighting—a change of ceiling level can often be accomplished in conjunction with a clerestory window or skylight. In some advanced builder's houses, these are effective in giving interiors more light, air and spaciousness. (Photo above.)

Flexible adjoining rooms—an open dining corner or a bedroom that can be thrown open to the living room add just much more space to living areas. (Photo below.)



Architect: Percival Goodman. Photo: Alexandre Georges



Architect: Eugene Sternberg. Builder: Edw. Hawkins

Architects: Keyes firm. Builder: Luria Bros. Photo: Robert C. Lautman

One textured wall—a decorative asset that also helps to dispel the claustrophobia four identical wall surfaces can create. This wall can be paneled in many materials: wood planks, walnut, birch or mahogany plywoods, panels of pressed wood chips, several varieties of brick, etc. (Photo right.)

Color—a complex problem best solved with the help of a professional color consultant. In general, though, a room can be made to look larger by using "receding" colors (neutral tones and "cool" ones in the blue end of the spectrum) rather than "advancing" ones (bright shades and "hot" colors in the red end of the spectrum). In open plans, it is important to key living, dining and kitchen areas to the same color scheme.



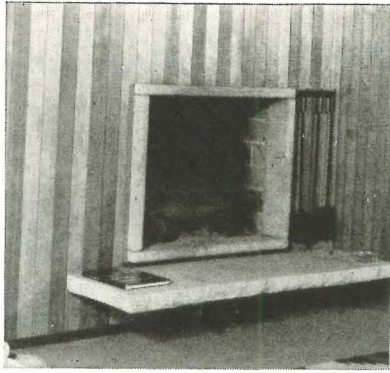

Architect: Paul Kirk
Photo: Dearborn-Massar

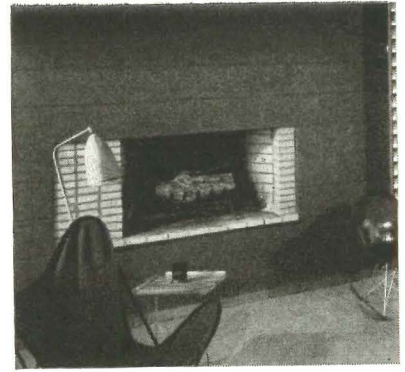

Designer-builder: Edw. Hawkins
Photo: Guy Burgess



Builder: Luria
Robert C. Lautman

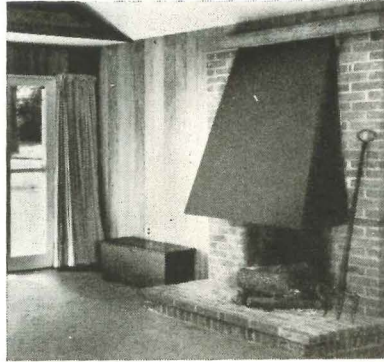

Architect: Robert W. Kennedy
Photo: Fred Stone

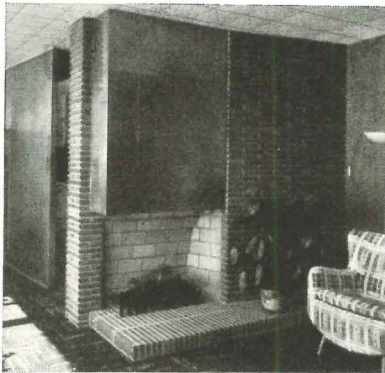

Architect: Eugene Sternberg, Builder: Edw. Hawkins
Photo: Guy Burgess



Architect: George Hay, Builder: Arters Bros.
Photo: Cortlandt V. D. Hubbard

Why not

Feature of the fireplace? It doesn't cost much more to give a fireplace a "custom" look: raise it 6"-18" off the floor so it can be seen better and tended more easily; build in a wood paneling to it or under it. Or project the hearth into the room. Or install a metal hood over it. Or make it a corner of a two-story fireplace that can be seen from both living and dining areas. Or reduce its bulk by leaving the upper half of the flues exposed.

Television? Some builders, like Ray Hommes of Los Angeles, are beginning to offer TV sets in the mortgage, bought at a price without cabinets and built into special storage compartments into the fireplace wall. Others offer a specially designed cabinet where the owner can install his own set. (Photos right.)

Hi-fidelity equipment? Now that big manufacturers like General Electric, hi-fi field and mortgages cover more and more appliances, it may not be long before a \$25,000-house builder includes hi-fi in cabinetwork for a 15" speaker, amplifier, radio, TV and graph—even offers the equipment as an optional extra.

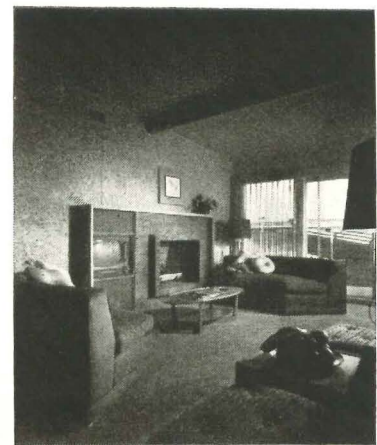
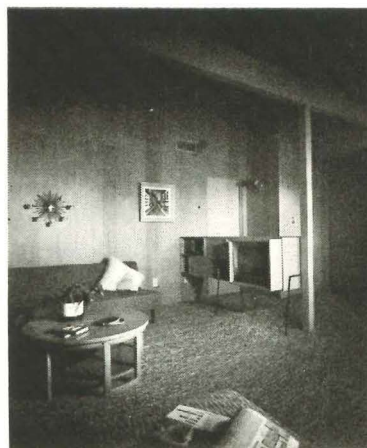

Architect: Edw. Fickett, Builder: Ray Hommes
Photos: George de Gennaro



Excerpts from the Round Table

GERHOLZ: We built a Trade Secrets house with the open kitchen, but we put in sliding wood doors on a triple track so that the woman working in the kitchen has a full view of the living area or can screen off the kitchen when she has guests. I don't think I will ever build another closed kitchen.

KOBICK: Color, when it comes to appliances, is a serious problem. Somebody wants a specific hue of rose red or Ivanhoe blue. With the terrific number of items that go into a kitchen, color would necessitate a fantastic inventory.

YOST: Why not take a neutral buff color, which would blend with everything, and match nothing, as a starter in getting away from hospital white?

GOODMAN: If manufacturers just produced one color, gray, along with white, they would immediately open up a whole new avenue of decoration in the kitchen. Gray is neutral and allows unlimited color schemes. White "bleeds" any other color in the room.

PRENTICE: Do you agree that you must have an exhaust fan in the kitchen? (Consensus of "Yes".)

GOODMAN: It should be a big fan with enough capacity to pull the air out.

ANSHEN: For builders' houses, there should be a special packaged unit so that we don't get cracks that collect dirt between refrigerators and stoves and counter tops. If the large components could be made so that they could be installed as one unit it would save the builder money, and it would save a certain amount in the manufacture. The oversize exhaust fan could be part of the package.

KOBICK: We think that by standardizing appliances, which we have been working on strenuously for a number of years, we can bring into being enough component units, including the sink, to eliminate many of the cracks. All these units could have one continuous top.

SPIEGEL: I use an acoustical ceiling in the kitchen; it costs me about \$60.

SATTERLEE: If you use the acoustical tile with the plastic film surface, you can wash grease off it, so it is perfectly easy to maintain.



This open kitchen has low walls, continuous counters, sliding-door cabinets.

Architects: Anshen & Allen. Builder: J. Eichler. Photo: Ronald Partridge

If the woman has the last word in choosing the house (and we know of no statistics to the contrary), she'll usually get the last word in kitchens. Here is a checklist of 25 ways to win her heart and her husband's signature. How many of these salable features does *your* kitchen offer her, and how well are you pointing them out?*

Layout

1. *Proper location of windows.* Can she see someone approaching the house? Can she watch the children playing indoors and outdoors? Does she have to walk far to open the front or back door? Is the service entrance convenient to kitchen, laundry, garage? Can she get from kitchen to bedrooms and to a bathroom without going through the living room?

* A more detailed study of kitchen design and planning standards, along with many new "idea" kitchens, will be presented in next month's H&H.

opening or pass-through counter to the dining area (other than door) that can be left open for serving, sociability and a feeling of greater space, yet closed off during formal occasions by sliding panels, curtains or blinds.

Convenient arrangement: sink, range and refrigerator close enough together so that the "work triangle" formed by them measures less than 20' (but more than 12') overall.

Clear traffic across this work triangle.

Place for eating in the kitchen with a built-in table and bench or a breakfast bar with stools. Surveys indicate that most families eat far more meals in the kitchen than in the dining area.

Stairs that do not obstruct a work space or an appliance when landing open.

Range

Enough cabinets—at least 9 lin. ft. of base cabinets, preferably 12 lin. ft. or more; at least 5 lin. ft. of wall cabinets, preferably 8 lin. ft. or more. Difficult corner space can be utilized with various types of "merry-go-round" shelves. Sliding doors for wall cabinets eliminate the danger of bumped heads; glass-fronted cabinets show quickly where things are, protect them from dust.

Special storage for special items, located at the point of actual use: vertical slots for trays and platters; shallow, divided drawers for silver, linens and small utensils; ventilated bins for vegetables; swing-out shelf for the electric mixer; a swing-out trash can mounted on the door of the under-sink cabinet; a chute to an outdoor container for cans and bottles.

Built-in refrigerator, out of the way (in the wall if possible), with space above used for cabinets for cereals and mixes. The refrigerator placed so that its door does not swing open to obstruct a work area.

Countertops

Enough counter space—at least 7 lin. ft., preferably 9 lin. ft. or more, not including the sink.

Properly located counters, at least 1'-6" wide on both sides of the range; on one side of the range, and on the opening side of the refrigerator.

Break-down counter or "kitchen office"—a place for telephoning, writing menus and household accounts, sewing, reading recipes, washing vegetables; shelf for cookbooks.

Chopping block or breadboard at least 2' wide, either fixed as part of the counter top or as a pull-out leaf just under the counter.

Smooth, washable work surfaces that won't collect dirt, scratch or stain, yet not so hard they will create clatter and break dishes.

Protectable walls, with special protection above the range, where fire is bound to spatter.

Warm colors, a minimum of "hospital white" in walls and ceilings, especially when an open-kitchen plan exposes them to view from the dining area.

Resilient floor to save the housewife's feet, yet one that is easily cleaned with a mop (e.g. rubberized or plastic tile).

Acoustical ceiling and/or walls to cut down kitchen noise, especially when the kitchen is partially open to dining and living areas. Plastic-faced acoustical tile absorbs sound, is washable.



Choice of kitchen types added sales appeal to this Los Angeles development house. Equipment is standard, but floor plans vary from open to closed, from square to oblong. Architect: E. Fickett. Builder: R. Hommes. Photo: Maynard L. Parker



Eating counter can double as a "kitchen office" in this handsome custom design. Fluorescent tubes under ceiling-hung cabinets light work surfaces. Architect: O. Stonorov. Photo: Cortlandt V. D. Hubbard



Architect: Clothilde Woodard Smith
Photos: Rodney Morgan—Photolog



"Island" kitchen can be wide open to dining and living space (right), or curtained off completely when necessary (above).

Equipment

19. *Good lighting*, both *general* (ceiling lights, indirect cove lighting) and *local* lighting (spots, strip fixtures under wall cabinets, valance lights) at all work areas, so placed that the housewife never works in her own shadow.
20. *Adequate ventilation*: an exhaust fan directly over the range and really powerful enough to remove odors against the pressure of an outside breeze.
21. *The major appliances* now regarded as standard equipment in many kitchens. In addition to range and refrigerator, a builder can include at cost in the purchase price: dishwasher, mechanical garbage disposal unit, freezing compartment or separate freezer, and clotheswasher and drier in adjoining laundry space.
22. *A TV set or a small radio* built into the wall, in either the eating or working part of the kitchen.
23. *Wall ovens, counter-top burners*—several types of “decentralized” cooking equipment on the market give a kitchen a custom-built look, with ovens built into the wall at a height that requires no stooping, burners built into a stainless-steel top in the continuous work surfaces.
24. *An indoor barbecue*, built into the back of fireplace wall or with a flue of its own.
25. *A serving cart* on rubber tires or casters that can be used for setting and clearing table, or as a movable, auxiliary work surface.

As a merchandising scheme, the fully equipped “all-electric” house has paid off for these two builders:

Builder Arthur Oman, of Weymouth, Mass., convinced that people are demanding more and more equipment, includes an all-electric kitchen and laundry with \$3,000 worth of appliances in his under-\$30,000 houses. He has tied in with GE's “Young America house” promotion campaign, attracted tremendous publicity and thousands of visitors to his development in suburban Boston where he sells houses ranging from \$14,000 to \$35,000. As proof of the sales appeal of the fully equipped house, Oman cites this comparison: he started two developments about the same time in the same \$14,000-\$18,000 bracket, one of 15 homes without equipment, one of 50 all-electric houses; the latter sold out weeks ahead of the smaller number of unequipped houses. Oman considers his tie-in with the manufacturer the best merchandising plan he has used.

Builders Watkins & Richter of Glen Head, N. Y. advertise their model as the “Hotpoint House of the Fifties,” include no less than *six* major appliances in their sales price of \$25,500: range, refrigerator, dishwasher, deep freezer, clothes washer and drier, all arranged in a roomy kitchen and adjoining laundry. Hotpoint sells the appliances to the builder at normal discount, shares advertising costs. Architects Matern & York designed the kitchen “to sell the house,” built in a dining corner with table and bench, extra shelves and cabinets included. Watkins & Richter are also among the first builders to use remote-control touchplate wiring throughout, explain its advantages with a demonstration model in the garage sales office.

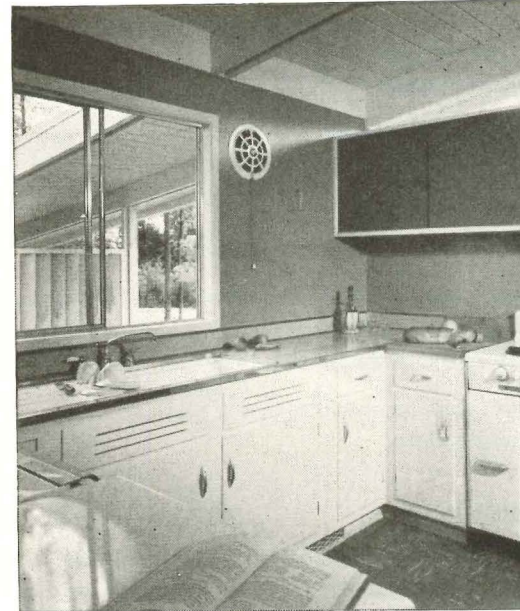

Big window over sink gives housewife a pleasant view of these Virginia builder houses. Note glass gable window which adds light, cabinets with sliding doors of hardboard. Architects: Keyes firm. Builder: Luria Bros. Photo: Robert C.

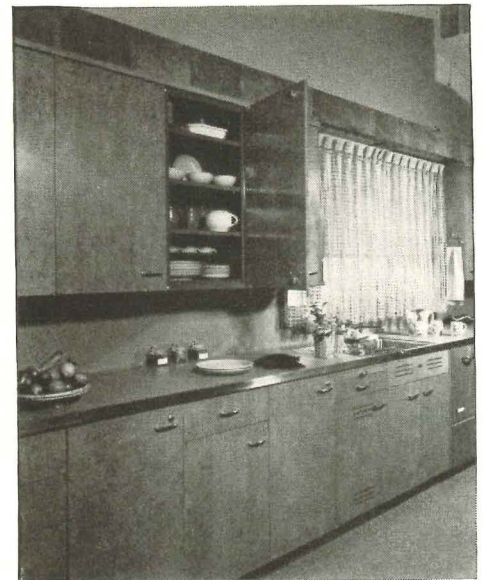

Natural wood or pastel-colored cabinet fronts are almost a necessity in open kitchens which are seen easily from the living room.

From St. Charles. Photo: Hedrich-Blessing

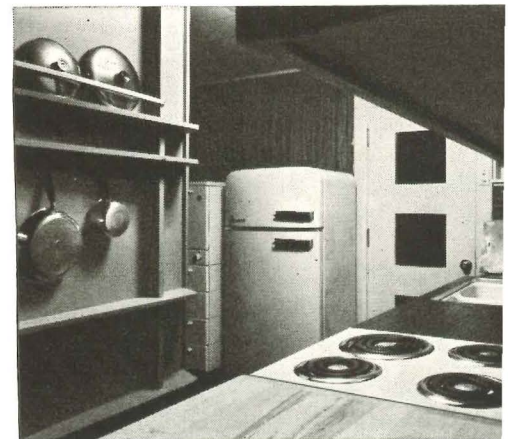

Extra features can add appeal to any builder's kitchen. Special storage racks are provided here for pots and burners are built in flush with counter top.

Architects: Smith & Hegner. Photo: Guy Burgess

When in any \$14,000 house is kitchen-dining-combination (1) by Place & Co., South Bend. So large it affords expansive dining space, area for children. 2. Floor plan shows how right has utility room with laundry equipment, fully close but separated. In alternate plans is so spacious it can double as playroom, or multipurpose room with curtain or slid-shut off laundry equipment. 3. Photo below for Place kitchen large enough for regular meals, children's play, and entertaining guests.



1

Place kitchen photos by Priddy-Tompsett Studio

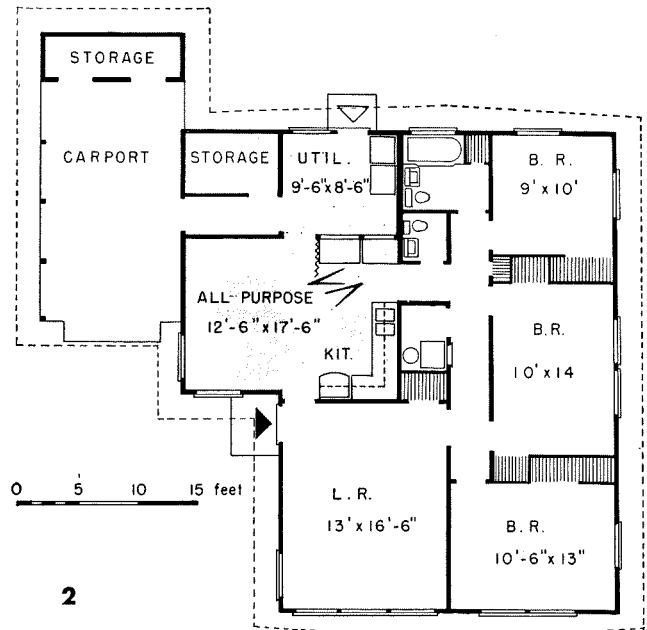

2

Wind Co.

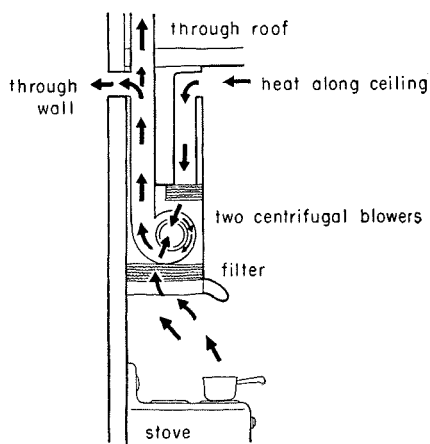
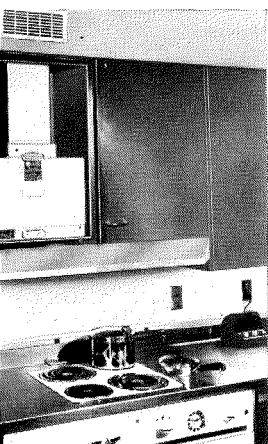

with powerful centrifugal blowers close to stove odor problem of open kitchen. Added features: make and outlet, removable filter.

Photo: In-Sink-Erator Co.



Garbage grinder and a stainless steel counter and sink are features that woman buyers like. Floors must be easy on housewife's feet, easy to clean and long-lasting.



Excerpts from the Round Table

DAYTON: I predict that within as short a time as three years, one-bathroom houses will be completely finished. They won't sell. There has to be a minimum of a bath and a half in every price class.

SPIEGEL: The most successful developments out on Long Island are the ones featuring the three-bedroom house with one bath, and for \$2,000 more a buyer gets an extra bath, a garage and other extras. They sell a lot of those two-bathroom houses.

GOODMAN: The average builder house has a miserable little medicine cabinet in it.

SPIEGEL: That is rapidly changing now with more vanities coming in all the time.

GERHOLZ: Prior to the large medicine cabinet, we put in two cabinets, one at the right and one at the left, and that doubled the mirror space. It was a compromise to give a little more storage space. There is nothing new about that. You can put that in the cheapest house.

GOODMAN: The bathroom is the most poorly lit space in the house and the room in the house which most needs good lighting for the housewife and for the husband's shaving—I want to stress that point.

GERHOLZ: I recommended a valance light, at the risk of having to dust it once a year.

YOST: A strip light over the mirror is very good. Use two 40w fluorescents over the entire mirror with a plastic cover, to light up the whole bathroom. Another thing I like to do is to put in a light which is halfway over the tub, centered. When you pull the curtain on the shower you are not in the dark. It serves as general illumination.

GERHOLZ: I think by actual test you will find the tube light, valance fixture or anything else overhead, is the finest light. We conducted some experiments on that. This expensive tubular vertical light hooked on medicine cabinets is absolutely no good.

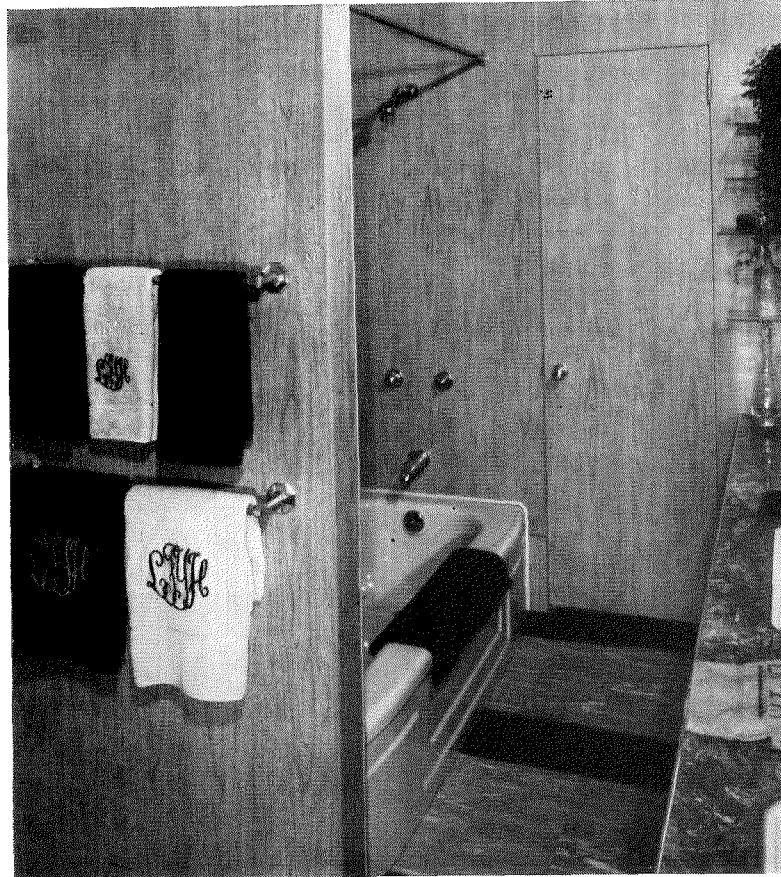

Plastic-finished panels provide durable, colorful, maintenance-free surface

Here is a digest of a comprehensive study of the bathroom published by HOUSE & HOME in February, 1953. Builders everywhere were overwhelmingly in agreement that these built-in features will add needed sales appeal—many at little or no extra cost.

In the one-bathroom house, to take the kinks out:

- ▶ Add more storage space: a bigger medicine cabinet with sliding, mirrored front; recessed clothes hamper beneath basin or in wall; cabinet space over toilet tank for towels and toiletries; shelf space on washbasin or along wall.
- ▶ Install an exhaust fan vented to attic space or through roof.
- ▶ Add auxiliary heat either in combination with a light or in wall.
- ▶ Provide a bigger washbasin with a wide, flat rim or shelf back, or use a counter-topped sink.
- ▶ Put in double or triple electrical outlets (out of reach of the tub) for sun or heat lamps, hair driers, electric razors.
- ▶ Use bath enclosures of plastic, glass or glass fiber for showering in tub.
- ▶ Provide more towel racks for drying nylons as well as towels.
- ▶ Put a grab bar on the wall next to the tub.
- ▶ Install general and concentrated lighting for grooming activities.
- ▶ Use colored bath fixtures.
- ▶ Provide durable, easily cleaned walls of ceramic, plastic or waterproof covering.

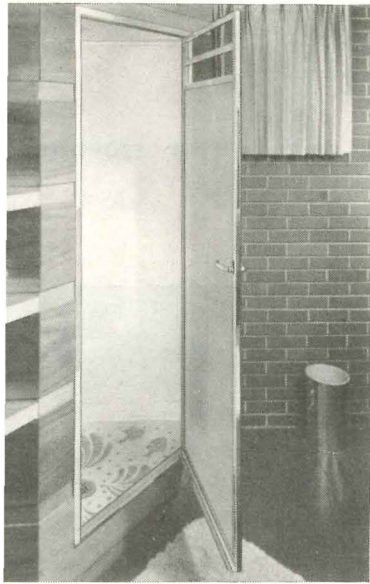

Stall or cabinet shower, bought as a package, is particularly popular feature in two-bathroom house.

g. Co.

Kohler of Kohler



Cabinet-lavatory, above, doubles as dressing table. Plastic tile lines recessed area with shower-size tub. Note handy grab bar.

ty is dividend of two basins in new nc. houses Knoxville, Tenn. Cabinet reaching full ceiling height, has slid-perforated to reduce sound transmission, age space replaces space usually wasted, achieved by building in odds-and-ends inexpensive plywood.

Monsanto, US Plywood



garty, Jr.

Formica Vanitory

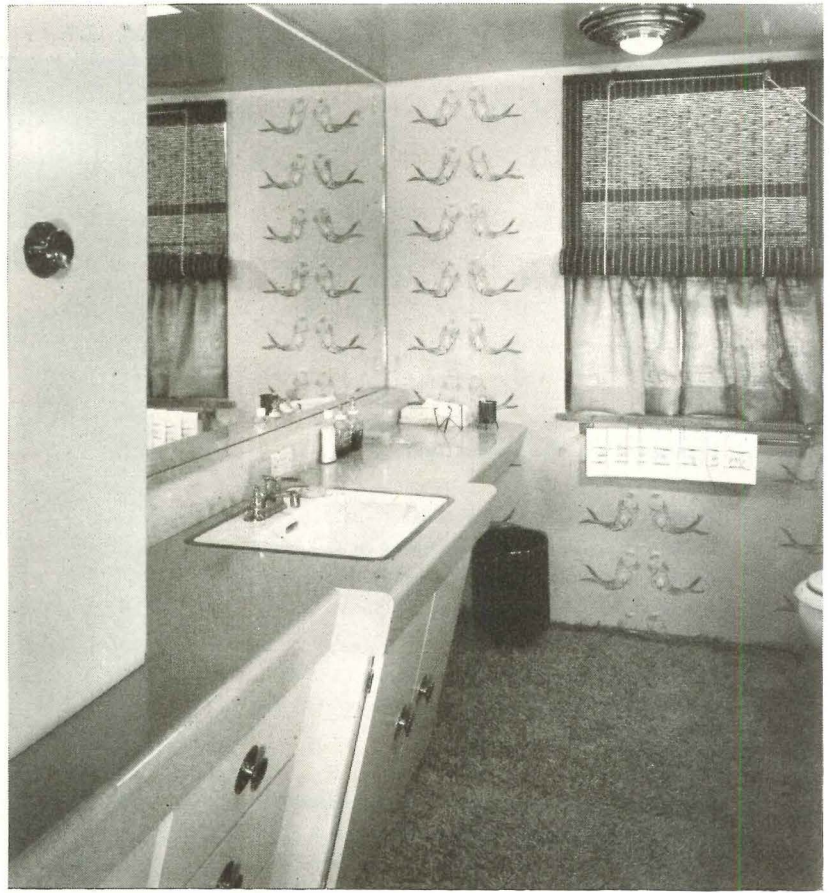

Smartly slanted storage unit makes greatest use of floor area while providing drawers and doors for everything. Top is plastic laminate.

In the bigger bath, these additional features add beauty, utility:

- ▶ Compartmentalize fixtures with space frames, a section of wall or sliding partitions or doors.
- ▶ Use more built-ins: bathroom scale, magazine shelf or rack near toilet.
- ▶ Provide a double basin with large counter top.
- ▶ Install a full-length mirror.

In the extra half-bath or second bathroom:

- ▶ Use a cabinet or stall shower.
- ▶ Provide a dressing table so it can be used as a powder room.

Alternate to the half-bath or second bathroom is an extra wash-basin in the master bedroom screened off in a closet.



Bedrooms need more space and better storage

Maynard Parker



Excerpts from the Round Table

ZUZAK: The small bedroom in the Trade Secrets house is a mistake. We are trying to sell the woman and she is not convinced of the desirability of the small bedroom.

GOODMAN: 12' x 12' is a nice room; 12' x 14' is a little better. Anything under 12' x 10' is a little ridiculous.

ANSHEN: You might make the first bedroom 12' x 15' and then have three cubicles 8' x 10' with a walk-in closet for each. If you took the space you saved and added it to the hall in front of the cubicles you would get a second sitting room. In other words, you create an extra room from space wasted most of the time.

MAY: I think bedroom furniture is going to be built in, in future. For six or seven years we have been building beds into the master bedroom. From the start we were called back to build beds in the rest of the bedrooms. They made it easy for the housekeeper. She did not have to vacuum under beds and she saved money not having to buy carpet to go under the bed. We use 2 x 4's on edge and leave asphalt tile under the bed section and then fit in the box springs. For headboards we use a birch door. That costs \$8 and the whole frame is \$10. If the beds are in a corner we pivot them.

PRENTICE: What about window heights? At what point can the demands of modesty and the necessity of putting furniture under the window be reconciled with aversions to claustrophobia and the needs of ventilation?

GERHOLZ: A good compromise for the sill height is about 42".

GOODMAN: We advocate exhaust fans to get positive ventilation, particularly at night. For comfort ventilation has to be low enough so that the air pulls across the bed. If your window is up in the air, how are you going to get air to move across your body? We run our windows all the way down to the floor and have ventilation at the floor level.

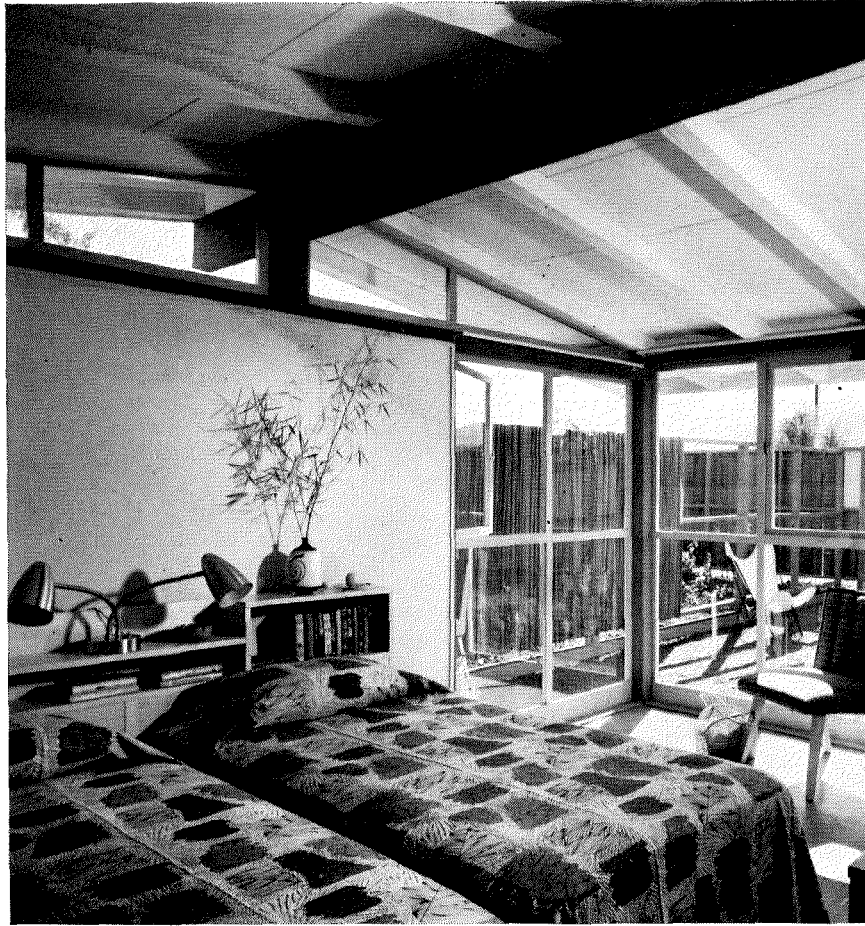

A big glass area makes a bedroom appear larger.

Because so little has been done to glamourize bedrooms in a builder's house they offer a great chance for improvement. A builder setting out to improve his house should adopt an attitude of "How can I make this room more attractive?" rather than "This room is about as good as anyone else is doing."

Here are five features builders have found successful:

1. Make the room larger. Surveys show people want larger bedrooms. Better designing can turn hall space into bedroom space.
2. Make the room seem larger than it is by using light colors, higher ceilings, windows that carry the eye outside. Borrow light from adjacent space with a partition which has a top section of glass or plastic. Demonstrate under-scaled furniture and built-ins in the furnished display house.
3. Storage facilities are the best-selling feature for a bedroom. Included should be shelves, drawers, storage for separate items including out-of-season clothes and for clothing of different lengths.
4. Windows should be restudied by many builders. In hot climates many people don't like the high windows, especially if both windows are high. Breeze blows in one, out the other with no benefit to the occupant. Nor can an attic fan help, as all the moving air is at ceiling height. High windows, devised to allow for beds or chests beneath, are now much higher than they need be for this purpose. Best reason for high windows is to provide privacy.
5. Built-in furniture has many advantages, especially for a young couple without furniture or the money to buy it.



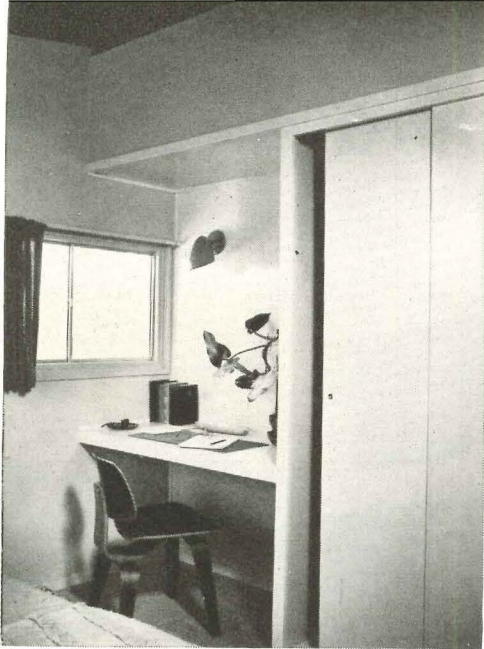

Built-in furniture, such as this desk in Luria Bros.' house in Fairfax Co., Va., is always a sales asset and suggests multipurpose use of bedroom.



Double-hung windows that let people see out are preferred by many buyers to high strip windows. This is Lakewood Plaza project in Los Angeles.

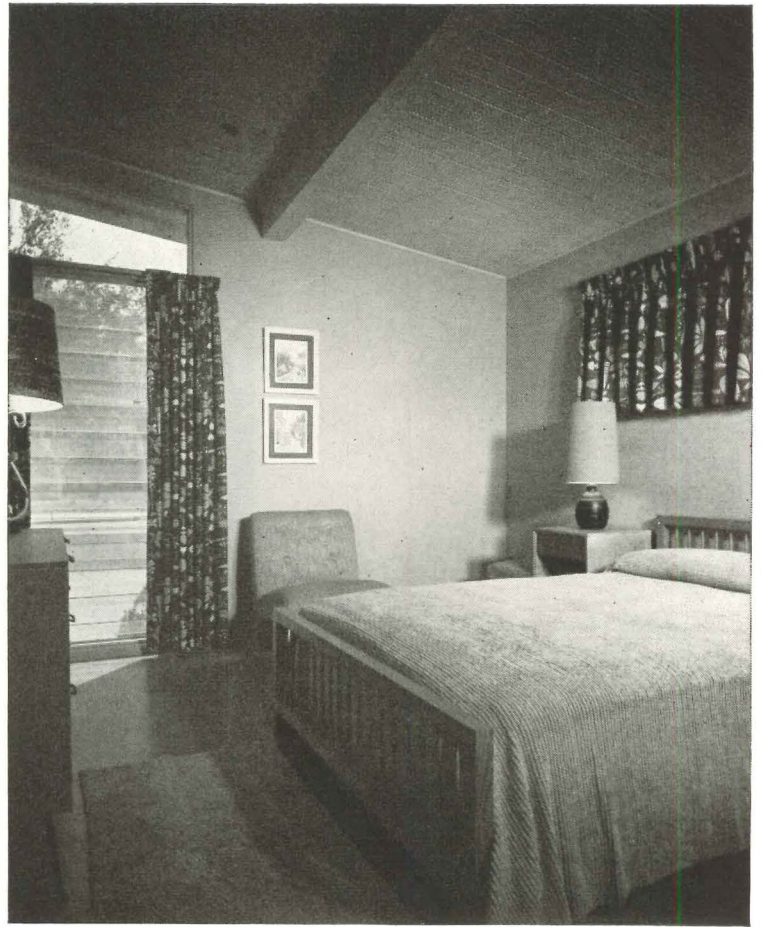

High, sloping ceiling, tall windows carry visitors' eyes up and out, make room appear larger. Builder should always curtain unusual windows.

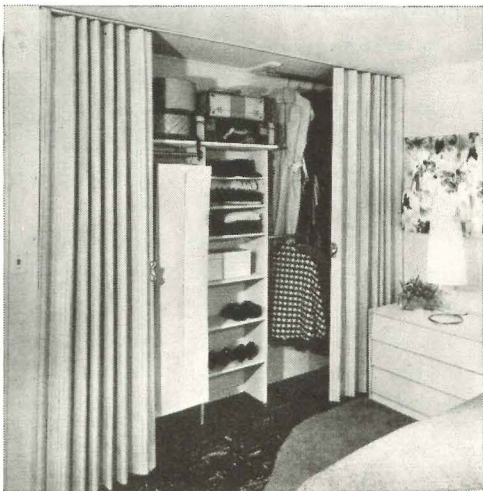

Built-in shelves in the storage wall were a popular sales feature in Levitt houses. Clothing helps show how storage space works.



Full-height storage cabinets give great flexibility as two adjoining bedrooms can later be turned into one. These are Modular-Built-In cabinets.



Storage wall with drawers and various-sized compartments, is attractive and eliminates need for chest. Such built-in furniture when included in mortgage benefits young couples.



Combination bedroom-sitting room where the parents can retreat when children entertain is good merchandising idea for model house. Widdecumb furniture in "Tod" Sloan's Colorado Springs house is contemporary but not too extreme for buyers.



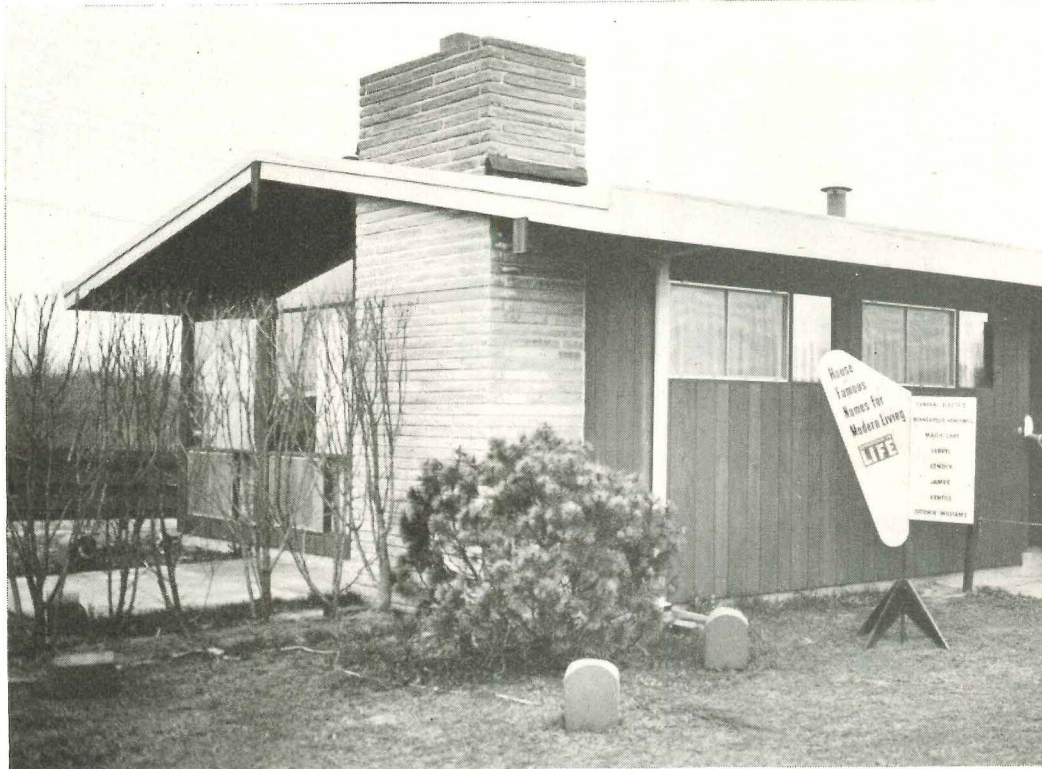

House of Famous Names tie-in, top, was made by Burton W. Duenke Building Co., St. Louis, in collaboration with LIFE. Sales, already good, were helped. Vice President G. W. Mefferd plans outdoor movies for summer evenings as promotion.

Trim, traditional-looking signs are used by Realtor Geo. H. Beckmann of Teaneck, N.J. on all houses he sells, above. He insists upon well-groomed look both inside and out, believes shrubs, trees, growing grass give his display houses a plus look.

A model house, furnished or unfurnished, is a building window. It can either attract or scare away customers depending on how it is used.

House selling is one of America's three biggest retail businesses with an annual gross of at least \$12 billion.

Many years of study have gone into developing the best advertising and sales methods for all retail businesses, but there are no generally accepted procedures for selling houses.

The truth is that in a seller's market a builder has no real merchandise. In nearly every city, however, some imaginative builders have done an outstanding job of selling houses. Their market-tested methods can help other builders when sales becomes more difficult, or when a builder decides to go into the huge market that exists everywhere today—families who buy a new house when they are convinced it is a better one than the one they now live in.

"Many builders let a golden opportunity slip through their fingers by not displaying their houses properly," says Nathan Manilow, a merchandising specialist who handles displays for many big firms. "Everyone who sees a house is a potential buyer who knows people who are." Builder Nathan Manilow says that today are not first-look buyers. They won't come back unless you impress them on their first visit." Architect Herman Yonkers says, "The only way you can make an average buyer remember a house is to make a storybook house of it. He must take something away that he will remember."

The following suggestions will be of help whether a builder furnishes a display house or whether he sells from each house as he finishes it. And displaying a model need not cost a fortune. Free services are available to builders through many organizations and there are dozens of low-cost techniques for displaying a model with more sales appeal.

es from a model house

Astanga



5. Furnish your display house. "We furnish a model for as few as 15 houses," says Earl Smith of California. Architect Woodman of Washington, D. C. agrees: "We had 20 houses for \$9,500. We furnished one model and sold every house. We sold the furniture and made money on it." Builders who find that visitors find they average six minutes in an unfurnished house but 15 minutes in a furnished model. This extra time gives builders a better chance to sell their houses.

6. Hire a professional decorator. An experienced decorator (not from a department store) can make a house look larger, more attractive, knows decorating trends and can help the builder choose the best foot forward. A builder's wife is not always the best judge of what appeals to the public. "Our best-selling model house was furnished by the most professional decorator," says a builder from the fast-selling Stern & Price project.

7. Use your own furniture. Builders from coast to coast agree they should use their own furnishings if they buy furniture and do not ask a store to furnish it. A store wants to sell furniture and tends to overfurnish a display house. Visitors may get so interested in the furnishings that they won't see the house. Furnishing should be kept in line with the house, and usually should cost between 15% and 20% of the price of the house.

8. Scale and underfurnish your house. Rooms look better when they are not cluttered up with a great deal of furniture. There should be fewer chairs, fewer tables, fewer lamps than are necessary. Underfurnishing makes a house look cleaner, more attractive, focuses more attention on the house, less on the furnishings. Furniture should be underscaled, slightly smaller, lighter in weight, light in color, too, to make rooms seem larger.

5. Hang curtains from the ceiling. To make a room seem taller, hang curtains from ceiling to floor. Whenever there is a high window or an unusual window, Manny Spiegel recommends that the builder hang curtains to show the housewife how to solve an unfamiliar problem. Many builders are adding a built-in curtain track on the ceiling for this purpose. To make rooms lighter on dark days, curtains should be pushed back to expose the whole window. This requires a wider curtain track, and not only lets in more light but also makes windows seem wider and more important. Light-colored transparent curtains tend to make rooms look larger.

6. Mix modern with traditional furniture. It is a mistake to make people think they must buy all new furniture to move into a house with big windows and an open plan. Make them feel at home by mixing good traditional furniture with simple contemporary. Here, again, a professional decorator knows how to advise a builder. Don Drummond of Kansas City uses period furniture in his contemporary houses to show how any style can be at home in them.

7. Show the family where to eat. One of the first things that interests a woman in a new house is eating space. It is good psychology to set tables in kitchen and dining area. Many builders who do not decorate their display houses put a table in the kitchen. A built-in table or built-in seats is a good sales attraction.

8. Show how flexible a third bedroom can be. For many families a third bedroom soon becomes a study, hobby room or TV room. Families already aware of what a nuisance TV can be in the living room may find an idea of Arthur Oman & Sons of Boston worth trying. Oman puts the TV in the study ("What is it but a place in which to relax, anyway?") and arranges the set so it can be seen by the whole family. Builders often panel one wall of a third bedroom to suggest its multipurpose use.

When a small third bedroom is furnished as a baby's room, no one complains about the size.

9. Give your house a lived-in look. If people feel at home in a display house they are more likely to buy it. So:

- ▶ Put fiber or matting rugs on finished floors. They are cheap and durable, save hardwood floors.
- ▶ Furnish the kitchen by putting bright pots and pans on the stove, mixing bowls on a counter, a paper towel rack on the wall.
- ▶ Put groceries in the cabinets. An open box of breakfast food, rice and other inexpensive foods will show how handy things are.
- ▶ In a pantry closet put brooms, dust mops, a vacuum cleaner. They can also be used to keep the model clean.
- ▶ In a child's bedroom put games, toys, blackboard or play things.
- ▶ In the living room add small touches such as an open photo album on a desk, books or magazines, pipe in an ash tray.
- ▶ In the bathrooms put an attractive cotton rug that matches or blends with shower and window curtains; include towels and even such items as toothpaste on the counter (with cap removed so it won't disappear).
- ▶ In bedroom closets some builders like to hang one or two plastic garment bags.

10. Don't worry about petty thievery. Builders seem to have mixed feelings on how much the public pockets in display houses. One large Eastern builder who has had thousands of visitors says: "We never lost an ash tray." Another who has had some losses says, "Knickknacks are a good investment and a builder should write them off as part of the cost of doing business."

11. Use lots of color—but use it wisely. Color is the cheapest sales tool a builder can use indoors or out. But a builder who puts maroon, red or purple on his walls will scare customers away. One of the many values of an architect is his knowledge of colors. Builders who use color stylists for their exteriors should also use such special advice on the interiors too.

A source of expert advice is the color consultation services of the large paint companies. One paint firm recently did the complete color styling for a large project. Builders can get much professional advice free if they ask for it.

A builder can cash in on color trends by using the "landscape colors" that are best sellers in rugs, curtains, wallpaper, upholstery and painted walls. There is no doubt whatever about the colors people want because for several years the trend has been growing stronger to landscape colors: soft greens and light yellows of foliage, grays and browns of earth and rocks, sky and water colors and, for accent marks, the brighter greens, yellows, reds and blues of flowers.

Many builders could profit by professional advice on wallpapers. Plain colors make rooms look larger, are a better background for furniture, detract less from other features. Fancy, bright-colored wallpapers are fine for individual families but not for display houses. Washable or dirt-resistant papers are a big sales feature and should always be identified as such.

12. Use signs or placards to explain your best features.

"Signs inside a house are silent salesmen," says Earl Smith. "We use them to work for us." Because no prospect likes to be high-pressured some builders will let a customer walk through a house alone. It is assumed that such obvious advantages as large bedrooms, big closets, well-arranged kitchens and other sales features will speak for themselves. But many visitors miss some of the best points about a house. They may never see them unless they are pointed out.

No builder wants to clutter up his house with too many signs. But discreet signs can be neatly done, can point out disappearing stairways, attic fans, washable wallpaper, durable kitchen counter tops, floors that are easy to maintain, extra-good hardware and windows, circuit breakers that replace fuse boxes, well-planned lighting, the location of heater room, and dozens of other features.

At Park Forest, Nathan Manilow puts a placard in every room with its dimensions. In the Diller-Kalsman houses, Los Angeles, the garages of five different models carry inside signs that tell its features. George Washburn, sales manager for the Beckmann real estate firm in New Jersey, used one "Stop" sign to avoid placarding a house to death. As prospects left they read a poster asking "Have you noticed the many features of this house?" It listed 20 selling points.

Signs should be neat, not too large, uniform in size and color, should not state obvious facts, should be worded like advertisements.

It is a mistake to place too many "Don't" signs around. A sand-filled urn outside the front door suggests politely that you prefer no smoking inside. A suggestion that children be held by the hand is smoother than "No children."

NAHB President Manny Spiegel believes that signs can answer the questions a visitor has concerning the neighborhood, transportation, shops, schools, churches, sewage disposal, construction details and appliances. It is true that many builders put these facts

Photos: Corlanat V. D. Hubbard

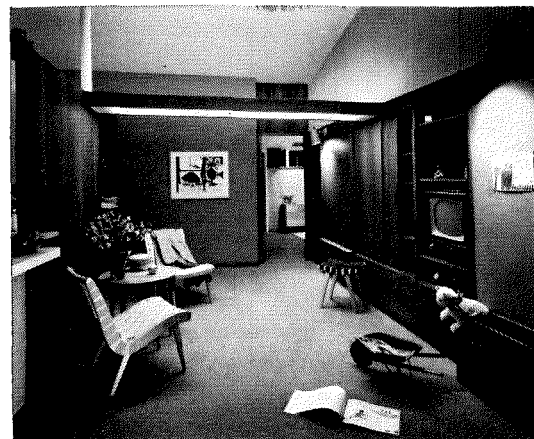



Dining space is dramatized in Philadelphia Builders Assn. house designed by Oskar Stonorov by chairs around set table. Note how scarcity of furniture in room opens it up, makes it appear even bigger than it is. Night lighting has special appeal, lengthens summer sales time.

look achieved by coat draped over chair, left, laythings. Built-ins suggest how simply room can be.

Scored concrete patio, below, simple, inexpensive outdoor furniture like table and chairs, grill on wheels showed visitors to Southwood at Syosset how easily indoor-outdoor living could be achieved. Ideas like this helped sell 315 \$10,500 houses in eight weeks. Note big window, door.



in a sales brochure, but there is more sales punch if they are known while visitors are in the display house.

Signs are especially valuable for builders who do not furnish a house but let visitors wander through without a guide.

13. Point out any built-in furniture. Built-in furniture is such an excellent merchandising feature that anything a builder includes should be clearly identified as being part of the house.

14. Capitalize on the optional extras. Many potential buyers walk in and out of a furnished or unfurnished display house without realizing they could get an extra bath, screened porch, a larger garage, finished basement, a fireplace or other extras. Most builders find that at least half the buyers take one extra or more. This is profitable and helps give variety to any project.

Buyers should be told, perhaps by a sign in garage or kitchen, what extras are possible and their costs. Extras must be handled diplomatically, as some builders advise that if a house is loaded with optional extras a prospect feels he is getting less for his money than he might. In larger projects a builder can display a standard and a de luxe model to show what the extras are and their cost.

15. Use the help of manufacturers. Almost no small or medium-volume builders use the free help that they could get from big manufacturers. One large electrical equipment firm will help a builder plan his kitchen, will furnish a salesman to demonstrate the kitchen during rush periods, will provide signs or display material, and will even participate in advertising under certain conditions. Many manufacturers have free planning service and will give advice on equipment, furnishings, decorating, colors.

16. Feature easy maintenance. One way to demonstrate that a new house is an improvement over an old one is through materials that are easy to keep clean and maintain.

Wherever the new plastic-laminated surfaces are used on kitchen or bath counters or on built-in furniture they should be pointed out. Flooring and wall coverings and tile used in bath or kitchen that are easy to clean and long lasting should be emphasized. Don Drummond of Kansas City has a placard reading: "These beautiful redwood plywood interiors are washable with soap and water—no more finger marks to mar the room beauty." Many builders use new kinds of materials that perform better than the public knows without such information.

17. Make sales points of basements and attics. The two most neglected areas from a merchandising point of view are basements and attics. Builders who include them have a great sales feature these days when families are crying for more space.

Summer Hersey of Natick, Mass. glamorizes his basement by coloring all walls with a new stucco paint. Previousy he had painted only the walls in the recreation room.

Edward Rose & Sons, Detroit, use small-duct heating, tuck ducts between floor joists and point out that the buyer gets high ceilings for recreation space.

Rodney Lockwood, Detroit, takes the curse off a naked basement by using it as an exhibit hall. Walls are covered with plats, blue-prints, architectural drawings, photographs. Other builders use a basement to display construction details.

The heating plant can always be merchandised with signs. A basement is as valuable to a builder as a window is to a department store. It is space to be used to attract and sell potential buyers.

Chief value of a basement to many families is storage. The least a builder can do is to put up a sign reading: "No storage problems in this house." Or: "Here you get 8,000 cu. ft. of storage space," or "This basement will hold all the bicycles, sleds, summer furniture, trunks and other stuff a family can collect."

The attic, no matter how small, is a sales feature. If it can be used only for storage, point out how much it will hold. Label heat risers. If electrical outlets or roughed in plumbing are installed, let the customer know about it. Point out the headroom, usable square footage when finished. Few people can visualize how attractive an attic room can be finished. If you don't want to finish one room as a sample, put up a photograph or a magazine advertisement as a suggestion.

18. Dramatize outdoor living. Everyone who buys a house would like to visualize the day when he can also have a beautiful outdoor patio or terrace. The paved rear terrace, with its barbecue, was one of the great popular features of the Trade Secrets house. A builder can cash in on this terrific demand by 1) designing his house so that it actually includes some indoor-outdoor features, and 2) by demonstrating outdoor living in his display house.

Some builders are so afraid to include features in their model house which are not in production houses that they don't want to add even a canvas deck chair and a few pieces of flagstone. But such items can be plainly identified as not included.

A rough-hewn picnic table, bench or other outdoor furniture that is put on a paved area can communicate the outdoor living idea quickly and at little cost. An even less expensive technique: show on blueprints where a patio can be placed to advantage.

19. Show construction details. Builders do not agree on the value of showing construction details. Some use such displays to great advantage; others say people are not interested in construction. But people who have owned homes nearly always ask about dry basements, insulation, paint peeling, etc. Rossin & Ringler, Detroit, invite visitors to inspect other houses under construction.

Many builders use basements or garages for cutaway displays of walls, samples of floor covering, type of insulation. Some use cutaway displays along the path to the model.

20. Provide public conveniences. The builder wants his bathroom seen by everyone but he doesn't want it used as a public toilet. Devices like plaster of Paris in the bowl, a plywood cap cut to its contours, will prevent its use. Several builders are showing thoughtfulness by providing a public toilet in the basement. It can be sold as an extra in the display house and costs the builder nothing, or it can be installed and removed at a nominal cost.

Many prospects drive past model homes that have no convenient parking facilities, where roads are blocked by cars parked on both sides of a road. Etheridge & Vanneman thought parking so important a problem to solve that they topped an entrance street with crushed stone when they could not get paving done in time.

21. Handling traffic inside the display house. The builder who attracts a big opening-day or week-end crowd to his development has an audience many retailers would give their eyeteeth to have. For that reason, says Victor Civkin, Connecticut architect who has worked closely with many builders, "Visitors should be treated as house guests, not as interlopers."

Here are some of the things builders are doing to entertain, amuse or instruct house-buying prospects:

- ▶ Using recorded music inside or outside the house.
- ▶ Employing a retired man to rake soil on the front lawn or tend a garden in the rear (to promote customer identification with the house, preserve the effect of neatness and attention to details on the outside of the house).
- ▶ Using a housewifely looking woman in the house as hostess or to demonstrate kitchen facilities.

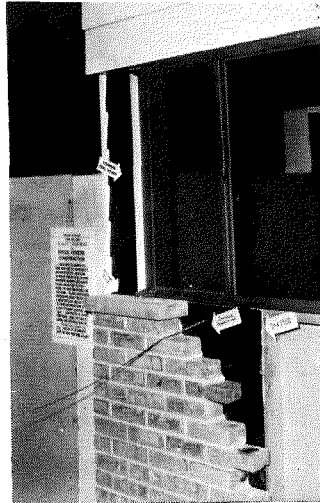

Cutaway of exterior wall section of Scottsdale home of Ray Lutgert, way of reassuring people, who homes before, that construction. Signs in Duenke, St. Louis subdivision, eyes of chore-conscious housewife. Added attraction for basement is tool to interest man, washer to interest woman. Basement loses naked look.

Accessible parking space was so important around all air-conditioned houses, below, that Etheridge & Vanneman put in temporary



Dean Vannice

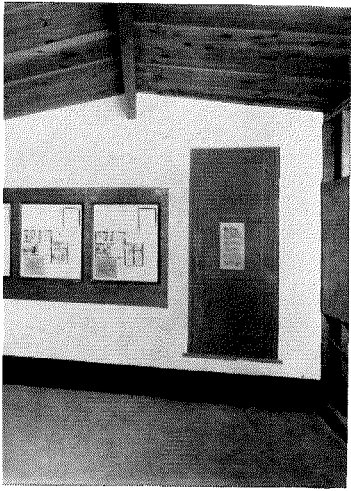

Plans is used by Fritz Burns in garage of his Los Angeles home. Door is painted on, indicates future aperture.



Graphically demonstrating two important by-products of air conditioning is this Servel display: over 100 quarts of water abstracted from the air on damp summer day, amount of dust and dirt screened by filter.

Tracy O'Neal



▶ Capitalizing on the American tendency to be sidewalk superintendents: having a house under construction next door or nearby that indicates a builder is not afraid to show his construction techniques. One builder keeps all houses uncluttered and swept so men-folk who want to poke around observing construction details can do so with ease.

▶ Using traffic or guide tapes discriminately. These may be necessary for big crowds on sunshiny week ends to keep traffic flowing smoothly, but they should not enclose such a small area that visitors must crane their necks to note closet sizes (a common error) or bottleneck traffic in hallways. During the week there is no need for guide ropes and many builders do not even use them on week ends. (Reason: "They take you through the house too fast, don't really let you live in it for a while".)

▶ Having a play yard for children. Ray Lutgert in Chicago rents ponies to keep children occupied while their parents go through his houses, but the small-volume builder need not go to even that much expense. He can buy a few swings, a seesaw, build some sandboxes.

▶ Providing an entrance and clearly marked or open exit door to keep traffic going in one direction.

▶ Using signs to help relieve traffic jams, avoid quiz contests in rooms. Room-size signs answer the most frequent question.

▶ Several builders do not let a steady flow of visitors stream through the house, prefer to let them go through in batches of 15 couples. Solution for those waiting in line: a hostess or salesman explaining some of the particular things to note inside, displays of construction features, Burma-shave signs explaining features in detail.

Other ideas for merchandising a model house are on p. 144.

22. Dramatize air conditioning in your model house.

Air conditioning in new houses is a magnetic drawing card. Proof? The thousands of curious people who have flocked to see houses across the country where pioneering builders have featured all-year air conditioning.

Here are the best ideas from builders who have used air conditioning to help sell their houses:

▶ Use signs outside and inside. Explain that air conditioning works all year, such as "This unit heats or cools, dehumidifies in summer and cleans your air 365 days a year. You are always comfortable despite torrid heat in summer or frigid weather in winter."

▶ Emphasize health benefits. "Filters remove dirt, soot and pollen. Air conditioning makes life comfortable if you have asthma or similar allergies. Doctors prescribe it for heart patients chiefly because exposure to extreme summer heat saps body strength."

▶ Dramatize how much water is removed from the house on a humid summer day by exhibiting the actual water extracted in buckets or bottles next to the unit.

▶ Hang a pair of black, dirty filters in garage or basement with a sign: "This dirt removed from house in one week."

▶ Appeal to women. Emphasize the fact that all-year air conditioning is a boon to housekeeping, "an invisible maid that constantly keeps out dirt. Your redecoration costs will be sharply reduced. Even light-colored curtains and walls stay clean for years."

▶ Operating cost is the biggest question mark in the minds of your prospects. Tell people what they will have to pay for summer cooling. Average costs are surprisingly mild in many parts of the country—\$10-15 a month (provided, of course, that cooling towers are used in high water cost areas).



Long Island is one of the most competitive housebuilding areas in the US, with 2½ builders for each of its 1,723 sq. mi. Within one short mile of one road there are 13 model houses. Builders call it “Murderers’ Row.”

Competition is so tough that when a new house is successful its first week it is likely to have more builders than buyers the next. A popular new feature unveiled on Sunday will be standard equipment for miles around by next Saturday night.

Faced with such competition, builders have learned what retailers have known for years: the more attractively you package and present your wares, the faster and surer they sell. From Long Island’s many good merchandisers, here are two case studies which have been unusually successful recently:

Bar Harbour

When builders Irwin Chess and Nat Siegal planned their 219-acre site as a 650-house community in the \$20,000-up range, they knew they faced the tough sales problem of getting production volume from expensive houses. Their solution: plan Bar Harbour as a promotion, and build a complete merchandising team to achieve the four-year goal.

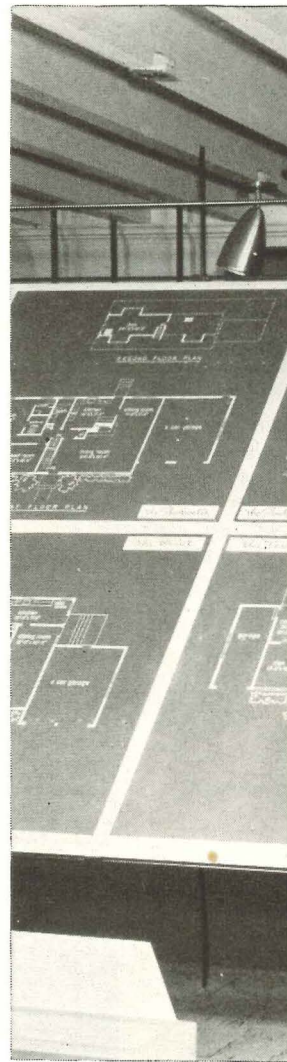

Distinctive sign is made from wooden letters mounted on expanded metal mesh and rod background. Though sign cost 2½ times more than normal painted billboard, builders felt that it would contribute to “good taste and individuality” appeal of the subdivision. Sales office (rear) has often been mistaken for contemporary house.

Lee Studios

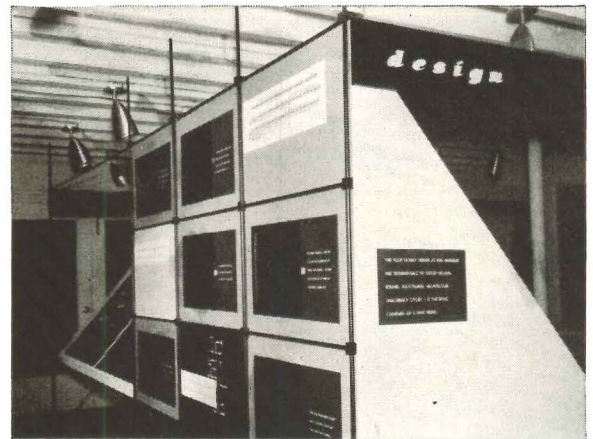

house



Display men created exhibit of outstanding houses. Kodachromes of interiors, made from photos, eliminated wait for completion of models. (below, l.) use white space heavily to secure crowded real estate pages.

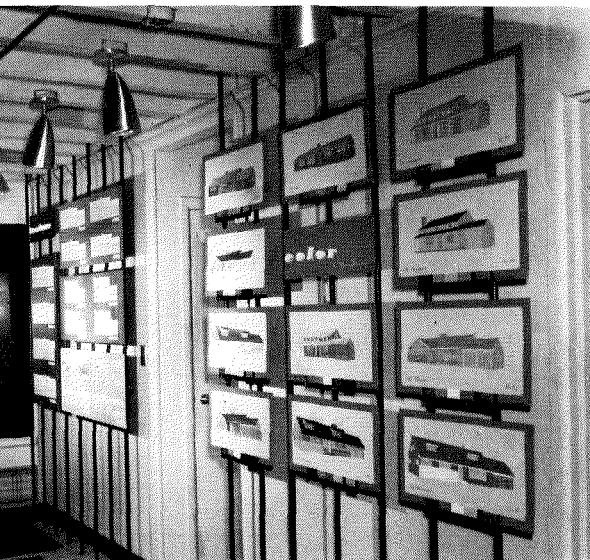

As made easy for buyers by display of various available. Exterior colors are being coordinated by consultant, whose advice is available to buyers to decide what shades to select.

Call in the team. "You have to spend money to lick sales problems," says Irwin Chess. Bar Harbour proves his point. Every facet of the operation, though coordinated by the builders, is in the hands of professionals. The nine-man planning board includes builder, sales agent, architects, advertising and publicity man, a display specialist, engineers, landscape architect, decorator and color consultant. As Chess said: "Five years ago I would have tried to do many of these jobs myself. I was an expert then. Now I know better."

The location of the models was planned for maximum return. Bar Harbour's front on busy Merrick Rd. was intended as a future shopping center. Instead of leaving the frontage vacant, the team decided to put the models and sales office on the heavily traveled highway. They are sure it is worth the \$50,000 that relocating them later will cost.

While the architects were still completing plans, the ad agency began preparing the first copy. Publicity releases started with the purchase of the property, and continued with each newsworthy development. A month before the project opened, "teaser" ads alerted people to "watch for Bar Harbour's opening." Full-page ads in three New York papers on opening day brought over 5,000 people to the models.

Everything was ready for them. Landscaping, split-rail fences around each model, parking space and attendants for 450 cars, and an eye-catching display of nationally known products. The sales broker had 17 men on the job, all thoroughly grounded in details of the house and neighborhood advantages.

Talking house. For several miles before Bar Harbour, the motorist is aware of discreet but inviting signs. Planned markers lead the visitor from the parking lot through the models. "No children" signs are conspicuously absent. Entry into a house sets off a tape-recorded voice which describes the best of its features.

In addition to salesmen stationed in each house, the sales office is in the center of the property, and interested prospects are referred there. On one side of this contemporary building (see photo) is a modern display of floor plans and color schemes, aerial perspectives of the property as it will look when completed, financial data and exhibits of materials and products. The other side has several well-furnished offices where salesmen and clients can talk in comfort. Large windows keep the houses constantly in view of the prospect.

Clean it up! Model houses are Bar Harbour's showcase, get special attention. Cleaning women go through each several times a day and a superintendent checks weekly for needed repairs. This spring the houses will be redecorated.

Traffic tapes are held to a minimum. Though pilferage has cost some small items and even a 16" TV set, Chess doesn't want to take precautions that might alienate customers.

Grounds are kept clean, attendants keep the parking lot from jamming up, and directional arrows lead lookers from the houses to the sales office.

Still looking for ideas. Though a heavy newspaper advertising schedule is still carried, the builders are exploring other media. When they found that 60% of their buyers already lived on Long Island, they planned car cards for the commuting trains. They are surveying billboard locations.

The sales record of 100 houses since November, a volume of almost \$21½ million, proves the value of a merchandising job that includes everything from the lawn facing the highway to the 25' tower erected at the water's edge to give prospective buyers an eagle's-eye view of the community.

Southwood at Syosset

This 315-house project, sold out completely in eight weeks.

In the first meeting with sales agent, ad and publicity men, Builder Irving Warfield decided on a revolutionary tactic: to give a "display director," experienced in retail promotion, complete charge of the merchandising program. The job went to Manhattan's Jo Shenker.

Tell the story. After determining that the house was priced right and that the sales force was capable, Shenker set himself two goals:

1. Devise displays that would explain everything in the house, and also reinforce the feeling that no drop in quality accompanied the low (\$10,500) price.
2. Insure visitors ample opportunity to study the display and to see the model houses from every angle.

From his experience in retail stores, Shenker knew that a good display could tell a customer more in 30 seconds than a salesman could in an hour. Proof: the average visitor spends more time at the displays than he does in the houses.

No one can get to the model house without passing the display (see photo, top right) set up under a canvas canopy along the main entrance walk. Strong emphasis on nationally known products makes a point of the quality of the houses. The exhibit is open, so customers can touch any material on the retailing axiom: "Get the product into the customer's hands!"

Lure them in. The first sign is 1/2 mi. from the project and surveys showed that many people who started out for some other project wound up at Southwood after seeing the signs.

J. Alex Langley



Children's playground was good-will gesture, not accompanied by "No Children" signs on model houses. Nurses were in constant attendance, and playground could be seen easily by parents inspecting models. Equipment stands heavy use, may be stored and used on future projects



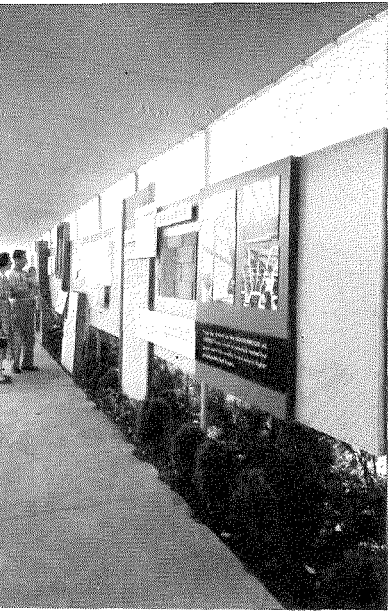

Outdoor exhibit featured all materials used in houses, was sited alongside only path leading to models. Openness of display was very popular with visitors, who liked to finger products. Key to successful public relations lies in word "Welcome" on sign. Every effort was made to treat all customers as invited guests. Unobtrusive tapes, strung to wire holders, kept large crowds in predetermined routes through models.

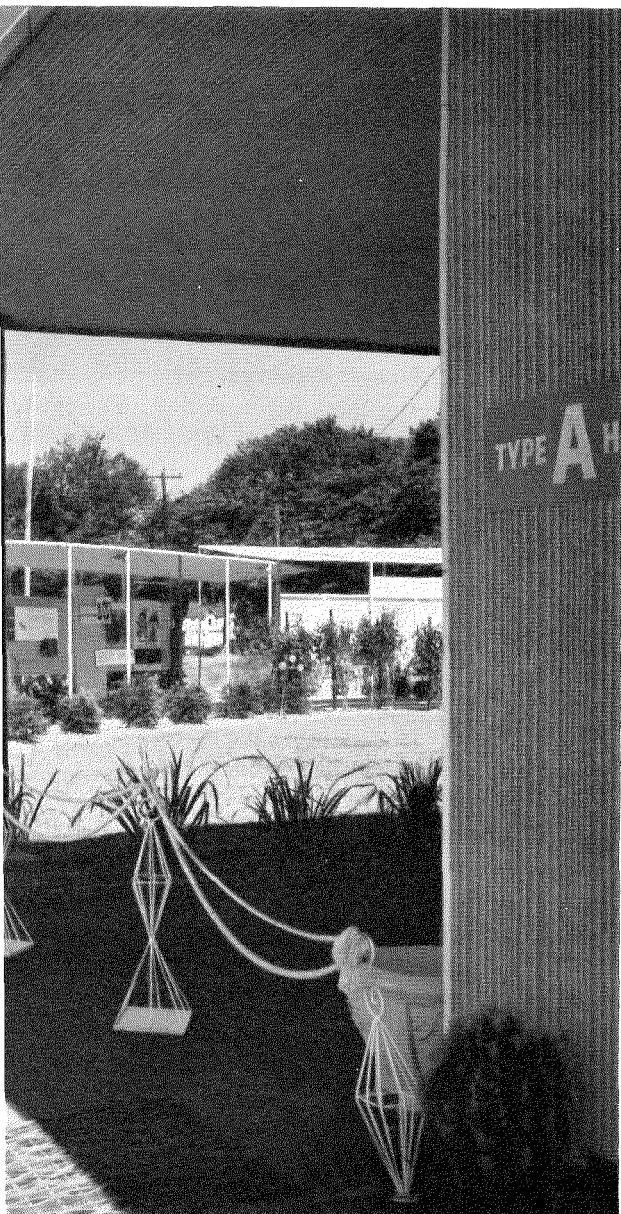

Shenker's rules for signs:

- 1. Keep one theme.** All signs are yellow and white, with vermilion spots and all emphasize Southwood.
- 2. Make them directional.** The placement of each sign is calculated to move people down a predetermined path.
- 3. Give them a background.** Signs are never placed in a bare field, but given a planting of shrubbery if necessary.

Then sell houses. Siting model houses was left to the display director so he could set a traffic pattern that shows the house completely and effectively. People who enter the front of the first model (the woman-catching kitchen is in front) are led by traffic tapes to the rear terrace of the second with its floor-to-ceiling window. The third house welcomes lookers via carport and side door.

The first salesman is in the last house. Reason: salesmen in the first two houses tended to stop traffic, or to break it up into little groups. Shenker wanted a constant flowing mass, with its built-in feeling of urgency.

Watch the decoration. As part of the merchandising job, Shenker supervised furnishing and decorating. One house has contemporary furniture throughout, another is entirely traditional. The theory behind this: when a woman enters a house, she asks herself, "Do I fit in here?" The dual furnishing job insures her answering "Yes" in at least one of the houses.

What did merchandising do?

- 1. It sold houses.** The project was sold out in eight weeks. In fact, oversales were able to offset any mortgage rejections or cancellations.
- 2. It saved money.** Original advertising budget was \$50,000, but the quick sellout saved \$20,000, more than enough to pay for all merchandising aids.

Wide-open field. Shenker, who enjoyed his venture into house merchandising, says:

"Merchandising has explored every other field, but has ignored the biggest one of all. I think you will soon see the same scientific selling used for houses as is used for soap, or drugs, or appliances."

Photos (top and below) Alexandre Georges



Radiant heat, usually difficult system for salesmen to explain, was made clear by explanatory display of pipe installed in slab section. Pictures and diagrams replaced words whenever possible, were clear to everyone.

Merchandising techniques

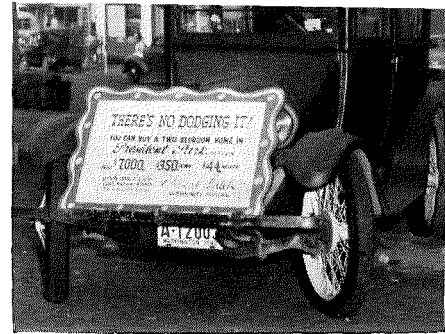

Possession of a "For Sale" sign no longer constitutes a complete sales program. An aggressive campaign is essential. Some big builders enlist the aid of the same specialists used by retail merchants. Many alert smaller contractors are borrowing techniques from big builders and adding clever touches of their own. For all builders, merchandising breaks down into three major classifications:

1. Pre-sale public relations

In the East, most sales agents advise the builder to set aside 1% for ads if he has a good traffic location, and 2% if not.

Publicity as well as advertising can get in some hard preselling for you before your prospect gets to your development. The merchant whose name is familiar to the public has a dollars-and-cents advantage over his unknown rival.

Tie-in with consumer magazines. Frank Zuzak, who built the Trade Secrets house in Shreveport, says: "This promotion has done more to get me known in this city than anything I have ever done." Many appliance manufacturers have built houses in cooperation with local builders to plug their products, and these get heavy editorial coverage from local papers. In Milwaukee, Consolidated Homes, Inc. furnished the *Milwaukee Journal* with a model house that was made the subject of a 16-week "Watch This House Grow" series. It cost the builder only some construction delay on one house, gained him a four-month serial in one of the country's leading newspapers.

Press previews. Rapidly gaining favor in larger projects, they bring newsmen to the house where they can see everything.

Direct mail. The J. C. Nichols Co., of Kansas City, has found it possible to attract a heavy volume of visitors through mailed invitations alone. During a three-week exhibition of one model 300 invitations a day were mailed, and no advertising was used. The first day 650 people came to the house.

Tie-ups with industry. In Denver, Frank Burns has his sales managers call on the personnel directors of all important local industries and volunteer their services in housing new employees.

2. Point-of-sale promotion

A construction and materials display. People have been known to spend as much time on informative displays as on the house itself. An outside display introduces the customer to what is in the house before he enters the door. Or such exhibits may be in the sales office. Best bet for the small builder: feature all your brand-name products in a well-lighted basement. Manufacturers will furnish whatever you need.

Children's playground. This will keep many children out of the model (but "No children admitted" insults parents). NAHB's ex-President Bill Atkinson furnishes pony rides for all comers,

even gave 100 animals to the first buyers in his new subdivision. The gum and popcorn machines at Park Forest do not cost many coins, as Sales Manager Jack Rashkin feels that a dime spent to make a customer's child happy is a dime well spent.

Plenty of good signs. Joe Eichler's findings on the importance of these signs (see p. 176) pointed up the importance of these signs. If local conditions permit, large billboards should be placed two or three miles away, on main roads. A large one is visible from the project, and if crowds line up, small Burma-Shave-style signs along their path will get good attention. Maximum visibility signs will be gained by having them designed by an expert rather than a sign painter.

A well-equipped sales office. The garage may be used as an office, or a room partitioned off in the basement. Many builders use house trailers, which can be moved from one project to another. Walls can be hung with area maps, with transportation facilities, and schedules marked on aerial perspectives of the finished subdivision; and all publicity the project has received.

A registry book. This makes it possible to keep in touch with people who have visited your house. It furnishes a means for research or promotion and tells where your lookers come from. Smart gesture: Burt Duenke, in St. Louis, sends a picture card of the model to his mailing list, to recall the house.

Cut-away, or "X-ray" displays. Some customers are interested in construction, bring check lists with them. The cut-away displays their construction questions effectively. Marvin Helf, in St. Louis, is using an X-ray house next to his model house. Bohannon, in San Francisco, also makes a point of showing construction displays.

Good printed material. The one thing the prospect takes home with him is your brochure. Some builders print two brochures: one leaflet for all visitors and a longer, illustrated booklet for interested prospects. Be liberal with brochures: they are worth the cost. Also, distribute material from manufacturers provided with their own imprint.

Control crowds and take the tedium out of waiting. If your project is large and Sunday visitors jam up, you may need extra staff to handle them. Architect Victor Civkin, who worked with merchant builders, advises that some work on the way in the project, even if it means overtime pay for the grader, or similar equipment, will hold people's attention. Builders employ men to work on the grounds, just to keep the attention of those in line.

Special openings. A West Coast builder holds "openings" on suitable nights. Andy Place invites the San Francisco Chamber of Commerce to his previews. Various builders

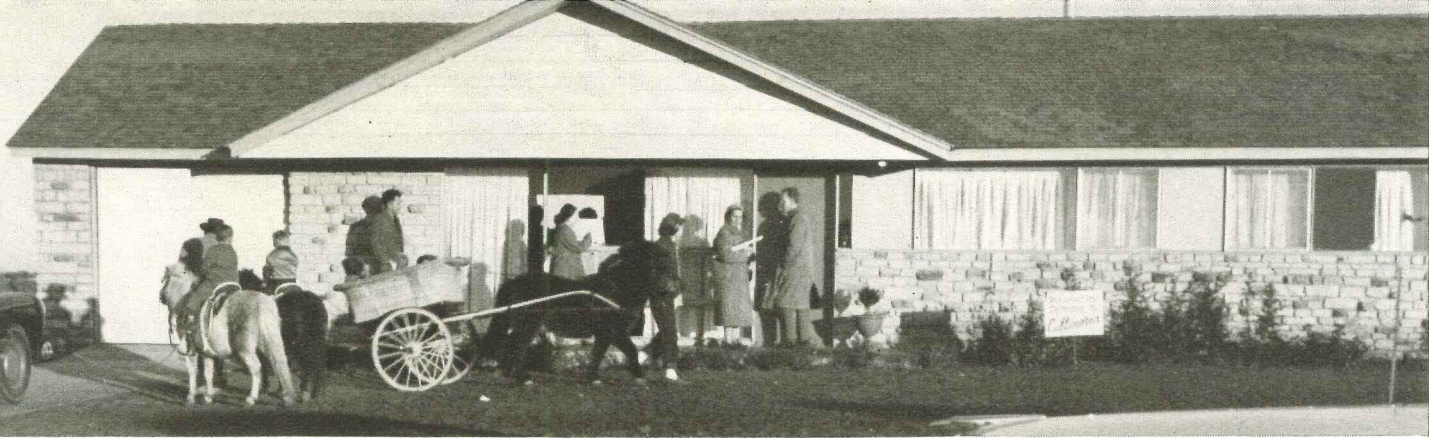

ents out of their house openings, serve refreshments and get newspaper publicity.

Save air conditioning. Rosemond Woods, just launched of Philadelphia, is a striking example of how to merchandise around air conditioning. Madison Builders, Inc. named 5,500 house Air Fashion House to tell the air-conditioning and dramatize the light-colored decorations made practical and air. Air Fashion House became the theme of advertising motion. The air-conditioning manufacturer, in this case pitched in and spearheaded the entire sales campaign. A local gas company—a gas conditioner is used—and the suppliers pooled all advertising. A joint campaign was hit the papers for six months after the model opened. Philadelphia papers played up Air Fashion House and a rent store is featuring it in four downtown show windows. and television interviews maintained high interest in the local colleges use the model for a laboratory in interior design and home air conditioning. Members of women's clubs are guided tours to learn about the new decorations and air conditioning.

estate brokers Hall and Crecraft say: "We've been and already have 150 good prospects. Three houses are and three others are ready for closing—really amazing for the class."

Post-sale public relations

Helpfully buyer can boost your house. Some builders pay attention to customers after they buy as before. Most local builders' associations have prepared booklets on the care and maintenance of houses, and the warranty builds better relations wherever it is used.

Home organizations. Most builders today use the 30-day system making all minor adjustments needed from a list furnished to the home owner. A good rule is: "When in doubt, fix it." In California, spent over \$1,500 fixing an 18-month-old slab. Result: 12 sales directly traceable to the home owner.

Help public relations. Frank Zuzak has a three-year program mails cards to the neighbors, introducing the new program. Keys are delivered in a simple but impressive leather service call is made the day following possession. Personal stationery for the wife is sent and an address marker is drawn. A gift of flowers or a tree marks the first anniversary, a telegram the second and a card the third.

Help the buyer in the progress of his house. Have a groundbreaking ceremony for the buyer, or a small party to mark the roof going on. Invite a special inspection trip to the house before the customer moves in.

Pony rides for children were big drawing card for Oklahoma's Bill Atkinson, who is "throwing merchandising book at customers." Carrouseis, free candy and toys are other small-fry winners. Old car (above, l.) made bad pun, good ad for Al Balch.



Impressive office gives buyers confidence in builders, will be converted to commercial use when project is completed. Makeshift facilities are drawn back to sales when they force buyers to consummate deal in cheap surrounding.

Del Carlo

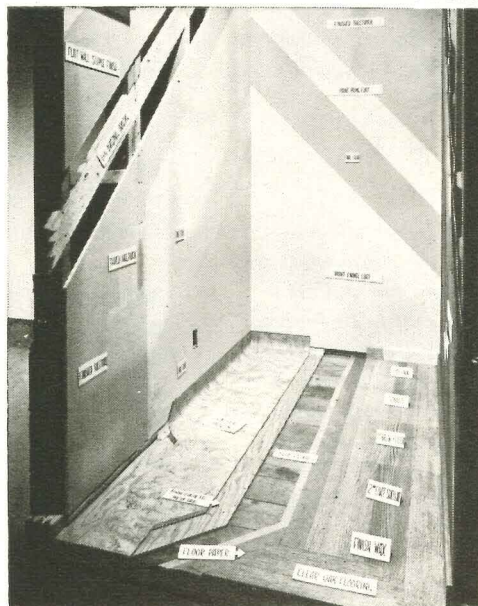

Cut-away displays go well with inquisitive visitors, furnish good opportunity to play up well-known products hidden in construction. This is best way of answering large number of customers who arrive at model equipped with check lists.



What's wrong with salesmen?

If you were invited to the White House for a conference on merchant houses would you feel safe in sending your salesman? Does he know enough to represent you? Probably not. Yet you trust him to be your front man at the daily conferences that are even more important to you. He is your chief contact with the most important people in your business life: your customers.

To the public your salesman is you. If he is friendly and cheerful, does his job thoroughly and is a real salesman—then your reputation as a builder is good also. But if he has egg on his vest, is lazy, badly informed—what your customers think you are like too.

▼
"We can get a better sales approach only through the use of competent, trained, full-time sales people. Do not depend on 'house sitters' or week-end sales specialists." Miller Nichols, president, J. C. Nichols, Co., Kansas City.

▼
"One thing we consider very important: the salesman should know everything that's in the house. Our men know as much about the house as I do." Joe Vatterott, builder, St. Louis.

▼
"Each of our buyers talks with two or more members of our staff to eliminate any misunderstanding. This prevents customers from becoming disgruntled at overeager salesmen." Jack Rashkin, sales manager for American Community Builders, Park Forest, Ill.

▼
"Some builders dislike large, unwieldy crowds, claim selling is impossible. That's wrong! Our money, our skill and our ingenuity goes into getting the public out to see the models, and the more they come, the more they buy. Every big builder will tell you: sales are made when mobs overwhelm you, not on rainy Tuesday mornings." M. J. (Pete) McKenna, N. Y. real estate ad executive.

▼
"We do not permit our salesmen to sit on the furniture in the model house. That house is an extension of our sales office, not a lounge." Henry H. Kay, partner, Trylon Realty, Long Island.

In the good old days (up to a year ago) anyone could sell a house. Your cousin Jenny's boy or your old Uncle Fred could take orders as well as anyone else.

You can still get along with Uncle Fred today and maybe next year. He can still sell the newlyweds. But if he is not a well-trained, experienced salesman he won't do you justice in selling against tough competition. He'll never be able to convince the couples in their thirties who have already had one or even two postwar houses that your house is their best buy. And certainly Uncle Fred, with all due credit to his fine qualities, cannot persuade people now living in houses 20 or 30 years old that your new house would give them more comfortable, better family living. Yet to stay in business, you must sell the tough customers as well as the easy ones.

Your salesmen are really key men in your organization. They are what the military call VIPs—Very Important People. While their big job is selling, they can do other jobs too. If you think about these many related jobs you get a new slant on your salesmen's importance.

Salesmen can take public opinion polls. If your salesmen do a proper job they can be your eyes and ears. They can tell you what people like and dislike about your houses. They can tell you why you get buyers, and this can steer your designs into popular channels. In fact, your salesmen should be real policy makers when it comes to changing designs to keep ahead of public trends. No one does a better job of bringing out new models than Place & Co. of South Bend. Their sales staff sit in on every new-design conference and help influence such trends as bigger kitchens and more storage space. (See p. 136.)

Your advertising should be based on what salesmen tell you people like and dislike about your houses. Obviously, if you emphasize the popular features, you'll attract more buyers than if you keep plugging unpopular features.

Your salesmen can also keep you informed about the builder down the street. You probably hear a lot of news about your competition, but do you get the hand reports about how people like the other houses? When split-level designs had their big revival around New York recently, many builders first got an inkling of this new trend from their alert salesmen. Sales boomed for those who were on the band wagon fastest. And if there are changes, as some real estate men say it will, it will be smart salesmen who first discover the public is tired of something.

Salesmen need to know what a house is. To get material for this issue H&H editors and Time, Inc. correspondents throughout the country visited great many display houses and talked with salesmen. They met many fine salesmen who knew their jobs and who created confidence in their houses. But the editors piled up a mountain of evidence that salesmen could do a better job if they knew more about the qualities of a good house.

Can your salesmen talk convincingly about the features emphasized in our Round Table discussion on p. 120? Do they make selling features of interior design, the house with the land, of what makes a good neighborhood, the value of good location, wide overhangs, good circulation, the open plan vs. the closed plan, and many other features of an up-to-date, comfortable house? If they can you have a real treasure in your men.

else should a salesman know?

the facts about the house

editors were staggered to find salesmen who didn't know basic facts about a house: number of square feet, size of lot, type of furnace, manufacturer of furnace, type of flooring and so on.

A salesman cannot remember the facts, but he should have them in a manual. In fact, many salesmen make a point of referring to a manual or a salesman's kit as it impresses the buyer that he is getting facts. Bob Gerholz of Flint has used "fact sheets" for many years which show floor plans and plans of all his houses, with lists of materials, equipment, financing and other information a salesman needs.

materials, mechanical equipment, heating and plumbing instruction details

A salesman should know in detail all the information on what is in the house and how the house is built. If a salesman is worth hiring he is worth training. C. Nichols Co. of Kansas City trains its salesmen for a month in their full operation. They have him watch an experienced salesman at work. Many builders take an electrician, plumber or mechanic who likes to sell. These men are often better salesmen than the bored professionals. The salesman should know the maker of every major piece of mechanical equipment.

He should be especially knowledgeable about the heating. If a slab house has a furnace with warm-air heat, for example, a salesman should know that there are no cold spots on the floor and if he is an expert he will be able to quote the price of such heating. Imagine the uselessness of telling a mother of a small child, "Madam, there isn't a cold spot in the fire floor." He should read trade magazines to keep up on technical talk.

the neighborhood

A salesman must be able to sell the neighborhood as well as the house. He should be able to talk accurately about schools, shops, transportation, churches, playgrounds, and other such facilities. (AHB President Manny Spiegel has a model house in operation in his model house in a city so buyers can see what kind of neighborhood they can expect in this area.) Potential buyers come from another town, or from out of town.

and financing

A salesman should have the facts about monthly payments, qualifying income, closing costs, monthly costs, mortgages, and be able to answer almost any question about costs.

He should also have facts, not guesses, about taxes, water, gas or electricity costs, and garbage pickup.

5. The opposition

A salesman obviously cannot refute what other salesmen are saying if he does not have facts about the competition. He ought to know almost as much about his chief rivals' houses as about his own.

6. Watch the trends

Many builders were caught with a lot of two-bedroom houses long after the public taste had shifted to three bedrooms. Their salesmen should have caught this trend in plenty of time. But the salesmen were either indifferent to dissatisfied customers or could not interpret what they said. A smart salesman listens, learns, then tells his boss.

Should you use a sales broker? When selling gets really tough, many builders turn to outside salesmen to help them out. This has happened to nearly all of the Long Island builders. (See p. 150.)

There are many advantages to using an experienced real estate man to do your selling. He is a professional, has a steady source of clients, knows the competition. He is well worth his fee if he knows his job. He will be especially valuable when builders begin taking trade-ins.



His attitude is most important. As H&H editors and correspondents visited display houses and talked with salesmen one major failing became apparent. Too many salesmen didn't give a damn. This is surprising in men working on commission. At one large project of \$16,000 houses the salesman pointed out the oven of a de luxe range, included in the price, criticized it as being much too low for convenience. He showed a built-in bathroom clothes hamper but admitted he had never bothered to learn how to open it. He made a sales point of windows that could be removed and washed from the inside but said he couldn't get them open "because they're all stuck right now." He knew there were schools nearby, but not where they were.

The builder of this project would have been horrified at trusting this salesman with a half-million dollar industrial operation but he had that much money at stake in this 35-house project. Yet he never bothered to train this key staff member.



Only friendly, well-informed salesmen who like people may work for Place & Co., South Bend.

Here come the women. Largely because they have such a practical, human attitude, women are moving into the house-selling field in increasing numbers. Women can sell to women, can demonstrate the kitchen equipment, discuss labor-saving gadgets, long-lasting counter tops, good floor plans, cross ventilation in bedrooms and other selling features. Most builders agree that women make excellent "salesmen."

Another fault of salesmen is their indifference to visitors who don't resemble the salesmen's preconceived idea of what a buyer looks like. Many salesmen feel they can tell at first glance who are the buyers and who are the lookers.

It is true that many people enjoy looking at new houses they don't intend to buy. But they might buy if the salesman persuaded them his new house was far better than their old one. Or if he did a really bang-up selling job, the "lookers" might pass the good word on to friends who are buyers. Salesmen are so used to selling the GI market they ignore couples over 40, and yet nearly every family has friends who are looking for a new house. One man, ignored by salesmen because he didn't look like a buyer, was a popular taxi driver in the next community. If he had liked the houses he would have spread the good word through his entire village, but the salesman didn't like him, he didn't like the houses and sales were lost.

VA and FHA 'reluctantly' raise mortgage interest rates to 4½%

The administration's May 2 decision to raise VA and FHA mortgage rates to 4½% ended a three-and-a-half week tailspin in the mortgage market that had threatened widespread disruption of homebuilding.

After a call at the White House, HHFA Administrator Albert M. Collins noted the new policy with this explanation: "The increase has been authorized with reluctance, but in my judgment is necessary to make such funds adequately available. On the present market, the difficulty of obtaining mortgage funds has been increasing for the very families that the VA and FHA programs are intended to serve—those with limited cash resources, who must meet the larger down payments required without these aids. I believe it is better to enable these people to obtain the funds they need at a slightly higher interest rate than to deny most of them the chance of buying a home."

For FHA, the increase from 4¼ to 4½% was applied immediately to loans under Sec. 203, 603-610, 903 and Title I, Sec. 8. For large scale rental-housing projects under Sec. 207, FHA likewise upped its maximum permissible rate ¼%—to 4¼%. Left unchanged because they are fixed by law were the 4% rates on Sec. 213 cooperatives, Title VIII Wherry Act and other defense housing. FHA announced the new rates would apply to applications in process and commitments outstanding, if lenders asked.

For VA, the ½% increase went into effect May 5, without becoming applicable to loans in its pipeline.

Bottleneck cracked. Industry received the news joyously. President Charles L. Clements of the US Savings & Loan League said the rate boost would crack the "bottleneck" on GI loans. He promised a drive among the league's 4,000 member associations to "put the GI home loan program back in high gear."

The tieup began April 8, when the Treasury announced its new 3¼% long-term bond. The new bond bore a rate 30% higher than the rate for such funds three years ago. In contrast, VA rates at 4% were still where they were since 1944. FHA rates, at 4¼%, had been pegged since April 24, 1950.

Within 24 hours after the change in the bond rate, big lenders stopped buying or committing VA and FHA loans (except at prohibitive discounts). One New York life insurance company wired its correspondents: "Please be advised we are not interested in any FHA loans."

Fanny May pulls out. It took HHFA only five days to realize the new Treasury bond rate made VA and FHA loans a poor buy. On April 13, it ordered its subordi-

nate Federal National Mortgage Association to stop buying them, except for outstanding commitments, defense and disaster loans. To the sensitive mortgage industry the Fanny May order was a red flag that the government was acting to prevent default of VA and FHA loans at the old rate. It meant that the government at last was getting ready to accede to industry's demand for a rate hike.

The economy-bent House Appropriations Committee threw another monkey wrench into the market April 17 by unveiling a plan to force Fanny May to sell private industry up to \$1 billion of its \$2.4 billion portfolio in the next fiscal year (1951). If VA and FHA rates went up, said the committee, Fanny May could only unload its loans at a discount of two or more points. This would make the government lose money. Moreover, such a move would not siphon money from current mortgage financing, but would be something like the government dumping cut-rate butter on the market that it had previously bought to bolster butter prices. Although the plan was killed on the House floor, the government-backed mortgage market dropped but dead.

As April dragged on without the rate boost everybody expected, VA loans reportedly offered at discounts as high as 10% in the Midwest. An FHA mortgage drought in Texas began to ease construction. A survey by the Oregon Journal found "the veterans home loan program a sham" at the 4% rate. The *Journal* reported that since the higher government-backed rate was announced "the stalemate has been broken wholesale to non-veteran FHA loans. More than 100 home purchases of the type had been canceled in Portland in the last 10 days face cancellation in Portland."

The obstinate VA. Some grumblers suggested that the administration's

IN THIS MONTH'S NEWS:

(see pp. 37 through 66)

House of Representatives votes to kill public housing and HHFA research, trim other housing programs to the bone

HHFA removes the last remnants of Reg. X, reopening the door to no-down-payment VA homes

Builders try to spur Congress to act on housing law changes and mortgage bankers propose new FHA rehabilitation loans

Air conditioning heads for a record-breaking year but builders ask more help selling conditioned homes to FHA

Urban Land Institute urges housing be divorced from urban redevelopment

subtle scheme to curtail homebuilding for a cushion if a recession developed. But there was no evidence of such attempted manipulating.

Instead, the architects of the delay that delayed the crisis appeared to be VA Administrator Carl R. Gray Jr., VA Loan Administrator Officer T. B. King, and Rep. Hiram Boren (R., Okla.), chairman of the House Veterans' Affairs Committee. It took more than a week before the administration finally raised mortgage rates. It was apparent to insiders that FHA was going to do so. But even when reports came out that Treasury Secretary Humphrey had approved an increase for VA (the law required), VA's Gray dallied in exercising the discretion Congress gave him several years ago to raise interest rates as high as 4½%.

Instead, VA hatched a proposal to maintain the 4% rate but legalize discounts to let the real rate to rise or fall but present a politically-palatable fiction of 4%. Neither builders, bankers nor government officials liked the scheme. But it was Congress that finally killed it.

Policy boomerangs. The loudest Congressional champion of a sacred 4% interest rate for veterans has been the House Veterans' Affairs Committee and its chairwoman, Edith Rogers. After hearing VA's offer as an alternative to a rate hike, Mrs. Rogers called an April 29 meeting of her committee to get a full explanation from VA Administrator Bert King. The strategy backfired. The committee members cold-shouldered VA's offer. Snorted Rep. William Ayres (R., Okla.), chairman of a subcommittee that was then investigating veterans housing: "It's legalized larceny—a flagrant violation of ethics." Did the committee members blame VA's insistence that the cost of disallowing loans was not passed on to veteran-

buyers? Said Ayres: "That's a lot of stuff."

But of greatest influence at the White House was action of the American Legion's national executive committee. As first order of business at its quarterly meeting April 29 in Indianapolis it debated the GI loan program from 10 A.M. to 3 P.M. Then National Commander Lewis K. Gough at

last wired the President that the Legion had approved recommendations made by its special mortgage committee headed by Attorney Tom Moses of Pittsburgh. Favored by the Legion: a "flexible" rate (it avoided approving any precise figure) and continuation of direct government loans at 4% in hardship areas for two more years.

Rent control extended to July 31; controls in some critical areas kept another year

For the eleventh time since 1942, Congress voted to extend rent controls. As President Eisenhower signed last month's extension into law, the building industry had more hope than before that this was the last.

The new law extended rent controls left over from World War II for three months from their April 30 expiration—to July 31. It retained rent ceilings in critical defense areas through next April 30, but restricted critical areas to those caused by military or atomic activities—thus excluding communities swollen by a defense plant influx.

Big cities out. Of the nation's 5.6 million rental units still under some kind of control, 4.3 million (77%) were in areas where controls had remained for the full 11-year life of rent ceilings. Involved were 1,133 communities with a total population of 34 million—21% of the nation. Among them were 31 cities of more than 100,000 population, including Boston, Chicago, Philadelphia, Baltimore, Cleveland, St. Louis, San Francisco, Pittsburgh, Newark, Jersey City, Louisville, Minneapolis, St. Paul, Cincinnati, Memphis, Providence, Worcester, Mass. and Dayton, Ohio.

Only 1.3 million rental units lay in the 124 communities with critical area rent control (which is imposed and administered separately from critical area housing aids, which embrace 223 communities). And Rep. Jesse Wolcott (R., Mich.), powerful chairman of the House banking committee and chief architect of the brief rent extender, estimated that the narrower definition and complete review of them required by the new law would shrink the 100 to between 25 and 40 critical areas.

House in control. The 1953 rent law was a notable legislative success for Wolcott personally. It was his insistence that rebuffed administration suggestions that World War II controls be continued until Sept. 30. The July 31 expiration date, Wolcott argued, was time enough to let states take over rent control if they wished. (Only New York already had state rent control, although

New Jersey, Massachusetts, California, Illinois, Missouri and Pennsylvania legislatures were considering it.) President Eisenhower, whose principal concern was giving due notice to the states, chose not to make an issue of the date. Neither did pro-rent control Democrats in the Senate, who figured a fight would let controls lapse entirely.

Still more important for the building industry, enactment of the Wolcott rent bill virtually killed chances at this session for Sen. Homer Capehart's standby controls bill embracing not only rent control, but wage, price and credit controls that the administration did not seek.

By the time the House passed the Wolcott bill 187-66 and the Senate, interrupting its tidelands oil filibuster, adopted it without change by a voice vote, it was clear that leadership in housing legislation had passed from Capehart's Senate banking committee to Wolcott in the House. In this lay industry's real hope for no more rent control extensions: Wolcott would have none of them. The new rent law also:

- ▶ Abolished the Office of Rent Stabilization on July 31, empowering the President to give some other federal agency control over rents in resurveyed and recertified critical areas. (The Office of Defense Mobilization seemed likely to get the job.)
- ▶ Lifted rent controls at once on units in critical areas built or converted after Feb. 1, 1947. Such "new construction," freed from controls by Congress in 1947, was blanketed under critical area controls last year—one of their most unpopular features.

Even before the new law was passed, Republican administrators were beginning to trim the list of critical areas. Generally the reason was that in-migration of defense workers forecast by surveys made during the Truman administration had not taken place, or that isolated military bases were being deactivated. Decertifications: Indianapolis, Cedar Rapids, Port Townsend, Wash., Fort Huachuca, Ariz., Camp Cooke, Calif. and Benton, Ark.

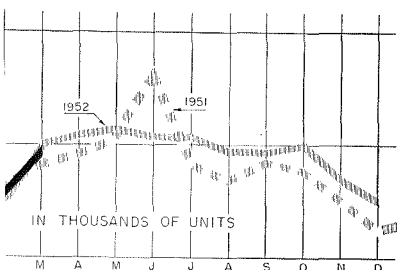

STARTS in March totaled 97,000 (a year adjusted annual rate of 1,114,000) or 1/3 of March '52 starts. The decline was at least in part to excessive rains. Total starts in the first three months this year reached 245,000, just under 246,500 in the first quarter of '52. The quarter's decline was all in public housing which fell from 19,600 to 17,600. Revisions to the final total of 1952 starts at 1,127,000.

The fastest-selling houses in the USA

This is the second installment in a grass-roots' survey made each month by HOUSE & HOME to show you the fastest-selling houses in the country and tell you why they set

"One of a kind" houses sell fast in New Orleans

Builders Ernest and Robert Norman apply modular planning,

tilt-up construction to a variety of house plans, presell all the houses they build

The Normans design and construct each house in their development differently from the others yet offer each at repeat-model prices. In their Aurora Gardens development (200 houses) they use many of the building techniques they learned from low-cost mass building, sell most houses between \$12,000 and \$14,000 on lots bigger than those in almost every merchant-built development in the area ("In New Orleans even a 50' lot is considered large"). House pictured here sells for \$13,375, has 946 sq. ft. of living space plus carport, outside storage and a 9' x 14' porch.

The Normans have sold over 30 houses since the first of the year. At present there are no big-scale developments in New Orleans like Hamilton Crawford's 1,500-house project of 1951-52.

Enforced economy. Customers are given the privilege of selecting from a variety of 25 plans, may even have features of one house incorporated in another. "We know just what the cost of every variation or change will be," says Bob Norman. "We spent a lot of time preplanning everything and we keep tabs on everything—book-keeping, extra overhead, additional drafting expenses. But once the buyer makes his choice and signs a contract, we allow no changes." He studied business administration at Tulane, accents cost accounting, says more builders go broke because of inadequate records than people realize.

Much of the expense of building individually varied houses is taken care of by the design. The builders plan frame houses on an interior module, block houses on an exterior module because "block is harder to cut than wood or gypsum board." Customers who suggest changes that do not

conform to a module are discouraged if possible, by the builder.

"All our designs are engineered for economical production. We show customers how much costs run up if they abandon the module, add an extra stud or an odd-sized piece of gypsum board," says Bob.

Low-cost lessons. The Normans figure

the average Aurora lot (from 75' x up) is worth \$3,500, which makes prices on most designs close to \$10,000 slightly over \$10 per sq. ft. selling of houses alone are made possible by steel concrete forms—the builders were first in the area to use them on a development scale; tilt-up method of exterior construction—walls are constructed

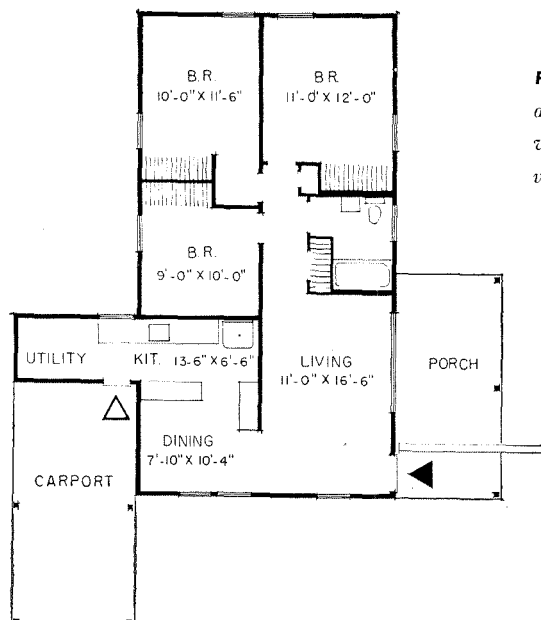

Plan allows housewife to command views and rear of house. Low fence gives privacy from street. Every room in house gets ventilation by placement of windows, c

self; use of power tools—table saws, miter saws, etc.—one for each house on site; complete materials breakdown on each house. Roof designs vary widely, the builders' budgets are not economical. "They don't build unless you have five to ten of the same going up at once."

The builders are content to make a small profit on their Aurora houses, but they can make more money on low-cost, mass-produced houses where they can gain economies by "doing the work of a fabricator on site." They pre-cut all materials, use roof trusses, design on an interior module. Last year they sold out a shipment of 114 houses at \$6,600. This year they are going ahead with 117 houses priced at \$10,000.

the customer gets. "The people who buy our houses want to feel they are in the suburbs," says Bob. "Our big selling point is that feeling." Setbacks vary from 25' to 45'. Utility poles are on rear property lines.

Although the builders believe in using mass-produced houses—and will have six furnished on their 117-house project—they have no model at all in Aurora, rely on plans and photos of the development to sell. "Frequently," says Bob, "we ask folks who have bought houses if we can show prospects a furnished home. Surprisingly, most folks are reluctant to have us ask. We think we lose a negligible percentage of customers by not having a furnished model. And there are delays from 15 to 20 houses just starting to finishing to show customers the results of construction."

Most of the houses were sold through VA financing, but the recent rise in Treasury bond interests will cause an increase in mortgage fees.

Low-cost best seller in Portland

Leo Rush offers two-bedroom, 900 sq. ft. house for \$8,000,

a three-bedroom, 1,100 sq. ft. house for \$9,000,

and is sales ahead of starts

There is just one reason why these houses are Portland, Ore.'s fastest selling houses: an alert real estate broker, John Clarke, found a way to make FHA's low-cost—203B2(D)—program work in a climate requiring heavier construction, more heating, greater insulation. The program permits 95% FHA mortgages on two-bedroom houses selling for \$7,000, three-bedroom houses selling for \$8,000, four-bedroom houses selling for \$9,000, including land.

Clarke had three tough nuts to crack: 1) Find enough existing lots in Portland at a cost low enough to hold selling prices within FHA's limits.

2) Find enough takers for the mortgages. 3) Find a builder willing to take less per unit for a larger volume of business.

"Outstanding" program. Clarke found the lots, got the takers and has in builder Leo C. Rush the fastest selling homebuilder in town. Rush has sold 240 low-cost houses since the first of the year. The Washington FHA office calls the Portland program "outstanding." Clarke's results in selling the houses (over 400 since last July) prompted him to get other builders in on the program.

Rush builds most of the houses on lots scattered over 50 sq. mi., keeps close tabs on his operation via radio telephones in his and his two superintendents' cars. He uses no pre-cutting techniques, ascribes his efficiency to power tools, advance plan-

ning and ordering of materials. Financing is the toughest hurdle: all FHA loans require much shopping around in the area. He is on a spring schedule of two houses per day, 60 days for completion of each house.

Cost comparison. In southern California and Arizona where there is no heating or moisture problem building costs for this type of FHA-insured house are below those in Portland. In the southern area 1,098 sq. ft. houses with three bedrooms and two baths are selling for \$8,000. In Portland where construction must be heavier and heating greater, a three-bedroom house is from 883 to 992 sq. ft., has one bath and sells for the \$8,000 tag. Four-bedroom houses with 1,086 to 1,137 sq. ft., some with two baths and others with forced-air oil heat and fireplaces, sell for \$9,000.

Lumber in Rush's houses is all No. 2 or better. No. 3 is used for cripples and non-bearing supports, as recommended by fir lumber manufacturers. Exterior of houses are finished with shakes or fir boards with the rough side out and used vertically with batts.

Sales success story. Clarke handles all Rush's sales from two display houses, one a two-bedroom, the other a three-bedroom model. He bases his success on keeping up with what the public wants and needs in a house. Says he: "It is better to spend weeks planning before the houses are built." His preplanning idea includes architect collaboration. "We try to get houses that look like \$15,000 worth and sell for less than \$10,000. The architect deserves much of the credit for the higher-price styling they have given us. They changed costly features to less costly items that actually sell better: open planning, bringing the outdoors indoors, large efficiently planned storage areas." Design work was done especially for Rush by Home Building Plan Service, Portland.

Clarke and Rush give a great deal of credit to FHA. Says Clarke: "Many ideas incorporated in our houses—architecture, price, location, construction—were not original with us but came from FHA officials, from the state director on down."

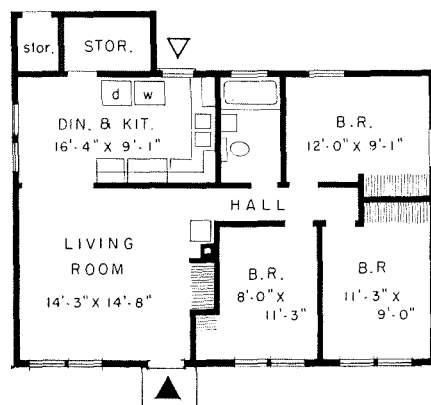
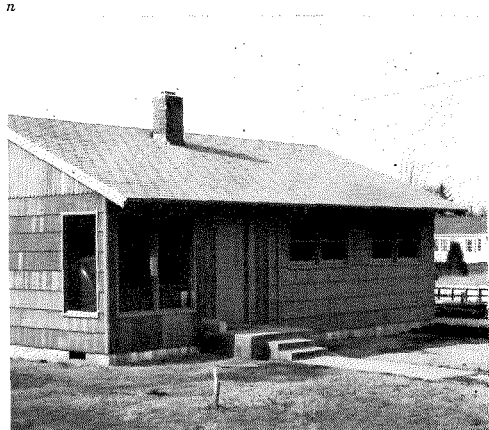

Sales features include redwood kitchen cabinets, flush interior doors, exterior doors of birch. Only appliances included are space heaters, gas, electrical fixtures.

In Detroit: best seller scrapped for better house

At a price often lower than FHA valuations, these builders sell more houses than any of their competitors

John L.

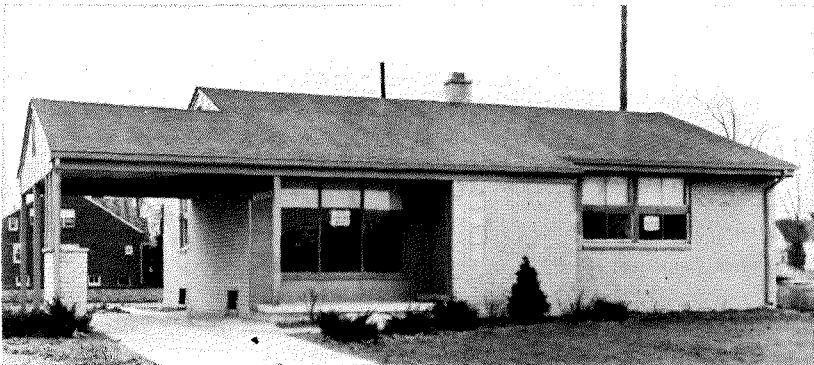

Carport is standard in Rose's new design, left, as he found buyers are willing to convert it to garage later. Builder provides directions for enclosing one side with storage wall.

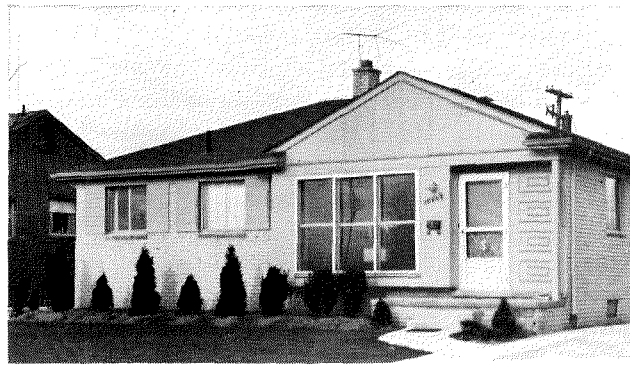

Older house, right, is one of Detroit's best sellers. It had many popular features including pass-through closet from bath to hallway. It lacked chance for outdoor living of newer model.

For years Edward Rose & Sons has been one of Detroit's biggest builders. Since son Irving came into the business several years ago they have been steadily selling more houses. Last year they sold 965, more than any other builder in the city. Here is the house that did it (photo, right).

All these years the Roses have been selling brick veneer houses and giving the public more house for their money. Sales took care of themselves. But young (27) Rose, not satisfied, called in an architect to redesign his houses completely (photo, above left). Prices: from \$13,300 to \$13,800.

More for the money. Since the first of the year the Roses have sold 247 houses. Chief attraction: a three-bedroom brick house that sells for \$11,500 to \$12,500. Many other builders privately admit they cannot come close to the \$10.12 per sq. ft. selling price.

Young Rose, now president of the firm his father started 32 years ago, ascribes the low prices to standardization and volume production, says: "We are able to give buyers more value because every member of our organization is on the lookout for new ways to cut costs." Examples:

▶ Construction for a finished house used to take five months, now takes two. Says Rose: "We now get a return on our investment six times instead of twice a year, and can do more with the money."

▶ Since the builders offer few basic plans, one man using power tools can cut lumber for two complete houses in one day.

▶ Use of plywood for sheathing, subflooring.

▶ Use of dry wall, first introduced to Detroit in volume building by this company.

▶ Tilt-up construction for exterior walls.

▶ Preassembled door and window components, shop-assembled cabinets, precut trim.

▶ Poured concrete foundations.

Better value still. Raw land costs the Roses \$2,500 per acre. Land improvement costs run from \$20 to \$25 per running foot, include all improvements.

"Lack of uniform building codes is the biggest block to even better construction and lower costs," says young Rose. "It would help immensely if the painters' union would allow spray painting. But even though we are faced with a higher wage scale than a year ago, we have successfully cut our rough and finish carpentry costs \$100 per house. We soon hope to do better than that."

The Roses give a one-year building warranty, have excellent customer relations ("50% of our sales are from recommendations of other owners"). Features of the houses at no extra cost include:

Full ceramic tile bathroom, tile kitchen drainboard and backsplash, drop vestibule of quarry tile, painted basement walls

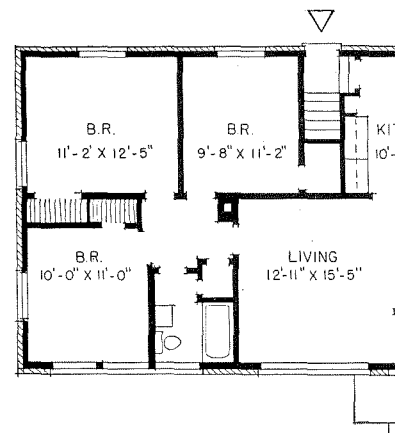

(round pipes recessed between floor joists for the oil-fired, forced-air heating system to allow 575 sq. ft. of clear space for recreation room), wardrobe closets, sliding doors, enclosed storage room, and preserves in the basement.

Rose also provides storm sash and believes they are one of the home's biggest boosts: "In our climate storm windows is an absolute necessity. If a homeowner had to buy it later, it would strain his financial resources to the limit, and he'd pay a higher interest rate if he bought on short-term credit. We give him a garbage-disposal unit, too, at half of what it would cost him later."

The Roses think space is the most important of all sales features, reject plans that do not include at least 100 sq. ft. for the smallest bedroom. They are responsible for introducing the trend to the three-bedroom, one-floor plan locally where the two-bedroom, story-and-a-half house was the standard.

The builders rely on newspaper advertising to promote their houses, plan to move soon on an outdoor advertising campaign.

They are now spending \$25,000 for architect services (Beneicke & I

Oklahoma City: a bargain in brick

er N. D. Woods lowers his costs by completing houses in four to six weeks,

to make fast sales through VA mortgages he gets by borrowing construction money at 5%

Oklahoma City best seller demonstrates a new way to sell faster: complete your house sooner. Because Woods takes little more than a month to finish each house, he keeps his prices down. "That way we get more house for the money," he says. "We plan everything so a man doesn't think in the field. If he has to stop working, we lose money." Faster completion allows Builder Woods to keep construction financing cheap.

Woods used a basic plan in several price ranges ranging from \$8,000 (down payment cost of \$225) to \$14,500. The inclusion of familiar details allows workmen to do things automatically. More than 75 houses Woods sold since the beginning of the year were priced at \$10,500 (see

Without garage this house is 918 sq ft. goes on a lot 55' x 125' worth \$14,500. Woods adds loan cost to the 5% interest payment, could make the \$750 down payment even lower by lumping loan costs into the required 5%.

Fast construction. Woods is able to lower his costs way down and sell the houses by:

using roof trusses where dimensions are simple (hip roof type shown here is used in a variety to his projects).

Using the open-room technique for interior construction (one big area under the roof cluttered by a forest of studs) when he uses roof trusses. He tried putting the roof trusses down before partitions were found the wear and tear on the floor made it worth-while to put floors in until he had completed partitioning.

Using jimcracks. "They just add extra trouble in this climate; they warp up because of great temperature and gusty winds."

Fast scheduling. Woods has a superintendent who works smoothly with a team of subcontractors who have worked with him for years.

Fast purchasing, made possible by fast buying.

Fast closing schedule. One man does all the work for each house.

► Constant search for new ways to cut costs. Example: Woods shifted from oak flooring on screeds set in hot pitch, to mastic application, directly to slab floor, saved 5% per ft. on floors.

The selling job. "Woods sells well," says a fellow builder, "because he puts good design in low-priced houses." For his model house Woods hired an interior decorator who used cool receding colors to blend one room into another. This made the rooms look bigger. He uses expensive wallpaper on one wall of almost every room of the house, is sold on making the display house as attractive as possible.

He is so convinced of the demand for the \$10,500 model that he is planning several future projects with it, the next with 98 houses. Woods is now building in three sub-

divisions, one of which is Midwest City, a bailiwick of big-builder "Bill" Atkinson who has not been building very actively in the last few months.

Trends of the time. Woods finds Oklahoma buyers insist on open planning of dining and living areas, three bedrooms, an attractive bathroom, hardwood floors. Slab floors are beginning to catch on although there was some resistance at first. The marble-chip built-up roof (first used by Woods in the area) is rapidly growing in popularity. Emphasis is definitely on a one-floor, ranch-type plan. Woods, who used Architect Ned Cole on higher-priced houses, leans toward contemporary design in all his houses: his windows are being replaced by window walls, his plans show a definite trend toward openness.

Houses are built in three different subdivisions with price range to suit each. Lower-priced houses have space heaters, frame construction, no garages. This brick model has central, forced-air heating system, is most popular and is fastest seller.

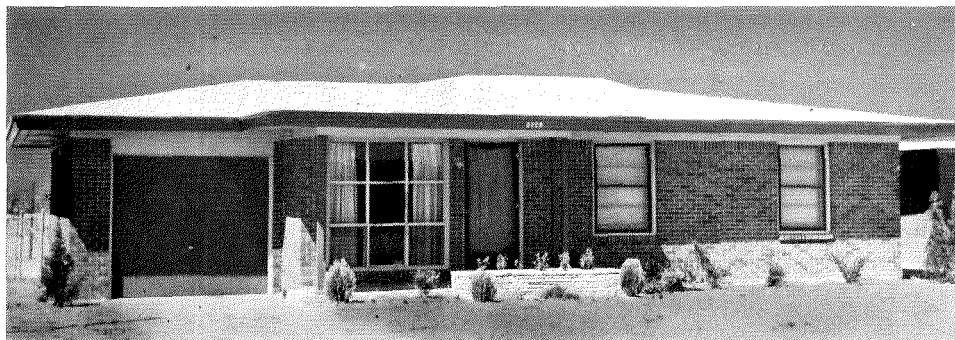
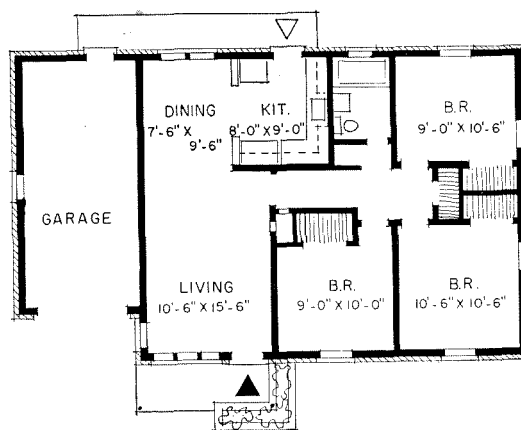

Air conditioning sells in Atlanta

Etheridge & Vanneman find they can sell 1,500 sq. ft. of living space for \$16,790

by offering a host of advantages in a story-and-a-half house

There are seven reasons why these houses are far and away the fastest sellers in Atlanta:

1. They are in the first complete merchant-built development to offer air conditioning.

Unit is a new combination heating and air-conditioning system. "It's wrong not to sell a complete package," says Builder Don K. Vanneman. "Atlanta needs air conditioning. We will sell all future houses with it."

2. Plans were a product of architect-builder collaboration.

"Our architect, Henry D. Norris (AIA), gives us the esthetics—our 9' in 12' roof looks more like a 5' in 9' because of the wide, heavy overhangs—and we supply the practical considerations.

"We are not wedded to the story-and-a-half house," says Vanneman, "but we find that we can offer more house for the money that way, which is important in this time of rising costs."

3. Houses provide 1,500 sq. ft. of living space in a modest perimeter.

"That gives us a chance to offer more area than we could before for \$2,000 to \$3,000 more on a one-floor plan." No comparable house sells in the \$16,790 range.

4. Builders take advantage of construction economies that make lower cost possible.

Vanneman, who was on Long Island when Levitt first started building years ago, learned many cost-cutting techniques then. Etheridge & Vanneman have built prefabricated and precut houses in the past, hit upon precutting as the biggest cost saver in building these houses. They precut every bit of framing lumber, assemble walls while they are lying flat.

5. Houses are site planned.

Architect and builders set each house on its lot to take maximum advantage of the terrain and view in a one-price subdivision. Lots vary from 75' x 200' to 150' x 400'. Buyers of smaller-plot houses get as much for their money in view or site advantage as buyers of bigger-plot houses. Even corner lots are the same price.

6. The builders saved trees.

This meant added expense but paid off in faster sales (20 the first day).

7. The builders did a crackerjack job of merchandising the houses.

A top-notch local broker asked for and got permission to have his entire sales force tour the Ridgewood Heights tract to study these professional techniques:

▶ A furnished model (cleverly connected to an unfurnished one with guide ropes and a boardwalk) done by Davison of Dixie in Raymond Loewy's Spectrum Group.

▶ An unfurnished model with appliances price tagged. Vanneman says: "We didn't want to get the Home Show effect with people coming in just to gape at all the new gadgets so we put weekly, monthly or total charges on appliances in an otherwise bare house."

▶ An expensive sales brochure—cost: \$2,500 for 10,000 copies. "It was so attractive we noticed no one threw it away," says Vanneman. "With 4,000 to 5,000 people going through the model on week ends, you can't do much selling. We made sure they had something to take home and remember, a good reason to come back and buy."

▶ A scale model of the entire tract was one of our greatest selling aids. Vanneman. "People want to see how house and lot will look like when complete. That's important when you are selling models and other lots are in a rough

Slipping up to contemporary.

Etheridge & Vanneman were primarily in the mortgage business before 1946 (still in their own mortgages), decided to pre-speculate on what the public needs before they built. Each year they have added more modern features to their houses within economy limits.

When they decided the public would no longer buy a house with unfinished basements they completed their attic floor, added an extra bath. They switched to granite tile for kitchen and bathroom. They used concrete block for foundations and brick instead of shingle for exterior siding because they believed it had more curb appeal. Porches are more popular than carports or garages in Atlanta, so the house has a 12' x 16' porch. Several houses have garages in the basement. Extra attic storage at no extra cost: a dishwasher.

Folding doors can be used to partition kitchen-dining area from living-dining room. Closet doors are ventilated, fold for easy access. Second floor has good-sized dressing room off master bedroom. Buyers like large amounts of storage in bedrooms and in downstairs bath.

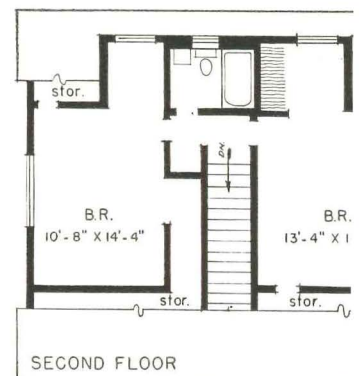
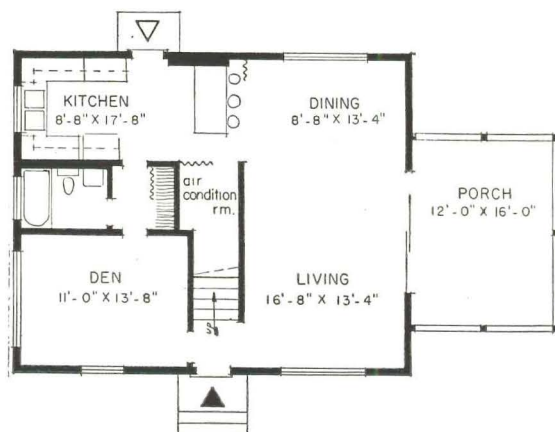

Westchester: wide choice makes fast sales

of Huntley Estates in New York's wealthy Westchester County

variety and luxury prices add speed to sales

development the builders have a sales formula that puts their \$17,000 houses at the top of the county's price lists. They offer buyers more designs than any other builder in New York. While Long Island, New York and Westchester are filled with firms that offer only one or two different models, the builders have seven distinctly different houses and three variations.

In their newspaper ads they emphasize variety and choice, find that it not only attracts first-time lookers, but buyers as well. In the fall, when the current project of 150 houses was begun, some 150 buyers had lined up—quite a record for this area.

Value is the pay-off. Buyers have a choice of a two-story colonial, Cape Cod with a full attic, split level or several one-story designs with different facades and exteriors. There is a wide choice of expandable garages, two baths, fireplaces, and basement treatments. In this price bracket wide variety pays off. So do extras. The most expensive models with the most features sell the fastest.

Two years ago when the builders first moved from Long Island to Westchester, a \$12,000 house on the market would not sell at all. "We learned our lesson the hard way," says one company official. "In the area, they don't want cheap houses." In the current Huntley project the builders have introduced two new designs that were not available in a nearby project they did last year. The two latest have jumped into top position and account for over two-thirds of the sales.

Most popular. The Bedford model made some 60 of the first 150 sales. It proves a clear-cut case of split-level popularity. Here is what buyers parted with in it:

Three of "upstairs" bedrooms that are separated from the rest of the house high enough to keep people from seeing through the windows.

Central air conditioning because the central furnace can radiate to all three levels, and buyers use a feature they like in the traditional colonial."

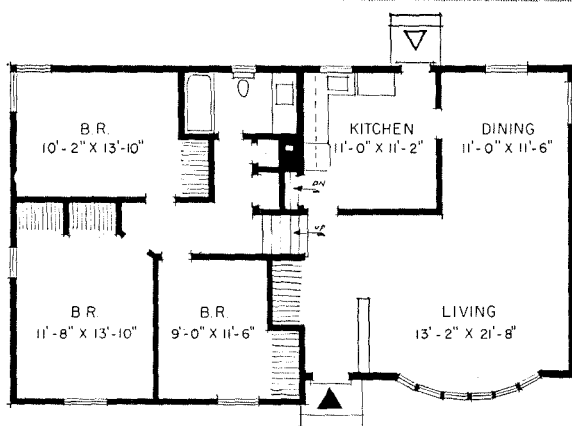
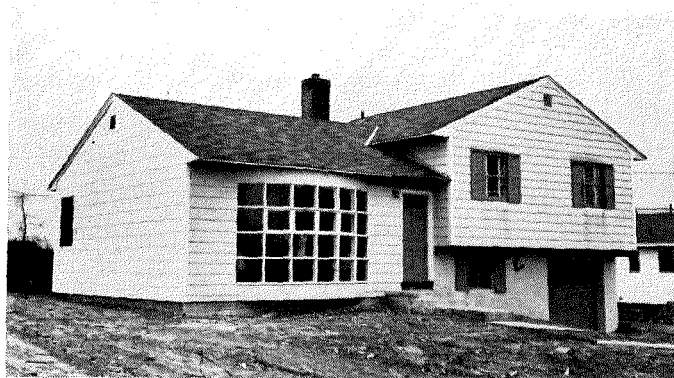

Big selling point of split-level above is large kitchen with big dining space. Garage and small basement under house are well liked because "they are just a few steps down."

The de luxe model has basement under full house or two-car garage. Ranch house, below, second most popular, is larger and has better plan than last year's ranch.

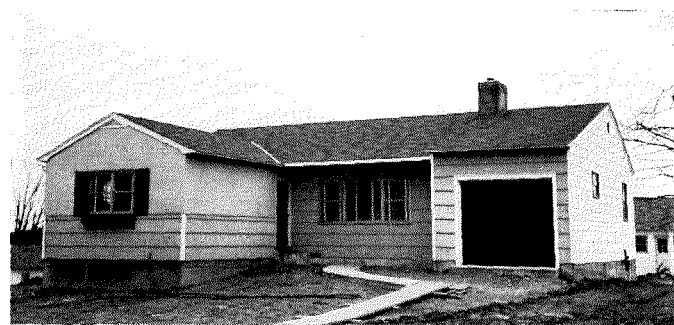

► Spacious-appearing living room that seems even bigger because of the dining L and windows at both ends of the area.

► Large kitchen with dining space.

► Two big bedrooms and one smaller one.

► Garage under the house. There is also a small basement area which is finished in the de luxe models. At additional cost, buyers can have more basement space by having the area under the living room excavated.

► Basement area only a few steps down.

Ranch style is next. Next most popular model was the Hartsdale offered in two versions. The de luxe model with two baths, fireplace, bigger bedrooms (price \$20,020) outsold the standard model, selling for \$2,600 less, 3 to 2. Total number sold: 50.

What the buyers want. Separate dining rooms or a large L which gives the effect of a separate room are in all the most popular Huntley sellers. In this price bracket and in this area families want to show their friends they have moved up the financial ladder, they no longer need to eat in the living room.

Buyer poll. The expandable-attic house (cheapest of all) sold 10 of the first 150. The two-story colonial sold 7. A one-floor plan with three distinctly different front elevations sold a total of 20. A modern version with huge corner window sold 3.

The builders find variety and extras their best salesmen. Though they did not put kitchen equipment and washers in their last year's project, they do now because buyers want them. A complete kitchen, that costs a buyer \$630, retails for \$900.



better wiring and better light

The honeymoon is over between builder and customer the moment the latter discovers he is short of electrical circuits. Home-buyer Jack Doscher (see opposite) blew fuses every time he used his basement power tools. Not until four circuits were added in his \$17,500 house could he have the lighting and outlets he needed.

Many builders seem to close their eyes to the growing assortment of electrical equipment families have today. Some 53 pieces of equipment are available and people buy them as fast as they can. A house that is not adequately wired cannot be called a good house.

"I suggest at least one 220 v circuit, which can serve the washer, drier and stove," said Claire Grove at the Round Table. "If the house has a basement, there should be a second 220 line there." Said George Kobick, "You should bring in circuits to take care of the growing needs, such as TV and air conditioning."

A wiring check list for new houses

Entrance lines should consist of a three-wire supply, as the old two-wire service is as obsolete as candlelight. Service wire for houses under 1,000 sq. ft. require No. 4 type R service wires. Up to 1,500 sq. ft. should have either No. 4 RH or No. 2 R wires; up to 4,000 sq. ft. No. 2 R. Minimum main switch size should be 60 amp. and houses over 1,000 sq. ft. should have a 100 amp. rated switch. If circuit breakers are used, 70 amp. ratings are minimum.

Branch circuits: for lights and regular outlets at least one circuit for each 500 sq. ft. of floor area is needed. Two separate No. 12 wire branches are needed exclusively for kitchen and laundry. Additional branches are needed for basements and for houses over 1,500 sq. ft. Without enough branch feeders, wires overheat, current is wasted or fuses blow out.

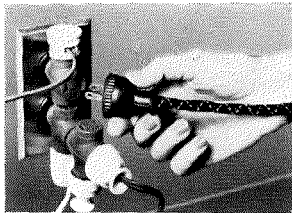

Convenience outlets: enough are needed to permit efficient use of lamps, radios and a wide variety of other equipment. In living rooms, bedrooms, etc., outlets should not be more than 12' apart so standard 6' cord appliances can be freely spotted.

There is so much inadequate wiring that when a builder does a good job he can merchandise it to the hilt. In South Bend, Place & Co. advertised: "You will find outlets for 42 lamps and/or appliances in our \$11,500 houses." It was one of the firm's biggest pulling ads. In Fairfield, Conn. Builder Edward Stoll featured "twice as many outlets" and remote-control wiring in his \$16,000 houses. These features helped to draw big crowds. Builders using circuit breakers (at no extra cost) instead of fused switches have found them popular with buyers.

Adequate wiring is not a costly luxury. Electrical contractors say that for an extra \$100 to \$150 per house they can do a very much better job in an average 1,000 sq. ft. house. In a larger house, adequate wiring costs about 1% of the total cost.

Local utility companies offer free wiring advice and even complete electrical plans to builders. Another source of information: National Adequate Wiring Bureau, 155 E. 44th St., New York 17.

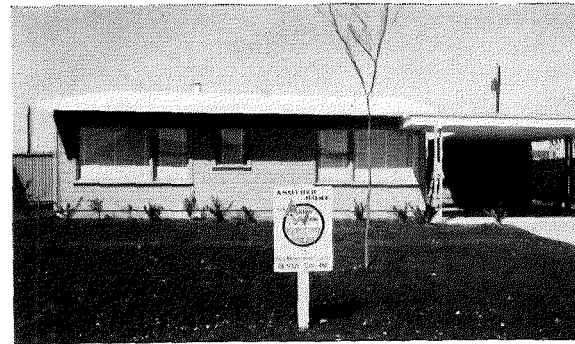

Adequate wiring is featured with special signs by many builders across the country. Public is especially conscious of good wiring. Builders say response has been "terrific."

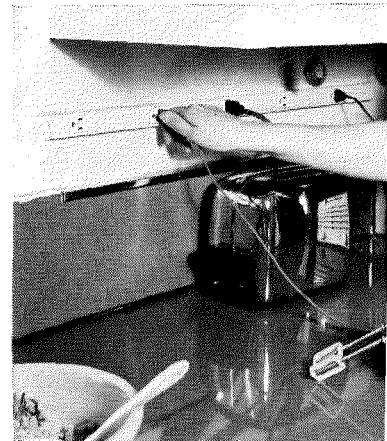

Electric plug strips, in kitchen or elsewhere, are dramatic evidence of adequate wiring.

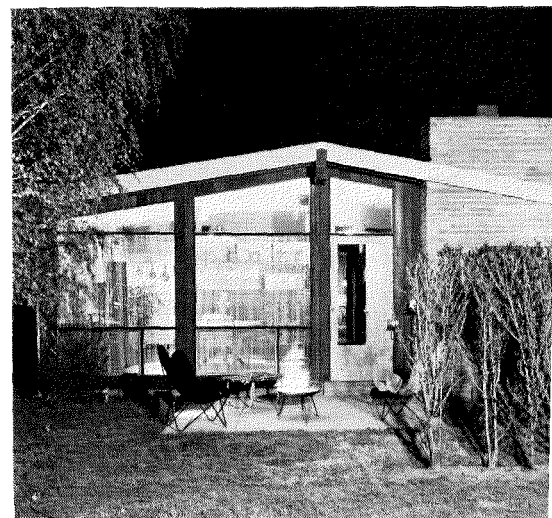

Good lighting has tremendous appeal at night, attracts new buyers after work hours. St. Louis Builder Bert Duenke says this house helped sell 10% of his new project.

Lighting will boost home value

Custom lighting at bargain prices that every builder can afford. Nationally known for their crack lighting designs, Engineer Kelly and Lighting Consultant Myrtle Fahsbender set out to demonstrate good lighting in a typical builder's house. They replaced the old, nondescript lighting with lights that literally sparkle with good design. Builders and architects. They used no frills or fancy, but simple, sensible illumination that will make any house shine.

Case. A one-story, \$17,650 house was the guinea pig. It was built last year, part of a project 25 miles north of New York City. When Owner Jack Doscher moved in he got standard lighting—no better or worse than that found in thousands of similar houses all over the US.

Problems followed. When Doscher set up power tools in the living room, the fuses blew. At night he had to grope his way up three flights of stairs to enter through the back door; there was no rear porch light. Doscher's biggest complaint was the kitchen: "Wherever I sat, I worked in my own shadow." All told, only 12 lighting fixtures were installed for 1,160 sq. ft. of living area, plus basement.

Kelly and Fahsbender arrived on this shadowy scene their job was simply to provide essential lighting for livability. The design called for a total of 21 lighting fixtures. In addition, the owners wanted two extras—two noted below in living- and dining room photos—that would be considered optional in builders' contracts to handle the increased electrical load the house was wired

with four more circuits, two for new lights, one for appliances and one for the workshop.

Cost comparison. Based on a 200-house order when the house was built, total electrical cost was \$289. According to the builders this included lighting fixtures worth \$50 at list price. This original contract covered installation of lights, switches and wall outlets adding up to 44 outlets in all.

The added cost for new wires and lights came to less than 1% of house price. The electrical contractor, George McKee Jr., says that if installed when the house was built the extra wiring would have cost \$100. (Local prices run \$5 an outlet.) The list price for the additional nine lighting fixtures is \$120, but every builder knows the sharp discounts he gets on lighting fixtures.

Will the extra cost for planned lighting pay off for builders? "Absolutely," says Jack Doscher. "If this lighting had been shown in the model we would have jumped at the chance to buy it, even as an extra." Neighbors have thronged to see the new lighting. What they see is evident in the striking before-and-after pictures below and on the next two pages.

This example of good lighting was sponsored by the New York Residence Forum of the Illuminating Engineering Society. Experts Kelly and Fahsbender generously gave their services free.

Lighting fixtures for this demonstration: Entrance spotlights—Swivelier; valances and kitchen—Wiremold; ceiling pinhole spotlight—Kliegl; night light—McPhilben; closet lights—Slater; dining-room pull-down—Lightolier; back-door light—Rab; ballast and fluorescent lamps—Westinghouse.

AFTER

Lionel Friedman

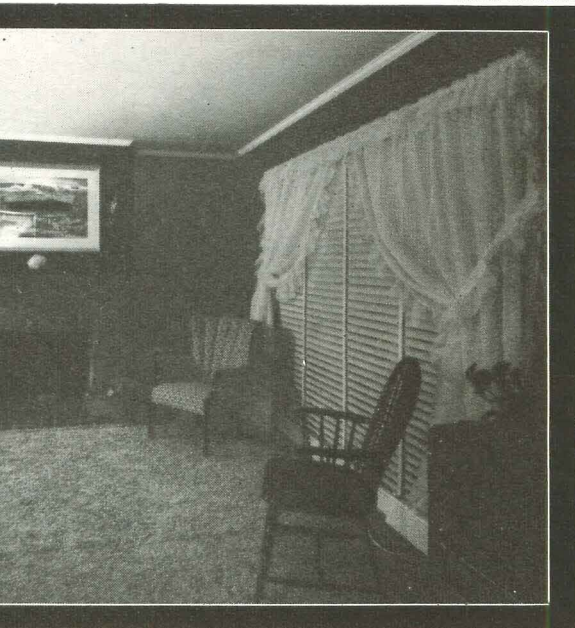

... had only two double outlets for ... , etc., was unlit when owner moved in. ... light ceiling fixture in dining room (to ... supposed to light living room, too, it was ... Reason: people sitting in chairs shown ... been blinded. Looking carefully you ... replace in the shadows.

Westinghouse



Planned lighting kills harsh shadows, gives soft, diffused illumination. Valance light over window and lamp were added for essential lighting. Pinpoint light in ceiling, a \$44 extra installed at owner's request, is aimed at painting which is focal point of room. Note fireplace now.



Dining-room table lamp usurps valuable space needed for dining or working. Despite lamp and bright overhead light people still ate in their own shadows. Because overhead light blinded living-room occupants, it was usually left off and dining room was a sea of shadows.



Window valance diffuses indirect light through room, the parasitic table lamp is gone. Hung from ceiling, pull-down lamp is dramatic extra that builders can display effectively in their models. It slides up or down or back to ceiling, e.g., when table is moved to center of room for guests.

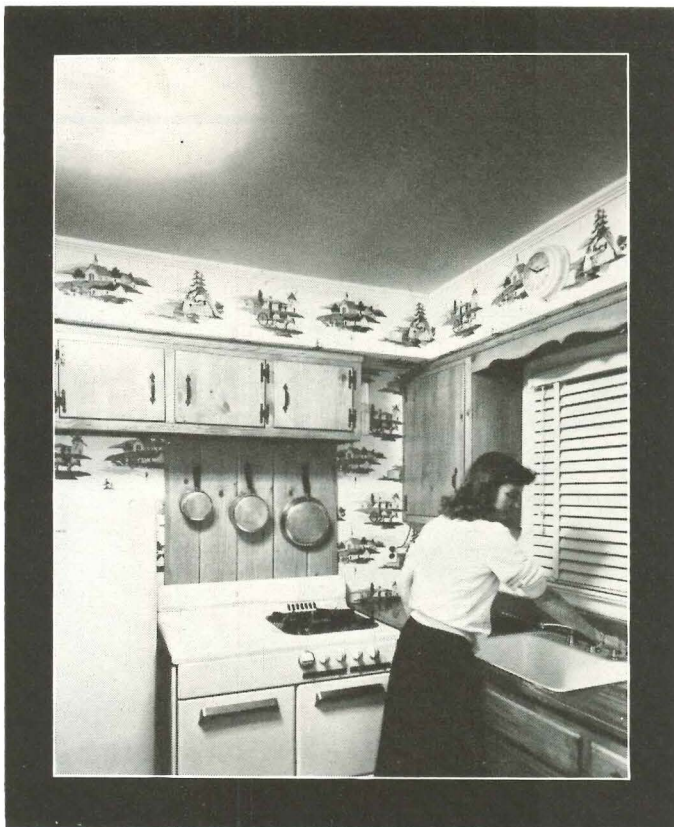

Ceiling fixture was only light in kitchen—housewife's biggest complaint. Wherever she moved to work she could not shake her persistent shadow. Note perfect silhouette over sink. Owners said, "We got an allowance for wallpaper, why not for lights, too, especially in the kitchen?"



Kitchen, most important room to housewife, is now bathed in soft light, shadows killed. Standard, inexpensive fluorescent tubes were concealed below existing valances over window and under wall cabinets. Light floods work areas, yet eyes are effectively shielded from direct beams.

BEFORE

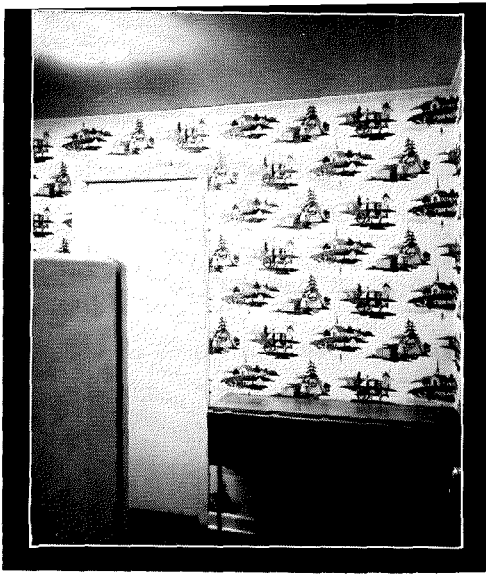

Utility table occupies the only spare space in kitchen but was practically useless at night. Children doing lessons, or writer-husband would look into their own shadows.

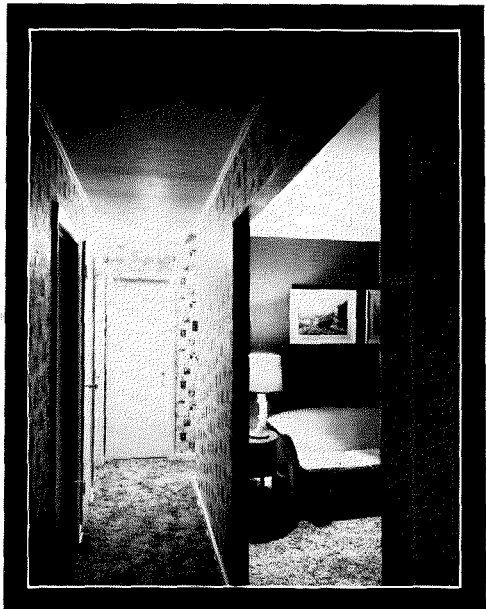

Hall gave dark reception to family and guests. On hot nights when doors are open, rear hall light glared into bedrooms where children sleep.



Single overhead bulb blinded persons looking into mirror. Shaving or grooming was difficult because "terrific" shadows predominated on underside of face and on neck.

AFTER

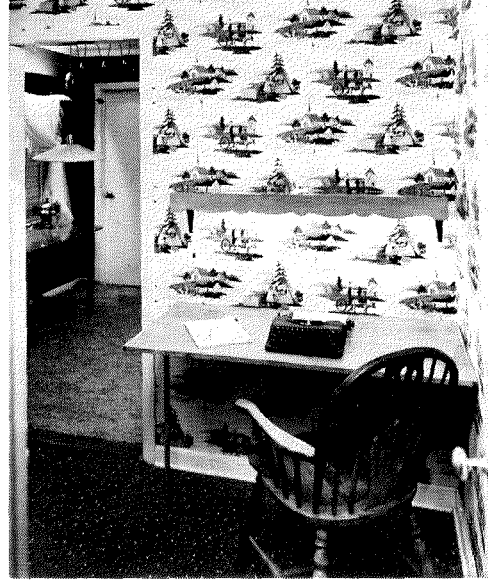

Valance light over table is placed so users do not look directly into light. Valance is topped with glass so light also travels upward to illuminate this corner of room.

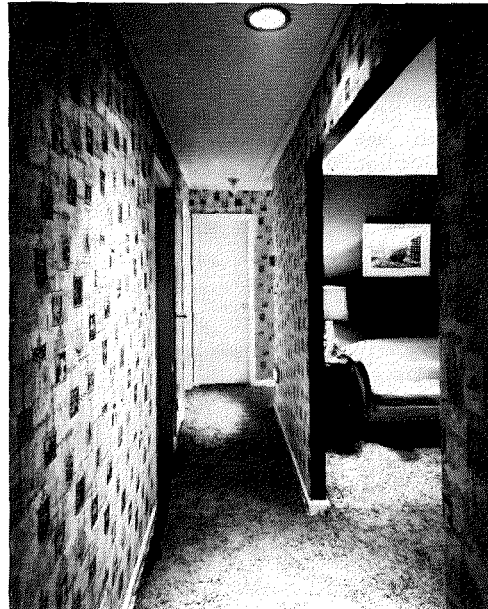

Down light in ceiling sheds pool of welcoming light in front hall. At end of hall baseboard night light does not throw bright rays into bedrooms; it can be left on all night.

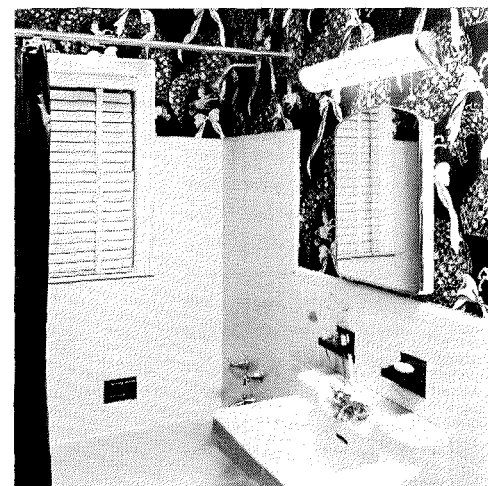

For economy, one 24" fluorescent fixture was used. It spreads light evenly, reduces glare. Though more costly, two vertical bulbs bracketing mirror would be ideal.



Garages and carports give more and more

A builder who still believes a garage or carport

is only a place for an automobile is losing customers and



Excerpts from the Round Table

ANSHEN: We used to build one-third carports and two-thirds garages. Now we are doing all garages. We are adding 12' at the back of the garage for additional storage and to gain a space 12' deep by 18' wide arranged so that the owner, if he wants to, can put in a wall and add an all-purpose room or whatever he likes.

GERHOLZ: Most people make very poor use of garage or carport storage. We have a deal with Good Will Industries to build us storage panels for rakes, hose, shovels and garden tools. You would be amazed how many things you can store in how little space with good organization.

PRENTICE: I drove around Miami with Tom Coogan recently and he certainly had a low opinion of carports compared with garages. There was nothing that did as much to impair the looks of the developments as the use people were making of their carports.

HAEGER: The problem of the mess in carports is due to the fact there is no storage in the house. It is not the fault of the carport.

SATTERLEE: A properly planned carport is a logical place for outdoor storage. It acts almost as a multipurpose room. It can be an outdoor work area and can even be screened in. It can afford cover to the front entrance, and we have found that it works perfectly well pricewise—including the carport as part of the house. We learned, too, in two developments, that a carport gave us a good deal more variation on the site.

GOODMAN: I feel you get a broader base of purchase if you give people more space for a certain amount of money and then make it possible for them to add increments such as garages or storage units.

ANSHEN: Extra space in a garage costs only about \$2 a sq. ft. in our area.

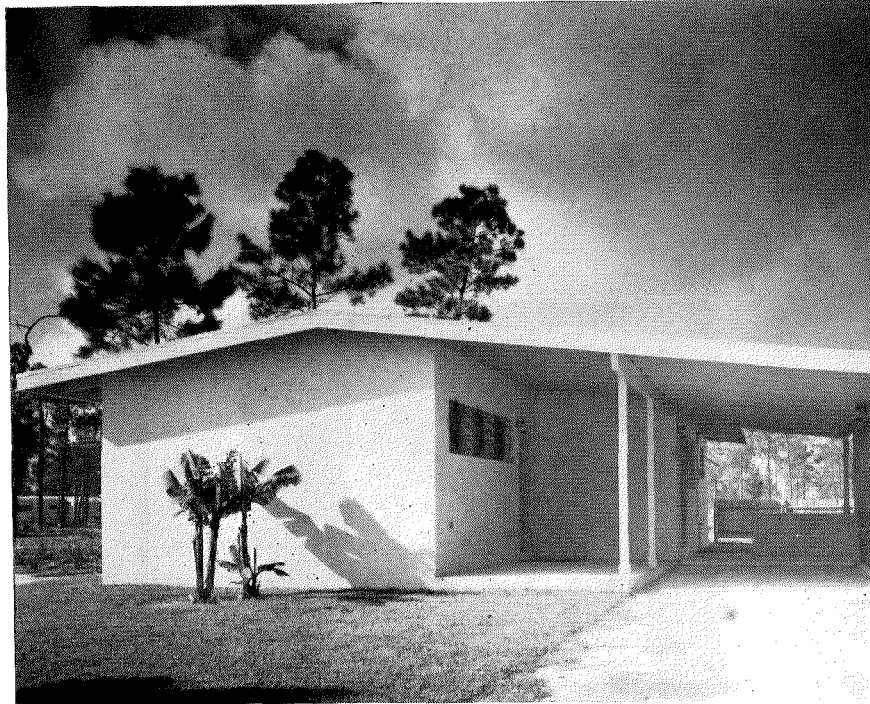

Any house will look much wider if the roof line is carried over porch, carport and storage wall as Architect Alfred Parker did here. Big "carporch" can be screened cheaply to become outdoor living room.

An up-to-date carport or garage has as many disguises as a vaudeville performer.

Even a new word has been invented to describe one of them: *carporch*. Carport or garage can become a family hobby shop, kids' play area, teen-age dance floor, a storage house "stretcher," the far end of a breezeway, or a porch between front door and service area. A few of these multiple uses are shown in the photographs on these pages.

Greatest need of most families, according to numerous studies, is more space and more storage. A well-designed carport or garage answers both needs. In HHFA's family follow-up study, "People Buy the Houses They Do" in *Housing Research*) it is significant that people without either a garage or basement were least satisfied with their storage space. A large garage or carport with proper built-in storage facilities, is one solution to the "storage equivalent" (see p. 120) which families who live in small houses are bound to need.

That a carport or garage can give a house the long, low profile popular today is clearly shown here. Even a small house with its narrow end to the street, can be made to look much wider than it is. Builders who use an enclosed breezeway not only make their houses seem wider but also provide a usable porch or multipurpose room. There is also another use for a garage or carport: in a pinch it is a good place to store an automobile.

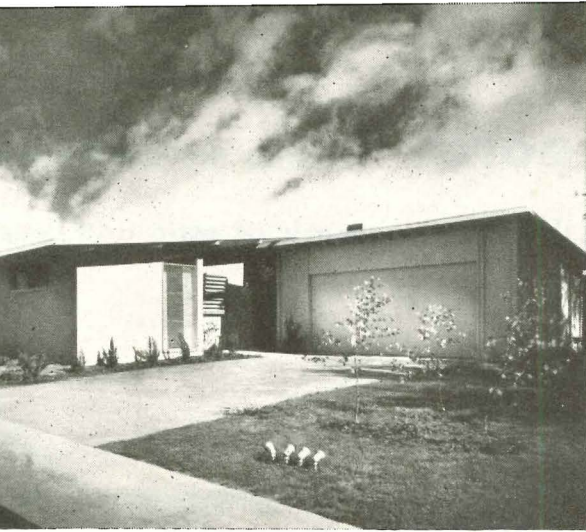

Ed Fickett uses garages to make Ray L. A. houses look larger and give variety in pattern. Houses have 8 different garage designs each contributing to over-all design.

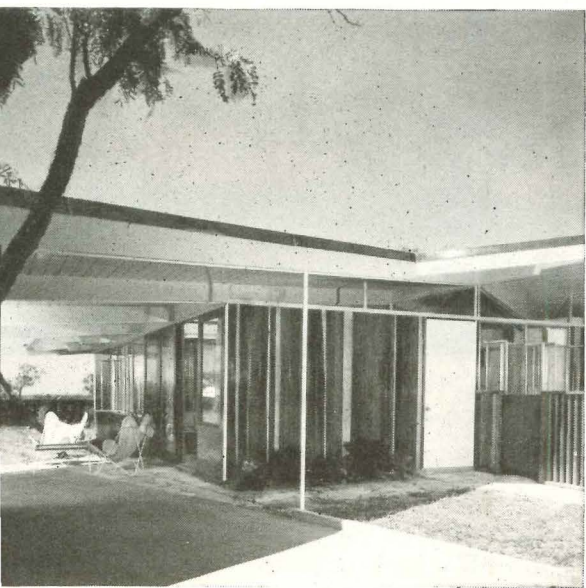

Expansion of the car porch by Architects **Wrightman & York** shows how a house can be made to appear wider than it is. At far end is highly usable storage wall.



Freezeaway of the Detroit Builders Show, with enclosed garage at right. **Wintertive** floor, rear door to garden, auxiliary storage make this a usable room, year round.

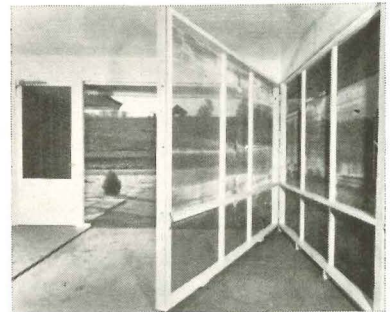

Builder Martin Bartling of Knoxville really thought up a sales gimmick with this screened porch-garage, with swinging door, which later could be glassed in. In top photo garage is at left end.

Photos: **Maynard L. Parker;**
Ulric Meisel; **Paul T. Fogarty, Jr.;**
A. Y. Owen

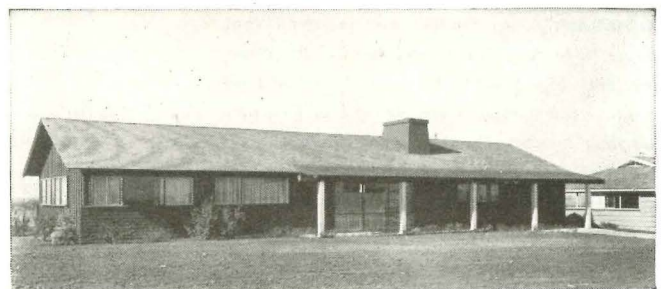

Bill Atkinson made history in Midwest City when he unveiled his new house, above, with an oversize garage which is good for almost any use to which a family wants to put it. Here is a terrific merchandising idea that any builder can use to dramatize ways families can turn a garage into a multipurpose area. Large photo shows it as hobby shop, playroom, dance floor, storage area.



The convertible porch expands the small house

makes amends for the disappearance of attic and base



Excerpts from the Round Table

MAY: The best reason for using front fences is that they can make a small house look very much larger—they can make a house seem as wide as the whole lot. We can site houses with the short side to the street and sell them as fast as the others by using fences. If you put the fence in front of the house and lap it over the next man's property, and paint it the same color as the house, the house looks as big as the biggest house on the street.

GOODMAN: Fences should be a function of land use and privacy.

YORK: Speaking of privacy, there was one successful builder on Long Island who sold houses at \$76,000 to \$18,000 which had rear living rooms, but I think his success was a matter of sales price. He had a bargain. In other cases we have not been able to get builders to accept rear living rooms. Too many GIs who move into new houses have just enough money to fill the oil tank the first time. They might like rear living but they can't afford to landscape their property.

MAY: With proper site planning and fences they would not have to look at the neighbor's laundry.

ANSHEN: Our families who have had rear living and at the same time have had privacy won't go back to front living rooms. But we use fences to give them privacy.

GOODMAN: Today houses are so small that people have to use the land for living. When they had big houses, they lived inside their houses. Now people have learned to live outside their houses. But they want privacy.

ANSHEN: The reason for that simile "as ugly as a board fence" is that in the old days fences were not designed in relation to anything. They were just around the property. Today a fence hides service areas, gives privacy to outdoor living space and to bedrooms.

MAY: The wall of a house is actually a fence and the wall can be continued out as part of a fence. It should be well designed.

Photo, Maynard Parker



Blueprints by Landscape Architect Douglas Baylis for patio of Cliff May house was given buyers, most of whom went ahead and built it.

The porch can yield the extra room most families need desperately so that parents are not driven to their bedrooms or the movies every time their children entertain friends. It is less expensive than an expansion attic or finished basement, pleasanter and it 1) makes the house larger, 2) makes it *look* larger, 3) can be enclosed for year-round use inexpensively 4) adds shaded space to the outdoor terrace.

The plan of the porch should not be haphazard.

- ▶ It should be approximately living-room size, but not so large it is a bother to clean—porches are notorious dirt catchers. Good dimensions to allow for comfortable furnishing and easy circulation: 10' -12' x 15' -20'.
- ▶ The floor should be level with the house floor. Even one small step complicates the use of the porch.
- ▶ The roof should overhang to keep out rain.
- ▶ Avoid due western exposure where the late afternoon sun will beat in and generate heat. Try to catch prevailing breezes and the most pleasant view of the lot. Keep the porch as close as possible to the most-used living areas, indoors and out.
- ▶ Everything about a porch should be readily washable, resistant to dirt tracked from the yard. Avoid rough-textured materials. Recommended: colored concrete (cheap and effective), tile, slate, brick, cast concrete.

To enclose the porch, removable full-length storm sash is practical; awning-type windows offer excellent ventilation.

Supplemental heat, or provision for it, will give the porch a four-season potential. Radiant electric panels permit quick heating of the area as wanted and obviate the need for maintaining heat between times.

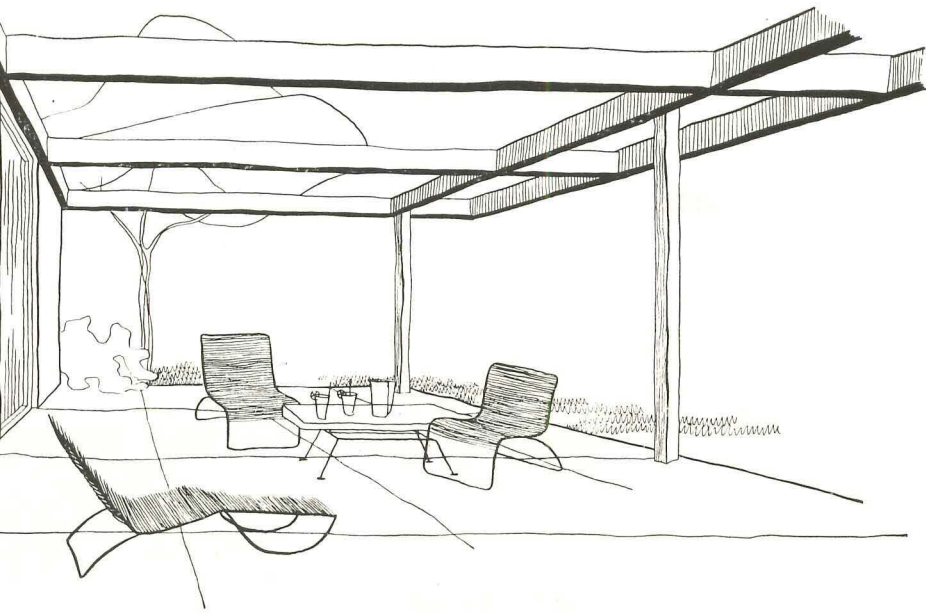

Expansion-porch framing could be included by the builder at little extra cost. Owner could then use it as trellis or add roof and side walls at his own expense and at his leisure. Such a space, roofed and screened, would make a cool outdoor room during hot weather. With glass sash and auxiliary heating it could be used in winter.

Screened porch is screened against wind, but allows the warmth of the sun. Fence, if painted a light color, would reflect sun into the area. Barbecue adds to the warmth and livability of the area at left in the drawing.

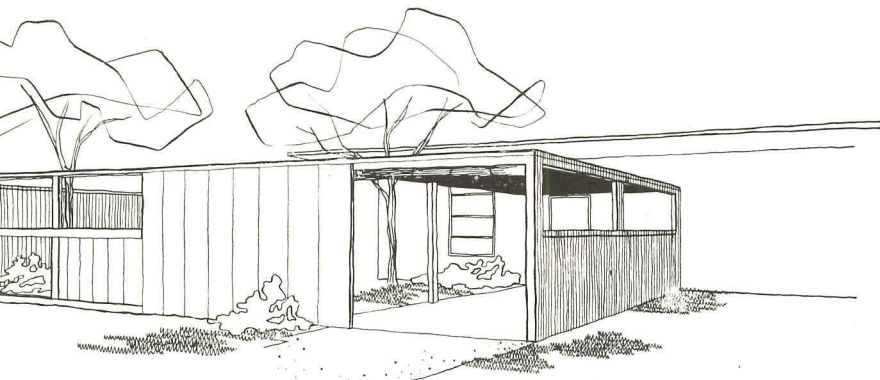
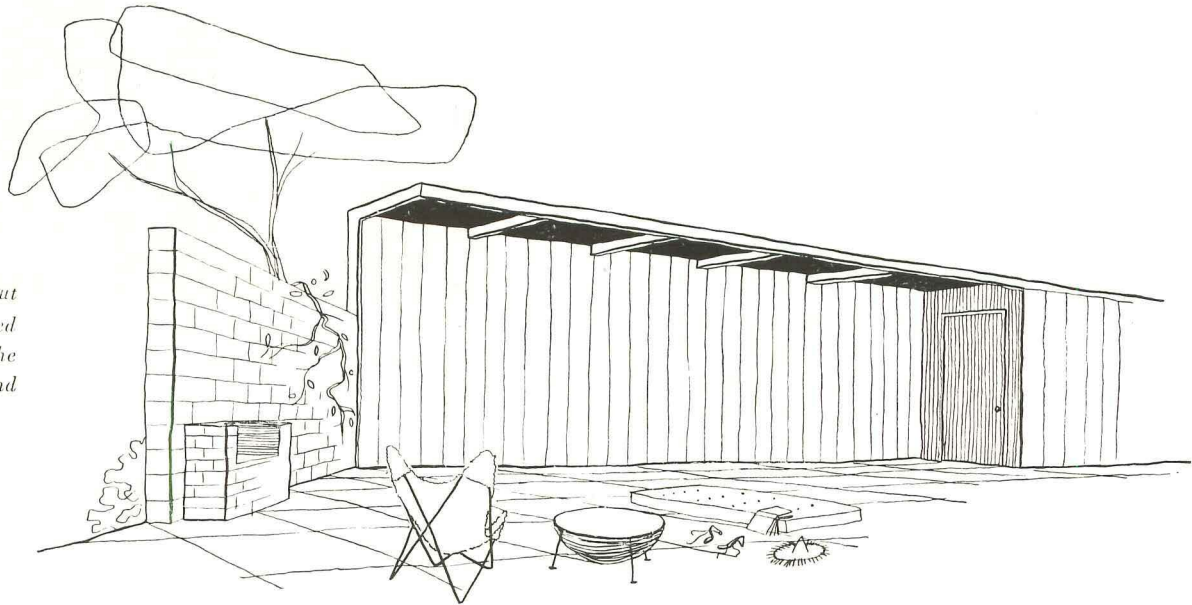

Breezeway between detached (cheaper) garage, below, and house, has post-and-pipe screen to be used as trellis. Sheltering roof adds to livability.

Side yard with fenced side yard for privacy can be easily shut off if split bamboo blind is hung over the side opening.

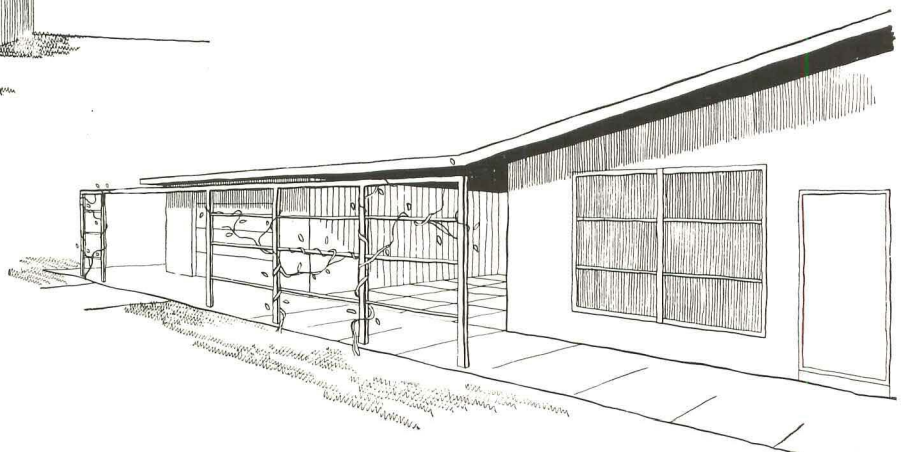

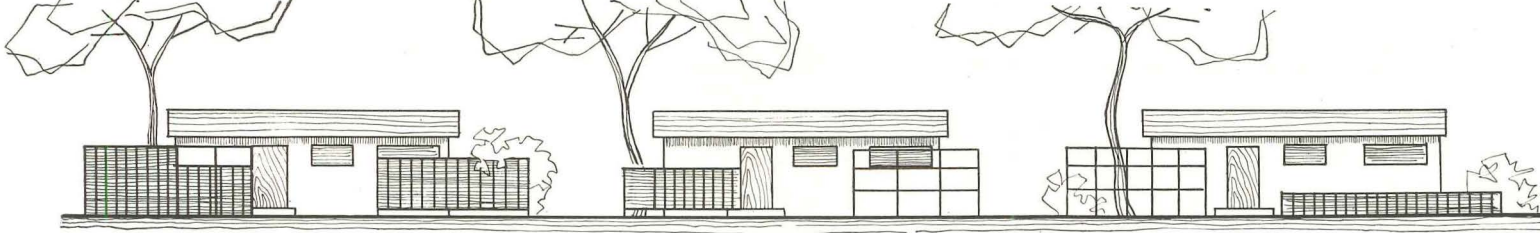

Well-designed fences can lend variety and interest—as well as to a streetscape of identical houses. They make small houses

Fences stretch the house to include private, outdoor living areas

Well-designed fences can work two ways. They can add to the usefulness of the land and they can add to the looks and the livability of the house.

Utility

Placed right, fences can furnish a pleasant outlook through wide windows instead of a grandstand view of neighbors' laundry on the line. They can also screen the owner's own drying yard, restrain his children and pets and keep a project looking tidy at all times.

More comfortable outdoor living, with a measure of climate control, is a dividend of fences. They are better (and cheaper) wind-breaks than planting and can create sun pockets in early spring and late autumn. Fences can give owners special outdoor areas for entertaining, barbecues, car parking; can insure orderly traffic arrangements by leading to front and back doors.

Looks

Think of the fence as a wall of your house, designed to harmonize with it and extend it, and—at \$1 a running foot—a 5' fence can:

1. Make a small house look as big as its lot;
2. Relieve the monotony of a row of identical houses;
3. Add a rambling, expensive look to even a boxy, inexpensive house;
4. Permit the builder to turn the short end of the house toward the street without having the house look tiny;
5. Underline good design features of the house and screen less fortunate ones.

Good fences don't just happen; they have to be designed. To get value from fences, don't just run them along property lines. Make them a continuation of the house, even connected to the house.

A "thin" rickety fence defeats its own purpose. It should know where it's going and look as though it did. If it has openings, they should be strongly framed. Since it is related to the house, it should have color, texture and pattern compatible with the house.

Height is important. A high fence is usually better than a low one, for practical as well as visual reasons. It is always better to have 4' than 3'; 6' is often better than 5'.

To be sure that your project will continue to look handsome and prosperous through the years, pick materials and construction that are easy to maintain. A picket fence is maddening to paint. Simple, flat surfaces are simpler to refinish. Stain or creosote finishes last for years. Also excellent: fagot or aspen fencing, translucent plastic sheeting, corrugated asbestos-cement panels, stone, brick, concrete, hollow clay tile, cinder block, plywood, tempered hardboard—plain or perforated, galvanized steel sheeting.

Photo by Maynard Parker



Fences frame living patios in houses for Stern & Price. They have been designed smoothly with the exterior h

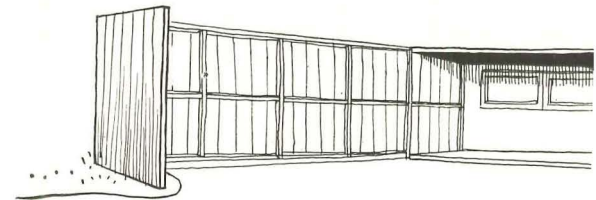

Car stand for visiting autos is if enclosed by a tidy fence, ca as a sheltered play space fo

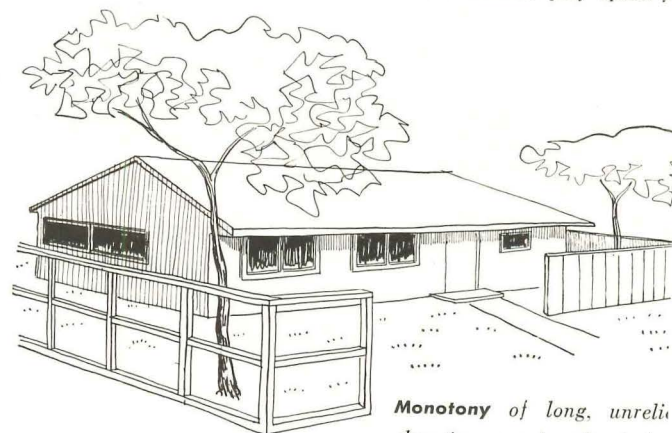

Monotony of long, unrelie elevations can be effectively the use of variegated fences.

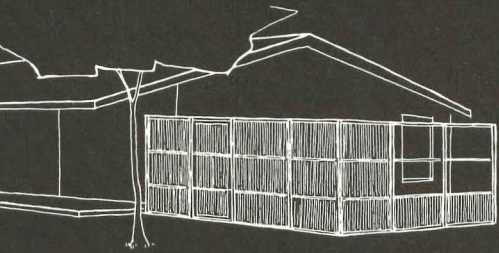

Wooden grill, painted white, has façot fence
topping, is left open where desired



Stock snow fencing can be hung
vertically in a 2x4 frame

Plastic-coated
panels cast green shadows
through plastic-coated
panels which costs
\$2.00 a sq. ft.

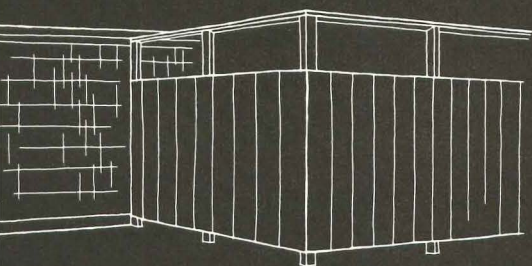
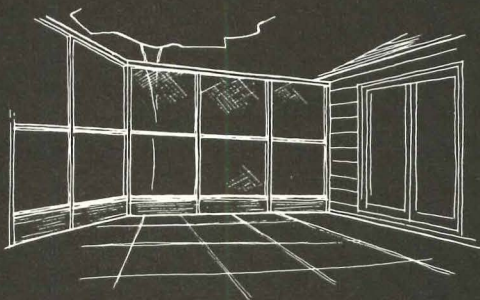

End-closed fence has
light, is less heavy than solid fence

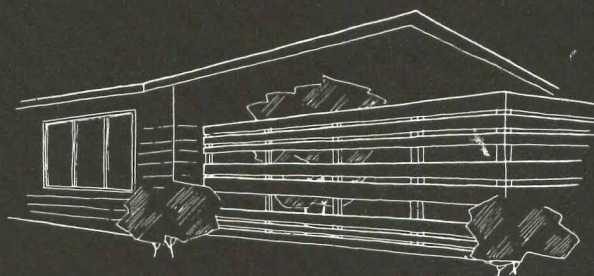

Random-width boards suggest
interesting horizontal patterns

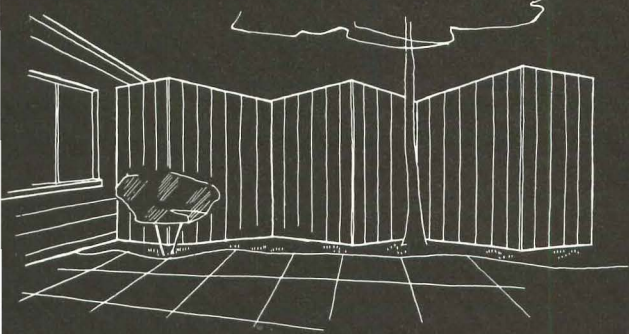

Stiff serpentine wood wall of random-width
fabricated panels, 4'-8' high, can be arranged
to fit around obstacles, is cheap

Weaving 1x8's around
posts allows ventilation

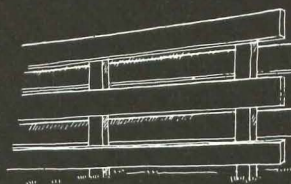
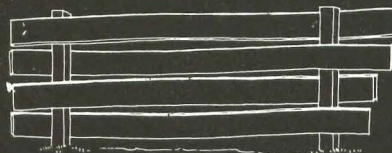

1x8's nailed
alternately to opposite
sides of 2x4 posts

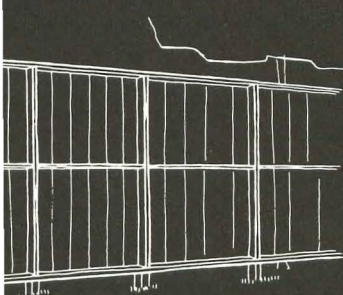

Endurable, redwood
panels nailed to
frame

Fence of 2x4's is architectural,
good for terrace edge or along
walk

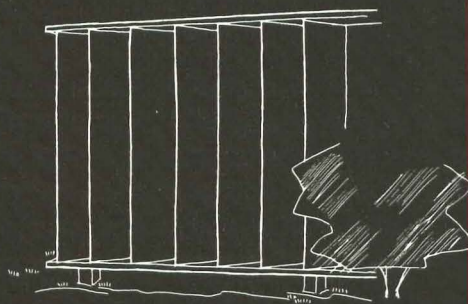
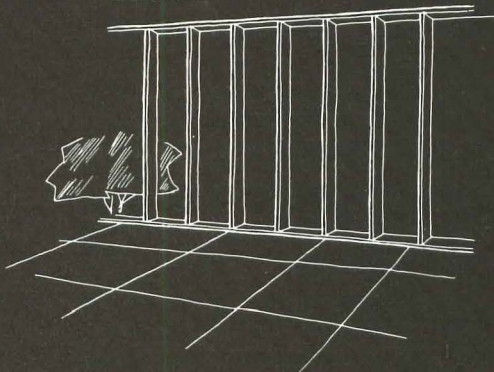

Lowered arrangement can
capitalize on prevailing breeze



What can a builder learn from his customers?

**He can save himself serious mistakes,
thousands of dollars
and discover new sales trends ahead of his competition—
all by asking his buyers
a few well-directed questions**

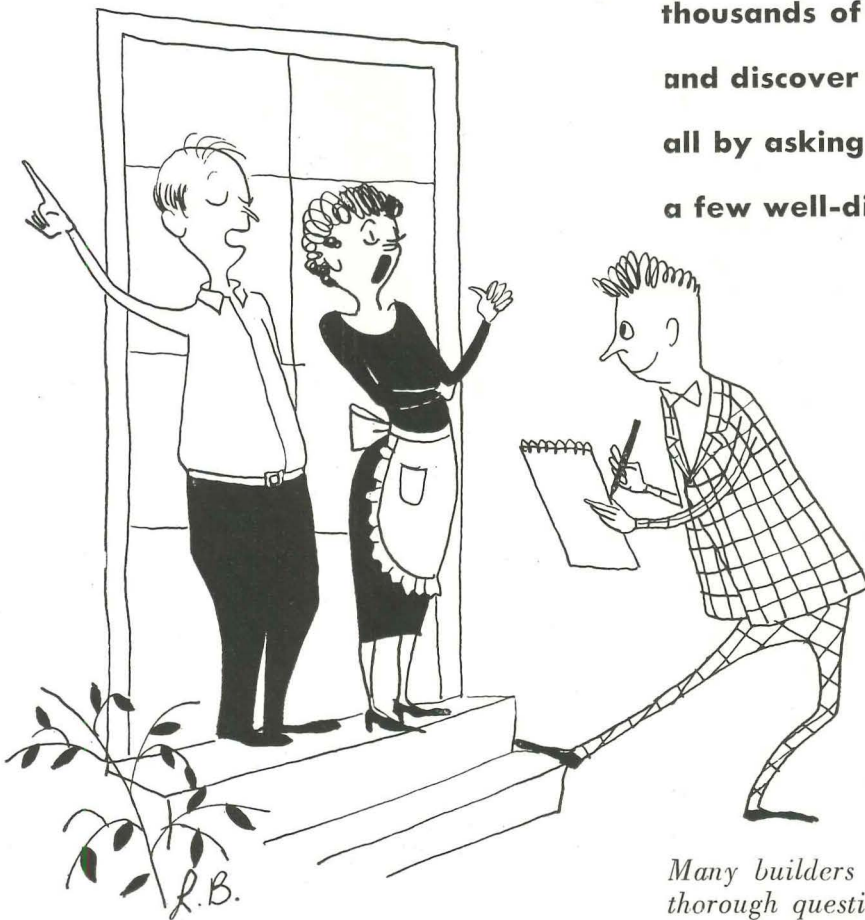

Many builders feel sure they know what people want in a house, thorough questioning of customers will often turn up some surprises. Smart builders are “knocking on doors” these days, asking questions and tabulating answers. They are finding out what is most popular in houses and what features are failures and sales liabilities.

Whom to survey Two markets can be explored: 1) People who have bought your past houses, prospective buyers. From the first group will come facts on what they have disliked in their present houses and what they wish they could have in a future house. From the second will come clues as to what they desire—and can pay for—in order of importance of these desires. A strong sales campaign can be based on the features people want most strongly.

How to survey To get professional results, any questionnaire must be:

Exploratory: Seek facts you don't already know, rather than evidence to back up your conclusions.

Specific: Use multiple-choice questions that will pinpoint what the person is trying to say.

Concise: Don't try to get too much information at one time. Several short surveys will be more valuable than one that is too long for people to answer or you to evaluate.

Nontechnical: Use the customer's words, not your own. Never assume that the language of business is his vocabulary.

Logical: A good reason should be given why the respondent should bother to answer.

Easy to answer: Stamped, self-addressed envelopes are a “must” for a mail questionnaire.

A final rule: Any information gathered is valuable only if you put it to work. Don't ignore customer preferences because they run counter to what you are sure people like or dislike.

West, a builder queries his, and his competition's buyers

Joseph L. Eichler, Palo Alto, Calif. Professional research firm did interviews.

135 Eichler buyers, 66 buyers of other houses.

Builder buyers first heard of the design through

36% (down 7% from 1951)

relative 30% (up 6% from 1951)

19% (up 7% from 1951)

articles 11% (up 9% from 1951)

The unexpectedly large group at the time will cause Eichler to pay attention to them. Greater thought will be given to the appearance, and location of these "outdoor

When nearly one-fifth of your come from one source, it indicates a valuable piece of selling

the people who bought his houses, the contemporary design as the most important factor, after cost, in their decision.

This confirmed the builder's belief that appearance was an important factor in their decision. They will continue to build contemporary houses. Eichler says: "We feel that our houses have been gaining more and more acceptance. This creates a problem: how to compete with the houses that many of our prospective buyers have to sell."

Two bathrooms were termed either "essential" or "convenient" by 86% of the interviewed.

All our future houses will have at least two bathrooms," says Eichler. "We are building two-bathroom houses right now in San Francisco on 2,500 lots, for \$13,600 on which we have \$11,100 FHA commitments."

Two-thirds of his customers said they were willing to pay up to \$2,000 more for a house with cork floors, sliding glass doors and other extras.

The firm is now studying the possibility of a de luxe model to tap this more affluent market. The value of a survey is indicated here by its unearthing of a market that is just beginning to be approached throughout the country: growing income and unutilized equities in their present homes, and larger families have put pressure on suburban families on the market for luxurious housing. Many producers are operating in a price and quantity today formerly reserved for the luxury builder.

Fact: One family out of five felt it had insufficient storage space.

Action: One of the principal design changes will be the addition of storage space, either through a garage instead of Eichler's usual carport, or an all-purpose room.

The personal interviews also revealed mild dissatisfaction with several other details. Specifically the builder learned what proportion of families would have preferred alternate materials or other changes and whether the comments were mild or strong. Consequently if the builder decides he wants to make changes, he knows where he can probably build good will with his future buyers.



In the Midwest, a builder questions his past customers

BUILDER: Place & Co., South Bend, Ind.

METHOD: Three-page mimeographed questionnaire, using multiple-choice questions, was sent to previous buyers with an explanatory letter from the builder.

SAMPLING: Place's higher-priced—\$16,000 up—subdivision was polled, with 375 families well queried. The completed questionnaire was returned by 30%, an adequate return for determining preferences.

Fact: Of the 112 families replying, about 99% said they received more for their dollar from Place & Co. than they would have from anyone else. After this gratifying opening, they settled down to give the builder the suggestions he wanted to hear. In almost every case the buyers desired more storage space. As Place builds on concrete slabs, storage is a critical problem.

Action: Since 72% of families said they were happy with their slab houses, Place will make no move to switch to basements for extra storage. Instead he will continue the design changes already being put in his new houses, i.e. larger kitchens (see p. 136) are adjacent to a large laundry and utility room that can become a family room if an owner wishes. Place had already begun using storage walls and his survey results will keep him doing so. Place is one of the first builders who saw the need for "the basement equivalent" mentioned by Round Table members (p. 120).

Fact: A front living room was preferred by 66% of the families.

Action: The firm will continue to put at least two-thirds of its living rooms in front. This bears out an experiment last fall and

winter in which 20 experimental houses were built (see sketch, p. 174) and the front-living-room houses sold fastest. But salesmen are aware that the rear living rooms looked out on the unlandscaped back yards of older houses where garbage cans and other unsightly objects were kept. To be successful, rear living rooms must have pleasant vistas.

Fact: In any house costing over \$10,000 there should be 1½ baths.

Action: The survey corroborated the Place theory that an extra half- or full bathroom is a strong selling point. Because the firm uses a low-cost prefabricated plumbing tree and carefully engineers the location of both baths and the kitchen plumbing, cost of an extra half-bath is around \$50. Under consideration now: a full second bath.

Fact: Among buyers of three-bedroom houses, no one wanted a fourth bedroom.

Action: "This has changed our planning," says James Peacock, president of the Place Realty Corp. which handles sales. "Perhaps fewer than we thought want four-bedroom houses, but all seem to want more space." Now their schedules will be recast, with four-bedroom houses held down to a more conservative proportion.

Fact: The 75' x 125' lots were satisfactory to all but an insignificant few.

Action: The question was asked on the assumption that an extra \$500 could be put into either a larger lot or into the house itself. The answers made it plain that additional house space or more equipment would be a more potent sales argument.

Fact: Even at additional cost, there was an appreciable demand for plastic floor tile in kitchen and bath.

Action: Answers on flooring show the value of the multiple-choice questions. Asphalt tile did not take the beating that Place expected, but many were willing to pay extra for hardwood floors in the bedrooms, or for plastic tile. Prices for each were given so that buyers could realize what their choice would cost them. Place also discovered his buyers do not want a combined kitchen and laundry and that "garbage disposals are here to stay."

A lot for a little: Place & Co. found this research experience so "interesting and profitable" that they will continue to use this method. They recommend that all questions be answerable with a Yes or No, or checkmark, or else endeavor to get a first-, second- and third-choice type of answer. For the insignificant expense of a mailing to 375 previous buyers whose names and addresses were already on file, and the tabulation of 112 answers, Place was able to get information that showed him several mistakes he was making in his planning. If only one such error were caught, the survey would be a bargain.



In the East, a builder interviews his new buyers

BUILDER: A large Eastern firm building ten different models in an exclusive subdivision.

METHOD: An informal mail questionnaire sent to recent buyers who had not yet moved into their houses. Main query: "Why did you buy the particular model you did?"

SAMPLING: All 85 customers were polled, with 36 replies, or 42%.

Fact: In the most popular design, a split level, the favorite features were the privacy of the upstairs bedrooms, the spaciousness of the house, and particular reference to a large bay window in the living room.

Conclusion: The questionnaires have been received too recently for specific action. But here is information that every builder of split-level houses should consider for the future. Even if the overwhelming popularity of the split level in the New York area is temporary (as some believe), how can a builder use the best of its features in future floor plans for nonsplits?

He can guarantee privacy by segregating his bedrooms from living quarters. If a large proportion of buyers prefer bedrooms above ground (so passers-by cannot look in), this particular builder could use his rolling ground to advantage. Bedrooms could be located in the end of the house which projects highest above ground. The popularity of the big bay window teaches another specific lesson. Buyers thought the living room with the floor-to-ceiling bay window was the largest of any model. Yet other living rooms were practically the same size. This proves that a big window adds spaciousness to a house. Several families also mentioned the advantage of the daylight basement playroom in the split level. This could also be added to nonsplits as a standard item or as an extra.

Fact: Buyers said they were attracted to this development because of the number of house types in direct contrast with the

monotony of projects with only one or two different designs.

Action: This will influence the builder to continue building one-story, split-level, expandable-attic and two-story houses with various elevations. From the questionnaires it is clear that the more variation this builder offers his customers, the wider his market will be. The builder will drop one slow-selling design but it did not take a questionnaire to tell him that house was not popular.

Fact: Many families mentioned that the most popular feature with them was the location of the tract on "high land."

Action: As many potential buyers are now living on low, flat ground without trees, it is clear that high, rolling, well-wooded land is a very strong selling point. This can be emphasized more than it has been in newspaper advertising.

Fact: Every family buying a two-bath or a 1½-bath house listed the extra bath as a leading attraction.

Action: In this price range (\$17,000-\$22,000) the builder should consider offering the 1½ or two baths in every model.

Suggestions for improvement: Each questionnaire also asked: "If you were seriously considering the purchase of another builder's house, what features in his house did you feel were outstanding?" There was also space for comments or suggestions. From these questions the builder received a wealth of information.

Fact: Improvement most often suggested for model homes to make them more attractive to the prospective buyer was a better job of decorating, with some complaints against traditional furnishing.

Action: No professional help was used in either decorating or furnishing, and choice of wallpaper and paints was left to the discretion of the subcontractor. Although

people bought houses despite disliking the décor, it seems logical to consider a professional decorating job might result in additional sales to prospects dissatisfied by the subcontractor's choices. It is significant that the best-selling houses had the best furnishings.

Fact: Lack of gutters and downspouts was objected to by 15% of buyers. It was noted that this almost caused him not to buy the house, and it took other features to overcome this drawback.

Action: This points out an educational problem on the part of the salesmen because the county demands an outside dry well wherever gutters and downspouts are used, the builder is using wide trenches to throw rain water away from the house and foundation. More information on the cost of dry wells in this rocky area and a good sodding job around the perimeter of the models to minimize trenches and dripping eaves should reduce the complaint caused by the lack of an item which the customer thinks a necessity.

Fact: Buyers wanted an outside dry well, basement, kitchen exhaust fans, more storage space, larger kitchens, more cabinets, larger windows, better kitchen arrangements, and a scarf for other items.

Action: None yet. While sales are good, the builder may feel he can disregard the demand but next year he can lead to give his houses more sales if the market becomes tougher.

Fact: Many buyers criticized either the job of extras, such as a garage, or the way in which the entire system of extras was handled. Some believed the builder was charging whatever he thought the traffic would bear. Obviously this was true. But the misunderstanding and pardoning good will between builder and buyer, and needed to be straightened

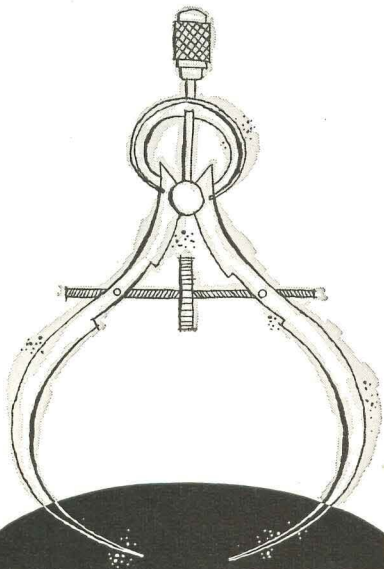

How **GOOD** can we make it?

In the design, engineering and building every Ro-Way overhead type garage door, the guiding principle is simply this: make it as good as it can be made.

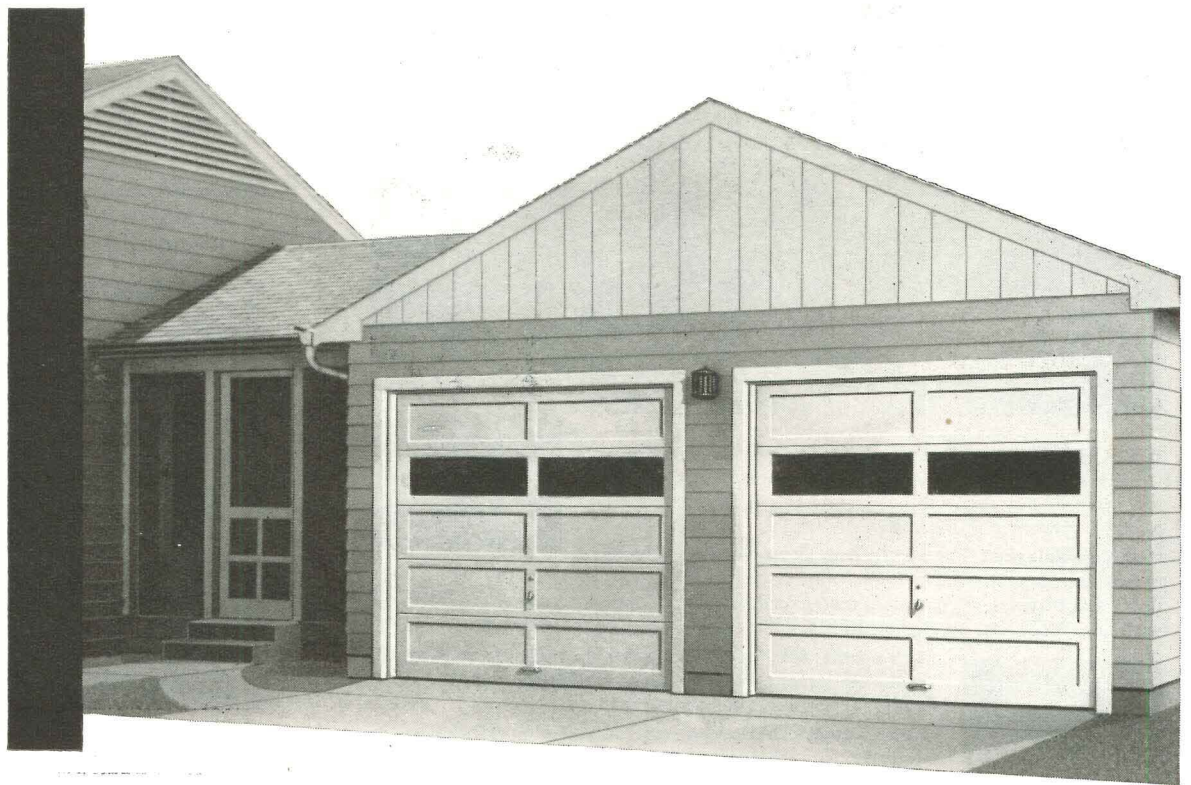

Take Ro-Way appearance, for example. Clean, simple, functional lines that blend unobtrusively with the building design. Lines that bespeak the thoroughbred quality built into every Ro-Way door.

Take Ro-Way construction. Mortise and tenon joints are not only glued, but *steel* doweled as well. Muntins, rails, and stiles are *precision-squared*. Sections are *rabbeted* to assure weather-tight joints. Millwork is both *drum* and *hand sanded* for extra smoothness. Heavy gauge steel hardware is fabricated on special machines right in the Ro-Way plant—then *Parkerized and painted* for lasting protection.

Take Ro-Way operation. Easy, quiet opening and closing. Smooth-running, ball bearing Double-Thick Tread rollers glide easily through the track. Springs are Power-Metered—individually matched to the weight of each door. Taper-Tite track and graduated Seal-A-Matic hinges assure snug, weather-proof closing.

Finally, Ro-Way designers and engineers are constantly striving to make Ro-Way doors even better. In this way we make certain the name Ro-Way identifies the finest in overhead type garage doors.

ROWE MANUFACTURING CO.
1118 Holton St., Galesburg, Ill.

Ro-Way
OVERHEAD TYPE
DOORS

there's a
Ro-Way
for every
Doorway!

For sales and installation, see your classified directory for nearest Ro-Way distributor



How to plan A 100% USEFUL BASEMENT

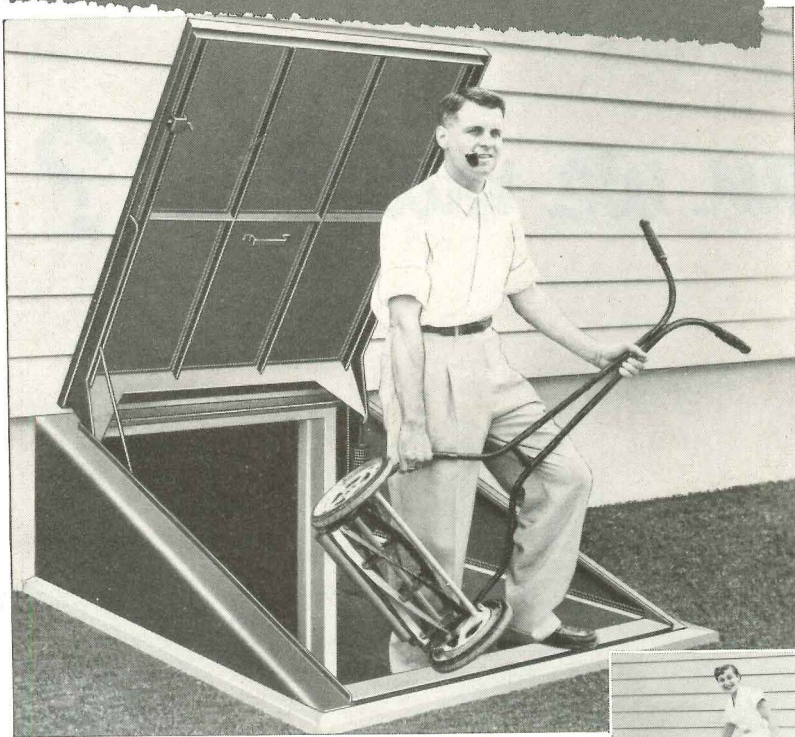

Finger-tip control! Specially designed spring suspension counterbalances weight of sturdy door.

SPECIFY the new Heatilator® Service-way. It gives you a direct exit from the basement to outdoors. The Service-way makes it easy to get things in and out of the basement quickly, without going through the house.

New Convenience! The Service-way simplifies the problem of storing lawnmowers, garden tools, screens, storm windows and bicycles. Repairmen, meter readers and children with muddy feet can go directly to basement from outdoors.



Saves steps on washday. Clothes can be carried direct from laundry to clothesline, with fewer steps to climb.

Extra-wide Service-way opening permits installation of bulky equipment. Plenty of clearance for freezers, pingpong tables, hobby shop equipment, etc.

Heavy-gauge reinforced steel door is counterbalanced by double action springs for finger-tip operation. Weather-tight, burglar-proof. Overlapping flanges assure snug fit. Slide bolts lock the Service-way door securely from the inside.

The Service-way adds to property values... one of the most desirable convenience features for the modern home, worth many times its moderate cost. See it at leading building supply dealers. Made by the makers of famous Heatilator fireplace. Mail coupon today for folder and specifications.

HEATILATOR SERVICE-WAY



Heatilator, Inc.
565 E. Brighton Ave.
Syracuse 5, N. Y.

Please send me folder and specifications on the new Service-way.

Name _____
Address _____
 Architect Builder Dealer
City _____ Zone _____ State _____

New Products

HARDWOOD PANELING in random le graining comes down off luxury shel

Solid mahogany wall paneling in house? Why not! At 35 to 45¢ p Philippine white and red varieties more than dry wall, painted or pap the friendly dignity that even a si wall can give to a home more tha sates for the small premium. From purchaser's vantage, hardwood's te more than surface deep. Requirin, tion—an occasional waxing and wood paneling, like wine, improves. Figured over a 10-year stretch (ha of an FHA mortgage) hardwood cost far less than plaster wall pl nance.

Currently plentiful larders of im domestic species, advanced millin and relaxed tastes have combined t erstwhile luxury of hardwood wit range of the small-home builder. years ago a hardwood contract called for custom millwork and h master mechanics. Now, exotic blo ash-brunette Pal Dao, and titian Ho

Random cut hardwood panels with variegated markings complement casual contemporary architecture.

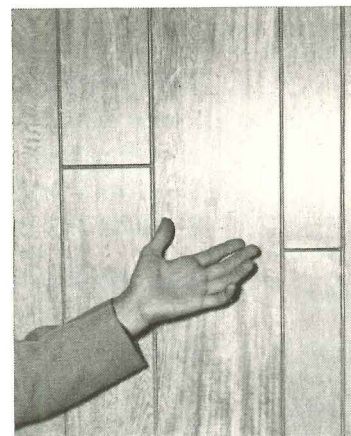

Big factor in taking hardwood out of the tycoon gameroom class and putting it within shooting range of homebuilders is the frank way less expensive cuts can be used. Instead of masking seams where sections meet, they are played up by using butt-type or V-notch joints.

Half as thick as costly 3/4" panels, the 3/8" board is strong, easy to handle. Solid wood paneling is installed when the house is closed in and dry. Panel backs should be sealed against moisture. A coating of liquid wax makes a mellow top-coat.

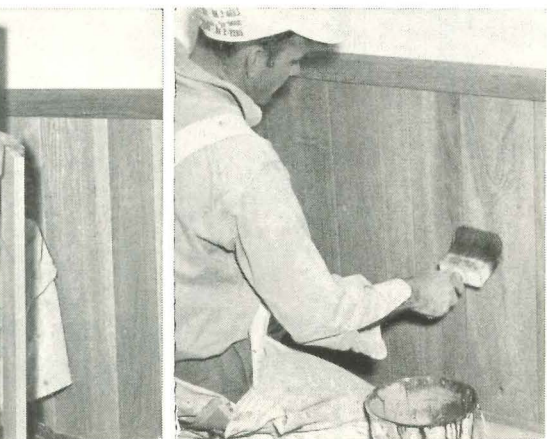

in single batches of 10,000 to factory crafted, and sold over 60 and 65¢ per sq. ft. The supply is stretched by cutting and 3/8" slices as well as the floor-to-ceiling boards, matched color, are magnificent drama in settings—and many designers, use strings, often specify such standard uniform length. Fortunately, a healthy representation of architects—and the public—not prefer the less wasteful, and random-size paneling of variously because its naturally imitative in keeping with a casual and also, perhaps, as release tonous regularity of test-tube

packaging pre-cut hardwood trim at comfortable prices are: E. J. Stanton & Son, Inc., Box Annex, Los Angeles 54, Calif. Architectural Hardwoods Div., 666 Ave, Chicago 11, Ill.

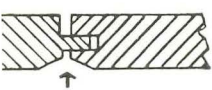

Standard V-Groove

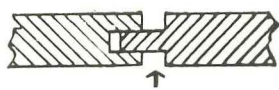

Modern Square-Groove



How to plan A NON-SMOKING FIREPLACE

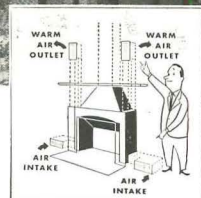

SPECIFY a Heatilator® Fireplace. It protects you against guesswork, rule-of-thumb construction, and all the mistakes that result in faulty fireplaces and client dissatisfaction. You can be sure the fireplace will be built just as you plan it—smokeless and trouble-free, giving your client a lifetime of satisfaction.

The Heatilator unit is engineered according to established and proved principles of fireplace design. In one compact unit, it provides all vital parts from floor to chimney flue, including scientifically designed firebox, throat, downdraft shelf, damper and smoke dome. It standardizes and simplifies construction, and saves architectural time ordinarily needed for detailing the masonry and for close supervision during construction.



Hidden in the masonry, the Heatilator Fireplace unit puts no limit on mantel design or type of materials used.

No limit to design. The Heatilator unit is practically hidden in the masonry, and allows complete freedom of architectural expression, both in style and decorative treatment. No restriction on mantel design or materials used.

The Heatilator unit draws in air from floor level, heats it, and circulates it to warm every corner of the room. Specified and recommended by leading architects for over 26 years. Sold by building material dealers everywhere.

HEATILATOR FIREPLACE

T.M. REG. U.S. PAT. OFF.



Heatilator, Inc.
615 E. Brighton Ave.
Syracuse 5, N. Y.

Please send me your new A. I. A. folder with full details and specifications on Heatilator Fireplace units.

Name _____
Address _____
 Architect Builder Dealer
City _____ Zone _____ State _____

HERE'S THE KEY TO NEW
VALUE AT LOWER COST

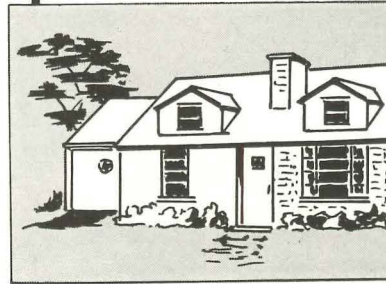
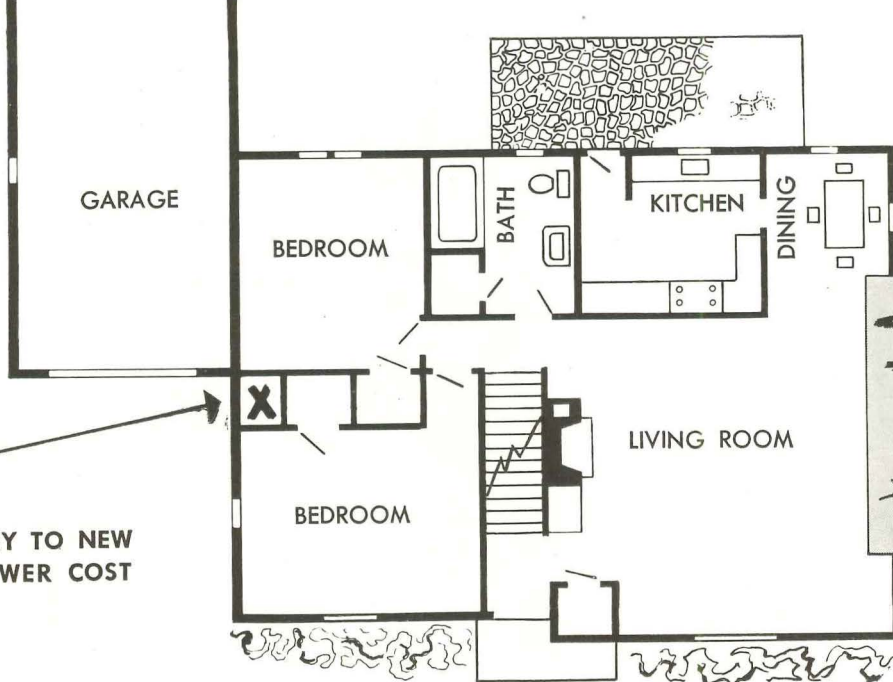

Remington Consoles are available in 1-ton and 1½-ton units for installation in closet, attic, or basement—to cool two good-sized rooms. They are available in both air cooled and water cooled units for various voltages AC or DC.

Fully automatic in operation, they have Remington's exclusive Climate Compensator, which maintains a perfect balance between cooling and dehumidification no matter whether the situation is "hot and dry" or "warm and sticky."

Remington, with the most complete line in the industry, also offers console models in handsome traditional mahogany or blond cabinets—for living room or master bedroom—as well as a full line of window units in these capacities: ⅓, ½, ¾ or 1 h.p.

With 64 years' experience in refrigeration, Remington now manufactures room air conditioners exclusively—heavy-duty, tropics-tested equipment, proved by installation in 57 countries all over the world.

How to cut construction costs . . . while adding value and sales appeal

Sound impossible? Architects and builders are doing it every day. They *add* value and sales appeal by including Remington Room Air Conditioners . . . and they *save* construction costs at the same time. The plan above shows a typical arrangement in which a Remington Console air conditions two bedrooms.

WITH REMINGTON YOU ADD THESE SALES APPEALS:

Complete sleeping comfort . . . With cool, dry, pure, healthful air all year 'round.

Warm air on brisk mornings . . . From Remington's optional heating feature (up to 7,000 BTU's per hour). This can save use of the central heating system for several weeks or more every year.

Privacy and better use of space . . . Because ventilating windows are not needed; their elimination permits plans with blank walls for privacy and more usable wall space.

Lower maintenance costs . . . Upkeep for fewer windows, saving on heating.

WITH REMINGTON YOU CUT COSTS THIS WAY:

You gain freedom in design . . . Self-contained, Remington Room Air Conditioners

leave you free to select the type of window you want. And you can orient the house to meet your major objectives.

You save on windows . . . You need not make costly provisions for window screens.

You eliminate other ventilating . . . And in milder climates you need not use space heaters or a central heating system.

First cost is low . . . No other form of room conditioning is so easily installed. Remington Consoles use no water lines, no plumbing, piping or drains.

Many builders are including room air conditioning by Remington for two bedrooms for an amazingly low price. Careful planning saves most of this cost. Builders can offer lots more in sales appeal at the price.

You can add this new, exciting feature to your houses right now. Remington insert in Sweet's Home Builders' Guide is a host of ideas on air conditioning. The print is yours for the asking. Write for it and mail the coupon.



FOR BETTER HOMES

Remington Air Conditioning Division
20-3 Willey Street, Auburn, N. Y.

Please send the Remington insert in Sweet's

Name _____

Address _____

City _____ Zone _____ St _____

It's new!

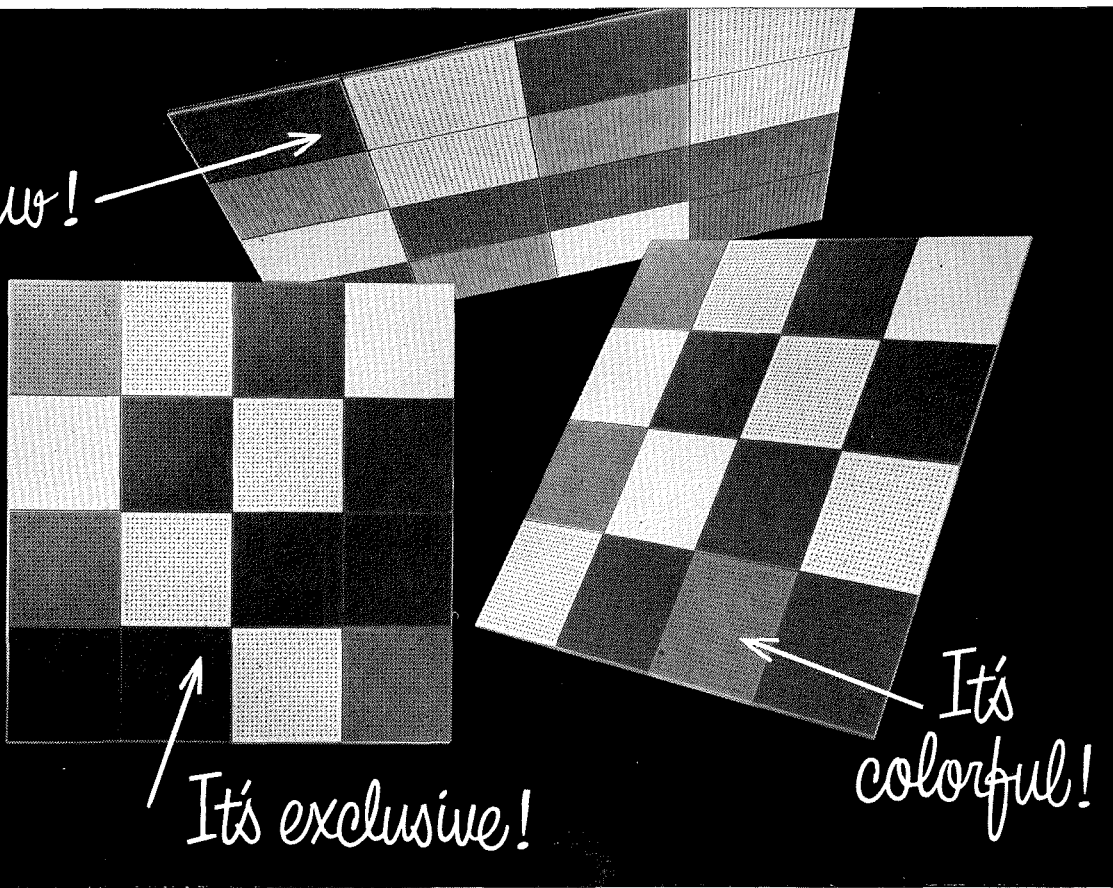

It's exclusive!

It's colorful!

Nu-Wood *Kolor-Fast* acoustical tile!

Here's new scope for you in planning acoustical installations. Today, Nu-Wood acoustical tile is available in a combination of four variegated shades, ranging from rose-tan to greyed-tan—to add the charm of fadeproof color to acoustical installations.

Nu-Wood Kolor-Fast acoustical tile is ideal for side wall installations, either in commercial buildings or homes where better-than-average sound correction is desired. It forms a perfect combination with Nu-Wood Sta-Lite—the high light reflecting acoustical tile that actually grows brighter with age. Now, with Kolor-Fast and Sta-Lite acoustical tile, you can offer owners advantages never before available in insulating acoustical tile! WOOD CONVERSION COMPANY, Dept. 119-53 First National Bank Building, St. Paul 1, Minnesota.



Endless Design Variety! With the combination of four variegated shades of Nu-Wood Kolor-Fast acoustical tile—plus Sta-Lite plain and Sta-Lite acoustical tile—design possibilities are practically unlimited for both commercial and residential work.

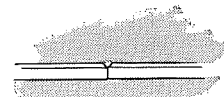

Pencil Line Bevel! Here's another Nu-Wood feature—a shadowline joint for greater beauty and distinction. Just another example of the extra quality which puts Nu-Wood in a class by itself.

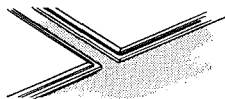

Easier Application! The famous Nu-Wood clip system provides complete wrap-around support for both Kolor-Fast and Sta-Lite acoustical tile—permits fast, correct application and center-of-ceiling starting of tile. Or, if desired, Nu-Wood acoustical tile can be applied with Adhestik.

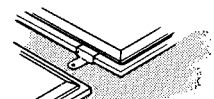

Tongue and Groove Joints Weld Tiles Together! The specially designed tongue and groove joints of Nu-Wood acoustical tile assure tight joinings that stay tight, look better. Air movement through joints is reduced, thus minimizing collection of surface dirt.

Get in now on this profit opportunity—mail the coupon!



Guaranteed Attic Insulation



Choice of the Experts

Nu-Wood*

PRODUCTS OF WEYERHAEUSER

*REG. U. S. PAT. OFF.

Wood Conversion Company
Dept. 147-53, First National Bank Building
St. Paul 1, Minnesota

I want to know more about Nu-Wood Kolor-Fast and Sta-Lite acoustical tile. Please send complete information.

Name.....

Address.....

City..... State.....

NEW LOW PRICES

SAVE BUILDERS MONEY!

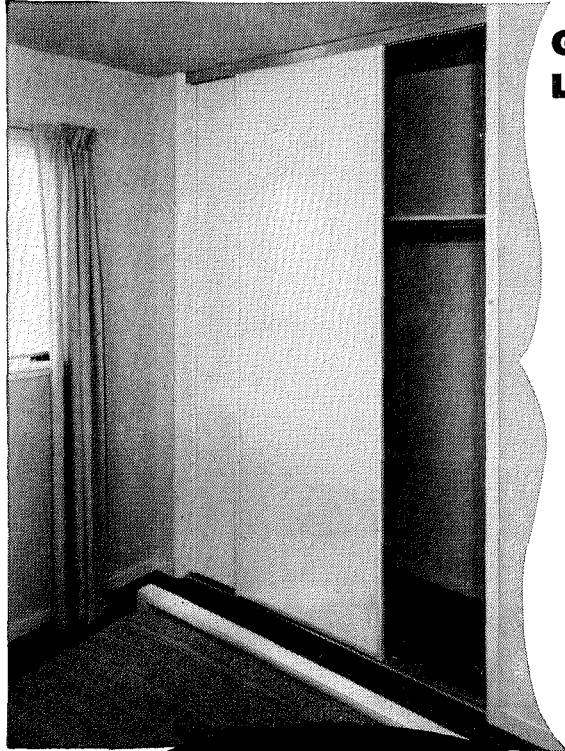
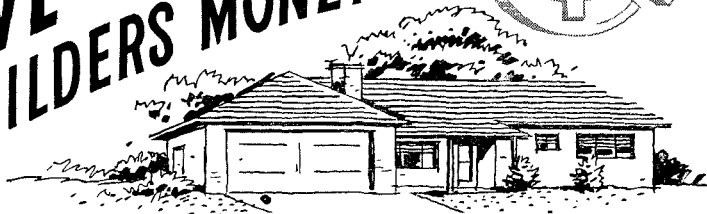

**GREATER VALUE..
LOWER COST**

- NEW MODEL "H"-
OVERHEAD HANGING
GLIDING ROLLER TYPE
- STANDARD MODEL "R"-
BOTTOM ROLLER TYPE
- BOTH FLOOR-TO-
CEILING OR STANDARD
HEIGHTS
- BOTH EASILY AND
INEXPENSIVELY INSTALLED
- BOTH SAVE CONSTRUCTION
LABOR AND MATERIALS
- BOTH NOW AT LOWER
PRICES

EASY TO INSTALL AS A B C!

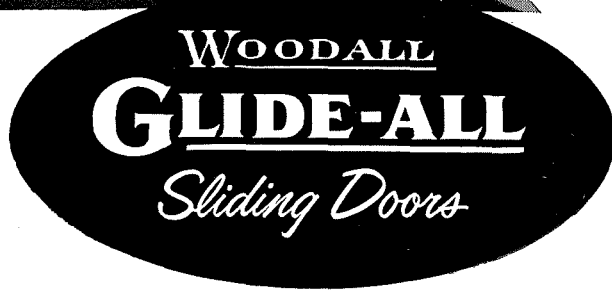

New low cost Glide-All Sliding Doors offer many money saving advantages . . . they contribute extra sales appeal to any building, yet save time and construction costs. They're ideal for any type of building project—small, medium or large—moderately priced or luxurious. Glide-All Sliding Doors are proven in use in thousands of homes and apartments from coast-to-coast.

Write for new low price schedule!

Glide-All Sliding Doors are a product of



DETROIT 34, MICHIGAN

4 Woodall Plants Coast-to-Coast Save You Shipping Time and Costs!

Write to Plant nearest you

Chicago, 3510 Oakton St., Skokie, Ill. • Laurel, Miss., P. O. Box 673 • New York, Glen Cove Rd., Mineola, N. Y. • San Francisco, 1970 Carroll Ave.

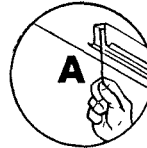

Top track is easily mounted on ceiling with screws.

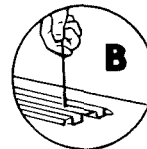

Aluminum bottom door guide is screwed to the floor.

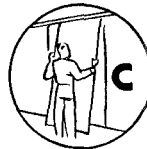

Doors are mounted in tracks by pushing doors into upper track, then engaging guide in floor guide.

SEE SWEETS CATALOG File 25c W0 for complete details and specifications.

Excerpts from the TABLE on how to plan your next house

The objective

Cole: Our objective is better everybody in America. My co I want to cooperate and will co want to give Americans decent which will bring them a gre home life and satisfaction, and of what it really means to live country.

Hollyday: Now, when some char made, may be the time for reche ing a new look at the problems in our present economy. The F go back a good bit and there for some real improvement. I to trying to make the improvem to be necessary.

Land planning

Anshen: By the time land pla the standards that the various commissions have, it conforms considered best by the pioneers earlier. If land is planned corre save money by making stre Most streets built today are t most streets have to have side of arbitrary standards.

Manilow: Would the fire depa with you?

Anshen: Yes, if the streets are there are small off-street loops can actually serve the house w through traffic. Then you don't wide streets and sidewalks. You atmosphere. Grass can come r the little gutter.

You can have off-street parl You can save dollars, and th money in the actual house, or a product that costs less money.

May: We have a planning co hated to see the prune orchar they forced us to have 37' b plus sidewalks on both sides, a miles from any community.

Hughes: I have been talking a 2 out a sidewalk to city comm years. I won for four or five ye ple who bought the houses stan ing to the city commission.

Manilow: Wherever the munici me to, I prefer to eliminate gutters, but most of them insist

contin



Unusual design of ranch-type apartments adds distinction to Fairmont Acres.

FAIRMONT ACRES . . .

Dayton's newest subdivision . . . is
equipped throughout with Frigidaire Appliances

LOCATION: Dayton, Ohio
BUILDER: Swango Construction Company

Fairmont Acres, located in the southeast section of Dayton, offers prospective customers a choice of two types of dwellings, an interesting variety of street layout, and the finest of household appliances — Frigidaire. When completed, this latest project of Swango Construction Company will total 600 houses and 40 "Ranch Apartment" buildings. To date, 250 houses have been completed and sold, and 25 apartment buildings have been rented.

The part Frigidaire Appliances play in influencing house sales is well known. Each Fairmont Acres home when sold included a Frigidaire Automatic Washer and Electric Clothes Dryer, and all the

apartments a Frigidaire Refrigerator, Electric Range, Washer and Dryer, thus bearing out these products' sales appeal.

Whether you choose them for large homes, housing projects or apartments, Frigidaire Appliances add to the desirability of *any* dwelling. To get complete information about the many fine Frigidaire Household Appliances, call your Frigidaire Dealer—or the Frigidaire Distributor or Factory Branch that serves your area. Look for the name in the Yellow Pages of your phone book. Or write Frigidaire Division of General Motors, Dept. 2104, Dayton 1, Ohio. In Canada, Toronto 13, Ontario.



Apartment" kitchen streamlines work with this Frigidaire Washer, Dryer and "Thrifty-30" Electric

Refrigerator, the modern food-keeper, completes the Frigidaire-apartment kitchen.

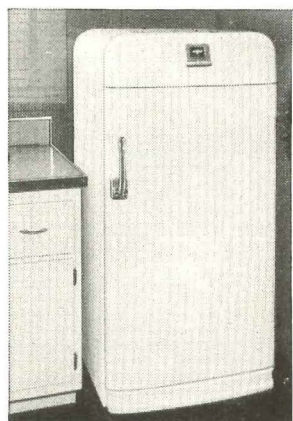

FRIGIDAIRE



Built and backed by General Motors

Enjoy Arthur Godfrey's daytime show on TV or radio.

Refrigerators • Electric Ranges • Home Laundry Equipment • Food Freezers
Electric Water Heaters • Air Conditioners • Electric Dehumidifier

BRIGHT IDEAS

to make homes LIGHTER and BRIGHTER

... with DRAMATIC WINDOWS TO THE SKY!

For more practical use of inside rooms, more pleasant use of any rooms — put Wascolite Skydomes overhead. Genuine Wascolite Skydomes, with “the dome that floats in its frame”, are weather-proof, shatter-resistant, maintenance-free . . . come in 17 economically-priced stock sizes . . . square, rectangular or circular shapes . . . with clear colorless or white translucent acrylic domes. For new construction or modernization, on flat or

pitched roofs, wherever cheerful daylight is desired, easily-installed pre-assembled Wascolite Skydomes are the natural daylighting choice. See Sweets' 19a or write for new residential folder. *Wa*

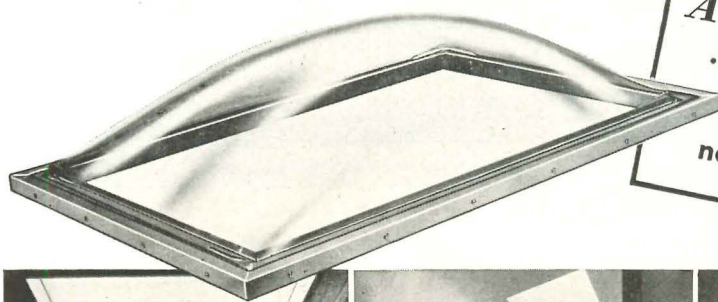

EXCLUSIVE!
frames of
**EXTRUDED
ALUMINUM**
... a big advance in
appearance and
performance ... at
no advance in price!

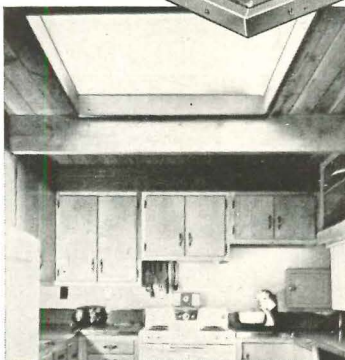

Never a “dull” moment in this kitchen—a Skydome sends floods of cheery daylight to every corner.

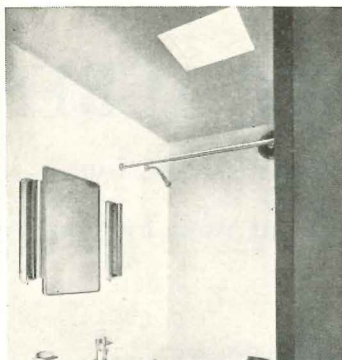

Plenty of bright daylight for shaving or make-up in this inside bathroom—there's a Wascolite overhead.



Sunlight an indoor garden with Wascolite Skydomes. Bright idea for sunporch, too.



Two Wascolites sunflood inside rooms here, make windowless spaces bright as all outdoors.



By day or night the light is right—fluorescent fixtures can be built into the Skydome “well”.

WASCOLITE SKYDOMES

U. S. PAT. 2610593



Other patents pending

WASCO FLASHING COMPANY, 88 FAWCETT ST., CAMBRIDGE 38, MASS.

Excerpts from ROUND T

Spiegel: I am not using sidewalks ent development. But FHA does very sound argument: that in s live young families with children. baby carriages and they cannot a narrow street. Most folks leave the road. A garbage truck come street and there is no place to babies. It is for that reason FHA sidewalks in those developments.

Goodman: Put a narrow strip of p of the house, between the lots.

Dayton: In most big cities, final tentative maps are all set, and it i job to change them. You can h stupid practices that exist. I kn borough requiring that every l house is built be graded toward th

Goodman: FHA requires it in Wa

Dayton: Think of taking a hillsid perfectly beautiful virgin land, an authority tell you that every p graded to the existing street, w street may be.

Communities

Goodman: People do not want t project where all the houses are th same cost, and everything else i They want to live in a varied com problem is to merchandise a com a project of houses selling for so ing a certain area and a certain of them identical, 100 of them or

Spiegel: You put custom houses 000 houses?

Goodman: Right in the middle of

Prentice: If you improve your si how do you make money on it?

Goodman: On a small house, on a of land, every penny counts. W into the larger house you have a spread. If you have a graded con can balance it all out.

Siting

Yost: On 60' x 60' lots we were new houses, all about the same the 60' lot looked like a 70' lot b the houses. They were staggere way—and some of them placed e people didn't feel cramped in the

Satterlee: If you attach a carpo face the short end of your house and still have it look large. You

contin

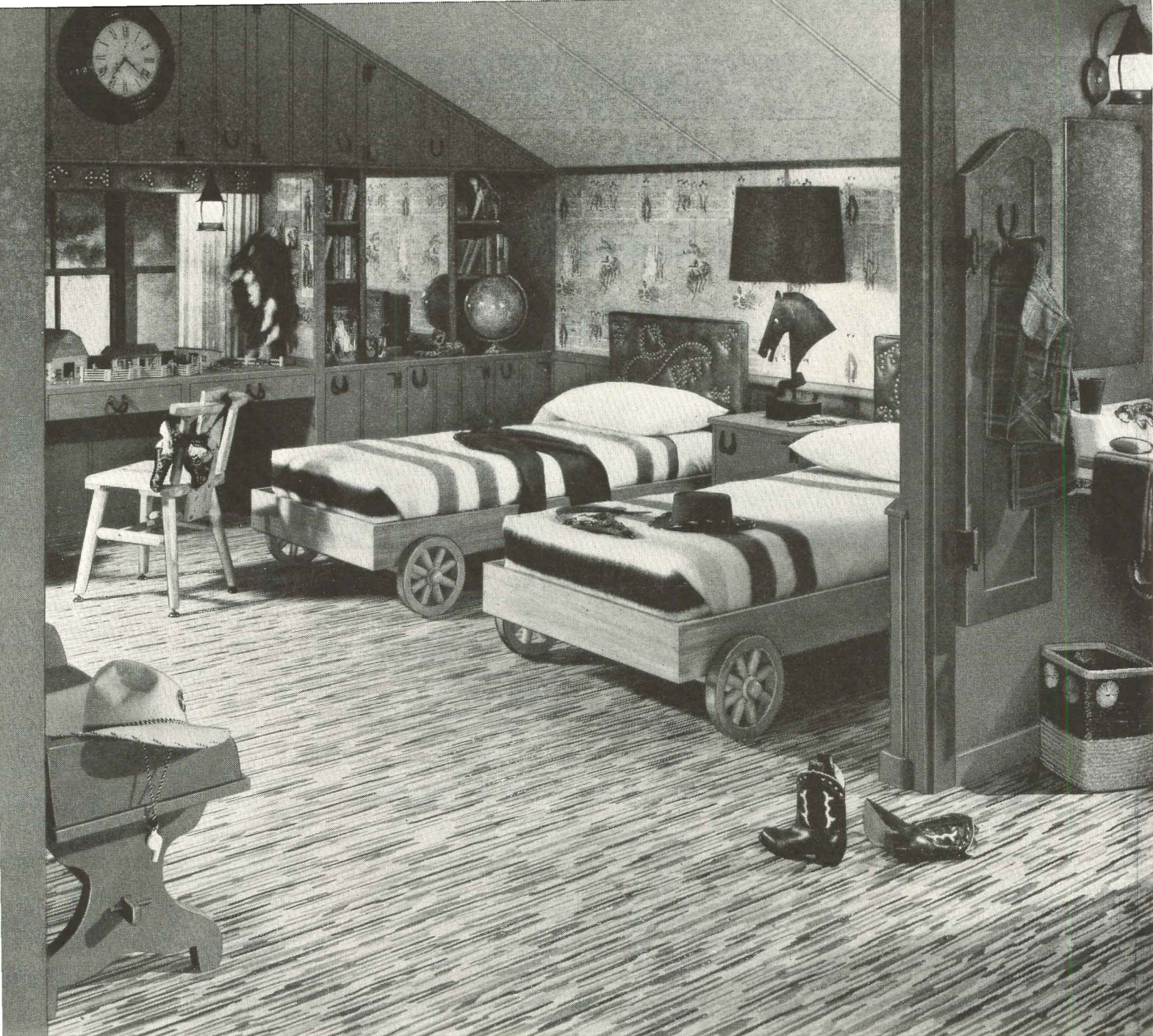

Upstairs in the attic for extra sales appeal at low cost

IT'S a good way to sell houses faster by offering a lot of extra little added cost. Covering the attic and putting down a floor make a strong impression on your prospect that far exceeds the modest price increase—especially if you add one or two simple touches. Or, you can provide the details and promote the idea to the buyer to do the work himself.

For example, is a spacious Westchester children's room that will appeal to young parents. Yet there's hardly any work involved. A corner of the room is partitioned off and fitted with bathroom fixtures. Inexpensive

storage cabinets are built along one wall—and there's an economical floor of Armstrong's Linoleum that gives the whole room a luxury look that's most impressive to a buyer.

When you specify a floor of Armstrong's Linoleum for an attic like this—or for any other room—you put more than just good looks to work in helping to sell a house. There are many other practical reasons why housewives prefer this famous floor. It is easy to keep clean, because of its smooth and virtually seamless surface. Armstrong's Linoleum is splash-proof, greaseproof, quiet and comfortable underfoot. Buyers appreciate its long-

wearing qualities and the fact that it never needs costly refinishing. They know it will last for years, even with the rough treatment it will get in a children's room like this.

Whether you're building one house or a multi-unit development, it pays to offer the extra sales appeal of colorful, practical Armstrong's Linoleum Floors for every room in the house.

SEND FOR FREE ROOM PLAN

For a sketch plan of this room, with color scheme description and a complete list of furnishings, write Armstrong Cork Company, Floor Division, 105 Sixth St., Lancaster, Pa. 



Extra that helps sell homes for Builder Charles Haring



"When people buy houses today they look for the extra values we builders add for their year-round comfort.

"One of the extras we furnish is the cool summer comfort supplied by a Robbins & Myers attic fan. Even on the hottest nights, these fans are so efficient that one generally sleeps under a blanket.

"It is surprising how much greater your home living comfort becomes with the addition of these fans.

"Personally, I wouldn't be without them in my home, and that is why I use R & M fans in the better houses I build."

*Charles F. Haring, Jr.
HARING & GRANT, INC.
Tuckahoe, New York*

LET ROBBINS & MYERS ADD "SELL" TO YOUR HOMES

Like Mr. Haring, you can increase the sales appeal of your homes with R & M "Package" Attic Fans. They're great sales closers. And they really do a job! At the flick of a switch, stuffy daytime heat of home and attic is whisked out . . . and cool, fresh outside air is pulled in. An R & M Attic Fan is the extra value today's home buyer demands. It's the easy, low-cost way to build your sales talk right into each house.

Fits low attics and all standard hallways. The smallest unit needs only 16" of attic clearance; the largest but 22". Perfect for "moderns" with limited attic clearance. Fan guaranteed five years; motor and shutter, one year. Available in sizes with certified air deliveries of 5000, 7000, 10500 and up to 16000 CFM. Priced from \$139.95* retail, including automatic ceiling shutter. Send the coupon for a reliable guide to better comfort cooling.

EASY TO INSTALL!

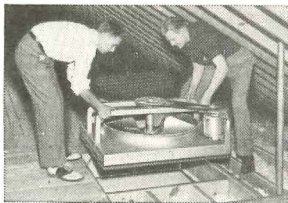

No other attic fan can be installed quicker or cheaper. It's a complete package—no extras needed. Fan simply fits over roughly framed opening. Complete automatic shutter unit fastens to ceiling opening frame; forms ceiling trim. R & M exhaust louvers are available to provide proper exhaust areas.



ROBBINS & MYERS

"Package" attic fans

*Prices subject to change without notice.

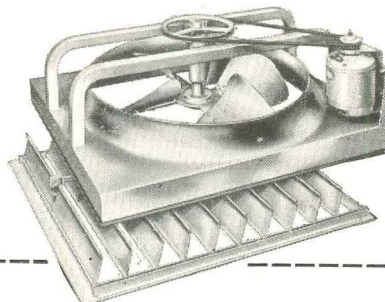

IT'S FREE!

Robbins & Myers, Inc.
Fan Division HH-53, 387 S. Front St., Memphis 2, Tenn.
Please send me your booklet, "Robbins & Myers Package Attic Fans, Belt-Driven Fans A.I.A. File No. 30-D-1."

Name.....
Address.....
City..... Zone..... State.....

site variation without putting the... to the front every time.

Zoning

Ludwig: In the average community no zoning, and no planning because the average builder is not interested. As our zoning committee, I have yet to hear a word from one architect, from one contractor, from anybody at all.

Hughes: Nobody has been interested in parks and playgrounds, things that help sell the lots. I provide backyard playgrounds for a young family with young children. I like them to cross the street to go to the park.

Prentice: Is the playground in the block paved or unpaved?

Hughes: It is not paved. We have swings and slides. It is a community of people who don't sell. I have not found any other way to properly finance it. I have to sell; I maintain it.

Selling

Smith: We give a lot of thought to the selling of our homes. We have sign boards and posting signs. We have a furnished model home with a sales attendant any time the door is open. The salesman knows everything about that house. It is very important for him to know the construction.

McKenna: First you have to know where your house is, through the neighborhood.

Spiegel: Salesmen have to point out the features that make yours a better home.

Manilow: I avoid having a sales attendant in a model house because if you crowd them, it just isn't humanly possible for one salesman to answer all their questions.

On the walls of each of our model homes we have the room sizes lettered, and they are very easy to read.

Where you have a disappearing salesman, as we do, with 200 sq. ft. of attic space, we have a card to describe it.

We are great believers in salesmen. We are in color, with visual details that make the features stand out.

Travers: We are using a technique called "talking house." We have the house wired, and each room is wired to a record that tells about the house. At the end, it says, "If you want to know more about this, go to the basement in the rear, and we will give you more information." A remarkably larger percentage of information.

contin

53 Window Models by Fenestra

NEW Fenestra "RAIN SHEDDING" PROJECTED WINDOWS

You don't have to run to shut your windows every time it rains—the projecting vents shed the rain outside, protecting your furnishings. And incoming drafts are deflected upward to protect your health and comfort. Fenestra* Metal Screens and Storm Sash go on quickly and easily from the safe, warm *inside* of the house and these beautiful, streamlined metal windows give your house a lower, spread-out appearance . . . emphasize the graceful, horizontal lines of your home.

They are available Super Hot-Dip Galvanized—never need painting!
Come complete with casings to save building costs.

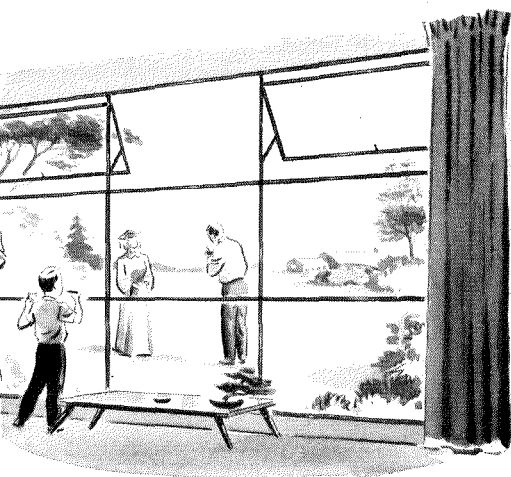
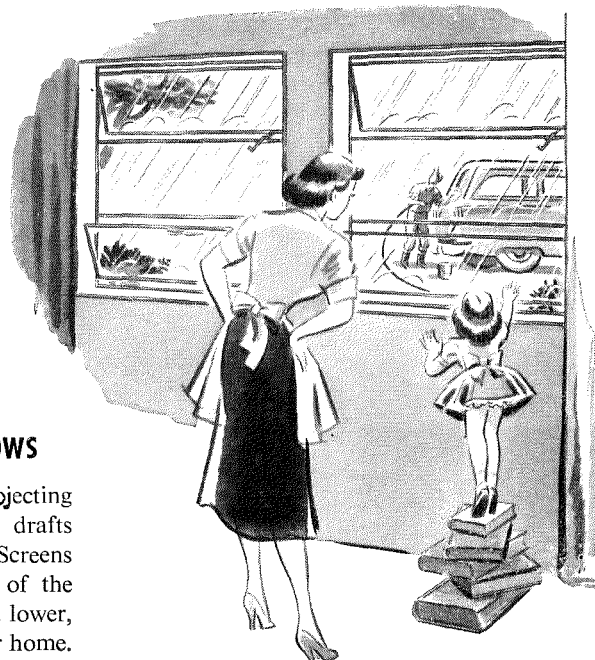

NEW Fenestra "BIG VIEW" WINDOWALL

Fenestra's new WindoWall† gives you extra view and more light because of its specially designed, slender steel frame. It adds the outdoors—makes your room feel bigger. It enhances the graceful lines and neatness of your home. The awning-type ventilators give you protected ventilation. Screens slip easily on from *inside* the house. And you can have ½" double-pane insulating glass in this exciting new window. Available Super Hot-Dip Galvanized for complete protection from rust.

Fenestra "EASY-OPENING" CASEMENT WINDOWS

Graceful, easy-operating Fenestra Metal Casement, Fenestra Casings, Metal *Inside* Screen, "tailored-fit" Fenestra *Inside* Storm Sash . . . all designed for each other. That's why they are so trouble-free. With a gentle twirl of the geared roto-adjuster, casement leaves swing out to catch the breeze and guide it in . . . where you *want* it. No tugging or lifting. These windows cannot swell or shrink or splinter. And you can wash them, screen them and put on the storm sash, all from the comfortable *inside* of your house. Available Super Hot-Dip Galvanized to eliminate your maintenance worries.



Fenestra RESIDENTIAL STEEL WINDOWS

• WINDOWS • HARDWARE • CASINGS • SCREENS • STORM SASH •

*® †a Trade-mark of D. S. P. Co.

ome is forever.
ember the famous Fenestra name when you
: buy.
es and sizes and further details on any of
enestra Windows, call your local Fenestra
ntative . . . he's listed in the yellow pages of
l city phone books. Or mail the coupon.

Detroit Steel Products Co.
Department HH-5
3401 Griffin St.
Detroit 11, Michigan

Please send me the free
literature checked, on
Fenestra Residential
Products:

- Projected Windows
 Casement Windows
 WindoWall Units

Name _____

Street _____

City _____

County _____

Zone _____

State _____

ORANGEBURG

PERFORATED

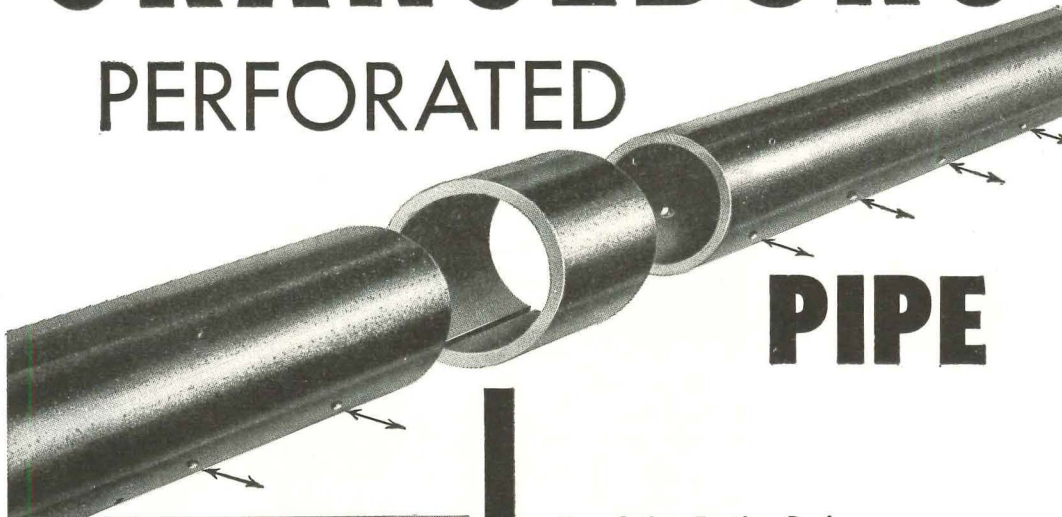

PIPE

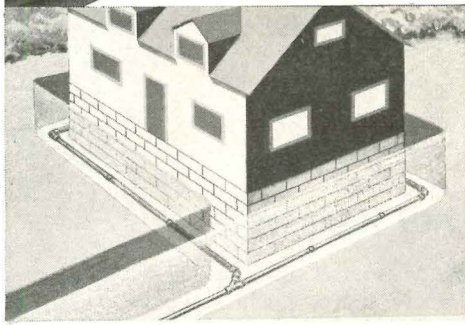

Foundation Footing Drains For Dry Cellars

Orangeburg Perforated Pipe—for foundation footing drains. A permanently dry cellar increases the value of the house and provides healthful basement area for many useful purposes. Long, light weight 8' lengths with snap couplings are easily installed around outside bottom of house foundation.

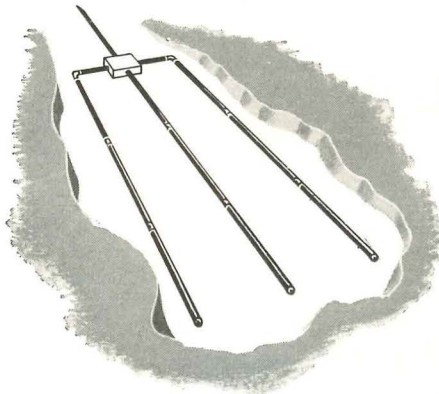

The Ideal Seepage Pipe For Septic Tank Disposal Beds

Orangeburg Perforated Pipe—for septic tank disposal fields. Long 8' lengths are easier to lay and establish grade. Two rows of 1/2" perforations on 4" centers permit seepage along entire line. Unique snap couplings assure maintenance of alignment . . . provide permanent joint cover . . . prevent entry of backfill . . . allow complete seepage through slot at bottom.

ORANGEBURG FITTINGS

for

1. Orangeburg Perforated Pipe
2. Orangeburg Root-Proof Sewer Pipe



1/4 BEND



1/8 BEND

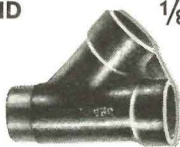

WYE

Draining Wet Spots of Lawns, Fields, Parking Lots, Airports, Golf Courses —and Draining Muckland

Orangeburg Perforated Pipe — maintains continuous seepage without clogging. Doesn't crack or corrode . . . withstands freezing and thawing . . . lasts indefinitely. New Orangeburg Fittings can be used with Orangeburg Perforated Pipe.

Use Orangeburg Root-Proof Sewer Pipe for House-Sewer or Septic Tank Connections

. . . or for conductor lines from Downspouts, Storm Drains. Orangeburg is America's most popular pipe for all non pressure outside uses—saves money—delivers trouble-free service.

Write Dept. HH-53 for data for your files.

ORANGEBURG

ESTABLISHED 1893

Manufacturing Co., Inc.

ORANGEBURG, NEW YORK

Excerpts from ROUND

Goodman: One simple selling movie, a little color film of the community with a story to go with in movie houses for five minute feature.

Travers: One of our competitors vision as a medium.

McKenna: If a house is furnished going to hold the prospect in times longer. The longer you better chance you have of selling.

Prentice: How small a developed furnished model pay off for?

Zuzak: I would say a minimum units.

May: We furnished four houses modern decorator, three by just orator with average furniture. vacant. The vacant one sold good one sold 65% of the house.

Hughes: The windows in my least 4' off the floor inside and windows are as high as 5'. If they get extra living space in cause they can locate furniture walls. We cannot yet sell our idea of a fixed window. I think come when most of the window except where you walk out from to the outdoor living room.

Spiegel: I find high bedroom a problem. Some housewives how to treat the windows. They to demonstrate. We have a decorative curtains.

Trade Secrets House

Gerholz: It is a house that gives people a feeling of space the terrace and into the yard like it. As far as regionalism and climate, it has debunked all time.

People like the window wall glaze. We have to do a little and so forth.

This is the first house in town chips on the roof. People like

I am thoroughly convinced that you a California house in Miami a terrific job with it.

Hughes: We will sell a lot of We will sell more models with windows this year than we will window walls.

Zuzak: We fortunately were a chief underwriter, the FHA, t

cont

PRODUCT NEWS from AMERICAN-Standard

A review of products in the news and important features worth remembering

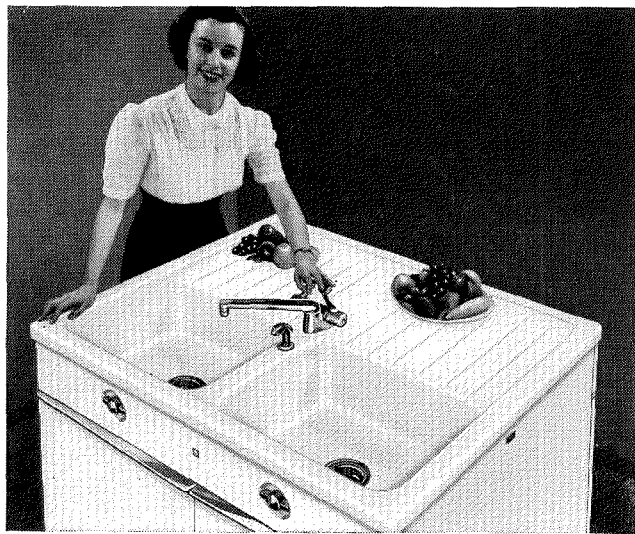

MIDWAY SINK. This new, island-type sink-and-cabinet combination saves steps and time. The 44" x 37½" unit has two deep sink bowls and spacious drainboard. Exclusive new fitting permits one-hand operation. Steel cabinet opens both front and back . . . has electrical outlets on both sides.

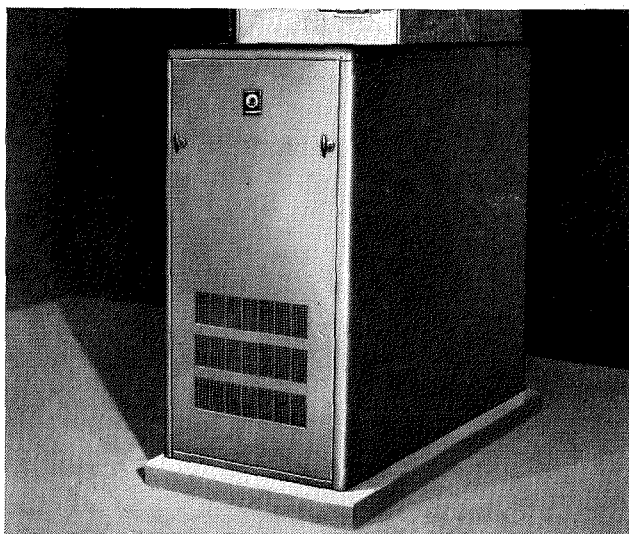

WINTERWAY WINTER AIR CONDITIONER. Available in three sizes to meet a wide range of heating requirements, this oil fired, basement type unit provides automatic, trouble-free heating. Long life and efficient use of fuel make it a real economy unit. It is compact, easy-to-install, easily converted to gas with no change in capacity.

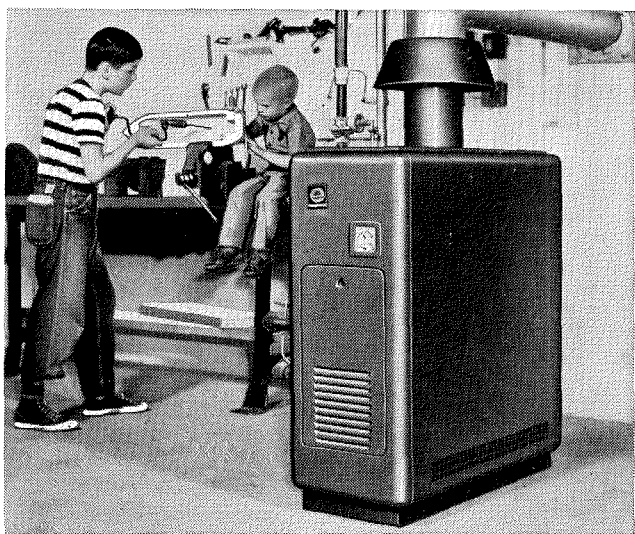

EMPIRE GAS BOILER. A compact, good-looking and efficient boiler that's available in models for hot water or steam, for basement or first floor installations. Burns any type of gas. Features include pintype cast iron sections which absorb maximum heat . . . precision controls to guard safety and fuel consumption . . . heavy insulation to prevent heat loss . . . colorful, streamlined jacket.

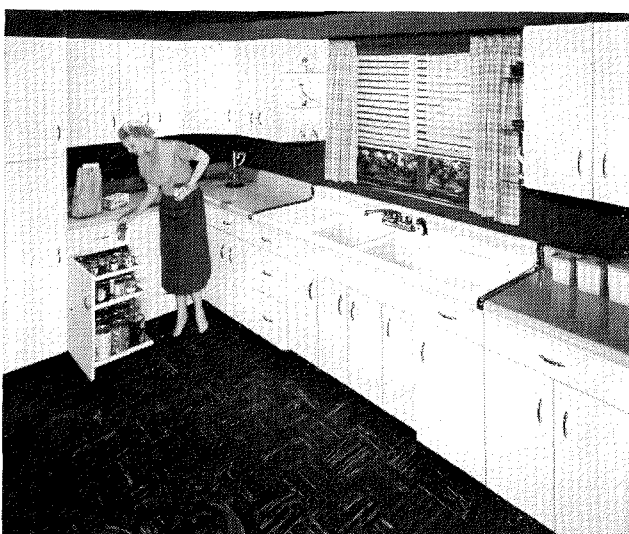

CONVERTIBLE KITCHEN CABINETS. American-Standard all-steel cabinets are the *only* kitchen cabinets with interchangeable drawers and shelves. You can install an economical package kitchen in the homes you build. By adding extra shelves and drawers to the cabinets at any time, buyers can create deluxe kitchens to fit their particular needs.



American-Standard
Dept. HH-53, Pittsburgh 30, Pa.

Without obligation on my part, please send me your free literature on:

<input type="checkbox"/> Midway Sink	<input type="checkbox"/> Winterway Winter Air Conditioner
<input type="checkbox"/> Empire Gas Boiler	<input type="checkbox"/> Kitchen Cabinets

Name.....

Address.....

City.....State.....

American Radiator & Standard Sanitary Corporation, Dept. HH-53, Pittsburgh 30, Pa.

Serving home and industry

"...Marlite bathrooms are the talk of the town"

W. P. "Bill" ATKINSON
Past President of NAHB

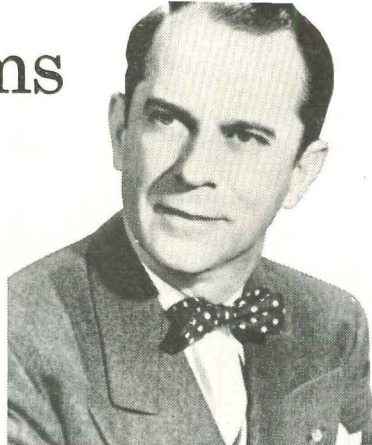

Wainscot and tub area are Rose De Brignoles Marble Panel. Wall at right (not shown) is Natural Walnut Marlite Woodpanel.

This beautiful bathroom has a four foot wainscot of Verdi Antique Marlite Marble Panel for permanence and easy cleanability.

Beautiful Country Estate Homes in Midwest City, Oklahoma, sell faster with modern divided bathrooms of Marlite prefinished wallpanels. W. P. Atkinson, builder of these popular homes, is one of the originators of the famous "trades secrets" house. He states:

"We have chosen Marlite for our smartly designed homes because of its beauty, economy, and easy-to-clean qualities.

"Three of our model homes featuring Marlite in the bathrooms have been open to the public for the past sixty days, and you will be glad to know that our bathrooms are the talk of the town."

Use Marlite in *your* new homes, too. Its beauty, economy, low-maintenance, and wide range of "decorator correct" colors and patterns will attract and please customers. See your building materials dealer, or refer to Sweet's Architectural and Builders Files, MARSH WALL PRODUCTS, INC. Dept. 522, Dover, Ohio. Subsidiary of Masonite Corporation.

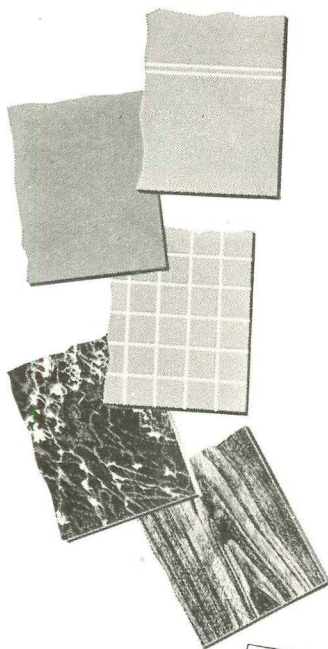

for creating
beautiful
interiors



in the house. Afterward we said: completely different home than we built or submitted for Shreveport want it, take it as it is without any marks." I think it is the first plan back from the FHA without one mark on it.

He was impressed by the favors from most of the people, especially on the terrazzo floor, storage walls. People liked the effect particularly, and the fre arrangement between the living and dining room.

Haeger: The interesting thing to the Trade Secrets house is that adequate, well-planned space; adequate; indoor-outdoor living; and the increment or equivalent.

Color

Lemperly: We started to make a survey of the builders' opinion on color. Up to 90 per cent of replies say that color, exterior and interior, is a positive factor in a home.

Over one-half of the builders thought that color would be more important as a selling factor in the days ahead than it has been to date.

Dayton: We have so many similar homes on Long Island, if you don't use color, you won't know where he lives. It is

Satterlee: I think color is an integral part of the design of the whole development. The architect should be the one to choose the color, or an expert who understands the architect's approach on designing the development.

Yost: I think it should be emphasized that color should be considered from the beginning. Too often color is pulled in after the fact, or the development has been completed, and in order to get the color pattern of the structural pattern of the house superseded by color pattern, an effect falls down.

Rehousing

Theobald: Moving into a program to build a million houses, the problem in the industry is that people dissatisfied and to dig out prospects who will move from one house to a better one. That calls for a major program. We are entering a period of hard calls for more than just show houses. One logical prospect is that if you bought a two-bedroom house four years ago. Go out and make him dissatisfied with that house and get him to transfer to a new house with three bedrooms.

Electronic Room Thermostat

Mounted indoors, it receives signals from the Weathercaster, adjusts its control point and maintains temperatures required to compensate for outside temperature conditions.

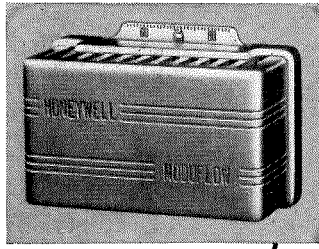

Electronic Relay Amplifier

Interprets signals from electronic room thermostat and controls the heating plant accordingly.

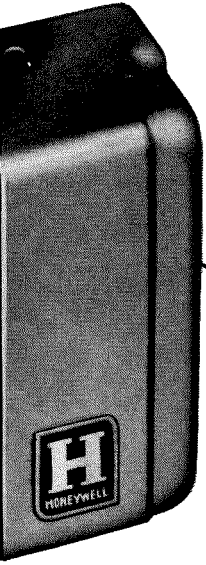
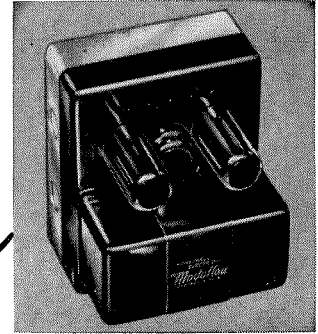

Weathercaster
 outdoors, it senses temperature—electronic—sends signals to indoor thermostat.

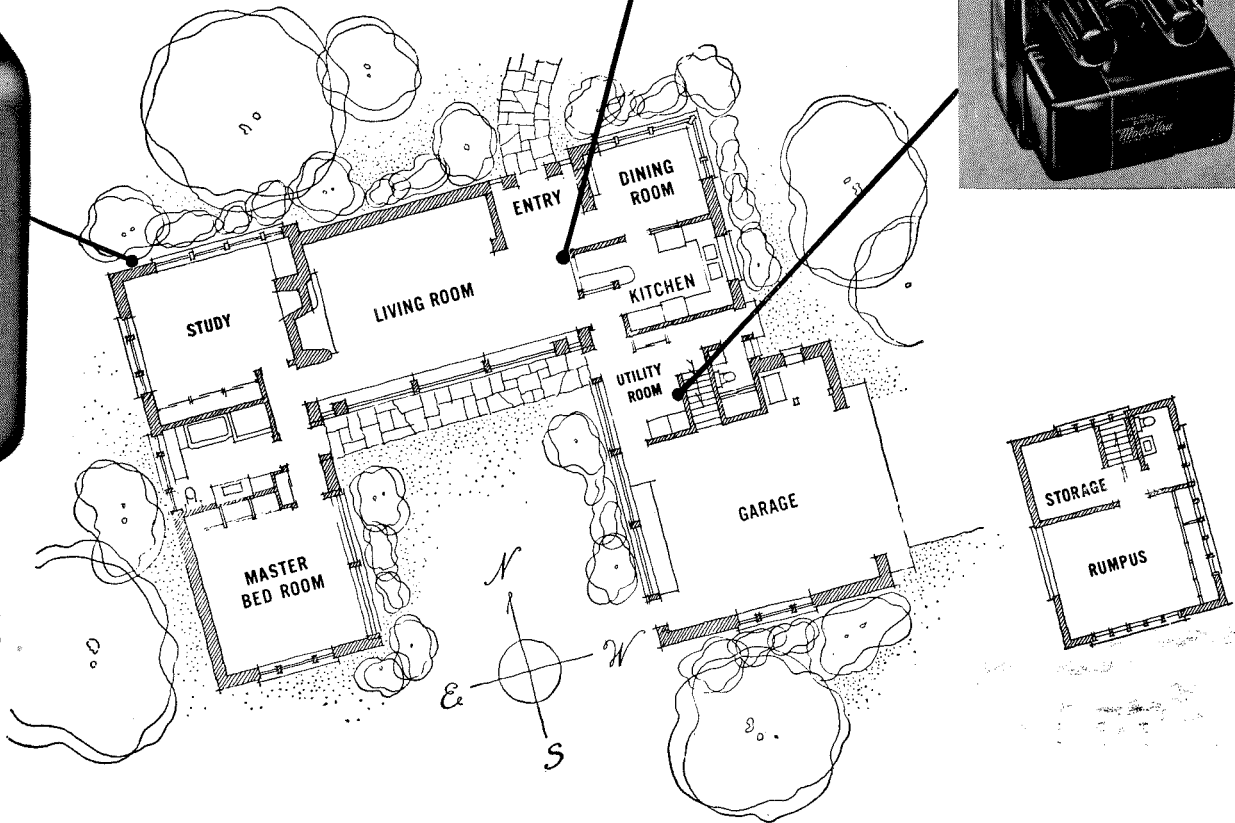

Magic of Electronic Moduflow heating control makes your homes easy to sell

In addition to being comfort conscious, every prospect is intrigued when you mention that magic word "Electronics."

When you show a house, explain Electronic Moduflow and the reasons why it means more comfort. Your prospect will be more interested in the house and you'll be closer to a sale.

Simply explain that because the controls are electronic, they're many times more accurate and sensitive

than ordinary controls. That in the new Honeywell Moduflow system, outdoor and indoor thermostats work together to give comfort that's close to ideal—by raising indoor temperature to compensate for heat loss when outdoor temperature drops—by balancing indoor temperature with the weather.

And explain how Electronic Moduflow provides virtually constant air circulation and helps eliminate hot ceilings and cold, drafty floors.

See your local Honeywell office—or send for more information

MINNEAPOLIS
Honeywell



First in Controls

.....
 MINNEAPOLIS-HONEYWELL REGULATOR CO.

Dept. HH-5-93, Minneapolis 8, Minnesota

Gentlemen:

Please send me more facts on your new Electronic Moduflow System for homes.

Name.....

Firm Name.....

Address.....

City.....Zone.....State.....

FIVE-YEAR WRITTEN GUARANTEE

furnished with each unit

No other
STAIRWAY
offers so much

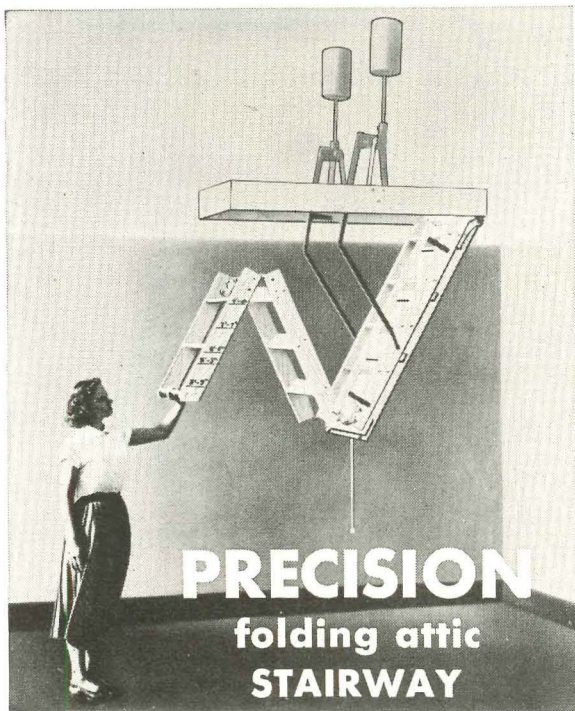

PRECISION
folding attic
STAIRWAY

5 exclusive features

1. Actuated by counterweights.
2. Operates on roller bearing which makes raising and lowering practically effortless.
3. Insulated door pannel to prevent loss of heat to attic.
4. Full width safety treads.
5. Finest grade lumber and aluminum alloy construction. All parts secured by bolts and screws.

Easy to handle -- Easy to install. Shipped in 1 package assembled. Requires no attic space. No adjustments, no springs. Fits all ceilings from 7 feet to 9 feet 9 inches. (Runners graduated, all you do is measure from finished floor to finished ceiling and saw off runners at desired height.) Accepted by F.H.A. Listed in Sweets. Specified by leading architects. Sold by more than 12,000 dealers in U. S. A. and Canada.

Contact Precision Jobber for attractive prices.

PRECISION PARTS CORPORATION
400 North 1st St. Nashville 7, Tennessee

IS ROOF LEAKING DOLLARS?

In an effort to answer this vital question, an HHFA project is sponsoring a New York University test. The demonstrate techniques for low-cost construction and to how much time and material they can save without a coring reduction in quality.

A builder of small houses permitted the University to redesign he was building and agreed to build one house the "old way" and redesigned. The new design, a truss roof, showed a saving of 34%

Conventional roof

After the exterior walls and center load-bearing wall were in place were plumbed and braced. Two-by-six ceiling joists 16" o.c. were laid across the span from exterior wall to load-bearing wall. While they were being placed and nailed, a cutting table was set up on top of 2 x 6 rafters were laid out and cut with an electric hand saw.

After cutting, the rafters were stood up against the walls of the house. A 2 x 8 ridge board was secured with rafters at each end, then the intermediate rafters were pulled up and nailed in place—16" o.c.

The hip, valley and jack rafters at the roof intersection were individually measured and cut to size.

The over-all time consumed was 62 man-hours and the crew consisted of from two to four carpenters as required.

COMPARISON OF LABOR FOR ROOF

The Builder's Control House (Conventional construction)

Cutting rafters and joists
Erection of ridge and rafters
Fitting and cutting rafters
... at roof intersections

62 man hrs. @ \$3.00 = \$186.00

Demonstration House (Nailed wood trusses)

Layout of jigs
Cutting of truss members
Nailing trusses
Erection of trusses
Saddle framing

44 hrs. @ \$3.00 = \$132.00

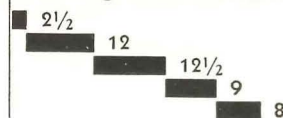

COMPARISON OF MATERIALS FOR ROOF

Control house 2,700 board feet
@ \$123.00 per M \$332.00
Demonstration house . 1,540 board feet
@ \$123.00 per M \$190.00



Truss construction

An outline was laid out with a chalk line on an adjacent concrete slab. Scrap wood blocks were nailed along the lines with hardened nails. While the jigs were being made, a cutting section was cut out of another section of the slab. The truss members were cut to size according to a prepared cutting list, which kept waste to a minimum. As each truss member was made and used to lay out lumber which was cut with an electric handsaw.

The cut members were stacked around the jigs, the carpenter placed them in the jig in the proper order and nailed them together. Finally, completed trusses were stacked.

Average elapsed time for two carpenters to complete this work was 141 1/2 to 161 1/2 min. per truss. Trusses were then carried into the house in inverted positions across the two walls, lifted upright and nailed in place. Saddle framing took eight man-hours; erection of trusses, 36 man-hours. Over-all time to frame the roof: 44 man-hours (two carpenters all the work).

* Housing Research No. 5, Mar. '53. For sale by the Superintendent of US Government Printing Office, Washington 25, D. C., 40¢.

MAND QUALITY PLUMBING FIXTURES

this check list to insure your customer's satisfaction

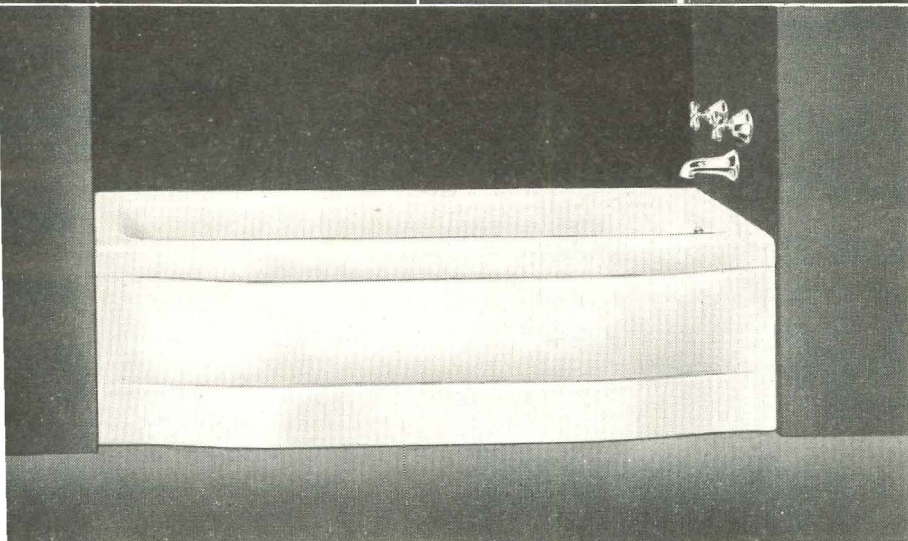

ONLY BRIGGS BEAUTYWARE OFFERS ALL THE IMPORTANT FEATURES LISTED IN THE COLUMN AT RIGHT—AS WELL AS MANY OTHER POWERFUL SALES FEATURES!

BRIGGS
Beautyware

BRIGGS MANUFACTURING COMPANY
3001 Miller Ave., Detroit 11, Mich.

INTERNATIONAL SHOWROOM
101 Park Avenue, New York City

© 1953

See our new 28-page catalog in Sweet's
Architectural and Light Construction Files

- Acid-resistant quality at no extra cost.
- Patented Safety Bottom bathtub, reducing accident hazard.
- Unnecessary dead weight eliminated from tub.
- Tiling-in flange—leak-proof seal, tub to wall.
- Under-tub framework—firmly positions tub, independent of wall support.
- Precision brass fittings engineered for minimum installation cost and long life.
- Quick opening valves on lavatory fittings.
- Lavatories with tarnish-proof chromium plated legs and towel bars.
- Deeper lavatory bowls for greater water capacity.
- Uniform tub dimensions, insuring exact fit.
- Vertical front panel edges on tub, eliminating need for cutting and fitting wall tile.
- Water closets with anti-syphon ball cock of proved quality.
- Twin concealed front overflows and anti-splash rim on vitreous china lavatories.
- Integral soap dish on lavatory.
- Quiet-flush, positive action water closets.
- Elongated syphon-jet closet bowl for greater hygiene.
- Four non-fading pastel colors at prices only slightly higher than white.
- Attractive contours, smart styling, functional design for durable service.

***Insist on all these—
they mean highest
quality!***

get FAST, RESPONSIVE HOT WATER HEAT for

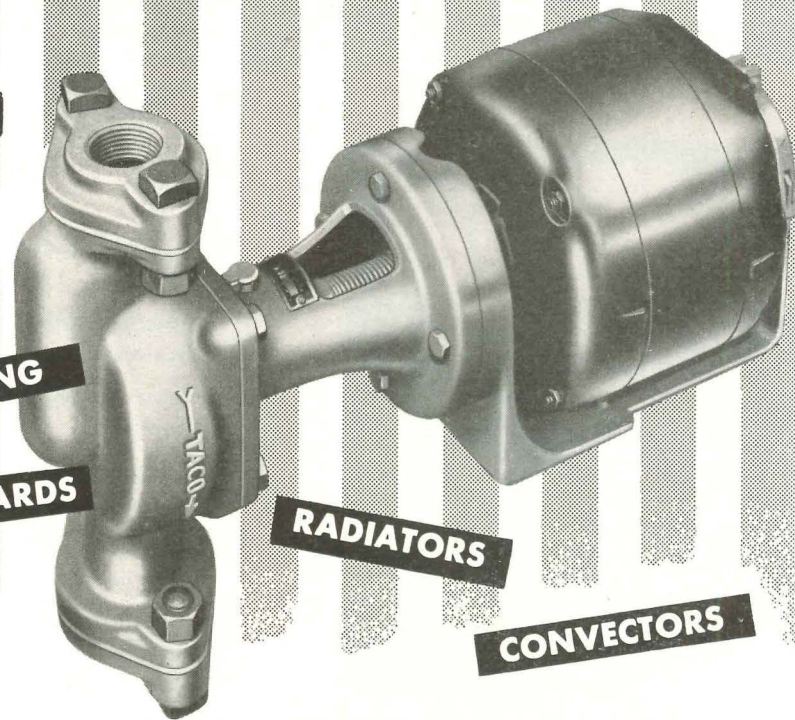

PANEL HEATING
BASEBOARDS
RADIATORS
CONVECTORS

with this popular TACO CIRCULATOR

EVEN LOW BUDGET HOMES CAN NOW HAVE THESE LUXURY ADVANTAGES

RADIANT WARMTH • DRAFTLESS WARMTH • CONTROLLED WARMTH

MORE HOT WATER FOR KITCHEN, BATH AND LAUNDRY

Yes, forced hot water heat with a TACO circulator gives all this *plus* economical warmth. No need for a separately fired water heater. TACO TANKLESS, hooked up to a heating boiler, supplies year 'round low cost hot water.

The TACO circulator delivers heat where it will give the greatest comfort . . . whether you use radiant panels, convectors, radiators or baseboards.



**ARCHITECTS—ENGINEERS
WRITE FOR . . . SIMPLIFIED
SELECTION CHART FOR SIZ-
ING TACO WATER HEATERS
UNDER ANY CONDITIONS.**

Three other famous TACO PRODUCTS for houses



TACO-VENT
eliminates air
from hot water
radiation
automatically

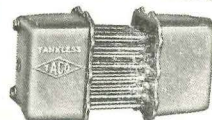

TANKLESS TACO
gives an abundant sup-
ply of hot water instantly.
No need for storage tank.



TACO TEMPERING VALVE
thermostatically
mixes hot
water with
cold so there's
no danger of
its being too hot.

**Better Heating-
Better with Taco**



TACO HEATERS, INCORPORATED • 137 SOUTH STREET • PROVIDENCE 3, R. I.

**FRANK LLOYD WRIGHT TALKS TO
THE TALIESIN FELLOWSHIP.** Three 10
(33 1/3 RPM) microgroove records
pressed but not recorded by Columbia
Inc. Copyright by the Frank Lloyd W
lowship. Price, \$5 per record.

Several years ago Frank Lloyd W
livered a memorable address before
vention of the American Institute
tects in Houston, accepting the
Medal. Luckily his words—probably
stirring statement ever made by
tect—were preserved on a disc wh
livered them, and astute national
cials later performed a real servic
ing his speech available in record f
then, 160 sets of these records hav
dered from the AIA, and the dema
than slacking, seems to be steady.

This is another neat accolade t
who is more than merely an inspir
chitect, but has become the centra
esthetic defiance of our age, a cons
only for his own profession, but fo
artists as well, and for all others t
ualist. That Wright's long, stubb
ful, principled struggle has been
is a reassuring truth in a dogmatic

Now here is a new set of three lo
records of Wright in a more rela
On them he talks about acoustics,
ments from Walt Whitman, disc
Man or Machine, and repeats his
the Junior AIA meeting at the
AIA convention in June, 1952. T
of these records does not equal th
cent address at Houston. Techn
have quite a few background
klumps and birdies. They are not
ciently, and do not follow their la
cisely—at one point the listener i
Frank Lloyd Wright improvising o
but no piano is heard.

But they may some day be prec
same, because they do this: They
intimacy with the fact of Wright
ity, which is as vivid as his gre
ture. In these records he is somet
—as in the sides which eavesdrop
with fellows of his Taliesin fellow
man and the machine; at other
humorous—as when he advises y
tects to do the whole job of build
designing, contracting, landscapin
rior decorating, because then th
be 40%; at times sharply critical
passage on education: “. . . Tea
seldom gets down to the element
the truth. . . . That is because
were taught facts, which is what
instead of truth. . . . And as you
know now, architecture, modern
especially, is still chiefly concer
fect. Effects are charming, or the
they're desperate, or despicable

continu

REYNOLDS Lifetime ALUMINUM GUTTERS AND DOWNSPOUTS

Beauty and rustproof permanence at the lowest cost of any rustproof material. Slip-joint application saves labor. Available in Ogee and Half-Round 5" Residential Gutters, smooth or stipple-embossed finish—also 6" Industrial Half-Round—with downspouts and fittings to match.

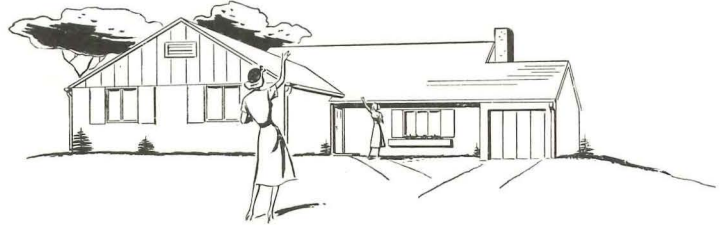
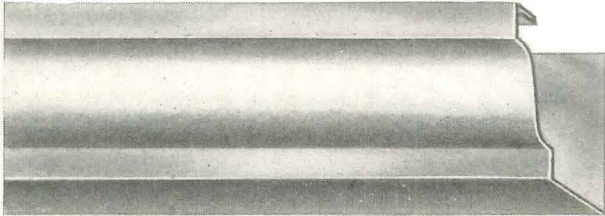
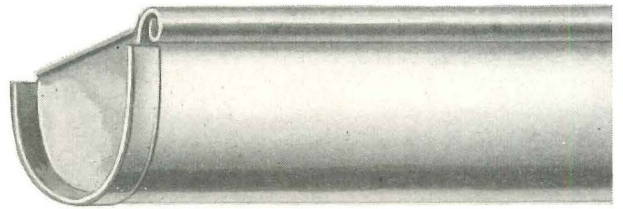

REYNOLDS Lifetime ALUMINUM FLASHING . . . AND NAILS.

Easiest flashing to work with, best looking, and lowest in cost of any rustproof material! In 50' rolls of 14", 20" and 28" widths; flat sheets 28" by 6', 8', 10', 12'; also cartons of 18" x 48" sheets. Remember, aluminum nails are a *must* with aluminum, best for all exposed nailing. Specify rustproof, non-staining Reynolds Lifetime Aluminum Nails.

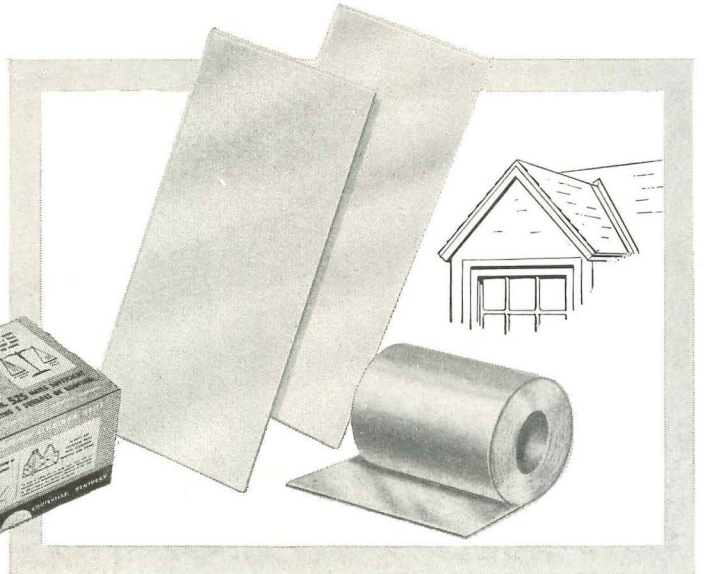

REYNOLDS ALUMINUM REFLECTIVE INSULATION

This embossed aluminum foil on kraft paper provides highly efficient insulation, plus perfect vapor barrier, at much lower cost than most bulk insulation. Cleaner to handle, quicker to apply. Double-faced (Type B) and single-faced (Type C), in rolls of 250 square feet, 25", 33" and 36" wide.

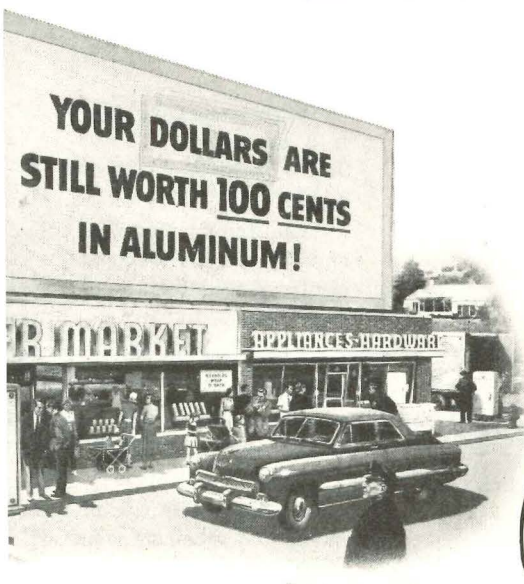
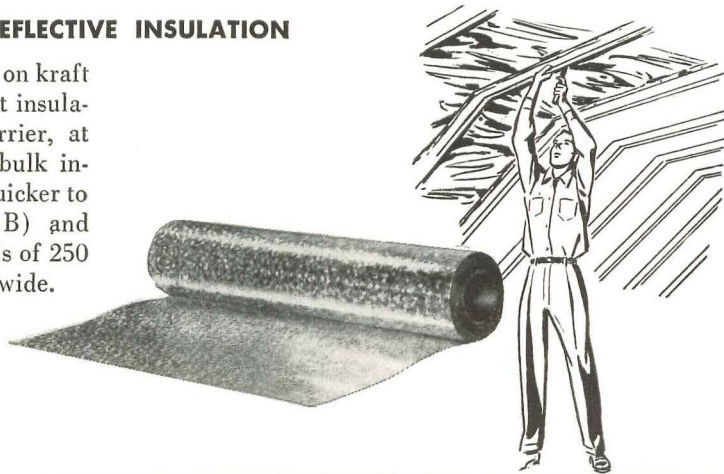

**REYNOLDS
ALUMINUM**

Yes, We GUARANTEE

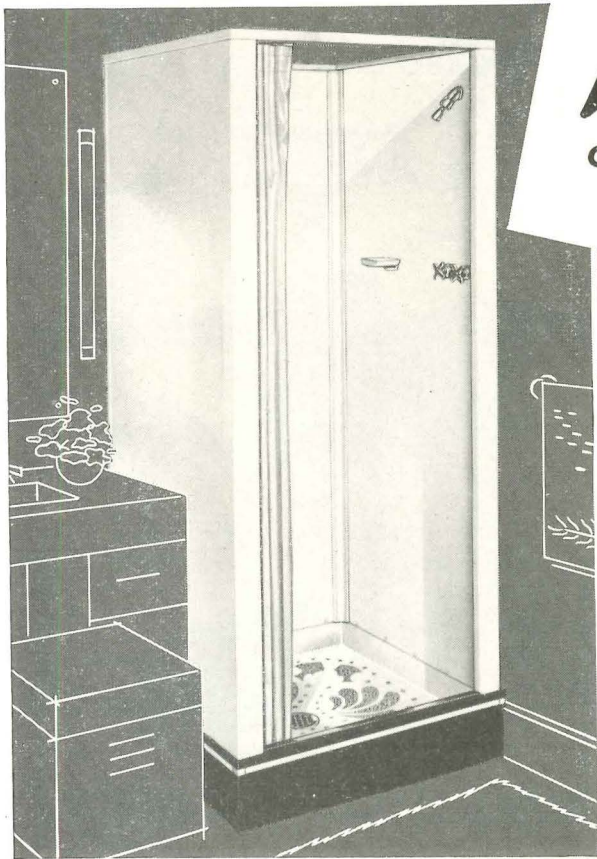

You're safe in installing Weisways in any home you build, regardless of price class. *Weisways are guaranteed leakproof.* Their engineered design, service-tested materials and precision manufacture assure long years of satisfactory service.

Receptor formed in one piece of heavy enameling iron, with glass-hard vitreous porcelain surface inside and out. Walls are galvanized, Bonderized heavy gauge steel with two separately baked-on coats of enamel. Corners sealed in compression-tight joints.

... Seldom is the endeavor of our time concerned with principles, w... Young artists aren't taught t... You can ask what, and when a... where, but never why. That can... education."

But more than anything else W... onantly noble, as in his final word... an afterthought after he has alrea... the talks to a conclusion and said:

"One thing more. Consider th... young architects are to be the pa... to American civilization. There c... other pattern-givers than our arch... we in America ever do have a cul... own you must be the way-showers... tion is only a way of life. A c... way of making that civilization h... that way of life a beautiful way... culture is your office here in Ame... no stream can rise higher than its... you can *give* no better to arch'it... you *are*. So why not go to work o... to make yourselves be in quality... would have your buildings be? . . .

**HOME BUILDERS MANUAL FOR LAND...
MENT.** Published by the National A...
Home Builders, 1028 Connecticut A...
ington D.C. 274 pp. 6" x 9". \$3

Written and produced by the Lan...
Committee under the chairmanshi...
Balch, editors of this revised editio...
first printed in 1950 are Max S. W...
Ross McKeever, assisted by Jean...

This is an important book for bu...
or small. It gets down to cases...
Striking a sound balance betwee...
vidual builder's own interests and...
the community, the editors demo...
and over that sound use of land...
economically advantageous. For...
curvilinear plan for a developme...
different types of savings over a g...
Examples: street length, san...
length, number of manholes and...
etc.

An interesting addition in this...
is a chapter on "Appraisal of...
Street Widths." A table of desi...
advocates 50' width for single fan...
for multifamily units; minimum...
and 3'-7' setbacks depending on w...
are trees. Says the *Manual*: The...
which still insists on excessive w...
streets and roadways is overlo...
important economic aspects:

1. The additional cost of initial...
to the city or developer (in eith...
the home owner who pays).
2. The continuing cost of mainte...
facing and repairing from 38%...
roadway surface than is needed.
3. The inescapable economic as...
taxes—which must be added to

contin

Extra Baths Add Sales Appeal

Space-saving Weisways enable complete extra bathrooms in minimum floor area. More bathrooms and better shower bathing facilities add powerful sales appeal. Weisways are easily, quickly installed. Independent of building walls and floor—not affected by settling or shrinkage. One man easily handles and places receptor—no metal underpans required.

WEISWAY VITRECEPTOR FOR WALLS OTHER THAN METAL

Vitreous porcelain enamel inside and out, over heavy gauge enameling iron, formed in one piece. Has integral flashing to make leakproof joint with shower walls other than metal. Foot-Grip, No-Slip floor safe, positively non-absorbent. Sanitary, practically self-cleaning.



Here one Weisway gives practical effect of two bathrooms.

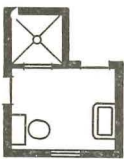

Irregular floor areas can be used for complete bathrooms.



Corner entrance Weisways provide complete baths in small space.

Mail Coupon

for catalog showing models for all price classes and five colors available.

HENRY WEIS MFG. CO., INC., 542 Weisway Bldg., Elkhart, Ind.

Please send catalog on Weisway Cabinet Showers.

Name _____

Street _____

City _____ State _____

**Look at these G-E appliances
designed and priced especially
for builders!**

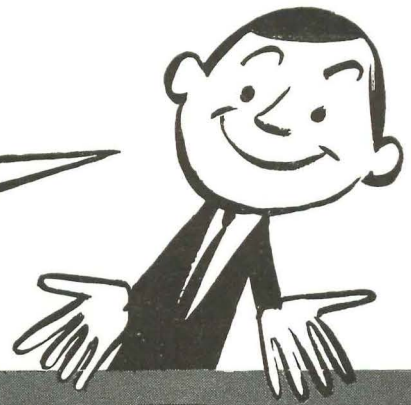

Model UCB 120. Here's the G-E Sink built for you . . . and at a low price you can't believe. The G-E Electric Sink is *pre-designed in standard sink width*. It's more to install a G-E Electric Sink in a regular sink.

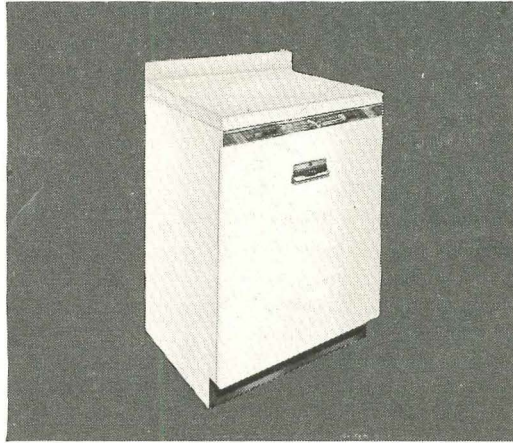

Model UCB 120. Here's the G-E Automatic Dishwasher so many women prefer. It installs in minutes! And it's designed to satisfy the strictest plumbing codes. Cost-conscious builders know this G-E Dishwasher to be a really powerful sales-maker!

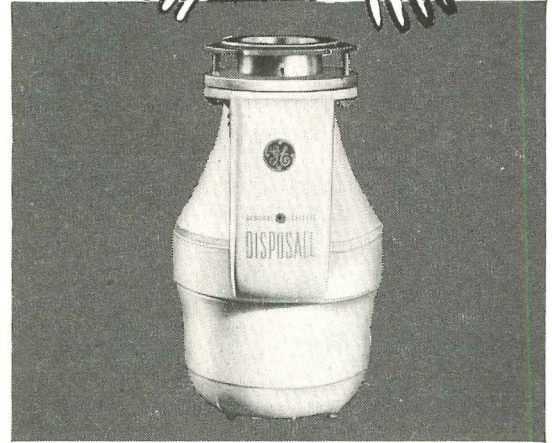

Model FA 4. The G-E Disposall is backed by a written 5-year protection plan. A G-E Disposall installs in the sink drain line easily. And G-E Disposalls operate efficiently with septic tanks as well as sewers. Over 100,000 are in operation *right now!*

WHY GENERAL ELECTRIC?

Because you'll find the G-E Electric Sink priced especially for you! Make a date to see your General Electric distributor. He'll sharpen his pencil to help you keep your costs *down* . . . your profits *up* with a G-E Electric Sink!



Because General Electric means *dependability!* Who but General Electric could offer a written 5-year protection plan carried by the G-E Disposall? There's proof of G-E dependability. The kind of proof prospective home buyers like to have.

Because General Electric is the name most people want most! In a recent survey we found 53 out of every 100 people interviewed believed the best home appliances were made by General Electric. On this basis, 1 out of 2 of *your* house-hunters is already pre-sold on G.E.!



Because General Electric means bigger, faster home sales for you! See your nearest G-E major appliance distributor. He can help you change more signs from "For Sale" to "SOLD"!

You can put your confidence in —

GENERAL  **ELECTRIC**

More and More of America's New Homes are PREFABRICATED!

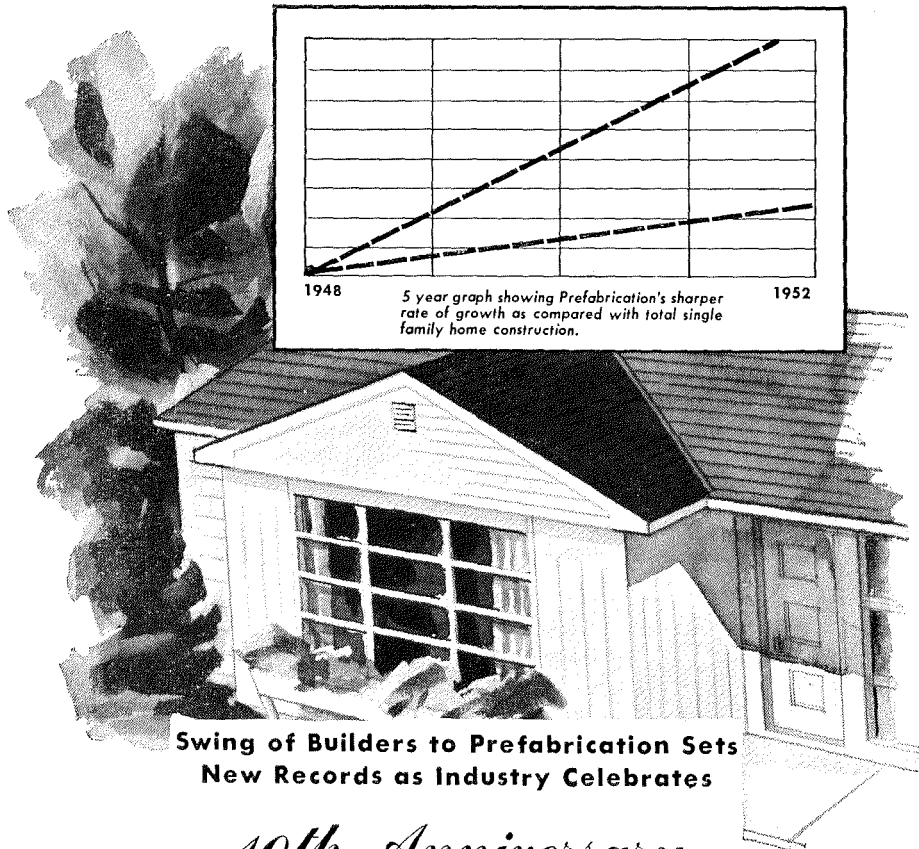

Swing of Builders to Prefabrication Sets
New Records as Industry Celebrates

10th Anniversary

Responsible for the spectacular gains of Prefabrication is the fact that Prefabrication delivers the *utmost* for the building dollar. New sales records continue to be set in the Prefabricated field because Prefabrication provides permanent, attractive homes geared to comfortable living and meets housing needs quickly and economically. Furthermore, Prefabrication's modern methods result in greater savings, from economy model to luxury home. In 1953, as it celebrates its 10th Anniversary, the Prefabrication Industry is ready for its greatest year. Join this big swing to Prefabrication.

Today, write for FREE booklet, "Build Better, Build Sooner."



**PREFABRICATED HOME
MANUFACTURERS' INSTITUTE**

932 20th St. N.W.

Washington, 6, D.C.

REVIEWS

To assist builders who are faced with the problem of narrow born municipalities, the second edition of *Traffic Engineering Handbook* is recommended.

In a new chapter on "Waste Removal," the costs of "arbitrary and excessive Street and Utility Repairs" is spelled out. Specific mention is made of the cost of cast-iron water main fittings when asbestos concrete pipe is used. Concrete paving on minor residential streets where narrower macadam paving is required for 6' walks where 4' are sufficient; and the use of concrete backs and short blocks.

Attacking the problem of lot coverage, the *Manual* says: "Many modern homes call for large windows in the side yard. This would be highly desirable if the lot is wide enough on a spacious side lawn area. On narrow lots, this feature is not so desirable. If windows are eliminated, the side yards serve no useful purpose. In some group houses might just as well be eliminated. Where garages are not used, an open side yard of 15' in width should be provided on the service side of the house. On the other side yard may be as narrow as 10'. On a story-and-a-half house, although the side yard is inadequate for mounting ladders, it is useful for other purposes. . . ."

Charts, plans and photos supplement the text, which is clearly presented and well organized.

OTHER BOOKS RECEIVED

NATCHEZ. By Nola Nance Oliver. House Publishers, Inc., 41 E. 50th St., New York 22, N. Y. 72 pp. 6 1/4" x 8 3/4". \$2.50.

A picture-and-textbook of houses and interiors not included in *Spring Pilgrimage* and therefore not well known.

LONDON HOMES. By Ralph Dutton. George G. Harrington & Co., 12 Beauchamp Place, London. 132 pp. 5-3/4" x 8-3/4". \$2.50.

Beginning before the Great Fire, this engaging study of London's architecture is liberally illustrated with drawings and engravings. Although the cover is contemporary architectural, it provides an excellent background.

ANTIQUES AT WILLIAMSBURG. By the Editors of Antiques Magazine. Hastings House Publishers, Inc., 41 E. 50th St., New York 22, N. Y. 68 pp. 9 3/4" x 12 1/2". \$4.00.

Photographs and comments on the ruins of Colonial Williamsburg by now be more than familiar to many.

"Build real city water service
into your homes even
'way out of town!"



Guarantee capacity with a DELCO WATER SYSTEM

Give your homes a real sales plus with all the convenience and luxury of dependable running water under pressure. A General Motors backed Delco Water System is the best assurance in the world of plenty of water to fill every need . . . for automatic laundries, baths and showers, watering lawns, everything that means better, more healthful living. Every Delco pump is test rated to deliver every gallon promised and more, now and years from now. Easy to install, easy to service, built for continuous peak performance year after year.

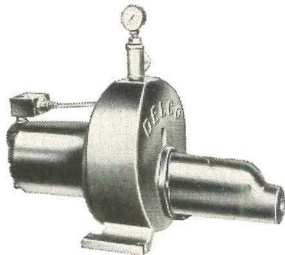

This convertible jet pump is super-simple, super-powerful. Converts quickly and easily to deep well operation if water table falls. For complete information about all pumps, contact your Delco Dealer. Or write: Delco Appliance Division of General Motors, Dept. HAH, Rochester 1, N. Y.



For a good deal
DEAL WITH DELCO

Place Homes

assure **positive profits** from conventional construction for all builders!



**5 FLOOR PLANS
17 ELEVATIONS**

More and more builders are turning to Place Homes for *positive profits* with lower overhead . . . lower inventories . . . lower investments. Designed by top architects, Place Homes are planned for contemporary living and modest budgets. Such features as Thermopane Windows throughout, Kitchen Maid Kitchens and Radair Heating plus a selection of two, three and four bedroom plans assure you of distinctive *homes that sell*.

Place Homes are shipped factory-cut with some vital pre-assembly to permit fast on-site construction by proved project methods.

Start saving through Place Homes' volume buying . . . factory-cutting . . . and labor specialization. Start taking advantage of Place Homes' complete program that includes sales and financial assistance. Thousands of homes already built and sold are proof of this fool-proof plan! Send coupon today for full details!

Place Homes is prepared to give you prompt efficient service throughout Michigan, Ohio, Illinois, Wisconsin, Iowa, Kentucky and Indiana. Place Homes, Inc. 1214 S. Walnut, South Bend, Ind.

Place Homes, Inc., 1214 S. Walnut St., South Bend, Indiana
Rush full details on your positive Profit Plan for conventionally built Place Homes.

Name _____

Address _____

GET THE FACTS on the Amazing *Fleettlite* Aluminum WINDOWS



*Beautifully Modern
Reduces Building Time
Comes Packaged in Carton*

Offers **NEW LIVING COMFORT
EASY HOUSEKEEPING**

● Here's the revolutionary new window you've been hearing so much about... the window that builders are applauding... the window home owners are specifying — FLEETLITE Aluminum Windows. They come, packaged and ready for installation, these complete year-round units combine interior and exterior double hung windows in a four-channel extruded aluminum frame. Keep homes warmer in winter and cooler in summer.

When you build—plan for the future, insist on FLEETLITE Windows for the home owners comfort—for the added sales advantage—for protection of resale value. It costs no more to have the best.

FLEETLITE Windows are the most handsome, most practical windows in America. Get the facts for yourself — today.

WRITE TODAY for complete literature on

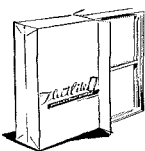

MADE BY...

FLEETLITE Windows
TERRITORIES OPEN
FOR FULL TIME
FACTORY REPRESENTATIVES

Fleettlite
AMERICA'S Finest WINDOW

As advertised in *House Beautiful*, *House and Garden*, *Small Homes Guide*, *American Builder*, *Practical Builder* and *Magazine of Building*.

FLEET OF AMERICA, INC., 102 Pearl Street, Buffalo 2, New York

FLEETLITE double hung windows on each side of FLEETLITE matching picture window.



Double windows weather stripped with pile mohair give most complete protection against winter cold, summer heat or dust storms.



Block rain, adjust air flow for inside pleasure by centering the two middle sash.



Sash easily and quickly removed for washing.

NEW PRODUCTS *continued*

finished wall without replastering: its square grille face will gloss over any rough edges around the hole cut for the fan housing. In operation, when the fan is switched on, the weathertight outside door opens automatically, and when turned off a counterbalanced spring snaps it shut. Tagged *Model 1082*, the new unit is made in 8" and 10" sizes selling for \$28.70 and \$33.95.

Manufacturer: Fasco Industries, Inc., Rochester, N. Y.

SHOWER CABINET comes wearing modest price tag and heavy plastic curtain

A stall shower can hardly be pegged a luxury when it costs less than \$60 and utilizes just 7 sq. ft. to make two bathrooms from one. Price as well as design flexibility of Fiat's new *Pilot* steel shower cabinet should make it popular with builders. Standing 75" high, the *Pilot* has a reversible panel that permits installation of the valves on either right or left side without any drilling on the job. The cabinet's receptor is heavy-gauge steel finished

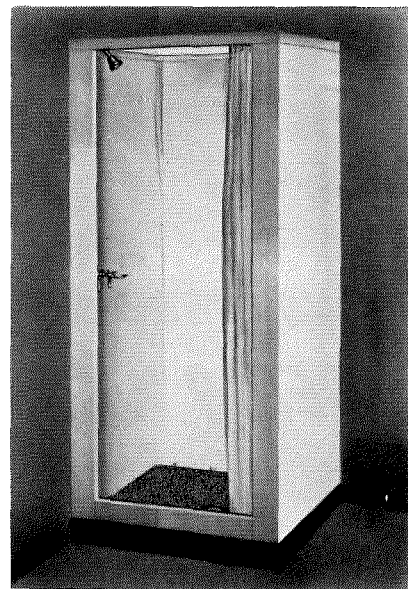

with vitreous enamel, and its walls are rust-proof galvanized steel with a baked-on coating of synthetic enamel. Valves, shower head, and recessed soap dish are chromium plated. Packaged complete with a heavy plastic shower curtain, the *Pilot* can be fitted with a *Neptune* shower door which Fiat makes in clear or translucent glass. The 30" size cabinet is priced at \$57.50; the 32" size at \$59.50. *Manufacturer:* Fiat Metal Mfg. Co., Franklin Park, Ill.

ALL-ALUMINUM ROOF doubles as effective insulation

More than just a house topcoat, *Aluminum-Lock Shingle* roofing is an integral reflective insulator. During summer it bounces 95% of the hot sun rays off its irregular grainlike surface; and in cold weather helps retain radiated heat within the house. The shingle is fabricated of 20-gauge aluminum alloy and

continued on p. 224

There's wall space galore...



When the heat's in the floor!

The prime purpose of a heating system is to heat, of course, and radiant panel heating does that superbly. But these modern heating systems have much more to commend them from a woman's point-of-view. And what women want, men get for them.

Because the heating panels of steel pipe are concealed beneath the floors or in the walls or ceilings, every inch of wall and floor space becomes available for use and decoration. Rooms *seem* larger, as a result, and furniture can be positioned in many more ways for complete decorative freedom. Women love that, just as they appreciate the greater cleanliness because there are no drafts, blasts, or hot or cold spots to cause

wall streaks and dirt deposits.

So, more and more, architects, builders, and plumbing and heating contractors are planning, specifying and installing "invisible" heating (as the ladies call it!), utilizing the natural advantages *steel pipe* offers for radiant panel systems.

They know that steel pipe has demonstrated its durability through more than 60 years of performance in hot water and steam heating systems. They know that, to the advantage of economy, may be added the factors of formability and weldability essential to satisfactory fabrication of coils and grids.

Yes, *steel pipe* is *first choice*... for radiant heating, snow melting and other applications, the most widely used *pipe* in the world!

**Steel Pipe
is First Choice**

A free 48 page color booklet "Radiant Panel Heating with Steel Pipe" is available. Write for your copy.

COMMITTEE ON STEEL PIPE RESEARCH

AMERICAN IRON AND STEEL INSTITUTE

350 Fifth Avenue, New York 1, N. Y.

DON'T GAMBLE WITH LESS THAN TOP PERFORMANCE TO VENTILATE THE MODERN KITCHEN



**TRADE-WIND
CLIPPER
VENTILATORS**

Only a Trade-Wind Clipper gives you the powerful, quiet suction through dual centrifugal blower wheels to adequately ventilate such kitchens as the photo shows.

Here is Trade-Wind Ceiling Model 2501 specially installed in the brass lined center canopy. The unit is equipped with 2-speed control—low speed for normal cooking and high speed to develop the full 425 CFM for heavy duty.

Trade-Wind also makes Model 3501 for installation in a cabinet or soffit directly over the stove where the newest designs call for this type of installation.

Write for complete information

TRADE-WIND MOTORFANS, INC.
5725-B South Main Street
Los Angeles, California

**TRADE-WIND
MOTORFANS, INC.**

NEW PRODUCTS *continued*

is designed to interlock on four sides for positive protection against wind and rain. Starter and gable strips, valleys, flashing, hip and ridge caps—even the nails—are made of aluminum for complete resistance to corrosion and termites. The entire roof, applied over a



30 lb. felt base, weighs only 40 lbs. per square. It can be painted, or left as is to weather to a soft gray, without appreciable

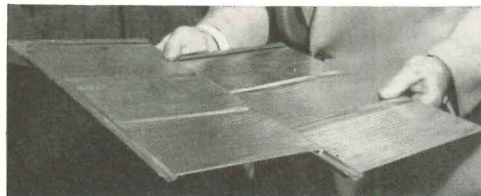

loss of insulating qualities. The manufacturer estimates the initial cost of *Aluminum-Lock* is three times that of asphalt shingle, but cites savings for the builder in ceiling insulation and in labor time because of the roofing's design for quick assembly. An incidental and unique feature of the aluminum product is that it will greatly enhance TV reception by directing random air waves to a roof antenna. *Manufacturer:* Aluminum-Lock Shingle Corp. of America, 725 S.E. Powell Blvd., Portland 2, Ore.

PREFAB CHIMNEYS made for pitched roofs and flat tops

With the addition of a packaged flue for flat-roofed, one-story structures, Condensation Engineering rounds out its line of economical, factory-engineered *Vitroliner* chimneys. Sup-

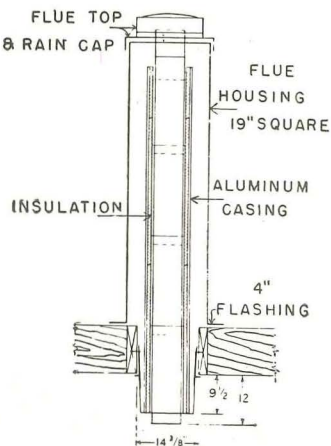

ported by straps nailed to ceiling joists (16" o.c.), the new unit can be installed by one man in less than an hour in any part of the house. The chimney's steel pipe core, made

continued on p. 228

CONTRACTORS and BUILDERS:

Attention!

Modern living
at low cost...

**FORD HOMES
SELL!**



- 50 standard models plus special designs
- Choice of exterior treatment
- Quality materials & workmanship
- Complete Factory-Built panels
- Delivered direct to your foundation
- Erected in less than 60 man-hours
- High appraisals, easily financed

These are only a few of the reasons why builders throughout the Northeast prefer the Ford Home package. Ford Homes are available in modern, or conventional style—require no compromise with real comfort and convenience. Flexibility in design assures quick sales and satisfied customers.

Triple profits—less labor—less sales effort—lower cost, faster turnover, less invested capital, no material chasing with Ford Factory Built Homes. Write today for free catalog and dealer application or plan a visit to our plant.

Manufacturing franchise also available.

FORD HOMES
McDonough, N. Y.



the inside facts

about the

ALL ALUMINUM MIAMI AWNING WINDOW

Today's woman exerts an increasing influence in the building of her home. She wants inside facts about features that make housekeeping easier.

The architect or builder can tell her with confidence that Miami Windows are better looking, last longer, and easier to clean (from the inside) at no more cost than ordinary windows.

Then too, the homemaker, being economical, is interested in knowing that Miami Windows close tighter reducing cold air infiltration to an absolute minimum - thus cutting fuel costs.



Easy to clean from inside

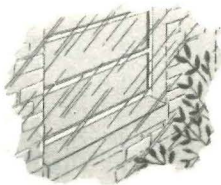

Positive weathertight construction.



Recessed inside for screens and storm windows



The Original Awning-Type MIAMI WINDOW [®]



For further information write, wire or phone Dept. HH-5 or see Sweet's Architectural File $\frac{3c}{Mi}$

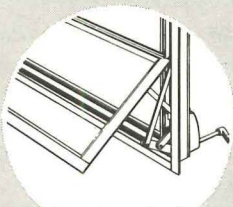

Locks automatically in any position

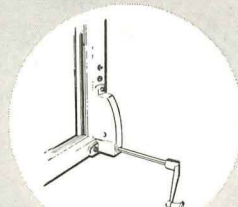

Opens and closes with single operator

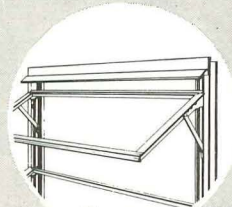

Extra wide vents provide 24 hour ventilation

MIAMI WINDOW CORPORATION

5200 N. W. 37th AVENUE, MIAMI, FLORIDA

FACTORY No. 2 — 4610 N. W. 37th Avenue, Miami, Florida

MIAMI WINDOW CORPORATION OF MISSISSIPPI—Key Field, Meridian, Miss.

MIAMI WINDOW CO., N. E. — 2077 Elmwood Avenue, Warwick, R. I.

MIAMI WINDOW CORPORATION OF PANAMA, Box 923, Panama, R. P.

MAIL THIS COUPON TODAY

MIAMI WINDOW CORPORATION HH-5

5200 N. W. 37th Avenue, Miami 42, Florida

Gentlemen:

Please send full facts about the all-aluminum Miami Awning Window. Thank you.

Check One: Architect Builder Dealer

Name

Address

City State

Let the
RICH-TRIPLETS
work for you!

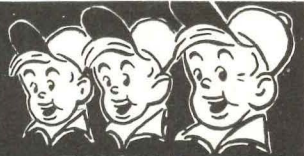

Richkraft

Only Richkraft brings you a complete line of building papers which permits the use of the right paper for every job. There's *Skuf*—every heavy duty, fully reinforced, plasticized and waterproof; *Medium Duplex*—forced, plain Kraft. And, 30, a low-cost Duplex. And, last but not least, Richkraft Black Sheathing papers. There is a Richkraft paper to meet every job requirement and economy. Ask for details.

Richflex

Richflex Reflective Insulation makes insulation an easy matter in keeping with job economy.

With Richflex you do a 4 in. summer heat out, create a moisture barrier, and a cold air barrier. Richflex turns back more than 75% of the heat rays striking it.

Use Richflex in side walls and in floors. Richflex in ceilings reduces by 15° by preventing thick insulation from storing sun heat during summer months. Ask for details.

Richbead

Richbead brings the protection of metal to both exterior and interior corners for new and existing homes. It eliminates banged up corners at doorways, arches, reveals and soffits and it covers cracks caused by settling in interior corners.

Richbead consists of a metal angle glued to joint tape and it can be installed by anyone. Richbead allows great savings by the elimination of casings around doors and windows and it means a real saving in time because it does away with factory corners, and permits the use of any piece of wall board. Ask for details.

ANOTHER
Richkraft
PRODUCT

THE RICHKRAFT COMPANY
510 N. Dearborn St., Chicago 10, Ill.

Gentlemen:
Please send me complete details on:
Richkraft Reinforced and Breather Papers
Richflex Reflective Insulation
Richbead for dry wall corner protection

NAME _____
ADDRESS _____
TOWN _____ ZONE _____ STATE _____

NEW PRODUCTS *continued*

with bell and spigot joints, has a coating of acid-resistant vitreous enamel inside and out. Insulation, 1" thick, and a metal casing are said to insure high stack temperatures and good draft as well as to protect nearby wood members from any dangerous heat. *Vitroliners* are listed by Underwriters' for use with coal, oil, or gas heating units, and are adaptable to suspension-type or stand-up furnaces. They come with flue diameters of 6", 7", 8" and 10". On the flat-top unit pictured, the 19" square sheet-metal housing extends from 3' to 6' above the roof line. *Vitroliner* prices run from \$50 to \$75 for one-story models up to \$100 for two-story.

Manufacturer: Condensation Engineering Corp., 3511 W. Potomac Ave., Chicago 51, Ill.

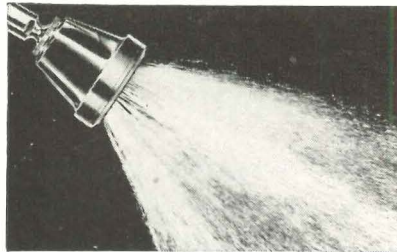

SELF-CLEANSING SHOWER HEAD yields efficient spray on little water, low pressure

Operating on as little as 5 lbs. water pressure, the *Magic Fountain* shower head should prove a boon in water-short areas. Without sacrificing washing effectiveness or shower comfort, the new device uses half the water of a conventional shower head. Even where water is plentiful, the saving can be reflected in water heating costs. The conical body of the *Magic*



Fountain is molded of chip and corrosion- and chip-resistant phenol plastic. A crepe rubber diaphragm pierced with fine slits regulates the flow. By adjusting a set screw, pattern and pressure can be altered from a spine-pelting stream for the athletic bather to a restful bubbling spray for the languorous. Price to builders for the shower head is around \$5.30.

Manufacturer: Magic Fountain, Inc., Waltham, Mass.

INSULATION-VAPOR BARRIERS are made for masonry construction

Two kinds of insulation recently developed to increase the thermal effectiveness of concrete, masonry block, and brick walls are *Alfol* type

continued on p. 232

A "BUILT-IN" FEATURE THAT SELLS HOMES!

In Cleveland . . .

Project builder orders 1000 Chore Boys

In Detroit . . .

Builder buys Chore Boys in 50-lot quantities

In South Dakota . . .

U.S. Air Force 561-unit housing project specifies Chore Boy Incinerators

CHORE BOY

GAS INCINERATOR

AT SPECIAL BUILDERS' PRICES



Model 14-S

\$51⁹⁷

Wall mounted, this model can be completely installed in less than 1 hour. Heavy steel shell, cast iron door and grate, high temperature lining. Size: 16" wide x 24" high x 11" deep. Capacity: .67 bushels.

Quantity discounts on all models

Model W-2

\$63⁰⁵



This wall-style model, most popular in new homes, requires no extra installation time. Heavy steel exterior, cast iron front and grates, high temperature lining. Size: 16" wide x 16" deep x 33" high. Capacity: 2 bushels.

SEND YOUR ORDER TODAY!

Ship me _____ CHORE BOY Incinerators; Model _____

Check Enclosed C.O.D.

Name _____

Address _____

City _____ Zone _____ State _____

INCINERATOR PRODUCTS CO.
685 POST AVE. S. • DETROIT 17, MICHIGAN

Gates cuts costs

...and lower costs

SELL houses!

**HOW DOES *Gates*
CONCRETE FORMING
CUT COSTS?**

up to 60% labor savings!

Eliminates hand-tying, extensive waling, much bracing, much of the lumber handling and a tremendous amount of hand-sawing and fitting.

save 75% on hardware

Gates form ties eliminate bulk wire purchases, and you'll use less than one-fourth the nails.

all lumber recoverable

Lumber comes off form clean, unscarred by nails. Log cabin corner fitting leaves longer lumber.

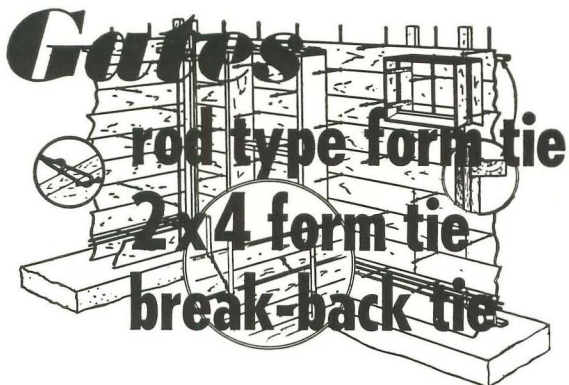

INVESTIGATE TODAY!

Complete catalog and details sent free.

Name _____

Firm _____

Address _____

City _____ State _____

Gates & Sons, Inc.

80 So. Galapago • Denver, Colorado

*Cabinet Hardware
That Sells Homes...*

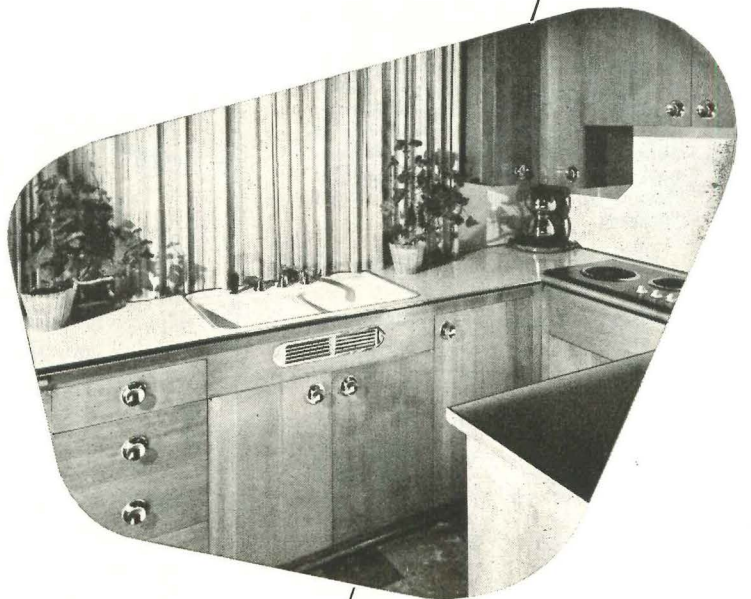

Cabinet Hardware can do more than open doors, it can open a whole new field of cabinet design. It can add "the finishing touch" that makes women say "my what a beautiful kitchen!"

It can only be done with unique hardware. Washington is unique.



WASHINGTON LINE

Ask your dealer or write to:
WASHINGTON STEEL PRODUCTS, INC.
Dept. HH-5, Tacoma 2, Washington

**WEATHERSTRIPPED
DOUBLE-HUNG
WOOD WINDOWS
show infiltration ratio**

6

TIMES LESS

... than non-weatherstripped windows by actual test of weatherstrip manufactured by members of the Weatherstrip Research Institute. (University of Minnesota Institute of Technology Testing Laboratory.) Effectiveness is greater than 6 for average or poorly fitted windows.

**Reduction in Air Infiltration
Through Windows
Due to Weatherstripping
(Unlocked—no storm sash)**

Type of Fit	Par Infiltration* cfh/ft. of Crack		
	Weather- stripped	Non- Weather- stripped	Weatherstrip Effectiveness†
Well	14.2	61	4.30
Average	16.7	104	6.24
Poorly	23.8	163	6.85

*At a pressure of 0.20 inch of water (20.4 mph wind velocity).
†Ratio of non-weatherstripped to weatherstripped par-infiltration.

The above facts, plus the complete story on weatherstripping is presented in Bulletin No. 35—"Air Infiltration Through Weatherstripped and Non-Weatherstripped Windows," published by the University of Minnesota, Institute of Technology. The facts showing the economic value of weatherstrip are based on over-all research of climatic conditions in 12 selected cities in the U.S. covering a full range of weather conditions.

THE SYMBOL OF
INSTITUTE MEMBERS

**WEATHERSTRIP Research
INSTITUTE**

OFFICE OF THE SECRETARY
BOX 101 - RIVERSIDE, ILLINOIS
DEPT. HH-53

Please send my FREE Copy of the 47 page,
illustrated Bulletin No. 35.

NAME _____

ADDRESS _____

CITY _____ ZONE _____ STATE _____

NEW PRODUCTS *continued*

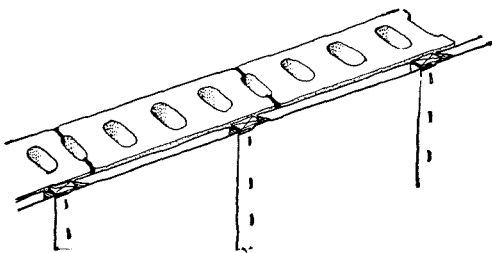

1-A and Masonry Balsam-Wool. The Alfol, pictured above, consists of aluminum foil and a layer of waterproof duplex laminated kraft paper. It utilizes the reflective surface of the foil and the 1" air space between foil and the room-side skin for effective insulation. It comes in compact rolls containing 250 sq. ft. and can be stapled to 1" x 2" furring strips set 16" o.c. The 7/8"-thick blanket-type Balsam Wool, shown below applied to an SCR brick wall, is completely enclosed in asphalt

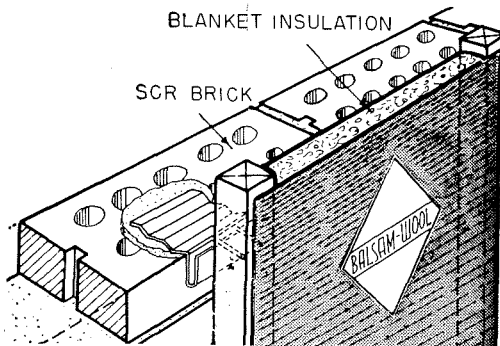

saturated liners. It is made in two widths for attachment to strips 16" or 12" o.c. Each of the insulating materials costs around 5¢ per sq. ft., plus installation.

Manufacturers: Alfol—Reflectal Corp., subsidiary of Borg-Warner Corp., 155 E. 44th St., New York 17, N. Y. Balsam-Wool—Wood Conversion Co., First National Bank Bldg., St. Paul 1, Minn. *continued on p. 236*

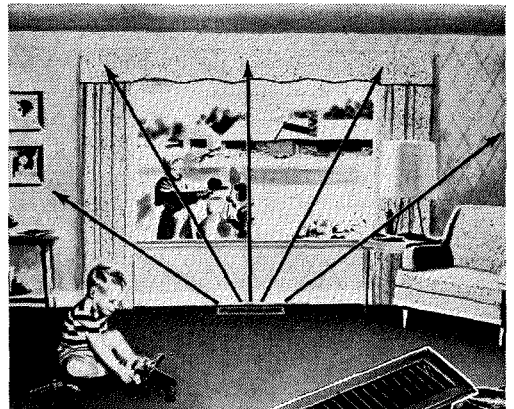

from
floor
outlets

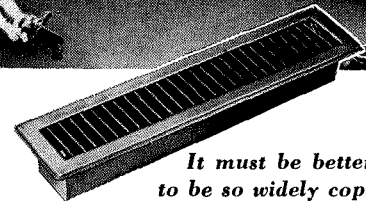

*It must be better—
to be so widely copied*

**Lima
DIFFUSERS**

**assure you of proper
air distribution in
perimeter heating**

Originally developed by Lima engineers and widely copied ever since, Lima Diffusers have helped popularize perimeter heating. The illustration above shows how the Lima Floor Diffuser does the complete job. It diffuses a fan-shaped blanket of warm air at reasonably high velocity to stop cold in critical areas . . . and . . . it pulls air from within the room into circulation without drafts. Sizes include 2" x 12", 2" x 14", 4" x 10", 4" x 12" and 4" x 14".

This same correct diffusion pattern can be secured from wall outlets with the new Lima "45" Wall Diffuser as shown in the illustration below. Sizes include 10" x 6" and 12" x 6". Ask your wholesaler or write direct for literature.

Lima register company

World's Finest Diffuser and Register Plant **LIMA, OHIO**

sold exclusively through heating wholesalers and manufacturers

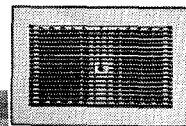

from wall outlets

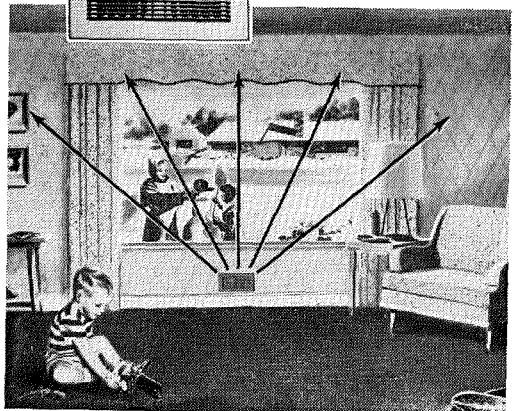

Build a better sales story
from the ground up with

SCR brick* walls

- ▶ When you build with "SCR brick," the sales appeal of your houses climbs with the walls—there's no need to rely on costly last-minute "extras."
- ▶ You offer just what most home buyers have always wanted—fire-safe, durable, solid brick at a cost that competes with frame.
- ▶ And you can point to each of the features shown here as evidence that you are supplying more house for the money.

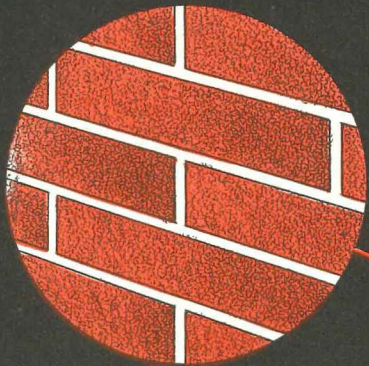

LOW INITIAL COST—This larger, thru-the-wall brick cuts costs by eliminating "backup," speeding construction. Meets all national building code requirements for single-story houses.

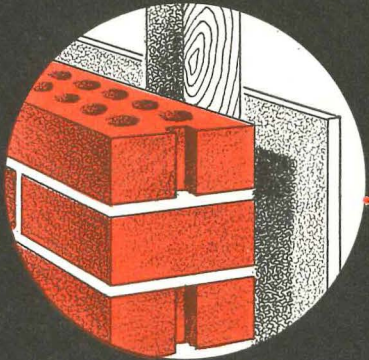

ALL-WEATHER PROTECTION—2" air space formed by furring strips acts as moisture barrier and insulating space for year-round comfort, reduces fuel or air-conditioning costs.

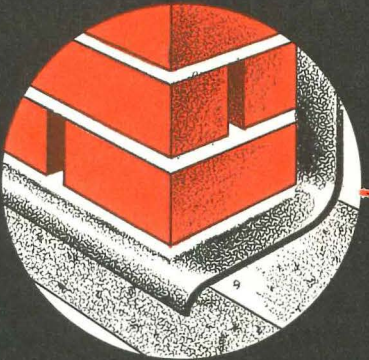

DRY WALLS—Weep holes and base flashing keep cavity dry—an inexpensive built-in sales feature showing quality construction.

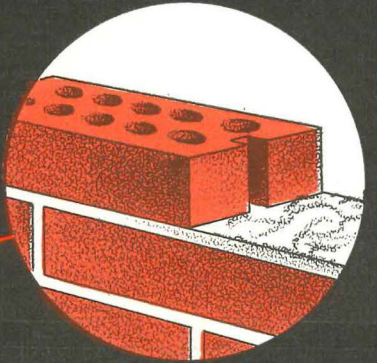
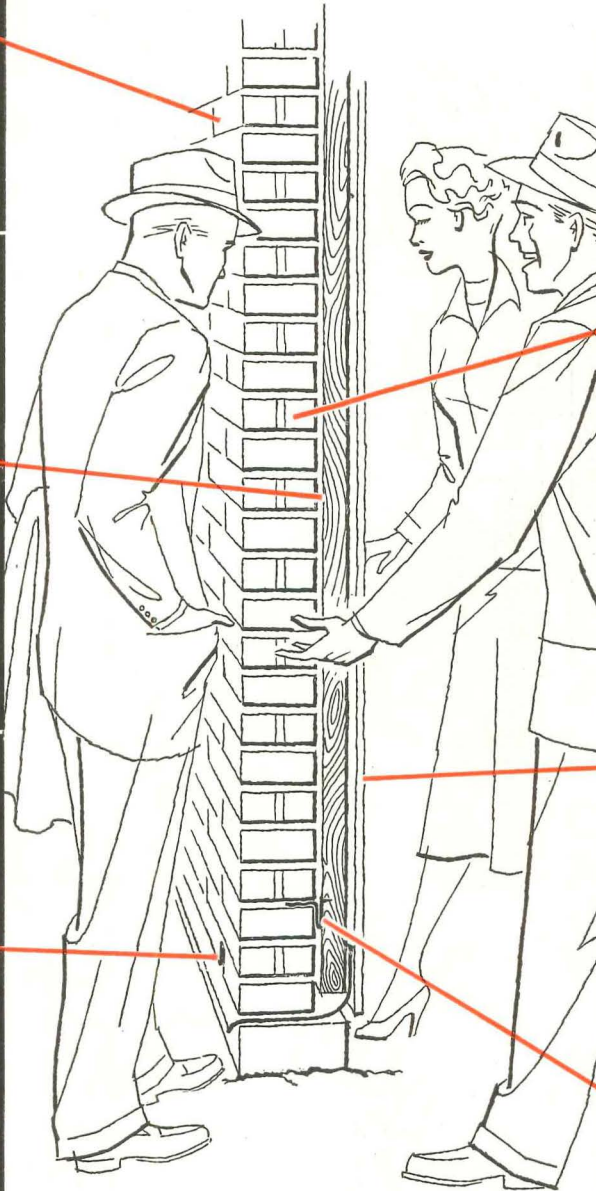

CUSTOMER PREFERENCE—Most people want brick—for maintenance savings, lower fire insurance rates, higher re-sale value, lasting beauty.

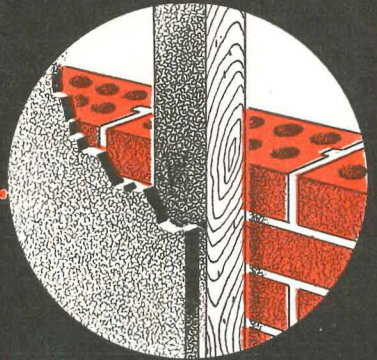

CHOICE OF INTERIORS—Variety of finish is offered through either plaster or dry wall materials—with assured protection from air space.

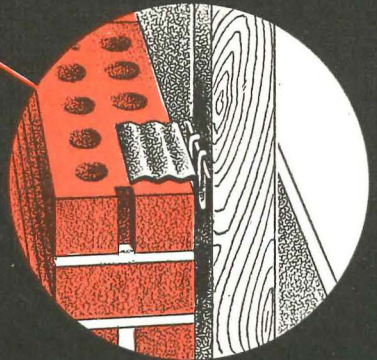

PRECISION-BUILT—Special furring clips preserve strips by preventing contact between wood and masonry, also simplify construction.

free booklet "HOW TO BUILD HOMES THAT SELL WITH THE 'SCR BRICK'" gives full construction details. To get one, just write us. Address: HH-5.

*Reg. TM, SCPRF, Patents Pending



STRUCTURAL CLAY PRODUCTS INSTITUTE

1520 18th Street, N. W., Washington 6, D. C.

**FEATURES
SELL HOMES!**

In the homes
you build . . .
FEATURE

"Comfort from Moving Air"

Builders today know that buyers, above all else, want *comfort!* The house that sells is the house that has *comfort built-in!*



FEATURE a master Home - Conditioning Fan in the attic; say, "This house stays up to 15° cooler in Summer, fresh all year."

FEATURE a Kitchen Ventilator; say, "No greasy smoke, no cooking smells! This house stays clean!"



FEATURE a Bathroom Ventilator; say, "No musty moisture, no lingering odors in this bathroom!"

These are features that turn *prospects* into *buyers* at little extra investment!



For accurate, illustrated, detailed information on how to install and sell "Comfort from Moving Air" in the homes you build, send for this comprehensive 200-page book, the most complete guide to air-moving equipment ever published. Produced by Torrington in cooperation with more than 100 American makers, it's your fastest guide to speedy sales. It's **FREE** — write for your copy today!



**THE TORRINGTON MANUFACTURING COMPANY
TORRINGTON, CONNECTICUT**

Western Div: Van Nuys, Calif. • In Canada: TMCo., Ltd., Oakville, Ont.

Box 808-X, TORRINGTON, CONNECTICUT

Please send my **FREE** copy of the '53 **GOLD BOOK** "How to have Comfort from Moving Air."

NAME _____

ADDRESS _____

CITY _____ ZONE _____ STATE _____

NEW PRODUCTS *continued*



PORCELAIN-ON-STEEL TILE stacks in precise pattern over scored backer-board

Even a 10-thumbed workman would be hard put to do a less than perfect setting job with *Veos* porcelain enameled wall tile. A unique foundation board, grooved to grip flanges on the tile, makes precise alignment practically foolproof. In new construction the board—which also acts as thermal and acoustic insulation—is nailed on a level line to wood sheathing or to 1" x 3" horizontal strips 6" o.c. The tile is buttered with adhesive (or, as pictured below in a Levitt-engineered application, the board gets the glue) and set in place. The crisp, uniform seams are then pointed

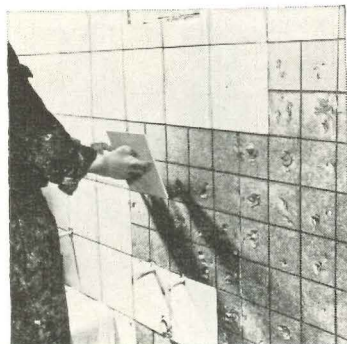

with white or tinted waterproofing grout. Wafer thin (tile and board together are just 9/16") *Veos* units combine the light weight of metal tile—1.15 lbs. as compared to clay's 4 to 6 lbs. per sq. ft.—with the wearability of ceramic. Actually, the face of the *Veos* tile is ceramic—vitreous enamel fused to steel. Because this porcelain surface has the same expansion characteristics as its steel backing, it will not craze or crack. Nor will the fired mineral pigments vary or fade. The gray, wide and handsome tile shown are 8 1/4" square. Smaller standard sizes are available

continued on p. 240

IN LEVITTOWN, PA,

EVERY HOME

IS HEATED WITH

YORK-HEAT

TABLE TOP BOILERS

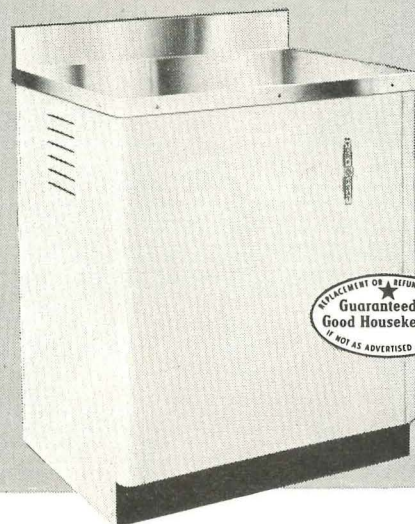

WARRANTY OR A RETURN OF MONEY
Guaranteed by
Good Housekeeping
NOT AS ADVERTISED THEREIN

**REVOLUTIONARY NEW BOILER
NOW AVAILABLE TO ALL
BUILDERS AT LOW PRICE!**

This small in size (25" x 30" x 36" high) and large in capacity (102,000 B.t.u. per hour) boiler unit for radiant or hot water heating is being installed in every home in Levittown, Pa., and is available to all builders at low prices, made possible by this mass production.

SMALL SIZE • OIL OR GAS

York-Heat Table-Top boilers are fired with either oil or gas depending on your needs. Controls are enclosed within the gleaming white cabinet.

SEVEN MODELS AVAILABLE

A complete range of models for all heating applications are available, all approved by Underwriter's or A.G.A. Boiler is ASME inspected and has FHA approval.

YORK-SHIPLEY, INC., YORK 10, PA.

Please send details on York-Heat Table-Top Boilers immediately.

Name.....

Address.....

City.....State.....

Check here if gas is available in your area.

with this **sensational,** equipment—by **Coleman**[®]

FLOOR FURNACES with heat-making, fuel-saving efficiency OIL GAS LP-GAS

Fits in floor—takes no space. Heats 2 to 5 rooms

Space-savers the home buyer always appreciates! Complete, compact units that fit in the floor. No basement needed, no air ducts, no trouble installing. Perfect for long years of trouble-free operation, they give complete change of fresh warm air 3 to 5 times an hour.

Oil models have exclusive new Coleman Fuel-Air Control that saves up to 25% of fuel. Gas models have many Coleman exclusive features—Stainless Steel burner, full gas flow on only 3½" of water pressure, with Streamlined Bottom for 35% faster air flow.

FLAT REGISTER MODEL (at right)—lies flush with floor, takes no space. Efficient, quiet performance with 84% open register for maximum heating comfort.

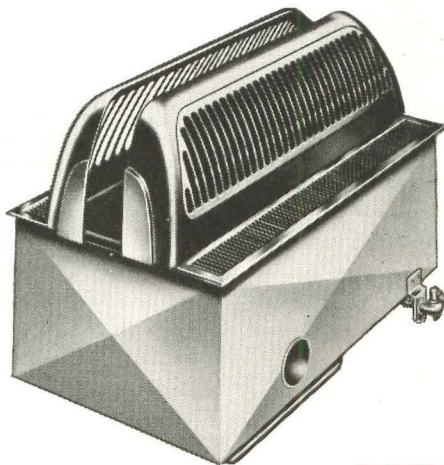
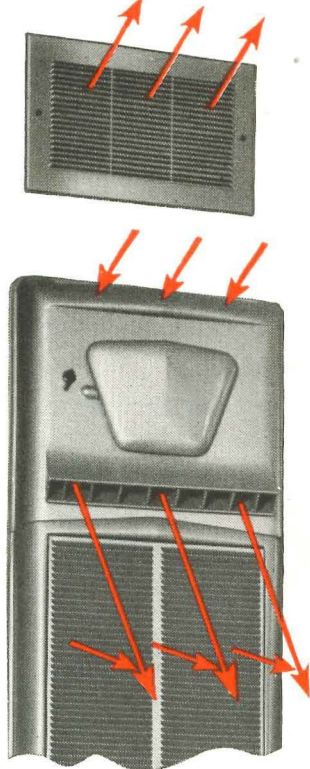
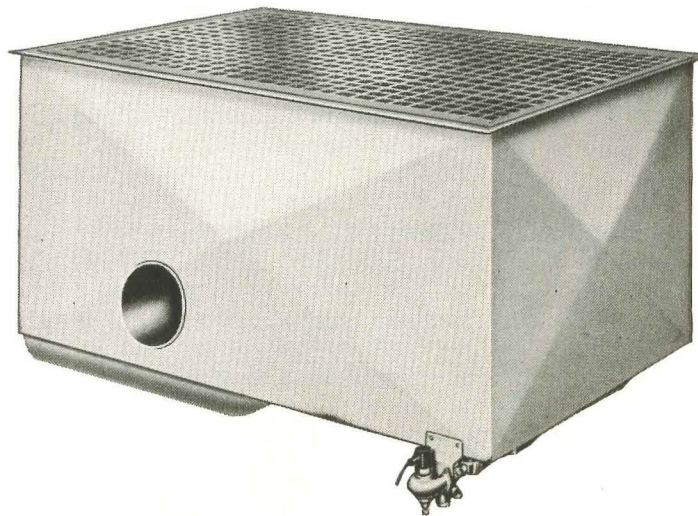

← **DUAL WALL MODEL** (at left) — fits beneath wall or partition, heats two adjoining rooms at same time. A complete, compact unit easy to regulate and keep clean.

Send for more information on these scientifically engineered, attractively designed wall heaters and floor furnaces that give low-cost homes powerful sales attraction. The Coleman Company, Inc., Wichita, Kansas.

See our catalog in Sweet's File for Builders

Comfort costs so little with a

Coleman[®]

America's leader in home heating

ALL EQUIPMENT AGA APPROVED OR LISTED
WITH UNDERWRITERS' LABORATORIES

THE COLEMAN COMPANY, INC.
Dept. 653-H, Wichita 1, Kansas

Please send information on Coleman Wall Heaters and Floor Furnaces. Oil Gas LP-Gas

Name _____

Address _____

City _____ State _____

No matter how big or small your home, there's a Coleman to heat it better

**INSTALL 'EM
FORGET 'EM**

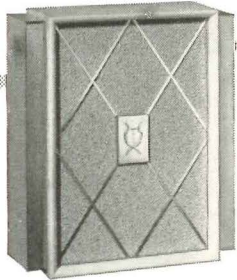

THE AVALON
\$10.95 list

**ONLY
RITTENHOUSE
DOOR CHIMES**

have the **FLOATING
PERCUSSION UNIT!**

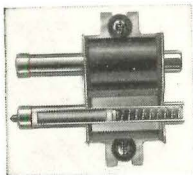

This is the only chime striker unit that eliminates metal to metal contact between plunger and solenoid tube.

HERE'S WHAT it does—assures dependable, quiet, service-free chime performance. It ends annoying hum, buzz and sticking plungers. No Rittenhouse Door Chime with Floating Percussion Unit has ever been returned for servicing because of jammed or sticking plungers . . . most common cause of failure with conventional chime design.

plus Matchless Tone

The melodious golden tone of Rittenhouse Door Chimes is due to flawless craftsmanship, finest quality materials and precision engineering. More than a million in daily use.

**and A Style
for Every Home**

There's a Rittenhouse Chime design for every type home—apartment, cottage, ranch or mansion. 15 models from \$4.95 to \$116.00 list.



THE SENTINEL \$15.95 list

See your electrical contractor or write direct for all the facts on the complete Rittenhouse Door Chime Line.



THE RITTENHOUSE CO., INC.

33 Allen Street, Honeoye Falls, N. Y.

Please send information on your complete chime line.

Name _____

Address _____

City _____ State _____

NEW PRODUCTS *continued*

in 12 other stock colors, as well as larger tile and special colors in quantity orders. In-place cost of *Veos* comes to around \$1.60 per sq. ft.

Manufacturer: Porcelain Enamel Products Corp., Div. of The Bettinger Corp., Rehoboth, Mass.

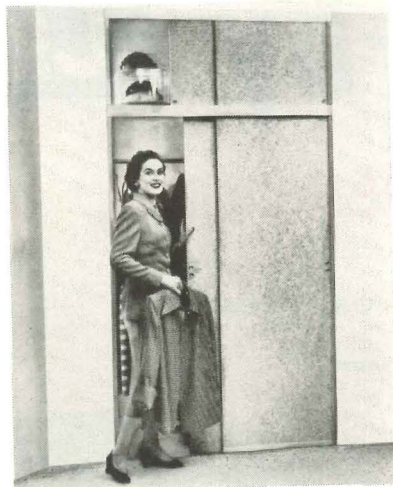

FLOOR-TO-CEILING CLOSET FRONT shipped with overhead track attached

Topping its own *Novoply* sliding doors (H&H, Apr. '52) National is now packaging a closet front with cupboard as well as wardrobe doors made of US Plywood's warp-resistant wood-waste board. Delivered with hardware attached and headers and jambs, the new combination requires no framing above the doors in an 8' high room; it trims right to the finished ceiling. Units are made to fit rough jamb openings 3', 3'-6", 4', 5' and 6' wide. The largest, pictured above, sells for about \$26. No dust-inviting grooves nor projecting separators are needed between closet floor and room because the wardrobe section operates on a ball-bearing overhead track. (Adjustments can be made easily to compensate for an irregular floor line.) Both pairs of doors have conveniently placed round pulls and are banded with a neat oak molding. The closet can be painted or stained to bring out the natural wood-chip pattern of the *Novoply* laminate.

Manufacturer: National Door Co., 163 Avenue A, Bayonne, N. J.



CEILING DIFFUSER nests lighting fixture

Widely accepted in big construction, overhead air distribution has not been adopted to any great extent for residential heating or cooling largely because diffusers have not been geared

continued on p. 244

SUN-SASH

air-controlled louvred windows

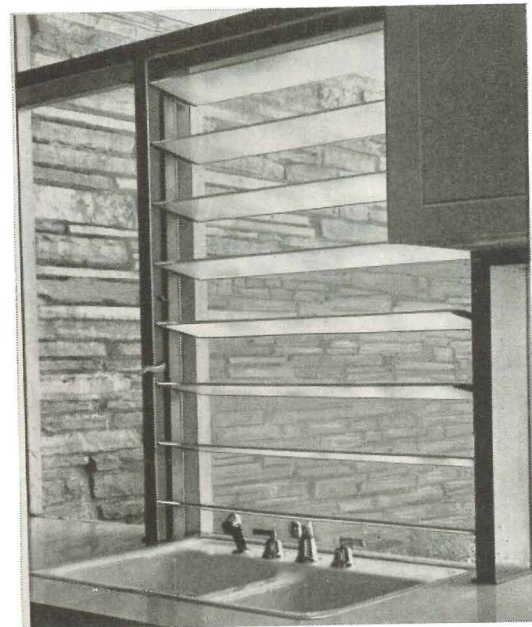

**America's Largest Selling
Lowest Cost Louvred Window**



SUN-SASH Features:

- Automatic locking
- Inside cleaning
- One-finger operation
- Fits any size opening
- Draftless ventilation
- Screens or storm sash can be fitted to the opening
- Can be installed vertically or horizontally.

SUN-SASH . . . a louvred window that is designed specifically to meet your building needs. Sun-Sash is perfect for new construction or remodeling . . . for kitchen windows . . . porches . . . breezeways . . . interior partitions . . . bathrooms . . . attic ventilators and cellars. Specify Sun-Sash air-controlled louvred windows. — America's largest selling louvred window.

MULLIONS

DOUBLE HEIGHT

With jamb fittings butted over each other. Cut 15/16" from bottom of top Sun-Sash to provide glass overlap.

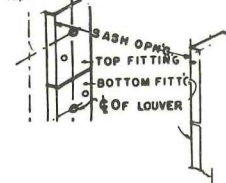

DOUBLE WIDTH

WITH CENTER MULLION OF 2 JAMB.3 FITTINGS FASTENED BACK TO BACK.

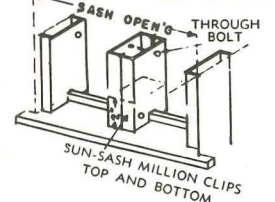

INSTALLATION IS EASY AND INEXPENSIVE



Screw on Sun-Sash fittings to side of window frames.



Slide glass louvres in to rattle-proof spring clip holders.



Close end of clips over glass to hold blades firmly in position.

MAIL THIS COUPON FOR FREE CATALOG

SUN-SASH COMPANY
38 PARK ROW, N. Y. 38, N. Y. HH-2

NAME _____

ADDRESS _____

CITY _____ STATE _____

with beauty that sells and sells!

WEDGEWOOD

Georgia-Pacific's new textured wood wall paneling gives you powerful new sales appeal at low cost

With WedgeWood you can turn prospects into customers: give them style, beauty, texture, give them color . . . give them new decorative ideas . . . AND reduce your costs. WedgeWood adds distinction and charm to any home design or style . . . raises them far above the ordinary in the eyes of your prospects. WedgeWood can be used in full-room or one-wall treatments . . . gives you an important edge over

competitive builders in your area.

The swirling grain and rich, sculptured texture of WedgeWood lend themselves to dramatic two-tone color effects that are in complete accord with the sweeping trend to texture in decorating.

Let WedgeWood help you sell the next homes you build.



WedgeWood blends harmoniously with modern furniture, fabrics and accessories.

WedgeWood brings you limitless new styling and color possibilities

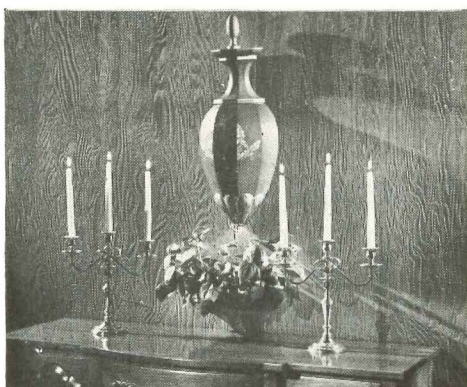

WedgeWood fits with timeless ease into traditional decor. Your customers will find their favorite style fits right with WedgeWood.

How builders use WEDGEWOOD in occasional or full-room treatments to create exciting effects and dramatic interiors

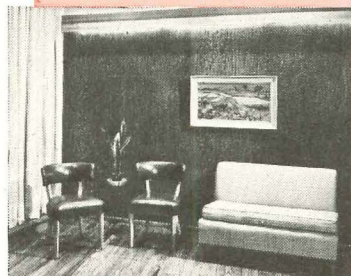

In an entrance hallway, WedgeWood paneling provides a warm welcome.



In a bedroom, WedgeWood creates a restful, relaxing atmosphere . . . hospitality and comfort in a guest room.



In a living room, WedgeWood's natural grain pattern adds style and beauty.

Use this Background of Beauty as a Cost-Cutting Sales Feature. See your Georgia-Pacific Representative or write to



**GEORGIA - PACIFIC
PLYWOOD COMPANY**

Dept. E, 605 North Capitol Way, Olympia, Washington

OFFICES OR WAREHOUSES IN: Augusta, Baltimore, Birmingham, Boston, Chicago, Cleveland, Columbia, Detroit, Fort Worth, Lancaster, Los Angeles, Louisville, Memphis, Nashville, Newark, New Castle, New Hyde Park, New Orleans, Olympia, Orlando, Philadelphia, Pittsburgh, Providence, Raleigh, Richmond, Salinas, Savannah, Seattle, Spokane, Toledo, Vineland, Waltham.

NEW PRODUCTS *continued*

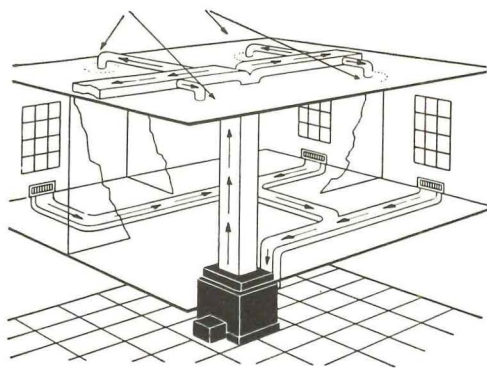

—in capacity, price, or looks—to home use. Connor Engineering set out to close the breach last year and introduced ceiling outlets specifically engineered and styled for home air-conditioning systems (H&H, Apr. '52). Now the firm has dressed up a new line of Kno-Draft diffusers with lamps and lenses to double as light fixtures. Their dual utility, packaged in a simple shell, should help popularize this effective method of air distribution with homebuilders and buyers. Like their mono-purpose K-D forerunners, the new units fan warmed or cooled air ceilingward where it mixes, above head level, with room air without any discomforting blasts. Return air grilles, situated along the baseboard, draw air from cold walls directly into the furnace.

K-D models are available with five styles of light fixtures. Each diffuser is made in 5", 6", 7" and 8" neck diameter sizes with capacities for heating ranging from 7,000 to 23,000 Btu's per hr. and for cooling, from 80 to 350 cu. ft. per min. Prices are approximately \$15 to \$21. *Manufacturer:* Connor Engineering Corp., Danbury, Conn.

BASEBOARD CONVECTOR SYSTEM packaged on a per-house basis as aid to builder

For projects of 10 or more houses, York-Shiple will package complete *Aqua-Ray* baseboard convectors separately for each house. Easy to install, the new system features an 8" high mounting plate which supports the finned aluminum heating coil and acts as a radiant heating surface. A cleanly styled cover plate, factory primed, slips over the base plate and coil to extend just 2½" from the wall. The coils have a hot water rating of 525 Btu per lin. ft. An *Aqua-Ray* system for a six-room home 24' x 36' costs about \$200.

Manufacturer: York-Shiple, Inc., York, Pa.

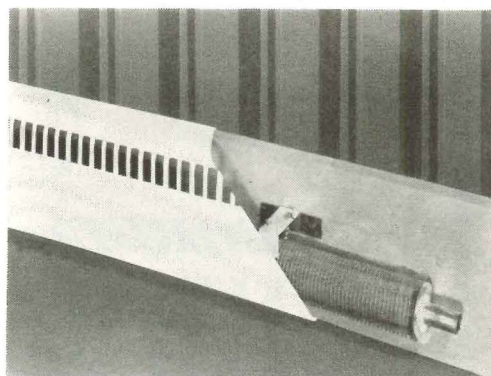

Technical Publications on p. 248

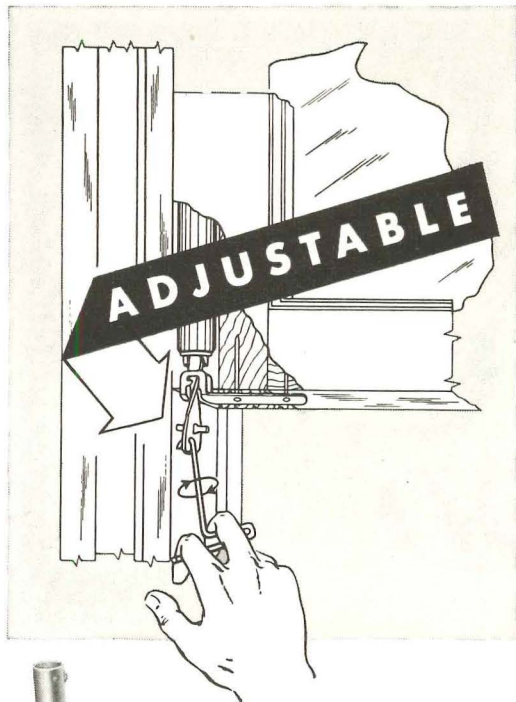

SPIREX
SPIRAL-SPRING
SASH BALANCES

The CALDWELL SPIREX guarantees easy-to-open, quiet operation of double hung windows for the life of the building. They are easy to install on the job or in the mill because tension can be adjusted after installation.

An exclusive feature is the patented clock-steel, flat wire spring. The spring coils are separated to prevent friction and eliminate noise, specially coated to prevent rust. Brass bearings are used to guarantee smooth, trouble-free operation. All other parts are zinc or cadmium coated steel.

AVAILABLE IN
ALL SIZES

CALDWELL CLOCK-SPRING
SASH BALANCES

CALDWELL guarantees smooth, trouble-free operation of double hung windows for the life of the building.

Tape-locking device speeds installation. Window units equipped with overhead clock-spring balances require a minimum of on-the-job carpentry.



Type 242 FT

WRITE TODAY FOR FREE CATALOG

CALDWELL MANUFACTURING CO.
72 Commercial St., Rochester 14, N. Y.
Please send catalog and price list to:

NAME _____
COMPANY _____
ADDRESS _____
CITY _____ STATE _____

Ask the man behind the "gun"

Coated optics
give you
this ↗ **not this** ↘



Model 3000, \$185.00*, complete with tripod.

with a White
Universal Level-Transit

HERE'S what coated optics do for you. You can put in a full day without eyestrain or headache. There's less chance for a mis-reading. You get a clear, sharp sight — not a fuzzy image. What's more, you get your reading in far less time. Check this diagram. See for yourself how coated optics pass through up to 40% more light, provide a clearer image contrast.

PASSAGE OF LIGHT THROUGH UNCOATED LENSES

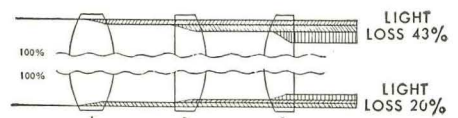

PASSAGE OF LIGHT THROUGH COATED LENSES

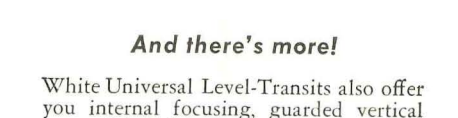

And there's more!

White Universal Level-Transits also offer you internal focusing, guarded vertical arc and ball bearing race which insures smooth operation, even in sub-zero temperatures. Check one out on your next trip. You'll soon be convinced a White can make your work faster, easier, more accurate . . . Write for Bulletin 1053. DAVID WHITE Co., 314 W. Court Street, Milwaukee 12, Wisconsin.



Expert REPAIR SERVICE on all makes, all types of instruments

*Prices subject to change without notice.

The man in two positions to buy



■ **As a businessman,** he buys or influences the buying for his company of goods and services of many kinds from many different sources.



■ **As a family man,** he and his wife and their friends are consistent best customers for all types of better products and services. Their interests are broader, and their means way above the national average.

Q.E.D. Successful businessmen-family heads like this, with their wives and families, comprise in large part the audience of TIME. Every week TIME's advertising pages talk directly to 1,700,000 families, America's most valuable prospects—best customers in two positions to buy.



Vitroliner

PREFABRICATED
CHIMNEYS

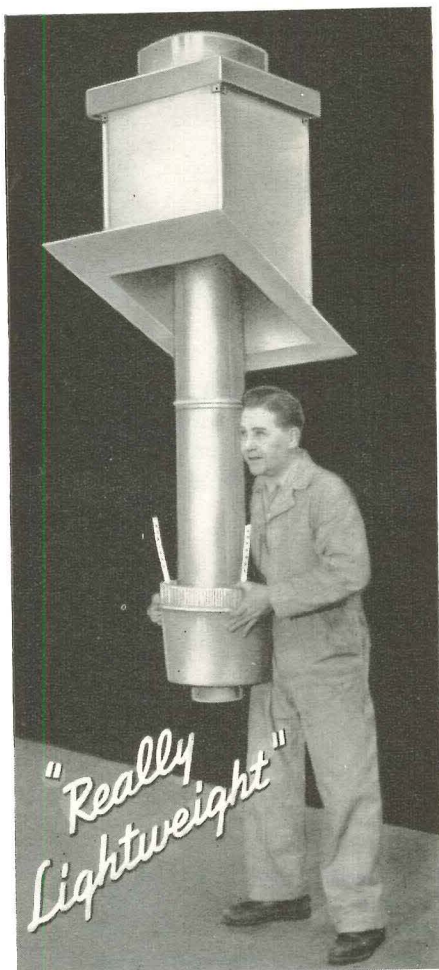

*"Really
Lightweight"*

Save Time—Money—Space

Speed up construction time with this packaged Vitroliner chimney by eliminating all masonry work. It is a complete chimney designed for 1 or 2 story homes or building using ANY fuel. Made in sizes 6", 7", 8" and 10" diameter.

The Vitroliner Chimney is lightweight and weighs only 10-15 lbs. per foot and installs easily and quickly in approximately 1 man hour. It can be mounted between ceiling joists directly over the heating plant.

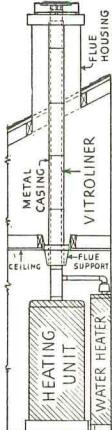

Tailor-made and packaged at the factory to fit the individual building—no cutting or fitting at the time of installation.

Vitroliner gives more draft than a comparable masonry chimney and also provides attic ventilation.

Quality built for long life. Accepted by F.H.A.—listed by Underwriters Laboratories and approved by local authorities.

Investigate this modern low-cost prefabricated chimney today!

CONDENSATION
ENGINEERING CORPORATION
3511 W. POTOMAC AVE., CHICAGO 51, ILL.

TECHNICAL PUBLICATIONS

METAL DOORS. Fenestra Residential Metal Doors. Detroit Steel Products Co., 3111 Griffin St., Detroit 11, Mich. 8 pp. 8½" x 11"

Describing steel swing-type and sliding doors designed for residential use, the catalogue is a useful reference for architects and builders as well as dealers. It lists stock sizes of the door units and illustrates details of hardware and installation. Sliding closet doors are pictured in a new simulated birch grain finish. They are also available with a gray baked-on prime coat.

GARAGE DOORS. 40 Garage Door Designs—Six Prize Winners and How to Build Them. Tavart Co., Paramount, Calif. 28 pp. 8½" x 11"

Putting the garage door, properly, before its overhead hardware, Tavart Co. co-sponsored with *Arts & Architecture* a national design

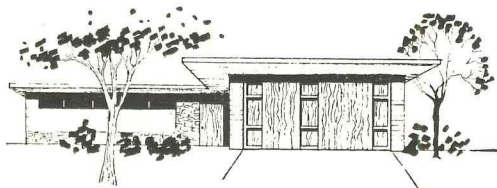

competition. This presentation of the winning plans is graphic testimony to what designers can work out with simple materials, given a gentle prod (like \$1,500 in prizes). In com-

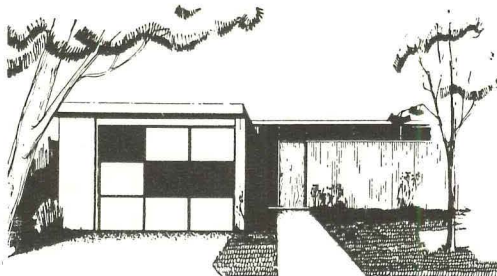

pliance with the rules of the contest, each overhead garage door can be built by an average workman with materials readily available from local lumber dealers. Each scheme is accompanied by a list of materials, fabrication plan and a rendering showing the garage door as part of a home. Most gratifying outcome of the competition is this repeated evidence not only that garage doors, too, can be beautiful but also that such ex-

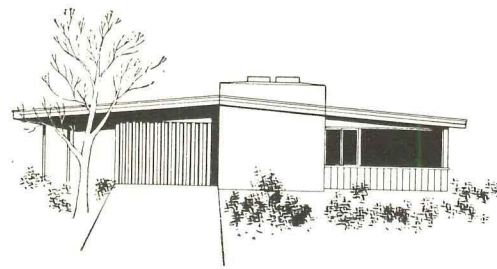

pensive objects can be smoothly integrated with the rest of the structure. John Kewell, AIA, makes a brief critical analysis of each winner and offers helpful suggestions on designing original doors.

continued on p. 252

a *"must"*
for today's
Modern Kitchens



THE
NATIONAL
FOOD WASTE DISPOSER

No kitchen today is really modern without a food waste disposer.

And head and shoulders above them all is the NATIONAL—preferred by builder and housewife alike.

Tops in quality, yet competitively priced, the NATIONAL'S exclusive split-ring construction means the quickest, lowest cost installation of any disposer on the market.

And only NATIONAL offers a choice of either continuous Feed or Lok-Top cover models. Both models feature the same rugged ⅓ h.p. motor, lifetime grinding elements, permanently bright sink ring.

On that next home project specify NATIONAL—the lifetime food waste disposer.

2141

NATIONAL DISPOSER
a product of
NATIONAL RUBBER MACHINERY CO.
Akron 8, Ohio

Send me detailed information on the model NATIONAL DISPOSER checked below:
Dept. HH-553

- Model 35CS — Safety LOK-TOP Cover.
 Model NC-45 — "Continuous Feed."

Builder's Name _____

Address _____

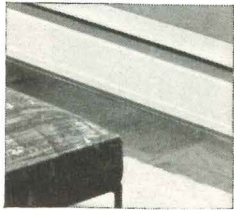

New Baseboard Convectector by TRANE brings you improved beauty of design plus . . .

Better solutions to 8 heating problems

1 Hidden heat that's designed to match (never mar) the beauty of the modern home!
 You look at it . . . and it's beautiful. Your clients will agree. It truly is! But the real beauty of the new TRANE Baseboard Convectector is that you *don't* look at it. It's inconspicuous. Built-in. Part of the wall. Clean.

Your clients can paint it to match the walls. They can hang draperies and curtains freely. They can put furniture *anywhere!*
 So to see the *true* beauty of the new TRANE Baseboard Convectector . . . look at the new beauty it gives the *rest* of the room. Hidden heat. It's a revolution!

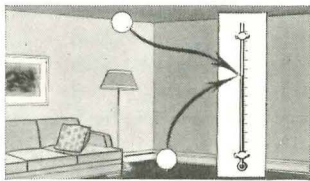

2 Even, all-over heat stops wall and window drafts!
 The TRANE Baseboard Convectector "surrounds" the homeowner with a wall of slowly-moving warm air. Temperature from floor to ceiling is uniform within a few degrees. Blocks down-drafts from cold walls and windows.

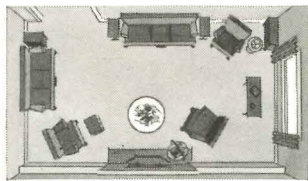

3 Complete freedom for furniture arrangement!
 There's nothing in the way. Nothing protruding. No hot blasts of air or scorching-hot surfaces to force the dweller or his furniture out of place. The cabinet projects only 2 3/4". Recessed, only 1 1/2".

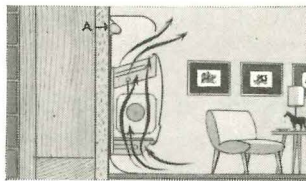

4 Features that help homes stay clean longer!
 Heat is directed out and away from wall through uninterrupted front opening. One piece bottom-back-top, full-length rubber strip seals unit to wall. Coved bottom, smooth easy-to-clean top, no unsightly grill work.



5 Hidden heat that neither burns nor blasts!
 You can touch it anytime. The TRANE Baseboard Convectector cabinet is never more than warm to the touch. And the heat rises out of it gently, slowly, evenly . . . never with on-and-off, hot-and-cold blasts.

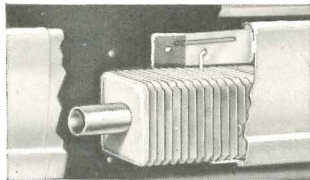

6 Free-hanging element for quiet operation!
 The famous TRANE fin-and-tube heating element hangs on swinging brackets within the cabinet. It's designed to hang freely . . . to prevent scraping against the cabinet. No moving parts, nor ducts to carry noise.

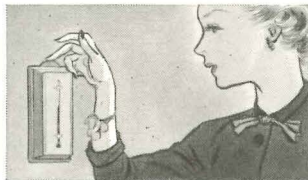

7 Fast response keeps heat uniform and costs low!
 Copper and aluminum surface of the TRANE heating element provides extra fast response. There's no fuel wasted on long warm-up and cool-off periods. The home dweller gets heat quickly, when he needs it.



8 Simple snap-on installation saves labor, money!
 In new construction or remodeling jobs, the TRANE Baseboard Convectector can be installed so fast, so easily that the initial cost is low . . . surprisingly low. Check your TRANE Sales Office for details.



Most complete baseboard data book available: FREE!
 TRANE engineers have compiled complete information on capacities, installation, roughing-in dimensions, control diagrams. The most complete literature available. Write for free copy, plus 4-color catalog for your clients.

Performs better because it's designed better . . . 6 ways ▶

Baseboard Convectector

Trane Co. of Canada, Ltd., Toronto • 80 U. S. and 14 Canadian Offices

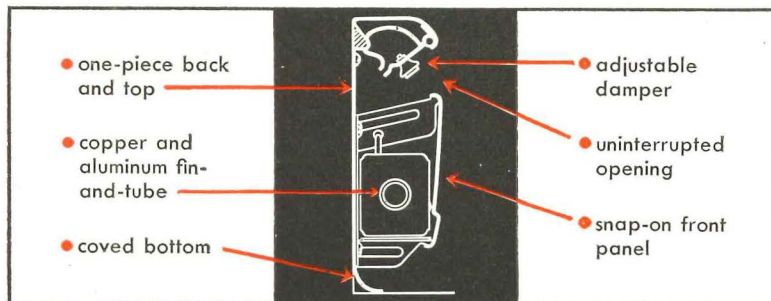

BE HAPPY GO LUCKE

USE

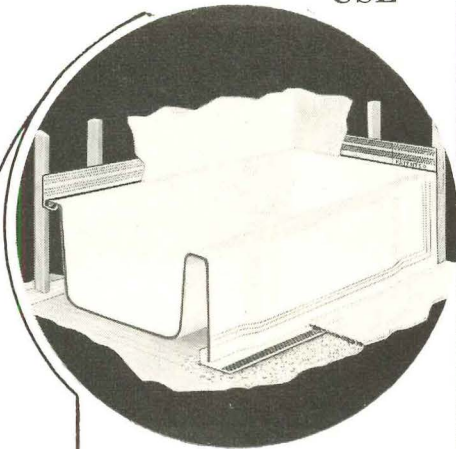

Leakproof LUCKE Bath Tub Hangers

They Offer 5 Outstanding Features

- Eliminates bath tub settling
- Eliminates water damage
- Eliminates repair expense
- Builds tub into the wall. Holds tub firmly for its entire length and width against sagging.
- Assures leakproof protection to ceilings and walls beneath bath.

**WILLIAM B. LUCKE
INC.**
WILMETTE, ILLINOIS
Post Office Box 177

WRITE FOR FURTHER INFORMATION

TECHNICAL PUBLICATIONS *cont'd.*

STRUCTURAL PLASTIC. Resolite Translucent Structural Panels. Resolite Corp., Zelenpole, Pa. 12 pp. 8½" x 11"

A reinforced plastic paneling, *Resolite* is given attractive and informative coverage in this booklet. Renderings show the translucent material utilized as skylighting and partitions. Technical data is presented on *Resolite's* impact resistance, light transmission and installation. An accessory line of molding, closure strips, and flashing is also described.

HEATING. Complete or Auxiliary Electric Home Heating, EC-140. Electromode Corp., Rochester 3, N. Y. 4 pp. 6" x 9"

The two-color folder contains pictures and specifications for the manufacturer's attractively styled wall-type and portable electric heaters in several designs and capacities.

AIR DIFFUSION. A-J Registers, Grilles, Diffusers. A-J Manufacturing Co., 2119 Washington St., Kansas City 8, Mo. 24 pp. 8½" x 11"

This publication catalogues a comprehensive line of crisply designed registers, grilles, and diffusers for heating and air conditioning. It shows photographs of the units, gives specifications and lists prices.

SOIL TREATMENT. Bondite Soil Conditioners for Erosion Control, Monsanto Technical Bull. No. 0-95. Monsanto Chemical Co., Organic Chemicals Div., St. Louis 1, Mo. 8 pp. 8½" x 11"

Describing *Bondite*, a soil conditioner which has been demonstrated to help control rain and wind erosion on construction sites, the booklet explains how this synthetic compound stabilizes aggregates on the soil surface to hold the seed and soil in place until vegetative cover crops can become established. According to the tests described, the conditioner is effective at the rate of 1 lb. per 100 sq. ft. It may be applied in powder form or sprayed in a water solution.

PAINT. The Redi-Blend Guide to Scientific Color Harmony. Adelphi Paint & Color Works, Inc., 86-00 Dumont Ave., Ozone Park 17, N. Y. 2 pp. 14" x 18"

Working with the Munsell system of color notation, in which colors are arranged in the spectrum as tones in a musical scale, Color Consultant William Clark developed this interior decoration guide for harmonizing *Redi-Blend's* 25 flat enamel wall finish colors and intermixes. The chart shows how to work out schemes for a room, balancing tones according to "warm" and "cool" values.

WINDOWS. Truscon Aluminum Casements. Truscon Steel Div., Republican Steel Corp., Youngstown 1, Ohio. 4 pp. 8½" x 11"

The folder contains a detailed description of the manufacturer's new aluminum casement window unit, and includes a chart of types and sizes as well as full-size section details.

continued on p. 256

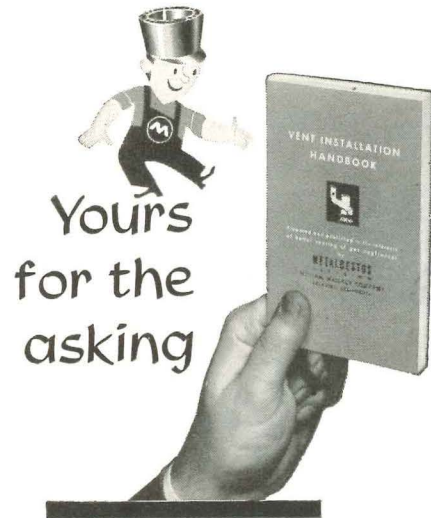

... *this new, authoritative handbook—based on the latest research in gas appliance venting*

When you install gas burning appliances, you'll want this useful handbook containing complete, up-to-date information on gas venting practices plus many helpful installation tips. The findings presented are based on extensive engineering research recently completed by the Metalbestos Division, William Wallace Company, with the assistance of Stanford Research Institute.

Here are some of the subjects covered:

- *Fundamental Rules of Venting*
- *Determining Correct Vent Sizes and Capacities*
- *Choosing the Location of Vertical Vents*
- *Rules for Venting Various Types of Appliances*
- *Vent Installation Tips*

Amplly illustrated throughout—and indexed for convenient reference—this handy pocket-size booklet will be an invaluable aid to anyone who specifies, sells, installs or services gas burning installations.

Send for your copy today! No obligation.



METALBESTOS DIVISION, Dept. F
WILLIAM WALLACE COMPANY
BELMONT, CALIFORNIA
Please send me, without cost, _____ copies of
the VENT INSTALLATION HANDBOOK.

NAME _____ TITLE _____
COMPANY _____
ADDRESS _____
CITY _____ ZONE _____ STATE _____

John Halperin

John Halperin is head of J. Halperin & Company, the country's largest firm of mortgage specialists, with offices in Jamaica, L. I., and Bristol, Pa. He is also president of Community Funding Corporation, which services mortgages totaling \$91,329,217. His organization has financed many outstanding one-family house and apartment developments in the New York and Pennsylvania area.



“Levittown, Long Island, started in 1947 and completed in 1951, has found an extremely active resale market for all of its houses, including those erected first in the community. It is my opinion that this is due to the fact that all of the houses contain nationally advertised materials. In fact, the Federal Housing Administration and the Veterans Administration have allowed present valuations higher than the original valuations... further proof that nationally advertised products help maintain values, create builder prestige and facilitate the sale of houses.”

Reputable builders and financiers stake their reputations in their communities on the homes they build or finance. National advertising is your way of backing up the reputation of your own name in thousands of communities all across the U. S. where these houses are going up.

And LIFE reaches 11,880,000 households in these communities and all over the nation. In the course of 13 issues, LIFE reaches 25,640,000

households—or more than 60% of the entire U. S.*

These LIFE households represent the better half of your market, too. In 13 issues, LIFE reaches 86% of all the households in America with incomes over \$7,000. And more than 58% of LIFE-reading households own their own homes.*

When you advertise your products in America's biggest *big* magazine, you're selling to the world's largest and most receptive magazine audience.

*Figures above are from *A Study of the Accumulative Household Audience of LIFE (1952)*, by Alfred Politz Research, Inc. A LIFE-reading household is one in which one or more of the adult members reads one or more of 13 issues.

The word "LIFE" is written in a bold, white, sans-serif font, enclosed within a thick red rectangular border.

first in circulation
first in advertising
first in the homes of America

ADVERTISING OFFICES: New York • Chicago • Detroit • Boston • St. Louis • Atlanta • Cleveland • Philadelphia • Minneapolis • San Francisco • Los Angeles

Important!

Investigate how FHA and VA regard all purpose rooms as 3rd bedrooms with resultant loan advantages.

Add an "EXTRA" Room without adding to building cost!

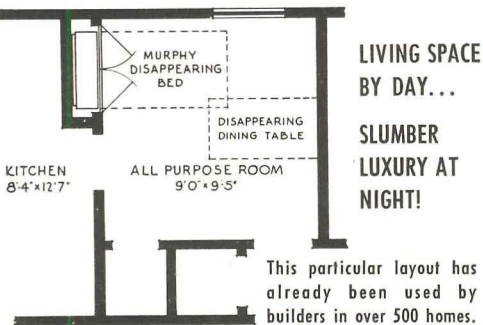
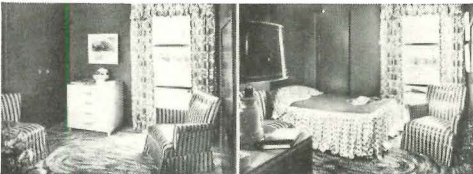

Murphy BEDS

Illustrated above is one of many examples of how ingenious builders everywhere are using Murphy Beds as the answer to the popular demand for an "extra" room.

The Murphy Bed illustrated is only one of several Recess Models, some requiring as little as 13" depth. Other models include Pivot and Roller types. All are built to receive standard mattresses to assure maximum sleeping comfort.

Send today for complete details on all Murphy Bed Models and Murphy Cabranettes (Dwyer Kitchens).

MURPHY BED AND KITCHEN COMPANY, INC.
19 West 44th St., New York 36, New York
Please send free information on Murphy Beds and Cabranette Kitchens.

NAME _____
ADDRESS _____
CITY _____ STATE _____

TECHNICAL PUBLICATIONS cont'd.

STORAGE. Mengel Space-Saver Wall Closets. The Mengel Co., Cabinet Div., Louisville 1, Ky. 12 pp. 8 1/2" x 11"

Prefab wall closets designed to be assembled easily on the job are completely detailed in this full-color publication. The *Space Saver* units are described as a aptable in design. They are available with adjustable shelving and drawers for chest-type storage. Plywood is used for panels, partitions, shelves, and drawers; and kiln-dried hardwood for the frame.

INSULATION. Fiberglas Insulations for Light Construction. Owens-Corning Fiberglas Corp., Toledo 1, Ohio. 20 pp. 8 1/2" x 11"

The attractive booklet covers application data on *Fiberglas* roll and batt blankets, pouring wool, and perimeter-type insulation. It discusses condensation and ventilation and item-

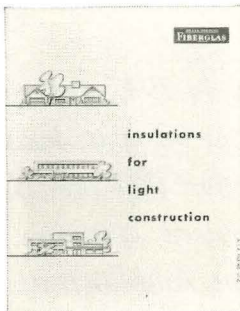

izes several advantages of insulation. Excellent drawings illustrate approved methods for installing the glass-fiber products.

HEATING. Clay Pipe Warm Air Heating Ducts. Clay Sewer Pipe Assn., Inc., 311 High-Long Building, 5 E. Long St., Columbus 15, Ohio. 6 pp. 8 1/2" x 11"

How to design and install warm-air distribution systems with vitrified clay ducts is the story told in this illustrated folder. In addition to basic design data, the guide includes specification information, installation instructions, and two typical layout schemes.

FANS. Broan Kitchen Fans and Bathroom Heaters. Broan Manufacturing Co., Inc., 1669 North Water St., Milwaukee 2, Wis. 8 pp. 8 1/2" x 11"

Illustrating each of the manufacturer's fan and fan-type heater units, the installation guide gives detailed mechanical and electrical data as well as installation details and helpful information on locating kitchen fans for top efficiency.

PLYWOOD. Exciting WedgeWood. Georgia Pacific Plywood Co., 605-B3 N. Capitol Way, Olympia, Wash. 12 pp. 8 1/2" x 11"

Full-color photographs illustrate *WedgeWood*, a textured plywood, as wall paneling in seven room settings. Instructions are included for finishing the moderate cost material with stain or paint to emphasize the grain effect.

We've put everything **YOU** want...

DESIGN FLEXIBILITY
EASE OF CONSTRUCTION
GUARANTEED PERFORMANCE
YEARS OF SERVICE

into these **BENNETT** fireplace dampers

Bennett fireplace engineers . . . specialists in fireplace design for over 25 years . . . have built into these Bennett throat dampers dozens of proven performance and construction features. Whether you're planning a conventional, single opening fireplace, or one of the "unusual" arrangements so popular today—you'll find it easier to design, easier to build with a Bennett Damper!

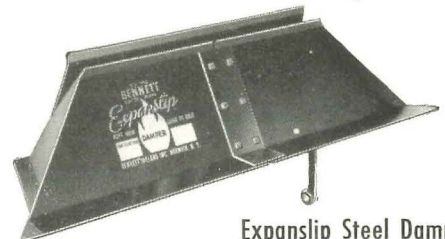

Expanslip Steel Damper

The famous boiler plate steel damper with the exclusive slip-joint feature, which takes up expansion that occurs when damper gets hot. 60° front slope gives sure draft. 8 sizes—up to 72" wide, designed for easy lay-up of brickwork.

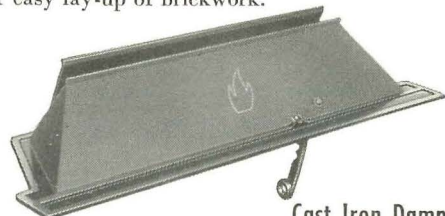

Cast Iron Dampers

Improved, higher-front design assures better draft, better smoke passage. Sturdy cast iron construction, with either cast iron or steel valve. Precision-cast in our modern foundry, Bennett cast iron dampers have no thin spots or weak sections to give trouble. Wide range of sizes.

Beneform
Universal Damper



The amazing new damper that gives you absolute freedom of design expression—at moderate cost. Builds any one of six basic fireplace styles including projecting corners, three-sided openings, etc.

See your Bennett representative

or write Dept. B for free catalog.

BENNETT-IRELAND INC.
Chartered in 1906
NORWICH, NEW YORK