

APRIL 1958 SIX DOLLARS A YEAR—ONE DOLLAR A COPY

House & Home

ARCHITECTS • APPRAISERS • BUILDERS • CONTRACTORS • DECORATORS • DEALERS • DISTRIBUTORS • FHA-VA • MANUFACTURERS • MORTGAGEES • PREFABRICATORS • REALTORS

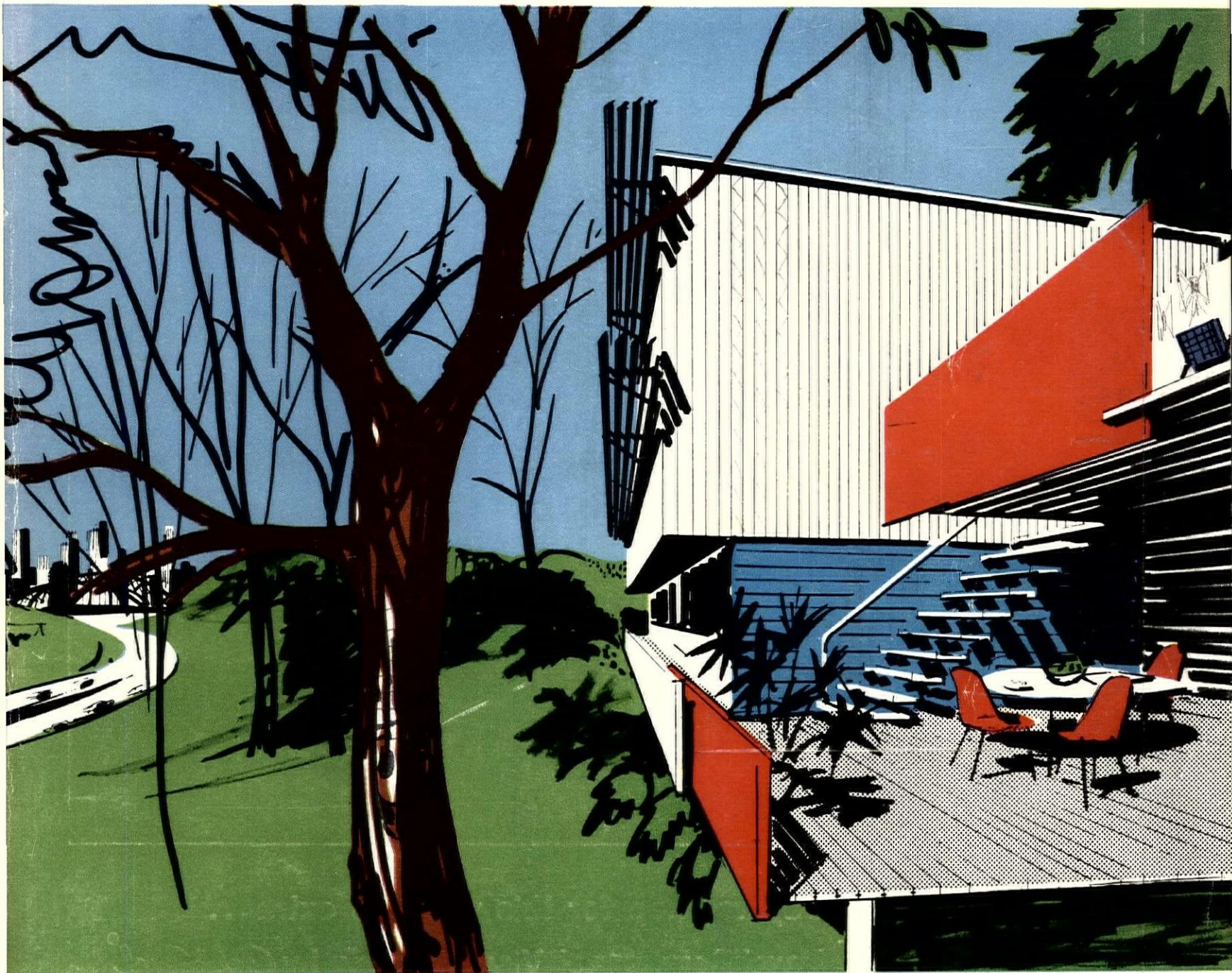

GARDEN APARTMENTS: Look how they've changed since the days of 608, page 108

■ How to make extra profits from rental housing, page 103

When you've got a good house plan, stick with it, page 123

How to decide when your market is turning back up, page 138

Housing for the aged: a new market opens up, page 41



Buyers shop for this valuable extra...

New "Berylstone" Vinyl Flooring by Gold Seal®

For tract units or custom jobs, you'll sell faster with new Berylstone* paving the way. Beautiful for bedrooms. Practical for kitchens. Wherever you use it, this new vinyl makes a terrific impression. "Berylstone" is different... smart! This Gold Seal® Nairon® Standard plastic is a rugged vinyl, too. Its pattern goes deep down, so it keeps its new look for ages. An exclusive Gold Seal finishing process gives "Berylstone" a unique surface gloss and smoothness that's especially easy to maintain. And there's no lining felt needed. "Berylstone"—both tile and yard goods—has its own under-cushion for added quiet and comfort. And it fully meets FHA Title I requirements. See "Berylstone" today!



FOR THE LOOK THAT'S YEARS AHEAD

Gold Seal®
FLOORS AND WALLS

Congoleum-Nairn Inc., Kearny, N. J.

SPECIFICATIONS: May be installed directly on above-grade floors of wood, concrete, or ceramic tile—including those with radiant heating. Available in 6 ft. wide yard goods and 9"x9" tile. Tile may also be installed on-grade.

FOR HOME, BUSINESS, INSTITUTIONS: BY-THE-YARD AND TILES — INLAID LINOLEUM • NAIRON® PLASTICS • VINYLBEST® TILE • CORK TILE • RUBBER TILE • ASPHALT TILE
PRINTED FLOOR AND WALL COVERINGS — CONGOLEUM® AND CONGOWALL® • RUGS AND BROADLOOM — LOOMWEVE® *TRADEMARK SATISFACTION GUARANTEED OR YOUR MONEY BACK

Five Kitchen Features Every Woman Wants ..



- 1 PROTECTION FOR CABINETS OVER OVEN
.. Give Her a NuTone Built-In Oven Hood-Fan
- 2 FRESH, ODOR-FREE AIR IN HER KITCHEN
.. Give Her a NuTone Built-In Range Hood-Fan
- 3 TIDY, UNCLUTTERED KITCHEN COUNTERS
.. Give Her a NuTone Built-In Food Center
- 4 MODERN, TIME-SAVING CONVENIENCES
.. Give Her a NuTone Built-In Intercom-Radio
- 5 CHEERFUL, COLORFUL SURROUNDINGS
.. Give Her a NuTone Built-In Clock & Chime

Frigidaire Appliances

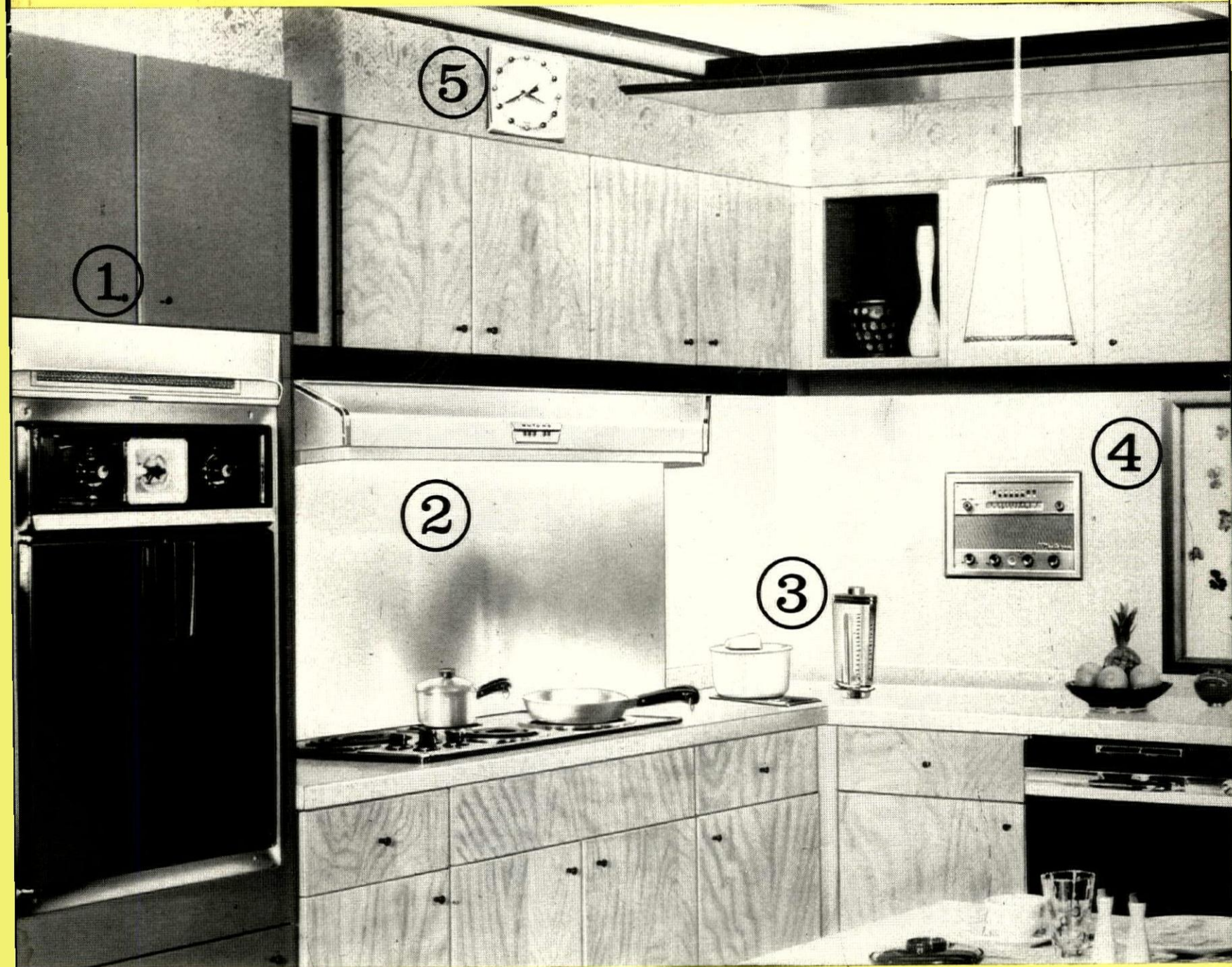

... Sell the Kitchen ... and Sell the Home !

NuTone, Inc., Dept. HH-4, Cincinnati 27, Ohio

Name _____ Firm _____

Address _____

City _____ State _____



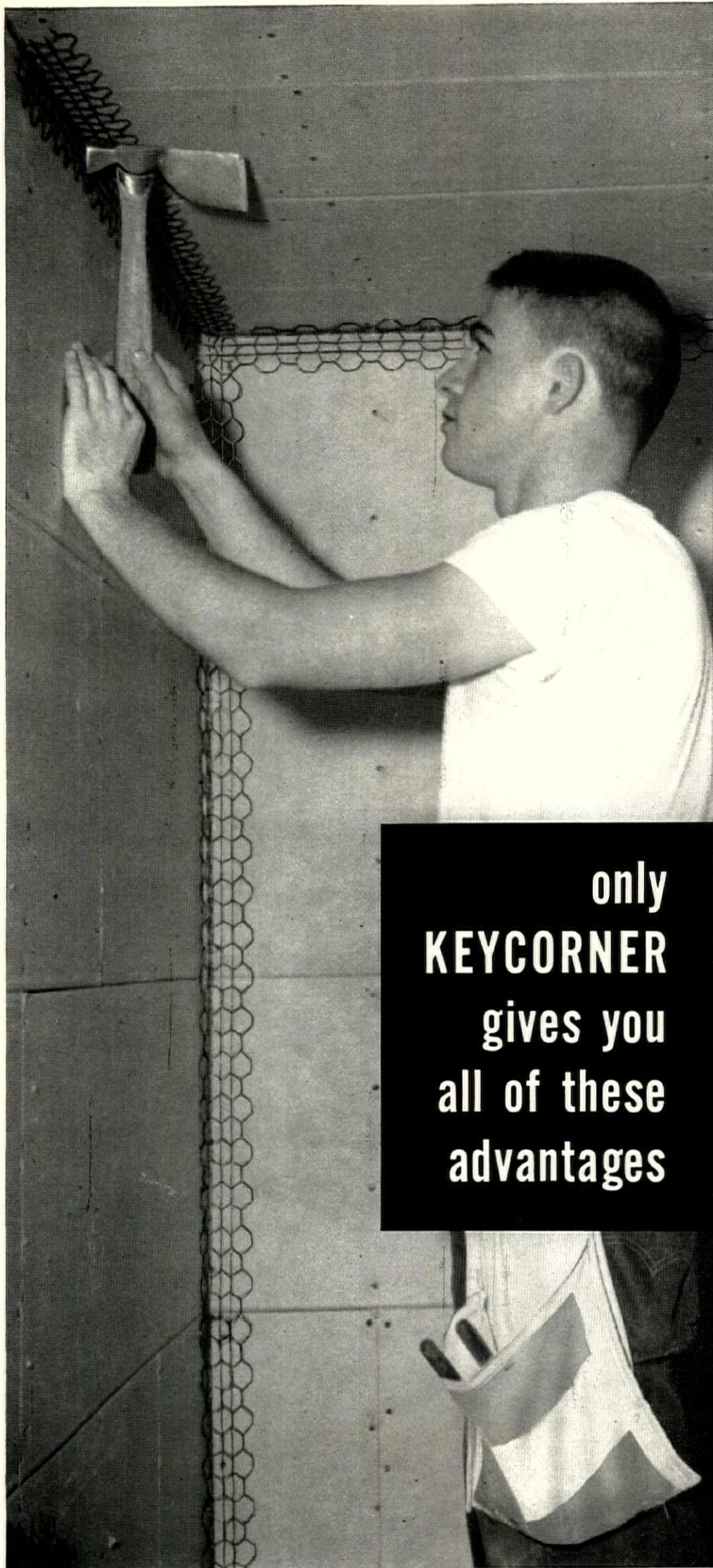

It's here!

KEY

**...at a new,
attractive
price**

**only
KEYCORNER
gives you
all of these
advantages**

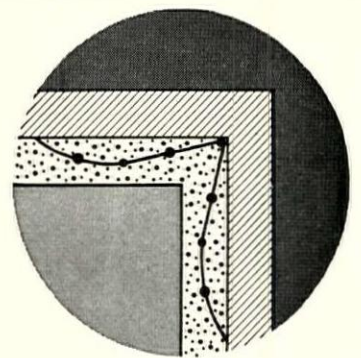

Self-furring—fully embedded—
Flanges of Keycorner are shaped to assure full embedment with effective reinforcement. Snug grip of edges with lath makes it easy to plaster corners.

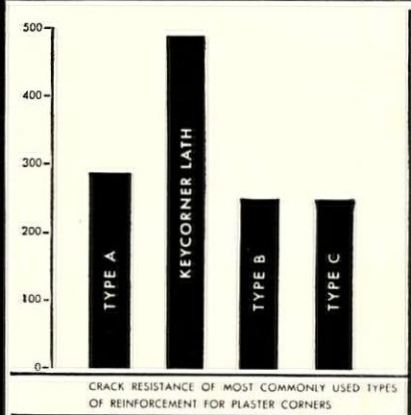

the **GREAT NEW**

CORNER

**GALVANIZED
CORNER
LATH**

Exclusive new features of Keycorner give far greater crack resistance in plaster corners than any other type of reinforcement.

What's more, lathers and plasterers both like it. Lathers like the 4 ft. lengths. The precision fit. The smooth, pliable wire that doesn't cut or tear the hands. The ease with which they can do a craftsman-like job. They like the way it's bundled and packaged for convenient handling and storing.

Plasterers like Keycorner because it's so

easy to plaster over; also because they can take pride in the workman-like corners that are strong, and crack resistant.

Builders like it because they get the highest quality job at a saving.

There are many attractive features about the NEW KEYCORNER. It costs you *nothing* to get the facts. Send for complete information about this new product. Write Keystone Steel & Wire Company, Peoria 7, Illinois.

It will pay
to use the new
Keycorner on all
your plastering
jobs.

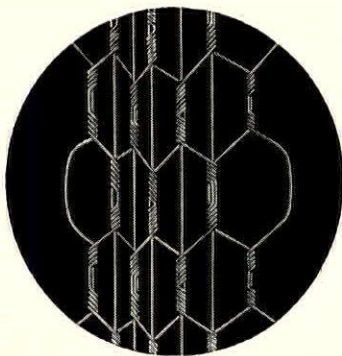

Designed to give maximum resistance to cracking—Spacing of longitudinal wires plus self-furring design adds exceptional crack resistance where needed most; keys plaster if open spaces occur behind Keycorner.

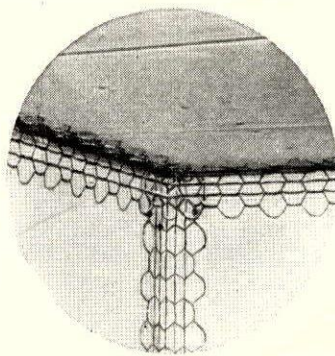

Precision formed—Every piece springs snugly into place. Fits accurately and exactly in corners, giving a truly craftsman-like appearance to the finished job.

plus all of these extra advantages

- Galvanized to prevent rust streaks
- Can be nailed or stapled
- Easy to plaster over
- Smooth wire does not cut or tear hands
- Little cutting required
- Packed in 4'-0" lengths
- Delivered in cartons (65½ lb.) of 1,000 ft.
- Easy-to-handle; easy-to-store

Comparison Test Reveals New KEYCORNER Almost Doubles Crack Resistance

A series of tests on crack resistance of plaster corners was recently completed by Edwin L. Saxer, Professor and Chairman, Civil Engineering Department, Research Foundation, University of Toledo. The chart at left records the results of KEYCORNER, plus those of the other commonly used types of reinforcement tested by Saxer. The results speak for themselves.

You can receive the complete test report by just filling in the coupon.

Department HH-48

KEYSTONE STEEL & WIRE COMPANY

Peoria 7, Illinois

Please send me FREE test report by Research Foundation, University of Toledo.

Name _____

Firm _____

Street _____

City _____ Zone _____ State _____

Now! Add the appeal of the one new appliance every housewife wants*

**and squash
the
costs
of
extra**



NEW Easy UNDER COUNTER **COMBOMATIC WASHER/DRYER**

EASY DOES IT—with the lowest cost per cubic foot Combination you can install! Because it saves more than 14 cubic feet over separate laundry units, you can install the EASY Combomatic exactly where a laundry should be . . . in kitchens, bathrooms, upstairs utility rooms. EASY is easy to install—easy to service through two convenient service panels, without moving the unit. And, it's ideal in *any* upstairs installation because it is

"Sound Conditioned" for quiet operation.

The EASY Combomatic provides *proved* satisfaction! During the past 2 years its design has been proved in thousands of homes. No other Under-Counter Combination can match the EASY record of satisfied users! Use the EASY Under-Counter Combomatic Washer/Dryer for a sure, sales-closing "extra"! Remember, it *saves you money* in extra space costs when you build!

Easy "KITCHEN-LAUNDRY-CENTER" sells new homes!

Let's face it! Refrigerators and ranges don't *help* sell houses like they used to! Today's *real* lure is a *complete laundry in the kitchen area!* The EASY Combomatic Washer/Dryer wins buyers because it is the savingest of all appliances—

saves, time, work, and steps.

And only EASY solves the problem of adding this excitement without adding the costs of extra space. The Under-Counter Combomatic fits anywhere—does a full-size laundry job.





***COMBINATION WASHER/DRYERS
ARE AMERICA'S MOST WANTED
APPLIANCE! '57 SALES SHOW IT!**

Combination Washer/Dryers
UP 72%!

*Name of survey on request.

Separate Washer/Dryers
DOWN 16%!

A recent survey* of 1531 housewives proves women really want a Washer/Dryer Combination. Over 50% said they'd pay more for their housing if it came with a Combination installed. (That was more than twice the number for the next most popular appliance—the dishwasher.)

FITS IN JUST 27 INCHES OF WALL SPACE!



**OVER A
SEPARATE WASHER AND
A SEPARATE DRYER!**

- Washes, rinses and dries family-size 10-lb. loads!
- EASY is Sound-Conditioned for quiet wash, rinse, dry operations!
- Fits in kitchens, closets, bathrooms! Needs no venting!
- *Slides* into place on special tracks for easy installation!

*There's no more profitable appliance
under the sun than the new*

UNDER COUNTER *Combomatic*[®] **WASHER DRYER**

EASY LAUNDRY APPLIANCE DIVISION • The Murray Corp. of America • Palmolive Bldg., Chicago, Ill.

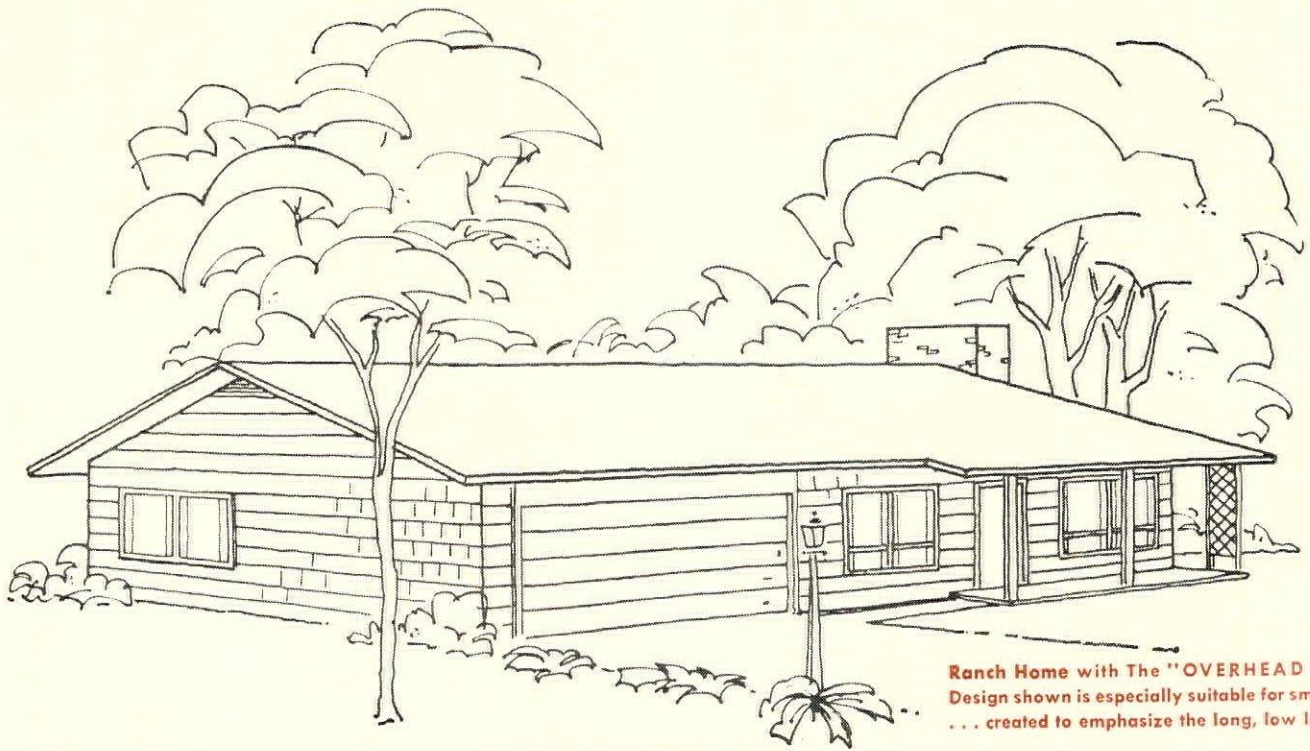

Ranch Home with The "OVERHEAD DOOR."
 Design shown is especially suitable for small homes
 ... created to emphasize the long, low look.

Whatever style you build...

The "OVERHEAD DOOR" demonstrates

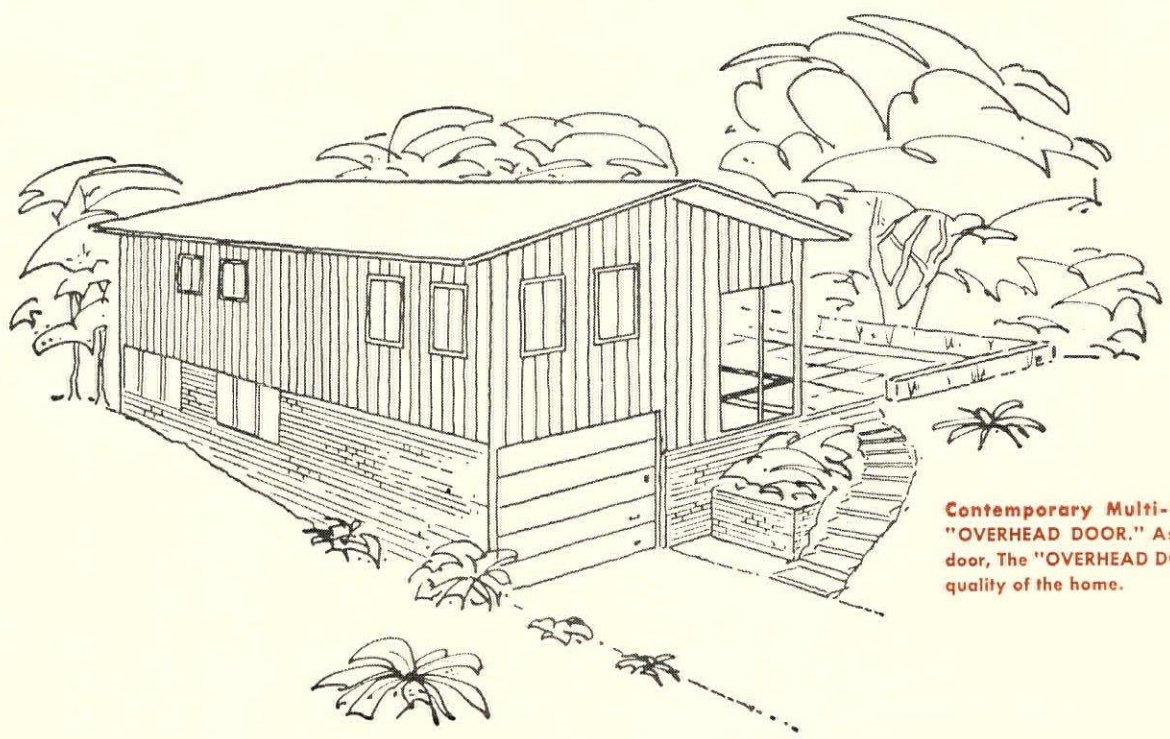

Contemporary Multi-Level Home, with The "OVERHEAD DOOR." As America's finest garage door, The "OVERHEAD DOOR" serves to prove the quality of the home.

Cape Cod Home with The "OVERHEAD DOOR."
 Representing more than 30% of the front of the
 home, The "OVERHEAD DOOR" adds beauty to
 the home . . . lasting living convenience.

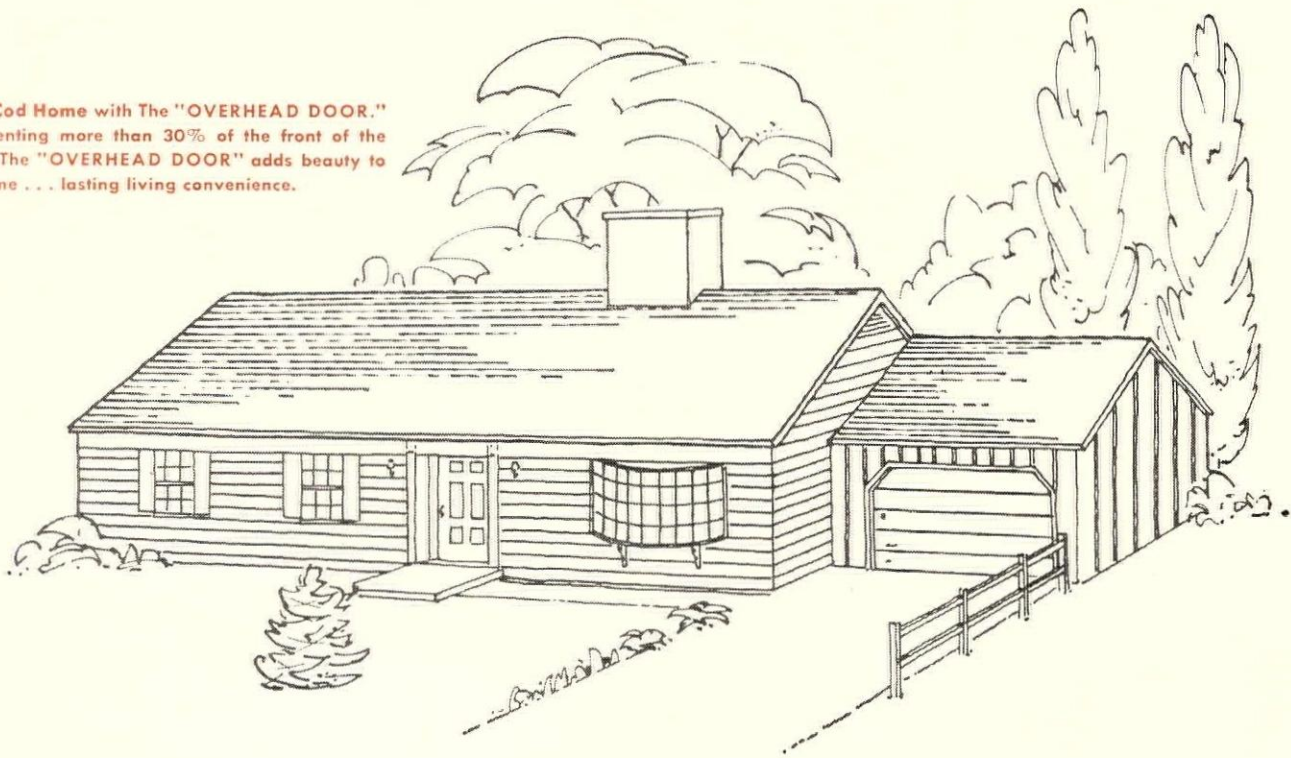

that you're building with the finest!

Sales-wise builders know the value of famous name products—and capitalize on them. As America's best known garage door, The "OVERHEAD DOOR" provides demonstrable proof that you build with the finest brand-name products on the market. In every way The "OVERHEAD DOOR" helps you sell homes. It offers you . . .

- *National Advertising Leadership*
- *Local Newspaper Advertising*
- *Sales Training for Builder Salesmen*
- *Free Literature and Point-of-Purchase Aids*
- *Dramatic Demonstration of Radio Operator*
- *Written Warranty on Materials and Service*

Remember: Overhead Door Corporation and its distributors assume complete responsibility for the performance of The "OVERHEAD DOOR" in every installation. Service provided when needed, parts available on 24-hour notice.

Offering a complete line of doors, including Ultronic operation, in a complete range of styles and prices . . . by America's pioneer and leader in upward-acting sectional garage doors.

OVERHEAD DOOR CORPORATION

GENERAL OFFICES: Hartford City, Indiana

Manufacturing Distributors: Cortland, N. Y.; Hillside, N. J.; Lewistown, Pa.; Marion, O.; Nashua, N. H. • Manufacturing Divisions: Dallas, Texas; Portland, Oregon.; In Canada: Oakville, Ont.

COPYRIGHT 1957, O.D.C.

THE



For 37 years, more people have bought
The "OVERHEAD DOOR"
 than any other brand!

Cut Construction Costs without sacrificing quality

Impossible? Not when Clay Pipe is on the job!

Whether the project is residential, public, or industrial, Clay Pipe is the only pipe that keeps installation costs low *without* sacrificing quality.

New longer lengths and factory-made joints speed up installation . . .

eliminate the need for collaring, mortaring, hot-pouring . . .

cut labor costs. And since Clay Pipe can't corrode, rust, rot, or disintegrate, the first cost is the last.

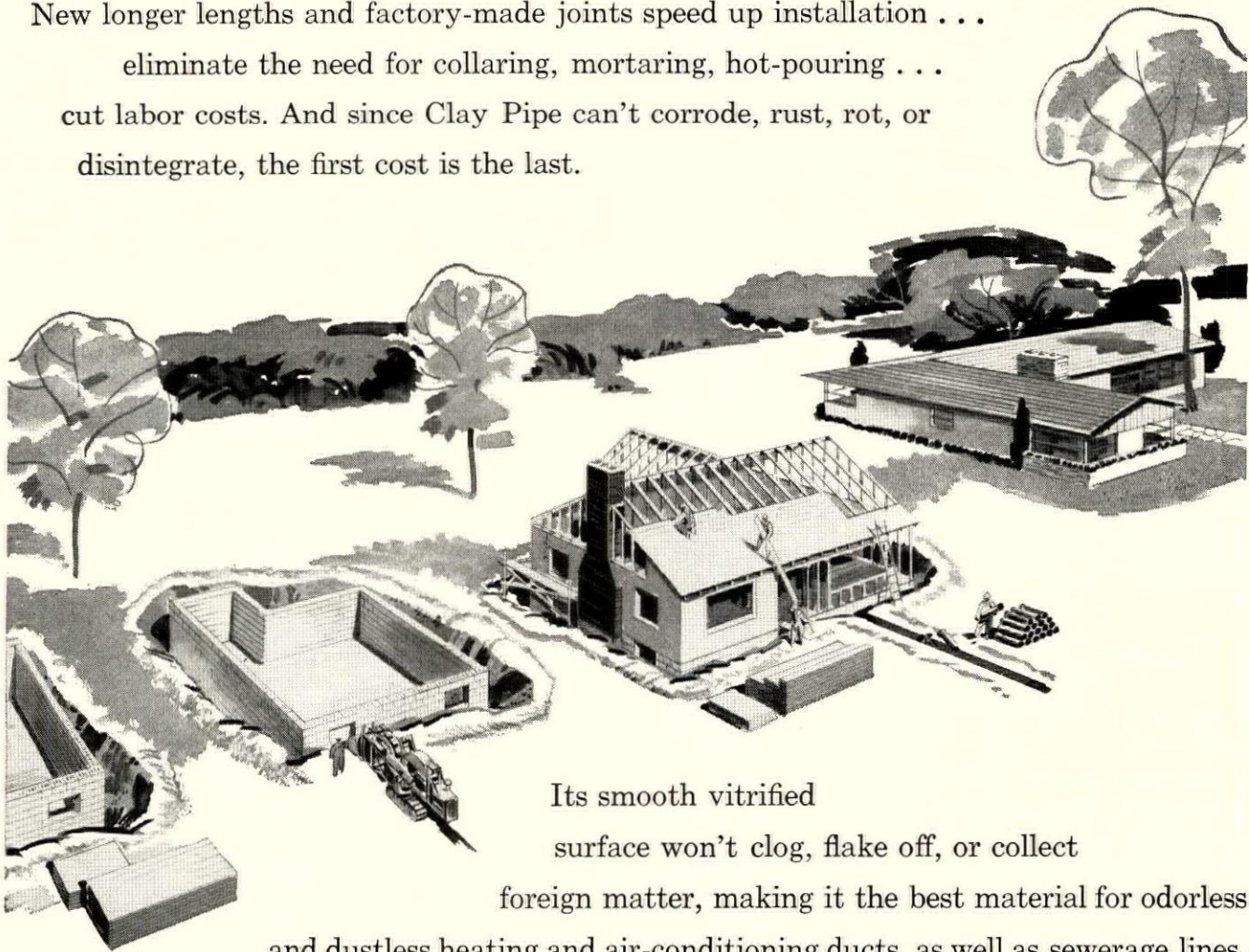

Its smooth vitrified surface won't clog, flake off, or collect foreign matter, making it the best material for odorless and dustless heating and air-conditioning ducts, as well as sewerage lines.

Remember, substitutes may have one or two of Clay Pipe's features . . . but *only* Clay Pipe has *all* the features you can trust.

Vitrified

CLAY PIPE

Never Wears Out

NATIONAL CLAY PIPE MANUFACTURERS, INC. 1820 N Street, N. W., Washington, D. C.
311 High Long Bldg., 5 E. Long St., Columbus 15, Ohio • 703 Ninth & Hill Bldg., Los Angeles 15, Calif. • 100 N. La Salle St., Rm. 2100, Chicago 2, Ill. • 206 Mark Bldg., Atlanta 3, Ga.



increase room spaciousness at no extra cost!

use new **SIGNET MOBILE MIRRORS** by Carolina



Easy does it . . . install the Signet Mobile Mirror in minutes!

Give a dramatic look to a living area . . . add depth to a foyer . . . with Signet Mobile Mirrors!

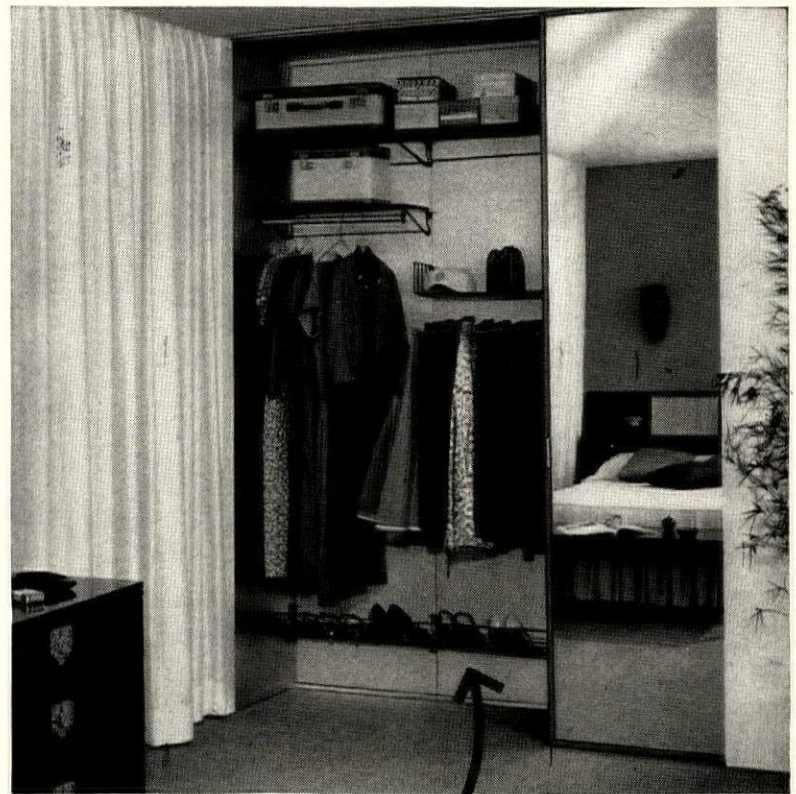

Eliminate the "closet door look" and get full width, full height storage with floor-to-ceiling Signet Mobile Mirrors! Shown with Masonite® Duowall closet interior.

Revolutionary! Spaciousness built in at no extra cost to you! Signet Mobile Mirrors can be floor-to-ceiling in new construction to conceal any storage area (eliminating expensive closet headers) . . . or when remodeling existing doorways they reflect added space to any room. Signet Mobile Mirrors are the *extra* that help sell the consumer today! Installed in minutes. Signet Mobile Mirrors are complete with hanging equipment (with nylon tired, ball-bearing hangers). Over-

head tracks function with either 1-panel wall-pocket or 2-panel by-pass installations, in standard widths from 2'6" to 8', depending on pocket or by-pass type. Libbey-Owens-Ford Parallel-O-Plate is framed in anodized aluminum available in mat black, satin silver, and gold. For more complete information—and your nearest distributor, send the coupon below. Complete literature will be on its way to you immediately.

**Trademark, Carolina Mirror Corp.*

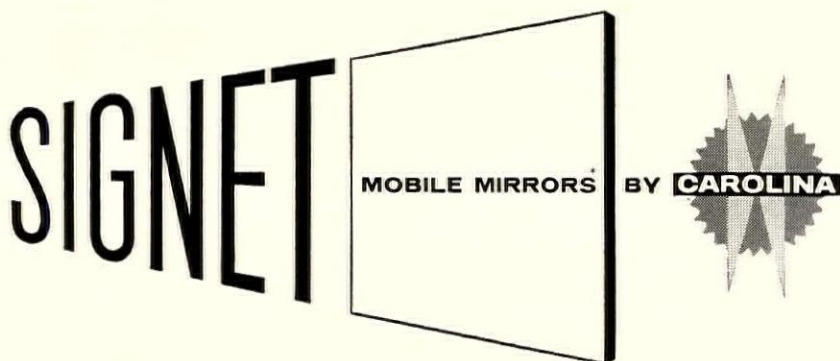

Carolina Mirror Corporation, North Wilkesboro, North Carolina

CAROLINA MIRROR CORPORATION
Dept. 10
North Wilkesboro, North Carolina

Please send me the name of my nearest distributor plus more information on Signet Mobile Mirrors.

NAME _____

ADDRESS _____

CITY _____ ZONE _____ STATE _____

Please attach coupon to your letterhead.

Now! Automation Gives You **UNLIMITED COLOR**

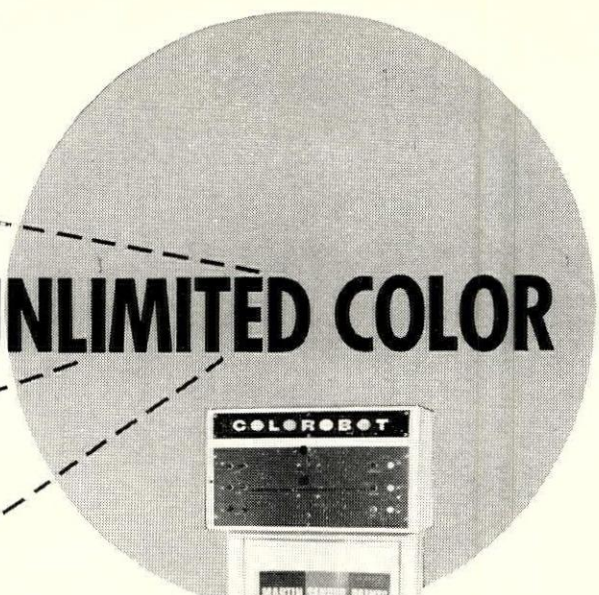
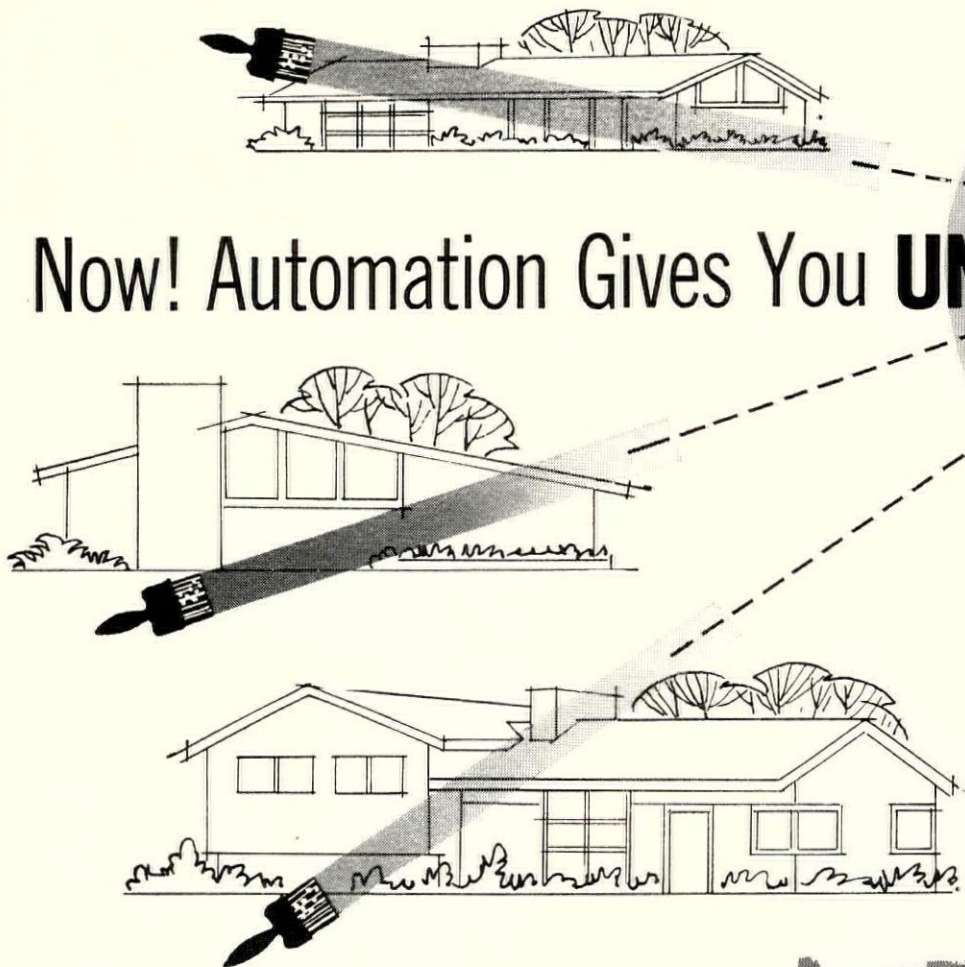

MARTIN SENOUR COLOROBOT

**Frees Taste and Imagination
to Create Superb Results!**

Unlimited Color with the Martin Senour COLOROBOT . . . any paint color you or your customer specify delivered immediately . . . in any quantity . . . with punch card accuracy . . . always the same now, or years from now through the miracle of automation. Freedom of color choice without delivery delay!

Unlimited Color with the Martin Senour COLOROBOT offers new versatility in color selection . . . unlimited color swatches . . . every finish for interior, exterior, or wood stains . . . hundreds of decorator groupings . . . all in Martin Senour's traditional matchless quality.

Unlimited Color . . . This is what Martin Senour COLOROBOT can do for you. See it at your nearest dealer or send today for complete details.



THE MARTIN-SENOUR COMPANY

Dept. HH458, 2500 S. Senour Avenue, Chicago 8, Illinois

**USE THESE OUTSTANDING
COLOR-SELECTION AIDS, TOO!**



COLOROBOT COLOR CENTER displays complete color selection of all finishes . . . interior and exterior . . . that Colorobot delivers immediately.

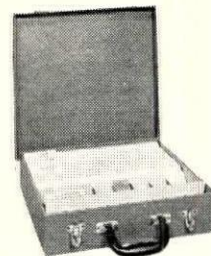

COLOR SAMPLE CASE . . . complete with free replacement swatches. 576 interior colors, 3 types of finishes.



TREND INTERIOR COLOR BOOK . . . 144 indexed swatches (5" x 6") in current home furnishings colors.



TREND COLOR "SLIDE-RULE" designed for architects, decorators and professionals, samples 181 colors.

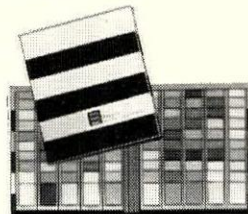

SPECIAL PORTFOLIOS . . . custom made for personalized customer presentation . . . provide permanent record.



TREND COLOR BOOKS . . . contain samples of all available Colorobot colors, interior and exterior.

Plus many other specification guides tailor-made to your needs.

The tougher the market the more you need **BRICK!**

... Smart home buyers, like smart home builders,
understand the values in beautiful brick!



The surveys prove it. Buyers want brick 2 to 1 over a second choice.

Today's selective home prospects want brick's freedom from maintenance, sturdy construction, rich texture and color, fire-safety, and all-season security.

So build with brick and include brick features—because the tougher the market the more you need brick!

FREE SALES SUPPORT WHEN YOU BUILD WITH BRICK

Your prospects are reminded of brick's advantages by constant advertising in magazines like LIFE and HOUSE BEAUTIFUL.

Get these free tie-in sales aids from your brick supplier.



Metal Lawn Signs

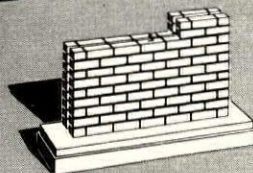

Miniature Demonstration Wall Sections

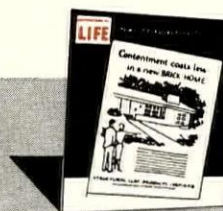

Color Prints of Ads on Easels
... for your counter and model homes

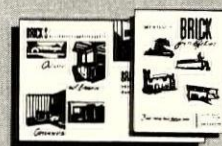

Colorful Giveaway Folders



Lapel Buttons



Book Matches

Your brick supplier will give you these FREE sales aids.

Structural Clay Products Institute

1520 18th Street, N. W., Washington 6, D. C.

New builder designed

FRIGIDAIRE

1958 CUSTOM IMPERIAL FRIGIDAIRE DISHWASHERS

24" Undercounter or Free-Standing, or 48" Dishwasher-Sink Combination models, designed to match the complete family of Frigidaire Appliances.



Custom Imperial model

BRAND NEW DE LUXE MODEL 24" UNDERCOUNTER DISHWASHER

De Luxe in every respect — same full size, same hold-more capacity, same Sheer Look full-width door as Custom Imperial models — to put you out front in home-selling features.

DISHWASHERS

WITH FAMOUS SHEER LOOK...PLUS MATCHING COLORS, MODULAR DESIGN, AND WANTED CONSUMER FEATURES!

The big dishwasher news is Frigidaire . . . new in style, capacity, superb performance and new in "Minute Man" installation. Now, you can build-in, blend-in a full-size Frigidaire Dishwasher wherever it makes a kitchen more efficient, more salable—with less on-site labor cost!

Builder designed 24" modular construction means perfect undercounter fit in standard cabinets. You get complete flexibility of kitchen design with five Frigidaire Dishwasher models — Portable, Custom Imperial Undercounter, Free-Standing, or 48" Sink-Combination, and the all-new Builder De Luxe Undercounter model — to satisfy every home buyer. And every model upgrades kitchens with the consumer-accepted Frigidaire Sheer Look, fashion leader of the appliance industry. You can choose from a rainbow of color to match the mood of

every kitchen you plan with Sunny Yellow, Turquoise, Charcoal Gray, Mayfair Pink, White or optional Satin Chrome finish in some models.

Every detail of new Frigidaire Dishwashers has been engineered with you, the builder, in mind. Plumbing and wiring connections are simplified and separated to speed installation. Drain system is designed for easier connection to high wall or simple gravity drains. Hook-up to a disposer is a snap, with factory-installed flexible adapter that eliminates threading fittings and cuts labor costs. Best of all, new Frigidaire Dishwashers are loaded with better living features for homemakers. See how new Frigidaire appliances can spark up your kitchen-planning and home-selling. Call your Frigidaire Custom Products Representative at the nearest Frigidaire distributing headquarters.

INSTALLS FAST! HOLDS UP TO 48% MORE, WASHES BETTER



Cost-cutting "Minute Man" undercounter installations are easy with sure-fit 24" modular construction and new easy-to-reach wiring and plumbing connections. Even an apprentice helper can follow these simplified steps: (1) Rough-in utilities under counter or in cabinet—clearance 24" W x 34-1/2" H x 24" D. (2) Slide unit into place and connect. Plumbing connections are made on left, wiring on the right—with complete front access for greater safety. (3) Attach bottom panel and the dishwasher is built-in! Optional left or right hand side panels available in choice of color for end-of-counter installation.

No other 24" dishwasher matches new Frigidaire capacity . . . 12 full place-settings *plus* . . . as much as 147 pieces . . . up to 48% more than other leading models checked. And every model has Glide-to-You racks.

Every dish comes sparkle-clean, with Frigidaire Turbo-Spray washing action. All Custom Imperial models have two detergent wash cycles and three rinses, including a special automatic "Spots-Away" rinse.**

*National Electrical Manufacturers Association Standards.
**De Luxe model has a slightly different operating cycle and does not include "Spots-Away" or Dual Detergent Dispensers.

Designed today...for satisfied homeowners tomorrow!

FRIGIDAIRE

Built-ins

FRIGIDAIRE Division, General Motors Corporation,
Dayton 1, Ohio.



Frigidaire—Built and Backed by General Motors

Better-equipped kitchens are a must in today's home-selling market. See for yourself, how much more you—and your home buyers—get with new color-matched Frigidaire Built-in and Free-Standing Appliances—all with the most wanted features and years-ahead Sheer Look—*Plus!*

- FOLD-BACK SURFACE UNITS
- WALL OVENS AND COOKING TOPS
- AUTOMATIC DISHWASHERS
- FOOD WASTE DISPOSERS
- REFRIGERATORS AND FREEZERS
- ELECTRIC RANGES
- WASHERS AND DRYERS
- FULL-HOME HEATING AND COOLING
- ROOM CONDITIONERS

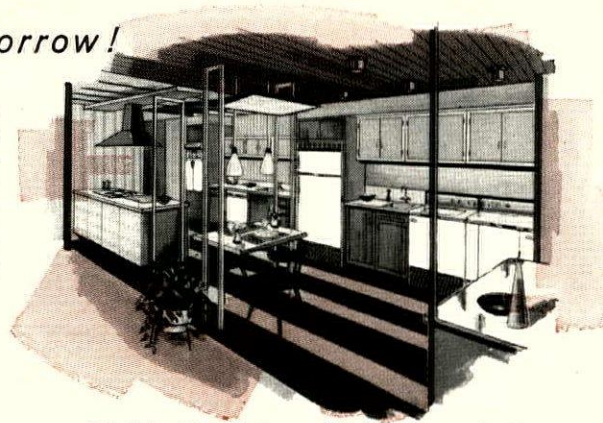

Frigidaire Idea Kitchen — The Sea Star — showing typical blending of new Frigidaire Built-In and Free-Standing Appliances. Cabinets by Mutschler Bros.

AllianceWare...now Slip-Proof



*"Slip-Proof" is an added
matte-finish surface
fired on the tub floor to
increase Bathing Safety
more than 100%
Even In Soapy Water*

100% Safer: AllianceWare's new "Slip-Proof" bathtub — the greatest tub improvement since porcelain-on-steel

*"Slip-Proof" lab-tests prove safety,
comfort, ease-of-cleaning*

You'll close more sales, faster, with these exclusive sales advantages of AllianceWare's new "Slip-Proof" process tested and approved by York Research Corporation.



"Slip-Proof" is as easy to clean and as comfortable as other surfaces of the tub. Optional on any AllianceWare Bathtub, white or colors.

Ask your Distributor Today

About These AllianceWare Exclusives:

Permanent Tub-to-Wall Seal • Straight Tile Lines • Duotone Color Tubs • Double Apron Tubs • Double Bowl Lavatories • Space-Saver Tubs.

FREE CATALOG! AllianceWare Tubs for Every Purpose . . .



All with Optional "Slip-Proof" Surface

Complete product specifications and dimensions on all AllianceWare bathtubs, lavatories, water closets and sinks.

Request on your letterhead today . . . Dept. HH-4.

AllianceWare Permasheen Porcelain-on-Steel Bathtubs, Lavatories, Sinks; Vitreous China Lavatories, Water Closets.
AllianceWare, Inc. • Box 809 • Alliance, Ohio

an  subsidiary



Here's Proof That AllianceWare Cuts Installation Man-Hours By 50%

1. One man can handle, instead of two.

2. Four simple supports to put in.

3. Patented Wall-Hung Installation.

LAYING FLOORS . . . SELLING HOMES . . .



NAIL GROOVE

Lockwood Oak Flooring has the Nail Groove, a great time-saver because it positions the nail and provides seat for nailhead.



TAPERED TONGUE

This End Match is newest improvement in oak flooring design! Lockwood end-matches immediately and snugly. Saves time and labor.



SNAP SIDE-MATCH

Thanks to Snap Side Match design, Cloud's Lockwood Oak Flooring lays up readily, with firm and squeak-free union.

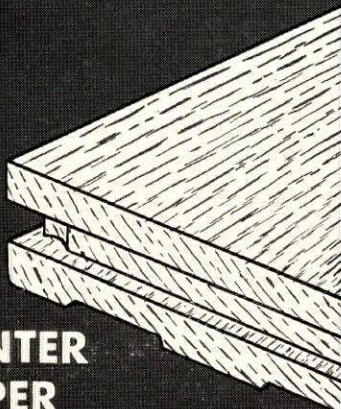

SPLINTER CLIPPER

Lockwood's exclusive Splinter Clipper eliminates annoying chip or spur . . . makes laying faster, easier and more economical!



Lockwood

OAK FLOORING

pays off big!

From the moment you start laying the floor until the contract for the sale of the new home is signed and sealed, Cloud's Lockwood Oak Flooring works for you.

Lockwood Oak Flooring has a host of features that substantially reduce laying-through-finishing costs, boosting your profits by saving you money.

And you can count on it, today's home seekers are looking for oak flooring in their new homes. Oak flooring is easier to decorate around, easier to care for. Lockwood's rich red Ozark Mountain color is warmly accepted for the way it fits in with any decor.

Try Lockwood Oak Flooring . . . then compare notes on every past experience you've had from laying the floor to selling the home . . . and you'll find yourself greatly rewarded!

SEE YOUR LOCAL LOCKWOOD DEALER

QUALITY OAK FLOORING
SINCE 1926



CLOUD
OAK FLOORING CO.
SPRINGFIELD, MISSOURI

We have



More Home for Less Money with

GLIDE-ALL®

Sliding Doors

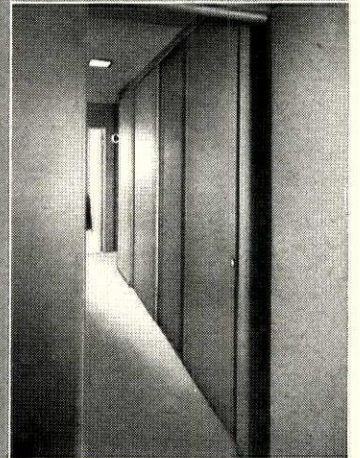
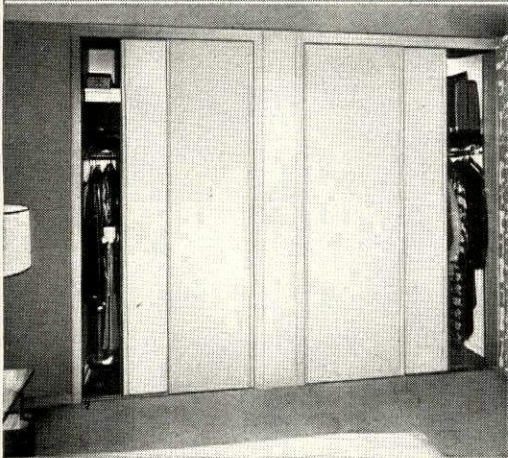
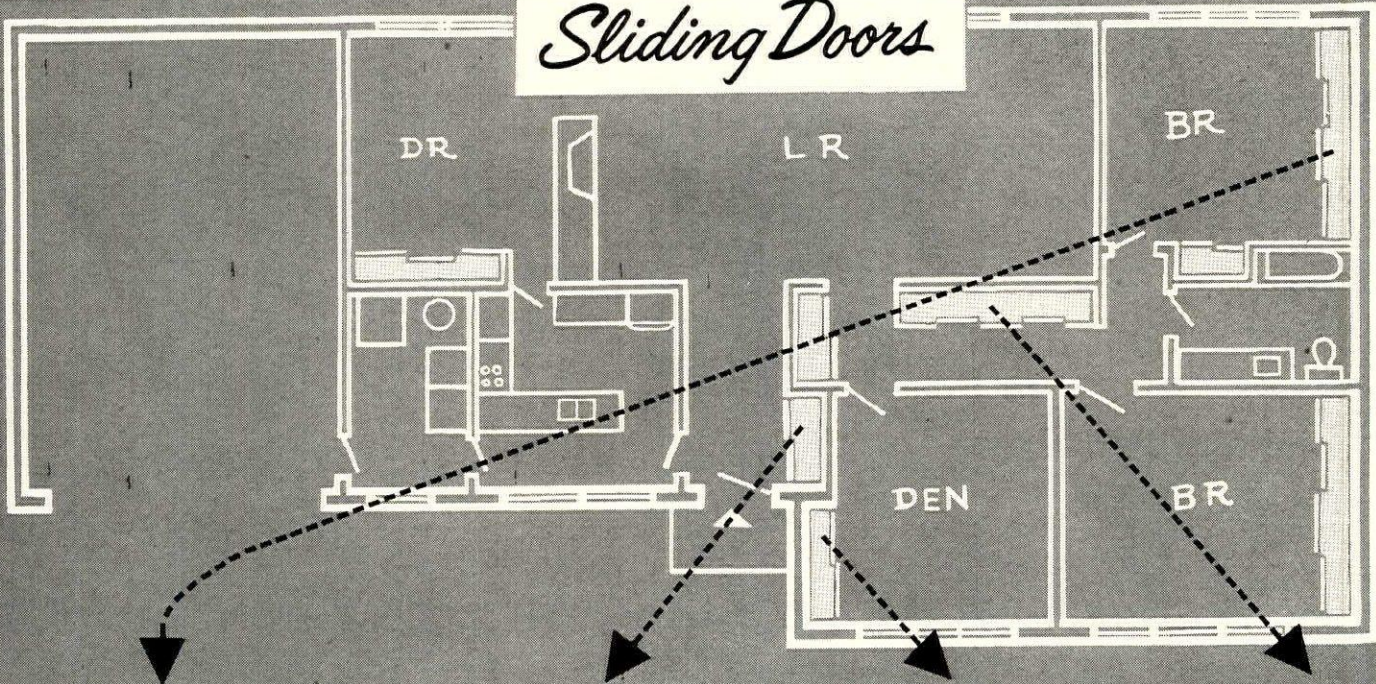

Floor-to-Ceiling • Wall-to-Wall • Entrance-ways • In the Hall!



GLIDE-ALL Sliding Doors supply the answer to "more storage space" at lower cost for these reasons: initial price is low; preparatory construction work is less; installation is easy; adjustments for perfect fitting are simple. And their versatility in stock sizes, heights and widths make them ideal for use all through the house.

When you are planning to build the most house for the least money, plan on using GLIDE-ALL Doors—they come packaged, ready to install, with built-in adjustment features . . . in 8' and 6'8" heights, flush or recessed types . . . and in special sizes for unusual jobs. See "Sweets" or write for complete specifications and details.

GLIDE-ALL Doors are available in principal cities throughout the United States and Canada. For information write Plant nearest you.

GLIDE-ALL DOORS ARE A PRODUCT OF

WOODALL INDUSTRIES INC.

DETROIT 34, MICHIGAN

CHICAGO, 3500 Oakton St., Skokie, Ill.
EL MONTE, Calif., 801 West Valley Blvd.
LAUREL, Miss., P. O. Box 673
SANTA CLARA, Calif., 1020 Bayshore Blvd.

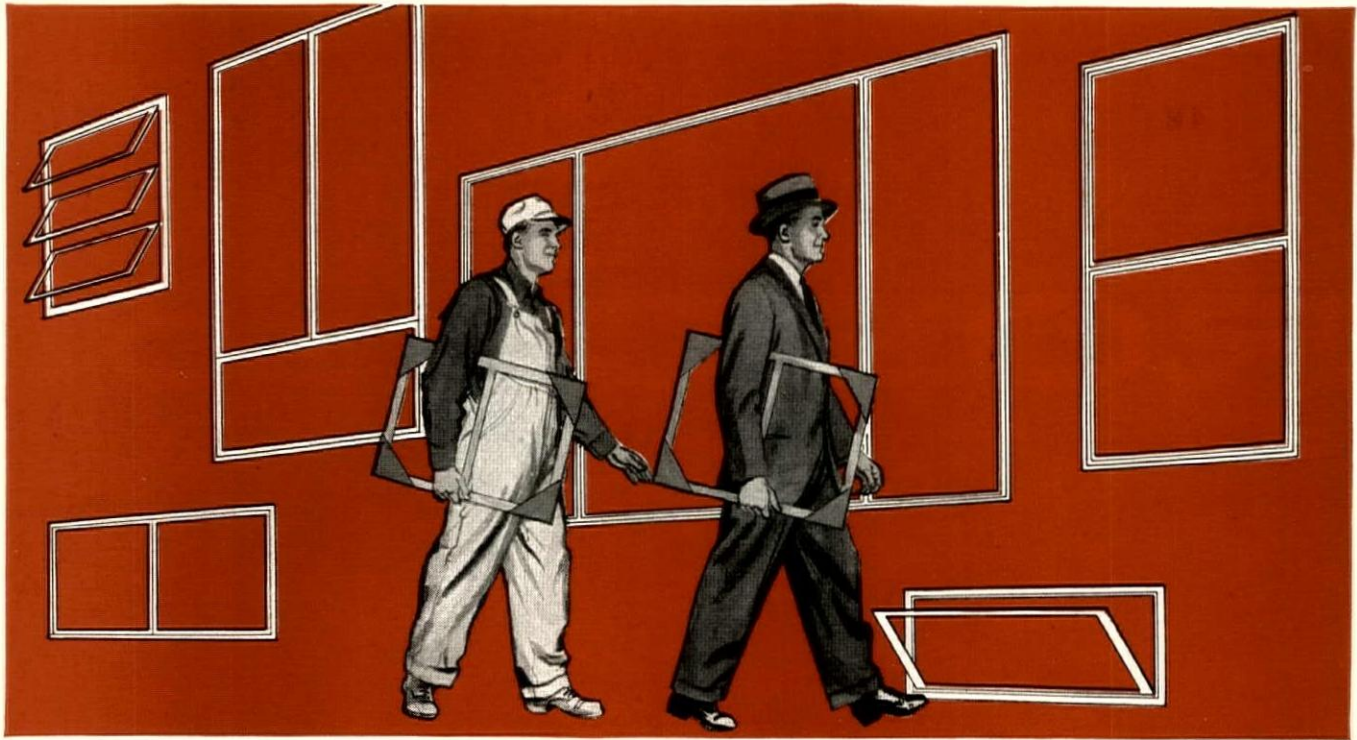

There's a **RUSCO** Size and Style to fit every Window Opening . . . Every Building Budget

RUSCO Windows are shipped to you in complete packaged units. They install in minutes . . . eliminate on-the-job painting, glazing, later adjusting or repairing. Made of hot-dipped galvanized steel with a baked enamel finish for greatest durability or economical aluminum.

- RUSCO's "Easy-Slide" design with felt lined slides eliminates sticking or rattling.
- Decorator colors to blend with any color scheme or satin finish aluminum.
- RUSCO Fiberglas® screen won't rot, corrode or stain and never needs painting.
- All sliding glass panels are removable from inside for easy, safe cleaning.



RUSCO's national ads are pre-selling thousands of new home prospects!

"Always one step ahead of the weather" with

RUSCO

SEND FOR THIS FREE ILLUSTRATED CATALOG!



New Optional Dual Glazing Gives Factory-Made Storm Protection
at 20% Less Cost

1. Maximum cold weather protection plus full year 'round filter screen ventilation.
2. No separate storm sash to change and nothing to store!
3. Up to 1/3 fuel savings when RUSCO windows are installed.

F. C. RUSSELL CO.
DEPT. 1-4 • COLUMBIANA, OHIO
(In Canada: Toronto 13, Ontario)

Gentlemen:
Please send me a copy of RUSCO's Illustrated Prime Window Catalog.

Name _____

Firm _____

Address _____

City _____ Zone _____ State _____



Again in '58

BRYANT LEADS THE WAY WITH NEW

ROBO-trol

HEATING

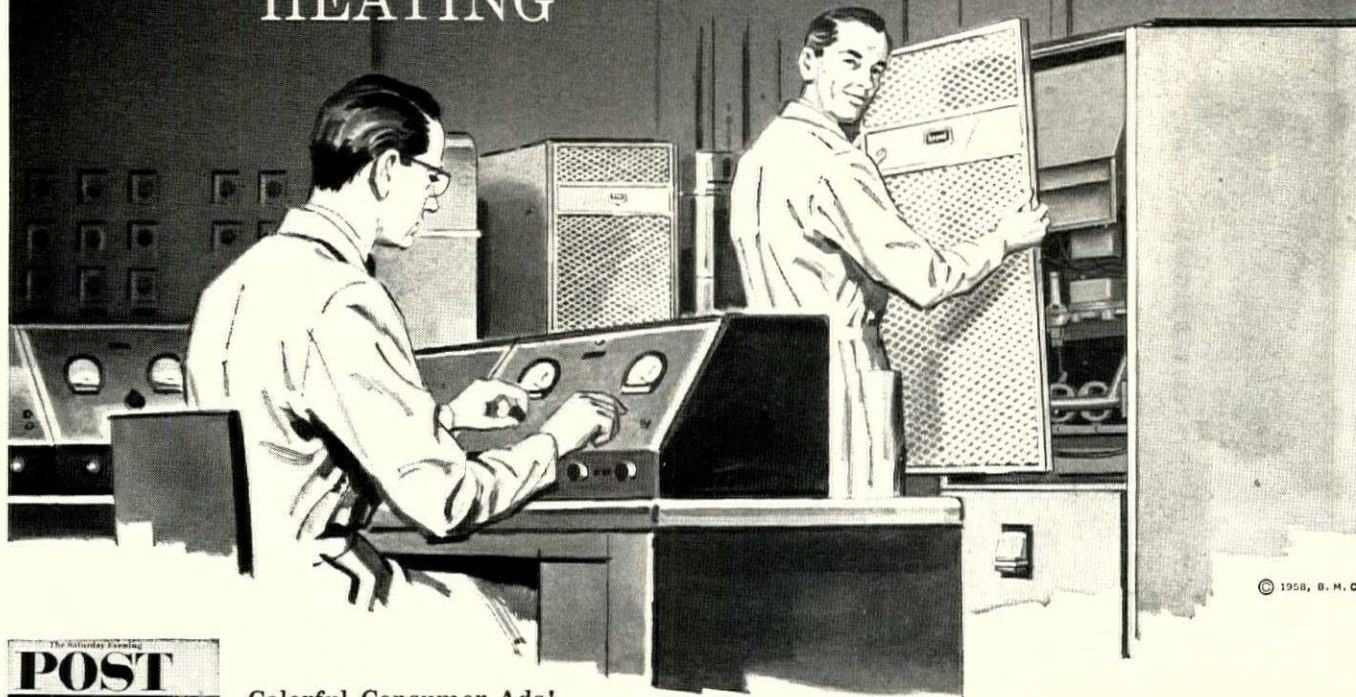

© 1958, B. M. C.



Colorful Consumer Ads!

We're sparing no expense to tell home owners about ROBO-trol! Typical of the persuasive consumer advertising is a two-page spread in full color in THE SATURDAY EVENING POST, to be read by millions of the very best potential customers.

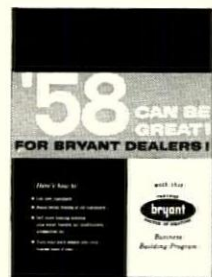

A Complete Dealer Kit!

We're going all out to help Bryant dealers achieve their greatest sales-and-profit-making year. Every certified Bryant dealer will receive this kit containing newspaper mats, radio commercials, direct mail and hand-out literature, with complete instructions for their most advantageous use! Ask your Bryant distributor about the Bryant Certified "Doctor of Heating" Program.

This new Bryant electronically controlled heating system is sensational from every angle . . . and we're making certain that Bryant dealers will cash in on it. Powerful Bryant consumer advertising will acquaint the public with the amazing new advantages of ROBO-trol . . . and Bryant dealers will have the sales helps and promotional material to take full advantage of it! ROBO-trol provides Bryant dealers with the greatest sales-winner since 1907, when Bryant produced the first successful automatic gas heating system in the world. For complete information, write us today.

BRYANT MANUFACTURING COMPANY, Indianapolis, Ind.
Bryant Manufacturing, Ltd., Toronto, Canada

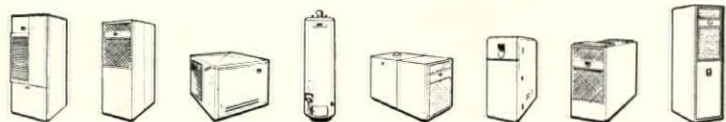

AMERICA'S FOREMOST SPECIALISTS IN RESIDENTIAL HEATING, COOLING AND WATER HEATING

NEW



12" and 16"

Bevel Siding with Phenolic Resin Surface and 1/2" Rabbet Joint!



"GPX YELLOW" saves paint time — helps paint last 5-10 years! Tough, phenolic resin surface needs no sanding or sealing, prevents surface checking. One coat each of primer and finish is superior to three coats of paint on other siding!



Self-aligning lap slashes installation time! Only first course needs leveling. Solid lumber back nails flush to wall, eliminates furring strips, wedges. Ends butt tightly without mastic. No splitting, no waste.

1/2" Rabbet gives 96% net coverage! This new siding is completely weather-tight with only 1/2" lap! And it can save you up to \$40 per M sq. ft. over other kinds of bevel siding, on coverage alone.



Protective packaging! Heavy-duty G-P carton contains 64 ft. Easy to store, one man can handle. Keeps siding clean and damage-free until used.

GPX[®] YELLOW BEVEL SIDING

made only by 

GEORGIA - PACIFIC

Lumber & Hardboard · Pulp & Paper
World's largest producer of Plywood & Redwood

Call your G-P dealer or send coupon for information.

GEORGIA-PACIFIC

Dept. HH 458 Equitable Bldg., Portland, Oregon

Please send me complete information on GPX Yellow Bevel Siding.

NAME _____

ADDRESS _____

CITY _____ STATE _____

New! Alcoa Aluminum Gutters and Downspouts

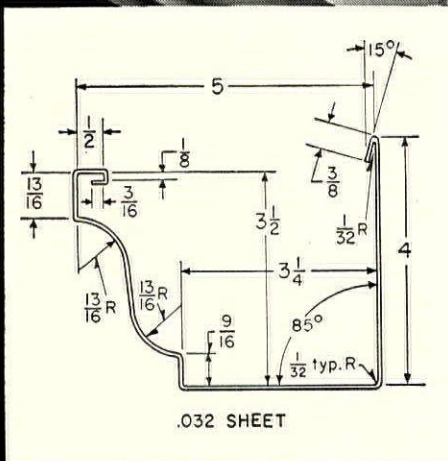
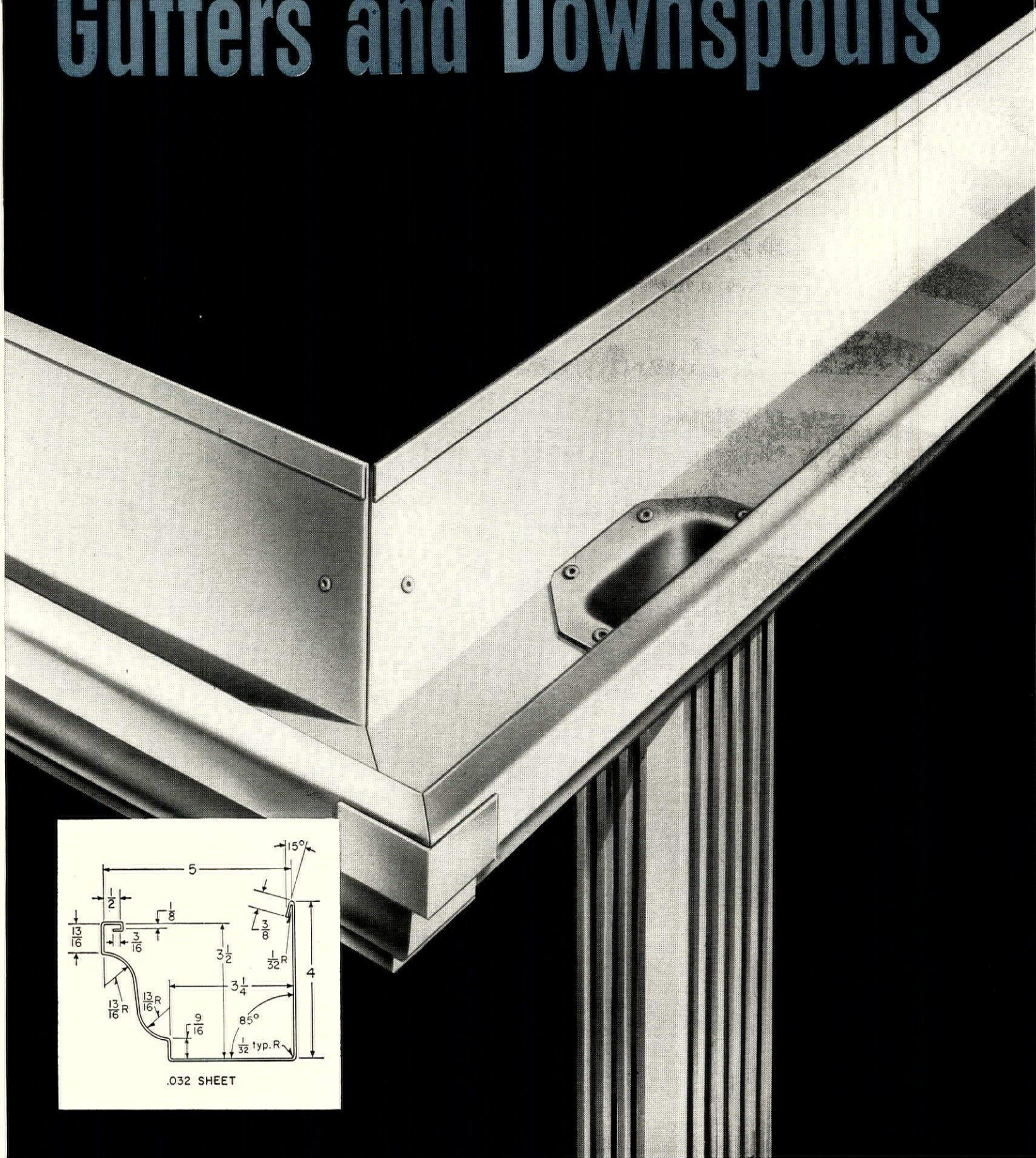

A Riveted and Cold-Sealed Joint System that Installs Faster, Easier, at Competitive Cost

extra-heavy aluminum • precision fitting • easy to work with

Now you can offer your customers a high-quality riveted metal installation at no extra cost. Designed and made exclusively by Alcoa, this entirely new gutter and downspout system provides aluminum's rust-free and corrosion-resistant advantages with a new, fast method of on-the-job riveted and sealed joints. The Alcoa system is rigid, watertight—stays new-looking longer, while providing dependable, year-in and year-out service.

Extra Length, Extra-Heavy Gage, Precision-Formed Gutters

The strongest gutter on the market—full .032" thick! For faster, neater installations, 16-foot lengths. Precision-formed with tolerance held to $\frac{1}{64}$ " for tight, leakproof fits and better appearance. The OG gutter is designed with a front bead for added rigidity and strength throughout. Back of the Alcoa gutter is one-half inch higher than the front for protection against overflow.

Specially Designed Hanger System Permits Free-Floating Gutter

Installation is simplified through the use of two entirely new types of hangers—roof-type apron hanger for new construction, fascia-type apron hanger for remodeling work. Both allow gutters to contract and expand with seasonal temperature changes. Thus, the major cause of leaks is eliminated by this "free-floating" action.

Simplified Fittings—One-Third Fewer Pieces Needed

Gone are the old-style corner and downspout sections, slip joint connectors, gutter spikes and hot soldering. Alcoa end caps and miter joint covers give a neater job, fit snugly. The downspout drop tube is placed where desired after the gutter is hung. An Alcoa system goes up much faster and simpler because fewer fittings are commonly required.

Newly Developed Riveting and Sealing Method

Installation is further speeded up with this new procedure. For example, gutters are joined and sealed simply by overlapping two inches, applying the Alcoa® Gutter Seal and riveting with the Alcoa "pop" riveter. Alcoa's patented Gutter Seal is the result of exhaustive testing and research. Once applied, it stays watertight. This is an exclusive new Alcoa product.

Ask your distributor or local metals supply house for new Alcoa Aluminum Gutters and Downspouts. Send for detailed information.

For more complete information about the new Alcoa Rain Carrying System, including installation data, mail coupon.

Aluminum Company of America, 1969-D Alcoa Building, Pittsburgh 19, Pa.

Name _____

Firm _____

Address _____

City _____ State _____



"ALCOA THEATRE"—Exciting Adventure, Alternate Monday Evenings

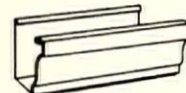

OG Gutter

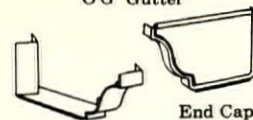

End Cap

Miter (outside-inside)



Rectangular Downspout



Eave Tube

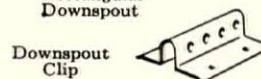

Downspout Clip

FOR REMODELING

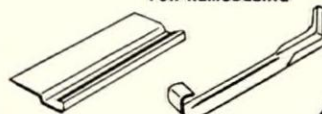

Fascia Apron

Bar Hanger

FOR NEW CONSTRUCTION

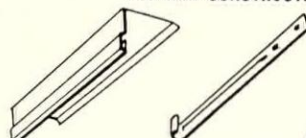

Roof Apron

Strap Hanger

POPULAR STYLES AND FINISHES Standard 5" Size Only

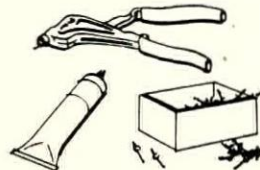
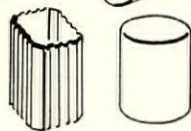

ALCOA
ALUMINUM
ALUMINUM COMPANY OF AMERICA

FOR A
Care-free Home

Here's the sign that stopped us!



NEW MODEL
NEW LOW PRICE

Electro-Klean®

ELECTRONIC HOME AIR FILTER

Built and Backed by American Air Filter . . . World's Largest Manufacturer of Electronic Air Filters

"I imagine every woman has dreamed about a home that would keep itself clean . . . tables that would dust themselves . . . walls that would keep their new look . . . rooms that would automatically 'clean themselves'. I've dreamed of such a home, too, but I never expected to find it!

"That's why this sign stopped us. We could hardly believe that now automatic house-cleaning is here, at a price we could afford!

"The salesman showed us how a simple electronic device, attached to the furnace or central cooling unit, drew up to 20 times more dirt particles out of the air than throw-away filters. It was easy to understand how Electro-Klean could prevent thick layers of dust from collecting on furniture, walls and windows by trapping it from the air. Naturally the Electro-Klean gets bacteria laden dirt and pollen, too. I understand that doctors use Electro-Klean for relief of allergy troubles.

"When we found that automatic house-cleaning added less than two hundred dollars to the cost of a home, we were sold!"



"Imagine . . . this addition to our furnace will house-clean every room in the house, every day!"

Electro-Klean is a compact, "package" unit that may be quickly installed on the return air side of any forced air furnace or air conditioning system, using existing ducts. There are no water or sewer connections. Electro-Klean traps airborne dust and pollen like a magnet attracts and holds bits of iron.

Electro-Klean provides a tremendously effective selling point for your homes at low cost. It is backed by a national promotion program that will pre-sell your best prospects. Localized promotional material and plans will help you reap the benefits of this outstanding new and exclusive selling feature.

Electro-Klean is a product of American Air Filter Co., oldest and largest manufacturers of electronic air filters. It is backed by more than 30 years' air filtration experience.

Investigate Electro-Klean today. Be first to offer this amazing new selling point — "homes that house-clean themselves". Write for details of promotion plan and Electro-Klean prices.

American Air Filter Company, Inc.
209 Central Avenue,
Louisville 8, Ky.

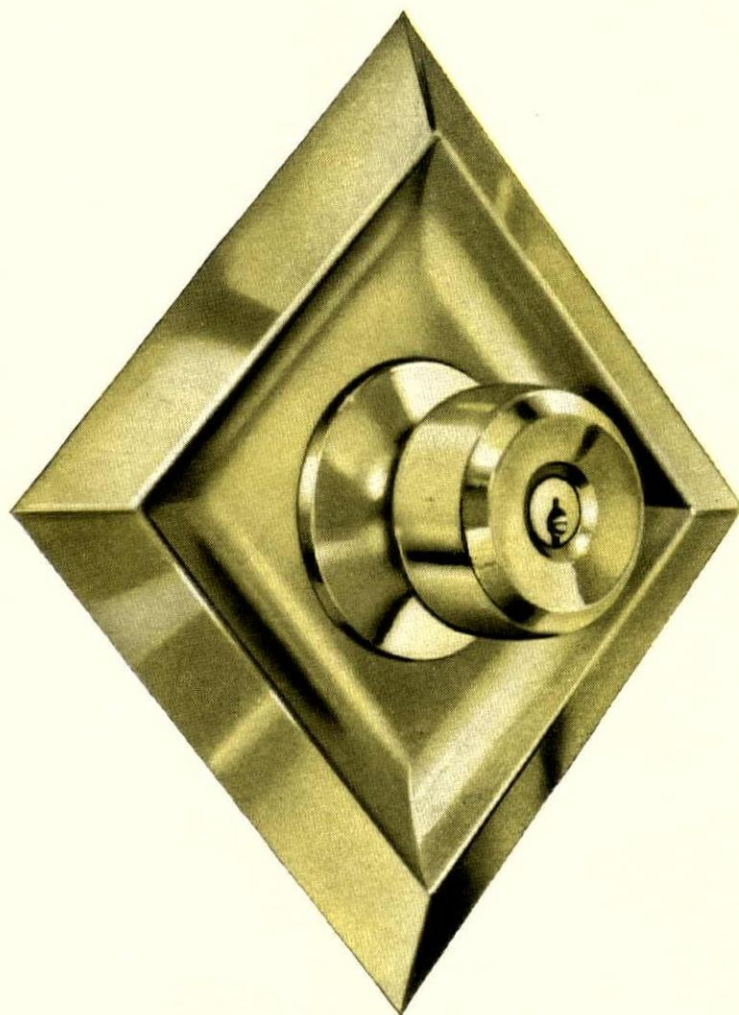

Troublefree service . . .

the part of its value you don't see

There's more to the value of a lockset than meets the eye. There's the matter of engineering and materials that go into its construction. Sound engineering and quality materials help assure long life, positive security and dependable service. Remember, "call-backs" for repairs are costly. That's why, so often with cheap brands, the first cost is not the last cost. Quality construction . . . fresh, smart styling . . . competitive price tag . . . these are the factors that make NATIONAL LOCKset "America's Outstanding Lockset Value". Ask your building material supplier.

Illustrated is Doric knob with Square escutcheon. Can be mounted as square or diamond for 5" or 18" backset.



Specify it with confidence . . . Install it with pride

NATIONAL LOCK COMPANY

ROCKFORD, ILLINOIS



MERCHANT SALES DIVISION



CRA MEMBER MILLS:

Georgia-Pacific Corporation
(Hammond-California Redwood Division)

Holmes Eureka Lumber Company
Redwood Sales Co., Eastern Distributor

The Pacific Lumber Company

The Pacific Coast Company

Simpson Redwood Company

Union Lumber Company

Willits Redwood Products Company
Hobbs-Wall Lumber Co., Sales Agent

Arcata Redwood Company



Carlton Stelner, Architect

Phil Palmer, Photo

THE REDWOOD MOTEL invites the passing motorist...
its warmth of color and texture promises a restful home away from home.
Motels of redwood from coast to coast beckon the traveler... motels built
with CRA Certified Kiln Dried redwood... graded, milled
and seasoned by the member mills of the

CALIFORNIA REDWOOD ASSOCIATION • 576 SACRAMENTO STREET • SAN FRANCISCO 11, CALIF.

OFFER YOUR BUYERS BUILT-IN WINDOW PERFORMANCE



THE MODERN LIF-T-VIEW STYLE

"Built-Ins" do help sell homes. Prospects become buyers when they see *extra* features at no extra cost.

The built-in performance features of R·O·W windows can be demonstrated convincingly. Beautifully balanced with R·O·W LIF-T-LOX, they lift out immediately for safe and easy cleaning. Spring-pressure weather seal is built in, too. No other windows can match the built-in performance of R·O·W Removable wood windows.

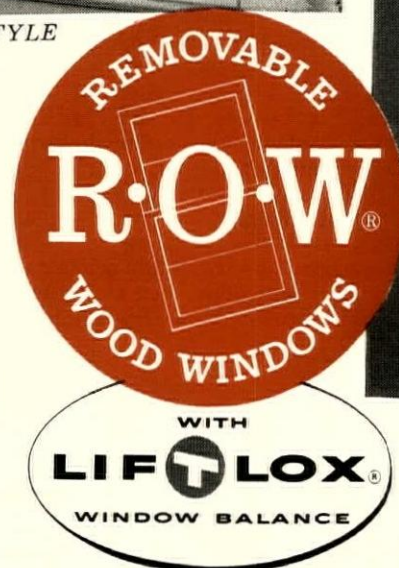

R·O·W and LIF-T-LOX are the registered trade-marks of the R·O·W Sales Company

See your local lumber dealer or write

R·O·W SALES COMPANY • 1328 ACADEMY • FERNDALE 20, MICHIGAN



LOCK

the front door

THE FIRST DAY

Your Inland Home *goes up* . . . walled-in, roofed-over and safely locked . . . the day the truck delivers the package!

From the moment you check the Inland Component Package Price List and plan your package, you are in *complete control* of your building operation and of all *costs*. All Inland packages and components are clearly priced and covered by *one invoice*. You know your costs before you build and you can figure your profit right from the start. No changes, delays, wastage or pilferage will eat it up.

Inland offers a wide selection of models for basement, crawl-space or slab, 2, 3 or 4 bedrooms, 1 or 1½ baths, carports, 1 or 2 car garages. Factory-assembled room-size exterior wall sections, 2 x 4 studs, 16" o.c., with factory-applied primed siding, double-course cedar shakes or boards and battens. Double-hung windows, exterior doors, hardware installed. Complete gables, assembled trusses, plywood roof sheathing, asphalt shingles.

Exterior doors, trim, cornice, soffits prime painted. Factory-assembled interior partitions, 2 x 4 studs, 16" o.c. Fiberglas insulation. Youngstown Monterey kitchen cabinets and

dishwashers, Tappan built-in ovens and countertop ranges, Westinghouse Space-Mates washer-dryer combinations, Modernfold doors, Overhead garage doors.

More than 200 Inland Home Packages, all clearly priced, give the variety you need to sell practically any home buyer. Our two plants give you quick delivery. Through Inland Mortgage Corporation, we offer financing plans to fit all builders' needs.



Let's get together. Get our *new* 1958 Component Package Price List. Visit, call or write either of our offices. Inland Homes Corporation, Box 915, Piqua, Ohio (Phone 3880) and Box 137, Hanover, Penna. (Phone Melrose 7-6681).

INLAND HOMES

Inland[®] Homes
CORPORATION

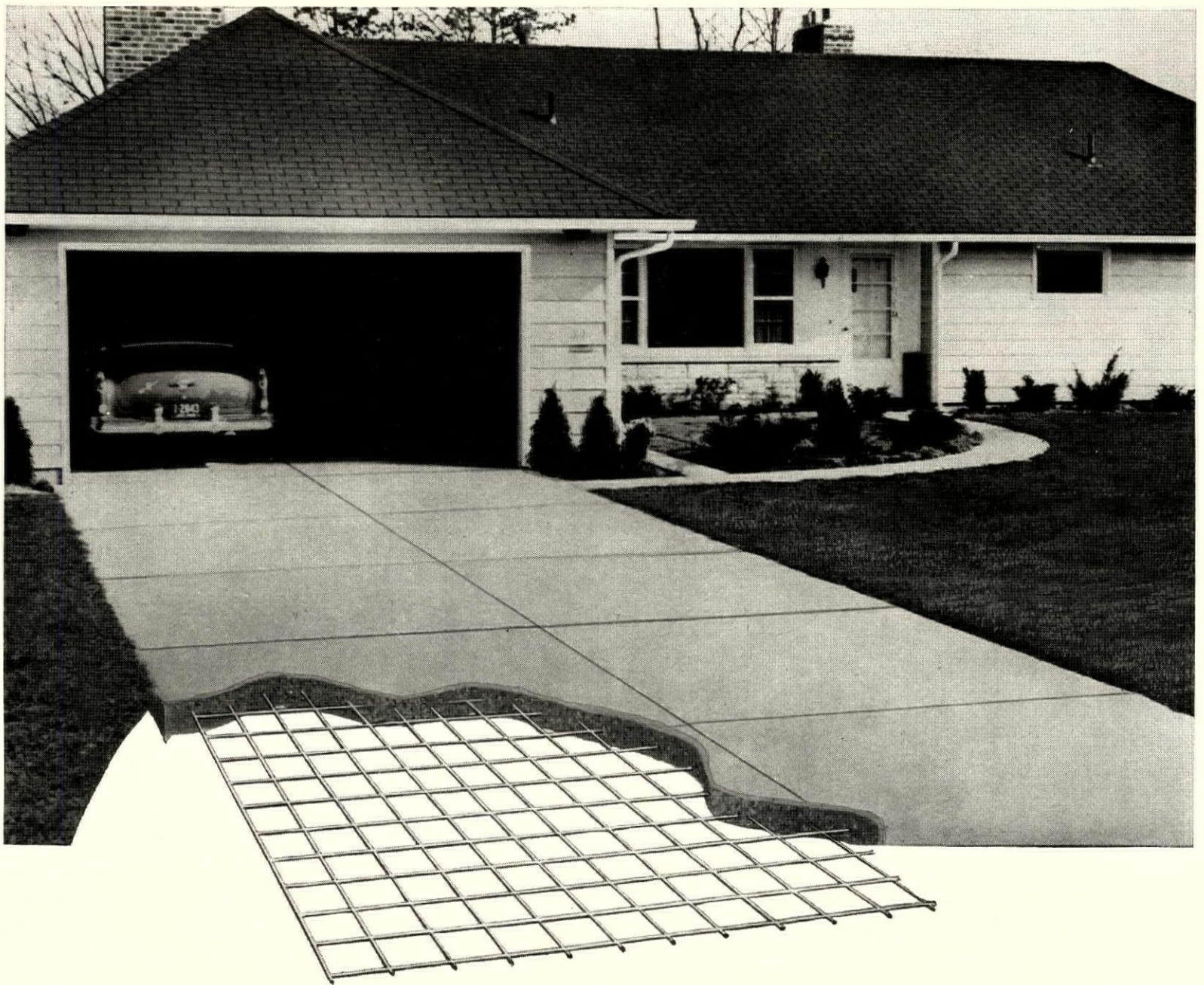

Give your homes added sales-appeal with **WELDED WIRE FABRIC** concrete reinforcement

ONE OF THE BEST WAYS to strengthen concrete is with Welded Wire Fabric. When this reinforcement is used, the cost of the concrete is increased less than 10%, but its strength is increased 30% . . . giving you a strong selling point when pointing out your foundation and basement slabs, walks, drives, and patios to your prospects.

Tell your home buyers that concrete reinforced with Welded Wire Fabric is far less apt to crack or break, even underground heave or adverse weather conditions. And be sure to remind them that Welded Wire Fabric must be installed when the concrete is poured. It cannot be added later. Architects, as well as builders, can stress the importance of this to their clients by reminding them that Welded Wire Fabric reinforcement should be included in the original plans.

National Advertising helps you sell

Leading national magazine campaign directed to home buyers is telling your prospects all about the advantages of Welded Wire Fabric reinforcement for concrete and reminding them

to ask about it when they purchase a home. So that your information will be up-to-date, send for your copy of our free booklet, "Reinforced with Welded Wire Fabric." It will bring out many additional selling features which you can pass on to the people who come to see your homes.

Buyers will ask *"is it Reinforced"*

Wire Reinforcement Institute, Inc.
Dept. 93, National Press Building
Washington 4, D. C.

Please send me promptly a copy of your manual,
"Reinforced with Welded Wire Fabric."

NAME

ADDRESS

CITY ZONE STATE

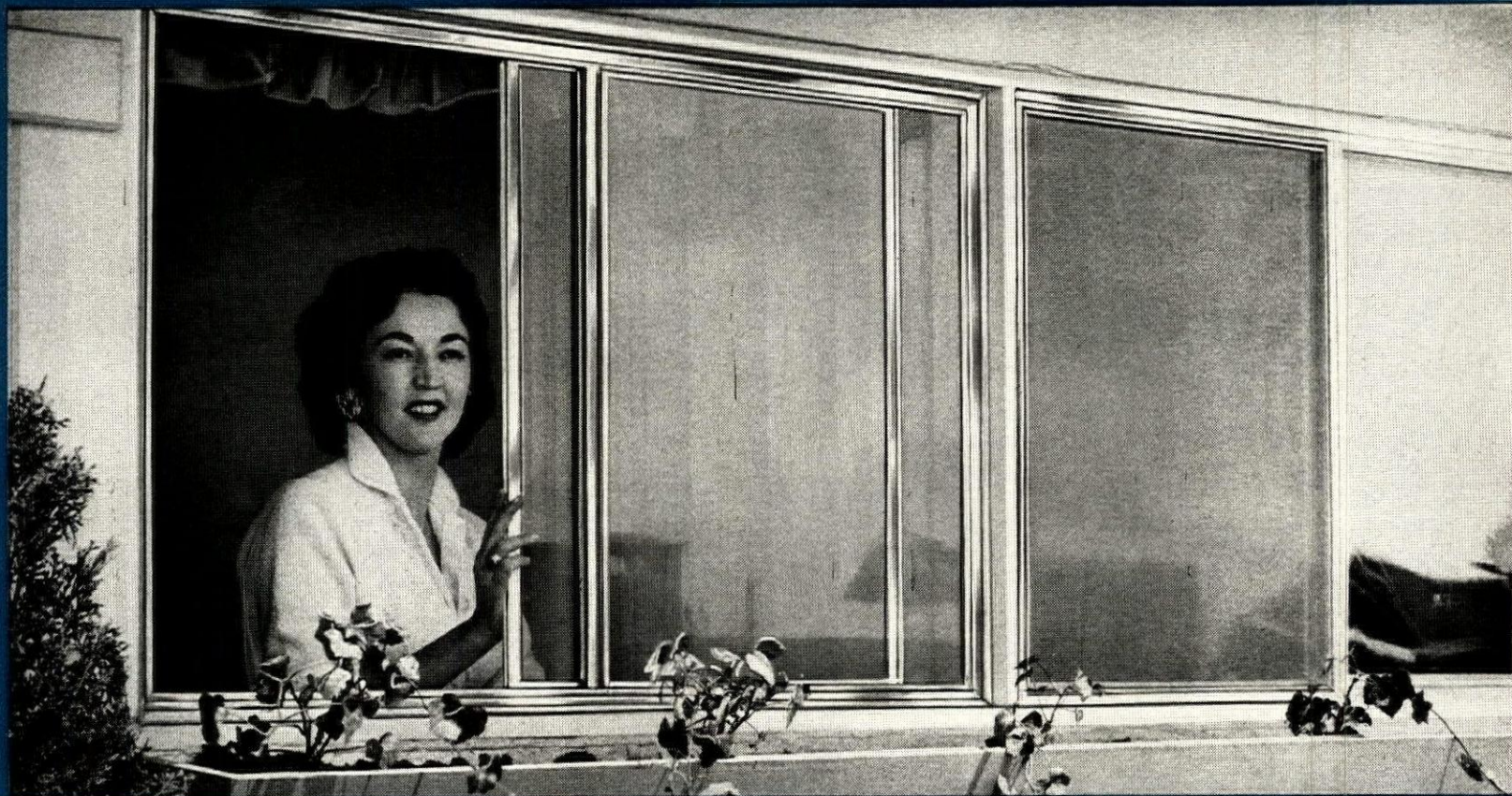

IT TAKES A WINDOW LIKE

this

TO SELL TODAY!

Capitol PRIME SLIDING WINDOWS
have features no other can match

Capitol is the first manufacturer to design a prime sliding window with a *positive* airtight, weather-tight seal. The new Capitol aluminum prime slider uses a special compressive vinyl seal and employs a new design of the meeting rails that is so efficient that wind-driven water at hurricane force cannot get through!

Sell Capitol and you'll further benefit from the product development and sales experience of Capitol, world's largest manufacturer of aluminum doors.

Keep in mind that you can get your aluminum combination storm doors and windows from Capitol, too.

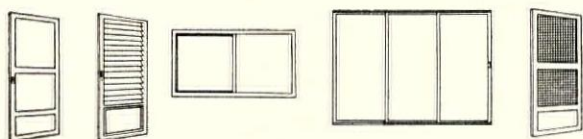

PRIME WINDOWS • ROLLING GLASS DOORS AND SCREENS • COMBINATION DOORS AND WINDOWS • JALOUSIES • EXTRUSIONS





**RIGID FRAME . . . EASY OPERATION
 . . . NOT A RATTLE**

Heavy aluminum extrusions are welded into a rigid frame, reinforced by the strength of a fixed center bar. This design plus perfectly mitered corners make sagging or warping impossible. Sliding sections have nylon guides. Units slide freely at the touch of a finger.

**PATENTED FINGER-TIP
 AUTOMATIC LOCK**

This is the finest sliding window lock made today. Attractively designed, it opens at the touch of a finger . . . automatically locks when the window is closed. It's truly fool-proof.

EASY, TROUBLE-FREE INSTALLATION

With the simplicity of design and easy-to-follow instructions on every window, improper installation is virtually impossible.

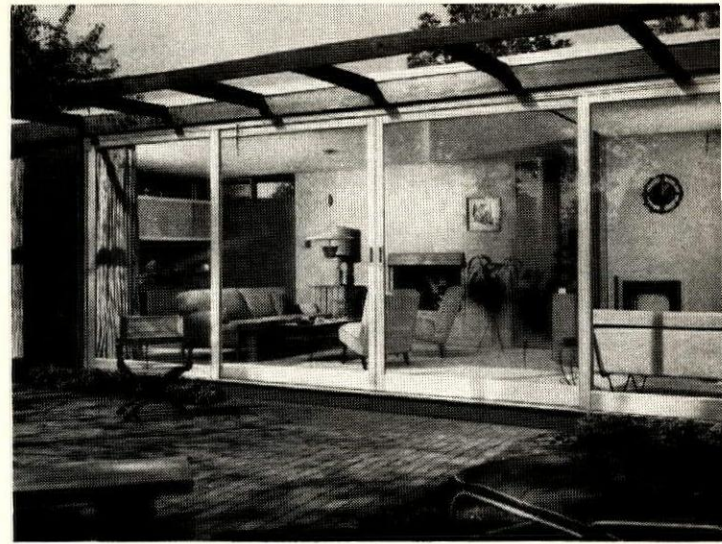

**A wonderful sales opportunity . . .
 ROLLING GLASS DOORS
 by Capitol**

You can capitalize on the growing demand of homeowners for modern rolling glass doors with the complete line of magnificently engineered doors by Capitol.

Available in two and four-panel units, in widths from six to sixteen feet, in various heights to eight feet, Capitol rolling doors appeal to the builder because of their sound engineering, quality construction, ease of installation.

Perfect machining, careful assembly and factory checking assure trouble-free installations. You may have Capitol rolling doors with 1/4" plate or Thermopane.

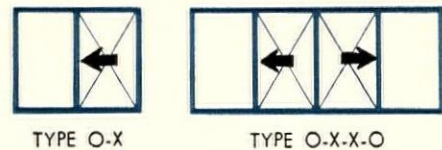

**A SINGLE SOURCE . . . SINGULAR SERVICE
 for all your aluminum doors and windows**

HH103

**CAPITOL PRODUCTS CORPORATION
 Mechanicsburg, Pa.**

Please give me complete information as soon as possible on

- Capitol Prime Sliding Windows
- Capitol Rolling Glass Doors & Screens
- Capitol Combination Storm Doors & Windows

NAME _____

COMPANY _____

ADDRESS _____

TELEPHONE _____

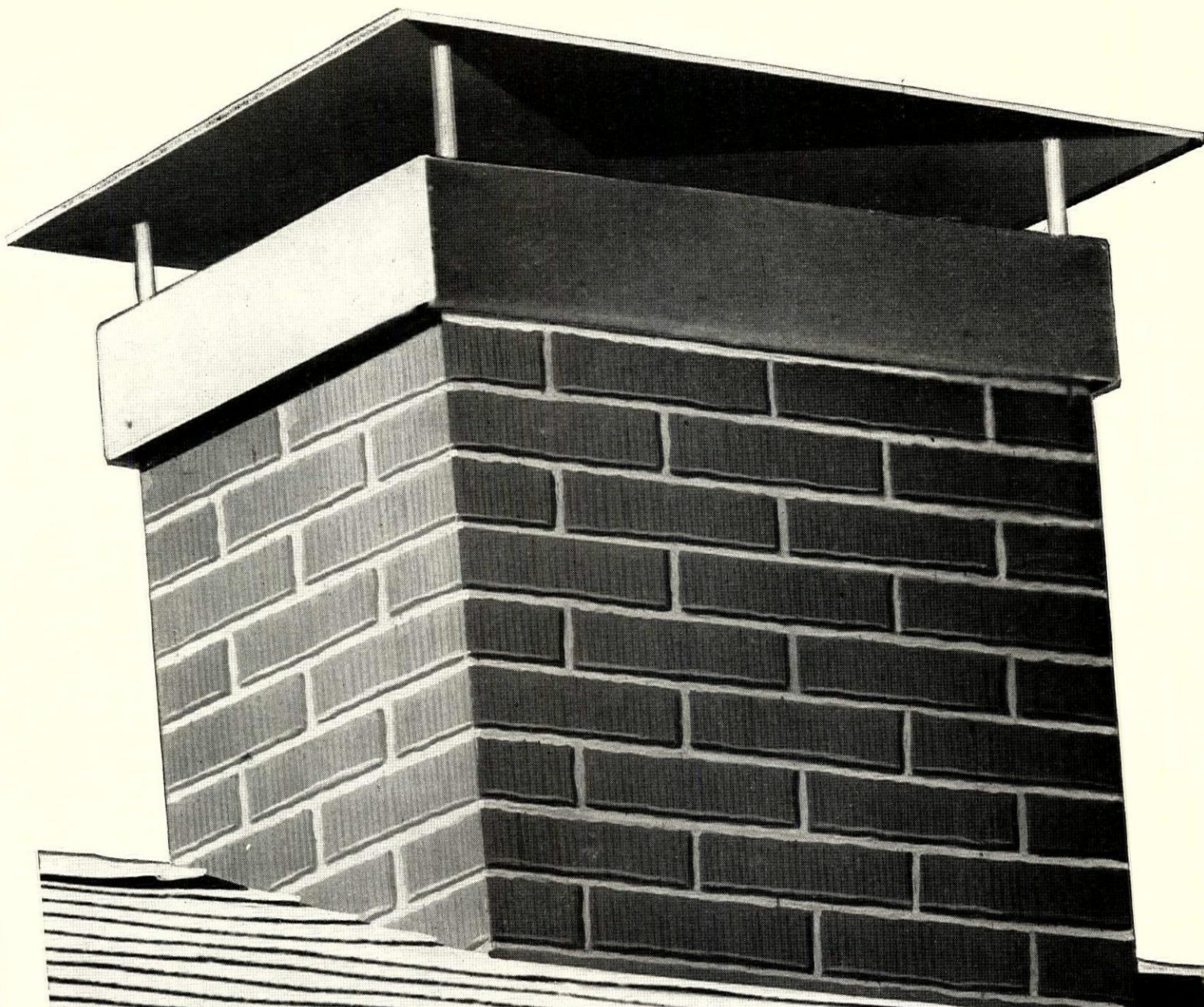

Packaged chimney is permanent masonry

The Van-Packer Chimney gives you masonry permanence and is safe even for incinerators. Asbestos-cement brick-design panel housing comes in red, buff, gray or white colors. It has natural mortar lines that give it the attractive appearance of real brick. Because the Van-Packer is the attractive appearance of real brick. Because the Van-Packer is factory produced, you save up to 40% on installation costs, one man can install it in 3 hours. See your jobber listed under "Chimneys—Pre-fabricated" in Yellow Pages, or write Van-Packer for Bulletin RS-1-19.

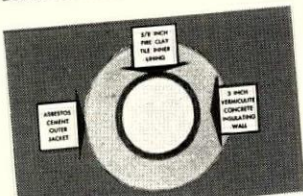

Permanent masonry construction makes Van-Packer safe even for incinerators. Withstands 2100° F.



One man can install a Van-Packer in 3 hours—saves on labor costs.



The Van-Packer comes completely packaged in sturdy, easy to handle cartons. All parts provided.

Snap-on housing cap

Brick-design panel housing

Aluminum flashing

Masonry flue sections

Snap-lock drawbands

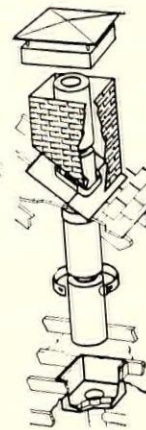

Van-Packer FACTORY-BUILT MASONRY **Chimney**

Van-Packer Company • Division of The Flintkote Company
P. O. Box No. 306, Bettendorf, Iowa • Phone: East Moline, Ill. 3-5288

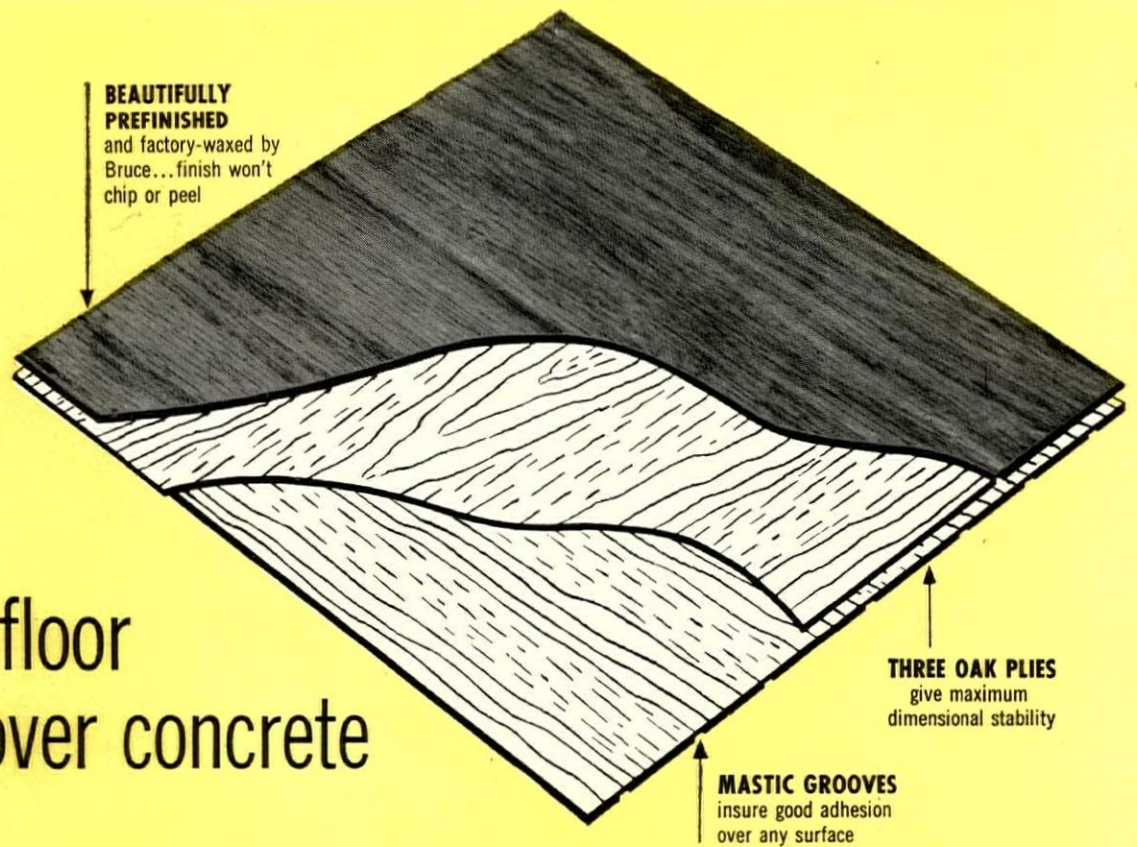

Ideal floor
over concrete

New Bruce Laminated Oak Block



Modern, inexpensive floor lays like tile over concrete subfloors

- Cross-laminated under heat and pressure with waterproof glue
- No surface dampproofing necessary when laid on slabs on grade constructed to FHA or VA specifications
- No expansion space necessary
- Lower in cost than most types of synthetic flooring materials
- Easily applied on wood or concrete subfloors in Bruce Everbond Cold-Stik mastic (no heating required)
- Ideal for private residential and commercial construction
- Smart, modern parquet pattern
- Manufactured in 9" x 9" squares, 1/2" thick
- Carton-packed for protection and easy handling and storage

Bruce Laminated Oak Block

... designed for modern construction

E. L. BRUCE CO., Memphis, Tenn.



World's largest maker
of hardwood floors

Find out about this low-cost oak floor today!

E. L. Bruce Co.
1658 Thomas, Memphis 1, Tenn.

Please send literature on Bruce Laminated Oak Block.

Name _____

Address _____

**NEW INTERNATIONAL®
330 UTILITY TRACTOR**



Now, International tractors with matched loaders and backhoes—complete units backed by unexcelled IH facilities for parts, service and financing. Here, the new 330 Utility is equipped with International Wagner loader and backhoe.

**NOW! MORE
'BEEF'**

than ever before in a 35 hp rig!

It's terrific for trenching, loading, 'dozing! Now you can get an International tractor in the economical 35 hp class, with strength and stamina for high capacity and low maintenance. The new International 330 Utility has up to 900 pounds greater built-in weight than other tractors of similar horsepower—really *rugged* construction! Handle 1,000 pounds with a front-end loader, lift 4,000 pounds with rear-mounted fork, dig faster with heavy-duty backhoe.

ALL the work-easing features of larger IH tractors are available—10 speeds forward with Torque Amplifier drive . . . power steering . . . job-tailored Hydra-Touch equipment control . . . Fast-Hitch.

See how heavy-duty design can cut your costs! Look in the classified directory . . . phone your IH Dealer. For free catalog, write International Harvester Co., Dept. HH-4, P. O. Box 7333, Chicago 80, Ill.



Yardage-boosting traction! Greater built-in weight puts the new International 330 Utility far in front for push-and-pull power that pays off in higher output.

For extra-rugged service, ask your IH dealer to show you the husky, 45-hp International 350 Utility . . . Over 5,500 lb drawbar pull; ¾-ton capacity with front-end loader.

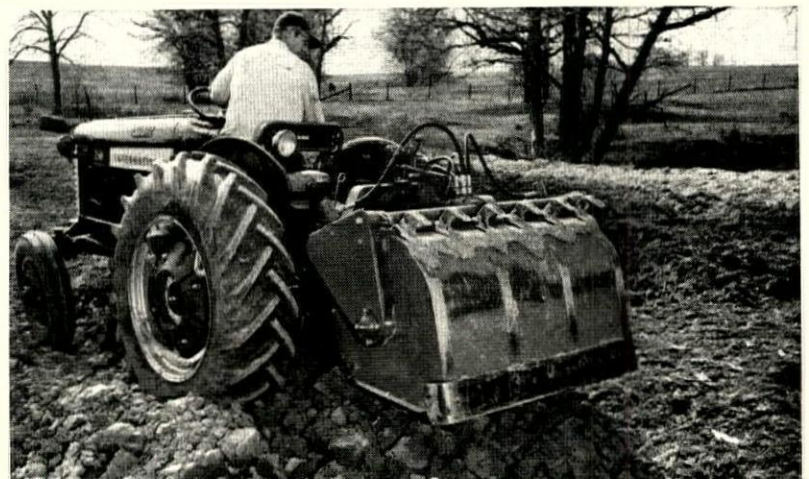

SEE YOUR
**INTERNATIONAL
HARVESTER** DEALER

International Harvester Products pay for themselves in use—
Farm Tractors and Equipment . . . Twine . . . Commercial
Wheel Tractors . . . Motor Trucks . . . Construction Equip-
ment—General Office, Chicago 1, Illinois



Now! Offer New Home Prospects...

Built-in Protection

Against Premature Obsolescence!

Exclusive **YORK**
Low-Priced
HOME COMFORT CENTER

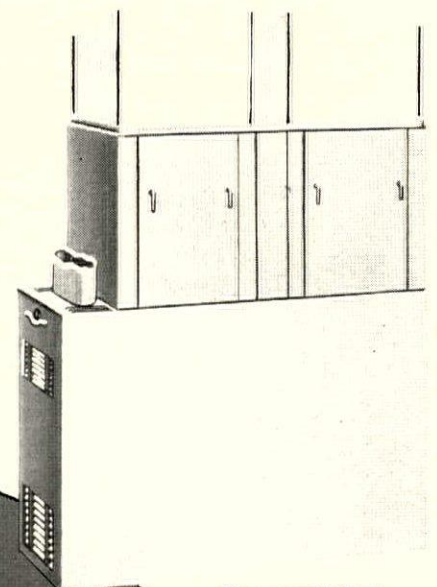

- **Compact! Only 59" x 51" x 27"**
- **Beautiful Baltic Blue, Hammertone Finish!**

It's a Furnace!

...An Air Conditioner!

...A Humidifier!

...A Dehumidifier!

...An Electronic Air Purifier!

Non-Air Conditioned Homes to be Obsolete In 5 to 10 Years!

FHA Recognizes Fact By Permitting Air Conditioning To Be Included In Mortgage!

The deal with Federal Aid: A few years ago...

Now, with the low-cost York Home Comfort Center, you can offer buyers not just heating alone, but all-season comfort—*all in one*, beautifully styled, compact unit! And, because air conditioning is actually a built-in part of this same unit, you offer your customers built-in protection against premature obsolescence. For, as recent FHA policy change indicates—unless the new homes being built today are equipped with air conditioning, they will lose value and become obsolete within a few short years! Get all the facts about the new 1958 York Home Comfort Center, today. Remember, it's the finest—priced so low you could offer it as standard equipment in your homes and still underbid competition!

Your FUTURE and FORTUNE now lies with York!

YORK  York Corporation, York, Pa.
 Subsidiary of Borg-Warner Corporation

Newest cooking center



RCA WHIRLPOOL built-in ranges are designed for simple, fast, economical installation . . . and are available for gas or electric operation. You have a choice of several oven models and surface unit models to give complete versatility

in kitchen planning. There's a choice of color to enhance the most modern decor, too . . . brushed chrome, copper tone, pink, or yellow for the ovens . . . and brushed chrome, pink, or yellow for the surface units.



everything for MODERN

New decorating flexibility! Now you can have mixed color or solid tone kitchens . . . and change them when desired in seconds from one to another without tools. Select-A-Door cabinets are of steel with snap-on wood doors and drawer fronts in 5 modern colors.



Use of trademarks  and RCA authorized by trademark owner Radio Corporation of America

for modern kitchens...

1958 RCA WHIRLPOOL built-in gas and electric ranges offer exclusive, automatic cooking conveniences never before available in built-ins!

Now, in addition to the most modern design, these new RCA WHIRLPOOL built-in ovens and surface units have buy-appeal beyond compare! Complete with the newest features, they're the perfect answer to every woman's wish for truly automatic cooking.

For time-saving convenience there's nothing to beat the exclusive, automatic Roto-Baste, Meat Probe, and "2-Set" clock timer.

For creating new and unusual dishes there's the new automatic Ka-Bob, rotisserie, and radiant-heat barbecuing.

And, for perfect surface cooking every homemaker will appreciate the full range infinite-heat controls, the flash-heat electric range unit, and the thermostatically controlled unit.

All these, and many more outstanding features, will make RCA WHIRLPOOL built-in ovens and surface units first choice with homemakers in 1958. That's why you'll find more and more modern kitchens equipped with the newest and finest ovens and surface units . . . RCA WHIRLPOOL!

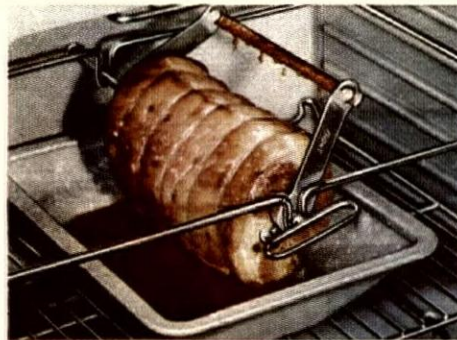

New exclusive Roto-Baste automatically scoops up juices and spreads them evenly over meat.



New automatic Ka-Bob cooks 5 skewers of delicious shish-kabobs on all sides automatically.

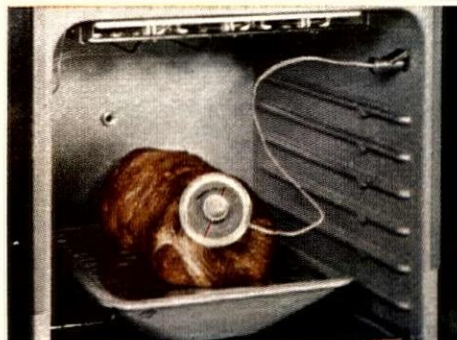

Built-in automatic Meat Probe watches doneness of meat . . . makes roasting super-accurate.



Thermostatically-controlled surface cooking ends pan-watching, scorching, boilovers.

KITCHENS with one brand name Whirlpool

The complete RCA WHIRLPOOL line includes built-in and free-standing appliances in gas and electric models plus standard wall, base, and specialty cabinets. Each product is engineered for easy, fast, economical installation. All are available from one supplier who is ready to give you expert planning assistance, merchandising aid, and fast delivery. And, you'll install products with one brand name, nationally known for quality performance and wanted for dependable service . . . RCA WHIRLPOOL!

RCA WHIRLPOOL Home Appliances
Products of WHIRLPOOL CORPORATION St. Joseph, Michigan

Contract Sales Division,
Whirlpool Corporation, St. Joseph, Michigan
Please send me complete information about
RCA WHIRLPOOL kitchens and the complete line of
appliances

NAME _____ TITLE _____

FIRM NAME _____

FIRM ADDRESS _____

CITY _____ ZONE _____ STATE _____

(HH4)

For the package deal at a package price . . . it's RCA WHIRLPOOL!



KENTILE® Asphalt Tile on Today's Smartest FLOORS

New, smoother Kentile Asphalt Tile in exclusive Rose Random Tones . . . Wall base in Russet KenCove®

Sell Them Faster with the Floors They BELIEVE in . . .

MORE PEOPLE CHOOSE KENTILE FLOORS THAN ANY OTHER TILE!

A presold floor helps sell the house! Capitalize on this overwhelming preference for the famous Kentile name. Kentile, Inc., maintains its leadership position with outstanding advertising support. Exciting full-page, full-color ads will run all year in top magazines like LIFE, THE SATURDAY EVENING POST, LIVING FOR YOUNG HOMEMAKERS, BETTER HOMES AND GARDENS, AMERICAN HOME and others.

Remember, there's a Kentile Floor for Every Purpose!

KENTILE FLOORS

AVAILABLE IN: ASPHALT TILE • SOLID VINYL • VINYL ASBESTOS • CUSHION-BACK VINYL • RUBBER AND CORK TILE . . . OVER 175 DECORATOR COLORS!

58 Second Avenue, Brooklyn 15, New York • 350 Fifth Ave., New York 1, New York • 3 Penn Center Plaza, Philadelphia 2, Pennsylvania • 1211 NBC Building, Cleveland 14, Ohio • 900 Peachtree Street, N. E., Atlanta 9, Georgia • 1016 Central St., Kansas City 5, Missouri • 4532 So. Kolin Ave., Chicago 32, Illinois • 2834 Supply Ave., Los Angeles 22, California

**FREE! NEW KENTILE
PERSONALIZED "MODEL HOUSE" SALES KIT!**

Call your Kentile Flooring Contractor (see your classified phone book) or write to Kentile, Inc. for complete details on the new sales kit which includes:

1. Lawn sign, personalized with your development name
2. Personalized interior signs, for floor & wall base
3. Helpful selling tips . . . for use by your salesmen

ROUNDUP

Anti-recession Housing Act: a mixed blessing

Assuming President Eisenhower pigeonholes all or most of the needless \$1.5 billion pumped into Fanny May, the anti-recession Housing Act (see p. 52) should help housing to recover. It may not help very much, but it will help. Repeal of discount controls on FHA and VA mortgages—best feature of the legislation—cheers builders and lenders alike. Coupled with permission for the administration to boost VA's politically frozen 4½% interest to 4¾%, it means a revival for VA tracts with their enticing 2% down payments. (VA for World War 2 veterans also gets a two-year extension.)

Cutting FHA down payments to the lowest level ever (3% on the first \$13,500 appraised value) will be less help. But almost nobody objects that it is unsound.

The Fanny May provisions, despite all the newspaper headlines they grabbed, are a case of politicians flogging a dead horse. Last year's shortage of FHA and VA mortgage money has now become a glut.

For the long run, the unfortunate aspect of the new law is that by turning to easier terms and easier money, it postpones again any fundamental attack on housing's No. 1 problem: higher and higher costs. But Congressional majority seems dedicated to the notion that the thing to do about the recession is inflate our way out.

FHA's program for small towns will be extended to cities

FHA's Certified Agency Program, on trial for six months in seven areas, will be extended soon to at least six more areas and will be made a permanent part of the FHA system. When CAP was started last fall (Oct. '57, News), it was to have had a one-year trial. But FHA brass have been so impressed with the scheme's reception they have decided to expand it sooner.

When the program is extended it will no longer be limited to cities of 15,000 and under, as now set-up. Now it will take in whole states, including large cities. FHA officials think this will bring them "plus business," such as small builders who have shied away from FHA's red tape and financed only conventionally. FHA will make sure big builders continue to work through FHA district offices, however, by continuing to limit to five the number of outstanding commitments to one builder.

FHA backlog continues to grow

Despite use of fee appraisers and two task forces of headquarters trouble shooters (March, News), FHA is losing more ground than it's gaining in its struggle to overcome its processing jam. Of 19 offices reporting big backlogs in the first week in February, 11 had bigger jams at the end of the first week in March. Some sample increases: Wilmington, Del., from five weeks to 11 weeks; Miami, four weeks to nine weeks; Pittsburgh, four weeks to six weeks; Columbus, three weeks to six weeks. Five of the eight heavily-backlogged offices which improved their processing time during the month improved it by only one to four days. The only city to show a big cut in processing time was Louisville: from six weeks to one week.

FHA still contends it can whittle the backlog down. The agency blames the lost ground on the high level of applications. But FHA has also notified its field offices that the use of fee appraisers—authorized as an emergency measure in February—is now a permanent part of the FHA system for existing houses.

Private starts and combined FHA-VA activity nosedive

Private housing starts plunged to the lowest level in nine years in February: 60,000. The seasonally adjusted annual rate fell to 890,000.

BLS blames winter storms for part of the dip. But some housing experts now wonder if housing will match 1957's 989,000 private starts this year. This much seems certain: if 1958 is to show a gain over last year, at least 60% of the year's starts will have to come in the last half. Normal percentage: 48.8%.

FHA and the administration continue to point with misplaced pride to the high level of FHA applications as a sign of a housing comeback. The more meaningful picture is reflected not by FHA figures alone but by combined FHA-VA activity—and the picture is dark.

FHA applications on new 1- to 4-family units in February (20,656) were up 70.7% from February 1957. But combined FHA-VA total (VA had 5,301 appraisal requests) is only 25,957—19% behind last year.

Conventional starts for the first two months of the year are up 10%. They now account for 74.6% of the market. FHA-VA starts, off 19%, account for only 25.4% of the market vs. the 31.6% of January-February 1957.

NEWS continued on p. 40

THIS MONTH'S NEWS

(index to the top stories)

Housing market: builders begin shift to cheaper homes; FORTUNE predicts 1.1 million starts this year...p. 40

Housing for the aged: a new market beckons builders.....p. 41

Local markets: staff reports on house sales in Ohio and Texas...p. 45

Prefabbers race to get back into low price home market.....p. 49

Anti-slump law: Congress repeals discount controls, cuts FHA down payments to lowest level ever, boosts VA interest rate....p. 52

Views on the news: Is politics partly to blame for housing's slump.p. 57

Mortgage market: easing money revives VA activity in Texas and Californiap. 60

Mortgage brokers: housing's money middlemen come from famine to feastp. 61

Materials & prices: price cutting becomes commonplace and lumber dealers are in real pain.....p. 68

Earnings: materials producers report worst year since 1949—but deny overexpansionp. 72

Canada: government forecasters predict 15½% increase in starts this yearp. 73

Labor: NLRB cracks down on the closed shop; touches off wrangle with laborp. 76

Urban renewal: Chicago acts to divulge identity of hidden slumlordsp. 80

Remodeling: home improvement promotion in Houston paves way for gyp contractorsp. 81

Community facilities: what happened when home building reached one unprepared suburb.....p. 85

People: Tom Sweeney, VA loan guaranty chief, quits to become mortgage banker.....p. 89

Statistics and indexes:

Housing startsp. 40

FHA, VA applications.....p. 40

Mortgage quotationsp. 65

Materials pricesp. 68

Boeckh housing costsp. 68



BIRRI
Wind Seal
SHINGLES

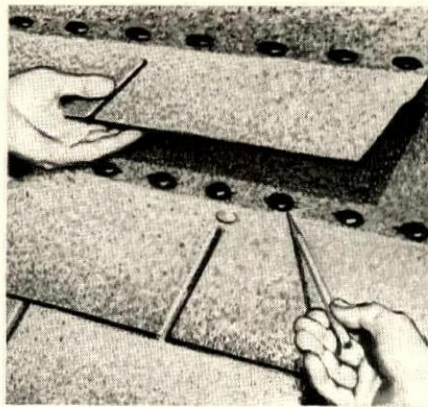
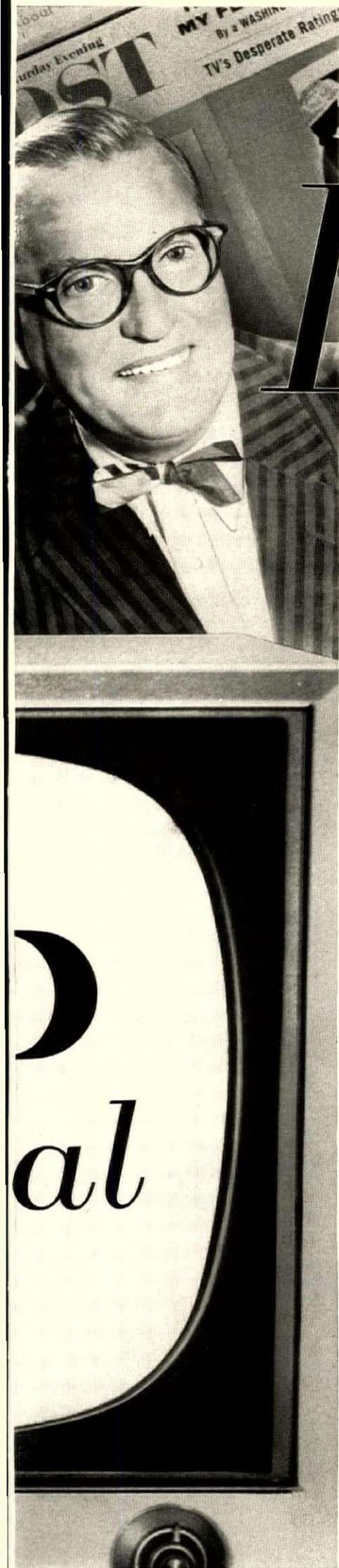

Your customers will see how Bird Wind Seal Shingles work—will look for them in the homes you build.

Look who's demonstrating

BIRD

WIND

SEAL *shingles*

to your home-buying prospects!

Two great NBC-TV personalities will be demonstrating Bird Wind Seal Shingles on their shows — day after day — night after night — reaching millions of families — families right in your selling area.

THE DAVE GARROWAY SHOW

plus

THE JACK PAAR SHOW

plus

FULL COLOR ADS

in the Saturday Evening

POST

Ask your Bird salesman, distributor or dealer for samples and point-of-sale aids to make Bird Wind Seals a selling feature of your home!

BIRD & SON, INC., DEPT. HH-4, EAST WALPOLE, MASS.; CHARLESTON, S. C.; CHICAGO, ILL.; SHREVEPORT, LA.



HOUSING MARKET:

Will the shift toward cheaper homes push starts to 1.1 million this year?

A revival of home building is already under way, wholly independent of Congressional and administration pump-priming schemes.

Don't be misled by February's nine-year low in the annual rate of starts. Signs of upsurge are visible across the country. But it will take a while before they show in statistics. No. 1 reason for housing's prospective recovery is the spectacular turnaround in the mortgage market. Notes FHA Commissioner Norman P. Mason: "The amount of housing that is started in this country is controlled by the money market, largely."

Builders are actually making plans to put up about 1.1 million homes this year—of which some 300,000 (a 50% increase from 1957) will be in the \$7,000 to \$12,000 bracket.

This is the finding of HOUSE & HOME's sister magazine, FORTUNE, after its big semi-annual survey (270 builders in 30 cities) which has consistently called the trend in home building. Says FORTUNE in its April issue: "In the heart of the market, houses of \$12,000 to \$20,000, builders plan approximately to match the 600,000 units of 1957, which was also the average for 1954-55. At the top of the market, above \$20,000, builders plan as many—or more—units as last year's record 200,000." Builders are trying hard to lick their No. 1 problem, the survey finds: "They say they absorbed about half of their 4% increase in costs last year—2% in land and 2% in construction costs—and they expect to do as much this year."

Don't look for a really fast pickup in housing's pace.

What some lenders like to call the "housing binge of 1955"—plus continued advances in costs—make housing more vulnerable than it was in the 1954 recession to consumer attitudes and confidence. Observes Realty Analyst James Downs: "The problem is going to be customers instead of money."

Even last year, when most builder spokesmen were blaming tight money for falling output, the main reason builders sold fewer homes than expected, says FORTUNE, was "weak market conditions"—according to one-fourth of them. Less than a fifth failed to sell as expected because of a lack of mortgage money.

The Eisenhower cabinet is aiming at boosting housing to 1.75 million starts this year. But the industry isn't taking it seriously. HHF Administrator Cole's prediction—at mid-month—was still 1.1 million. Reassuringly, that is what builders plan to do.

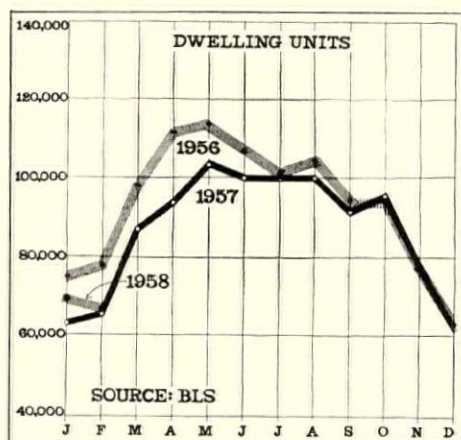

HOUSING STARTS, instead of showing a normal seasonal gain, plummeted to 65,000 in February (vs. 69,000 in January and 65,800 in February a year ago). Private starts totalled only 60,000 for a seasonally adjusted annual rate of 890,000, lowest since April 1949. BLS believes low February starts may be due to bad weather which brought building to a standstill in some areas rather than a bad sales market. Starts for the first two months are still up 4% from 1957.

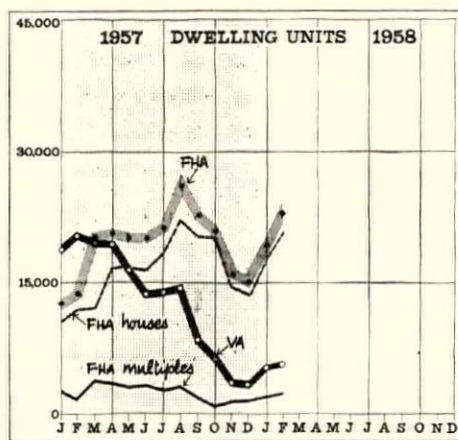

FHA APPLICATIONS on new units reached 23,403 in February, up 3.5% from January and 6.5% from February 1957. Applications on 1- to 4-family units totalled 20,656—19.6% over January and 70.7% over the year before. But VA appraisal requests reached only 5,301 (vs. 5,252 in January) on new units. So total FHA-VA activity on 1- to 4-family homes in February was still 19% behind February a year ago: 25,957 vs. 32,272 (including 20,170 VAs).

MARKET BRIEFS

VA cuts staff by one-third

Will the Veterans Administration be ready to handle a bigger workload if the VA housing program for World War 2 veterans makes a comeback this year?

It looks doubtful, judging from the decimation of VA's ranks of technical personnel in the last nine months.

Since last June 30, when it started retrenchment, VA has cut its loan guaranty staff 35%—from 3,147 to 2,035. (It had planned to reduce it to 1,840 by June 30.) VA conditioned further cuts on whether Congress extended the program beyond its scheduled July 25 cut-off.

VA has not closed any of its 65 loan guaranty offices but has consolidated its top echelon staffers. Thus such big markets as Miami and San Diego do not have loan guaranty officers of their own. Miami is now subject to the Jacksonville office, San Diego to Los Angeles.

More 6% commissions

Brokers in more cities are adopting a 6% realty commission.

A survey by the Natl. Assn. of Real Estate Editors shows most of New Jersey has gone to 6%. So have Pittsburgh, Albuquerque, Tucson, Boston and Quincy, Mass.

There is agitation to go from 5 to 6% in Cleveland, Washington, Cincinnati, Milwaukee and Philadelphia.

Other cities which had already gone to 6% (Dec. '57 and March, News) include Detroit, Minneapolis, Chicago and Denver.

Prefab firm goes national

Scholz Homes has become the nation's first prefab company with coast-to-coast distribution.

The Toledo firm has signed a contract with Workman-Rhodes Co. in Fresno, Calif. to subcontract the Scholz line of homes along the west coast. In recent months, Scholz has also signed up with firms in Kansas City, Independence, La. and Huntington, L.I. to make and distribute Scholz house components.

BLS v. Census

Finger-pointing has begun in housing's leading statistical whodunit.

The mystery is why the Census Bureau managed to count 2.7 million more new homes (new since the 1950 Census, that is) when it took the 1956 housing inventory than BLS had tallied as new housing starts during the same time. Census counted 10.9 million new units. BLS starts reached only 8.1 million. Even after you knock off 800,000 units for trailers and farm homes (which BLS does not check), the Census inventory is 2 million higher (Jan., News).

BLS has been much berated since then, even faced loss of all its housing statistical work to the Census Bureau (a threat which is not gone yet).

Now, BLS comes forth with the argument that Census erred.

Arnold Chase, chief of BLS' division of construction statistics, argues that Census inventory-takers could easily have run into trouble trying to determine the year a new unit was built. Census tried to match units against 1950 enumeration sheets so it would not recount new homes that got in to the last

Hank Cohen

decennial census. But Chase contends that in projects of 25 or more houses, the matching "was not even attempted." It was left to the enumerator to decide whether a unit was a "new" unit—built since the last Census. In a tract of 500 homes, however, it is not inconceivable 450 were counted in 1950 and a full 500 were counted in 1957—if the tract was still being developed in 1950.

Chase's most telling point combines two of Census' own statistics which seem to substantiate BLS' starts estimates rather than the housing inventory. Census reports a 6 million increase in households in the 6¼ year period, which should be equivalent to occupied dwelling units. Adjusted for increases in Census' vacancy rate, an increase of 7.5 million in the total inventory is indicated.

The implication: the only inconsistent figure of four (BLS starts, Census' housing inventory, its household formation estimate and vacancy rate) is the housing inventory.

Says Chase: "It follows that the housing inventory must overstate units added by new construction between 1950 and 1956."

No selling on Sunday

Battles over selling real estate on Sundays continue across the nation. Items:

Sixty Columbus realtors now do not advertise in Sunday papers, show or sell on Sundays. The remaining realtors in the city and home builders still do. An ordinance to ban all Sunday selling was introduced in the city council at the behest of the supporting realtors, but it has been tabled and has apparently little chance for passage.

A group of Indianapolis citizens, headed by three downtown businessmen, have started a "Respect Sunday" drive to persuade all businesses (including real estate) to be closed except those essential to health, safety and traditional Sunday recreation. The program will rely on persuasion, is not supposed to lead to a Sunday closing law.

Realtors in the Evanston-North Shore board north of Chicago want to establish Saturday as the key weekend sales day. The board will promote five Saturday open house showings (but remain open on Sunday also), then decide whether Sunday closings are feasible.

The New York's city council has asked the state legislature to pass a law to let the city to permit certain types of businesses to remain open on Sundays if they are closed for religious observance another day.

A proposed ban against Sunday retail selling failed to get through the Michigan legislature despite strong support from church groups, farm, labor and retail store representatives. The argument in favor of inaction: it is impossible to close all retail establishments; therefore to close any would be discriminatory.

Cost-price dilemma

Until 1965, warns the Labor Dept., housing starts will "be improved appreciably only if ways are found to hold down construction costs and, at the same time, maintain a quality product." It adds: "Reduced costs (would) bring quality housing within reach of a larger proportion of families and enable housing to compete more effectively with other consumer goods and services."

Between now and 1965, says the department in an analysis of housing demand, the rate of new homebuilding will hinge heavily on "social and economic factors" and less on basic forces like household formation, demolitions and migration. After 1965, it predicts: "... A sharp upturn in household formation can be expected to strain the resources of the industry."



RETIREMENT HOMES at upholsterers union Salhaven village, Fla. included these 1-bedroom units bid at about \$9,000 for construction only. The \$5 million-plus community has equally plush convalescent, administrative and social facilities, was financed entirely out of union funds with no mortgage. Architect was Rufus Nims. Builder was Coastal Properties.

HOUSING THE AGED:

Easier FHA terms, growing population beckon builders to a new market

You are missing one of the country's newest potential housing markets if you have overlooked homes for the elderly (as most builders have).

Those few builders who have tapped this growing market, have been surprised themselves by the size of their success. Items:

- NAHB First Vice President Carl Mitnick of Merchantville, N. J. did not aim at the retirement market. But he found that half the buyers in his 1,120-home Cape May, N. J. seashore tract were retirees. (Price range: \$8,250 to \$11,090.)

- Florida's Mackle Co. actually aimed at the market, has sold 14,000 units in six years, most of them to retirees.

- Though Big Builder Bill Levitt put up Levittown, L. I. for young marrieds with children, a survey of resales shows 42% of the 2-bedroom homes now go to couples whose offspring are full grown.

Market keeps growing

Today one person in twelve in the US is 65 or older. By 1980, this age group will swell 36% to almost 22 million. E. Everett Ashley III, HHFA statistical chief, points out two reasons why builders should take note:

1. Average net worth of older families is \$8,400—almost double the average for all families.

2. A big part of these assets is often an old home which has become too big (40% of aged couples live in 6-room or larger homes because of inertia or sentiment).

Many oldsters would be prime prospects for a newer, more convenient retirement home (which would often involve a trade). Many more would be interested in smaller rental units—often semi-institutional with community dining and health facilities.

FHA activity up

Activity under FHA's special rental housing provisions has begun to spurt.* Since July 1956, 17 projects worth \$17½ million and involving 2,146 units have started. Another 200 projects, worth over \$200 million, are being planned.

If Congress buys the administration plan for rejiggering its rental housing program for the aged—as seems likely—building for this market will become even more attractive.

The proposal would take the program out of Sec. 207 and put it in a new Sec. 229. It would eliminate the requirement that a project be "economically sound," thus allow projects designed specifically for the aged. FHA would be permitted to fix rent ceilings—but not required to do so. Mortgage ceilings would be raised \$1,000 per room in high cost areas over the present limits, giving it the same leeway as Secs. 207 and 220.

FHA Commissioner Norman Mason, who has called housing for the elderly "the catalyst to a whole new era in housing," personally flew to Miami in March to sign a commitment for expanding and refurbishing a Jewish Home for the aged under the 207 program.

Fanny May bought \$1 million worth of mortgages on housing for the elderly last year. It expects to buy \$15 million this year; \$25 million next. Under its special assistance program, the agency pays par for such loans (less a ¾ point marketing and ¾ point advance commitment fee). That is about 1½ points better than market in the East for 4½% paper, and 3½ points better in California. Fanny May demands proof that the mortgage has been turned down by two lenders before it will buy.

Needed: new concepts of lending

Political interest in housing for the aged is beginning to make private lenders stop, look and listen. Financing old people's housing "requires that lenders revise their normal standards of loan acceptance to meet the

continued on p. 45

* The 1956 Housing Act introduced two special deals for housing the aged: 1. Under Sec. 207, FHA will insure 90%-of-replacement-cost loans up to \$8,100 per unit (\$8,400 with elevators) for projects of more than eight units. 2. Under Sec. 203, home buyers over 60 may borrow both downpayment and closing costs from a relative (but they must still meet income requirements). "Very little interest has been shown," says Mary Cleverley, FHA's aide for housing the elderly. "I know of only a couple of cases where people have borrowed the down payment."

new vinyl wall and counter surfacing lets



BATHROOMS Splashproof, washable, and stain resistant, Armstrong Vinyl Plastic Surfacing adds high style appeal to the bathrooms in your homes. Here, it was used not only on walls and counters, but also behind the shower, in stripes of contrasting colors. Vinyl Plastic Surfacing may be used on all bathroom walls, except in enclosed shower stalls, because the Hydrocord back resists moisture and alkali.

Smooth, colorful vinyl wall and counter surfaces add work-saving appeal to your kitchens and bathrooms. Homemakers prefer them because they're so completely carefree and practical. Now, with new Armstrong Vinyl Plastic Surfacing, you can build in this attractive feature at lower cost than ever before. The installed price is only 55-75¢ per square foot over a clean, smooth base.

Vinyl Plastic Surfacing is remarkably flexible. It can be snugly fitted to sharp edges, coved tightly to inside and outside corners. The result is a permanent seamless surface that makes kitchens and bathrooms much easier to keep clean. Vinyl Plastic Surfacing is also highly resistant to detergents, alkalis, foods, medicines,

cosmetics . . . anything likely to be spilled on it. It is very durable, won't shatter on impact or buckle with heat. The exclusive Armstrong Hydrocord backing insures that it will not be harmed by moisture. Vinyl Plastic Surfacing comes in a variety of color-fast decorator shades . . . in long rolls 30", 42", and 72" wide —assuring seamless installations in most areas.

Other wall and counter materials

For those builders who prefer high-pressure plastic laminates, there's Armstrong Corlex. A high-quality rigid counter surfacing, it comes in smart designs specially created to harmonize with Armstrong floors. Eye-catching effects can also be obtained with Arm-

you offer a more carefree home



KITCHENS Armstrong Vinyl Plastic Surfacing can be installed on walls, counter and sink tops to make your kitchens decorative and easy to keep clean. Quieter, too . . . because it's a resilient surface that reduces kitchen clatter. Notice how the extreme flexibility of Vinyl Plastic Surfacing permits it to be formed into smooth "waterfall" edges and coved neatly to corners without metal or other trim.

strong Linoleum and inlaid vinyl sheet Corlon by flashing these flooring materials up walls and counter faces and by covering counter tops with the same material chosen for the floor.

Your Armstrong Architectural-Builder Consultant will be glad to help you choose materials for walls and counter tops as well as for floors. He can offer design assistance from the Armstrong Bureau of Interior Decoration and provide you with merchandising programs that will help you sell more houses. Phone or write him at the nearest Armstrong District Office. Or write direct to Armstrong Cork Company, Floor Division, 104 Sixth Street, Lancaster, Pennsylvania.

Offer a more carefree home . . .

One of a series of merchandising ideas from the Armstrong Architectural-Builder Service to help you sell homes faster, more profitably.



Armstrong

THE MODERN FASHION IN

FLOORS, WALLS, AND COUNTER TOPS

LINOLEUM • INLAID VINYL CORLON • EXCELON • VINYL-
ASBESTOS TILE • CUSTOM CORLON PLASTIC TILE • RUBBER
TILE • CORK TILE • CUSTOM VINYL CORK TILE • ASPHALT
TILE • LINOTILE • VINYL PLASTIC SURFACING •
VINYL WALL TILE

BUILDERS! For Greater Immediate Profit

New 1958 **WEATHER-TWINS***

CONVECTOR HEATING • DIRECTIONAL AIR CONDITIONING SYSTEMS



Only **WEATHER-TWINS** Bring The Builder These 10 Big Benefits!

1. GREATER IMMEDIATE PROFIT.
2. INDIVIDUAL UNITS CAN BE INSTALLED AS NEEDED.
3. MORE FLEXIBLE RENTING.
4. MINIMUM OPERATING COSTS. THE TENANT PAYS FOR THE CURRENT.
5. LOWEST INSTALLATION COSTS.
6. REQUIRES NO COSTLY CENTRAL SYSTEM OR OPERATING ENGINEERS.
7. COMPLETE SYSTEM BREAKDOWN IS IMPOSSIBLE.
8. ELIMINATES WINDOW WASHING PROBLEMS.
9. MORE BEAUTY. RETAINS THE CLEAN BEAUTY OF THE LINES OF THE BUILDING.
10. AVAILABLE WITH ONE-PIPE STEAM SYSTEMS, TWO-PIPE VACUUM SYSTEMS, AND HOT WATER SYSTEMS.
(No fans used for heating)

These Prominent Builders Are Now Making **WEATHER-TWIN** Installations

MARTINIQUE APARTMENTS—PASSAIC, NEW JERSEY
58 apartments Howard Garfinkle—Builder 120 air conditioners

DORCHESTER APARTMENTS—MONTCLAIR, NEW JERSEY
48 apartments Howard Garfinkle—Builder 130 air conditioners

SILVERSET REALTY CORP.—YONKERS, NEW YORK
85 apartments Harry Silverman—Builder 196 air conditioners

MEFER REALTY CORP.—NEW YORK CITY
52 apartments George Schaeffer—Builder 62 air conditioners

BEVERLY OPERATING CORP.—BROOKLYN, NEW YORK
55 apartments Geller & Mitchell—Builders 130 air conditioners

STRATTON ESTATES, INC.—FOREST HILLS, L.I., N.Y.
60 apartments Frank Vitale—Builder 110 air conditioners

**Weather-Twins . . . Heating by Embassy Steel Products, Inc.—890 Stanley Ave., Brooklyn 8, N. Y. . . . Air Conditioning by Kelvinator*

BUILDERS! For The Finest In Room Air Conditioning See The

New 1958 **KELVINATOR**

"STYLE MARK" AIR CONDITIONERS

6 New 1958 Kelvinator "Thin-Style" Models only 27" wide. Install through the wall or in the window. 1 H. P. (7½ and 12 amps.) to 2 H. P.
KELVINATOR DIVISION AMERICAN MOTORS CORP., 14250 PLYMOUTH ROAD, DETROIT 32, MICHIGAN

challenge," says Vice President Harry Held of New York's giant Bowery Savings Bank. "Enough risk factors have been modified so lenders should take a new look. . . . The final age limit at which a loan could be paid might reasonably be increased to 75 or even 80."

'Would you make the loan?'

Held suggests lenders might like older customers because they: 1) are likely to have few competing credit obligations; 2) treat debt seriously; 3) impose little wear and tear; 4) shop carefully.

To a builder with an older customer he suggests: "Ask yourself if you would make the loan with your own money; if you would you can probably convince the lender."

So far, most projects for old people have been sponsored by religious or philanthropic groups. Typical is a 12-story apartment block for retired Omaha school teachers financed under Sec. 207. Equity was put up by \$1,500 individual investments by teachers who thus also bought rights to a life-time lease.

Labor is interested too (see photo). An AFL-CIO group has plans for a pilot project in Washington, which will be followed by others around the country.

The sales market for retirement homes is concentrated where the climate is good. Florida's Mackle Co. is probably the biggest "retirement" builder. A typical Mackle home has one or two bedrooms, costs less than \$10,000, requires less than \$1,000 down.

Some builders cry FHA makes it hard to

serve this market because it disapproves 2-bedroom homes. Says Mrs. Cleverley: "Many have the mistaken idea people shrink when they reach 60. . . . We have had to turn down a lot of doll houses."

How should houses be designed?

Main thing to realize, say experts, is that old people are not freaks. And to make projects attractive to lenders they should think in terms of dual use (i.e., by both old and young). Some recommendations:

One-floor planning; no steps and thresholds (accident hazards); good lighting (for maximum sun and aid to failing eyes); oversized heating system (5° above normal working temperatures); wider doors; grab rails in bathrooms; non-skid floors.

Four S&L men indicted as HLBB hits self-dealing

The Home Loan Bank Board is clamping down on savings & loan officers who have been participating in builders' profits by lending their institution's money to themselves.

After a two-year investigation by the HLBB—with FBI help at the end—two Florida grand juries have indicted four prominent Miami Beach S&L executives including Baron de Hirsch Meyer, one of Florida's leading citizens. They are charged with using \$7 million from an S&L and two banks they control to make personal profits of \$600,000 in building and land speculation deals.

The ever-reticent HLBB will not admit a drive against self-dealing. But US Attorney James L. Guilmartin of Miami revealed the government is investigating similar cases elsewhere in the nation. He added: "There has been a complete reappraisal of the methods of the government in examining the financial records of all institutions of this type."

Both the Justice Dept. and the HLBB in Washington refused to confirm or deny Guilmartin's statement. Neither would the HLBB divulge how many S&Ls it has acted against in the past for self-dealing—nor how many officers it has removed. But S&L men say there have been at least three—two in Florida and one in Wisconsin. This closed-mouth policy has been frequently criticized by S&L leaders who contend it leaves them somewhat in the dark as to what practices HLBB will not condone. Complains one: "The board ought to publish its rulings [in disciplinary



S&L MEN ABESS, BECKER & MEYER

cases.] They ought to tell us what they mean."

Distinguished citizens

The Miami Beach case involves some of the city's most prominent citizens: Baron de Hirsch Meyer,* civic leader, philanthropist and Harvard law school graduate, and three associates, Leonard L. Abess, Sam R. Becker and W. George Kennedy—all four connected with one or more of the three lending institutions involved.

The indictments—30 counts in all—charge

* On the night of his indictment, Meyer received the regional brotherhood award of the Natl. Conference of Christians and Jews. He told the audience: "Tonight, thank God I'm in America where true brotherhood exists. Where else . . . can you be indicted in the afternoon and honored in the evening by your friends."

the four men with approving unsecured loans from the Miami Beach Federal S&L, the Industrial National Bank and the North Shore (state) Bank, to corporations they controlled which shared in profits from participating deals with home builders.

They are also charged with 1) making false entries in the S&Ls' books to hide these loans from the HLBB examiners and 2) arranging purchases of undeveloped real estate which was resold at a profit.

No losses involved

The case has aroused no great antagonism against the men in Miami since the institutions lost no money. All three are in sound financial shape (and the public was so assured by the HLBB and other federal officials to avoid a possible run.)

In fact, the federal grand jury in Miami heard the evidence against the men a year ago and refused to indict them. So the government took the case to Tampa and Jacksonville, won indictments in both places on differing phases of the case.

Meyer, who was president of the Miami Beach Federal, resigned a week before the indictments were returned. The other three men also gave up their positions with the S&L and the two banks.

Says Meyer: "To the best of our knowledge and conscience, we do not believe we are guilty of any wrongdoing." Each count carries a penalty of up to five years in jail and a \$5,000 fine.

LOCAL MARKETS: staff reports on sales in Ohio and Texas

Last month, seven House & Home editors fanned out across the US for a first-hand look at housing trends. Executive Editor Carl Norcross, focusing on Ohio and Texas, visited 16 cities in 21 days. His eyewitness report on how sales are going:

Ohio: Despite some unemployment in their areas, builders in five Ohio cities—Cleveland, Columbus, Springfield, Dayton, Cincinnati—are more optimistic than they were in the early winter. Builders who are merchandising aggressively report a definite pick-up in sales since New Year's. Several say business is better than in January and February last year.

Bright sales spot of the entire state is Xenia (pop. 15,718), 15 mi. east of Dayton. Since New Year's, Builder H. B. Layne has sold 319 houses, 98% to Dayton families and 95% to former renters. The secret: Layne has National Homes' new \$9,950 Fairlane model. Down payment is \$395, so a man whose weekly take-home pay is \$72 can qualify. Of

total sales, 59 are to veterans who bought the Sunbury model at \$12,950. Sales manager Bob Copes reports about a quarter of the families would qualify for a more expensive house. Says Copes: You can't tell how many renters there are in a city like Dayton until you offer a low-cost house that draws them out."

At huge Forest Park (eventually 50,000 people) just north of Cincinnati, Warner-Kanter report sales are up "more than 50%" compared with 1957 for their models priced from \$14,490 to around \$20,000. "A lot of our sales have been to old prospects—people who had been looking for three to six months. Some had been on the fence but in Jan. and Feb. they decided to buy now. We know some decided to buy a house instead of a car," says President Marvin Warner.

In Columbus, 200-a-year Builder Ernest Fritsche finds sales are faster and easier than

in early 1957. He is 30 sales ahead of construction with his \$15,000 houses. "Two thirds are second-time buyers who had an old house to sell, so FHA down payments are no problem," he says.

Fritsche, who is a steady advertiser himself, says all Columbus' east side builders sold houses as a result of heavy advertising in Jan. by Huber Homes who had moved in from Dayton. Huber sold out a 40-house tract, has now moved to a 200-lot subdivision where the firm made 79 sales in two days after heavy promotion of the \$13,995 houses.

At Lincoln Village in Columbus, Salesman Ralph McColley says: "Suddenly people have more money. Last year no one wanted to pay extra for houses with basements so we built slabs. Now everyone seems to have money and we are selling basements. We know the big road building program here is helping our sales. About 1,500 families were forced to

continued on p. 49



MEMO

TO: *Builders*

RE: *Features that sell homes*

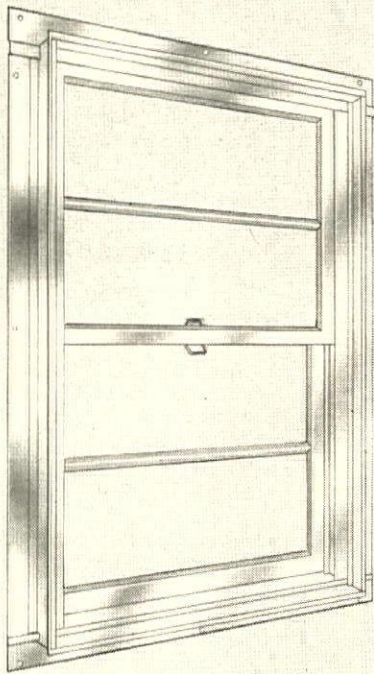

Ceco "Series 70" Double-Hung with Integral Fin-Trim

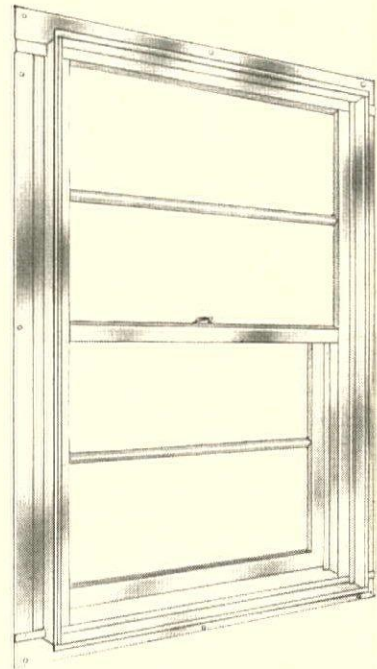

Ceco "Series 80" Single-Hung with Integral Fin-Trim

**CECO
STEEL**

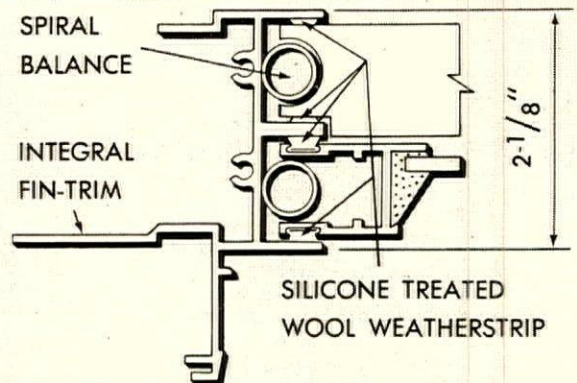

DETAIL OF SERIES 70 SHOWS QUALITY OF NEW WINDOWS

Weatherstripping cuts infiltration to less than 1/2 cu. ft. per min. per ft. of sash perimeter with wind at 25 mph. New spiral balances provide finger-tip operation.

LOOK INTO CECO'S NEW ALUMINUM RESIDENTIAL WINDOWS...THEY HELP MOVE HOMES FASTER

Send for your free copy of Catalog 1049-D, giving complete data on Ceco's warehoused windows and screens, including the new Aluminum Series 70 and 80 Double-Hung and Single-Hung types.

Dressing up your dwellings with fresh products is one way to trigger sales. And Ceco can help you do that with its new Aluminum Double-Hung and Single-Hung Windows. For with these windows you now can offer your prospects smooth window operation—and weathertightness, too—all because the sash are cushioned with pre-tested silicone-treated wool-pile weatherstripping. The sash operate effortlessly because they are countered with even-tensioned spiral balances. These windows are easy for your men to install. They are modular. They have integral fin-trims and offer the quickest possible attachment—no loose parts to assemble. Call your Ceco man today. He can help you with your window problems. Ceco Steel Products Corporation—offices, warehouses and fabricating plants in principal cities—general offices: 5601 W. 26th St., Chicago 50, Illinois.

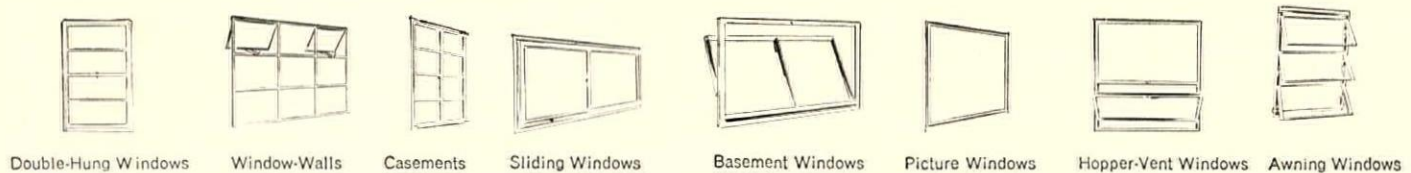

IN CONSTRUCTION PRODUCTS CECO ENGINEERING MAKES THE BIG DIFFERENCE

THERE'S A NEW TREND IN BATHROOMS

For faster home sales Abe Johns uses fixtures in Color

Johns Riverside Development features homes with 2 or 3 bedrooms—1½ or 2 baths.

One of the industry's leading builders, A. F. Johns of Tampa, Florida, offers the most house for the money in his fabulous Johns Riverside Development.

He knows that home buyers, today, respond to attractively planned bathrooms with plumbing fixtures of pleasing design and known quality. That's why he features 1½ and 2 bathroom homes with the world's finest plumbing fixtures in color by Universal-Rundle.

And, Universal-Rundle "New Trend" bathrooms can be a big selling feature for every builder.

You are invited to write to us for a complete catalog. Or see the Universal-Rundle section in Sweet's Architectural and Light Construction Files. Universal-Rundle Corp., 530 River Road, New Castle, Pennsylvania.

NEW U/R BUILDER AIDS

Universal-Rundle furnishes a coordinated merchandising package for builders, tailored to your model homes.

- Four-page brochure illustrates your homes, highlights the features.
- Luxurious Counter Book with built-in easel, tailored for you, illustrates features of U/R fixtures in your model home.
- Full-color decorating book, "The New Trend in Bathrooms," gives buyers exciting bathroom ideas.
- Color Key Packets show U/R colors, suggest complementary decorating colors.
- Feature Pointers highlight extra-value features of fixtures.
- Outdoor sign, imprinted match books, radio scripts, TV films.

Write to Universal-Rundle for details.

Universal Rundle

MAKER OF THE WORLD'S FINEST PLUMBING FIXTURES

Plants in Camden, New Jersey; Milwaukee, Wisconsin; New Castle, Pennsylvania; Redlands, California; Hondo, Texas

move during the last nine months from both slum clearance and roads and a lot of people are moving up to better houses." McColley calls February sales considerably better than in January.

In **Dayton**, Huber Homes (which built 700 houses at around \$13,000 last year) showed a new group of models late last month. Because of unemployment and business conditions Huber anticipates a 10% drop in production in Dayton this year, but expects to more than make up for this by more sales in Columbus and Chicago.

In **Cleveland**, Builder Bernard Rubin of Par Realty had a noticeable pick-up in business during the first two months of this year compared with last fall and early winter. His split-level houses sell at \$27,000 to \$34,000. Out of every ten sales, he reports that five are for four-bedroom models, four are for three-bedrooms and one is for a five-bedroom.

President Ray Murphy of the **Cincinnati** Home Builders told *HOUSE & HOME* sales are definitely higher among his members than last fall. "All builders are more optimistic this year," he says. "The phones are beginning to ring again for both realtors and builders. 'If this is a recession,' commented Jack Murphy, 'we can stand a lot of it.'" The three Murphy brothers built 131 last year (at \$16,000 to \$22,000) and plan to build 200 this year "or maybe more."

Ft. Worth builders report a sales pick up since Jan. 1. Building permits jumped 60% in January—to 440 vs. 333 for January last year. Says 20-house Builder Thomas Buckner: "The market is very good for me. I've never seen so many people looking. There are lots of buyers, too. There is plenty of mortgage money." He expects to sell 30 homes from \$14,000 to \$17,000 for his best year.

The city's largest builder, C. P. Hadley (400-a-year, mostly below \$10,000) sold 67 houses in January-February versus 25 in December. His secret is low cost and trades. Hadley took title to 150 old houses last year, expects 200 trades this year. In Wedgewood subdivision, when 28 builders buy lots and build, Sales Manager R. L. Pool says: "We sold 41 houses in January and February, plus 52 lots. There's a definite pick-up since New Year's."

San Antonio's market is good for builders with low-priced houses or builders who sell higher price houses aggressively. NAHB Secretary Jim Burke sold 110 in January-February, but stopped advertising because he was sold too far ahead of construction due to wet weather. Best seller is his \$8,250 FHA 203 model with 900 sq. ft. Burke is cheerful over 1958 sales. Quincy Lee, the city's other biggest builder, sold 39 homes in February, expects to reach a record 300 this year, priced from \$10,500 to \$18,000. Some builders are discouraged by a sticky market around \$20,000. But builder Weslie Cooper expects to sell 25 at \$25,000 or more for his best year.

San Antonio never had a big boom, was never overbuilt, does not build much ahead of sales. So the market is steady even though it is a low income area. Best sellers are all under \$12,000.

Oregon: Housing is showing more signs of life. FHA applications on new homes totaled 192 in February, compared to 112 in February a year ago. Applications on used homes rose, too, from 431 a year earlier to 509. FHA reports more optimism among both builders and realtors.

PHMI MEETING:

Prefabbers racing en masse to jump back into low-cost home market

Prefabbers are going back to the low-cost home.

A survey at the 15th annual spring meeting of prefabbers in Boca Raton, Fla. shows most members are either concentrating on the low cost market now or taking aim on it.

National Homes, biggest in the industry, reports great success with its low-priced (\$9,950 is typical) Fairlane model (Jan., News). Says George Cowee, sales vice president: "This model alone will account for the great bulk of our sales volume for the rest of the year."

Best Homes is producing two low priced models—\$9,450 and \$11,500 with land. They have already produced a spurt in Best's volume. Says President W. G. Best: "You could see the market for lower cost houses coming a year ago. When I noted the sales of smaller cars going up, I figured there was a big market for smaller and lower cost houses coming. It's here."

More join the trend

Lumber Fabricators and American Houses both have models aimed at FHA's Sec. 221 relocation house market. Inland Homes is shipping its model 690 (\$11,200 with land) into Dayton.

Pease Homes is planning three new models to sell below \$14,000 each. Comments James Pease Jr.: "Our sales people tell us we need models to qualify people who can't afford to spend more than \$100 a month for housing."

Knox Homes now has six models ranging from \$7,500 to \$9,000 (with land). "We expect that we're going to get a lot of help on houses like these and others a little higher in price by the new housing legislation which lets Fanny May buy mortgages up to \$13,500 at par," says President Peter Knox Jr.

Thyer Manufacturing Co. is bringing out a model to sell for \$9,600 to \$11,500, depending on land cost. Admiral Homes will soon have four to six models priced from \$10,000 to \$13,000.

Says Admiral President Frank Baldus: "With only \$405 down for a \$13,500 house as contemplated in the new housing bill, we'll have the easiest market we've had in years."

Other firms aiming at the low-price market: Harnischfeger, General, Wilson and Fairhill.

Besides the lower FHA down payments, prefabbers pointed to Fanny May's special assistance program for low cost houses (up to \$10,000), the probable extension of the VA program for World War 2 veterans and more direct lending in rural areas as justification for renewed emphasis on cheap homes.

Official pat on the back

FHA Commissioner Norman Mason encouraged the trend in his talk to the meeting. "Your industry knows that the mass market lies in the lower price range. You have made great progress in this field. I don't blame you for bragging about your houses in the \$10,000 to \$12,000 range," he said. "You've got something for which there is a tremendous market. The whole building industry should be concerned with this, too. It is just good merchandising to price your product within the paying ability of your market."

PHMI's outgoing president, George E. Price of National Homes, took a shot at government manipulation of housing. He complained: "It is folly to regard any particular annual

rate of home building as optimum. It is even worse folly to regard home building as a pump priming operation that can be started and stopped at the turn of an economic trend.

"Such a short sighted step would completely discourage the long-term planning that is absolutely essential to the success and stability of the home building industry."

Price conceded that PHMI supported the emergency anti-recession housing bill then before Congress but cautioned: "Beyond these emergency measures lies the urgent need for a long range housing program that will give greater stability to the conditions under which our industry must operate."

Before adjourning the prefab institute changed its name to Home Manufacturers Assn. Explained Price: "The name is far more expressive of the function we serve in the housing industry. Auto manufacturers do not say their autos are prefabricated. But that is the manufacturing principle they use. Instead of becoming preoccupied with a process the auto makers put all their stress on the product they manufacture. That is what I think we should do."



PREFAB'S DURSTON, KURTZ, SAMERDYKE
For the new bill: big smiles

Prefabbers elect American Houses' Durston president

Prefabbers chose an old hand as their new president. He is Horace N. Durston, 50, vice president in charge of the southern division of American Houses at Lumberton, N.C.

Spare, scholarly and soft-spoken, Durston got into house manufacturing in 1938 when he joined Steelman John C. Taylor who formed Century Houses Inc. of Ft. Worth, licensed by American to produce steel-frame homes. Durston was vice president and plant manager. When American bought out Century in 1939, Taylor became president and Durston chief purchasing agent. Later, he moved up to vice president in charge of manufacturing. Durston briefly assumed the presidency of American in 1955 when Taylor suffered a stroke (last month he was in a Miami hospital after a coronary attack). In 1956, American's directors named John R. H. MacDonald as president and Durston took over American southern operations.

Born in Salt Lake City, Durston spent his early life in Anaconda, Mont. and Ft. Worth. He attended Phillips Academy in Andover, Mass. (where his oldest son now goes to school), and the University of Virginia.

His hobbies are salt water fishing and boating, some golf. But Durston remarks: "Who has time for his hobbies these days?"

Other new officers: Eugene E. Kurtz, president of Inland Homes, vice president; and Frederick J. Samerdyke, president of Harnischfeger Homes Inc., secretary-treasurer.

NEWS continued on p. 52

Which is the best way to combine heating and cooling?

That depends on the size of your houses, the price range, the climate. Your Carrier dealer has the heating and cooling combination best suited to your needs. He'll show you how to do the job most efficiently and at the lowest price. He knows products and installation. He knows how to keep costs down without sacrificing performance. We suggest you discuss your house plans with him before they are made final.

Besides expert technical service, your Carrier dealer will

offer you the bonus of tested merchandise support. You have your choice of everything from brochures to billboards.

Remember, too, that Carrier is the best known name in air conditioning. It's a name that will look good on your own sales literature. Let a Carrier dealer show you what he can contribute to the value and sales appeal of your houses. He's listed in the Classified Telephone Directory. Carrier Corporation, Syracuse, New York.

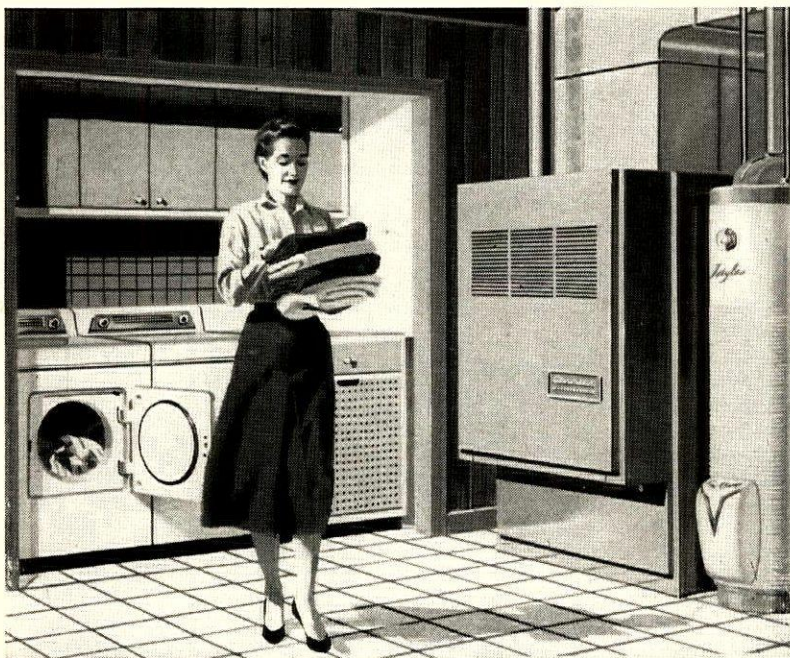

If you want the finest heating and cooling as standard equipment, choose the Year-Round Weathermaker.* It combines matching heating and cooling sections in one cabinet. Installs in utility room or basement. Takes little more space than average furnace. Special centrifugal fan is spring mounted, completely isolated from ductwork so fan sounds can't travel through the house. Available with gas or oil heating sections. Air or water cooled refrigeration sections.



If a heat pump is the answer for your houses, then investigate the Carrier Heat Pump Weathermaker. Its new two-piece design saves indoor space. Fan-coil unit can go in basement, attic, closet. Outdoor section houses refrigeration system, air-cooled condenser. The Heat Pump Weathermaker design eliminates need for air supply duct required by one-piece heat pumps. "Climate Balanced" design assures maximum efficiency over year-round temperature range, saves cost of oversized parts. *Reg. U.S. Pat. Off.

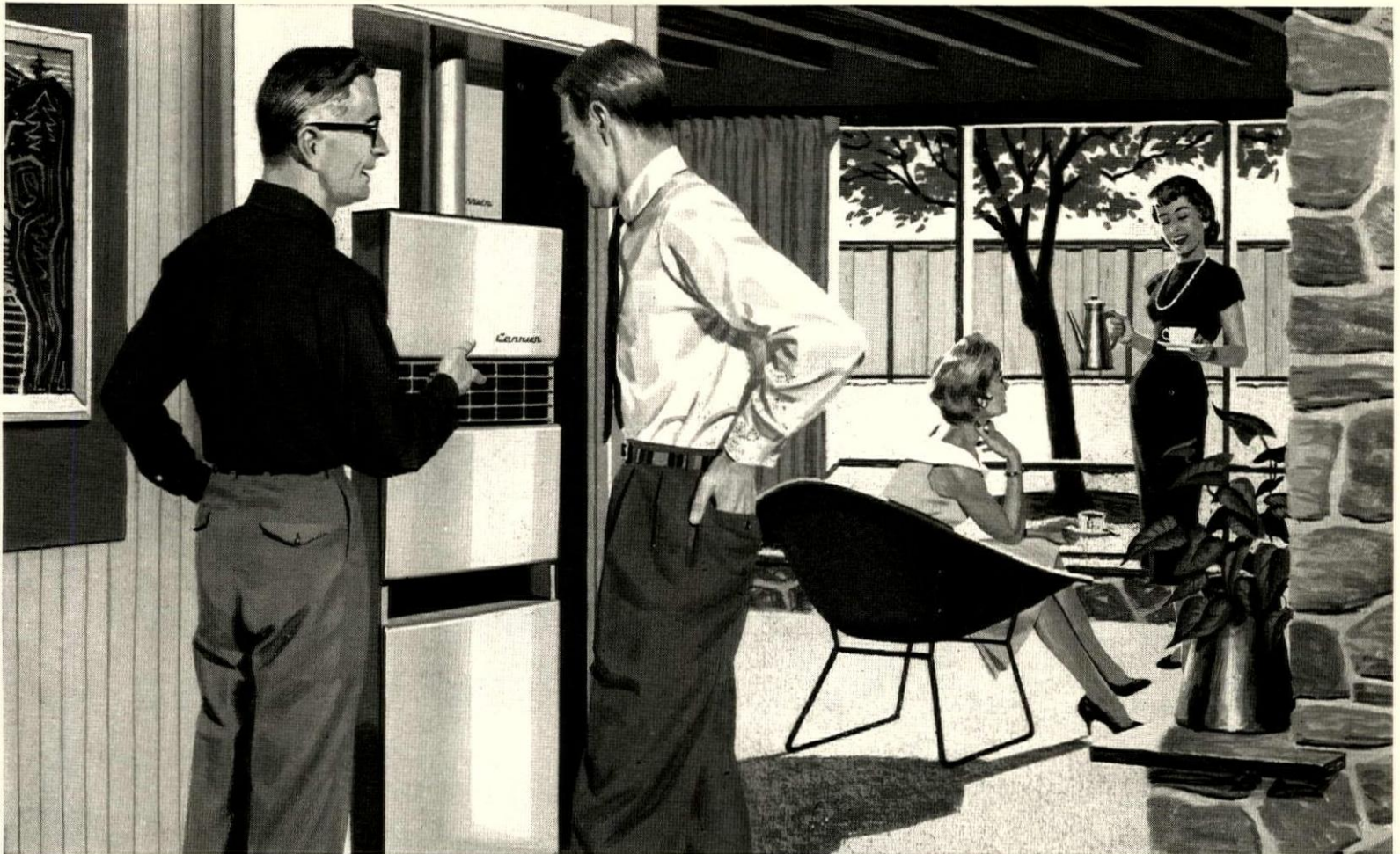

New Winter Weathermaker, "the Furnace with a Future." Casing, blower, heat exchanger are all specially designed to work efficiently in combination with air conditioning equipment. Measures only 14" wide and 26½" deep in popular 80,000 and 100,000 Btu/hr models. Fits easily into utility room or closet near living

area. Has complete line of matching plenums and cooling coils. Burns natural, mixed or LP gases. Upflow and downflow models. Capacities (gas-fired) from 75,000 to 185,000 Btu/hr input. Compact oil-fired models of the new Winter Weathermaker have capacities from .75 to 1.25 gallon per hour inputs.

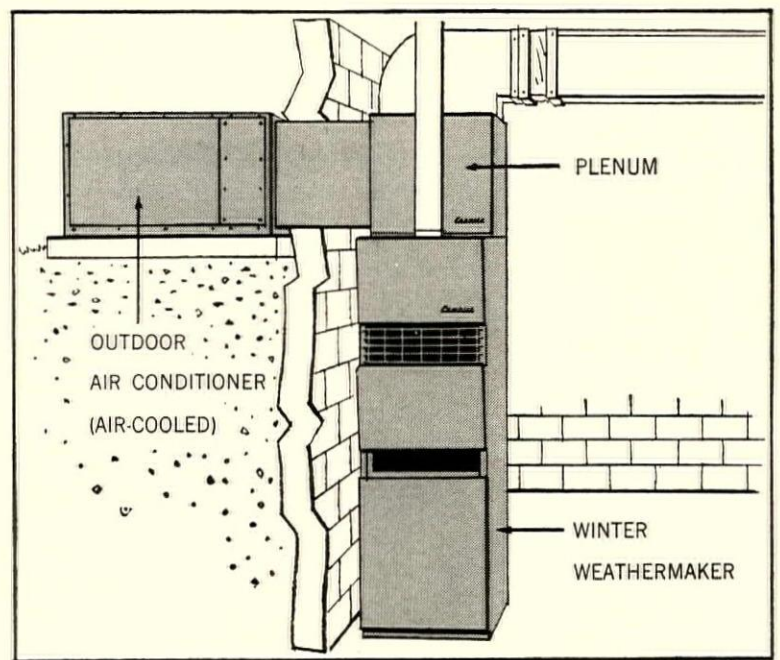
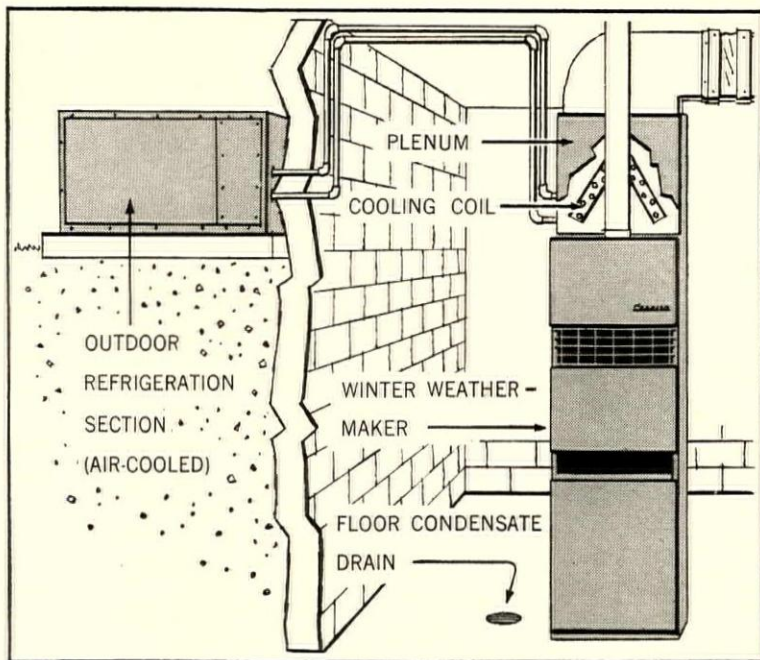

Matching Summer Weathermaker easily added. Up and downflow Winter Weathermakers provide year-round comfort when equipped with indoor cooling coil, outdoor air-cooled refrigeration section. Heating and cooling can be installed as original equipment. Or put in furnace, take simple steps to make later addition of cooling easy for home owner.

Offer heating and cooling at a budget price by installing a Carrier Thermo-Center. Up or downflow Winter Weathermaker and plenum is located near outside wall. Short duct connects plenum to new Carrier cooling section. Costs hundreds of dollars less than other systems. Or install heating only. Home owner can add cooling at low cost later.

"Home with a Future" promotion kit for builders. Carrier has prepared a new promotion for builders to dramatize the value of homes designed to make future addition of air conditioning easy, low cost. Includes hand-out brochures, outdoor signs, billboards—the works! Another example of the extra support you get from Carrier. Ask your local Carrier dealer about this new promotion.





SENATE BANKING COMMITTEE opens hearings on the anti-recession housing bill before a packed house. House later passed Senate bill without debate.

HOUSING POLICY:

How the anti-recession law will help

Repeal of discount controls means VA tracts again. But buyers remain a big problem. Looming: ever higher costs.

Like the Housing Act of 1957, the new anti-recession housing law which roared through Congress in a record three weeks is supposed to give home building a big shot in the arm.

The new measure is supposed to mean 500,000 more jobs and 200,000 more housing units. Whether it will or not is questionable.

What's happened to starts since last July, when the '57 law went on the books, is one clue. Starts have almost exactly paralleled their 1956 pace—all down except for a spurt in January which is overshadowed by February's dip.

The problem now is the recession. To put it another way: will people buy homes just because they are very much easier to finance and can now be sold with the lowest FHA down payments ever?

Will the law work? Some informed opinions:

"Unless we have markets for the products we produce, it won't do us much good to get improved financing," concedes NAHB President Nels Severin. "The average home builder will be cautious about going ahead because he's concerned about the market. Home building cannot reasonably be expected to pull the country out of this recession single-handedly. The individual home owner must have some personal security in feeling justified in buying a home."

"Massive government pump-priming in the mortgage market is not going to produce expanded home construction on an economically sound basis," says Managing Director Harold P. Braman of the Natl. League of Insured Savings Associations.

One definite result will be an upsurge in production of houses priced all the way up to \$14,000 or \$15,000. But few experts foresee any substantial increase in total starts. Instead, the consensus is the new law will keep housing volume this year up around 1 million—or possibly a little higher. (HHF Administrator Cole figures 1.1 million).

But, as Executive Vice President Norman Strunk of the

US Savings & Loan League notes: "Everytime we relax terms, we delay doing something fundamental about the problem of higher building costs. Some day we will come to the end of easy credit. What will we do then to sell houses?"

Adds an eminent San Francisco banker: "This country is recovering from financial indigestion—the gluttony of 1955 when the housing market was all but surfeited. Now, most of the excesses have been digested. The worst thing Congress can do is to let the whole cycle begin again."

The new legislation is a mixture of good and bad news for private housing.

Repeal of discount control on VA and FHA mortgages gets rid of the worst feature of the 1957 Housing Act—a provision which must take the major share of blame for shriveling the VA loan guaranty program.

Now, a revival of VA tracts, with their 2% down payments, is in prospect. Many a foresighted builder is already well along with planning and scores who switched from VA-FHA to all FHA last fall are switching back to combination terms again.

Higher VA interest will give this trend an extra nudge. In the mid-March money market, a 4¾% VA loan (30 year, 2% down) would have sold anywhere from 93 to 96. At the top of that range, discounts are low enough so most builders will feel the profit in building isn't swallowed up by financing costs. Besides, VA appraisals in many areas are celebrated for their liberality in covering discounts, even though the rule book says they should not do so.

Lower FHA down payments—the new measure cuts them to 3% of the first \$13,500 of appraised value—are supposed, in the words of the Senate banking committee which drafted the bill, to “make it possible for thousands of additional families to enter the market for new homes.” Whether they will chose to do so remains a question. One reason the administration let the big cut in FHA down payments authorized by last year's Housing Act go into effect at once, say authoritative Washington sources, is that White House advisers figure cutting down payments has almost never stimulated starts very much. (Last July, the government was still fighting inflation.) The key to the problem is availability of money. Now that there is plenty of money, lower down payments could have more effect on what happens.

Biggest potential dangers in the Sparkman Act are its Fanny May features.

Unless the administration uses great restraint, the \$1.55 billion Congress authorized Fanny May could upset the private mortgage market severely. The money is earmarked for Fanny May special assistance loans. This means 1) the government mortgage agency is compelled by law to buy them at par and 2) the Treasury puts up the money. Ordinarily, lenders could rely on a Republican administration to move cautiously to avoid market disruption. But the administration has just shoveled \$200 million into Fanny May special assistance funds to buy FHA and VA mortgages under \$10,000 (see p. 56). What worries lenders is whether this will lead President Eisenhower to take advantage of the new pump-priming authority from Congress to let Fanny May buy \$1 billion more FHA and VA mortgages up to \$13,500 under special assistance at above-the-market prices.

The President does not have to spend any of the FNMA money Congress has voted. Laws already on the books “authorize” the Treasury to buy FNMA obligations to provide it with money for special assistance buying. But they do not “require” or “direct” the Treasury to do so. So the

HOW FHA AND VA DOWN PAYMENTS NOW COMPARE

APPRAISED VALUE	OLD FHA LAW		NEW FHA LAW		VA	
	AMT. ¹	%	AMT. ²	%	AMT. ³	%
\$10,000	\$300	3.0	\$300	3.0	\$200	2
\$11,000	450	4.0	330	3.0	220	2
\$12,000	600	5.0	360	3.0	240	2
\$13,000	750	5.7	390	3.0	260	2
\$13,500	825	6.1	405	3.0	270	2
\$14,000	900	6.4	480	3.4	280	2
\$15,000	1,050	7.0	630	4.2	300	2
\$16,000	1,200	7.5	780	4.9	320	2
\$17,000	1,500	8.8	1,080	6.4	340	2
\$18,000	1,800	10.0	1,380	7.7	360	2
\$19,000	2,100	11.0	1,680	8.8	380	2
\$20,000	2,400	12.0	1,980	9.9	400	2
\$21,000	2,700	12.8	2,280	10.9	420	2
\$22,000	3,000	13.6	2,580	11.7	440	2
\$23,000	3,300	14.3	3,000	13.0	460	2
\$24,000	4,000	16.7	4,000	16.7	480	2
\$25,000	5,000	20.0	5,000	20.0	500	2

1—3% of first \$10,000 plus 15% of next \$6,000 and 30% of value above \$16,000. 2—3% of first \$13,500; plus 15% of next \$2,500 and 30% of value above \$16,000. 3—VA minimum down is a flat 2% (with closing costs to be paid in cash whereas FHA allows some to be included in mortgage). Since, under new bill, maximum insurable mortgage is \$13,500 (\$10,000 previously) lenders are not prone to accept 2% down above this.

ANTI-RECESSION HOUSING LAW AT A GLANCE

Repeals discount controls on FHA and VA mortgages.

Boosts VA interest ceiling from 4½% to 4¾%, but requires that FHA interest be at least ½% higher than VA (as it is now at 5¼%).

Cuts FHA down payments for sale homes under Secs. 203 and 220 to 3% of the first \$13,500 of appraised value.

Extends VA home loans for World War II veterans—both loan guaranty and direct lending—two years beyond their July 25 expiration date.

Provides \$150 million a year for direct VA loans, for the next two fiscal years and raises loan limit from \$10,000 to \$13,500.

Boosts interest ceiling for FHA military housing loans (which BLS classifies as public housing) from 4 to 4½%.

Gives Fanny May \$1.55 billion more authorization to buy FHA and VA loans under special assistance programs (i.e. at a mandatory par) as follows: \$1 billion for new FHA and VA loans not over \$13,500; \$500 million to be allocated by the President; \$25 million for regular FHA military housing; \$25 million for housing at research and development centers.

White House can pigeonhole this part of the new law without affecting the rest of it.

Testimony of administration spokesmen before the Senate banking committee gave a strong hint this might happen. HHF Administrator Albert M. Cole called the \$1.5 billion special assistance fund a “serious mistake . . . a shot of adrenalin we do not need.” He warned: “This public intervention would drive out private investment upon which the housing industry must depend for the bulk of its support in the long run.” Federal Reserve Chairman William Mc C. Martin, in a little publicized letter to the committee, branded more lending authority for FNMA as “neither necessary nor desirable.”

And FHA Commissioner Norman Mason added: “We will get the housing starts that are needed [to help combat the recession] because of what we have done up to now; we do not need to do any more.” (How many starts are “needed,” he did not say.)

Vice President Harry Held of New York's Bowery Savings Bank, speaking for the Natl. Assn. of Mutual Savings Banks, complained that the new Fanny May special assistance provisions would “convert FNMA from a secondary mortgage financing operation to a primary one.”

As Rep. Henry O. Talle (R, Iowa) pointed out in a talk to the American Bankers' Assn. savings and mortgage conference in New York, the Fanny May provisions cannot work anyway, without a boost in the national debt limit. “There is no leeway in the present debt limit for any such program,” he said.

Biggest argument in the Senate was over boosting VA interest.

It began in the banking committee. Sen. Homer Capehart (R, Ind.) tried to get VA's interest boosted to 5%, tying VA to FHA with a ¼% differential. The committee voted it down on a party line basis, 8-7. But two days later, the committee accepted the 4¾% VA ceiling, with a ½% differential, by a voice vote.

Sen. Mike Monroney (D, Okla.) promptly drafted an amendment to knock out the interest raise. He got 21 senators to sign it by the time the legislation reached the Senate floor. The Senate divided 47-47 on the Monroney amendment, which meant that it failed. The tie-vote divided largely along party lines, but six Democrats voted to let VA interest go up and six Republicans sided with a frozen 4½% ceiling.

Republicans then moved to nail down their victory by tabling a motion to reconsider. This brought another 47-47 vote. Vice President Nixon cast the tie-breaking vote to pigeonhole the Monroney amendment.

Sen. Jacob Javits (R, N. Y.) withdrew an amendment he had drafted to cut FHA's insurance premium from ½% to ¼% and extend maximum amortization from 30 to 40 years on Sec. 203. But he won assurances the banking committee would consider these changes when it gets around to the omnibus housing bill. (HHF Administrator Cole warns that cutting FHA's premium will plunge the now profitable agency into the red, forcing it to rely on money from the Treasury to meet operating expenses.)

NEWS continued on p. 56

American business buys more

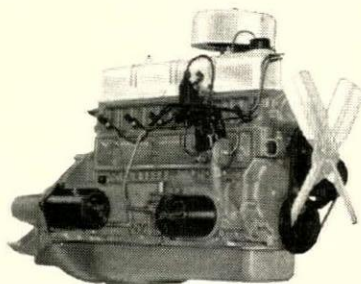

New Ford 139-hp Six.
Now with up to 10%
greater fuel economy.

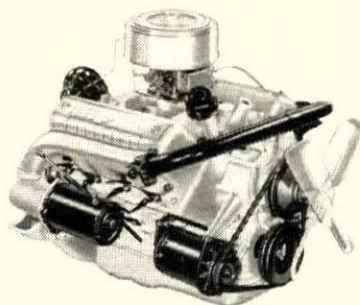

**New Ford 292-cu. in.
V-8 with 186 hp.** Bigger
cubic inch displacement
for greater pep and power.

Whatever your business . . . there's a Ford truck for your special needs

Official registrations for 1957 show that American business buys more Ford trucks than any other make. There are many reasons for this popularity.

To begin with, Ford offers a complete line of over 360 truck models, ranging from pickups to mighty Extra Heavy Duty tandems. And there are dependable Ford Dealers almost everywhere, ready to help you select the truck best suited for your individual job. They're ready with modern service facilities, trained mechanics and low-priced Ford parts to keep your trucks on the job, earning for you.

Ford trucks are your best buy, too! Ford's initial costs are *low* and resale value is traditionally *high*. Only Ford offers the economy of Short Stroke power in all engines, Six or V-8. And rugged chassis design means these new '58s are built to last. All this plus the proven fact that Ford trucks last longer adds up to America's No. 1 truck value.

See your local Ford Dealer right away for the latest in '58 trucks or the best in A-1 used trucks.



FORD TRUCKS than any other make!



Ford's F-250 Styleside pickup is well suited for fast, economical bulky-load delivery. Over 70-cu. ft. capacity; 7400-lb GVW. Choice of V-8 or Six.

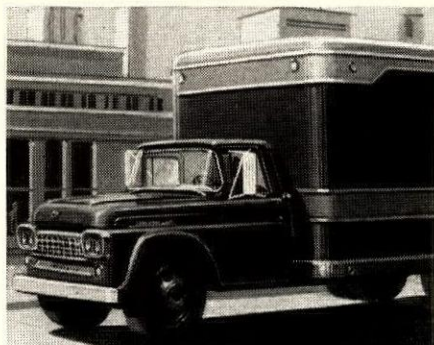

F-600 with van body is standout performer for straight truck service. No other two-tonner is so well built for proven longer life.



P-350 Parcel Delivery chassis with 104- and 122-in. wheelbases for 7- to 11½-ft. bodies with maximum load-space in stop-and-go service.

FORD TRUCKS COST LESS

... LESS TO OWN
... LESS TO RUN
... LAST LONGER, TOO!



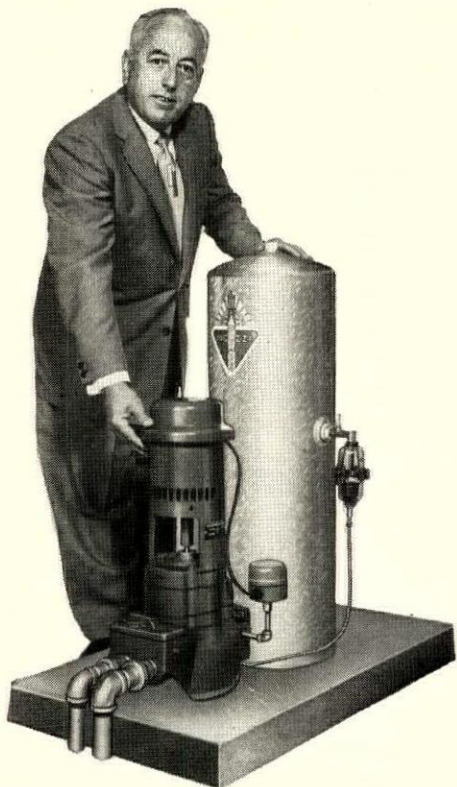

● Here's the ideal domestic water system for jobs beyond city mains. It's the Jacuzzi Deeprime Jet . . . the patented water system that has only one moving part and it's above ground . . . no motor, valves or moving mechanism down in the well to cause trouble — even on wells to 400 feet! You simply install it and forget it.

Owners like the Jacuzzi Deeprime Jet because it can supply water under high pressure at every tap simultaneously with plenty to spare for an automatic washer.

The Deeprime Jet is self-priming. Self-adjusting to changing water levels. Even shuts off when well gets pumped down. Over twenty-five thousand already in use under all types of pumping conditions. Recommend it . . . install it with complete confidence.

FROM WELLS TO 400 FEET AUTOMATIC WATER FOR HOMES, COTTAGES, MOTELS

● In addition to the new Deeprime Jet, your local Jacuzzi dealer can quickly supply Jacuzzi jet water systems in all price ranges for both shallow and deep wells to meet your specific requirements. Get his advice.

ALSO CONTRACTORS PUMPS POOL EQUIPMENT AND FILTERS

● Jacuzzi's self-priming pumps for builders and contractors drain water fast! Portable or stationary units in wide range of hp. ratings equipped with electric motor, gasoline engine or heavy duty transmission head. Also, the industry's most extensive high-quality line of swimming pool filters and equipment.

For technical bulletins and your supplier's name, contact our nearest factory office.

JACUZZI BROS. INC.

4100 Bayless Ave. • St. Louis 23, Mo.
HU 1-4400

Jacuzzi Avenue • Richmond, California
LA 5-3400

Canadian Factory: P. O. Box 514,
Toronto, Ontario

Branch offices in 16 cities coast to coast.

Administration pours more money into housing

The administration is trying to pump up housing with more money in two ways:

1. President Eisenhower released \$200 million in Fanny May special assistance funds to buy FHA mortgages up to \$10,000 at par (minus a ¾ point advance commitment fee and ¾ point purchase and marketing fee). This uses up all but \$36 million of the \$450 million Congress gave the President last year to pour into FHA as he chose.

Fanny May promptly wired its 1,800 originators that the loans are available. Most of the money will benefit only the South and Southwest where 1) money costs most and 2) where land and labor are cheap enough to produce a substantial volume of low priced homes.

The move looked to some Washington observers like an effort to deflate the Democrats anti-recession pump priming legislation.

One Texas mortgage banker is encouraging builders to build in smaller towns under this Fanny May deal. Most lenders still don't want small town loans, but there is a ready market for the homes.

2. The Home Loan Bank system is going into a longer term market for funds. The HLBB has authorized regional banks to make five-year loans to members to let them expand their own lending. Loans may be up to 5% of an association's savings capital (in addition to the present 12½% limit).

The HLBB has been considering this step for six months but held off because of the likelihood that it would have to pay so much to borrow the money (probably 4%) no local S&L would have paid 4½% to reborrow it.

Omnibus housing bill faces long delay

Passage of the anti-recession housing law removes much urgency for other changes in housing legislation this year. Sen. John J. Sparkman's adroit political seamanship neatly undercut the administration's late-arriving proposals to amend the Housing Act.

Administration proposals were delayed by a still unsettled internal debate over its much-discussed plan to let FHA insure only the top 20% of otherwise conventional mortgages (Dec. '57, News).

Now, chances are the Senate banking committee will not get around to hearings on the 1958 bill before mid-April. In the House, hearings probably will not start until May. The administration bill would:

1. Boost maximum FHA mortgages on one-, two- or three-family homes under Secs. 203 and 220 from \$20,000 to \$30,000.

2. Revamp FHA provisions to make trade-in deals much easier and eliminate double payment of closing costs. The bill would let builders obtain, for 18 months, the maximum terms allowed a home purchaser on the house taken in trade. If the house is not sold within 18 months the mortgage would have to be cut to the 85% limit on builders' loans. Meanwhile, the difference would be held in escrow.

3. Boost maximum interest rates to 4½% for FHA Secs. 207 (rental) and 213 (co-operatives).

4. Raise FHA's total insurance authorization by \$3 billion a year for each of the next five years, beginning July 1.

5. Sweeten profits in FHA Sec. 220 rentals by authorizing mortgages equal to total replacement cost including land, but excluding builders' overhead and profit for new construction. This would eliminate the troublesome question of limiting

continued on p. 84



BE CHOOSEY • BUY JACUZZI

OPINIONS:

Noteworthy comment on matters of moment to housing:



Emil J. Seliga, president, Talman Federal S&L, Chicago:

"If we get jittery now, we could repeat the mistakes of 1954 when we went overboard trying to reverse the business decline. At that time, credit eased too rapidly and extensively. Congress tried too hard to help through such programs as the Housing Act of 1954 which made home credit excessively easy and inflationary."



Rep. Henry O. Talle (R. Iowa), ranking minority member, House banking committee:

"This year Congress will make a fundamental decision on housing. The choice is one of making free enterprise work or entrenching government mortgages at undercutting interest rates."

Architect **Frank Lloyd Wright**, at a press conference at the Natl. Concrete Masonry Assn. convention:



"Public housing shows the desperate situation [of the country]. What right has government anyway to take a hand in cultural things? Government's proper role is as a policeman. It has no business in housing. It would be better to subsidize transportation for poor families so they can live in outlying areas than to put them in jail in center cities."



Lester C. Rogers, president, Associated General Contractors:

"Make-work, featherbedding and other restrictive practices continue to exist and are increasing despite lip service repeatedly given by labor leaders to the idea of a full day's work for a full day's pay."



Hugh B. Coddling, Santa Rosa (Calif.) builder-developer:

"Today's builder has to think more about developing planned communities, churches, parks and shopping facilities than he did a few years ago. The day of people just going out and building a house is over. Housing is becoming just a by-product. Today's builder has to make his money in shopping centers and practically give the housing away."

VIEWS ON THE NEWS:

Is politics partly to blame for housing's slump?

By Gurney Breckenfeld

Builders reflecting on the depressed state of private starts (a nine-year low in February) will do well to remember that the chief cause of the drop is VA's collapse.

FHA starts and applications are up. Conventional starts, as usual, are steady. VA's cave-in, as any builder knows, is heavily due to discount controls and frozen interest rates. These were imposed by the Democratic-controlled Congress over violent protests of the Republican administration.

It is probably a mistake to credit Democrats with so much Machiavellian insight. But February's fresh slump in housing (which they are so loudly trying to win votes by curing) is in large part their own handiwork.

Yet the administration, whose policies might well have made the downturn less severe, is getting most of the blame.

Now that there is more mortgage money than loans, nearly everybody is trying to give the home building industry still more money.

First the White House. Next the Home Loan Bank Board. Now Congress. But there is a big difference in the kind of money involved and what its use would mean to the nation's economy. The White House ladled out a drop-in-the-bucket \$200 million (which it already had) to Fanny May to buy FHA loans from \$10,000 down at par. This is supposed to generate more cheap new homes by paying more for the mortgages (par) than the market says they are worth. Actually, it looks more like a political maneuver to try to tone down the money tinkers in Congress. Anyway, first returns indicate it won't amount to much. In the first week, Fanny May had only one application for a loan.

The Home Loan Bank Board has decided to make five-year loans to S&Ls to let them expand their lending portfolios, in addition to the existing short-term (usually one-year) loans it already makes. The five-year money will be limited to 5% of an S&L's deposits. But that's in addition to the 12½% of deposits S&Ls can already borrow from home loan banks. The money involved here is not the taxpayer's. The HLBB is entirely S&L financed. In the long-run, this will let S&Ls convert short-term borrowing into long-term borrowing.

The \$1.55 billion Congress voted for Fanny May special assistance is a lot of printing press money—so much it can't be used without puncturing the legal limit of the national debt. This part of the Emergency Housing Act of 1958 sets a pattern of inflation that will compound, not cure, housing's problems. It does NAHB no particular credit to have espoused pouring even more—\$2½ billion—of Treasury funds into mortgage supports of questionable need. This is the same kind of benzedrine that got housing into trouble a few years back.

Savings and loan men worry over AFL-CIO opposition to their far-reaching plan to insure 90% conventional loans through a new corporation under the S&L-owned Home Loan Bank Board. This may actually hurt their chances of persuading the Democratic Congress to adopt the plan, they fear. They are unworried over lack of support from the White House, blame it on FHA and HHFA lobbying for their own version of the idea (which would substitute public for private credit).

SEMANTICS CLASS: Prefabbers have decided that prefab is an ugly word. Too much association in the public's mind with those wartime boxes that almost no prefabber makes any more. So the Prefabricated Home Manufacturers' Institute (PHMI) has switched its name to Home Manufacturer's Assn. (HMA). The Natl. Savings & Loan Assn., tiny (560 members) rival of the giant (4,400 members) US Savings & Loan League, has changed *its* name to Natl. League of Insured Savings Associations. This is a case of confusing identity. The smaller league wants to differentiate itself from the bigger one, now that merger talks have been shelved.

...omes

...FOODS

...are N. W.

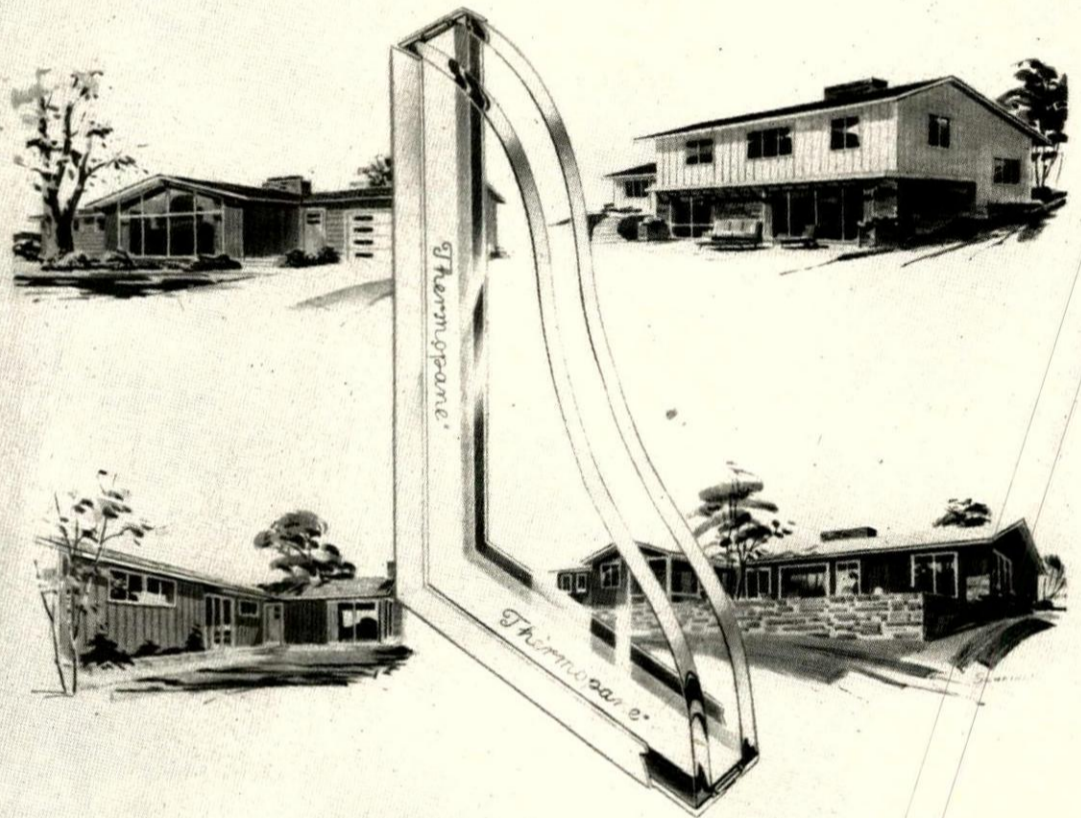

BETTER YOUR LIVING in a new home
 built with products like *Thermopane*®

Now's the time to buy a new home! When you look at the exciting 1958 models, you'll see how much you're missing.

Today's good houses—at all price levels—are better planned! Better built! More economical to maintain! They offer much easier, more pleasant and comfortable living. That's because builders are using advanced building materials, like *Thermopane* insulating glass!

Builders know that without windows of *Thermopane* a house is only *partially* insulated. It will be cooler in winter—harder to heat; hotter in summer—harder to keep cool.

Thermopane cuts heating and cooling costs. Keeps you more comfortable year 'round. *Thermopane* protects you from drafts. Cuts down fogging and frosting. And you can forget storm sash.

This week end, plan to visit the model homes on display in your community. You'll discover outstanding models like those shown above. Write for a beautifully illustrated booklet describing *Thermopane* and what it can do for you. Only 10c. Dept. 658, Libbey-Owens-Ford Glass Company, 608 Madison Avenue, Toledo 3, Ohio.

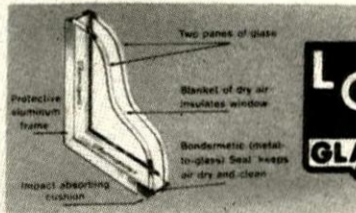

LOF
GLASS

Thermopane
 INSULATING GLASS

LIBBEY-OWENS-FORD

a Great Name in Glass TOLEDO 3, OHIO

"We need the advertiser's help
in making people want better homes"



DAVID SLIPPER, *President*
WEBB & KNAPP COMMUNITIES, INC.

so *Thermopane*[®] is telling all America:

"Better your living in a new home!"

Your better prospects, the millions who read the "shelter" magazines for "better living" ideas, will see the L·O·F advertisements that say:

"Today's good houses—at all price levels—are better planned! Better built! More economical to maintain!"

And to illustrate, the advertisement explains how *Thermopane* insulating glass, for example, makes homes more comfortable, more economical to heat, pleasanter to live in all year 'round.

This advertisement (and others to follow) urges readers to visit model homes. When they do, they'll be looking for "better living" features, like *Thermopane*. Put it in every window of your model home—even if you only offer it as an option.

Be sure to ask for *Thermopane* merchandising helps. Call your L·O·F Glass Distributor (listed under "Glass" in the Yellow Pages), or write to Dept. 948, Libbey·Owens·Ford Glass Company, 608 Madison Avenue, Toledo 3, Ohio.

◀ Full color advertisements, like this, in *American Home* and *Better Homes & Gardens* promote new home sales.



LIBBEY·OWENS·FORD a Great Name in Glass
TOLEDO 3, OHIO

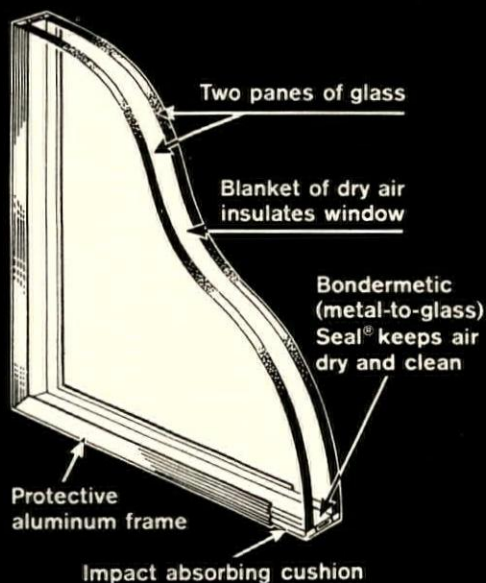

2 NEW, IMPROVED KINDS OF *Thermopane*

Thermopane (left) with the famous Bondermetic (metal-to-glass) Seal[®] now has clean-cut edges (maximum strength) cushioned by a special mastic and further protected by an aluminum alloy frame.

GlasSeal[®] *Thermopane* (right) sets new quality standards for all-glass insulating units. Made of DSA sheet glass, its uniformly rounded, smooth, true edges make glazing easier, faster.



MORTGAGE MARKET:

VA revives in Texas, California as easier money lifts discount barrier

VA housing, written off as dead seven months ago, is beginning to show remarkable signs of life.

Builders in Texas and California are switching tracts back to VA despite its 4½% interest rate and discount controls. Some are planning new VA projects. Two developments make it possible:

1. Prices on VA mortgages have jumped another 1 to 2 points above mid-February, reaching an average 92-93 spread.
2. VA boosted its discount ceiling by one point.

Now, the VA mortgage market is up to 92½ in California, 93 in Texas.

HOUSE & HOME's exclusive monthly mortgage roundup

Discount ceilings are 1 point higher in each place. But a 1 point commitment fee covers the gap. David Northridge, vice president of Los Angeles' Colwell Co., has commitments for \$7 million in new VAs. "Our builders can live with a 7½ point discount on VAs. They're used to it," he explains. The truth is simple: inflated appraisals cover most of the discount. As one mortgage man observes: "They always have out here."

Almost as soon as the Senate began debating a higher VA interest rate, mortgage men began hedging forward commitments.

Los Angeles' Northridge notes that commitments he's negotiating provide if the VA rate goes up to 4¾%, the price will be 94½ instead of 92½. Few builders are going back to a 100% VA program. Instead, they are using VA to supplement FHA in the hope of tapping more market.

California builders contend they have a big VA market left, a result of transferred veterans regaining VA eligibility. But in Texas Donald J. McGregor, executive vice president of the T. J. Bettes Co., says: "We here feel the VA market has been satisfied for the most part. But builders feel there is something left—particularly in the low-cost range."

FHA prices also continue to improve, leading to speculation that FHA may cut its interest rate from 5¼ to 5%.*

Mortgage Banker W. A. Clarke of Philadelphia predicts some lenders may cut the rate before FHA does, a belief supported by other mortgage bankers. Says Clarke: "It could happen faster than anyone expects."

FHA prices are higher in 11 of the 16 cities checked in HOUSE & HOME's monthly mortgage survey. They are up from ½ to 1 point in Cleveland, Chicago, Houston, San Francisco, Los Angeles, Philadelphia, Detroit, Atlanta, Jacksonville, Washington and Oklahoma City. Par (or better) markets are reported in Boston, New York, Newark and Philadelphia.

Conventional interest rates are slipping in five cities. They are down at the top from 7% to 6.6% in Los Angeles and San Francisco (the bottom: 5½ in LA; 5¾% in San Francisco). Drops of ¼% in the prevailing rate were noted in Newark, Philadelphia and Oklahoma City.

Anticipated heavy buying from Fanny May has not yet developed.

Why? Because Fanny May prices are still 1½ to 2½ points above the market in most areas. Examples: T. J. Bettes closed a \$7 million deal, selling VA mortgages it has serviced for Fanny May to a New York savings bank for 95½ vs. the current market of 93. Citizens Mortgage Co. of Detroit bought \$5 million in VAs for resale to an investor. It paid 94, which Vice President Harold Finney calls "completely unrealistic." The VA market in Detroit is 92½.

Some savings banks are demanding that mortgage bankers sweeten a Fanny May package by cutting their servicing fee to ¼%. They argue that if the originator doesn't sell them and keep servicing, someone else will and the originator will lose the servicing.

Net effect of FNMA sales may well be that mortgage bankers simply trade servicing accounts and cut servicing prices in the bargain—just at a time when servicing is becoming more expensive. Collections are getting tougher. Eight of 16 mortgage bankers reported delinquency rates up in March though none called the rate alarming yet.

*If (as seemed likely when this article went to press) Congress pegs the VA interest ceiling at ½% below the FHA rate, chances are FHA will stand on 5¼.

Gov. Harriman vetoes bill to permit conventional loans for 10% down

A bill boosting maximum conventional mortgage limits from 80 to 90% for savings banks met a surprise veto by Gov. Averell Harriman last month in New York.

The measure was being hailed as one of the most important non-federal pieces of housing legislation in years before the governor squashed it. It also boosted maximum amortization for savings bank conventional loans from 20 to 30 years and boosted the maximum high-percentage loan from \$15,000 to \$25,000. (Under existing law, savings banks can lend 80% of the first \$15,000 valuation, but only 50% above that.)

'Risky,' says banking department

Harriman acted on advice of his banking department which remained silent as the measure went through the legislature, then announced the higher loan ratio would be "extremely risky." The department told the governor: "Experience has shown that in times of declining real estate markets, expenses of foreclosing a mortgage on even a \$10,000 home, including tax arrears, interest, foreclosure costs, repairs and sales commissions, frequently amount to \$2,000. Thus, it can be seen that a mere 10% equity in a modest one-family home would be exceeded in most cases even by foreclosure costs. Our fundamental concern is for the safety of savings bank investments, and only a clear and convincing proof of necessity for such investments could possibly out-weigh this fundamental objection."

Disappointed savings bankers translate this as follows: "The banking department is saying 'Why use private credit for high-ratio home loans when we've got the crutch of FHA and VA?' We were hoping to do something to make such reliance on federal support less necessary."

Republican legislature leaders attacked the veto as "an indefensible 'do nothing' approach to remedy the drop in housing." They planned to introduce new bills to meet technical objections the governor raised. But savings bank men predicted: "The idea looks dead for this year."

Reserve like FHA's

The vetoed measure imposed no limit on how many 90% loans a bank could make in proportion to its assets. The only significant requirement is that a bank set up a reserve equal to ½% per annum of the declining balance of the loan to be charged and reserved in virtually the same fashion as FHA's ½% insurance premium. The law forces banks to leave these reserves intact.

The legislature was also considering legislation to extend the same liberal lending terms to savings & loan associations and insurance companies, though federally chartered S&Ls would still be limited to 80% loans.

The savings bank measure was initiated by the New York State Home Builders Assn. with support from most of the state's big savings banks. It won bi-partisan support in the Republican-controlled legislature, passing with only seven dissenting votes in the Senate, only two in the Assembly.

Many New York builders, particularly on Long Island, were planning to convert their tracts to the new conventional plan if the governor had signed the bill. Several big New York City savings banks had announced they would start lending on the new terms (though not on every conventional loan).

Said one savings banker: "Every builder we talk to is getting ready to change over. Remember, he can get a commitment from us in one week where it now takes him six to eight weeks to get one out of FHA—plus all the extra paper work and the inspections. One builder estimated that on a \$15,000 house he will save about \$500. That is just added profit for him."

He predicted the conventional plan would be used most in tracts where prices are \$16,000 and over—which includes 90% of New York tracts. Over \$16,000, FHA down payments shoot up (30% of the appraised value over \$16,000), giving an advantage to the conventional plan from the buyer's viewpoint as well as the builders.

Supporting the 90% loan principle in a speech to the NAHB convention in January, President George C. Johnson of Brooklyn's Dime Savings Bank explained: "I'm convinced a 90% 30-year conventional loan is sound and inherently safe. The true test of soundness of a mortgage loan is not the down payment or length of term but the skill and ability of the lender to make a proper appraisal of the property and the borrower's credit."

MORTGAGE BRIEFS

Chase to resume warehousing

Chase Manhattan Bank is ready to start warehousing FHA and VA mortgages again, assuming enactment of the anti-recession housing bill which kills discount controls.

Vice President John Scully says Chase has \$100 million to lend originators and builders. The money would probably be loaned at 5% (possibly less) plus a 1 point warehousing fee. Chase Manhattan has not warehoused mortgages for two years.

IRS rules on FNMA stock

Cost of buying Fanny May stock that brings only half what builders must pay for it cannot be deducted as a business expense for tax purposes.

The Internal Revenue Service has ruled that payment for the stock must be capitalized. And it must be valued at its cost not current market value. Any loss in subsequent disposition (now about 50%) is a capital loss.

IRS also has ruled that marketing fees paid to Fanny May are items of business expense.

Mortgage volume off 10%

Amid last year's tight money, savings and loans trimmed their residential mortgage lending least. Their dollar volume for home loans fell only 3% from 1956.

Home loans by insurance companies were off 18%; commercial banks 22% and mutual savings banks 22%, says the Federal Home Loan Bank Board. Total home mortgage investment (based on estimates of nonfarm mortgages of \$20,000 or less) reached \$24.2 billion last year. That is 10% behind 1956 (vs. a 9.5% drop in private housing starts).

Other findings on residential lending by type of mortgagee (amounts in millions):

Mortgagee	Amt. 1957	% Chg.		% of total	
		from 1956	% of total 1956	1957	1956
S&Ls	\$9,217	-3	38	35	
Ins. Cos.	1,427	-18	6	7	
Comm. Banks	4,264	-22	17	20	
Mut. Sav. Bks.	1,430	-22	6	7	
Individuals	3,554	†	15	13	
Miscel.	4,307	-12	18	18	
TOTALS	24,244	-10	100	100	

† Less than 0.5%.

Easier money revives mortgage brokers' business; fee cuts common

By John Senning

Prosperity has returned for housing's money middleman, the mortgage broker—at least for awhile.

The sudden easing of the money market which brought eastern savings banks back into the FHA-VA out-of-state market has produced more business for most mortgage brokers (in the housing field) in three months than they had in all of 1957.

But with the turn of the market have come stiffer competition and fee cutting in a business which has always been notorious for back-stabbing. (One broker's description: "It's a business based on rumor mongering and character assassination.")

Fee cutting is just one of the broker's problems. The 1957 famine produced a big shakeout in his business—and it may not be over yet. It also gave many mortgage men pause to reflect on the broker's future—or the lack of one.

The average broker who depends upon housing (unlike the broker who deals exclusively in conventional deals on commercial properties) lived on standby commitments, distress merchandise and carryover deals in 1957. Says Frank FitzGerald of FitzGerald, Reed & Bisco: "If you had no carryover from 1956, you were in trouble." There was plenty of trouble.

Mortgage brokerage is a business where overhead has traditionally been high. Brokers

Fabian Bachrach



FITZGERALD

liked plush offices. They used expense accounts lavishly to entertain both ends of the pipeline: bankers in New York and loan originators in the South and West. Their staffs were large. Such plush operations grew to be a habit in the halcyon late 40's, when brokers were collecting 1 to 3 point premiums on FHA and VA loans from savings banks, as the latter unloaded their wartime glut of government bonds to buy higher yield FHA and VA mortgages.

Then came tight money

Last year changed all that. The shakeout which inevitably followed the drop in business broke up some firms. Overhead had to be cut and it was—or the business folded. Staffs of salesmen were halved. Expense accounts and entertainment were reduced drastically.

Pringle-Hurd, long the biggest firm in the field, broke up. Max Pringle (though seriously ill recently) runs the old firm. Richard Hurd has his own office dealing in conventional mortgages only. Jack Eleford and Ernie Rutgers left Pringle to set up their own business.

Huntoon - Paige, another one of the big firms, has split up. J. P. Huntoon has started his own business, operating in a new way. Five partners now run Huntoon, Paige & Co.

Frank McRedmond, once a salesman with Housing Securities, is in business for himself. So are other salesmen—though the one-man office has never been notably successful in selling out-of-state mortgages.

Biggest brokers still active in housing—all in New York City except as noted—are Prin-

gle; Huntoon; Housing Securities; Eleford & Rutgers; FitzGerald, Reed & Bisco; Eddy Armstrong; Lowell, Smith & Evers, Inc.; Lomas & Nettleton; J. Kislak of Newark; Howard Ludington of Rochester and Jack Halperin.

Scrambling for mortgages

Brokers are having more trouble finding mortgages than money today. Says Tom Coogan, president of builder-owned Housing Securities: "We have trouble getting anyone to sit still. We get an offering and by the time we get it settled with a buyer the seller decides he wants another point."

Brokers have been towing savings bankers by the dozens to the West Coast to look at properties and make deals (though few savings bankers will commit themselves on the spot for fear of the state ruling they are doing business there, subjecting them to laws and taxes governing foreign corporations).

Bankers are complaining that many originators are backing out of commitments made months ago. A builder who committed in November at 89 on VAs would rather forfeit a 1 point fee and sell at 92 today.

One broker, as he was being interviewed by HOUSE & HOME, was interrupted by a phone call. He was told

by a banker, who had agreed verbally to deliver a package out of portfolio at 94, that the package was no longer for sale—even at 96 net. (This was the day after the Fed cut its discount rate to 2½%.) And the broker had already found a buyer.

As brokers scramble for mortgages, fee cutting is common, though it is hard to find a broker who admits it. All fingers point to those "other bastards."

Originators are less secretive. They admit that ¼ point is as common today as the usual ½ on immediate sales. At least one big deal has been closed at ⅛.

Are brokers necessary?

There are those who feel the mortgage broker will eventually pass out of the housing picture. Robert Tharpe, president of the mortgage banking firm of Tharpe & Brooks of Atlanta, foresees the day when more originators will deal direct with banks. "I think we should make our own contacts."



COOGAN



ELEFORD

continued on p. 64



TRUSCON...

Trained Salesmen help you
build better, economically
...for faster Sales



REPUBLIC STEEL KITCHENS offer "her" cabinets of "her" choice for every kitchen storage need and counter arrangement—available *right from stock*. The open-plan arrangement, above, features an island or peninsula center that provides generous storage and counter space with handy access to cabinets from either side. Sturdy wall cabinets, hung from ceiling rods, have shelves that adjust to comfort reach. For kitchen planning ideas send for the "102 Ways" booklet. See your RSK distributor.

TRUSCON HOLLOW METAL SWING DOORS AND FRAMES are as handsome as they are functional. Doors swing open easily, close silently because whisper-quiet, sound-deadening insulating material absorbs noise. Truscon doors are easy to install. No cutting, trimming, planing, sanding needed. Simply erect the steel frame and hang the door. No pre-paint preparation needed. Just one-coat paint-to-match room decorations. For additional facts, details, sizes—write today.



TRUSCON SERIES 138 DOUBLE-HUNG WINDOWS are ever-popular, low-cost. Operated on stainless steel balances, they open and close with fingertip action. Stainless steel weatherstripping keeps weather out, comfort in—reduces fuel and air conditioning costs. Truscon 138 Double-Hung Steel

Windows are available in a wide range of sizes up to 5 feet wide and 6 feet, 5½ inches high for picture window luxury. Unit above features fixed picture window at center. Truscon dealers everywhere are ready, willing and able to help you with your building plans.

Naturally, you prefer to deal with a man who knows his business.

And the men who represent Truscon and Truscon Dealers are trained to help you solve building problems. As active participants in "O.M.I." (Order Makers Institute—Truscon's sales training program), these experts-in-their-field can help you turn shoppers into buyers. Here's why:

They know Truscon Products—from the smallest basement or utility window to the largest picture window unit. They can recommend the right Truscon building product or accessory with the style, size, and convenience for greater home buyer appeal.

They know installation. Because they are Truscon-trained, they are skilled at adapting out-of-warehouse-stock standard Truscon items to special conditions and applications. And they work with developers and builders to reduce installation costs and increase sales values.

They know the importance of jobsite decisions. Truscon-trained representatives have the know-how and ability to make on-the-jobsite adjustments that keep building schedules on time and keep building costs low.

Seeing building ideas come to life is the job of your Truscon-trained representative. To learn more about Truscon and Truscon building products, call your Truscon representative—or send coupon below.

REPUBLIC STEEL



*World's Widest Range
of Standard Steels and
Steel Products*

REPUBLIC STEEL CORPORATION
DEPT. HO-5363
1441 REPUBLIC BUILDING • CLEVELAND 1, OHIO

Please send literature for the following subjects:

- Truscon 138 Double-Hung Windows
- Republic Steel Kitchens "102 Ways" Booklet
- Truscon Interior Steel Doors
- Have representative call

Name _____ Title _____

Firm _____

Address _____

City _____ Zone _____ State _____



5-FOOT

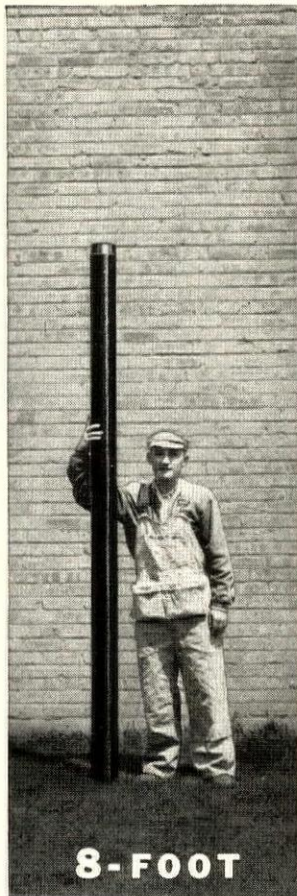

8-FOOT



10-FOOT

Choice of 5-foot, 8-foot, and 10-foot lengths, pioneered by L-M. Permaline fibre pipe is light and easy to handle, resists alkalis, acids, hot water, settling, and heaving. Taper-tight couplings are waterproof and root-proof.

L-o-n-g Lengths Make Permaline Fibre Pipe Easier to Install

With 10-foot lengths, you make only half as many joints as with 5-foot lengths. And Permaline tapered couplings are simply *tapped* onto the tapered end of the pipe to make a permanent, watertight, root-proof joint. No cement—no calking—just drive it!

Permaline fibre pipe is light and easy to handle. Several lengths may be joined on the ground before lowering them into the trench. Permaline pipe resists soil acids and alkalis, hot water, freezing, thawing, and settling—without leakage!

Get complete information on the many advantages of Permaline pipe. Mail the coupon—or ask your wholesaler to get in touch with us.



Sewer installation at a project home, by N. J. Rodrigue, Plumbing Contractor, Houma, La. Permaline comes in 5, 8, and 10-foot lengths. Diameters 2, 3, 4, 5, 6, and 8 inches. Full line of fittings, adapters.

L-M PERMALINE BITUMINOUS FIBRE PIPE for better sewers and drains



LINE MATERIAL INDUSTRIES • McGraw-Edison Company



This seal is your guarantee of recognized quality in Bituminous Fibre Pipe.

320

Mail This Coupon

LINE MATERIAL INDUSTRIES, Milwaukee 1, Wisconsin
Send me free bulletin with complete information on L-M Permaline Fibre Pipe for sewers and drains.

Name _____
Company _____
Address _____
City _____ State _____
Type of business, please _____

Trend away from straight mortgage brokerage noted

he says. "We have enough middle men in this business."

Comments another mortgage man: "The trend is away from the broker toward the straight correspondent. Moreover, savings banks are reaching out further to buy loans direct with servicing from New York."

Undeniably there is a movement toward new types of mortgage brokerage and even away from brokerage of any kind.

Eleford & Rutgers have set a new pattern by signing eight originators in eight non-overlapping geographical areas and representing them exclusively in New York. Instead of a flat percentage fee, they get an \$8,000 annual retainer from each firm plus a nominal 1/8% fee on all deals.

Immediate service

Jack Eleford predicts more brokers will eventually do business his way. He contends its better for originators, better for the banks: "If an originator asks a group of brokers to find a buyer for a package of mortgages, it may take a week or two for an answer. These brokers have other deals to work on. We can work on our client's case immediately"

Eleford got a call from his Los Angeles originator, the Wilshire Mortgage Co., while HOUSE & HOME was interviewing him. Wilshire wanted 60 commitments on 203s in Phoenix. Said Eleford: "I'll have them for you in a couple of hours." He did.

Eleford contends his method of operation is favored by banks as well. "They call us because they know we can control our supply."

J. P. Huntoon has adopted a similar operation, represents nine originators exclusively—charges them a flat fee sliding down to 1/4% with no retainer.

His old firm, Huntoon, Paige & Co. has no exclusive clients but does have originators who sell exclusively through H-P. Says David Northridge of The Colwell Co. in Los Angeles, one of Huntoon's originators: "It is a better arrangement. There's no shopping around from one broker to another to worry about." FitzGerald, Reed & Bisco also represent several originators on an exclusive area basis. They also deal in other areas.

A correspondent system

Some mortgage men believe more banks will eventually go to a correspondent system as insurance companies have—particularly as changes in state laws make it unnecessary for them to qualify as foreign corporations when they buy mortgages at the point of origination.

Bowery Savings Bank in Manhattan, largest in the country, has a modified correspondent plan—makes allocations to its originators each year. But it also buys from brokers. The Philadelphia Society for Savings also makes annual allocations.

And savings banks are buying and servicing direct further and further from New York. Emigrant Savings, third largest in the US, restricts its lending to an area as far south as Washington and an equal distance west and north. So does the big Lincoln Savings Bank. Other banks buy and service their own mortgages as far west as Ohio.

The here-to-stay school

Most originators and savings bankers contend brokers will remain a permanent part of home financing. They agree with Broker FitzGerald who argues: "The Northeast will continue to be an area of surplus capital and

other areas will continue to be capital-short areas. As long as that is true there will be a need for men who can bring the two areas together."

T. J. Bettes of Houston, biggest mortgage banker in the US, has what amounts to its own broker in New York—an employe who negotiates Bettes' deals direct with banks. Yet Donald McGregor, Bettes executive vice president, admits: "Anyone with a smaller operation than ours needs someone in New York. He can't have someone running around the city looking for money. He has to have his entré through a broker."

President Tom Lively of Centex Construction Co., Dallas, biggest US home builder,

uses brokers on his military and rental housing projects. He comments: "It's advantageous for us to use a broker. He has 50 investors whom he can contact immediately. But if we had to go to New York and knock on 50 doors it would take too much time and we might not find the money until the 50th one."

Banks protect brokers' fees

There are 128 savings banks in New York City. Only two or three still do not buy out-of-state FHA and VA mortgages.

No savings banks work on an exclusive basis with a mortgage broker as an originator

does, though some banks favor two or three brokers whose judgment they trust.

Most banks protect a brokers fees. Thus if an originator tries to bypass a broker who brought the originator and bank together first, the bank will insist the broker get his fee. And occasionally it is the originator who protects the broker from a bank which tries to buy direct. One good reason: mortgage brokers supply about 60% of the out-of-state FHAs and VAs bought by savings banks.

Volume of mortgages purchased by banks through brokers range from 90% of all purchases in a few instances to 20% in others.

NEWS continued on p. 68

MORTGAGE MARKET QUOTATIONS

(Sale by originating mortgagee, who retains servicing. As reported to HOUSE & HOME the week ending Mar. 15)

FHA 5 ¹ / ₄ s (Sec. 203) (b)									
MARKET TRANSACTIONS									
City	Conventional Interest Rates	FHA Discount Ceiling	FNMA Price xy	Minimum Down* 30-year		Minimum Down* 20-25-year		10% or more down 20-25-year	
				Immediate	Future	Immediate	Future	Immediate	Future
Atlanta	5 ¹ / ₂ -6%	98	97	97-98	97-98	98	97-98	98-98 ¹ / ₂	98
Boston local	5-5 ¹ / ₂ %	99 ¹ / ₂	98	par-101	par-101	par-101	par-101	par-101	par-101
Out-of-st.	—	—	—	97-98	97-98	97-98	97-98	97-98	97-98
Chicago	5 ¹ / ₄ -5 ¹ / ₂ %	98	97	99b	98-99	99b	98-99	99b	98-99
Cleveland	5 ¹ / ₂ %	98	97	98	97b	98	97b	98	98
Denver	5 ¹ / ₂ -6%	97	96 ¹ / ₂	97-98	97-98	97-98	97-98	97-98	97-98
Detroit	5 ¹ / ₄ -5 ¹ / ₂ %	97 ¹ / ₂	96 ¹ / ₂	97 ¹ / ₂	d	97 ¹ / ₂	d	98-98 ¹ / ₂	d
Houston	5 ¹ / ₂ -5 ³ / ₄ %	97 ¹ / ₂	97	97 ¹ / ₂	97 ¹ / ₂	98	98	98 ¹ / ₂	98 ¹ / ₂
Jacksonville	5 ³ / ₄ %	98	97	97 ¹ / ₂ c	97 ¹ / ₂ c	97 ¹ / ₂ c	97 ¹ / ₂ c	98	98
Los Angeles	5 ¹ / ₂ -6.6%	97	96 ¹ / ₂	97-97 ¹ / ₂	97-97 ¹ / ₂	97 ¹ / ₂	97 ¹ / ₂	98	98
Newark	5 ¹ / ₂ %	98 ¹ / ₂	97 ¹ / ₂	par	99 ¹ / ₂	par	99 ¹ / ₂	par	99 ¹ / ₂
New York	5 ¹ / ₂ %	99	98	par	par	par	par	par	par
Okla. City	5 ¹ / ₂ -6%	97 ¹ / ₂	96 ¹ / ₂	97b	97b	97-98	97-98	98-99f	98-99f
Phila.	5-5 ¹ / ₂ %	98 ¹ / ₂	97 ¹ / ₂	99-par	99-par	99-par	99-par	99-par	99-par
San Fran.	5 ³ / ₄ -6.6%	97	96 ¹ / ₂	97-97 ¹ / ₂	97-97 ¹ / ₂	97-98e	97-98e	97 ¹ / ₂ -98	97 ¹ / ₂ -98
St. Louis	5 ¹ / ₄ -6%	97 ¹ / ₂	97	96 ¹ / ₂ -98	96 ¹ / ₂ -98	97-98	97-98	97-99 ¹ / ₂	97-98
Wash., D.C.	5 ¹ / ₂ %	97 ¹ / ₂ -98 ¹ / ₂	97 ¹ / ₂	99	98 ¹ / ₂	99	98 ¹ / ₂	99	98 ¹ / ₂

* 3% down of first \$10,000; 15% of next \$6,000; 30% of balance.

VA 4¹/₂s (Immediates)

MARKET TRANSACTIONS					
Not subject to discount control unless so noted					
City	VA Discount Control Price	FNMA Price xy	30 year		20-25 year
			2% down	5% down	10% down or more
Atlanta	94 ¹ / ₂	90	a	a	a
Boston local	96	91	a	a	a
Out-of-state	—	—	90f-92	90b-92	90b-92
Chicago	94 ¹ / ₂	90	a	a	a
Cleveland	94 ¹ / ₂	90	a	a	a
Denver	93 ¹ / ₂	89 ¹ / ₂	92 ¹ / ₂ -93b	92 ¹ / ₂ -93b	92 ¹ / ₂ -93b
Detroit	94 ¹ / ₂	89 ¹ / ₂	92 ¹ / ₂	92 ¹ / ₂	92 ¹ / ₂
Houston	94	90	93cd	93cd	93cd
Jacksonville	94 ¹ / ₂	90	92	92	92
Los Angeles	93 ¹ / ₂	89 ¹ / ₂	92 ¹ / ₂ -93cd	a	a
Newark	95 ¹ / ₂	92 ¹ / ₂	b	b	b
New York	96	91	b	b	b
Oklahoma City	94	89 ¹ / ₂	91bg	91bg	93bg
Philadelphia	95 ¹ / ₂	90 ¹ / ₂	a	a	a
San Francisco	93 ¹ / ₂	89 ¹ / ₂	92-92 ¹ / ₂	a	a
St. Louis	94 ¹ / ₂	90 ¹ / ₂	90-92	90-92	90-92
Washington, D.C.	95	90 ¹ / ₂	93 ¹ / ₂ b	93 ¹ / ₂ b	95b

Footnotes: a—no activity. b—very limited market. c.—includes 1 point advance commitment fee. d—future prices; subject to discount control. e—local price for 10% or more down. f—for 15% or more down. g—from warehouse or shelf; no new projects. h—in 5 north Virginia counties. x—FNMA pays ¹/₂ point more for loans with 10% down or more. y—FNMA net price after ¹/₂ point purchase and marketing fee, plus 2% stock purchase figured at sale for 50¢ on the \$1.

- ▶ Immediate covers loans for delivery up to 3 months.
- ▶ Quotations refer to prices in metropolitan areas; discounts not subject to price control may run slightly higher in surrounding small towns or rural zones.
- ▶ Quotations refer to new houses of typical average local quality with respect to design, location and construction.

SOURCES: Atlanta, Robert Tharpe, pres., Tharpe & Brooks Inc.; Boston, Robert M. Morgan, vice pres., Boston Five Cents Savings Bank; Chicago, Maurice A. Pollak, exec. vice pres., Draper & Kramer Inc.; Cleveland, David O'Neill, vice pres., Jay F. Zook Inc.; Denver, C. A. Bacon, vice pres., Mortgage Investments Co.; Detroit, Harold Finney, exec. vice pres., Citizens Mortgage Corp.; Houston, Donald McGregor, exec. vice pres., T. J. Bettes Co.; Jacksonville, George Dickerson, Stockton, Whatley, Davin & Co.; Los Angeles, David Northridge, vice pres., The Colwell Co.; Newark, William F. Haas, vice pres., Franklin Capital Corp.; New York, John Halperin, pres., J. Halperin & Co.; Oklahoma City, B. B. Bass, pres., American Mortgage & Investment Co.; Philadelphia, W. A. Clarke Sr., pres., W. A. Clarke Mortgage Co.; St. Louis, W. C. Rainford, pres., Mercantile Mortgage Co.; San Francisco, Raymond H. Lapin, pres., Bankers Mortgage Co. of California; Washington, D. C., Hector Hollister, exec. vice pres., Frederick W. Berens Inc.

NEW YORK WHOLESALE MORTGAGE MARKET

Prices on the open wholesale market in New York City, for out-of-state loans, as reported the week ending March 15, by Thomas P. Coogan, president, Housing Securities Inc.:

FHA 5 ¹ / ₄ s	
(minimum down, 25 or 30 years)	
Immediates: 97-98	Futures: 97-98
VA and FHA 4 ¹ / ₂ s	
(minimum down, 25 or 30 years)	
Immediates: 91 ¹ / ₂ -92	Futures: 91 ¹ / ₂ -92

Note: prices are net to originating mortgage broker (not necessarily net to builder) and usually include concessions made by servicing agencies.

FNMA STOCK

	Month's			
	Mar. 13	Feb. 13	low	high
Bid	57	58 ¹ / ₂	55	62 ¹ / ₂
Asked	59	60 ¹ / ₂	55 ¹ / ₂	62 ¹ / ₂

Quotations supplied by C. F. Childs & Co.

Suddenly

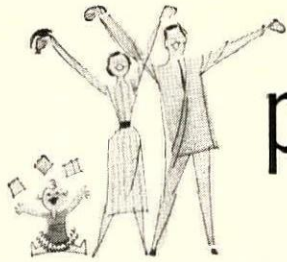

perfect comfort becomes



PERFECT AIR CONDITIONING—The cleanest, freshest air ever known, perfectly cooled throughout all living areas, with a special blower speed to meet demands of high daytime temperatures and heavy sun exposure. Unit capacities from two to 10 tons.

PERFECT HEATING—Ideal warmth in winter, with an exclusive "accordion-type" heat exchanger that wrings maximum heat out of fuel, and a special blower speed for heating. The Landmark heats efficiently with gas, oil, electricity or heat pump.

PERFECT AIR HANDLING—A big, two-speed blower, cushioned on live rubber in a sound-conditioned chamber, quietly "floats" large volumes of air through the home. Over size Hammock Filter does a vastly better job of cleaning the air.

a powerful selling point for you!

Ready now—the first true all-year comfort system:

LANDMARK* by LENNOX

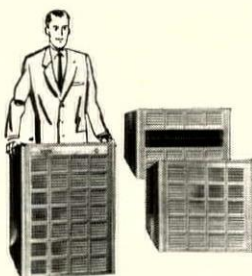
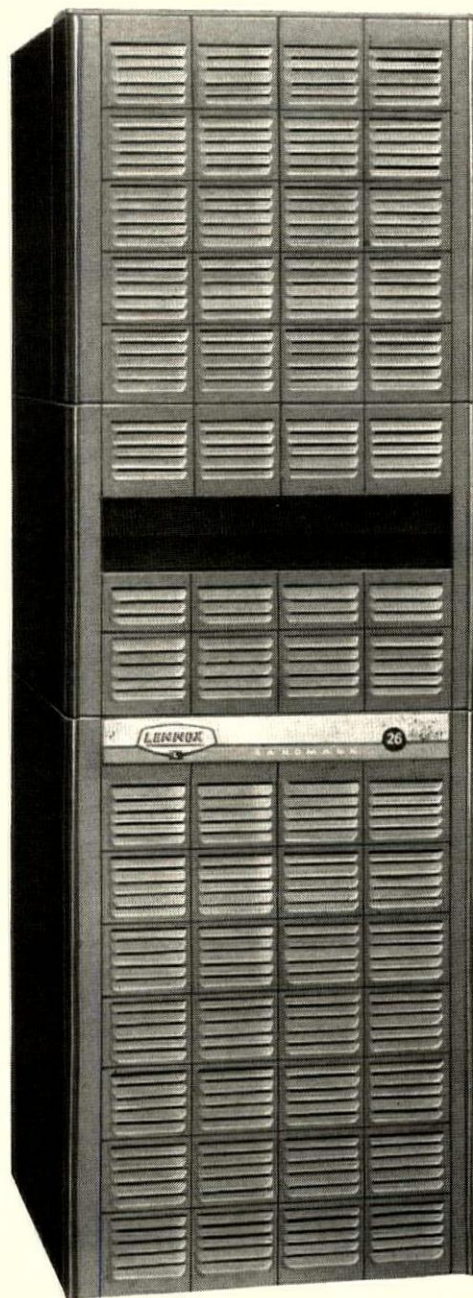

Separate “blocks of comfort” offer heating and air conditioning made-to-measure to your homes . . . with big savings on installation . . . dramatic sales appeal to prospects!

You know it's different the moment you set eyes upon it! For here is not the usual pre-packaged furnace with cooling added. Instead, the Landmark consists of *separate* comfort components—*blocks of comfort*.

Why separate? That's so your Lennox Comfort Craftsman can select the *one* right heating unit, cooling unit, air handling unit best suited to the needs of your climate and of each home you build. Now, for the first time, you can offer prospects year-round comfort that's precisely *made-to-measure* for each home and for the personal needs of each family.

Super-quiet, trouble-free!

This remarkable comfort system functions so *effortlessly*, you hardly know it's operating. There are no sudden “ticks” or thumps; no “popcorn” noises; no vibrations or annoying air surges. Fuel bills are lower, for air travels in “slow motion” to pick up *all* the cooling it can hold (or all the heat in winter), as it passes through the Landmark.

The superb efficiency of these specially-designed components keeps the Landmark operating trouble-free, and treats your customers to the cleanest, most comfortable, most healthful indoor air ever known to man! And these easy-to-handle *blocks of comfort* save you as much as three hours of installation time!

For information, see your Lennox Comfort Craftsman, Sweet's, or write Lennox Industries Inc., Dept. HH-84, Marshalltown, Iowa.



A SOUND PLAN FOR SELLING HOMES
Prepared by experts, it gives you the merchandising help you need in these competitive times—saves you time, trouble and money. It's available from Lennox, NOW!

SEE OUR CATALOG
IN SWEET'S
ARCHITECTURAL
FILE
File No. 30b/Le

For better business,
better buy . . .

LENNOX

*Trademark

© 1958 Lennox Industries Inc., Heating and Air Conditioning, founded 1895; Marshalltown and Des Moines, Ia.; Syracuse, N.Y.; Columbus, O.; Decatur, Ga.; Ft. Worth; Los Angeles; Salt Lake City. In Canada: Toronto, Montreal, Calgary, Vancouver, Winnipeg.

MATERIALS & PRICES:

Some materials prices come tumbling down as dealers feel competitive pinch

Price cutting is now the order of the day in the building supply business. Lumber dealers are feeling the pinch most. A HOUSE & HOME survey produced these typical reports in mid-March:

Detroit: "The lumber business has never been in worse shape," moans Lumber Dealer William C. Restruck Jr. He has cut prices to near cost, he says. "It's all coming out of my profit." Electrical, plumbing and masonry suppliers are doing the same, says Restruck.

Atlanta: "Price and profit cutting is not restricted to a few products. It's just a general 5 to 15% on everything," says J. Ross Hanahan, president of Carolina Lumber & Supply Co. "The bigger the job—say five or 10 houses—the more price cutting. It's coming strictly from the dealer's pocket."

Phoenix: "We are selling lumber 10% under what we should," reports Cliff Shields of O'Malley Lumber Co. "Sometimes we don't cut unless the customer or his volume is worth fighting for. We will always cut to hold an established customer." Reports Lumber Dealer John Entz: "Now we are feeling the pinch in locks and hinges, too. There are more and more—and cheaper—foreign goods coming into the market and builders of cheaper houses where quality is not too important are buying them."

Dallas: "It's dog eat dog," according to Grady Cates, president of the Hines Boulevard Lumber Co. "We couldn't go any lower on prices—we'd have to quit."

Sums up Col. E. H. Boeckh, Washington cost analyst: "Everyone is cutting each other's throat."

Plumbing at 1950 prices

Plumbing fixture prices have been cut sharply at the builder-dealer level. Reports one plumbing equipment dealer: "We are selling our fixtures at 1950 prices. If we weren't diversified we'd be losing our shirts."

Builders are also getting a big break on appliance sales. Says Philadelphia Builder Ralph Bodek: "Builders are just about able to write their own ticket when it comes to buy-

ing refrigerators, garbage disposals, cabinets and stoves."

In San Francisco and Philadelphia, lower materials prices have been offset by higher labor and land costs. So the price of houses remains about the same. But in Detroit, Realtor Gordon Williamson estimates that lower materials prices mean "people get 5% more house compared to a year ago." His estimate is supported by Lumber Dealer George Erb who figures at least \$500 has been pared from a minimum-priced Detroit home.

Detroit Architect Clifford Wright, who keeps tab on contractor-bidding on custom homes, reports: "Current prices are the best in six years."

Subcontractors cutting

Tough competition is shrinking some builder profits—but the subcontractor seems to be slashing his bids the most. "They're price-cutting all over the place," comments Cliff Shields, Phoenix lumberman.

Atlanta Architect Henry D. Norris finds bids from subcontractors are lower. "I notice where we formerly might have a 20% spread in bids from high to low bidders, it is now 8 to 10%. Subs are figuring closer," he says.

General contractors are cutting profit margins in their bidding too. Reports H. L. Mills, business manager for Houston schools: "Contractors are crying for work now." On two one-story elementary schools just let, the winning bid was \$936,200—\$54,970 less than a contract for two similar schools two months earlier though the first schools were two-story and theoretically should have been cheaper.

Phoenix Architect John Sing Tang recently took bids on a restaurant estimated to cost \$100,000. The low bid was \$83,000.

Ironically, some contractors blame home builders for bid-cutting. Explains an AGC spokesman in Atlanta: "Some home builders have turned to building small commercial buildings as a result of their curtailed house market."

MARKET BRIEFS

Trane to build home coolers

Trane Co., long a major maker of commercial air conditioning equipment (as well as residential and commercial heating equipment), is moving into the residential air conditioning field.

The company is completing a new \$1.5 million plant at Clarksville, Tenn. where its residential units will be made. Officials say residential air conditioning could be their largest market—a chance to substantially boost sales and earnings.

Notes Trane President D. C. Minard: "Less than 2% of the over 35 million single family homes in this country are now centrally air conditioned. So the market potential is vast."

Gas water heater sales up

Shipments of automatic gas water heaters in January reached 238,200—10.8% above January 1957 and equal to shipments in April 1957, biggest month of that year.

Adequate wiring progress

Electrical wiring and fixture costs are getting a bigger cut of Chicago's home building dollar.

A survey by the Chicagoland Home Builders Assn. (its new and fancier title) shows that wiring and fixtures were only 2% of sales price in 1950. But in 1956 they reached 3.7%, then rose to 4% in 1957 and 4.3% in 1958.

Lumber workers ask hike

Lumber's depressed state will not deter lumber and sawmill workers from demanding higher wages this year.

The 80,000-member Lumber and Sawmill Workers Union, representing workers in 11 western states, wants a 31¢ hourly increase—15¢ in wages, 10¢ health and welfare and 6¢ for paid holidays. Average wage would be boosted from \$2.33 to \$2.64.

Says Earl Hartley, executive secretary of the union's western council: "We intend to take the economics of the lumber industry into consideration in bargaining sessions. But we feel our demand is fully justified. . . . All signs point to a definite pickup in demand for lumber and wood products."

Plywood—an industry that still responds in classic fashion to dwindling orders (i.e. by cutting prices and stirring up new business) has roller-coastered through another dramatic price trough.

Plywood hits bottom

Price-cutting drove the market down to \$64M for 1/4" AD index in late February and early March, lowest price in nine years. But heavy buying dragged prices back up to \$66, then \$68. By mid-March, most mills were quoting \$72 again—and one was asking \$76.

At the end of February mills were producing at only 84% of capacity. But in one week at the \$64 price, new orders reached 135 million board feet vs. an industry capacity of 138 million.

Sheathing plywood also felt the rebound, from its winter low of \$84M, it bounced back to \$90 last month.

Lumbermen do not believe the big sales

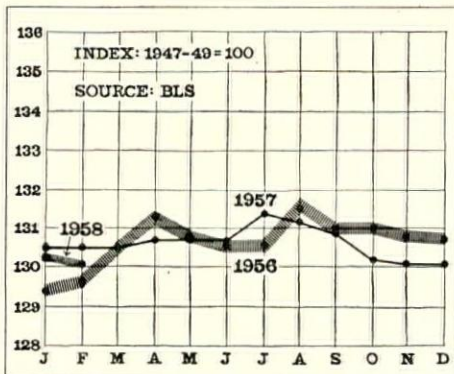

BLS BUILDING MATERIALS' prices slipped 0.2% to 130.1—0.4% below February a year ago. The drop was caused by more decline in the price of lumber and wood products (down 0.3%) and plumbing fixtures (down 1.1%). These more than offset a 0.3% increase in the price of concrete products.

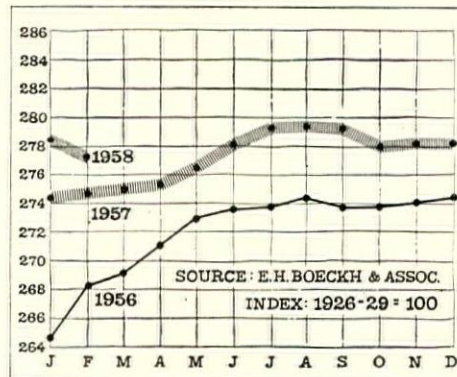

BOECKH'S INDEX of residential building costs is down 1.2 points to 277.2. Col. E. H. Boeckh attributes it to cuts in plywood prices and in heating and plumbing equipment. He cautions that these cuts may be a result of inventory clearance, not firm price reductions, could well go back up again soon.

PUT YOUR MONEY IN SALES APPEAL

but don't "Gold-Plate" the drain!



Specify Republic Steel Pipe for maximum economy in waste line service

Today, more than ever, it is true extra-value that converts "just-lookers" into home buyers. That's why discerning building contractors put more dollars into practical sales stimulators—and insist on maximum economy in basic material selection.

When it comes to waste line specification, Republic Steel Pipe provides actual savings for home builders and owners alike.

For the builder, low initial cost is only the first of many advantages of Republic Pipe. This, coupled with stability in price and availability, means no profit-robbing cost fluctuations or work stoppages. And, since one grade meets all

requirements, inventory expense and problems are minimized. Danger of installing wrong grades is eliminated.

Finally, excellent workability of Republic Steel Pipe, plus years of know-how in handling steel pipe offered by every reputable plumbing contractor, add up to fast economical installations—good for the life of the building.

All of these factors mean true extra-value for builders and buyers. For complete data, consult your Republic Pipe Distributor, or write Republic Steel Corporation, Dept. HO-5368-A, 1441 Republic Building, Cleveland 1, Ohio.

REPUBLIC STEEL

World's Widest Range of Standard Steels and Steel Products



Producers' profits slide; overexpansion denied

Plumbing fixture makers, lumber and plywood industries have especially bad year because of housing's slump

Last year was the worst since 1949 for home building's materials producers—the biblical lean year after seven relatively fat ones.

Earnings reports from 64 leading companies show only 19 (30%) had an increase in both sales and profits. Of these 19, only 12 depend on home building for a major part of their market.

Among all 64 companies, 29 (45%) had sales increases but only 21 of them are tied closely to home building. Earnings were up for 25 (39%) companies but again only 18 have a major stake in home building.

Was the 1957 performance of the materials producers as good as could have been expected in a year when home building slumped 10% from 1956 and nearly 30% from 1955?

Forbes magazine (circ. 250,000), which claims its viewpoint represents the attitude of Wall Street investors, has been sharply critical. "Far from having prepared themselves for the inevitable slowdown [in home building] the building materials manufacturers had, if anything, tended to lavish their hard-won profits on expansion when they should have been pulling in their horns," says *Forbes*.

Focusing on the 10 biggest building materials producers*, the magazine notes that in the first three quarters of the year they took in as many sales dollars as in the first three quarters of 1956. Yet their profits on the average were down 16.8% and "had it not been for the good work of US Gypsum and Lone Star Cement, the comparison would have been even more odious."

Other *Forbes* complaints: producers have used "old-maidish" financing, failed to develop new materials and new selling methods.

The accused reply

Chairman Melvin Baker of National Gypsum, one of the firms which has expanded most, answers simply that the industry must disregard temporary building lulls and booms to keep pace with the demands of the economy. Later, calling on businessmen to "combat gloom peddlers," he announced National Gyp will soon start building a new multi-million dollar plant in Waukegan, Ill.

"We could delay the new plant until the economic picture looks better but our confidence in the future dictates that we act now to provide new production for the larger market ahead," he says.

Frederick K. Weyerhaeuser supports Baker's reasoning: "Although it may not appeal to certain types of investors, we do believe that for certain companies a sound, conservative expansion based on retained earnings has its place in the picture as well as imaginative borrowing programs."

US Plywood President S. W. (Tony) Antoville agrees: "Our company would be remiss in its responsibility if we did not base our long-term plans upon filling the housing needs of the population surge ahead of us." His company is amid a \$10 million capital expenditure program. It is adding to its distribution system, completing two new plants and adding timber reserves.

Says President C. J. Backstrand of Armstrong Cork: "Not too long ago there was

talk of investigations over lack of capacity [among building materials producers]. It should not be too surprising now that some extra capacity is available and that not everyone in the industry has been able successfully to switch emphasis from production to merchandising."

Adds Armstrong Treasurer Walter Hoadley: "A lot is happening that isn't evident in the statistics. Lots of companies, including our own, have research programs going on, aimed at developing new products for tomorrow's house technology. Part of the problem [of the building materials industry] in getting out of today's dilemma is the cost of new ideas and new products to get you out."

To the *Forbes*' cry of overexpansion Hoadley replies: "As far as products sold today are concerned, we're glad we expanded, because some of our most modern high-style items [from new plants] are selling well."

President Adrain Fisher of Johns-Manville announced his firm is launching a three-pronged effort to offset its drop in sales and the squeeze on profits. J-M is stepping up its advertising program, speeding up installation of new processes which can cut costs and simplifying office methods.

The squeeze on profits

No area of building materials or products escaped the 1957 profit squeeze. Items:

Appliances: Manufacturers fared better than firms more closely tied to the rate of home building. Westinghouse sales were up 31.7%. General Electric's 6%. Only Whirlpool and Maytag showed sales drops. Carrier, however, shows a 10.5% sales increase but a 33.5% drop in net earnings. (First quarter figures for Carrier are worse, with sales down 16.4% and net off 74.2% from 1957.)

Cement: Every major company shows a minus in either sales or net. Lone Star, biggest in the field, has the best record. Sales were off only 3.7%; net fell 3.4%. Companies blame last summer's cement strike and the slow start of the federal road building program for their slump.

President W. A. Wecker of Marquette cautions against any more plant expansion. "All cement demand, including that for high-

1957 SALES AND EARNINGS FOR 64 PRODUCERS

COMPANY	SALES	% CHANGE		
		IN SALES '56-'57	IN NET '56-'57	
Appliances				
Worthington	\$191,727,439	12	7.2	
Whirlpool	402,322,212	-2.9	-24	
Trane	80,648,000	8.3	8.8	
Maytag	98,613,291	-12.7	-21.6	
Westinghouse	2,009,043,000	31.7	95	a
Carrier	263,426,097	10.5	-33.5	
General Electric	4,335,664,061	6	16	
Cement				
Penn-Dixie	40,753,792	-28.2	-16.2	
Lehigh Portland	70,407,706	-7.3	-32	
Ideal	78,254,763	.8	-3	
Gen. Portland	37,762,700	-16.7	-26.7	
Marquette	46,615,860	9.6	-.9	
Lone Star	94,676,587	-3.7	-3.4	
Alpha Portland	30,958,384	-12.6	-22.8	
N. American	17,079,341	-2.6	2.8	
Glass				
Owens Corning	163,327,463	1.4	-9	
Pittsburgh Plate	620,803,296	4	4.2	
Thatcher	42,019,715	33	7.6	
Amer. Window	17,595,477	-24	-91.5	
Libbey Owens	237,199,069	-8.5	-4	
Lumber & Plywood				
Roddis	53,344,456	-3.4	-78.2	
E. L. Bruce	12,678,719	-15.7	-8.4	
Georgia Pacific	147,649,368*	21.7	12.2	
Weyerhaeuser	427,000,000	-4.4	-17.4	
US Plywood	154,416,000*	2.8	-24.1	
General Plywood	7,025,446	-12	b	
Int. Paper Co.	940,427,571	-3	-9.5	
Prefabbers				
Harnischfeger	87,548,369	7.9	17	
National Homes	45,382,042	-3.6	-19	
Scholz Homes	6,149,914	-12.4	28.7	
Plumbing and Heating				
Rheem	188,580,607*	8	d	
Coleman	30,953,057	-11.9	-82.6	
A. O. Smith	140,515,665	17.1	24.1	
Universal Rundle	12,963,157	-12.7	-58.4	
Bell & Gossett	11,495,443	1.9	8.7	
Briggs	13,432,935*	-27.3	e	
Crane	268,902,000*	-1.8	-28.1	
Amer. Standard	368,783,000	-8.1	-35.8	
Minn. Honeywell	324,886,719	12.8	-5	
Metals				
Aleo	869,378,093	.6	-15.4	
Kaiser Aluminum	400,000,000	16.4	-32.9	
Revere	199,625,549	-20.3	-11.4	
Anaconda	96,145,526*	-52.3	-59.9	
Bridgeport Brass	150,868,526	-9.8	18.7	
Jones & Laughlin	837,568,000	21	.7	
US Steel	4,413,824,266	5.1	20.4	
Wallboard, Roofing, Tile				
Celotex	66,629,231	-12.9	-34.2	
Masonite	13,314,667	-5.5	-99.8f	
	58,861,372	-4.1	-29.3	
	15,827,194	14.9	1.9e	
Johns Manville	308,293,000	-7	-29	
Armstrong	246,528,518	-4	-17	
Ruberoid	81,073,947	6.2	14.4	
U.S. Gypsum	249,646,019	-5.8	-4.6	
Philip Carey	69,889,864	.7	2.4	
National Gypsum	141,472,944	-6.8	-11	
Bestwall Gypsum	29,401,797	-6.9	-17.3	
Certain-teed	83,633,776	-9.2	-6.5	
Flintkote	116,249,878	2.3	-1.2	
Miscellaneous				
Amer. Hardware	35,624,097	16.7	29.9	
Yale & Towne	128,558,408	4.9	-22.1	
Monsanto	708,005,000	8.3	6.8	
Minn. Mining & Mfg.	370,106,838	11.9	2.6	

* The top 10: American Standard, Armstrong Cork, Crane, Georgia-Pacific Lumber, Johns-Manville, Lone Star Cement, National Gypsum, US Gypsum, US Plywood and Weyerhaeuser Timber.

—NOTES: a—1956 profit affected by 5 months strike; b—loss of \$506,291, up \$310,700 from '56 loss of \$195,591; c—3 months to Nov. 30; d—1957 net of \$1,968,916 following '56 loss of \$9,163,134; e—loss of \$131,029, showed \$1,333,428 net in '56; f—3 months to Jan. 31st; g—9-month report; h—6-month report; i—10-month report.

ways, failed to come up to expectations in the final quarter," he warns.

Lumber & plywood: Only Georgia-Pacific, with sales up 21.7% and net up 12.2%, did better in 1957 than in 1956. Sales of the major companies listed, however, do not accurately reflect the industry's year. The lumber slump hit small producers much harder than big ones.

The first quarter will probably be worse for the lumber industry. All mills are expected to have an operating loss with a painful profit squeeze for pulp and paper plants. The earnings outlook seems the worst since World War 2 because no notable pick-up in the lumber market is expected until late spring. Reason: a full month's supply of lumber still lies in mills awaiting buyers.

Wallboard, roofing & tile: Ruberoid, with sales up 6.2% and net up 14.4%, has the best record for 1957—a year when firms in this category expanded greatly, competition stiffened and a cost-price squeeze resulted.

Plumbing & Heating: It was a very tough year for the major plumbing equipment producers. Earnings drops ranged from 58.4% for Universal Rundle to 28.1% for Crane and a net loss for Briggs.

CANADA:

Government says home building will jump 15½ %

Government forecasters expect new home building to jump a surprising 15½% this year. The Dept. of Trade and Commerce predicts a record 140,000 starts and \$1.6 billion outlay. It says total construction will be up 1% to \$7.14 billion—also a record. How the estimate compares with previous years' results:

	Starts	Completions	Expenditures (millions)
1955	138,276	127,929	\$1,499
1956	127,311	135,700	1,575
1957	122,300	117,300	1,415
1958	140,000	134,000	1,635

- Two intriguing aspects of the prophecy:
1. Housing dollar volume would be higher (in relation to starts), except for the already noticeable trend to low cost homes spurred by the government's agency lending program (Feb., News).
 2. In recent years, this first official forecast has tended to underestimate. This year, because it is based on surveys started in late fall before the recession was well under way, some experts say it may be at least 10% too high.

National building code replaces NHA standards

Canada has taken another big step toward a single national building code for housing—a goal that now seems only two years away!

On April 14, a new code will replace Central Mortgage and Housing Corp.'s building standards (MPRs) which govern all NHA building. It has been written by the government's division of building research to eliminate discrepancies between the national building code and CMHC standards.

The new code has one major relaxation: 24" spacing of rafters and ceiling joists, with ¾" plywood sheathing is recognized for the first time (wall studs must still be 16" o.c.). This means builders can now use trusses economically.

A temporary document, largely a revise of the old CMHC standards, will be used until 1960.

NEWS continued on p. 76



**ONLY Fleetlite Sliding Glass Doors
HAVE PASSED THIS TEST!**
100 mph. winds and heavy rains
stopped by water barrier threshold

Before you select a sliding glass door, ask the question, "will it protect costly rugs and hardwood floors from water damage in pouring rain and high winds?" The answer is YES when you specify Fleetlite. These doors give protection in a man-made hurricane of 100 mph. with a 2" per hour downpour. No other door has ever passed this test. The Fleetlite exclusive "water barrier" double threshold and double weather seal block winds and water... provide automatic drainage so water cannot build up from the outside. Fleetlite Sliding Glass Doors are quickly installed, easily adjusted and are maintenance free. Write today for literature and complete information.

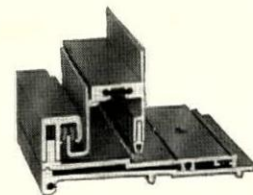

Above: Cross section of Fleetlite double threshold that blocks wind and water.

Below: Fleetlite flat threshold is recommended only for interior sliding door installations where weather is no problem.

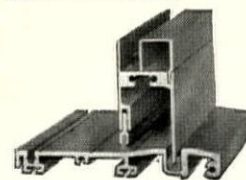

FLEET OF AMERICA, INC.
Dept. HH-48, 2015 Walden Ave., Buffalo, N.Y.

How to personalize your homes for extra sales appeal

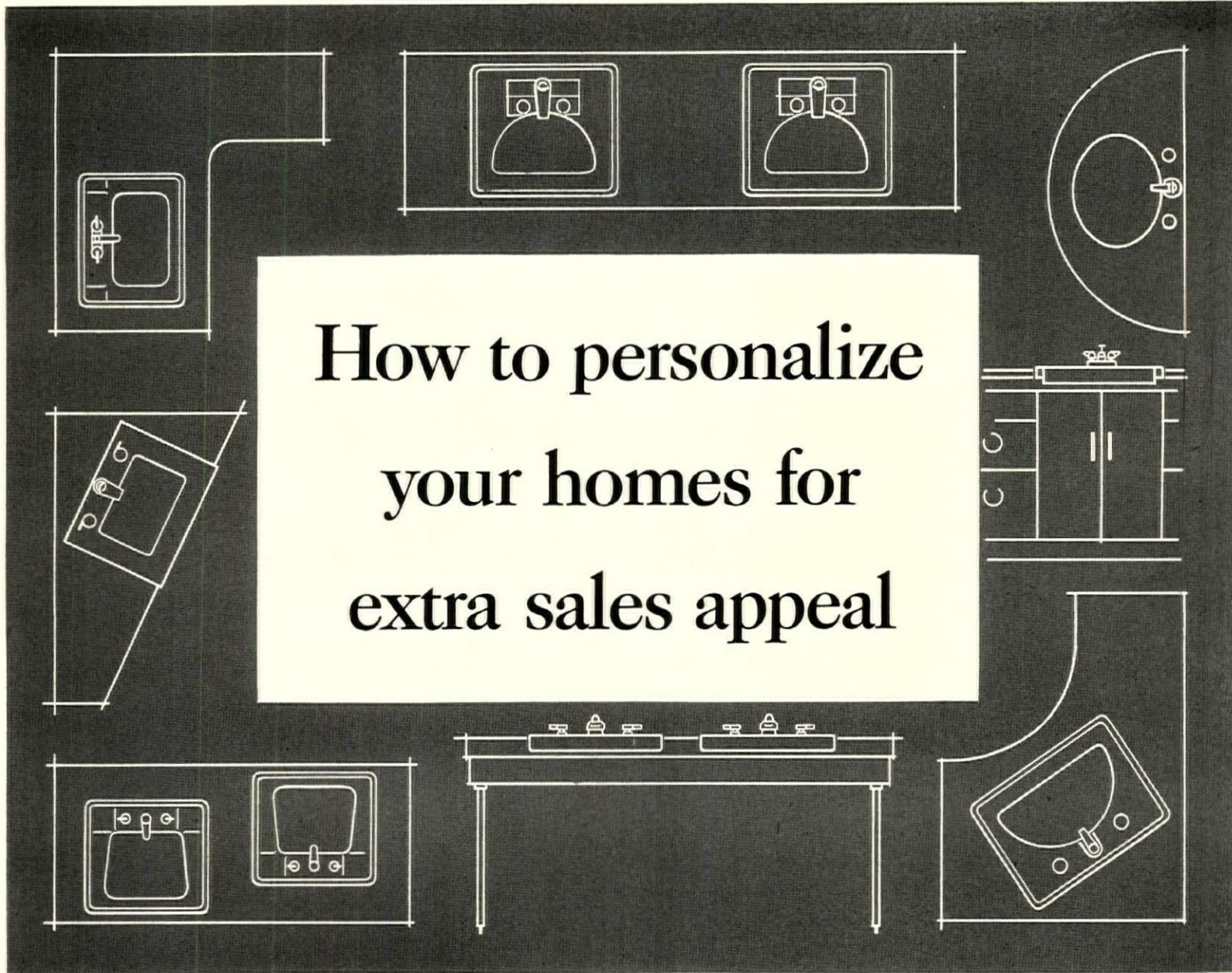

Crane offers the most complete line of countertop lavatories—9 designs, 7 colors to help you make every bathroom different and distinctive

There are a lot of ways you can avoid the "peas-in-a-pod" look—even if you're building project homes.

One of them is Crane countertop lavatories in the bathroom—built into L-counters, corner units, vanities with storage, or other distinctive installations like the ones shown above.

Crane offers *nine* designs... the most complete line of countertop

lavatories in the field. 7 beautiful colors and white in vitreous china, cast iron, and porcelain-on-steel.

And every Crane countertop lavatory is styled by famous designer Henry Dreyfuss, and engineered by Crane to last longer.

Yet Crane, the preferred plumbing, doesn't cost any more. Why not call your Crane Branch or Crane Wholesaler for complete information?



Luxury at a modest price. Crane Westland (above), Crane Countess (left), gleaming vitreous china lavatories priced for smaller budgets. Both feature Crane Dialase controls and come in 7 lovely Crane colors and white.

CRANE CO. 836 S. Michigan Ave., Chicago 5 • VALVES • FITTINGS • PIPE • PLUMBING • KITCHENS • HEATING • AIR CONDITIONING

CRANE

THE
PREFERRED
PLUMBING

WHERE ARE YOU HEADED IN HOME BUILDING?

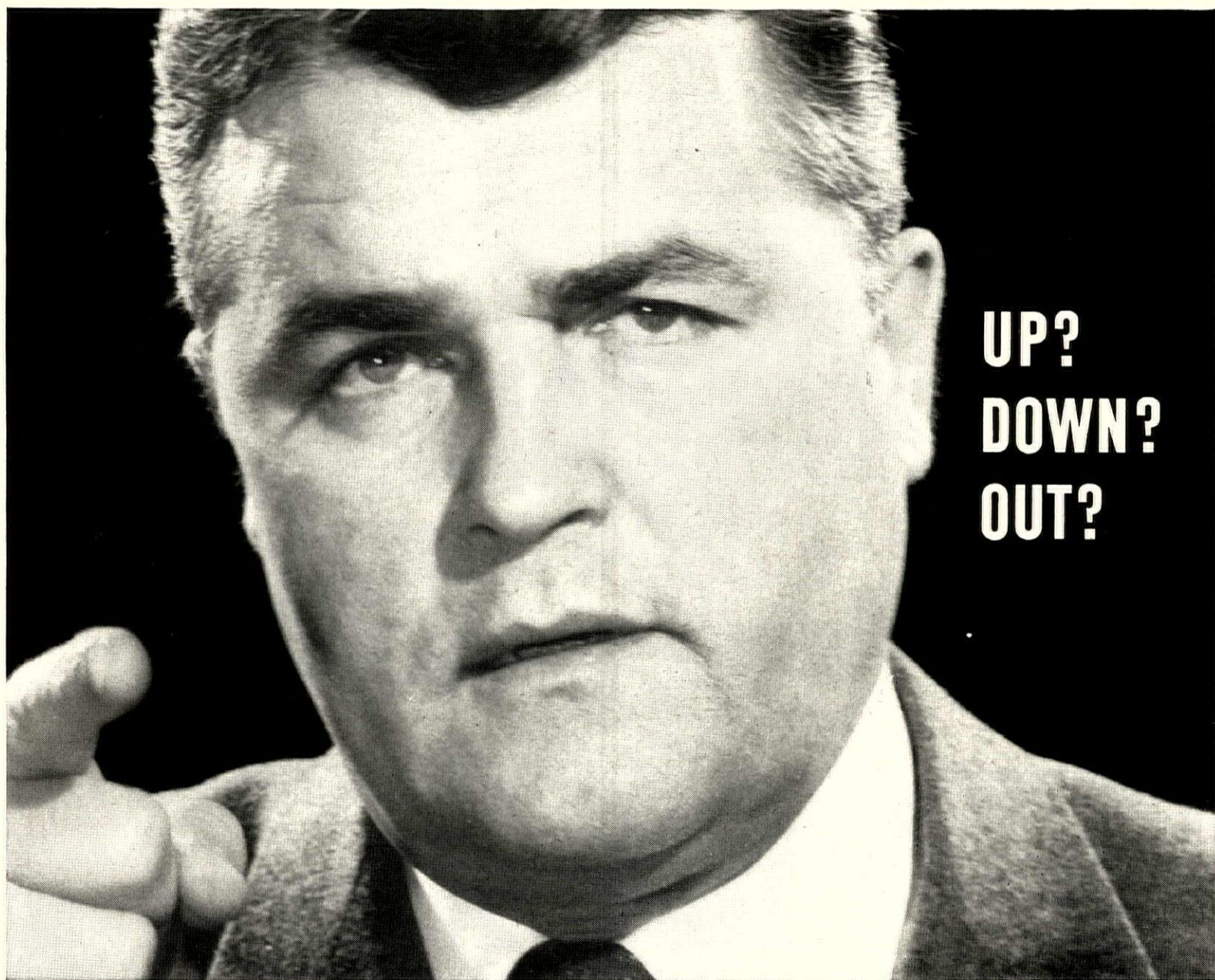

**UP?
DOWN?
OUT?**

If your plans during the next few months are realistically geared to the market — fine! If not — look out!

Every builder is *hoping* for an upturn in home sales during the spring and summer months. But the builder who can *expect* it is the one who operates at top efficiency in *every* phase of his business. The one who spends *less time* with time-consuming details and *more time* in productive selling!

If you have any doubt whatever about *any* phase of

your building or selling program — whether it involves locating financing or finding the right merchandising tools — get the *full* story on the Harnischfeger Plan, and how it's helping other builders. A letter will bring you the facts — quick! Select dealerships available in Wisconsin, Illinois, Indiana, Ohio, Missouri, Iowa, Michigan, Minnesota, and northern Kentucky.

HARNISCHFEGGER HOMES, INC.

Dept. HH-584 • Port Washington, Wisconsin • Phone 611



LABOR:

Closed shop banned; hiring hall may be next

NLRB threatens to invoke its most severe penalty if building trades, employers do not comply by June 1

The death knell has been sounded for the closed shop in the building industry—but it may turn out to be the starting bell for a long, bitter wrangle.

The Natl. Labor Relations Board has given both building trades and building employers until June 1 to end closed shop and illegal hiring practices or face the stiffest of NLRB's penalties—the Brown-Olds reimbursement remedy. This requires refund of all dues and assessments collected from all union members under a contract held illegal.

Building trades leaders have reacted violently. They accuse NLRB of conspiring to bankrupt their unions. They promise a legal battle. (The Brown-Olds remedy has not been tested in court.)

NAHB first called the edict from NLRB General Counsel Jerome Fenton "the most significant NLRB ruling to affect the construction industry since the passage of the Taft-Hartley Act in 1947." But several days later, an NAHB spokesman admitted concern over the matter of compliance. Building employers are held equally responsible with unions to end closed shop and illegal hiring practices; could face demands for cash refunds of dues if a bankrupt union can't make the refunds under the Brown-Olds remedy. Yet NLRB will not spell out in detail how employers should comply.

And this is not the simple problem it may seem on the surface.

What about the hiring hall?

It will be easy to strike closed shop language from a contract. But builders and contractors are unsure of the status of the union hiring hall, out-of-area employment and informal pre-job hiring arrangements which call for union men.

Everywhere home building is unionized,* builders rely to some degree on the hiring hall. A call to the hall will bring the desired number of tradesmen and their referral slips. In practice, a union usually agrees that if it cannot provide the desired number of men within 48 hours, the builder may hire from another source—even a non-union man. (Though the non-union tradesman would have to join the union within 30 days under terms of the still-legal union shop contract.)

Since few builders keep fulltime crews the hiring hall has served a purpose—providing a pool of labor on short notice.

Yet in several cases NLRB has recently ruled hiring halls illegal because they discriminate against the non-union worker.

There has been speculation that unions may open the hiring hall to non-members. But there has yet to be any sign that this may occur.

Now industry wonders: should builders continue to hire through the hiring hall though only union men are available there? If the

NLRB holds this and other common pre-hire arrangements a violation of Taft-Hartley, then the Brown-Olds remedy can be costly.

NLRB's only answer so far: "We've said all we're going to. It's up to you to comply."

Puzzled labor experts in both NAHB and AGC are urging their members to be extremely cautious. NAHB also suggests members "make every effort to revise your hiring system so it will meet NLRB conditions." But they confess they are at a loss to make specific recommendations. Meantime, their only consolation is an assurance from someone in NLRB that the Brown-Olds remedy will not be pressed in cases of technical violations.

The Brown-Olds remedy

This controversial remedy—bitterly condemned by union leaders—could cost builders a fortune.

The remedy came out of a 1957 NLRB decision in the case of the J. S. Brown-E. F. Olds Plumbing & Heating Corp. of El Paso, Tex. Brown-Olds had a closed shop contract

Robert Phillips



NLRB COUNSEL FENTON
Closed shop must go.

with the plumbers union. When a Vernon L. Bryant applied for a job with the firm, Brown-Olds checked with the union, found the man was not a union member so refused the job.

Bryant appealed to the NLRB, which ruled that the job denial was illegal and ordered the union to pay Bryant the money he would have earned had he been working for Brown-Olds. This was the standard penalty for a closed shop violation.

But the board shocked the union and Brown-Olds by ruling that because of the illegal closed shop provision, the whole contract was illegal—thus all dues and assessments checked off by Brown-Olds for the union were collected illegally. Result: the union was ordered to refund all the money to its members. Since most of the money had already been spent, NLRB agreed to suspend the penalty—but left it on the record.

If the penalty were invoked and enforced again, NLRB could hold both builder and union responsible. Thus if the union could not refund dues and assessments, NLRB

would demand the money from the builder.

The threat of the Brown-Olds remedy was the most surprising portion of the letter from NLRB Counsel Fenton which ordered an end to the closed shop.

The letter, itself, was no real surprise since NLRB had been hinting strongly for several months that it would no longer tolerate the closed shop.

Closed shops were banned by Taft-Hartley in 1947 but the ban was not enforced in the building trades. The nature of the business, with its traditional hiring hall system, made it easy to overlook the violation, particularly while the law was enforced by an NLRB dominated by appointees of ex-President Truman. But the last Truman appointee, Abe Murdock, left the board when his term expired in December. Departing, he cried that the board was framing evidence to make the union-run hiring hall unlawful on its face.

Fenton's letter, sent to the AFL-CIO Building Trades Dept., the Natl. Constructors Assn. and AGC (but not NAHB), gave no specifics of what NLRB will be looking for, other than a bona fide closed shop. It said: "It would be preferable if the parties took it upon themselves to correct their illegal hiring arrangements, thereby achieving the same basic purposes sought by the board but without the necessity of board action."

The fact is that few union contracts today actually specify a closed shop, though closed shop conditions prevail wherever the construction industry is unionized—usually by informal pre-hire agreements.

'A union-busting order'

Reaction of building trades leaders to the NLRB order was quick and bitter. An attack on the closed shop is, in effect, an attack on the unions' control over their members. Reason: the closed shop puts the power of job control into the union's hands.

President Peter Schoemann of the United Association cried that NLRB's use of the Brown-Olds remedy would "make the Taft-Hartley Act far worse than Congress legislated." He calls it a "punitive and union-busting order" which threatens unions with bankruptcy.

But in the meantime Schoemann and the other union chiefs sent word to their locals to erase the closed shop or any words relating to it from their contracts. Schoemann even instructed abolition of the word "referral slip" and suggested "introduction slip" or "identification slip," thus to wipe out the hiring hall and closed shop association.

Legalize the hiring hall?

In Congress, Rep. Thomas Pelly (R, Wash.) pleaded for approval of his bill (introduced last June) to legalize the hiring hall in the construction and maritime fields. (Pelly represents Seattle, a major seaport and staunchly union city.)

Pelly argued that Taft-Hartley was aimed at industrial or factory-type labor relations, is not feasible in the building trades and other fields. He explained: "Contractors have always found it not only convenient but economical and efficient to have access to a supply of trained workmen available at specified wages and working conditions."

Chances for Pelly's bill this session: close to zero.

*Cities where home builders work under union contracts include New York (and suburbs), Buffalo, Chicago, Cleveland, Detroit, San Francisco, San Diego, Seattle, Portland, Miami, Kansas City, St. Louis, Philadelphia, St. Paul-Minneapolis, Milwaukee, Fresno and Shreveport.

LABOR BRIEFS

Higher wages in Chicago

Chicago's building trades, already among the highest paid in the US, will all apparently get 5 to 6% wage hikes this year.

Plumbers Local 130, representing 7,000 plumbers, has won a 20¢ wage increase in a one-year pact and builders are already admitting that the increase will undoubtedly set a pattern for all other trades.

The contract was negotiated by three plumbing contractor groups. It was immediately attacked as completely unjustified by the Builders Association of Chicago (general contractors, not home builders) which is now negotiating contracts with the basic trades.

Cried H. Mayne Stanton, BAC's executive secretary: "It looks to employers like labor will be pricing itself right out of business. This will encourage abandonment of big construction projects." Stanton predicts that extension of the plumbers' pattern to other trades will push construction costs up 3 to 4% in Chicago.

The new scale for plumbers: \$3.73 for journeymen; \$4.03 for subforemen; \$4.18 for foremen and \$4.58 for superintendents. Earlier this year, Chicago painters settled for a 12¢ hourly wage increase.

Union legislative program

The AFL-CIO Building Trades Dept. is pushing its same tired legislative program this year.

About 2,000 tradesmen came to Washington early in March to ratify the package, then spent two-days lobbying for it with their Congressmen. The ingredients—and their chances in Congress:

Unions want a housing and slum clearance program to finance at least 2 million new homes a year (little chance); more school and hospital building (schools doubtful; hospitals probable); extension of the Fair Labor Standards Act to cover construction workers (doubtful); broadening of the Davis-Bacon Act to include fringe benefits in the concept of the prevailing wage (no chance); more unemployment benefits (very good) and these changes in Taft-Hartley (none of which are likely to get far this session):

- Legalize refusal to work with non-union building mechanics.
- Let building trades unions make pre-hire union shop agreements—i.e. closed shop.
- Repeal the section which allows state right-to-work laws.
- Legalize employer contributions to joint labor-management apprentice training funds.

Negro lathers win on bias plea

A Chicago lathers union, after a four-year court fight, has agreed to end racial discrimination against Negro lathers.

Eight Negroes complained in a federal antitrust suit that they were blocked from membership in Local 74, AFL-CIO Wood, Wire & Metal Lathers union. They also charged that the union required lathing contractors to sign contracts agreeing not to hire Negro lathers.

The union and contractors have signed a consent decree which opens the union to Negroes and bans contracts with discrimination clauses. Union and contractors must also pay \$4,000 damages to the eight Negroes plus \$6,000 attorneys' fees.

NEWS continued on p. 80

Eliminate hidden closet costs with



X-PANDA SHELF *
*Trade Mark of Home Comfort Mfg. Co.

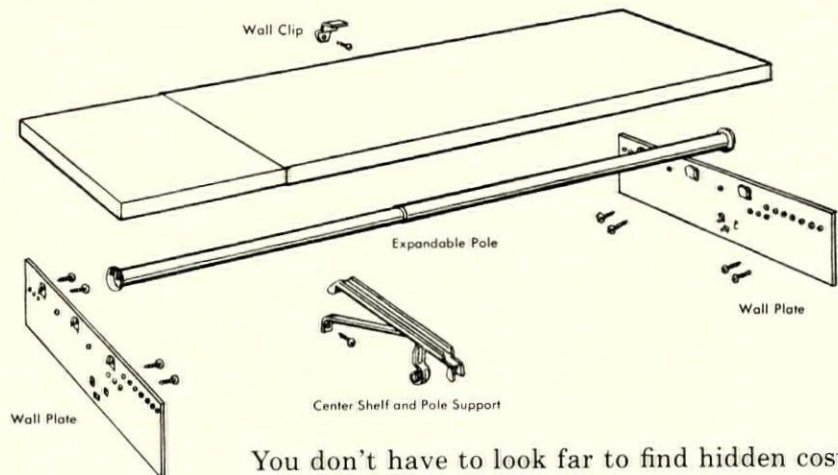

You don't have to look far to find hidden costs in conventional shelving material. Figure the wasted time... cutting—fitting—painting—installing... it's expensive! You get a finished job at lower installed costs when you use X-Panda prefabricated shelving for clothes closets (illustrated above), linen closets and wall storage areas... investigate today.

- X-Panda Shelves fit all size closets.
- Strong—won't warp. Choice of three finishes—linen, graytone, or aluminized.
- Saves time—installs in less than 10 minutes. Package comes complete with all hardware necessary for installation.
- X-Panda Shelves—easily adapted to out-of-square walls.

H-C Sales Co.

3300 N.E. Adams St.
Peoria, Ill.

X-Panda Shelf—A product of Home Comfort Mfg. Co.



H-C Sales Co.
3300 N.E. Adams St.
Peoria, Illinois

Please send the latest literature on X-Panda Shelves.

NAME _____
STREET _____
CITY _____ STATE _____

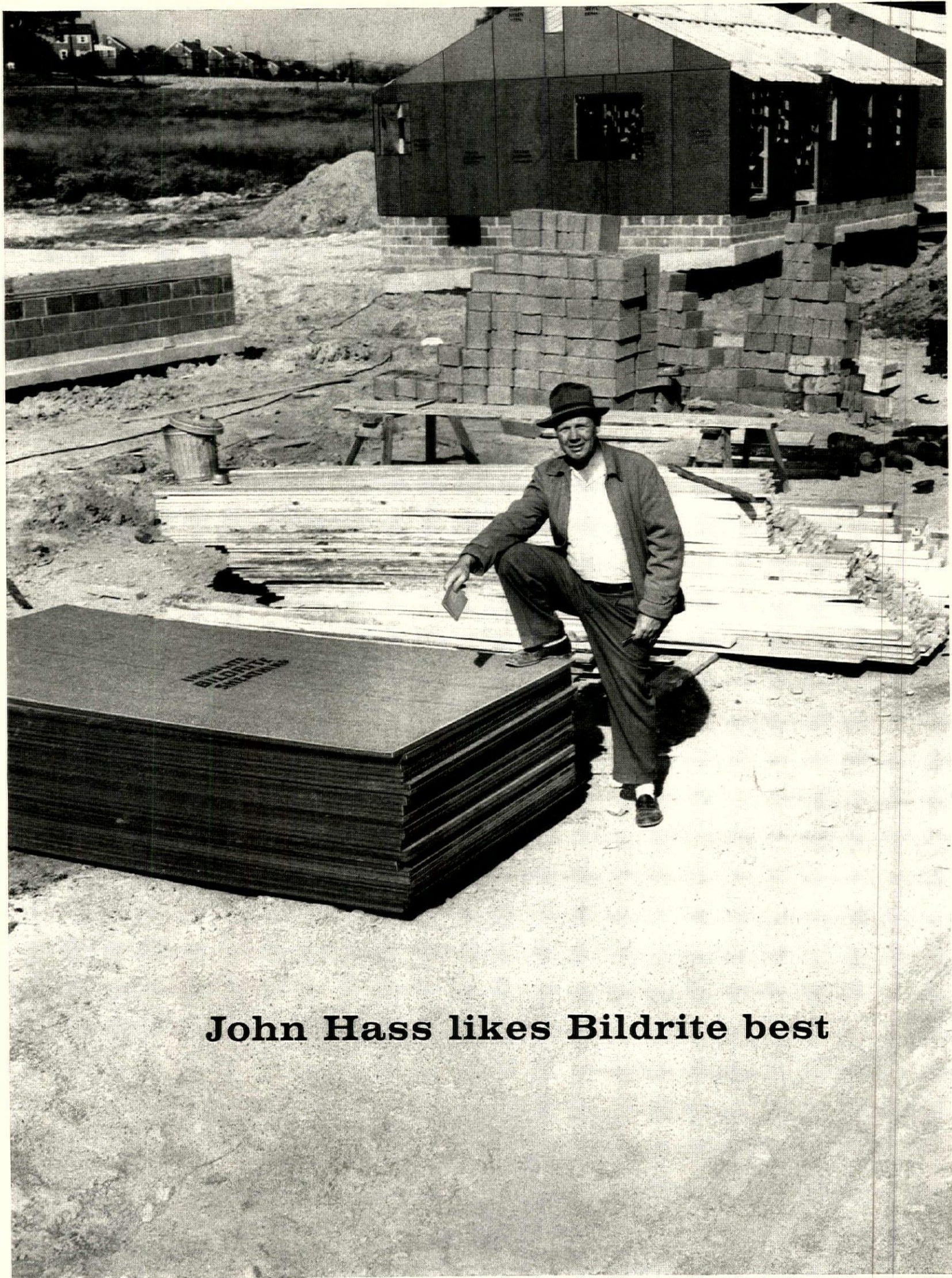

John Hass likes Bildrite best

“Two men can close in a house in 6 hours,” says Hass

Around Hyattsville, Md. (near Washington, D.C.), Hass & Carson are known as builders who never put up a “cheap” house. Yet hundreds of their homes have sold for less than \$14,000; and today the price range is \$14,650 to \$15,850.

John Hass, who bosses construction for the firm, says sheathing is a key item, both for strong, snug, solid walls and for really important cost savings. And for 14 years . . . since the first year he started in business . . . Hass has used nothing but Insulite Bildrite Sheathing.

“We use 30 sheets of 4' x 9' Bildrite and 8 sheets

of 4' x 8', on an average house,” says John Hass. “Just stack it by the foundation; never have to worry about rain hurting it. As your picture shows, we use almost every cut-off piece to fill the areas on gable ends. Bildrite cuts easy, nails up perfectly, makes a strong, warm, wind-tight wall, and leaves almost no waste. Best of all, two carpenters can close in a house completely in 6 hours.”

Want to speed up your building . . . reduce waste . . . and add more strength and insulation without extra cost? For facts on Bildrite Sheathing, write us—Insulite, Minneapolis 2, Minnesota.



4' x 9' size avoids “piecing out,” in vital sill area between foundation and sidewall. One man can easily lift, carry and nail a big, light 4' x 9' Bildrite panel. Applied, it makes a solid, tight, strong insulating shell from eave line to top of foundation.

They sell like hotcakes, at around \$15,000; and typical Hass & Carson home features 3 bedrooms, living room, dining room, kitchen, wall oven, entrance hand-rails, broad concrete driveway. Small, highly-trained H&C crew enjoys steady work the year around.

build better, save labor, with
INSULITE
Bildrite Sheathing



INSULITE, made of hardy Northern wood. Insulite Division of Minnesota and Ontario Paper Company, Minneapolis 2, Minnesota

INSULITE AND BILDRITE ARE REG. T.M. S. U.S. PAT. OFF.

URBAN RENEWAL:

Builders tell officials why they spurn projects: 'timidity,' red tape, delays

Past President Richard G. Hughes of NAHB got up before a distinguished assemblage of some 90 urban renewal experts last month in Washington and laid it on the line.

Why, he asked, aren't builders getting into urban renewal? "Everybody wants the program to succeed. Why then have the actual results been so meager?"

Builder Hughes, chairman of NAHB's National Housing Center which hosted the two-day session, answered his own question: no profit opportunity. Why? At first, because the "main tools"—FHA's Secs. 220 and 221, are snarled in red tape. Now, physical handicaps, he conceded, have been largely removed. But the "psychological" risks spawned by the Senate's celebrated inquisition into 608 windfalls "still remain."

"If I made a profit under one of these new programs, I would be in constant fear," said Hughes, recalling his uncomfortable hours on the kleig-lighted windfall witness stand while he was NAHB president. "We may have to wait for a new generation of builders and perhaps a new generation of FHA administrators" before renewal will really work, he predicted.

Hooks but no bait

This gloomy outlook was echoed by James Scheuer, whose City & Suburban Homes of New York has become one of the nation's biggest redevelopers—it has project contracts totaling \$50 million in Sacramento, Washington, St. Louis and Cleveland—mostly in partnership with local firms.

"Unless the average builder gets in, the program is going to die aborning," he forecast. "If an experienced builder like Dick Hughes has not been able to see that the program adds up, I don't know what hope we can hold out for the average builder who knows less about it."

Chicago adopts law to expose hidden slumlords; lenders pledge 'no loans'

"It is the virtually impregnable anonymity of the professional slum builder that enables him to go merrily on his way turning more and more shacks into more and more shekels."
—The Journal of Housing.

Chicago, the nation's second biggest city with the second biggest slum problem, is getting set to force ghost landlords of slums into public view.

The city council has adopted an ordinance requiring registration with the city building department of all buildings with more than two dwelling units, plus the name of their owner. If the title is held in trust, the trustee would be required to record the fact with city officials. The owners' name would also be posted inside the building.

It is a simple piece of legislation. But steering it toward passage took a major effort in a city where crowding produced by massive Negro in-migration still lets slums grow faster than they are being cleared.

Pinpointing renewal's problems, Scheuer complained:

"Procedures are too time-consuming.

"It is not set up as a builder-program but as an investor-program. That's the reason you see empty chairs in this room.

Nibbles but no bites

Results of the meeting bore out Experts Hughes and Scheuer. One of its aims was to bring local redevelopment officials in personal contact with private redevelopers and financiers who might "buy land across the counter from the people who have the land to sell." Twenty-seven cities grabbed the chance, set up displays of their projects. As the meeting ended, local officials reported "a lot of nibbles" from 50 interested builders, but no firm—or even tentative—deals.

Other ideas aired at the conference:

• To speed up renewal, contended James W. Rouse, Baltimore mortgage banker who headed the 1953 Presidential advisory subcommittee that hatched today's renewal concept, the federal government should adopt a whole new approach. It should say: "Sure cities are going to make mistakes. But go ahead and get the job—with a minimum of criteria. There is not enough confidence in cities. And there is too much fear of criticism."

• To lure builders into Sec. 220 sales projects, suggested Builder R. H. Barrett of San Francisco, FHA needs to create a "separate processing procedure—not based on a Sec. 203 replacement cost formula. This could permit recognition of organizing expenses. Builders should be able to recover higher marketing expenses due to special conditions, such as interracial buying [open occupancy is mandatory], neighborhood blight not yet removed and lack of completed community facilities."

The measure first came before the city council in late December labeled as a major proposal of Mayor Richard Daley's administration. But no Democratic alderman spoke for it—apparently in fear of political repercussions at 1958 elections. Several denounced it. The bill bounced back to a committee.

Mayor Daley took a bigger windup. Cried he: "This is one of the most important pieces of legislation* introduced in the last 2½ years while I have been mayor. One of the real problems [of Chicago's fight against slums] has been to ascertain the true owners who have been gouging the public on buildings not fit for human habitation."

Chicago newspapers backed him up. ". . . An important ordinance to check the

* Chicago's ordinance is modeled after a New York City law, which New York officials say is a flop because of two technical loopholes. Bills are pending to close them, but anti-slum enforcement in New York wins no prizes.

growth of slums," editorialized the *Tribune* with enthusiasm.

A few days later, Daley took the rare step of appearing personally before a city council committee to press his view. He agreed to drop provisions calling for owners to file detailed plans of every building. Critics charged this would force some 250,000 owners to hire architects. Instead, Daley agreed to require plans only when alterations or additions are built.

The law carries a \$100 fine and 30 days in jail for the first offense. Subsequent violations involve a maximum \$200 fine and up to 90 days in jail.

Scarcely was the law on the books before Chicago got the kind of remainder of its slums that always produces a flurry of official activity. Three slum fires took 13 lives in eight days. Properly indignant, Daley organized a task force of 135 firemen to inspect buildings, in a large area on the South Side. He put more heat on the building department, and two of its inspectors were suspended. The municipal court assigned more judges to hear housing cases (for years, Chicago slum fighters have been complaining about wrist-tap fines and constant continuances that mock their efforts to hound slumlords).

Most important of all, Chicago mortgage bankers adopted a stiff policy of refusing mortgage loans to buildings with illegal overcrowding or conversions. In letters to its 150 member institutions, MBA recommended clauses permitting immediate calling of a loan if the building isn't maintained, is altered or undergoes substantial change in its use without the lender's consent.

PUBLIC HOUSING:

PHA studies plan to buy standard builder-homes

Public housers are dickering with a California builder over plans to buy 50 units of his regular houses for a Sacramento public housing project.

It is the first time the Public Housing Administration has considered such a deal.

It ties in with Commissioner Charles E. Slusser's growing list of experiments with single-family units (Mar., News) in an effort to let public housing escape the social stigma projects have acquired.

PHA's regional office in San Francisco has discussed plans for the precedent-breaking move with Stanley Davis Co., Bay area firm that has built some 3,000 homes in the last 10 years. PHA officials report: "His designs provide considerable flexibility so far as number of bedrooms is concerned and substantially meet the standards followed by PHA in evaluating plans submitted by local housing authorities for individual projects."

The plans call for the 50 units to go on scattered sites. PHA says savings in land development would be "substantial." Buying homes from a builder also promises to save money on planning, review and approvals says PHA.

Prefab public housing for tornado-hit city

Single-family and duplex prefabs on scattered sites are being planned by public housers for Murphysboro, Ill. (pop. 10,000) to rebuild a tornado-cleared slum.

Realtors are annoyed about it. "This is the second small community invaded by public housing with this type of construction," cries NAREB's weekly newsletter, *Headlines*. In the first, Cedartown, Ga., PHA negotiated a contract with National Homes for com-

ponents for 20 units of one- and two-family homes (Mar., News). In Murphysboro, PHA plans to take bids on 90 units, with plans specifying modular design. If a conventional builder wins, he will get the job.

Even though the town has no workable program for urban renewal, PHA has handed it an \$18,000 preliminary loan to start planning. William E. Bergteron, PHA's Chicago regional director, says the town may get the units "in nine months or less." He explains: "Under ordinary procedures, such a program would require between 24 and 30 months.

77 single mothers forced to leave public housing

Single women who become pregnant while living in Cincinnati's public housing projects are being ordered to find another home.

In February 1956, Housing Authority Director Harry L. Reece pointed in outrage to the number of illegitimate births in the city's 4,242 units, warned that any single woman who became pregnant after April 1, would have to move out within 45 days after the love baby was born (Aug. '56 News).

Since then 77 single mothers have been forced out; 47 left voluntarily when they became pregnant; 21 moved when ordered by Reece; nine who refused to leave were evicted by court order.

Reece believes the illegitimacy rate is lower now. Says he: "We think the threat of eviction brought the rate down. Some of the women just started different lives after the order. We'll take an unwed mother and her child—or children. But one offense after she moves in and out she goes. We just don't want promiscuity."

Suede shoe Who's Who achieves record size

A record 6,700 remodeling contractors—firms and individuals—are now on FHA's "gray list" for Title I repair loans.

The list contains the names of remodelers who have been reported to the agency as flouting its repair loan rules—anything from outright fraud to slipshod workmanship. Repair loan lenders (FHA does not screen such loans itself) are required to take extra precautions that home owners are not gypped before paying "gray list" firms for fixup work. Lenders must:

1. Verify all statements in the home owners credit application. (The suede shoe scandals that accompanied FHA's windfall scandals of 1954 showed many a gyp fixup operator was falsifying applications, often after persuading ignorant home owners to sign in blank.)

2. Require borrowers to sign a certificate that the fixup work was completed in the presence of the lender whom FHA insures.

3. Inspect the work if it cost \$500 or more, and inspect one of every three jobs costing less than \$500.

4. Sign a statement for FHA that items one through three were complied with before contractors were paid from the repair loan.

FHA repair loans gain 25 % ; spending pattern the same

FHA Title I repair loans were up 25% last year from 1956 (to \$868.6 million). And January was up 25% over January '57. But the money was spent much the same way as before:

Alt. & add'n.....18.2%	Ext. finish10.4%
Int. finish..... 8.7%	Roofing 5.1%
Plumbing 8.7%	Heating13.1%
Insulation18.8%	Non res. misc...17.0%

REMODELING:

Gyp operators cash in on fix-up push, Better Business Bureau warns

Booming promotion of home improvement is producing a new outbreak of gyp contractors.

This warning comes from Houston's Better Business Bureau, whose executive vice president, Ed Buehner says fix-up publicity "has created open season for the fakers." He reports a big upsurge in calls from people who 1) wonder if that nice man with a special repainting deal is honest, or 2) have heard the bureau's barrage of radio spot announcements warning against gyp repair men.

Two years ago, the Houston bureau produced a six-page colored pamphlet warning householders against repair rackets. Some 2 million copies have been distributed—through legitimate contractors and supply houses, and in answer to phone calls (currently 500 a week). A new half million printing has just been ordered.

Houston's No. 1 racket: fixing roof gutters with newspaper and black tar. "They just charged one old lady \$500 for such a job," says Buehner.

Efforts at ethics

The Home Improvement Council, national spark-plug of home repair promotion, is trying to purge the industry of suede shoe operators (as is NERSICA). It has drafted a code of ethics which it wants the Assn. of Better Business Bureau (108 in the US and Canada) to help promulgate.

HIC is still pushing hard for members, now has 2,500 (1958 target: 6,000). Two local chapters have been chartered, in New Orleans and San Francisco's East Bay area. The latter is affiliated with the local home builder assn.—the first time organized home building has

officially joined hands with fix-up. It already has 60 members, 15 of them also in the builder group. Chapters expected soon: Birmingham, Ala.; Galveston, Tex.; Los Angeles; Minneapolis/St. Paul; Charlotte, N. C. HIC charges local members \$25 (\$50 for firms with over 50 employees).

Old tricks for new dogs

In Detroit, a classic in the suede shoe repertoire—the mortar rat*—has just resulted in five arrests. The dodge usually works this way:

A man calls at a house, says the chimney looks in bad shape and offers to inspect it. If the offer is accepted, he reaches in the soot door or fireplace and pulls out a white rat. "Just as I thought," he tells the horrified home owner, "A mortar rat. They eat all the mortar out of the joints (that's what makes them white) until the chimney falls down." Then he offers to fix it and get rid of the rats for as much as the traffic will bear.

But the accused Detroit chimney doctors made the mistake of calling on a local official who knew something about building. He called police, who uncovered a hidden supply of white rats in the operators' truck. Five men—Richard Frese, Raymond Gardner, Joseph Love, George Puninske and Robert Foster—were charged with conspiracy to obtain money under false pretenses.

FHA has told its local offices to watch out for the mortar-rat racket.

* Some others: chemically treated paper which changes color in the air stream of a furnace "indicating poisonous fumes"; powder which turns the water in a toilet bowl blue "showing dangerous drains."

Repair contractor group struggles to promote more one-stop shops

"The building industry is not yet geared to making a real business of fixup on any wide scale."—HOUSE & HOME, Feb. '55.

Three years later, the home repair business looks almost as disorganized as ever, even though its dollar volume is on the rise.

With stepped up urban renewal beginning to generate rehabilitation work in quantity, members of NERSICA, the national fixup contractors group, centered their February convention around ways to cash in on a new boom. But only a hard core seemed really interested.

Average attendance at educational sessions was around 25. One talk, fighting a bathing beauty contest for an audience, was postponed because only eight persons showed up.

Whipping up member interest in an industry still largely composed of small specialty contractors is probably NERSICA's biggest problem year-round. "Too many of our local councils have been resting on past laurels," admits one NERSICA officer. "Others have to do something to justify their existence at all."

NERSICA President Joseph I. Sargon, a one-stop remodeler from Boston, is in there pitching. Last year, he says he traveled 40,000 miles visiting NERSICA locals. He says he helped start another 15 or 20 chapters.

"Home improvement continues to offer a

splendid market. . . . Those of us who are really interested have good reason to feel optimistic," says Sargon. More of the same preaching looms ahead for him. A stormy "members only" meeting (attendance: about 40) failed to elect a new slate of officers. ("Too much other business," explained an aide, even though newsmen outside the room heard noisy argument over whether a quorum was present.) Afterwards, it was announced

continued on p. 84



OFFICIAL PRAISE: NERSICA's efforts "to promote a higher ethical standard for the improvement industry" were lauded by Frederick H. Mueller (l), Asst. Secretary of Commerce, shown with (l to r) NERSICA President Joseph I. Sargon, FHA Commissioner Norman P. Mason, NERSICA Managing Director Frank Martin.

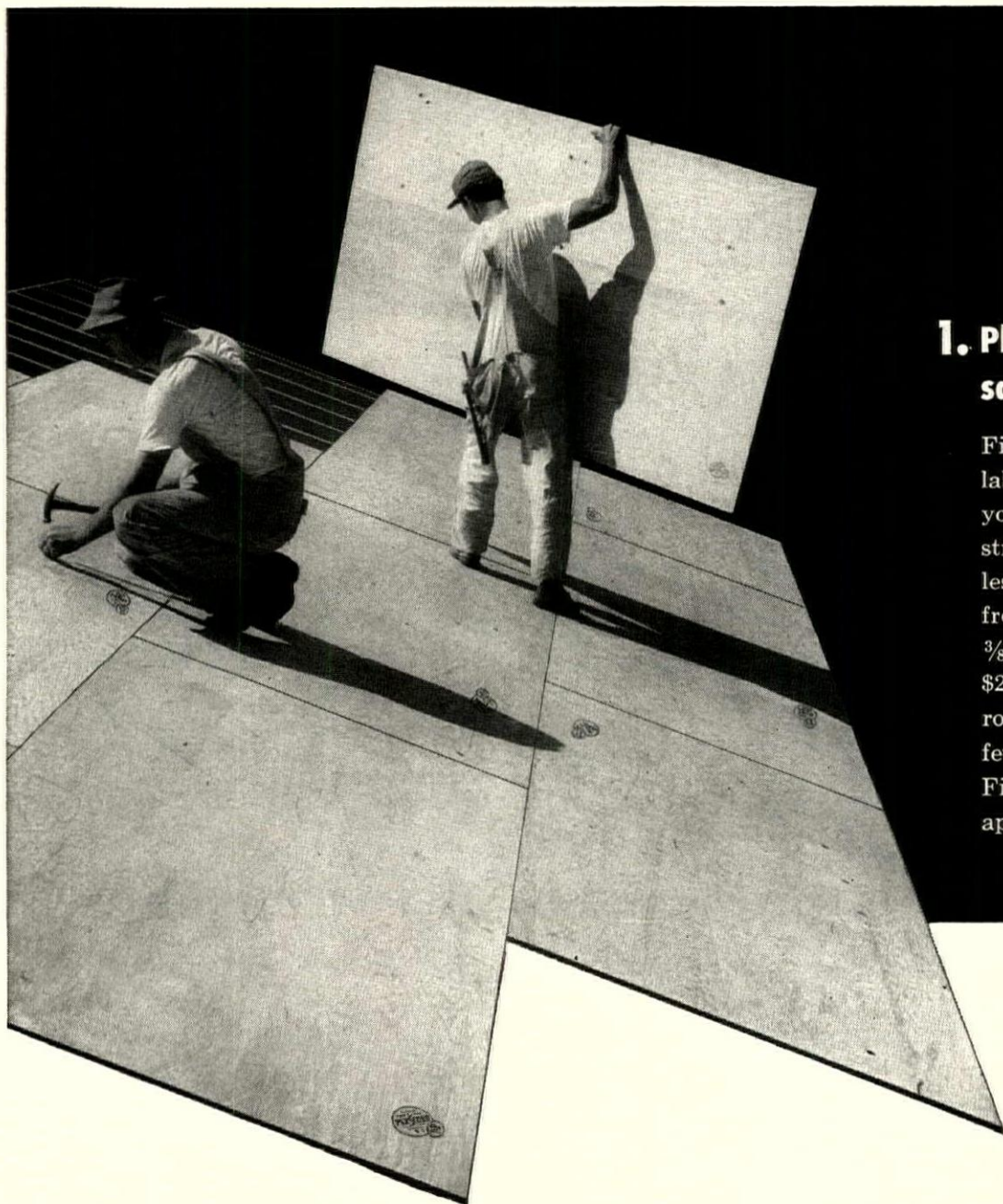

1. PlyScord roof sheathing saves up to \$2.00 per square

Figure *all* the costs—material, time, labor, waste and nails—and you'll find you can offer your prospects the plus structural advantages of PlyScord at less net cost to you. Exact savings vary from area to area, but builders report $\frac{3}{8}$ " panels over 24" rafter spacing save \$2.00 and more per square. PlyScord roof decking goes down fast. Requires fewer nails. Stable, resists buckling. Finish roofing looks better, is easier to apply on firm, solid PlyScord decking.

For at lower



2. PlyScord wall sheathing saves 25% in labor costs

Large, light PlyScord panels save 25% and more in application time and costs. And because of its extra strength and rigidity (over twice as strong and rigid as diagonal lumber), you can omit conventional diagonal bracing. PlyScord's extra rigidity makes it ideal for shear walls in buildings with large glass areas, provides an added measure of protection in case of storm or earthquake.

FOR COMPLETE INFORMATION, specifications, design data, write for free "Plywood Construction Portfolio." (Offer good USA only.) Douglas Fir Plywood Assoc., Tacoma 2, Wash.

PlyScord, $\frac{3}{8}$ "-thick on 24" span, easily withstands 500 lb. concentrated load or uniform load of 30 lbs. per square foot. Construction meets FHA Minimum Property Requirements.



Two types of PlyScord are now available: Interior PlyScord (moisture-resistant glue) and PlyScord with Exterior (waterproof) glue line. Trademarks above identify panels produced under DFPA quality control program.

Tests on roof exposed two years show force of 85 lbs. required to pull cedar shingle from 5/16" PlyScord. In same tests, composition roofing was torn loose, leaving nails in plywood.



the best construction, in-place cost, specify PlyScord[®]

3. Use inexpensive PlyScord backing for tile, hardwood

Firm, solid PlyScord backing simplifies installation of finish wall and ceiling coverings such as tile, cork, thin paneling. Plywood's strength and stiffness makes them look better with no unsightly buckling. Easy to cut, fit and fasten, fir plywood grips nails firmly so they won't work loose to mar appearance of wall or ceiling coverings.



Only panels bearing DFPA grade-trademarks are manufactured under the industry-wide Douglas Fir Plywood Association quality control program. Always look for the letters DFPA.

Fir Plywood

Glamour

ALUMINUM SLIDING GLASS DOORS



Glamour Sliding Glass Doors now being used in all Centex Homes Elk Grove Project, 6,000 residences, Elk Grove, Ill. by Centex Construction Co., Dallas, Texas.

FAMILY LIFE, INC.

Every feature A FINE SLIDING DOOR should have — Yet at less Cost!

GLAMOUR offers you the ideal package... custom quality, *really* easy installation, lasting, trouble-free performance... *all at less cost!* The following features are only hi-lites of GLAMOUR'S value—be sure to send for full data!

- Now, the 1958 GLAMOUR Sliding Glass Doors can be converted from *double glaze to single glaze without extra cost!*
- One unit now does the work of two!
- Available K.D. in multiples of 3 ft. (6', 9', 12', etc.); 4 ft. (8', 12', 16', etc.); 5 ft. (10', 15', 20', etc.); or 6 ft. (12', 18', 24', etc.).
- COMPLETELY ANODIZED—6063-T5 Satin Finish, thick aluminum—heat-treated, rust-proof.

- New snap-on glazing moulding (Pat. applied for).
- Bottom-mounted ADJUSTABLE ball-bearing rollers—adjustable after installation without removing frame.
- Complete weather control. Wool pile (by Schlegel) seals at all times regardless of the level of door or sill. Twin-sealed at locking stile and jamb. Weatherstripping replaceable without dismantling door.
- No extra mullions needed in any multiple GLAMOUR units.
- Overall opening height 6'9".
- All doors use STANDARD SIZE single glass and STANDARD SIZE TWINDOW or THERMOPANE.

A FEW DISTRIBUTORSHIPS AVAILABLE

Glamour Glass Wall-Dor Corp., Dept. HH-458
3040 W. Lawrence Ave., Chicago 25, Illinois

Gentlemen:

Please send complete details of the GLAMOUR Aluminum Sliding Glass Doors and low prices.

Name _____

Company _____

Address _____

City _____ State _____

I am a Bldr. Distr. Dealer Arch. Other

Glamour

GLASS WALL-DOR CORP.
3040 W. LAWRENCE AVE.
CHICAGO 25, ILL.

Sargon will temporarily continue in office for a third year.

Other convention developments:

- Col. Shelton P. Hubbard, boss of New Orleans division of housing improvement, reported the city's five-year-old push for slum rehabilitation (Oct. '53 et. seq., News) is creating jobs for a "growing but still insufficient" group of fix-up contractors. So far, said the colonel, 11,000 blighted units have been surveyed, 6,800 refurbished. Another 2,500 will be fixed up this year. "There's money to be made," said Hubbard. A typical contract, he said, runs from \$35,000 to \$40,000 for eight units.

- ACTION's Leo Molinaro urged fix-up contractors to jump on the rehabilitation band wagon. "We'd love to tell people you are ready to get into the fight against blight," he said. "We have to hear from you first."

- "The fix-up industry has never had to worry about a market," said FHA Commissioner Norman P. Mason, "but you haven't begun to touch it yet." Mason admitted "we have not yet found an adequate vehicle for financing this kind of work. . . . The present Title I limit of \$3,500 is just not enough, and amortization should run 15 or 20 years."

Mason said he liked NERSICA's proposed "rehabilitation mortgage" (which would include improvements in the appraisal of a resale house, spread their cost over a full mortgage term). "Something along this line has to be done," he said.

- NERSICA's long-standing campaign against bait advertising may be pepped up this year. Said President Sargon: "We hope to promote some new state bills banning it, put teeth in the laws there are." One way he would like to tighten up: have injunctions to halt bait ads pending hearing of suits.

- Conscious of a trend toward one-stop remodeling, "which many of us are still not geared to handle", some NERSICA locals (Louisville is the first) are promoting cooperative contracts in which the job is split between members, but the customer deals with just one, makes one payment.

- Always cagey about membership figures, NERSICA was curiously evasive about convention attendance. First claim was a record-breaking 15,000. This was later whittled down to "around 11,000." (Convention hardened Atlantic City reporters estimated around half that.) NERSICA announced 238 exhibit booths; an on-the-scene count showed 160.

Omnibus housing bill faces long delay

continued from p. 56

overhead and profit under FHA's present formula.

6. Give FHA Sec. 221 (relocation housing) a shot in the arm by raising the per-unit limit from \$10,000 to \$12,000, and killing the requirement that a city ask HHFA for it before 221 can be used. Rental housing under Sec. 221 would be opened to profit as well as non-profit corporations. Maximum loan for profit corporations would be set at 95% vs. the present 100% mortgage for non-profit corporations.

7. Kill the much-criticized law forcing Fanny May to buy special assistance mortgages at par, boost the maximum loan Fanny May can buy from \$15,000 to \$20,000 and give the agency \$90 million more authorization to buy special assistance loans.

8. Carry out President Eisenhower's proposals for reducing federal aid to urban renewal. The bill would authorize \$200 million more grants for fiscal 1959, \$250 million in each of the next three years and \$200 million in each of the next three fiscal years.

NEWS continued on p. 88



\$10,945 MODEL with four bedrooms has neither garage nor carport, no basement, gutters or downspouts, but offers 1,162 sq. ft. of living area. Lots average 75' x 180'. The tract is to be served by builder-owned water and sanitary sewage disposal systems.

COMMUNITY FACILITIES:

How not to open up a rural area for low-priced housing

When home builders move into virgin acreage beyond the edge of suburbanization, do they have a responsibility beyond that imposed by whatever rudimentary subdivision controls may be on the books? Legally, they don't, of course. But more and more communities are reacting to the results of such construction operations by raising real obstacles to home building for the mass market. A good case in point is Cranberry Township, a tiny rural pocket north of Pittsburgh. When mass building abruptly engulfed it, Cranberry was not prepared. The resulting hassle scarcely enhanced the standing of home building with the 2,213,236 people of the Pittsburgh metropolitan area.—Ed.

Suburbanization has caught up with a complacent rural township outside Pittsburgh—and with it community chaos.

The township of Cranberry (pop. about 1,000) lies 26 mi. north of Pittsburgh in the undulating Allegheny Mountains. It is a farming area but also has a few wildcat oil wells. It has no zoning ordinance, no building code, no subdivision standards to speak of—and apparently felt it needed none.

But that was before last November when Dover Construction Co. of Cleveland opened a new 327-home development called Fernway on a 200-acre section of Cranberry—the first housing tract in the township. (Dover paid only \$395 per acre vs. the prevailing \$2,500-per-acre and up, closer to Pittsburgh.)

Builders William Risman, Hal Gootrad and Henry Lefkowitz, Fernway's principals, took aim on the low-price market Pittsburgh builders are having more and more trouble serving, thanks to high land prices, wasteful codes and community restrictions. They offered a four-bedroom, two-bath clapboard home for \$10,945—selling with a 75% conventional first mortgage, a 22% second (which the builder took) and a 3% down payment of \$300. Monthly payments: \$72.

300 sales in one day

Dover preceded its Nov. 10 opening with full-page newspaper ads plus a barrage of radio and television promotion to proclaim: "Mr. Dover is coming to town". Response was immediate. On opening day traffic backed up bumper-to-bumper as far south as the Sixth St. bridge, 25 mi. away. In two days, Dover took orders for 300 homes. Despite cancellations and rejections for credit reasons, Fernway still had only 27 unsold homes nine-weeks after opening.

And this record was set despite the monumental commuting problem (by Pittsburgh standards) faced by buyers who work in the city: \$1.70 per day for buses which do not run often, or an hour or more each way by car in rush-hour traffic.

Though sales were even better than Dover

had expected, the company soon learned that community acceptance was far worse.

Builder Risman, president of Dover, had not submitted his tract plans to local town officials. In a community which had no requirements other than a minimum 1/4-acre lot, there was no legal reason why he should. But there was a practical reason.

Cranberry, like many another rural township, was ill-prepared for a big increase in population and the consequent demand for community facilities.

It has only one elementary school. Junior and senior high pupils attend schools in neighboring towns. The township is in debt up to the hilt because of the one school, built in 1952, plus an addition started last year.

It has an archaic tax system, assesses at about 20% of true value. The township collected \$31,000 in school taxes last year on valuations of \$900,000. Investors are so skeptical of the township's finances they charged a whopping 5 1/4% on \$230,000 in tax



\$395 PER ACRE land led builders to rural Cranberry Township, 26 mi. from downtown Pittsburgh and some 15 miles beyond the fringe of suburbanization.

exempt bonds for the 1957 school addition. Fiscal experts have told township officials they can't borrow any more unless their tax structure is revamped.

Yet 327-home Fernway means an overnight doubling of the township population, a probable addition of 300 or more school pupils. One Cranberry oldtimer warns: "About 150 children will be left standing at curbs next September, waiting for the school buses that will not come to take them to a school that does not exist."

Belated outcry

It was entirely predictable therefore that when Fernway opened, sleepy town officials belatedly realized they were in trouble. The Municipal Authority, organized in 1952 to build the school, and the school board warned there would be no schools for Fernway children. Township supervisors protested they would not shoulder the cost of maintaining the water and sewage disposal systems (though Dover never asked them to) and could not afford to provide police and fire protection or street maintenance. They announced they would all resign if Fernway were built and let the development solve its own facilities problems.

Six weeks after the tract had its socko opening, they went to court seeking a restraining order to stop Fernway, drew front-page headlines in Pittsburgh papers with their charge that the development would "wreak chaotic and financial ruin in the township."

Supervisors found one legal loophole overlooked by Dover. Though Cranberry has no ordinance requiring township approval of a new subdivision, Pennsylvania law does require subdivision approval by the township when it creates a roads or drainage problem.

They hastily passed a new ordinance a month after the Fernway opening, requiring minimum 3/4-acre homesites instead of 1/3-acre. Since Fernway had yet to be presented to them for approval, they contended the new ordinance would apply and would limit the number of new homes to 144 instead of 327.

Dover settles

Builder Risman and his associates wilted under this pressure, quickly offered the township \$42,000 to pay for new school facilities. The township accepted, withdrew its suit.

School officials admit the \$42,000 will not solve their problem. But they have arranged for more children to attend neighboring schools. Moreover, Dover has agreed to ask its buyers to agree to a \$100 increase in their second mortgages. This \$30,000 also would

continued on p. 88



When they ask to see the Furnace...

...**SHOW THEM THE ONE THAT'S**

*Show them **SUN VALLEY***All-Year[®]*

*TRADEMARK PRODUCT OF ARKLA AIR CONDITIONING CORP., EVANSVILLE, IND. & SHREVEPORT, LA.



AN AIR-CONDITIONER TOO!

Gas Air-Conditioning by **ARKLA-SERVEL!**

**Cools the entire home in Summer
from a single compact Gas unit.
(Heats in Winter, too!)**

SHOW THEM the most effective way to beat any heat spell. No more drafty fans . . . no more spot cooling in a couple of rooms. The Sun Valley* by Arkla-Servel cools the entire house (every room of it) from a single compact unit. And your prospects will like the peace and quiet of the Sun Valley*, too! There's no noise because there are no moving parts in the cooling system.

SHOW THEM how easily the air conditioner can be turned into a furnace when blustery winter comes booming in. A simple dial setting—and presto!—the Sun Valley* by Arkla-Servel is the most wonderful furnace! It circulates gentle warm air to every room of the house. And with Gas your prospects will never have to worry about late fuel deliveries—dependable Gas is piped right into their homes.

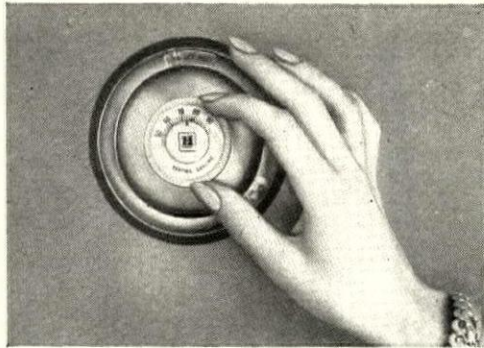

SHOW THEM how a single and simple thermostat looks after them night and day—with complete and correct moisture control both winter and summer. They merely set the thermostat to a desired temperature, and the Sun Valley* maintains that degree of heat or cooling around the clock. They're safe from all kinds of weather . . . and further protected by Arkla-Servel's five year warranty, too. AMERICAN GAS ASSOCIATION.

ONLY GAS



**does so much more...
for so much less!**





Refrigerator section:
10 cu. ft.
Freezer compartment:
13 cu. ft.
(holds 45 lbs.
of foods)
Height, 82 inches;
width, 36; depth, 24.
LOWEST COST
PER CUBIC FOOT
OF CAPACITY

Manitowoc's

new built-in 2-zone[®] makes sales for builder

"We enjoyed closing several home sales and about 50% of the buyers included the 2-Zone in their purchases."

So reports James M. Nichols, Nichols Construction Corporation, Milwaukee. His letter continues:

"I put a built-in 2-Zone into my home, which was included in the 1957 Parade of Homes and given an award for originality and use of new materials. Interest shown by thousands of people was tremendous, and the 2-Zone caused more comment than any other individual

item. . . . I have a fair knowledge of competitive units and am convinced that the 2-Zone is by far the best. . . . Larger capacity and installation ease caused me to decide in its favor . . . and I would not want to use anything but the Manitowoc 2-Zone again."

Mr. Nichols' reaction is your cue to offer the 2-Zone to your customers. They'll have America's most desirable combination, with its practical capacity and honest construction; you'll profit by simplified installation, customer goodwill and trade discounts.

Triple-tested



by MANITOWOC,
PARENTS' MAGAZINE
AND
GOOD HOUSEKEEPING



THIS
COUPON



is your
gateway to
2-Zone
profits.
Use it
today!

MANITOWOC EQUIPMENT WORKS
Manitowoc 35, Wis.

Send all details about:

- Built-in 2-Zone Free-standing 2-Zone
 Upright Freezers Chest Freezers

CLASSIFICATION:

- Builder Architect Dealer
 Wholesaler Kitchen specialist

.....

Other

NAME

FIRM

ADDRESS

CITY, STATE

8297

go to the school board. The board will convert a library and an all-purpose room in its new addition into classrooms.

The long range solution may be a little more difficult for some present residents of Cranberry to swallow. The township now plans to boost assessments from about 20% of value to 32 or 40%, thus improving its tax take.

More tracts expected

But a host of community problems still remain. If Fernway's buyers decline to lay out that \$100 more on their second mortgages, says the vice president of the Cranberry school board, then no new school.

And Cranberry, itself, may now boom. The township is in the path of the Eric extension of the Pennsylvania Turnpike. (There will be an exit within a half-mile of Fernway.) This project and other roads to be built under the federal highway program will bring Cranberry within a half-hour of downtown Pittsburgh.

The time needed to build the roads may give Cranberry enough time to overcome some of its greatest deficiencies. Supervisors are hurriedly putting together a building code. A five-man planning commission has been named and is seeking the services of a professional planning consultant. It has imposed a 100' minimum frontage for home sites.

Fernway—which some Cranberry oldtimers still deprecate as "sub-standard to the area"—is going up under an uneasy truce between the builders and the community. But the area now seems closed to any more low-price new homes. Says Pittsburgh Builder H. C. Degenhardt: "Builders aren't pricing their homes out of the market. Communities are doing it for us."

\$125-per-home fee to aid schools voided in Colorado

Another state court has slapped down a school fee charged for building permits for homes. A \$125-per-house fee assessed against builders since 1955 for schools by Arapahoe County, Colo., south of Denver, was ruled illegal. The county board, informed by its attorney that there is practically no chance of reversal, will not appeal.

This is the third victory for builders in as many states on this issue. Builders have also won court decisions in two other states on related questions.

The Arapahoe fee was imposed on the contention that new homes often escape county taxes for as long as 20 months because they are not on the tax rolls early in the year when taxes are assessed. The county board argued that the \$125 fee forced new-home owners to help support the schools until they paid realty taxes.

The fee was taxed in two suits, one by Builder-Architect Miles V. Lantz and another by Builder Newton L. Kozer, both of Denver. District Judge Martin Miller held that county governments can charge only fees and taxes provided in the state constitution and the school fee is outside those limits.

About \$200,000 has been collected and held in escrow since 1955. It will be returned to the builders who paid it.

Judge Miller's reasoning closely parallels that of jurists in the case of Park Ridge, Ill. (March, News) and of the Borough of Pt. Pleasant, N. J. (April '57, New). In these cases the courts held that the local community does not have constitutional power to raise revenue for schools by a building permit fee.

A Michigan court held a \$50 park fee charged builders by Redford Township (a Detroit suburb) illegal for the same reason.

PEOPLE: Tom Sweeney quits as head of VA loan guaranty service to become mortgage banker

Last spring, **Thomas J. Sweeney**, head of VA's loan guaranty service, got up before a meeting of NAHB directors just after tight money began to make VA loans a dead letter.

"Well," he wisecracked, "it's been nice knowing you."

Last month, his offhand prophecy became fact. Like so many able civil servants before him, Tom Sweeney called it quits after 25

Art Shay



SWEENEY

Bertram King (now a vice president of the S&L League), stepped up to head man when King left the government in 1955. In 14 years, he helped VA underwrite more than 5 million mortgages totaling some \$43 billion.

Cleveland-born, Sweeney attended St. Ignatius College there and Georgetown University in Washington, then went into real estate with Fulton R. Gordon in the capital. He joined HOLC in Washington in 1933 and became special assistant to the general manager two years later. During World War 2, he was budget officer for several new alphabetical agencies including the Office of Economic Stabilization.

Beverley Mason, FHA renewal expert, gets top technical job

A surprise appointment has boosted an urban renewal staffer into FHA's top technical job.

W. Beverley Mason, 49, for the last three years special assistant to Commissioner **Norman Mason** (no kin) in charge of urban renewal, is FHA's new assistant commissioner for technical standards. He succeeds **Charles A. (Dell) Boswer**, former Lansing, Mich. home builder who has joined Webb & Knapp Communities as general manager of its big project near New Orleans.

Walter Daran



MASON

In his new post, Mason will supervise not only FHA underwriting and mortgage credit analysis but also its highly rated architectural standards division. Both **Alfred Jarchow**, director of appraisal and mortgage risk, and **Neil Connor**, chief of architectural standards, were considered in the running for the job.

Mason's appointment may be only the first of a series of moves to beef up the agency's top ranks. The new technical boss, a native of the District of Columbia, studied engineering two years at the University of North Carolina, then worked for Architects **Porter & Leckie** and **William P. Lipscomb Co.**, general contractors, in Washington. He first joined FHA in 1938 in the underwriting section. From 1948 to '53, he headed the

construction section of VA's loan guaranty service, then became a Washington housing consultant. He returned to FHA in December 1953 as assistant to **Clyde Powell**, then director of its multifamily housing division. During World War 2, Mason was a Navy lieutenant.

New FHA district directors; HHFA opens offshore office

FHA has named three new district office directors:

W. Herbert Welch, 41, former special assistant to FHA Commissioner **Norman P. Mason**, was appointed head of the Charleston, W. Va. office. He succeeds ex-Congressman **Hubert S. Ellis**, who retired because of ill health. Welch, publisher of the weekly *Republican Delta* in Buckhannon, W. Va., was executive director of the President's advisory committee on housing policy which drew up plans that led to the celebrated Housing Act of 1954. Later, he served as HHFA's congressional liaison officer and as FHA information director.

A former builder and realtor, **Robert Powell Cunningham Jr.**, 40, of Oxford, N. C., was appointed state director of the North Carolina office in Greensboro. He succeeds **J. Lawrence Widman** who resigned to return to private business. Cunningham headed FHA's Charlotte office in 1957.

Attorney **Joseph Nardone**, 42, was appointed FHA director in New York City, succeeding **William Adam Shulz** who resigned to re-enter private business. Nardone was an attorney-advisor to FHA in 1953, has also worked for New York's rent control commission.

Paul Coste of Philadelphia, retired eastern district manager of B. F. Goodrich Co., was appointed administrator of HHFA's new regional office (its seventh) for Puerto Rico and the Virgin Islands at San Juan. The two territories have huge urban renewal and public housing programs. Some \$44 million of redevelopment is under way in 35 Puerto Rico cities. Puerto Rico has 17,651 public housing units in operation, 2,800 more under construction and another 10,800 planned.

TITLE INSURANCE: **Harold W. Beery** has been named president of Home Title Guaranty Co., New York, succeeds **Milton T. Vander Veer**, who becomes chairman and continues as chief executive officer; **Ernest J. Loebbecke**, president of Title Insurance and Trust Co., Los Angeles, has announced purchase of Union Title Insurance and Trust Co., San Diego, which will operate as a wholly owned subsidiary with no change in management personnel.

Booming markets draw northern builders south

More builders and developers are moving outside their home states to take advantage of booming markets elsewhere. Items:

Near Tampa bay, Builder **Francis J. Corr** of Lansing, Mich., began developing a satellite city on 5,200 acres of waterfront. In 15 or 20 years, he hopes it will become a community of 50,000. **Corr, Maurice Connell &**

Associates of Miami and **Gupton & Kelly** of Tampa have laid out a complete land-use plan. It includes such elements of foresight as seven school sites, zoned areas for all kinds of uses and canals, parks and other features developed from the topography to create neighborhoods of 800 to 1,200 homes each.

At West Palm Beach, **Martin Cerel**, big Massachusetts builder and realtor, began a 1,000- to 1,500-home tract for Negroes on 510 acres of filled swamp. Other members of the syndicate: **Louis B. Perini**, one of the nation's biggest general contractors, and **Michael and Joseph Campanelli**, New England's largest home builders. They plan to build seven years, spreading out over 4,200 acres with white housing, commercial and recreation areas. The resulting city would be twice the size of West Palm Beach.

Having outbid three other contenders (including **William Zeckendorf**) for the property, Big Builder **William J. Levitt** gave Washington newsmen a glimpse of his plans for building a satellite town on the 2,226 acre Belair horse farm in Prince Georges County, Md. between Washington and Baltimore. He plans 4,000 homes—two per acre—priced from \$14,000 to \$25,000. It won't be called Levittown. Counting land, houses, sewers, streets, schools and other community facilities, the development may cost \$100 million. Cost of the site: \$1,750,000—\$786 per acre.

Carolina public housing boss quits over \$1 million land deal

A North Carolina public housing authority executive who claims he now owns some projects he has managed for 17 years has resigned under fire.

H. Emmett Powell, executive director of the 11-county Eastern Carolina Housing Authority quit after an investigation of the case, prompted Gov. **Luther Hodges** to announce that the state will contest Powell's claim in court.

Powell, onetime PHA staffer in Washington, had been chief executive of the housing authority since it was set up in 1941 to manage



POWELL

two Lanham Act war housing projects, one near Goldsboro, the other near Holly Ridge. In 1950 he organized Wayne Redevelopment Co., held 89% of the stock for himself, gave 5% to his assistant, **N. E. Mohn Jr.** and bought the land under both Lanham projects for \$39,000.

In 1952, PHA turned the projects over to the local housing authority under a three-year lease with the stipulation that the authority get a three-year lease on the land from Powell.

In 1955, as the lease expired, Powell announced that the entire project now belonged to his Wayne Redevelopment Co. because the housing units, under the law, went with the land. The housing authority decided he was right, voted to buy the project from his company for \$1,165,000. Powell stood to make \$1 million profit.

PHA decided it had no jurisdiction, but suggested Gov. Hodges look into legality of the deal. PHA contends the buildings are still the property of the housing authority because the US Supreme Court has ruled that ownership of housing built on land condemned for use (but not in fee) doesn't revert to the landowner when the government relinquishes its right to use the land. More-

continued on p. 92



WESTINGHOUSE
BRINGS YOU THE BIGGEST
BUILT-IN OVEN—WITH THE
SHAPE → OF TOMORROW
FOR THE HOMES YOU'RE BUILDING TODAY!

This Westinghouse Deluxe Oven has a full twenty-four inches of *interior width*. That makes it the biggest built-in oven you can get from a major manufacturer of electric appliances. The Westinghouse Deluxe is indeed the big oven that sells the kitchen that sells the home. (Rough-In Dimensions: 30 $\frac{3}{4}$ " W x 25" H x 21 $\frac{1}{2}$ " D.)

With the Deluxe Oven and Deluxe 4-Unit Platform shown at left, you'll have a wealth of convincing sales points. You can tell prospects about the Miracle-Sealed Oven, show the Drop-Down Door which serves as a loading shelf, and the controls below oven . . . out of the heat zone. Then demonstrate the exclusive Plug-Out Units on the platform; they lift out (completely) for easy cleaning.

And of course your prospects will know about the Westinghouse SHAPE OF TOMORROW, the new custom look in all Westinghouse appliances.

Westinghouse Built-In Ovens are available in a wide range of Confection Colors, plus brushed chrome and antique copper. You can choose exactly the oven you need, the color you want, and the range platform that suits your kitchens best.

You'll want to take advantage of the powerful merchandising aids that are yours for the asking from your Westinghouse Distributor. Call him right away or write to the Westinghouse Electric Corp., Contract Sales Dept., Major Appliance Division, Mansfield, Ohio.

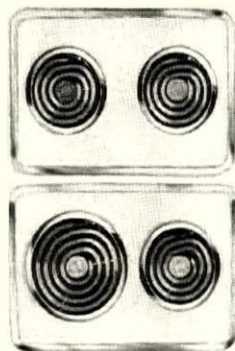

WESTINGHOUSE 2-UNIT PLATFORMS can solve space problems . . . also permit unique kitchen designs. Available with two 6", or one 6" and one 8" Corox® units. Both models have remote controls, come in Confection Colors, plus Stainless Steel. (Rough-In Dimensions for both: 13 $\frac{7}{8}$ " W x 20 $\frac{5}{8}$ " H x 7 $\frac{3}{4}$ " D.)

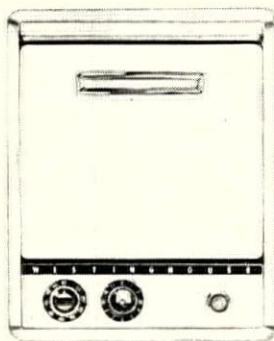

WESTINGHOUSE ECONOMY 17" OVEN is a completely automatic built-in oven designed for minimum space requirements. (Rough-In Dimensions: 21 $\frac{1}{2}$ " W x 26 $\frac{3}{8}$ " H x 23" D.) It has same Miracle-Sealed Oven, Single Dial Oven Control and color availability as deluxe model shown at left.



WESTINGHOUSE ELECTRONIC RANGE is the latest development in built-in ovens. Its Microwave cooking means food is ready in seconds and minutes instead of hours. Foods are cooked in same utensils they're served in. Here's a new way to build model home traffic. (Rough-In Dimensions: 21 $\frac{5}{8}$ " W x 25 $\frac{5}{8}$ " H x 24" D.)



YOU CAN BE SURE... IF IT'S

Westinghouse

Photographed at Rossmoor—Southern California's smartest suburb near Long Beach



If you sell only people who want the cheapest, you may sacrifice your profits

If you sell only people who want the fanciest, you may sacrifice your volume

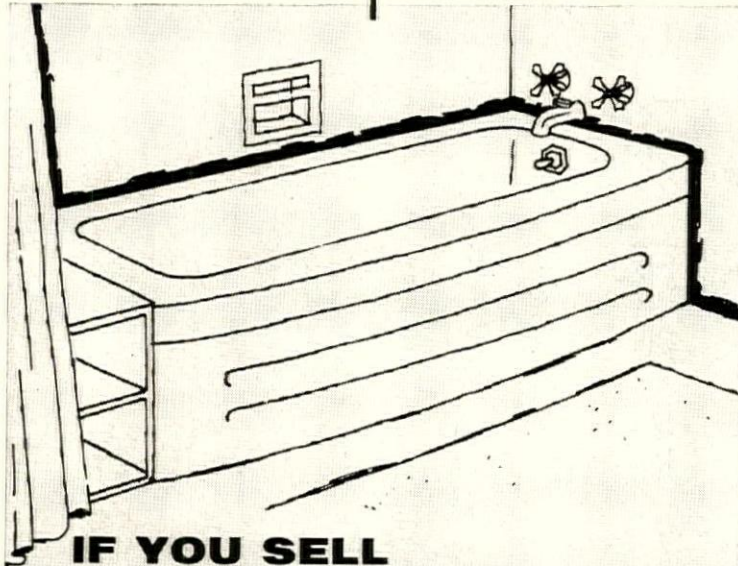

IF YOU SELL The Mighty Middle

If you sell homes in the most popular price range, you can add to their appeal—without increasing costs—with Gerber Plumbing Fixtures.

Gerber specializes in quality fixtures for medium price homes. They are "luxurious", but without unnecessary frills that raise costs; they are inexpensive, but not "cheap" fixtures on which quality is sacrificed for price.

By specializing in fixtures for The Mighty Middle—the biggest home market—Gerber is able to keep prices reasonable and at the same time offer the deluxe features usually found only in fixtures costing much more. Gerber fixtures have smart modern styling and are available in six beautiful colors and white.

Gerber makes a complete line of vitreous china, steel enamelware, and brass plumbing fixtures. Write for folder 9-B of Gerber fixtures and complete "packaged" bathrooms.

SELL

GERBER Plumbing Fixtures

Gerber Plumbing Fixtures Corp., 232 N. Clark St., Chicago 1, Ill.



Dependable service from leading jobbers, or delivery direct to your job from any of 5 modern plants:

Kokomo, Ind.; Woodbridge, N. J.; Delphi, Ind.; Gadsden, Ala.; West Delphi, Ind.
Export Division: Gerber International Corp., 500 Green St., Woodbridge, N. J.

over, argues PHA, Powell, when he bought the land, did so in trust for the housing authority.

At a state hearing, the housing authority defended its purchase as "a bargain," emphasized it knew all along that Powell owned the land. The investigating committee, however, found a "conflict of interest," and urged Powell and his assistant, Mohn, be fired. They resigned instead. The housing authority postponed the sale until the question of ownership is decided in court.

L. Walter Henslee was fined \$6,000 and sentenced to two years in jail for making false reports on rent receipts and concealing public funds while executive director of the Galveston (Tex.) Housing Authority. A federal jury convicted him in February at his second trial.

Bitterness sharpens rivalry between LA builder groups

A fight for industry leadership has erupted between Los Angeles' two rival home builder organizations.

Relations between the Building Contractors Assn. and the Home Builders Assn. had been strained for years. But they worsened in January when NAHB revoked the charter of BCA, its largest chapter (March, News).

They got worse yet when HBA officials sent letters to every BCA home builder inviting him to join HBA, noting that any dues they had paid to "the other builders' organization" could be applied to their HBA dues. Exploded BCA Executive Director Harry J. Stewart "It is a shame. Simple ethics would seem to have prohibited . . . such tactics."

HBA's unofficial reply: it merely was querying these builders as ex-NAHB members to determine their membership interest and desire to stay within NAHB.

BCA is stepping up its services for builders (financed largely by \$20,000 it no longer has to pay to NAHB). It has hired Robert S. Hunt away from the strife-torn Long Island Home Builders Institute where he was executive vice president. Hunt will head a department on councils and chapters.

HBA, which has more big tract builders, but not as many small builders as BCA, is already mapping plans to expand its services for the smaller operator. It also hired William Latta, local public relations man, whose first advice was: "Add no more fuel to the fire. . . . Affirmative policies, not feuds."

Predicts Sam Jaffe, editor of Los Angeles Building News—a local trade gazette: "We're in for some real internecine warfare as the various builder trade associations vie for supremacy in southern California . . . That long sigh you hear is from the manufacturers and suppliers, those poor unsung 'associate members' who pick up a high percentage of the tabs for trade associations. They had hoped that out of the whole mess there would be fewer, not more, trade associations which they have to support."

With Hunt's departure, the Long Island Home Builders Institute has rehired Otto J. Hartwig. He was executive vice president until 1956 when Hunt took over. Now, he has become assistant to the president. Hunt's former assistant, G. Donald Guillet, has been named executive secretary.

PLANNERS: Washington's National Capital Planning Commission demoted its executive director John Nolen Jr., 58, and named William E. Finley, 34, to the \$12,900-a-year job.

Finley, lecturer in planning at the University of Pennsylvania, is a former (1951-55)

FOR FURTHER INFORMATION
SEE OUR CATALOG IN SWEET'S
OR WRITE FOR COPY

planning director of Richmond, Calif. The switch, said the commission headed by **Harland Bartholomew**, was "in the interest of a more effective administration . . . and a much needed improvement of public relations." Nolen, a NCPC staffer since 1931, was offered an associate directorship, with a \$210 annual salary cut.

New York's Regional Plan Assn. named **Douglas S. Powell** as planning director succeeding **Henry Fagin**, upped to associate director. Powell has been associate editor of *The American City*.

INSTITUTES elected these new presidents: Urban Land Institute: Builder **David D. Bohannon** of San Mateo, Calif., a past president (1942) of NAHB, past vice president of NAREB and director of the American Planning and Civic Assn.; American Society of Heating & Air Conditioning Engineers: Prof. **Elmer R. Queen** of Penn State University; American Concrete Institute: **Douglas McHenry** of Chicago, director of development of the Portland Cement Assn.; Plumbing Fixture Mfrs. Assn.: **Stanley S. Blackner** of New Castle, Pa., vice president of Universal-Rundle Corp.; Clay Sewer Pipe Assn.: **A. G. Cochran** of Columbus, O.; Metal Ventilator Institute: **N. J. Badten** of Milwaukee.

MANUFACTURERS: **Edward P. Bailey**, 84, dean of the oil heat industry, resigned as president of National Airoil Burner Co. of Philadelphia, to be succeeded by **John F. Straitz Jr.**; **C. H. Blanchar** moved up from financial vice president and treasurer to president of Roddis Plywood, succeeding **Hamilton Roddis** who was elected to the new office of chairman; **J. A. Kelley**, executive vice president of Zonolite, was elected president following the resignation of **J. B. Myers** who continues as consultant; **Ronald N. Campbell**, former president of Bryant Mfg. Co., a division of Carrier, joined Westinghouse Electric as a vice president and was named president of its subsidiary C. A. Olsen Mfg. Co., producers of warm air heating equipment; **Lee B. Thomas** stepped up from president to board chairman (and still chief executive) of Thomas Industries Inc., Louisville manufacturer of lighting fixtures, power saws and paint sprayers, to be succeeded as president by **Frederick Keller**; **William L. Rodich**, general manager of laminated plastic and insulating products for General Electric, joined Celotex as vice president in charge of operations.

Ben F. Bohac, 65, moved up from president to chairman of Talman Federal Savings and Loan Assn., Chicago (the nation's ninth largest, with assets of \$215 million). Executive Vice President **Emil J. Seliga** succeeds him as president.

DIED: **Charles Wagner**, 68, realtor and founder of Wagner Electric Co., Feb. 16 in Detroit, of a heart attack; **Richard P. Heckmann Sr.**, 59, founder and president of Heckmann Building Products Co., Feb. 20 in Chicago; **George E. Stone**, 52, president of Associated Architects and Engineers and of Building Construction Corp., Feb. 21 in Washington, D. C., of cancer; **Harold H. Rosenberg**, 75, founder and board chairman of Industrial Publications Inc., publishers of *Practical Builder* and *Building Supply News*, Feb. 24 in Los Angeles, after a long illness; **Gilbert E. Webster**, 57, president of National Lock Washer Co., Mar. 3 in Orange, N. J.; **Thomas W. McNeill**, 57, procurement director for American Radiator and Standard Sanitary Corp., Mar. 4 in Stamford, Conn.

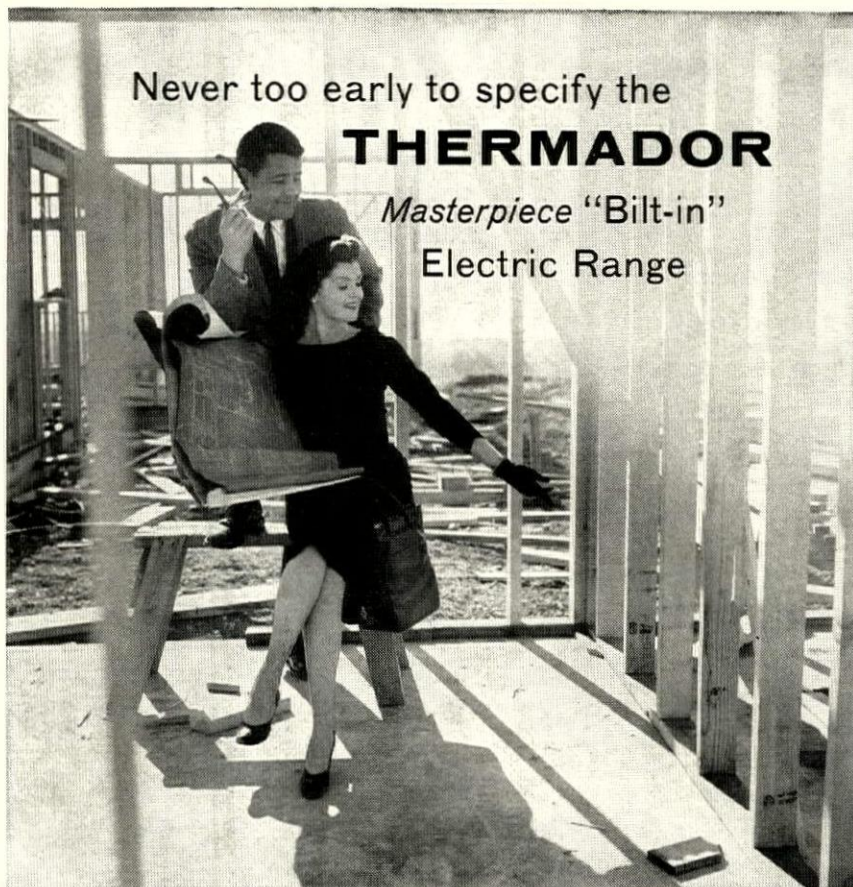

Never too early to specify the
THERMADOR
Masterpiece "Bilt-in"
Electric Range

More architects and builders each year are specifying Thermador "Bilt-ins" in the kitchens of their finer homes. They've learned that discriminating buyers who look to their new homes as lifetime investments want the finest electric ranges and refrigerator-freezers at so little extra cost.

The best time to talk Thermador to your client is right now, at the blueprint stage. Point out the advantages of Thermador "Bilt-in" cooking tops and ovens...the matchless quality, the Lifetime stainless steel (or decorator color) finish, the ease and low cost of installation during construction, and the Thermador "Bilt-in" reliability that pays for itself in minimum service and repair.

Do yourself a favor. Specify when you can, install when you make the choice...Thermador "Bilt-in" electric cooking tops and ovens and refrigerator-freezers...the "Bilt-ins" that make the builder look better.

Originator of the "Bilt-in" Electric Range



Air-cooled oven door has over-sized, easy-grip handle to avoid finger burns. Fully automatic. Three-spit rotisserie.

Most happy couple loves their handsome Thermador "Masterpiece" Electric Range and their builder for recommending it.

Please send illustrated literature on

"Bilt-in" Ranges "Bilt-in" Refrigerator-Freezers

___ARCHITECT ___BUILDER ___ELECTRICAL CONTRACTOR ___WHOLESALE ___DEALER

NAME _____

ADDRESS _____

CITY _____ COUNTY _____ STATE _____



THERMADOR ELECTRICAL MANUFACTURING CO.

A Division of Norris-Thermador Corporation

5119 DISTRICT BOULEVARD, DEPT. 57 • LOS ANGELES 22, CALIFORNIA

Key Builders salute AMERICAN HOUSES'

Silver Jubilee

Representative builders of 20-100-200 or more houses a year express their satisfaction with American Houses' services. Builders who know what tough competition means, and who also know quality and real service when they see it, are unanimous in their regard for American Houses and their way of doing business.



William A. James

William A. James
Builder-Realtor
Myrtle Beach, S. C.
writes as follows:

"In checking my files it is noted that I purchased my first American House in May of 1951.

"After reviewing these past six and one-half years, I would like to take this opportunity to express my appreciation to American Houses, Inc., for their splendid cooperation in all our business transactions.

"When I decided to explore the possibility of going into the market of prefab and pre-cut houses, meetings were held with several manufacturers and I am most happy that I selected your company.

"I have found your program to be most flexible, the quality of your workmanship and materials is excellent and your promptness of service is very satisfactory.

"As a builder of fifty houses per year, I feel that my problems are fewer and my profit greater with American Houses."



Ralph D. Rocks

And here's the word from
Ralph D. Rocks
President of Allen & Rocks, Inc.
Washington, D. C.

"I wish to congratulate American Houses, Inc. on its Silver Anniversary of being a major prefabricator of houses.

"We have dealt with your firm for about eight of these twenty-five years. We not only found your product the best in its field, but found your firm a real pleasure to do business with.

"We certainly want to thank you for all your past cooperation and hope you have many more years of great success."

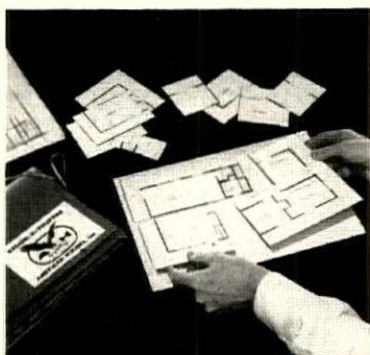

Characteristic of the many firsts hung up by American Houses in the prefabrication field, the American Houses' Silver Jubilee was preceded by the greatest advance of all—announcement of the "Design-It-Yourself"*

System. With this system selection and arrangement of all house elements is simple. The "Design-It-Yourself" Kit (shown here) shows how easily room elements can be planned.

*American Houses, Inc., Trademark



American Houses, Inc.

America's Greatest Home Value

S. Aubrey & E. South Streets, Allentown, Pa.

Plants: Allentown, Pa., Lumberton, N. C., Cookeville, Tenn.

—ATTACH THIS COUPON TO YOUR LETTERHEAD—

AMERICAN HOUSES, INC.

DEPT. HH-458

South Aubrey & East South Sts., Allentown, Pa.

I am planning to erect _____ houses this year and want to know how I can become an American Houses Key Builder. Please send me booklet and complete details on Design-It-Yourself.



Name _____

Company _____

Street _____

City _____ Zone _____ State _____

contemporary use of texture...

HANDSPLIT RED CEDAR SHAKES



The hand-hewn character of a cedar shake roof accents modern architecture with a roofline of dramatic texture, incomparable beauty and unmistakable quality. Because handsplit cedar will outlast the very sheathing it is nailed to... cedar shakes assure the homeowner a valued combination of enduring good taste *plus* generations of carefree service. *Above all, make certain it's cedar!*



CERTIGRADE
Smooth
5/8" x 12" x 1/2"
All Cedar
THE CEDAR SHINGLE BUREAU



CERTIGROOVE
Cedar Shakes
5/8" x 12" x 1/2"
All Cedar
THE CEDAR SHINGLE BUREAU



CERTI-SPLIT
Split Cedar Shakes
5/8" x 12" x 1/2"
All Cedar
THE CEDAR SHINGLE BUREAU

RED CEDAR SHINGLE BUREAU

5510 White Building, Seattle 1, Wash.

550 Burrard Street, Vancouver 1, B.C.

Roundup of ideas

A belated reaction to the September "Roundup of Ideas" issue of H&H. The historical material, the color photographs, the opinions from the profession all over the country were all very worth reading and having.

There is, of course, the usual depressing fact. The overwhelming majority of the builders' houses appear to me to be as bad, generally, as they were ten years ago with the minority being better and another minority, being "Cinderella," infinitely worse.

Let's all hope that more issues like the September issue can help promote good design.

JOHN CARDEN CAMPBELL
Campbell & Wong
San Francisco

What to do about sewage

Your excellent article, "What You Need To Know About Sewage" is an outstanding presentation to the public of a technical problem.

Obviously costs and details will vary widely from one locale to another, but your rule of thumb cost guide should provide a good basis for preliminary planning.

We would only add that when a builder or developer decides to proceed with plans for sewerage, he will be money ahead if he avails himself of the services of a professional engineer, thoroughly experienced in the field of sanitary engineering. A professional engineer can put together the various components of a treatment plant on a competitive performance and price basis to save you thousands of dollars initially and in operating and maintenance costs.

ARTHUR W. SAARINEN, JR.
Philpott, Ross and Saarinen
Consulting Engineers
Ft. Lauderdale, Fla.

Our commendation on the material in the article and its presentation. An excellent job. We would have no suggestions for changes.

RALPH E. FUHRMAN, executive secretary
Federation of Sewage & Industrial
Wastes Associations
Washington, D. C.

... interesting and all-inclusive.

A great many developers are using stabilization ponds or lagoons, particularly where land values are not exorbitant. Several small communities in Mississippi are using this method with very good results. Many others are in the design stage or under construction.

BAXTER F. WADE
Baxter F. Wade Engineers
Jackson, Miss.

For the small town broker

Yours is the best darn magazine yet for a small town broker who wants to keep informed.

MEL CRADER, realtor
Chowchilla, Calif.

Information source

We find more pertinent and current information pertaining to the home building business in HOUSE & HOME than in any other single source.

WILLIAM H. PERSONS
Burch Construction Co.
Coraopolis, Pa.

HOME BUILDERS' SEWAGE PUMPING GUIDE

5 pumping problems...and the engineers' solutions

1 PROBLEM: A builder who was erecting 50 homes found that he could pump sewage to the municipal sewerage lines... but that his pumping station probably would be abandoned in less than 5 years when the municipality built a larger station to serve his and anticipated adjacent developments.

SOLUTION: His consulting engineer drew up plans for a pumping station, employing a vertical enclosed shaft pump installed in a dry pit. Yeomans supplied the equipment in package form... ready for installation in the concrete pit. When the station is abandoned, the pump can be removed and reinstalled elsewhere.

Complete pumping station cost **\$125⁰⁰** per home.

2 PROBLEM: A land developer who was planning for 75 homes was told that he must put in a sewage pumping station to meet the codes of the adjoining village. Location of the station required that it take a minimum of space, be odor-free and clog-proof, and easy to install and maintain.

SOLUTION: The engineers designed a low-cost pumping station equipped with a Yeomans Pneumatic Ejector... the "package" Expelsor®. This is a complete, factory-assembled and wired, self-contained unit, with built-in controls and ready-mounted air compressor. It's ready to set in place, connect, and put into operation.

The complete station cost **\$120⁰⁰** per home.

3 PROBLEM: A builder of 150 homes in a nonsewered area had no room for a sewage pumping station above ground. Moreover, because of ground conditions, an underground station with concrete walls was not practical. A second consideration was the cost of equipping and installing the station.

SOLUTION: His consulting engineer recommended the Yeomans all-steel, factory-assembled, underground station. Inside the watertight steel tank are two vertical centrifugal pumps, the pipes, the valves and controls, a dehumidifier, etc.—the completely equipped station. The contractor had only to lower and anchor it in the ground and make the connections.

Cost of complete station **\$105⁰⁰** per home.

4 PROBLEM: A planned community of 1000 executive and professional men's houses was to have independent facilities except for water and sewerage... civic center, fire and police protection, parks, etc. A permanent sewage pumping station was to be installed under the street approaching the shopping center. The location made it imperative that there be neither sanitary nuisances nor periodic maintenance.

SOLUTION: The engineers put a Shone® with mechanical controls in the concrete pit under the street... but installed the air compressor powering the ejector in the nearby firehouse. To date, the ejector has required *no* maintenance. The electrically operated air compressor is easily accessible for lubrication and routine inspection above ground... and gets preventive maintenance because of its location.

Cost of complete station **\$30⁰⁰** per home.

5 PROBLEM: A subdivider was putting up 1500 new homes. Sewer lines for the entire development led to a central collecting well, and sewage was to be pumped from here into the metropolitan sanitary district system. The sewage lift station was disguised as a limestone gatehouse at the entrance to the golf course.

SOLUTION: The consulting engineer considered using Yeomans Vertical Dry Pit Pumps, but because there was ample space, recommended horizontal pumps for easier service. Both types of pumps have the large capacity required... and the desired sustained efficiency.

Cost of complete station **\$24⁰⁰** per home.

Yeomans has specialized in the design and manufacture of sewage pumps for 60 years. These cases have been selected from a wide range of pumping problems solved by Yeomans pumps. Yeomans welcomes the opportunity to work with your engineer in selecting the equipment which will give the greatest over-all economy in your case.



YEOMANS
SINCE 1898

A complete line of centrifugal and pneumatic sewage pumps. Sewage treatment systems for 1 home or 10,000!

Please send information on a sewage pumping station for _____ (number) homes to my engineer, who is

name _____

firm _____

address _____

city _____ zone _____ state _____

YEOMANS
2003-8 N. Ruby St., Melrose Park, Illinois

name _____

company _____

street _____

city _____ zone _____ state _____

Re: latex paint

In your article, "The Right Paint for the Right Job" (H&H, Aug. '57), the statement is made that "styrene-butadiene is not a good choice for exteriors because it lacks sufficient strength and chalk resistance."

This implies that the *type* of latex is more important than any of the many other raw materials used in formulating latex paint. It also disregards the technical know-how and the quality of production control of the manufacturer.

There are a number of responsible paint companies who use styrene-butadiene latex in their exterior masonry paint. Their competence and judgment must be relied upon. The suitability of the paint is too complex a question to be decided on the basis of one raw material.

DONALD L. GIBB, sales manager
Plastics department
Dow Chemical Co.

Reader Gibb is right in saying that the type of latex is only one factor in determining the characteristics of paint. HOUSE & HOME's statement was an over simplification. Dow developed and holds basic patents for latex paints and is the major supplier of latexes to the paint industry. Formulations, test methods, and specifications for latex paints are based largely, and in many cases entirely, on the development work of the Dow laboratories.—ED.

High cost of obsolescence

Reading your latest issue, I have gotten discouraged about my 50-year-old house and have decided to knock about \$30,000 off the asking price. It seems to be obsolete all the way from the iron dog on the front lawn to the back steps.

BILL WYANT
St. Louis

Wall-hung toilet

HOUSE & HOME has done a terrific job for the home building industry. Many of the seemingly radical suggestions you made only a short year and a half ago are becoming commonplace. We certainly hope you will keep instigating new concepts.

In your article on new wall-hung toilets (H&H, Feb.) you say "houses with more than one bath still can't have completely above-the-floor plumbing." Such installations have been made using our wall-hung closet. It isn't always possible to run lines outside the slab (i.e. interior bathrooms); however, we are working on an idea where this won't be necessary and the builder can still have one-stop plumbing.

You also refer to a new development incorporating the waste connection as an integral and structural part of the carrier. Our carrier has always had the waste line as an integral and structural part.

W. D. GERSTACKER, sales manager
Ingersoll-Humphryes
Mansfield, Ohio

As H&H point out, the chief obstacle to multi-bath use of wall-hung units is the common code requirement of 4" cast-iron waste lines. Two or more Ingersoll-Humphryes units have been used where 3 1/8" OD copper tubing satisfies the code.

Further it was not H&H's intention to imply that the new Wade Mfg. Co. carrier was unique. The Ingersoll-Humphryes integral carrier-connection, the first in the field, was shown in our original story on the wall-hung toilet in March '57.—ED



2 good reasons for insisting on PHILIPPINE MAHOGANY



1. Ilco Philippine Mahogany is graded after drying to assure full count and finest quality. And since the drying process is scientifically conducted in the company's own kilns, Ilco lumber has increased fiber strength and substantially improved hardness, as well as bending and compressive strengths. Ilco Philippine Mahogany is known throughout the world for its superior workability and uniformity of texture and color.

2. Ilco Philippine Mahogany offers the widest selection of milled products. By stocking the complete Ilco line, you are certain to satisfy the wants of all your customers, for Ilco, the oldest and largest Philippine lumber exporter, has the widest selection of milled products, including three types of paneling and an extensive variety of moldings. What's more, Ilco never fails to meet NHLA standards.

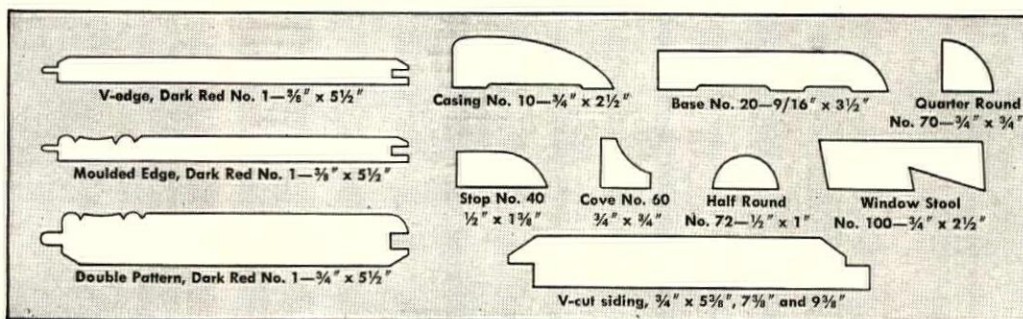

Write today for free booklets!



MOLDINGS
Illustrated booklet showing complete selection of Ilco moldings.

PANELING and SIDING
Illustrated booklet on entire selection of Ilco paneling, siding and other mill products, such as flooring.

EXTERIOR FINISHING
Illustrated booklet on how to insure the lasting beauty of natural Ilco siding.

INSULAR LUMBER SALES CORPORATION
1401 LOCUST STREET, PHILADELPHIA 2, PA.

Please send me the name of my nearest Ilco Philippine Mahogany distributor, together with the following free booklets:

Moldings Paneling and Siding Exterior Finishing

Name

Company

Address

INSULAR LUMBER SALES CORPORATION
1401 Locust Street, Philadelphia 2, Pa.

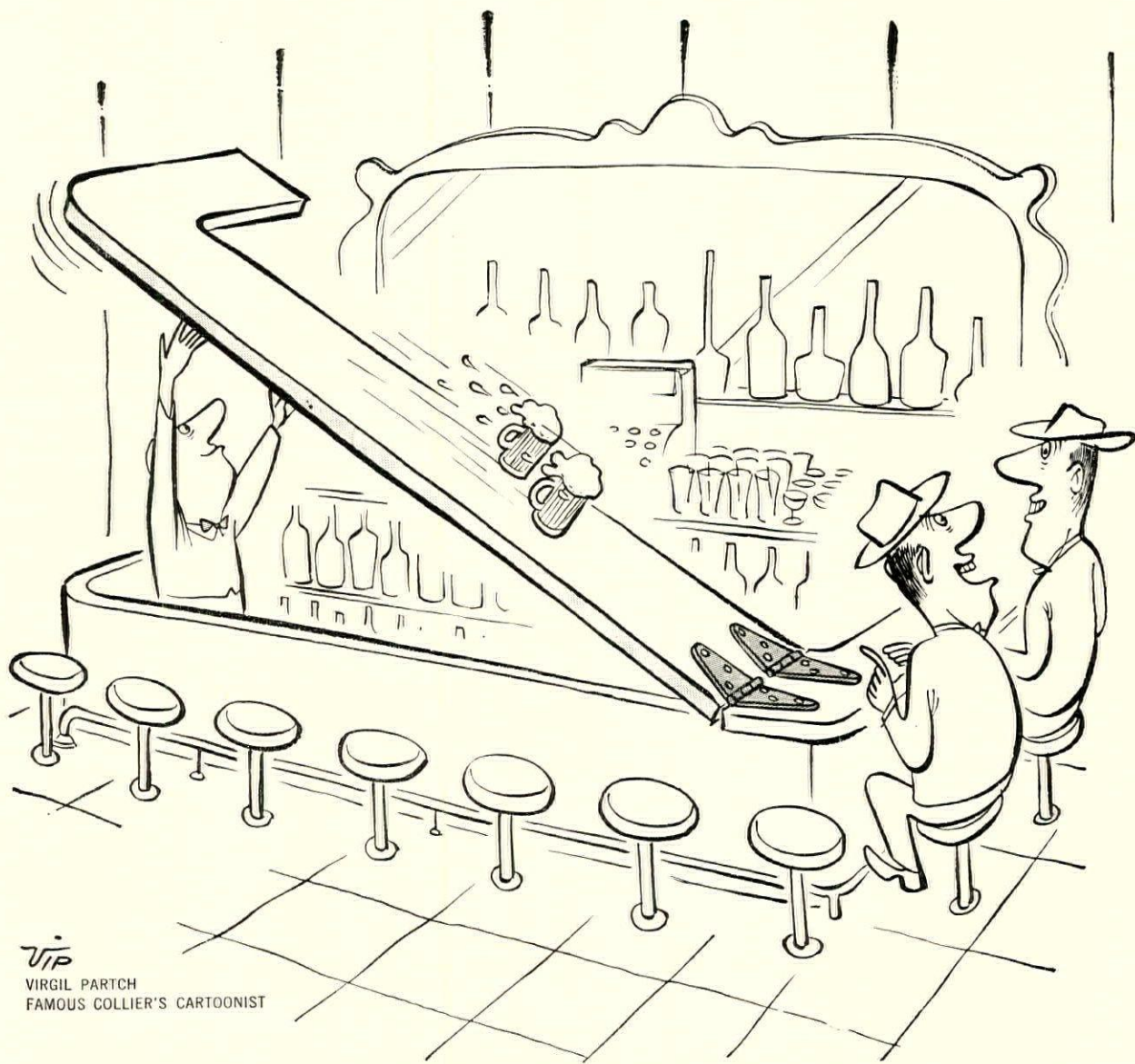

VIP
 VIRGIL PARTCH
 FAMOUS COLLIER'S CARTOONIST

*"He's looking for a way to send Back
 the empty glasses now that*

EVERYTHING HINGES ON HAGER!*

C. Hager & Sons Hinge Mfg. Co. • St. Louis, Mo.
 Founded 1849—Every Hager Hinge Swings on 100 Years of Experience



STANDARDIZE

ON



THE HIGHLANDER • 1034-A Elevation 3



THE DEVONSHIRE • 1033 Elevation 3

STYLECRAFT

*homes designed
with the BUILDER
in mind*

FOR 1958



THE KENILWORTH • 1034-B Elevation 1



THE IVANHOE • 1034-C Elevation 2



THE PATRICIAN • 1034-D Elevation 3

Beautiful Homes You Can Erect with Less On-Site Labor Cost

The Business That Builds the Homes: A mature organization, experienced in *every* phase of the building industry . . . equipped to precision-manufacture finest components . . . eager to counsel you on land planning, financing, erection principles, merchandising and advertising.

The Homes That Build the Business: Dynamic new houses, each research-tested for easier, more profitable erection . . . each bright with fresh new ideas to win sales over competition . . . each attesting to this fact: You'll do better to build *exclusively* with Stylecraft.

Each of these Stylecraft Homes provides 3 bedrooms, full bath and powder room. Each is available in crawl or basement models. Bedrooms all twin-bed size; oversize closets have mahogany folding doors. Choice of one and two-car garages, with or without large terraces under roof.

Write, wire, or phone in complete confidence for our free Stylecraft Homes information kit.

SH-458

Stylecraft

HOMES, INC. • 1032 Lee Street • Des Plaines 2, Illinois • VAnDerbilt 4-6142

Textolite Ideas



Foyer in new Travara Marble pattern. Travara is available in standard or postforming grades.

TEXTOLITE'S STUNNING NEW "BLOCK OF MARBLE" EFFECT

costs no more than wood—gives you many more selling features

Available in 5 rich color schemes, General Electric Textolite marble-pattern surfacing curves to follow contours of any wall . . .

looks more luxurious, cleans easier, and lasts years longer than wood

It's a luxury touch that helps close sales — at surprisingly low cost! Marble-pattern Textolite surfacing on walls looks like natural marble . . . costs no more than fine wood paneling — yet outlives it by years!

Unlike wood, General Electric Textolite surfacing does not need periodic refinishing. It resists scratches, scuffs, and stains—cleans to a sparkle with a damp cloth. And it's fast and inexpensive to install.

You can choose from 70 market-tested colors

and patterns in General Electric Textolite wall and counter surfacing. See them all in Sweet's Light Construction File, Catalog 7e/Ge.

For specific recommendations on where Textolite can be of most value in *your* homes, check with the Textolite dealer nearest you. He's listed in the Yellow Pages under "Plastics." Or send description of your surfacing problem to Laminated Products Dept., Section HH-84, General Electric Co., Coshocton, Ohio. You'll get prompt help from thoroughly qualified surfacing experts.

Textolite[®]
LAMINATED SURFACING
GENERAL  ELECTRIC

APRIL 1958

House & Home

Published by TIME Incorporated

EDITOR-IN-CHIEF Henry R. Luce
PRESIDENT Roy E. Larsen

EDITOR & PUBLISHER
P. I. Prentice

MANAGING EDITOR
Robert W. Chastaney Jr.

EXECUTIVE EDITOR
Carl Norcross

ASSISTANT MANAGING EDITORS
John Goldsmith
Walter F. Wagner Jr.

NEWS EDITOR Gurney Breckenfeld

ART DIRECTOR Jan V. White

ASSOCIATES

Edward Birkner
James P. Gallagher, Patrick Hailstone
David R. Kerr
Kathryn Morgan-Ryan
Robert W. Murray Jr., Richard W. O'Neill
Arthur David Piper, John Senning
Richard Saunders (Washington)
Clifford S. Smith, Paula Treder, AIA

ASSISTANTS

Natalie Forsberg
Olive F. Taylor, Ruth M. Hoagland
Peggy Lampl, Jenepher Walker

CONSULTANTS

Miles L. Colean, FAIA, Thomas P. Coogan
Ruth Goodhue, James T. Lendrum, AIA
David C. Slipher

PRODUCTION MANAGER
Lawrence W. Mester

CIRCULATION MANAGER
William L. Taylor

BUSINESS MANAGER
Archibald Peabody Jr.

DIRECTOR OF MARKETING
Arthur S. Goldman

ADVERTISING DIRECTOR
Richard N. Jones

STORY OF THE MONTH

103 *Why you should look into rental housing*

DESIGN

108 *How garden apartments have changed since the days of 608*

136 *Frank Lloyd Wright talks about prefabrication*

NEW HOUSES

123 *"When you find a good plan, stick with it"*

MERCHANDISING

138 *How to decide when to start back up*

LAND DEVELOPMENT

146 *Are you overlooking profit in marshland?*

TECHNOLOGY

128 *What you can do to control noise in your houses*

144 *FHA is clarifying its construction bible*

FINANCE

104 *How to cut taxes on your rental housing*

NEW WAYS TO BUILD BETTER

168 *Solar heating works in New England, too*

172 *What the leaders are doing*

181 *New products*

218 *Publications*

153 *Index*

HOUSE & HOME is published monthly by TIME INC., Time & Life Building, 9 Rockefeller Plaza, New York 20, N. Y. Yearly subscription payable in advance. To individual or firms (and their employes) engaged in building—design, construction, finance, realty; material distribution, production or manufacture; government agencies and supervisory employes; teachers and students of architecture and trade associations connected with the building industry; advertisers and publishers: U.S.A., Possessions, Canada, \$6.00; elsewhere, \$9.50. Single copies, if available, \$1. All copies mailed flat. Please address all subscription correspondence to HOUSE & HOME, 9 Rockefeller Plaza, New York 20, N. Y. When ordering change of address, please name the magazine and furnish an address label from a recent wrapper, or state exactly how the magazine is addressed. Both the old and the new address are required. Allow four weeks for the change. © 1958 by TIME INC. All rights reserved.

TIME INC. also publishes TIME, LIFE, FORTUNE, SPORTS ILLUSTRATED and ARCHITECTURAL FORUM. Chairman, Maurice T. Moore; President, Roy E. Larsen; Executive Vice-President for Publishing, Howard Black; Executive Vice-President and Treasurer, Charles L. Stillman; Vice-President and Secretary, D. W. Brumbaugh; Vice-Presidents: Edgar R. Baker, Bernard Barnes, Clay Buckhout, Arnold Carlson, Allen Grover, Andrew Heiskell, C. D. Jackson, J. Edward King, James A. Linen, Ralph D. Paine Jr., P. I. Prentice, Weston C. Pullen Jr.; Comptroller and Assistant Secretary, John F. Harvey.

Volume XIII, No. 4



APRIL 1958

NEWS

- 41 *A new market in housing for the aged*
52 *Congress pushes antirecession housing bills*
85 *Suburbanization sneaks up on a rural Pennsylvania township*
37 *Index to these and other News reports*

DEPARTMENTS

- 96 *Letters to the editor*
226 *Advertising index*



COVER:
Garden apartments — design and rendering by Architect Robert A. Little, Cleveland.

123
EAST
MICHELLE TORENA

APARTMENTS for LEASE

Phone 2-7635 55

JOHN L. WARREN & ASSOC
1810 STATE ST.

Why you should look into Rental housing

Financing is easier, the market is growing and depreciation rules promise tax-sheltered profits

Rental housing is well embarked on what seems to be a major revival. Its causes are complex.

To start with, in some cities and not a few older suburbs, soaring land prices (or often the nonresidential character of available locations) make many sites more suitable for multi-family than for single-family housing. Second, demand for close-in housing is increasing in several major cities. There is a limit to how far commuters will travel to enjoy the blessings of home ownership. And the railroads' financial mess means fares will continue up—and patronage down. Meanwhile, growing traffic jams on the freeways make commuting by auto not only expensive but fretful. For the long run, demand is on the rise from the fastest growing segments of the adult population: young couples without children and elderly people. It adds up to a rental market home builders can't afford to ignore.

Rental housing's comeback began early last year. Before that, except for the brief flurry of 608s, rentals had been in the doldrums for a generation—victim successively of the depression, war, rent control and then the FHA windfall scandals. In 1927, rental housing accounted for 44% of starts. By 1956, it had sunk to a thin 10% (including two-family units). Last year, it revived to a more respectable 15%. But take a close look at the makeup of that 15%. Private two-family units were up 5.8% to 32,700. But multi-family starts went up 43.4% to 118,000! This year, assuming continuing easing of the mortgage market (which is bringing FHA 207 rental projects off the tight-money shelf), HOUSE & HOME believes rental housing will do about 10% better: 165,000 units (see graphs, p. 105).

Now that the revival of rental housing is a well established trend, is it too late for more builders to cash in on it? In a few cities, possibly. For example, Milwaukee Builder Ken Kamrath says: "The rental market here is kaput." But in most cities, no. For example, in the traffic-choked sprawl of suburbanites called Los Angeles, apartment starts last year outstripped single-family house starts for the first time. This shift is continuing. Dallas is

continued at top of next page

Entrance of two-story apartment in Santa Barbara, Calif. Architects: Howell & Arendt, Neal Butler. Builder: W. S. Hamilton

Why you should look into

Rental housing



having a boom in garden apartments. So, surprisingly, is San Diego, a metropolitan area too small to seem a likely place for such activity. Even in Chicago, there are still a few spots where land is cheap enough to build FHA 207 walkup garden apartments renting for about \$35 a room.

"The only people who can build rentals of this kind now are builders with their own organizations," says Mortgage Banker Maurice Pollak. "The builder can make a profit out of the building. For us to syndicate a deal is very difficult by the time we have paid an architect and the other management expenses. If I were a builder, every little while I would get hold of a piece of land and build an apartment. I should be able to clear 10%."

What is the market?

"The suburban market," says Mitchell Siegel, counsel to the Long Island builders' apartment committee, "consists mainly of two groups: young families—the newly married who grew up in the suburbs and want to stay there—and elderly couples who no longer want the house-keeping involved in a big house. Unattached individuals are usually part of the big-city market."

So what should builders put up in the suburbs? Answers Builder George Rabinor of Long Island: "About half the units in a project should have one bedroom. A quarter should be no-bedroom efficiencies with a sleeping nook off the living room doubling as dining space. The remain-

ing quarter should be two-bedroom, two-bath units." Now that single-family homes have used up much of the best land, Siegel adds, "the whole area within 25 miles of New York City is ripe for apartment development." The lesson is applicable anywhere.

But the market is not bottomless. In Los Angeles, it takes builders longer to rent apartments than it did six months ago. People are growing fussier, just as they did about development houses two years ago (when the great glut developed in adjacent Orange County). But the vacancy rate, based on meter readings, is still only 2.4% in Los Angeles, and 3.1% in Orange County. On the other hand, realtors say there's a "hot market" for spacious luxury apartments in Louisville. In the Chicago suburbs, apartment building is booming.

Who will finance rentals?

If the project is small enough, one good place to look is the nearest savings & loan. S&Ls are financing thousands of duplex, triplex, four-unit and bigger dwellings, but usually their assets are too small to let them take on a really giant deal. Federal S&Ls can put only 20% of their assets into loans over \$35,000. Or state law may impose limits. Wisconsin-chartered S&Ls may lend up to \$50,000 at 80% of appraisal, but only 60% above that. This forces much rental building into a four-unit mold.

Insurance companies, in almost every state, and mutual savings banks, in the 17 states where they do business, are the big sources of big conventional loans on apartments—and conventionals make up the lion's share of all apartment financing.

"We generally hold our loans to \$300,000," says Vice President John P. Traynor of Mutual of New York, which does a big volume of garden-apartment financing. "But we're now considering a couple of over \$1 million." Like most insurance companies, Mutual can lend only up to 66% of its estimated project value (New Jersey-based life firms are empowered by state law to go up to 75%, but seldom do). Mutual will go for terms up to 20 years,

how to save

Key to rental profits:

TAXES

Tax savings can furnish all the equity you need to build and own some rental properties.

So say two of the nation's foremost authorities on realty tax law, Lawyers Sylvanus G. Felix (above, left) and John J. Griffin (below, left) of Oklahoma City. They add:

"The tax advantage to the buyer is a prime motivator. The money-making possibilities to the builder are unlimited. It doesn't matter whether the new property is garden apartments, hundreds of duplexes, a multi-storied cooperative, a service station, commercial or industrial building. In most cases, the total cash return occasioned by rentals will permit a faster recovery of equity capital than most other types of investment."

Here, in interview form, is their advice on why and how tax incentives make rental property a profit opportunity for builders:

Q What are the tax incentives to the builder of rental units?

A There are three main ways to cut taxes:

1. If you lease ground instead of buying it, the

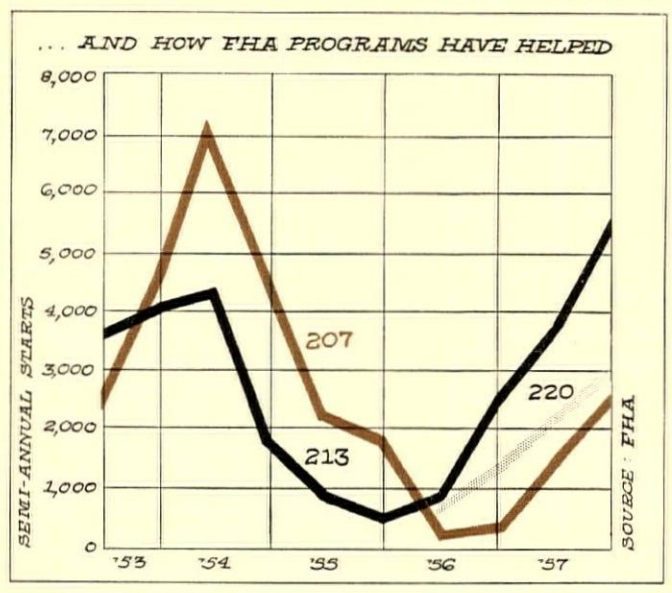
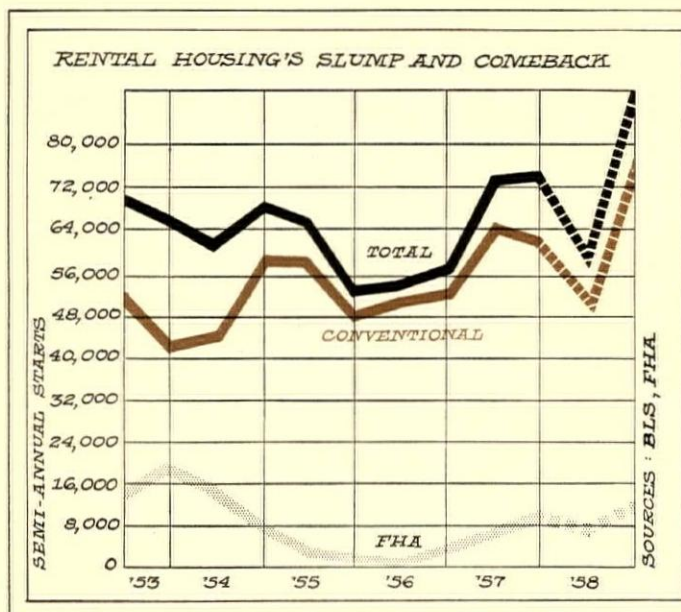

HIGHEST LEVEL since 1950 is in prospect for rental housing this year. Total rental starts (including two-family units) spurted from 113,200 in 1956 to 150,700 last year. Despite an anticipated drop during the first six months of 1958, this year should see 160,000 to 165,000 rental units begun. FHA will probably account for only 25,000 of them.

MOST VOLATILE segment of rental housing is FHA. Starts trailed after 1954 windfall scandals but are on the rise again. FHA's main rental program, Sec. 207, lags behind Sec. 220 and Sec. 213 co-ops which cater to the same market as rental units but offer preferential FNMA financing plus tax deductions for occupants.

but most loans are for 15. Interest rates have been hovering between $5\frac{3}{4}$ and 6%, but they are on the way down (one big New York savings banker calls $5\frac{1}{2}$ % "typical" now and adds that some loans "shade to $5\frac{1}{4}$ %"). Mutual's loans usually work out to about \$1,200 to \$1,700 per room, says Traynor. It prefers a majority of units with two bedrooms, but occasionally finances a project of efficiencies.

What makes lenders turn down proposed apartment loans? No. 1 reason, says Vice President Harry Held of Bowery Savings Bank (the nation's largest), is room layout—"a lot of little things" stemming from the developer's effort to squeeze in as many rooms as he can per square foot. Lenders, notes Held, reason that if apartments become

a glut again as they did during the depression, the ones with dinky rooms will produce big vacancies first. (Some lenders contend such lender-pressure for more space-per-unit makes conventionally financed apartments produce more living space per rent dollar than FHAs.)

No. 2 reason for turndowns is that the developer wants too big a loan. Lenders know apartment builders want all the loan they can get. Thanks to the tax laws (see below), the bigger the loan on a rental property, the bigger the profit should be on the builder's invested equity. "If we get a \$55,000 mortgage, we can build for \$60,000," quips Builder-Broker James L. Callan of Milwaukee.

The trick of building a conventionally financed apartment on a thin equity despite 66% to 80% loan maximums

continued at top of next page

- ground rent becomes a deductible expense on your tax.
- The 1954 Internal Revenue Code allows much faster depreciation on buildings and other improvements.
 - If you sell the property, your profit is taxed only at the 25% capital gains rate instead of at ordinary income rates that run up to 91%.

Q Which of the three ways is the most important for keeping the profits in rental property?

A Probably the stepped-up depreciation. On new property, it will normally cause the property to show a tax-reporting loss while actually throwing off a cash return. This offers a loss to offset against the builder's other income. If his other income is in the top tax brackets, the cash savings will be sizable. In fact, the money saved may be enough to provide equity capital for another project! One southwest builder, netting about \$100,000 a year from his other activity, has a \$27,000 tax loss from one project to offset against his total income.

Q How does the deduction for the expense of leased land help?

A That's an area of tax savings too often overlooked by builders. The cost of land may be the item that makes or breaks a rental project. If a builder buys land, he must do so with equity capital. And this asset becomes frozen. You cannot depreciate or amortize land for tax purposes. But rent paid on a ground leasehold is a deductible expense.

Q Will lenders put up mortgage money for projects on leased land?

A Yes, if the term is long enough and if where necessary, the ground owner subordinates his fee title as extra security for the lender. Even where the title is not subordinated, some insurance companies and other lenders will make sizable loans on leaseholds of 50 years or more.

Q Is it good business, then, to build apartments on a long-term leasehold?

A Generally yes. In effect, the value of the land becomes extra equity capital "borrowed" by the builder from the landowner.

continued on lower half of next page

is no secret to lenders. "You build up a convincing income story," explains one expert. "Then you capitalize the income on that basis, which gives you a high loan in relation to the actual cash outlay required to build. Then you take advantage of alternative tax depreciation methods to get your money out quickly (5 to 10 years) tax free. Then you sell the project." Two elements often creep into such proceedings: jiggered vacancy allowances (all the way down to zero) and questionable operating-cost figures.

Says a Brooklyn savings banker: "Usually, about 10% of the total is the builder's initial money. Another 10 to 12% is his profit. The next 20% is a second mortgage, perhaps at 6%. The rest—60%—is the bank's."

Conventional apartments run heavily to the luxury brackets. The arithmetic of financing compels it. Apartments are too risky for investors to settle for 3% or 4% on their investment. With a 90% mortgage on a \$20,000 unit, the builder can get his 15% return and amortize the loan (at 4%) for a rental income of \$1,020 a year. With a 75% mortgage, this income must rise to \$1,350.

FHA 207: thin equity, but profit control

For the first time since the windfall scandals flattened FHA rental housing, FHA's Sec. 207 seems likely to do a sizable business this year. Signs of the spurt:

On the 58-acre site of a razed public housing project in San Diego, Developers Sam Berger and George M. Holstein & Sons have just started what they say will be the nation's biggest 207—1,062 units of two-story garden apartments designed by Architects Palmer & Krisel. Estimated cost: \$13 million. San Diego's FHA is swamped by some 2,000 rental unit applications.

Long Island builders fired off a complaint to HHFA, FHA, the Budget Bureau and Congress that the New York FHA office was running into a processing jam. Instead of the normal four to six months, they cried, "numerous" builders report it is taking "nine months to a year or longer" to get a 207 application through FHA's sifting.

One reason for the surge in 207s is the easing mortgage market. Last year, with their interest rate frozen by Congress at 4½%, 207s were going begging despite FHA's relatively reasonable attitude on discount ceilings (8 points in Chicago, 6 points in New York, for example).

Now, mortgage financing is no longer a problem (and 207 discounts ceilings are down to 5 points in southern California and 3½ in New York). Many a stymied project is going ahead again.

What really entices builders is that 207's, thanks to amendments in the 1957 Housing Act, can now be built on a 3% cash equity—if you don't count the 7% builder's profit and overhead FHA is supposed to allow. Liberal financing is the only way in sight to build for the medium-income market. Commissioner Norman Mason has said FHA will let builders take the 3% equity out of a project in three years, instead of forcing them to leave it locked up in the project for the life of the FHA mortgage. This concession was adopted last year to spur Sec. 220, but it applies to all FHA rental projects.

Ever since authorities screwed the lid down tight on FHA rentals after the windfall scandals, the story of Sec. 207 has been one of gradual relaxation—a notch here and a gimmick there. Few builders realize how much things have changed, even though 207 (like all FHA rental housing) is still subject to cost certification and rent control.

In 1956, Congress raised the mortgage limit from 80 to 90% of appraised value. It recognized items of overhead as elements of a sponsor-builder's cost. It eliminated a possibility of future controversy by making FHA cost certification incontestable—a ruling that would have precluded the Sec. 608 windfall scandals.

At the same time, builders prevailed on Congress to boost the mortgage limits for 207 to:

- \$2,700 per room for elevator buildings (4 rooms per unit) or
- \$8,400 per elevator apartment under 4 rooms per unit
- \$2,250 per room for non-elevator apartments
- \$8,100 per apartment averaging under 4 rooms per unit.

Still, the spread between costs and mortgage limits was too big to produce the kind of "middle-income" rentals FHA likes—at least not without requiring more equity than anybody would put up while FHA policy was to control profits. Last year, builders persuaded Congress to allow an extra \$1,000 mortgage per room in "high-cost areas." This, builders agree, lets 207 become the 90% loan Congress envisioned.

TAXES cont.

Q Why is depreciation so important to builder-owners of rental property?

A Savings on depreciation are what makes it possible to pay off the mortgage, interest, insurance, taxes, repairs and maintenance.

Q How can you save enough by depreciation alone to do all that?

A Total cash rents must equal or exceed the monthly mortgage debt amortization and a pro rata amount of accrued federal and state income taxes if the rental owner is to avoid contributing more equity capital to a project. Principal payments on a mortgage are not tax deductible. So the owner needs a way to reduce his taxable income from a project to a level well below what he must pay to amortize the principal of his loan.

The Internal Revenue Code lets depreciation be computed in several ways: the straight-line method, the declining-balance method (using a rate not more than twice the straight-line rate), the sum-of-the-digits method, or any other consistent method which lets the owner depreciate

no more of the cost during the first two-thirds of the useful life of the property than he could under the declining-balance method.

Q How does straight-line depreciation work in relation to rental housing?

A It spreads depreciation—and hence recovery of cost—evenly over the entire useful life of the property. For example, a rental unit that cost \$10,000 and has a useful life of 20 years would entitle the owner to a \$500 a year tax deduction for each of the 20 years. This is the method used by most taxpayers before the Revenue Code was rewritten in 1954. Figuring depreciation in this way isn't much help to rental owners who want to retrieve their equity quickly.

Q Can the faster write-off methods be used on all rental property?

A Double-rate declining balance and sum-of-the-digits can be used only for tangible property with a useful life of three years or more which is constructed, recon-

FHA sets ceiling rents to produce a prescribed net income at 93% occupancy. For 207s, the return runs 7¼ to 7½% (depending on applicable interest rate). FHA aims at setting a rate ½% higher than the debt service plus ½% insurance premium. At 93% occupancy, the formula produces a return of about 11% on equity. At 100% occupancy the return goes up to about 20% more than is generally realized.

What does the financial profile of a typical 207 look like? Here are actual figures for a 12-unit project in a Midwestern city with average rentals of \$135 a month:

Land cost	\$20,000
Construction cost	140,000
Total cost	160,000
Mortgage	142,000
Equity investment	18,000
Annual gross*	19,940
Annual operating expense	6,000
Taxes	2,500
Mortgage payments	8,395
Net operating income*	3,045
Tax picture:	
Mortgage interest	7,000
Depreciation (straight line) 40-year	4,000
Operating expense	6,000
	\$17,000

* On 100% occupancy basis; FHA allows for 7% vacancy which would reduce earnings by \$1,395.

FHA 220: more red tape, but loans at par

If you can use it in your city, FHA's Sec. 220 combines all the advantages in the book for apartment building, except for the cost certification and rent control.

New York FHA Boss Nardone predicts starts under 220 may soon race ahead of building under 207 in his domain. Sec. 220's 5% interest means no trouble with loans. Instead of basing its mortgage on 90% of appraised value as in 207, FHA bases a 220 mortgage on 90% of replacement cost. This is another way of saying the smart builder need invest only his time and office overhead. Congress made this even clearer in 1956 when it encouraged FHA to recog-

nize as cost "an allowance for builder's and sponsor's fee and risk" up to 100% of all costs except land. On top of that, 220 mortgages are eligible for Fanny May special assistance, which means the government mortgage agency must pay par for them, less 1½ points purchasing and market fee. And there's no stock purchase requirement either. Sec. 220, of course, can only be used in areas certified by HHFA as having a workable program to combat slums, or in an area being redeveloped under the earlier provisions of the Housing Act of 1949.

Syndicates: the new pools of capital

By no means every rental expert takes as bearish a view of syndicating deals as Chicago's Maurice Pollak. Indeed, equity money for most really big apartment developments today is assembled through syndicates. Usually, a builder is the organizer, or chief investor. But high-income business and professional men—doctors, for instance—are investing in apartment deals from Miami to Seattle. New York realty men estimate the number of syndicates in the state has at least doubled in the last five years to about 50 groups with nearly \$400 million.

To the outside investor, the lure of realty participation is strictly profit. Syndicates—usually partnerships to sidestep federal corporate income tax—say the return runs from 7 to 15% a year. That compares with a 3.99% average at the beginning of 1958 on four grades of corporate bonds rated by Moody's, and a 6.1% median return on dividend paying common stocks on the NY Stock Exchange. To the builder, syndication cuts the need for equity capital, but includes him in on potential profits. Moreover, it lets him make management fees and/or construction fees and keep his organization busy.

Will rentals change patterns?

Yes, if the trend now emerging goes far enough. Affected will be chiefly cities in the West and South. The next five years, thoughtful apartment men agree, will see many more apartments in the medium price ranges. Pressures are becoming irresistible. END

structed, erected or acquired after Dec. 31, 1953. For acquired property, the original use of it must commence with the taxpayer after Dec. 31, 1953. So some used rental property (regardless of its useful life) must be depreciated by the old straight-line method. But where Internal Revenue officials grant permission to change the method or where existing property is "used" for the first time, the taxpayer can use the declining-balance method of computation at a rate not to exceed 150% of the straight-line method.

Q How does double-rate declining-balance depreciation work?

A On new property, it permits depreciation up to twice the straight-line rate. This is applied uniformly each year to a constantly declining balance computed by annually reducing the cost of the property by prior depreciation allowances. This way some two-thirds of the cost of a rental project can be recovered through depreciation during the first half of its estimated useful life. This method leaves a small unrecovered cost at the end of the useful life of the property. But this can be written off when the

owner sells or abandons the property. Better, the 1954 tax law lets an owner switch to the straight-line method at any time. Usually, this offers an advantage after about 35% of the useful life of the property.

Q How does the sum-of-the-digits method of figuring depreciation work?

A Like the declining-balance method, it permits faster depreciation during the early life of a property. The depreciation rate is a fraction; the numerator is the remaining useful life of the property at the beginning of the tax year, the denominator the sum of the years of useful life at time of acquisition. For example, if a property has a useful life of five years, the denominator each year is 15—the sum of 1, 2, 3, 4 and 5. And first-year depreciation would be 5/15ths of cost (less salvage value, if any). Second-year depreciation would be 4/15ths. This system permits entire recovery of depreciable cost during the useful life of a property.

Q How do the savings from the three methods compare, in practice?

How to save taxes continued on page 156

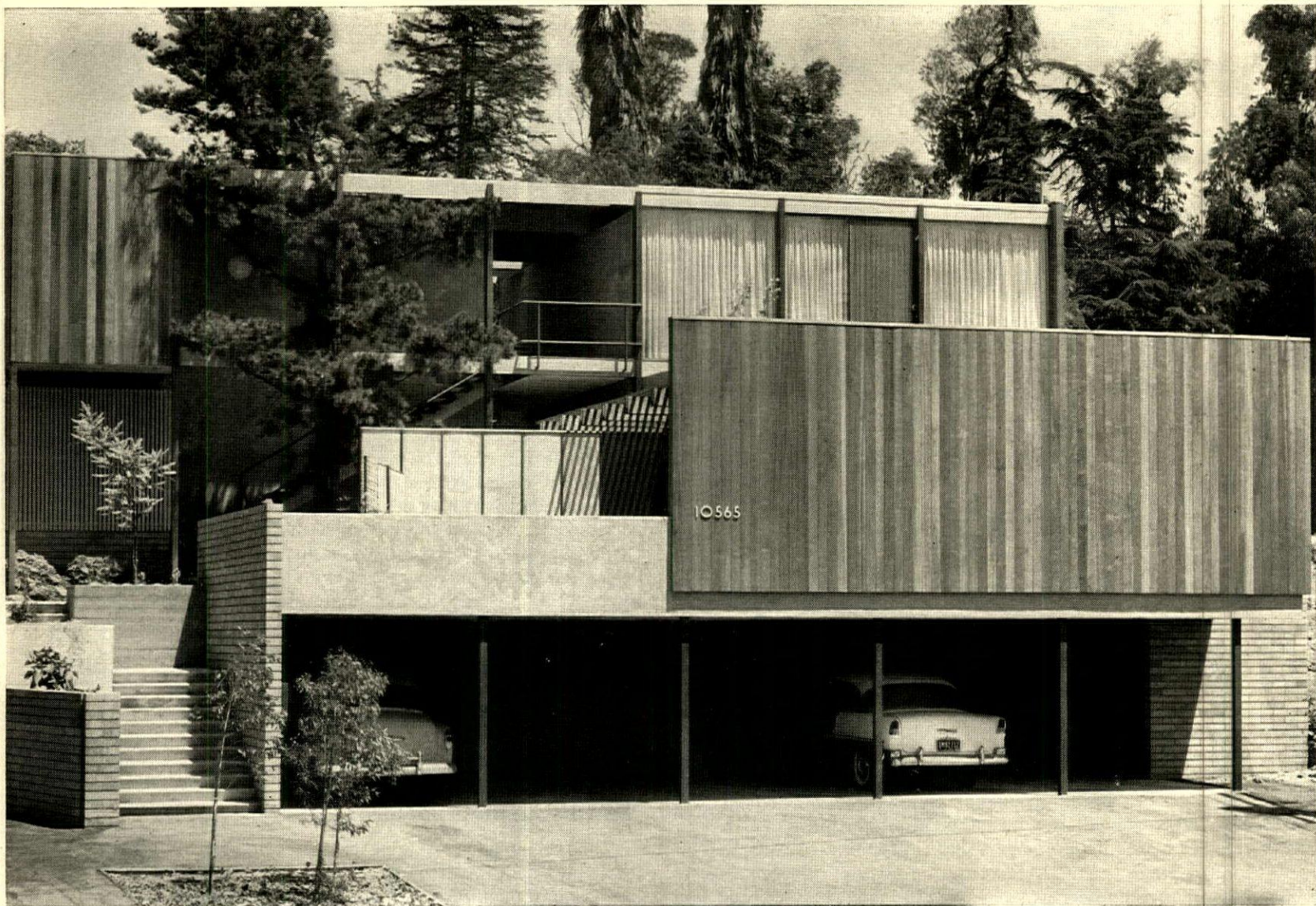

Architect: Raymond Kappe. No general contractor. Los Angeles

Rene Sheret

GARDEN APARTMENTS :

In the quick-money climate of FHA 608, most garden apartments tended to be impersonal, nondescript buildings—designed without imagination and built and equipped to meet minimum standards. Not so today.

Today's good garden apartments are long-term investments—built to compete for tenants. They are well planned, attractive looking, comfortable to live in. And, most important to you, they offer more opportunities than ever for home builders. Why? Because they are being built in smaller units. And because they are getting more and more like single family houses.

Like today's houses:

Today's apartments are planned for good living. Says Architect Robert Little of Cleveland: "The things you try to get into any house are the things you should try to get into apartments—privacy, a view, a degree of personal living."

Today's apartments are equipped for good living. Says Architect Dan Palmer of Palmer & Krisel, Los Angeles: "If you want to compete with other apartments, you need things like built-ins, disposers and dishwashers."

Today's apartments fit their region. Says Builder Manning Grinnan of Dallas: "People in the Southwest want indoor, air-conditioned living in the

Douglas Simmonds



Archs.: Howell & Arendt, Neal Butler. Bldr.: W. S. Hamilton. Santa Barbara
Arthur Kravetz

Morley Baer



Architect: Schubart & Friedman. Builder: H. S. Meinberger, Belvedere, Calif.

Frank Lotz Miller



Arch.: Irwin Baker. Buldr.: Frank E. Cooper. Developer: Lou Heller. Baltimore
H&H staff



Architect: Stanford A. Busby. Builder: Leland S. Busby, San Antonio



Architect: Curtis & Davis. Builder: Lionel F. Favrer Co. New Orleans

Look how they've changed since the days of 608

hot summer months and outdoor living the rest of the year. We built our apartments to give them both."

Today's apartments can be built with materials and methods that home builders already use. Says Architect George Rockrise of San Francisco, who has just designed a \$270,000 apartment for Home Builder Rollin Meyer: "Meyer's experience has been chiefly in wood construction. This was a major factor in our choice of wood framing."

So it's not surprising that today's good houses have inspired most of the best and newest changes in today's good apartments.

If you check the big ideas behind the changes, you'll find new emphasis on:

1. Land planning and land use.....p. 110
2. Indoor-outdoor living.....p. 112
3. Privacy for each apartment.....p. 113
4. Up-to-date practical items—from more storage to heavier wiring. .p. 114
5. Luxury touches to attract tenants.....p. 116
6. Workable floor plans.....p. 118

Robert Laufman



SCATTERED PINES were saved on this site. Now they form pleasing contrast with strong horizontal lines that keep building close to ground. Development won 1955 AIA award. Architects: Keyes, Smith, Satterlee & Lethbridge. Builder: Luria Bros. Pine Springs, Va.

IDEA 1 : Try a fresh approach to land plans

Here—say today's apartment designers and builders—are the three most important things to keep in mind:

1. Use your sites as they are—save good trees, for example.
2. Hold down density on your sites. "That's the biggest thing we're doing," says Architect Dan Palmer.
3. But keep open spaces to intimate scale. "Overwhelming open spaces just aren't necessary," says Architect Coder Taylor of Chicago.

And don't overlook adequate parking close to the car owners' apartments. The minimum in many codes is one parking space per apartment, but sometimes more are needed. Parking is usually on open ground, sometimes in carports. Under-apartment garages save land but hike costs because they require fireproof construction, often with sprinkler systems.

You'll find you can put apartments on sites you might otherwise neglect. Builder Joe Eichler of San Francisco is putting them on an 8-acre site that would cost over \$6,000 a lot for single-family houses. Other builders are using odd-shaped and urban sites (opposite page) and hillsides (below).

Apartments also make good buffers. Builder John Long of Phoenix is putting them between his houses and his new shopping center.

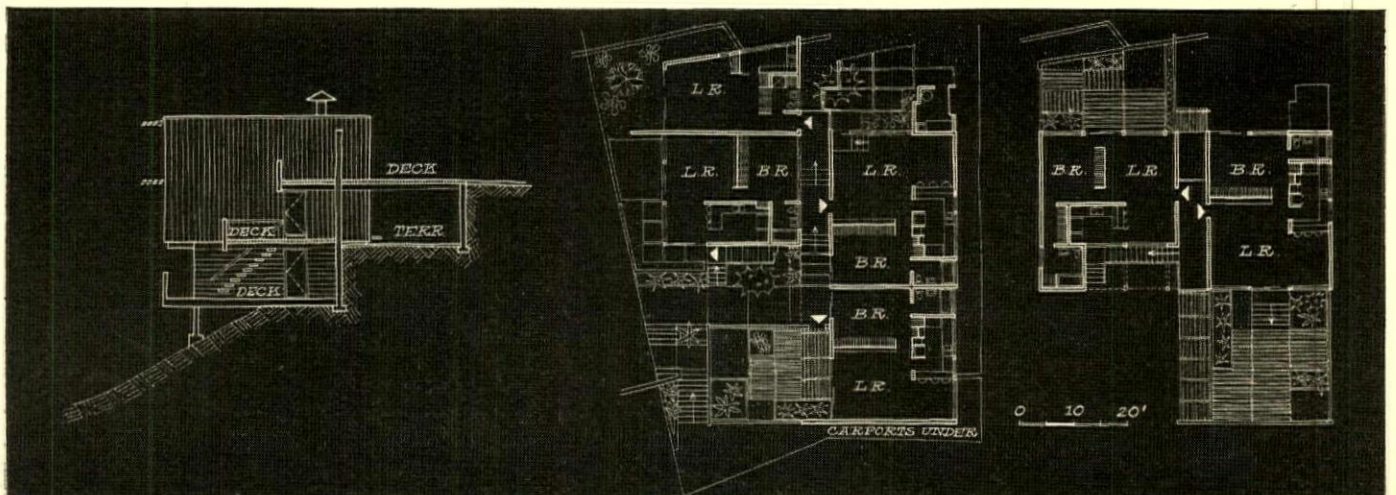

HILLSIDE SITES get two treatments. Left: apartments are stacked, decks and terraces at sides and rear. Architect: R. A. Little. Cleveland. Right: apartments change levels with ground; terraces are at grade, decks on roofs of lower apartments. Architect: R. Kappe. Los Angeles.

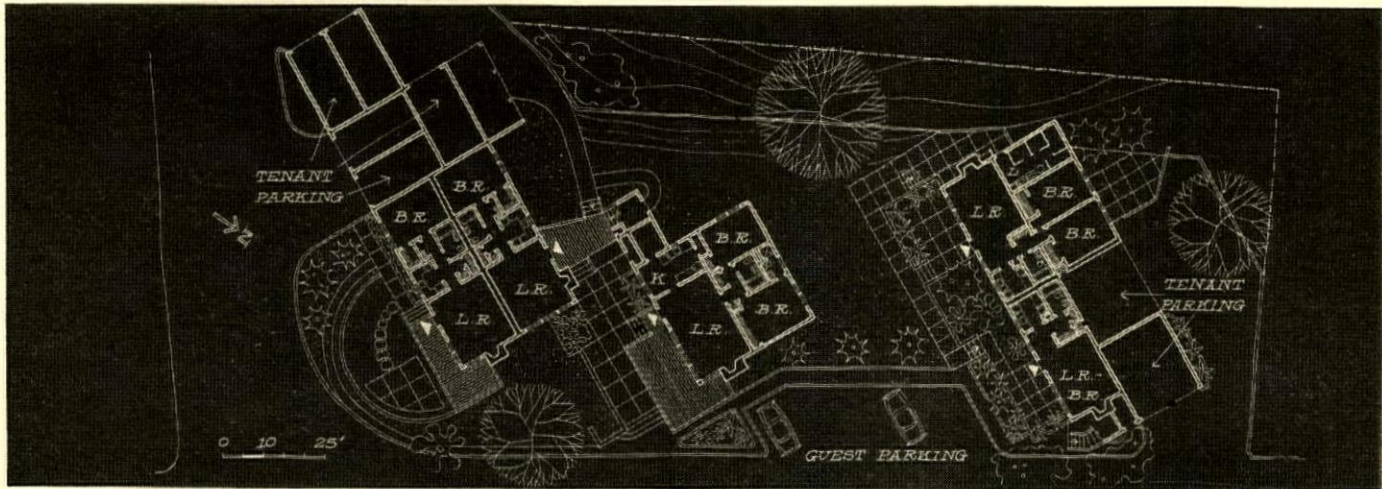

ODD-SHAPED SITE suits small separate buildings. Plan also shows other good land usage: low density, adequate parking, saving of big trees, small gardens to keep open space in scale. Architect: Schubart & Friedman. Builder: H. S. Meinberger. Belvedere, Calif.

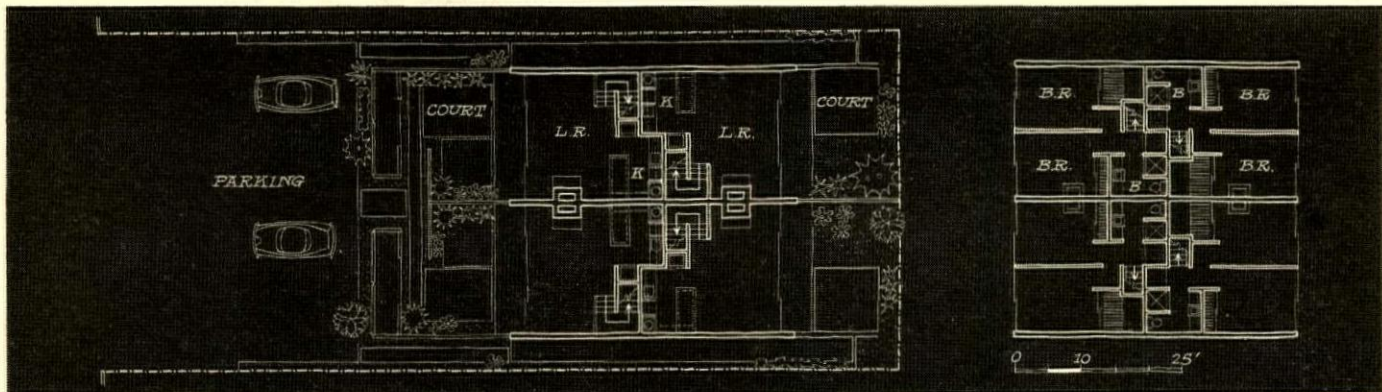

TIGHT CITY SITE is planned for full use. Each of four duplex units has private garden, separate entrance, one parking space. Entrance walks to rear apartments are along sides of building. Designer: Craig Ellwood Assoc. Builder: Henry Salzman. Hollywood, Calif.

Douglas Simmonds



UNUSUAL CARPORT has rooftop garden used by tenants of upper-level apartments. Large trees in right foreground were kept to shade gardens and entrance driveway. Architects: Howell & Arendt and Neal Butler. Builder: W. S. Hamilton, Santa Barbara, Calif.

continued

**Today's
garden
apartments**
continued



Morley Baer

ROOM WITH A VIEW opens out onto a large, sunny balcony through sliding glass doors. The balcony is partly screened from the street by a planting box along the far side. Architects: Campbell & Wong. Builder: Edward Anderson. San Francisco.

IDEA 2 : Use the outdoors as you do with a house

"Today's apartment tenants, like today's home owners, want more light and air," says Roger Turner of the J. H. Hedrick Co., California builders.

Other builders and designers agree. So they are merging the indoors and outdoors—first by using larger windows, second by opening their apartments to patios, terraces and balconies. Result: apartments are getting more like houses and less like institutional buildings.

You can use sliding glass doors and floor-to-ceiling windows to open grade-level apartments to private gardens and patios (below), second and third floor apartments to balconies (above). And even without patios and balconies, more window area means more light. But if you widen bedroom windows—even make them wall to wall—you may be wise not to deepen them. The idea: to leave room between the sill and floor for furniture.

And one other point: if you're lucky enough to have a view, use it—orient as many apartments as possible to face it.

Frank Lotz Miller

Marvin Rand



PATIO is outdoor living room. Glass wall, set back from face of building, uses upper floor as overhang. Designer: Craig Ellwood. Builder: Henry Salzman. Hollywood, Calif.

GLASS WALLS make apartment living room—like one in a country house. Garden fences provide privacy. Architects: Curtis & Davis. Builder: Lionel F. Favret Co. New Orleans.



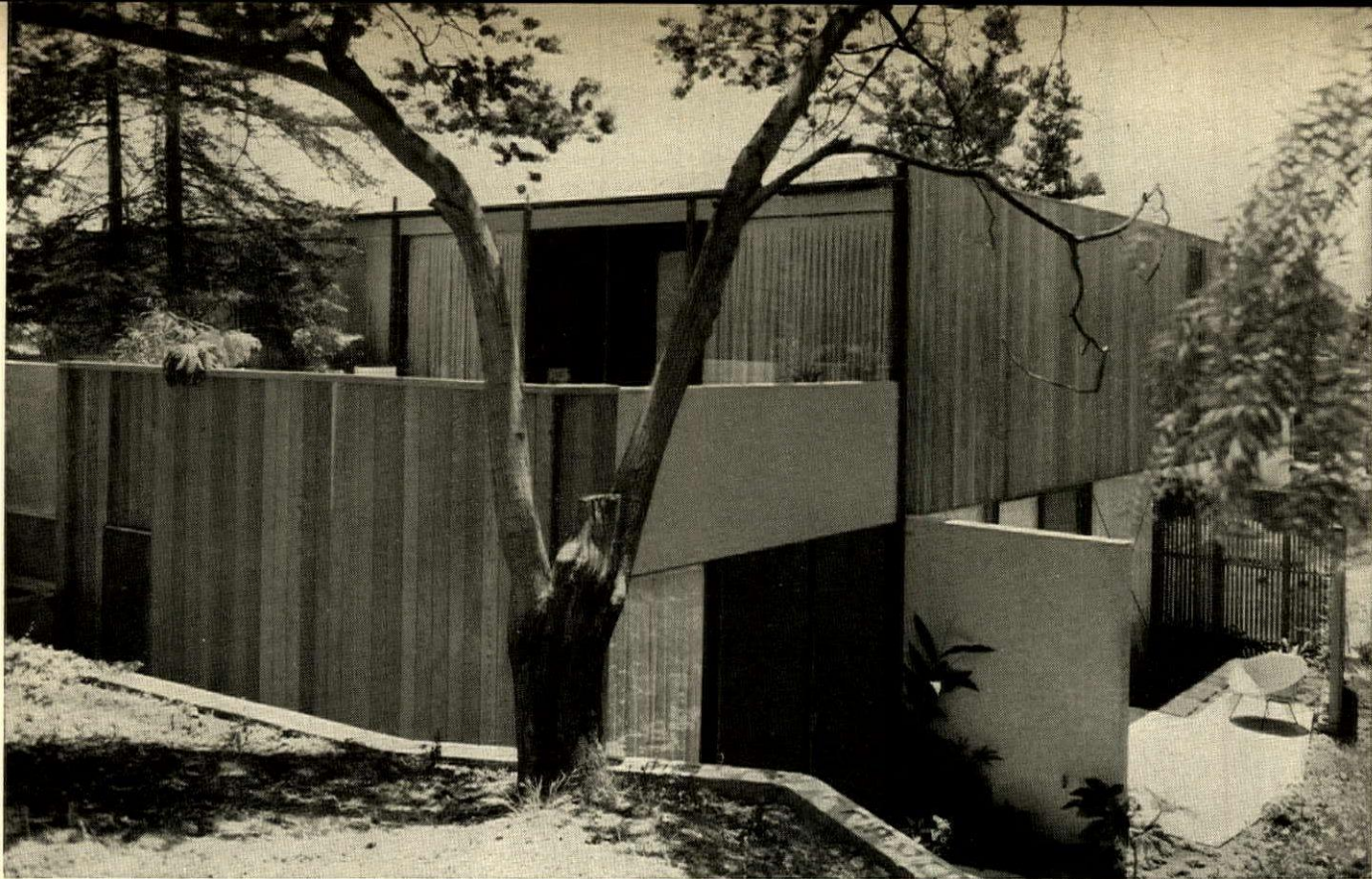

Rene Sheret

OUTDOOR PRIVACY is feature of this two-level apartment building. Gardens of lower apartments are below blank walls, separated by other walls and partly fenced. Decks of upper apartments have solid parapets to block view from street. Architect: Raymond Kappe. Los Angeles.

IDEA 3 : Plan your apartments for privacy

“Today’s tenants want apartment living with all the privacy of a separate house,” says Apartment Designer Richard Frazier of Beverly Hills. Here’s what he and other designers and builders suggest:

1. Use fences, walls and planting to screen patios and balconies from each other and from the street.
2. Plan apartments so those on upper floors have blank walls on sides facing ground-level patios (see photo above).
3. Omit inside public corridors—use balconies as outside corridors, for example (you’ll also save valuable floor space, avoid extra costs for fire-proof construction, reduce the owner’s maintenance).
4. Give each apartment a separate entrance if possible.
5. Plan your site so buildings face away from each other, are not too close to each other and have trees between.
6. Control as much noise as you can (see also Noise, p. 128).



Julius Shulman

WINDOWLESS WALL at left faces street and helps protect this two-story, six-unit apartment from traffic noise. Architect and builder: Carl Maston. Los Angeles.

PRIVATE ENTRANCES work well in this → four-unit apartment. Nice touch: private garden off bedroom (center). Architect: Maddox & Assoc. Builder: John Long. Phoenix.

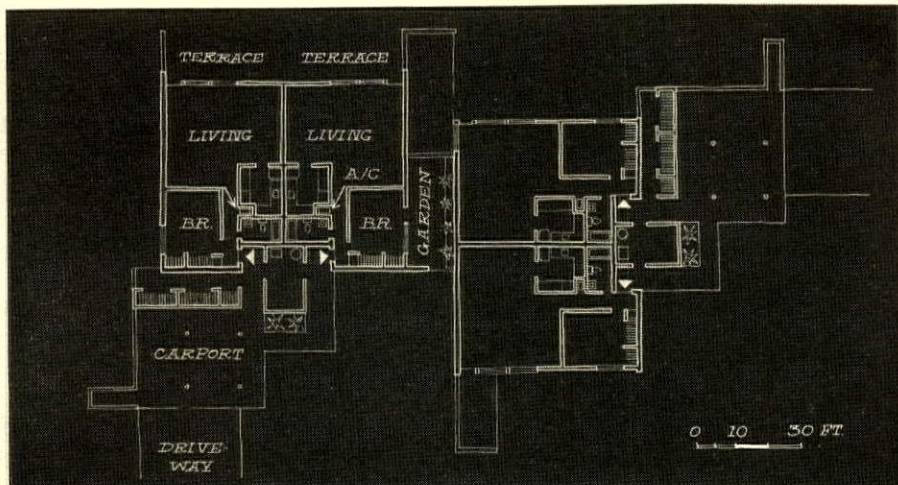

continued

Today's
garden
apartments

continued

Douglas Simmonds

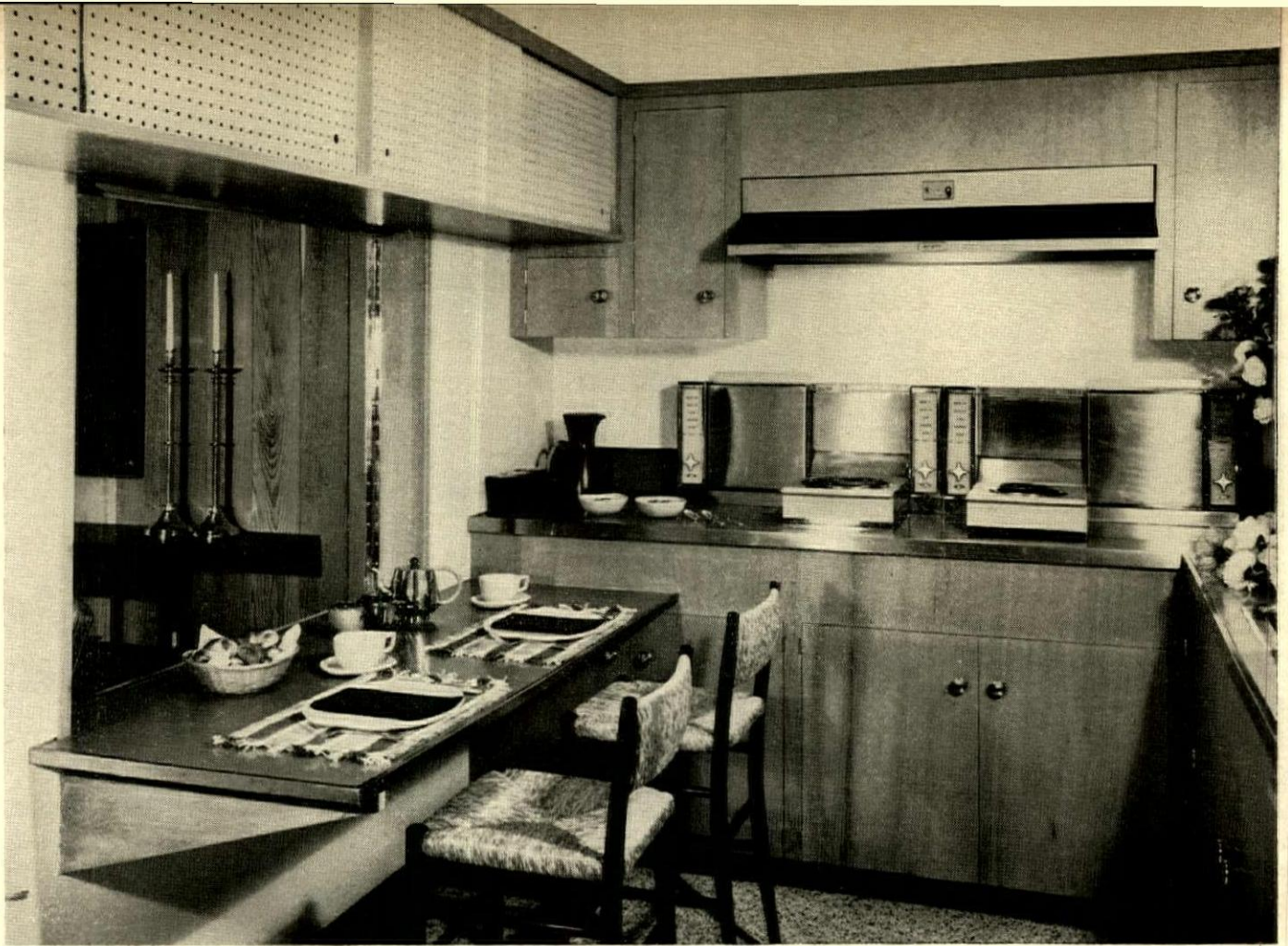

WELL EQUIPPED KITCHEN in luxury apartment includes plenty of features to attract tenants: fold-up range units that save valuable counter space, stainless steel countertop, vent hood over range units, some cabinets with natural wood finish and others with hardboard slid-

ing doors, and built-in oven (not shown in photo). Counter at left is used for informal dining in kitchen, also serves as pass-through to formal dining area. Architects: Howell & Arendt and Neal Butler. Builder: W. S. Hamilton. Santa Barbara, Calif.

IDEA 4 : Bring the indoors up to date

First, provide for air conditioning—even if you don't actually install it. In lower rent apartments, it's a good idea to beef up your wiring and leave wall openings so tenants can install their own units later. In luxury apartments, air conditioning is a must. Says Norman Wax of Henry Hohausser & Assoc., architects, Miami Beach: "Whether you put in central or room air conditioning depends on how much the building is to cost."

2. Use heavier wiring—at least 100 amps—say most builders and architects. You'll need it to carry the heavier electrical load imposed by more appliances, more television and more air conditioning.

3. Try separate heating units—especially in small buildings. Tenants control them and pay for fuel. Though the owner's maintenance costs may be higher than with a central system, he's free of fuel bills and this generally means a net saving to him.

4. Include kitchen extras like disposers, dishwashers, vent hoods and built-in ovens and ranges. They're musts in luxury apartments—easier renting outweighs extra initial costs and extra maintenance. If you have to omit extras in lower-rent units, you can still leave space (and wiring and plumbing) for tenants to add them.

5. Pack in all the storage you can—full-wall closets in bedrooms, linen closets, coat closets and room for bulky and seldom-used items in basements, common rooms and carports. Sums up Architect Charles Goodman of Washington, D. C.: "Absolutely everybody wants more storage."

6. Put dryers as well as washers in common laundry rooms. But even with dryers, leave some space for inside drying lines.

7. Use inside baths where codes let you. They free perimeter walls for more bedroom and living room space, also cut down hallways. Of course, you'll need vent fans operated by separate switches or light switches.

Morley Baer



SMALL KITCHEN looks bigger because it's open to dining area. Equipment includes dishwasher. Architect: Michael Wornum. Builder: Stewart Dinwiddie Sausalito, Calif.

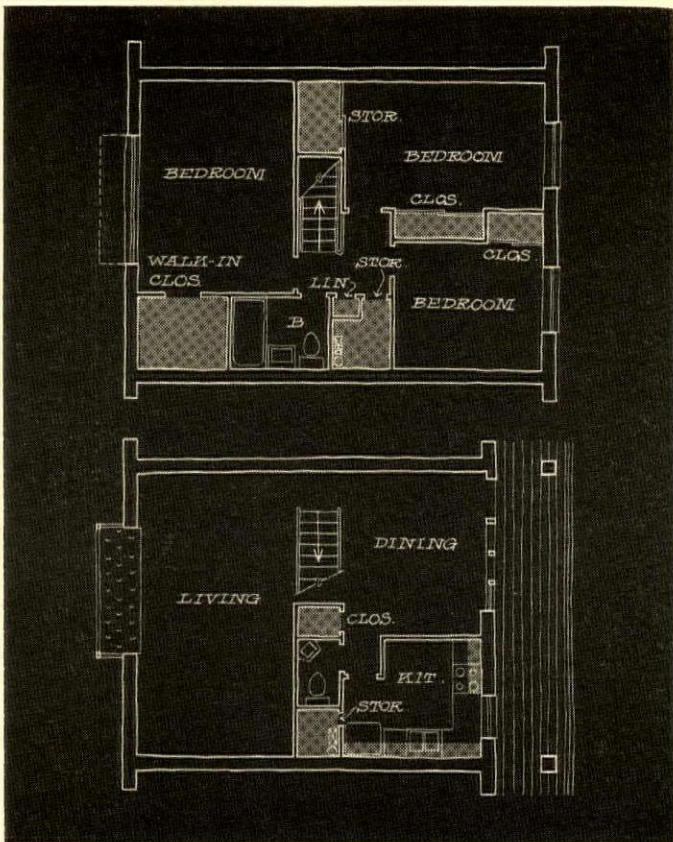

AMPLE STORAGE for any apartment is shown in plan for duplex in redevelopment project. Besides the usual closet space, plan calls for walk-in closet off one bedroom and two bulk storage areas—one upstairs and one down. Architects: Harry Weese & Assoc., Chicago.

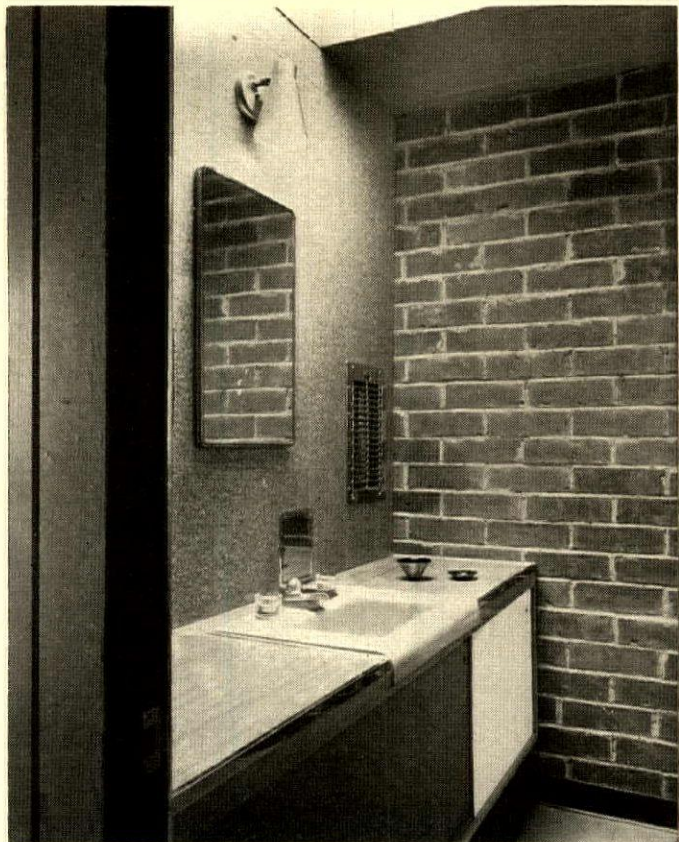

INSIDE BATH is fan vented, has skylight over lavatory. Electric unit, set into wall at right of sink, gives quick additional heating. Unusual wall finishes are cork tile (left) and exposed brick (right). Designers: Craig Ellwood & Assoc. Builder: Henry Salzman. Hollywood, Calif.

in practical ways like these



SLIDING LOUVERED SCREENS, partly open at left and closed at right, protect from glare. Use of other sun controls (overhangs, sun-



shades) depends on orientation (see H&H, Mar. '58, p. 136). Architects: Campbell & Wong. Builder: Edward Anderson. San Francisco.

**Today's
garden
apartments**
continued

Rene Sheret



Marvin Rand



Morley Baer



ATTRACTIVE ENTRANCES, with planting, give a house-like atmosphere to three California apartments. Left: in Santa Barbara—Howell & Arendt and Neal Butler, architects; W. S. Hamilton, builder. Right top: in Hollywood—Craig Ellwood Assoc., designer; Henry Salzman, builder. Right bottom: in San Francisco—Campbell & Wong, architect; Edward Anderson, builder.

IDEA 5: Add extras to attract tenants

Julius Shulman



You can use luxury touches and other extras to merchandise apartments just the way you use them to merchandise houses. Many of today's apartment builders are doing just that.

Take play yards, for instance. Most apartment developments now have them. And in the south, southwest and far west many projects have swimming pools with adjoining patios and terraces. Even more elaborate recreation facilities are provided by some large-scale builders like Milwaukeeans Jerome Treis and August Urbanek. Treis has a 72-acre tract with two lakes, bridle paths, a baseball field and tennis and badminton courts. Urbanek is putting up a recreation building with space for dancing and a soda fountain and separate card and game rooms for older people.

Smaller developments, too, can have plenty of extra touches to attract tenants—dramatic entrances, for example, and decorative stairways, kitchen pass-throughs, fireplaces, carpeting and special wall and ceiling finishes.

OPEN STAIRWAY makes apartment entrance hall light, cheerful and attractive. Architects: Palmer & Krisel. Builder: George Alexander Co. Los Angeles.

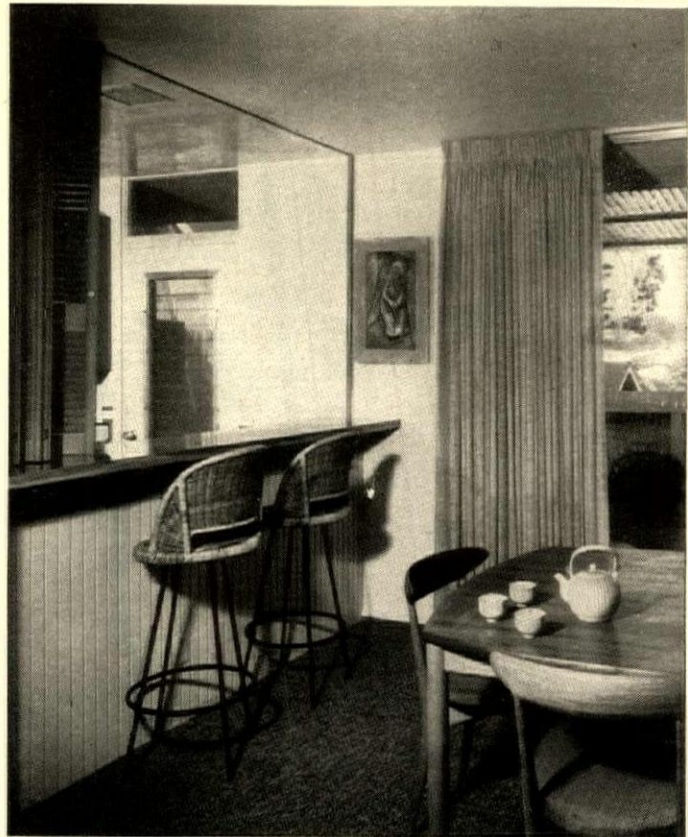

FIREPLACE IN BRICK WALL appeals to tenants who want homey feeling of single-family house. Other house-like details: exposed wood beams, wood deck ceiling, terrace (right). Architects: Howell & Arendt, Neal Butler. Builder: W. S. Hamilton. Santa Barbara.

WIDE PASS-THROUGH between kitchen and dining room also serves as snack bar. It can be opened as shown or closed with louvered folding shutters (left). Dining room also has sliding glass doors to terrace (right). Designer and builder: Richard Frazier. Beverly Hills.



SWIMMING POOL is in center of O-shaped apartment building. Balconies serve as public corridors for second-floor apartments, are covered

by 7' overhangs. Architect: Edward Fickett. Builder: Dobbins Construction Co. Landscape Architect: Garrett Eckbo. Los Angeles.

continued

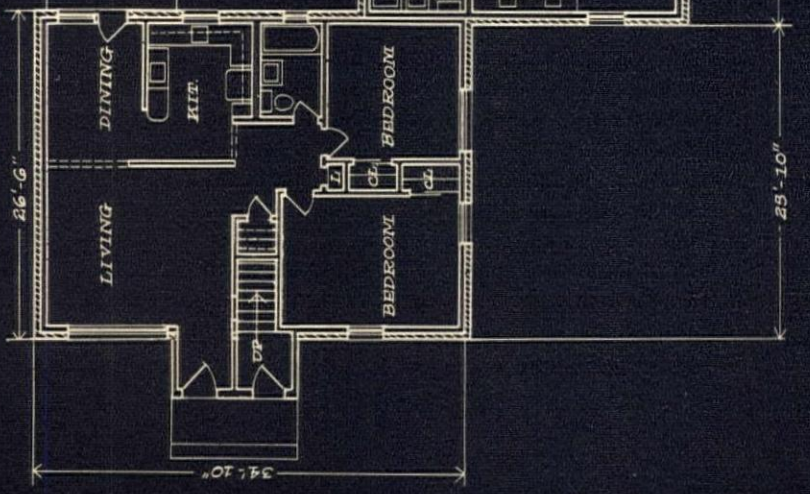

4 ARCH. A. H. SALKOWITZ
MANCHESTER, CONN.

FIRST FLOOR (SECOND FLOOR SIMILAR)
4-UNIT 2-STORY

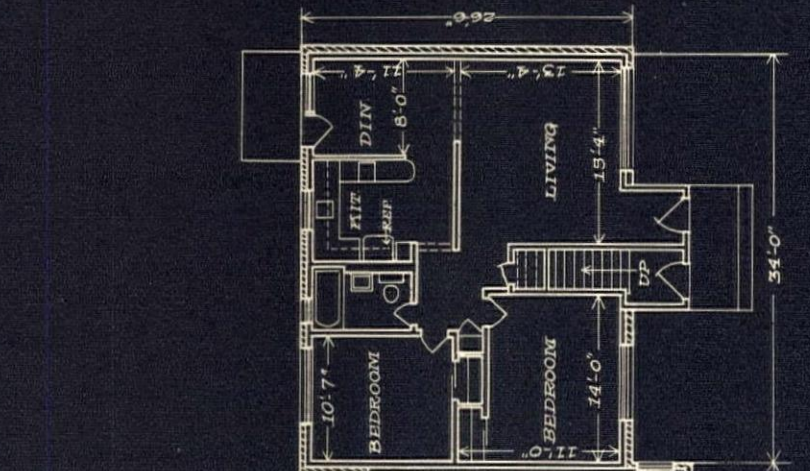
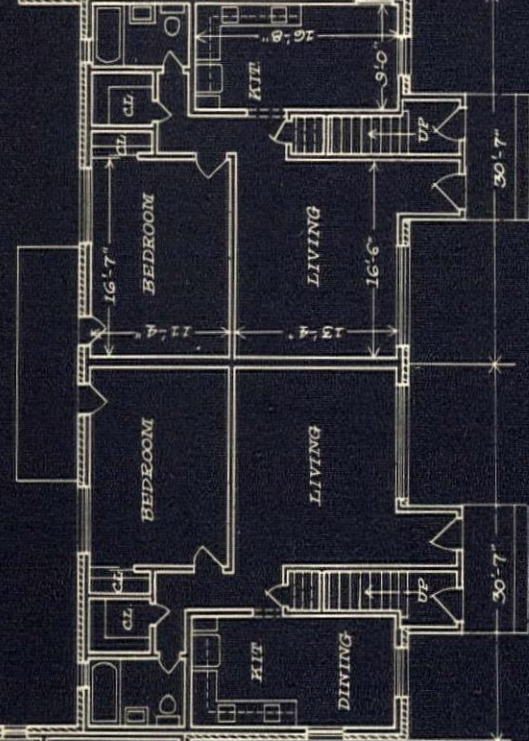

5 ARCH. CARL E. RIEMENSCHNEIDER
BLDG. AUGUST URBANEK - MILWAUKEE

FIRST FLOOR
(SECOND FLOOR SIMILAR)
4-UNIT 2-STORY BLDG

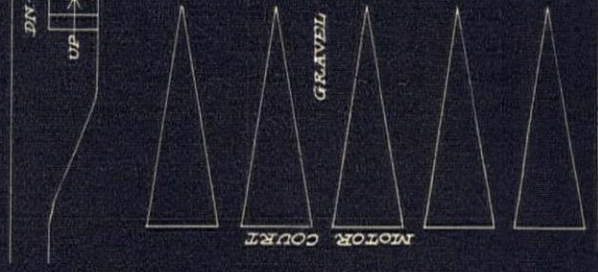
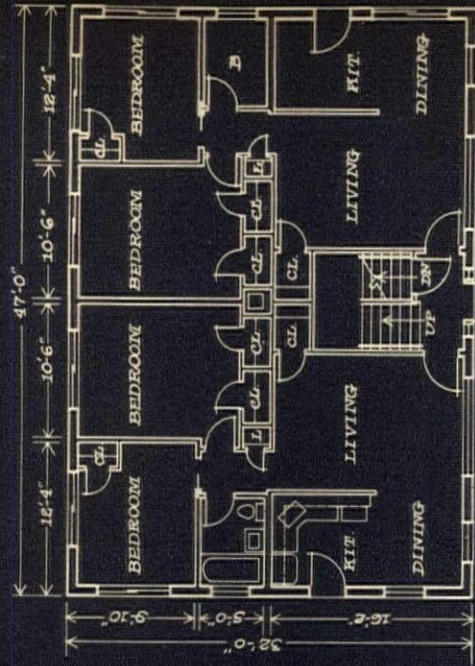

6 ARCH. WILTSHIRE & FISHER
DALLAS, TEXAS

FIRST FLOOR (SECOND FLOOR SIMILAR)
10-UNIT 2-STORY

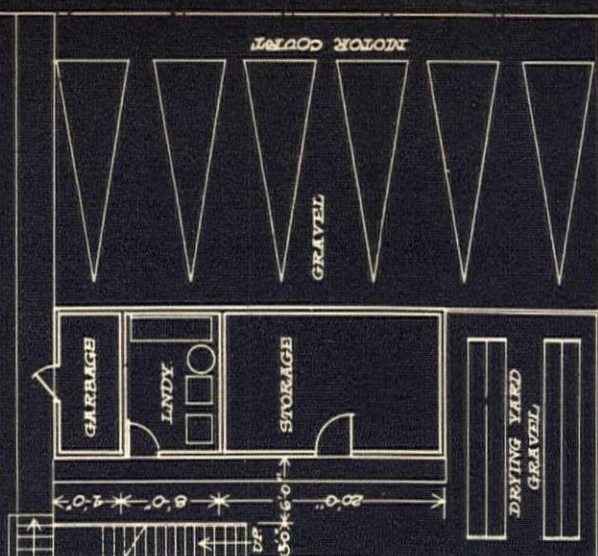
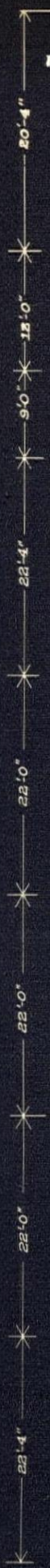
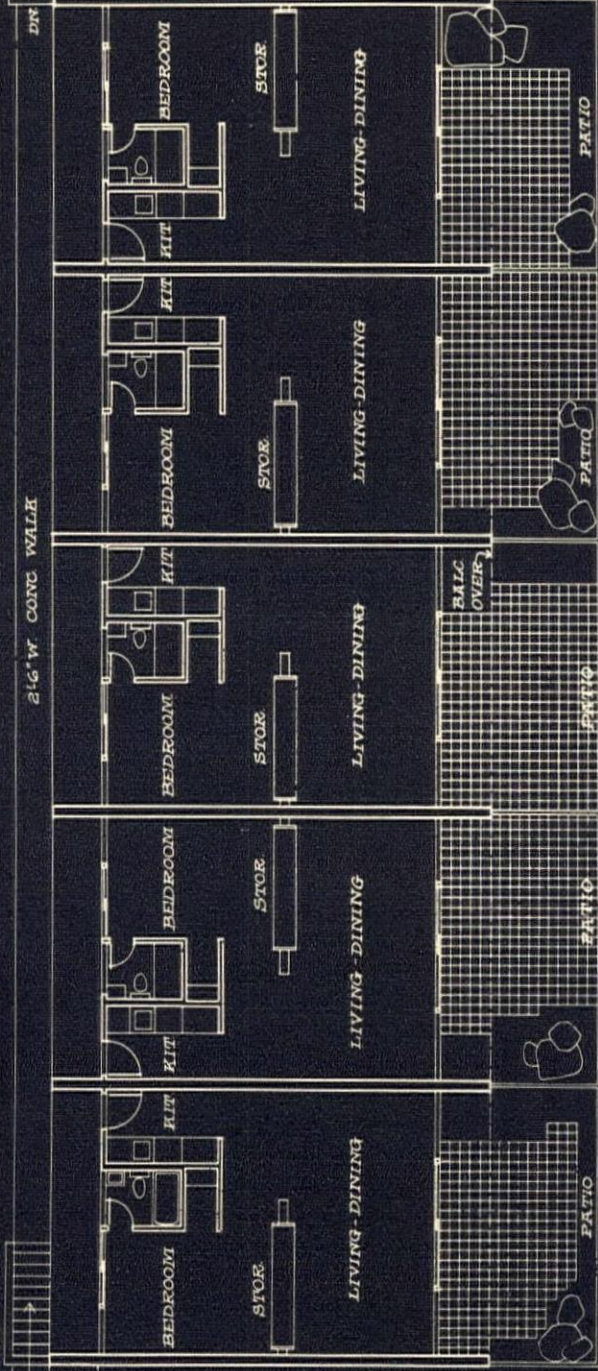

10-UNIT
2-STORY

BRICK PATIOS IN SAND

2 1/2" W CONC WALL

BALC OVER

PATIO

PATIO

PATIO

PATIO

PATIO

PATIO

PATIO

PATIO

PATIO

PATIO

PATIO

PATIO

PATIO

PATIO

PATIO

PATIO

PATIO

PATIO

PATIO

PATIO

PATIO

PATIO

PATIO

PATIO

PATIO

PATIO

PATIO

PATIO

PATIO

PATIO

PATIO

PATIO

PATIO

PATIO

PATIO

PATIO

PATIO

PATIO

PATIO

PATIO

PATIO

PATIO

PATIO

PATIO

PATIO

PATIO

PATIO

PATIO

PATIO

PATIO

PATIO

PATIO

PATIO

PATIO

PATIO

PATIO

PATIO

PATIO

PATIO

PATIO

PATIO

PATIO

PATIO

PATIO

PATIO

PATIO

PATIO

PATIO

PATIO

PATIO

PATIO

PATIO

PATIO

PATIO

PATIO

PATIO

PATIO

PATIO

PATIO

PATIO

PATIO

PATIO

PATIO

PATIO

PATIO

PATIO

PATIO

PATIO

PATIO

PATIO

PATIO

PATIO

PATIO

PATIO

PATIO

PATIO

PATIO

PATIO

PATIO

PATIO

PATIO

PATIO

PATIO

PATIO

PATIO

PATIO

PATIO

PATIO

PATIO

PATIO

PATIO

PATIO

PATIO

PATIO

PATIO

PATIO

PATIO

PATIO

PATIO

PATIO

PATIO

PATIO

PATIO

PATIO

PATIO

PATIO

PATIO

PATIO

PATIO

PATIO

PATIO

PATIO

PATIO

PATIO

PATIO

PATIO

PATIO

PATIO

PATIO

PATIO

PATIO

PATIO

PATIO

PATIO

PATIO

PATIO

PATIO

PATIO

PATIO

PATIO

PATIO

PATIO

PATIO

PATIO

PATIO

PATIO

PATIO

PATIO

PATIO

PATIO

PATIO

PATIO

PATIO

PATIO

PATIO

PATIO

PATIO

PATIO

PATIO

PATIO

PATIO

PATIO

PATIO

PATIO

PATIO

PATIO

PATIO

PATIO

PATIO

PATIO

PATIO

PATIO

PATIO

PATIO

PATIO

PATIO

PATIO

PATIO

PATIO

PATIO

PATIO

PATIO

PATIO

PATIO

PATIO

PATIO

PATIO

PATIO

PATIO

PATIO

PATIO

PATIO

PATIO

PATIO

PATIO

PATIO

AMERICA'S FOREMOST ARCHITECT SPEAKS ON PREFABRICATION

AND THE ROLE OF CREATIVE MAN IN THE MACHINE AGE:

"QUALITY AND QUANTITY MUST BE PARTNERS. SCIENCE AND ART MUST LIVE TOGETHER"

FRANK LLOYD WRIGHT

Way back in the days when Hull House was the cultural center of Chicago—say 65 years ago—William Morris, John Ruskin and the Pre-Raphaelites were at the center of the stage in art and architecture. Handicraft societies were all over the United States.

Hull House had called a meeting to found a similar crafts society in Chicago. I was invited by Jane Addams to put forward at this meeting a minority report. The minority report was: "what is the use in getting behind doors and pounding your fingers trying to make things, when the whole world of production is stalled and missing inspiration that really belongs to the machine!"

In those days we hadn't reckoned with machines. We merely used them. The machine was new on the crafts horizon and it was murdering handicraft right and left. It had succeeded by way of Grand Rapids in turning out machine carving as well as other hand work. I made a proposition at the meeting that we quit all of that study of the crafts.

I advocated the machine as an artist's tool and the machine of course meant prefabrication, reproduction, standardization. I suggested we go to work and investigate what it could do in Chicago, in the metal trades, what it could do with wood, what it could do with other building materials. But I was voted down and out.

Next day the Chicago *Tribune* published an editorial (I think Jane Addams wrote it), saying that for the first time in the history of art, a Chicagoan had advocated the machine as an artist's tool.

Since then my lecture, "The Art and Craft of the Machine," has been translated into seven languages and gone around the world. It had a long enough time to get around and come back, and really nothing much has happened since.

The ability to envision and make practical the uses and purposes of machines—to get what inspiration we can from on high to qualify the machine product in a new way, to new purposes—is still "way behind the light-house." As a matter of fact our architects are today building 19th century buildings. We are still building

the old steel frames. In other words, people who were accustomed to building lumber buildings, now build them out of steel lumber.

All our architects who are famous as modernists are still building steel-lumber buildings! New York's full of them, Chicago's full of them. They are all dying of arthritis at the joints because you can't insure the life of a steel-frame building by insuring the life of the joint with paint. As wood was born to rot, steel is born to rust.

That is only a little indication of our lack of education. I mention it here to show how slow it has been even to conceive the justice and the perfect common sense of the nature of materials and of making them beautiful in the way you work with them.

Now, that means today, prefabrication, because you can prefabricate nearly everything in a house that doesn't give it individuality. The bathroom doesn't give the house much individuality. You can prefabricate it, take it to the job, make three connections. The heating system I brought over from Tokyo—gravity heat I called it because heat rises as surely as rain water falls—is now called radiant heat for some curious reason. That's mechanical and that's prefabrication. It can all be made and brought to the building.

Of course, anything done in the field has gone (labor-wise) entirely out of all proportion. The cost of building used to be, for labor, about a third of the building's total. Today labor is about one-half of the cost of the building. Architects (and they are all that is the matter with architecture, I assure you) have not given enough study to what can be done by modern machinery to the advantage of the well designed house.

Now where you live, the living rooms, these places of warmth, proportion and charm, have gone by the board because no one is willing to pay for good design. Designs are something you get out of magazines. The magazines get them from boys who are looking to make a reputation somehow for something they have gleaned somewhere . . .

The so-called practical boys doing the housing now are not the real sinners. The real sinner today is education. Teachers have not placed the values in the right places, and don't realize the value of good proportion and design. Without them there can be no real beauty in building except by rebellion.

Text on these pages is extracted from a talk given early this year in Chicago at a showing of a new model for a prefabricated house designed by Mr. Wright for Marshall Erdman & Assoc.

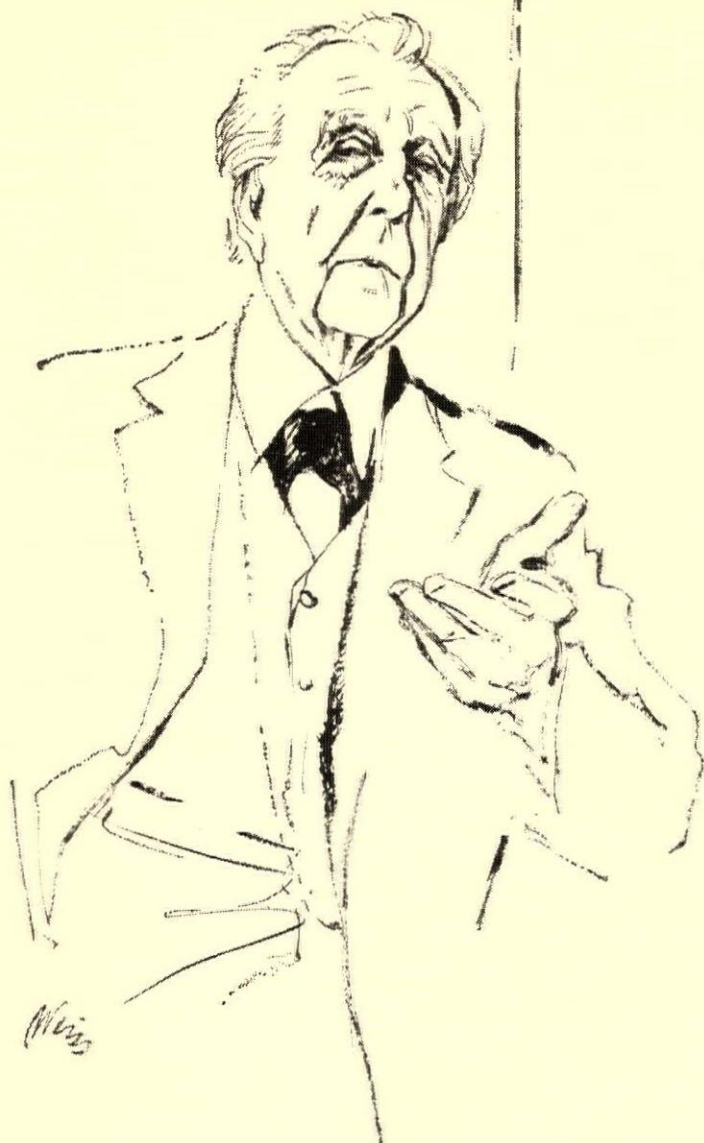

Without organic consistency of method to purpose, man to tool, there can be no great beauty in "housing." Without all these high-minded things, difficult to come by, we have only a stupid procession of empty technology. What should be technology is really not technique at all, it is mere habituation and has come by way of the realtor. Our nation is unfortunate in this respect. The industrial revolution (production controlling consumption) is making a cinder-strip of the whole country, with little hot-spots we call cities.

Now I don't think we were destined to wind up as an industrial cinder-strip. I believe we were "designed" to have the beauty and freedom of the green earth as a heritage. Then came the realtor, then came the developer—and God has not saved us from them. He won't, because He expects something of His children. He expects some intelligence on their part to stand up and say: "No, this is not living. This is not America. This is not sovereignty of the individual . . ." All the freedom of life, and the beauty of it for the individual, is right there where you live, where your "housing" is . . .

In building homes we have the key to, and the cornerstone of, whatever culture our nation is capable of. By its buildings every great civilization is judged. And most of them passed away just as we are going to pass away, only we are going to pass away sooner. We are not going to last quite as long as most of them did because we can go faster and the faster we go, the sooner we finish. So it is high time to pause and take stock of the things that constitute the spirit of true building.

Good design is the spirit of man, the spirit of our times, the spirit of our nation made evident. There is nothing so valuable, nothing worth so much to a society,

to its future, as the fine high quality of its living conditions!

Now living conditions don't consist only of kitchens, bathrooms and standardizations of rooms to live and sleep in. You can't prefabricate the thing that gives life to the building. That is something that has to come by "benefit of clergy" so to say. So this prefabricated house here, which we have launched in order to save a third of the cost—probably without damage to its character or its spirit—still has something that I have just called "benefit of clergy." This makes sure that the house belongs where it's built, that it is adapted to the site where you put it, that nothing can be done to mar or destroy the harmony of its features. The house cannot be distorted, nor can the house be misplaced.

The sense of proportion is what put me into architecture in the first place. I was the man who declared that the human scale was the scale by which man should build. The old architectures were grandomaniac architectures and were intended to give man inferiority complexes. They did! But now we are entitled to give the American citizen something more in his own image, in his own right—in his own proportion, too. Something that came out of the everywhere to which he belongs and into the here in which he lives. Now that's quality.

Quality and quantity need not be enemies, necessarily. They can be partners and in the prefabricated house that's what they'll be. That's what they are and what they should have been many, many years ago.

Our trouble now lies mainly in lack of ground. There is no such thing as human habitation put on the ground; no such thing as human habitation placed center to center, blotting out the ground. Only if the ground-space is developed into the spaces of the building and the building has enough ground-space about it to characterize the building, and be characterized by it, have you got what we should dare to call American architecture.

We used to say that an acre to the family was enough. Well, it should depend upon environment. It will all depend on where and how the building is built. Now much of the money that goes into the building should go into the place where the building stands. That is where your realtor has to come in for a drubbing. Because it is his habit to run out ahead of the crowd, buy up the land, put up his little advertising paraphernalia and sell land in little pieces—the smaller the piece, the bigger his profits. Why do you take it? Why now when the automobile is here and we have a new time scale? We plan by time scale—five minutes, fifteen minutes, twenty minutes.

Now the automobile itself has changed everything in a building. We have made the car like a little horse and stabled it alongside the building where by nature it doesn't belong. If there is any companionship that is odious to a building, it is the motor car of today. Gasoline, carbon monoxide, noise should be left outside somewhere. They are not fit for human companionship. And then if you look at the car itself, you can get an idea of what happens to buildings in the way of design. Who designs those cars? No student of nature! Well, now you can't get designs from any other source than from a deep sincere study of nature.

What's the nature of our automobility? Is it that thing with fins sticking way up and out behind and all the rest of it like a raft or a ferry boat coming down the street gnashing its teeth at you? Well, now your houses are going in the same direction. You have your picture-

continued



window houses, and you have all this glass you don't know what to do with. Perfectly indecent are most of these modern glassifications in subdivisions. I wouldn't be surprised if people began to commit suicide by the thousands on account of the way they have to live in their glass houses!

Why shouldn't you stand up on your hind legs and say: "No, we don't want that sort of thing. We know this isn't the right thing and we refuse to be jammed into a box, no matter how big the hole is in front. We know there is plenty of ground room in this country. We know that's one thing the country is 'long' on. We know we don't have to pile up on half-acre lots, 20 of us to the acre."

We don't have enough sense of our own dignity! We don't know who we are, really. We lack respect because we give no respect. Have we lost sight of the main thing we're here to get?

There is no excuse for building poverty into the country as an institution as they've done in the big red-brick prisons of New York City. Those red-brick insurance investments, the money of the people put into building poverty into the nation as an institution! . . .

If you can see freedom, if you can see green fields, if you can see children playing in the sun, if you can see buildings that have charm, what a man is, what a woman is, then you want something more than you are getting today. Now believe me—no man's home, notwithstanding prefabrication, need be so like another man's home as to cheat him of his natural distinction. Good design qualifies it by the things done to live in it. If the living room is there, and the people are where they belong and the things round about where that house stands are different and the client's things are where he put them, individuality will come through notwithstanding such prefabrication as is advantageous.

Prefabrication and standardization are two different things and yet they belong together. They're going to stand together. We're going to have them together.

You can standardize almost anything but unless you know how to keep life in it by good design, it will be more or less a quantity thing. Now a quantity thing is never going to take the place of the quality thing. But we know well enough now (I as an architect say this to you advisedly) to put quality into quantity up to a certain point. It can be done only by an inspired sense of design. It's not common and never will be. It's not in the magazines. It's not something you pick up in the street.

Good design is something you have to go in for carefully—not too sure of your own "taste". Good design is something precious and rare. Of course we're a taste-built culture. We have had no knowledge concerning taste. If you have been to a university or your children have been there, they have grown up in a haphazard environment. I think probably some regents should be taken out and shot just for their taste. University buildings were built by somebody's taste, nobody's knowledge.

You are likely to get into the same rut by taste. This still new engine called prefabrication is of course a dangerous engine. Anything vital, living and competent has a dangerous side. There is nothing more dangerous than Truth, nothing more to be dreaded if you are in the wrong. And here we are in our housing projects, the developers merry, ignorant of quality, desirous of quantity at so much per unit. But what of the human element (spiritual element),

the element of the man himself? Look for it! Where do you find it? You won't see it in the big projects. It has been left out. Whose fault is that? It isn't the fault of the builder. It's the fault of the man who buys that project house and consents to live in it. He can groan and complain and think he might have had more for his money but there he is. It isn't how much house you get for your money, it's the quality of what you get. Now if we could set that kind of thinking going we would really be what you might honestly call on an economic basis.

We boast of having the highest standard of living in this world. I'm afraid that when we say the highest we can only claim the biggest. Quantity is not the same thing as quality. You can have "the highest" standard of living when it isn't half so big. Now the question should be how do we improve the quality? How do we preserve and then how may we use quality?

Quality is a characteristic of the free man. Are buildings going to be subject to the deadly routine of conformity? The cheapest thing you can get in the cheapest way without consideration of quality and with no real knowledge of what constitutes quality? If so, then we are the biggest, shortest-lived civilization in history. And the atom bomb (what do you call it now?) might as well drop, because I don't see anything particularly admirable or desirable to stay here for. I think we might just as well kiss it all goodbye.

There is only one thing that makes life worth living to an American and that is the highest, the bravest and the best of everything there is available right down the line. Take no less, know what is the best; know what is really good, have knowledge.

Know why a house is good, know that the proportions belong, know that the building looks as though it belonged there where it is and couldn't be seen anywhere else, and shouldn't be. Know a building's charm—the kind of appeal that good comfortable clothes have, the way good shoes fit you. That's the good house. That is the quality house. That's organic architecture and it means: according to nature, to the essential intrinsic character of everything. Not just trees, flowers and out-of-doors, but the actual inner life of everything. In man it would be soul.

Only as science becomes as one with the spirit of man can a culture or a civilization live indefinitely. Science can take things apart, but only art and religion can put them together again—to live.

This really is at the base and the very center of good design by prefabrication, which means the appropriate use of an enormously effective instrument, the machine as a tool, to better the conditions of all human life. Our schools have to change their concept, training our architects to deeper nature study. We can't blame the professions or the builders or the people who buy homes. The thing I am talking about has to come into society, has to come to us by way of a greater consecration to life itself and by a deeper and more serious feeling for beauty.

Henry Mencken said: "Americans seem to have a lust for ugliness". Look at the poles and wires devastating our landscape. See the buildings we build violated by them. Everything we have sees no consideration for beauty, nor much for life. We need to join together to make environment beautiful.

We have raised the flag to the spirit of man. Until science, vision and art become as one, there is no rest or peace for humanity. /END

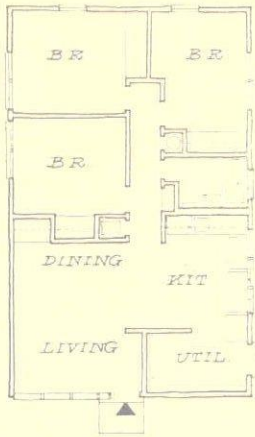

Here is how Honn kept improving the basic plan...

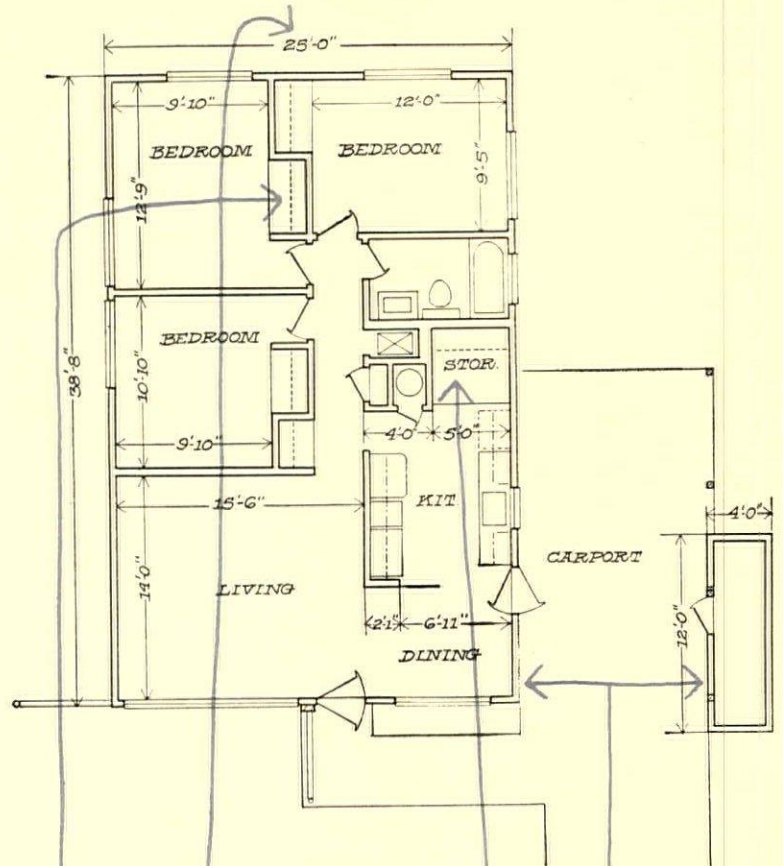

1956

Honn made 10 changes in the basic plan (preceding page, and repeated small size at left, above):

1. He widened the house one foot to 25' and lengthened it 8" to 38'8". This added 60 sq. ft. of floor space.
2. He added a 48-sq. ft. outside storage unit. This brought the total area of the house to about 1,020 sq. ft. (vs. 912 in the basic model).
3. He redesigned the kitchen to hide the work area from the living room and make it more convenient.
4. He moved the storage room to less valuable space, which made room for a dining area.
5. He arranged water heater, furnace and linen closet in a compact unit requiring less total space.
6. He moved the living room closet to a more accessible location in the hall.
7. He gained space in the bathroom for a 3' vanity.
8. He widened the carport from 10' to 12'.
9. He moved the center partition between rear bedrooms to the center of the house, to make framing easier.
10. He lowered the roof pitch to cut down the height of interior partitions.

These changes raised the cost of the house \$1,400. But its \$9,600 price, including lot, came to only \$9.41 a sq. ft.

And here is how Jennings kept on selling it...

54 sold in 1956



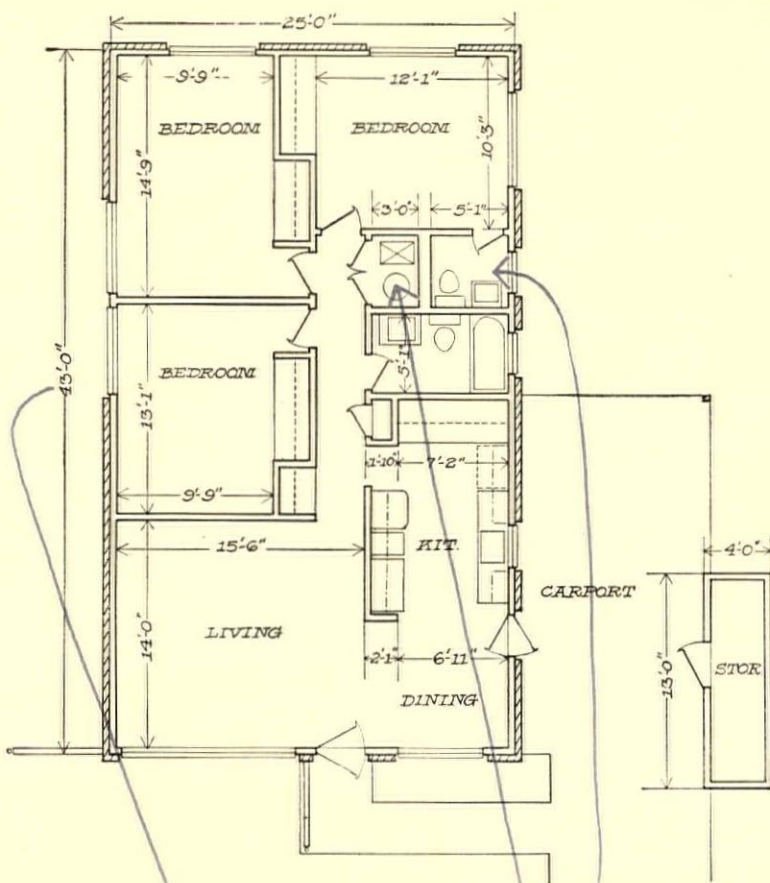

1957

Last year Honn made many improvements, almost all dependent on each other:

1. Again he expanded the house—this time from 38'8" deep to 43', adding another 110 sq. ft. of space.
2. He replaced Texture 1-11 plywood exterior siding with face brick. Thus exterior dimensions increased several inches more.
3. He added a half bath off the master bedroom.
4. He took space from the storage room to widen the dining room and provide room for the half bath.
5. He provided more closet space in all three bedrooms (more desirable storage than in a storage room).
6. He deepened all three bedrooms 2'.
7. He moved the water heater and furnace to a spot backing up on the half bath. Thus these units and the two baths formed a compact rectangle, simplifying plumbing.
8. He provided for plywood paneling along the 14' wall in the living room.
9. He provided for mahogany cabinets in the kitchen.
10. He lengthened the outside storage unit from 12' to 13'.

These changes raised costs sharply. And the house went on lots costing \$350 more. But at \$11,650, this 1,134 sq. ft. model still cost only \$9.84 a sq. ft.

61 sold in 1957

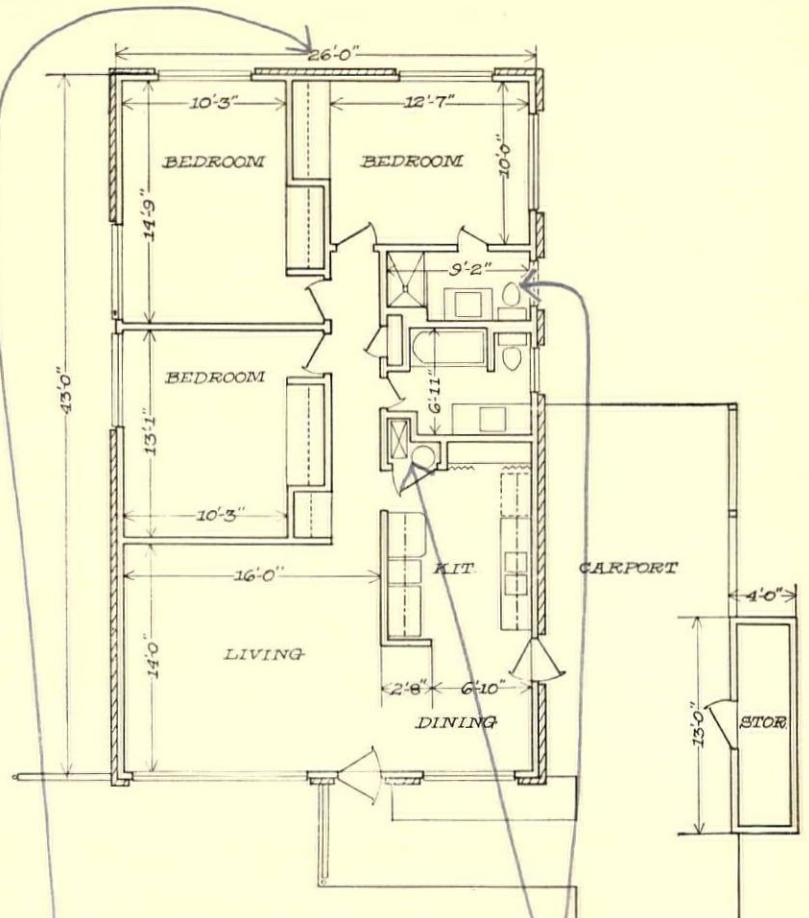

1958

This year Honn again made 10 improvements, some of them major, though the original plan is still recognizable.

1. He widened the house another foot to 26'. This adds another 43 sq. ft. of floor space.
2. He provided two full baths.
3. He expanded the first bath by 10 sq. ft., permitting a larger vanity and a toilet compartment.
4. He added a tiled shower, medicine cabinet and vanity in the second bath.
5. He designed the furnace so return air can be brought into the side. Now furnace and water heater are relocated in only half as much space.
6. He moved the linen closet closer to the bedrooms.
7. He added another 6" in width or length to all bedrooms.
8. He eliminated the kitchen window, to provide almost twice as much cabinet space.
9. He added 7" to the short wall between kitchen and dining room, thus hiding the range from dining-living area.
10. He replaced awning windows with horizontal sliding windows to give more protection in the windy climate.

These changes bring the 1958 house up to \$12,300 (including \$1,500 lot and \$100 for a community swimming pool). But with 1,230 sq. ft., it still sells for only \$10 a sq. ft.

To look inside the 1958 house, turn the page . . .

35 sold in first two months of 1958





\$12,300 CONTEMPORARY can have textured brick wall at front in place of windows used in version shown on preceding page.

Here is why the 1958 Honn-Jennings model

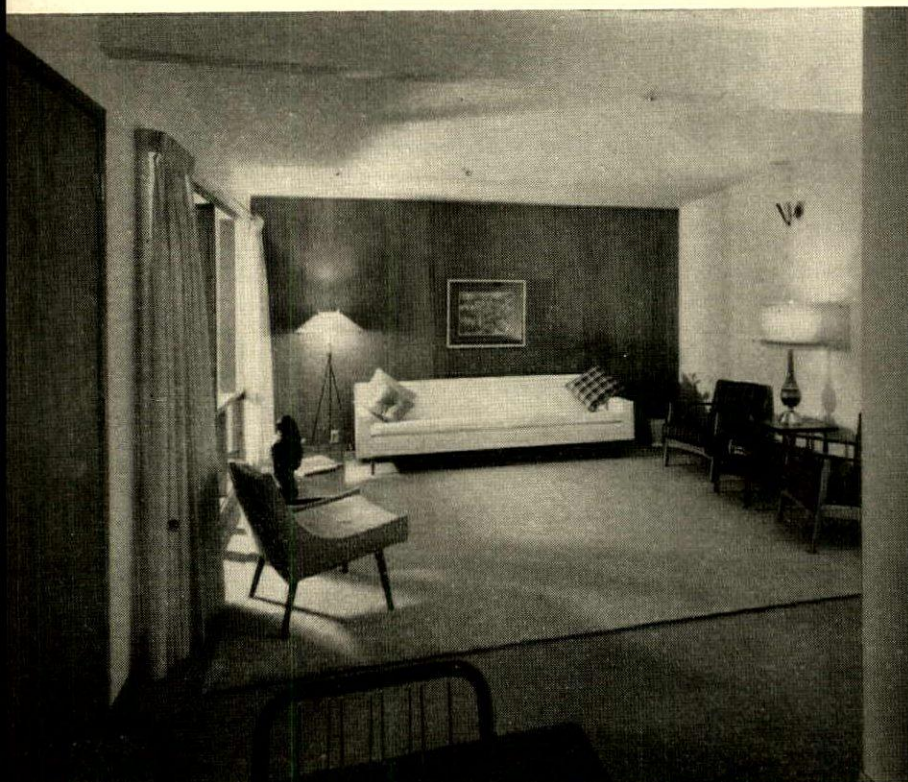

LIVING-DINING AREA was furnished differently in two houses to show buyers that either contemporary or colonial furnishings will fit well.



One side of living room has 8'-high mahogany plywood paneling. In earliest model, living room opened directly on kitchen.

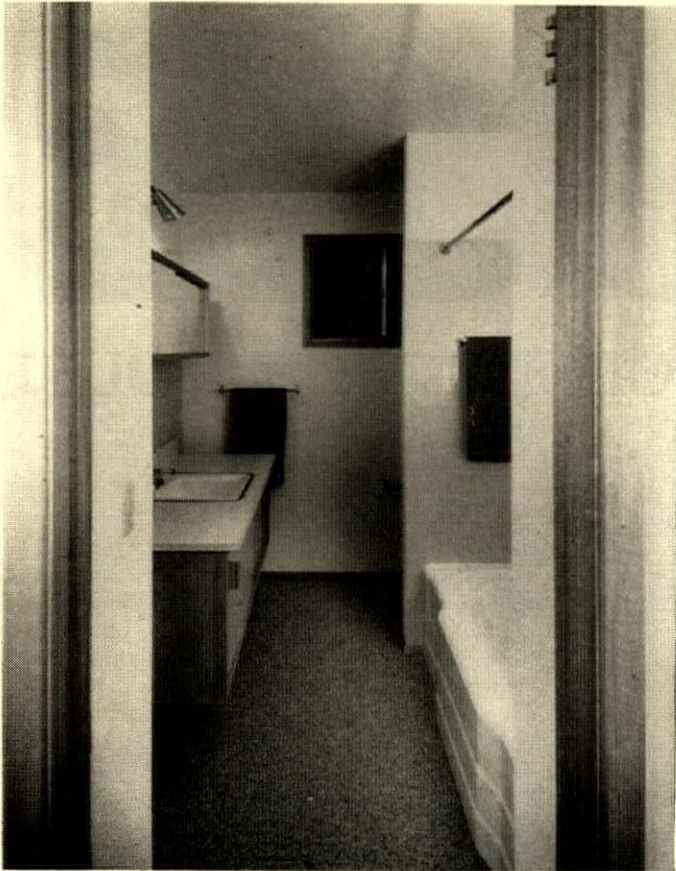

TWO FULL BATHS are a major feature of new model. Each has wide vanities and mirrored medicine cabinets. Bath at left was changed by

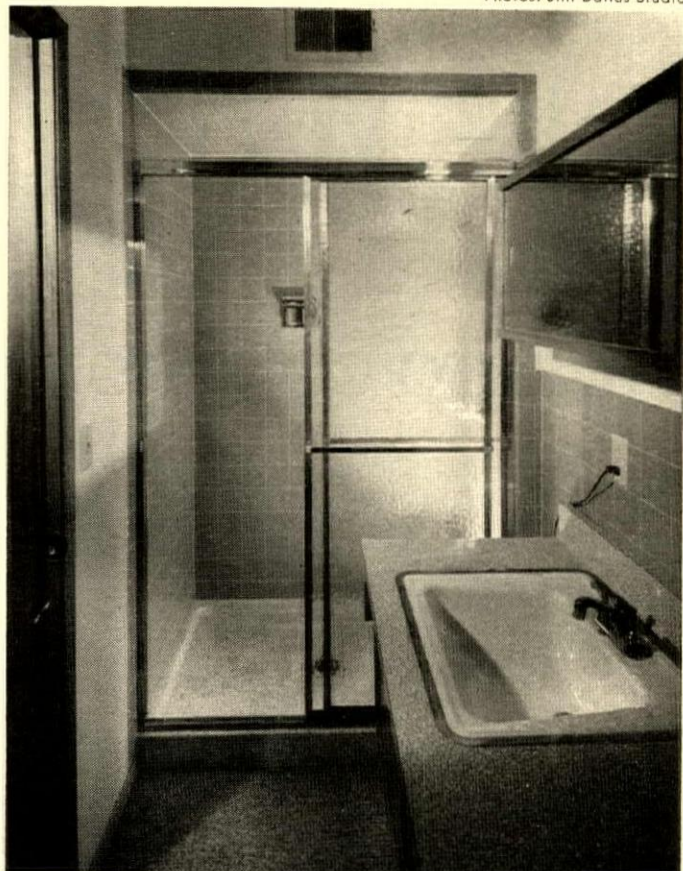

moving tub from under window and hiding toilet. In new bath at right, later houses will not have furring over shower, which will save \$40.

is selling better than ever

It is no accident that these pictures reflect Builder Jennings' good construction as much as Architect Honn's good planning. Jennings made a reputation building big houses (up to \$100,000) long before he got into the low-price field. Half his business is still in the \$16,000-up class where a reputation for quality counts most heavily.

"If you want to build houses in all price brackets," he explains, "all your houses must get a name for quality."

Honn agrees: "Builders who do a good construction job always sell more houses. And the quality of finish in Jennings' small house is like the finish in a \$20,000 house."

For the past two years Jennings' sales have been strong at both ends of the market. He sold 114 houses in 1956 and 125 last year, is Lubbock's biggest home builder.

Jennings' principle for success:

"Stick with a good idea"

Here are three ideas he's convinced are good:

1. Retain a top-notch architect.
2. Keep using a good plan. "Honn's basic plan for a small house has paid off, and I haven't had to change designs with every shift of the wind."
3. Apply the same good construction methods to low-price houses that you do to high-price houses.

Jennings panelizes all his houses. He feels that this is one big reason he has not priced himself out of the market despite his steady upgrading of the original Honn plan. /END

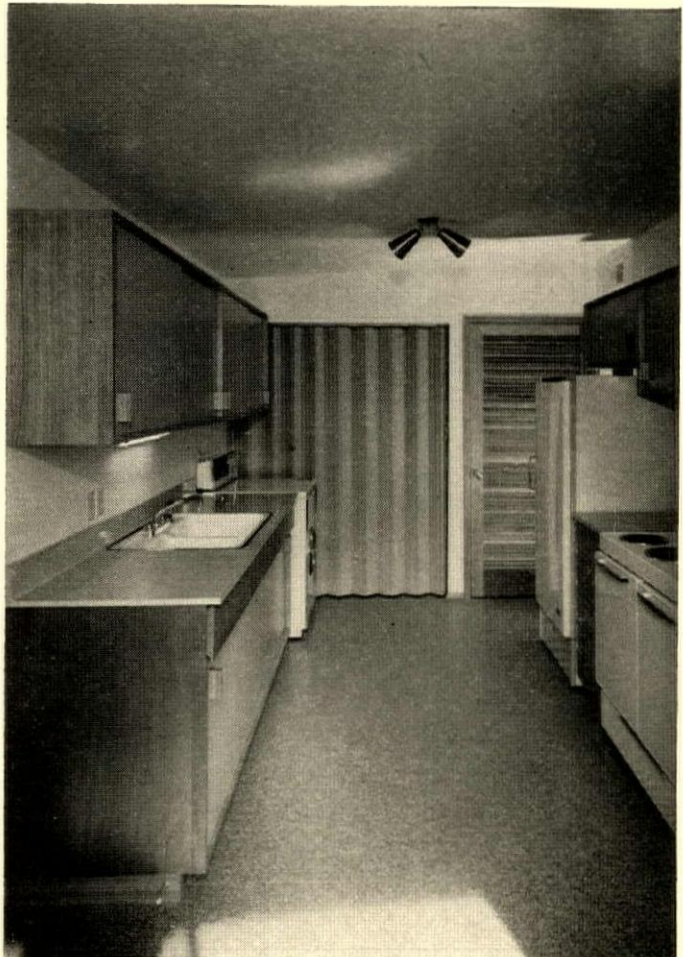

KITCHEN, viewed from dining area at front of house, has 10' mahogany cabinet. Folding door hides storage.

NOISE

HOW TO CONTROL NOISE IN THE HOUSE

There are more noise makers than ever inside today's house—more television sets, radios, washers, dryers, vacuum cleaners, air conditioners, power tools.

There are more noise makers than ever outside the house—more mowers in the yard, cars in the street, airplanes overhead.

So more home owners than ever are becoming aware of noise, and the time is close—if it isn't here—when all architects and builders will have to do more about noise control.

Can something effective be done? The answer is yes. The science of acoustics is still relatively new, and not all the experts agree on all its finer points. But on the next nine pages you'll find a simplified approach to noise control: How to break the big problem into four easier-to-handle problems (opposite); How to attack these problems with the right kind of plan (page 130), the right kind of structure (page 132), and the right kind of room finishing (page 134).

First, use this chart to find out how much control you need

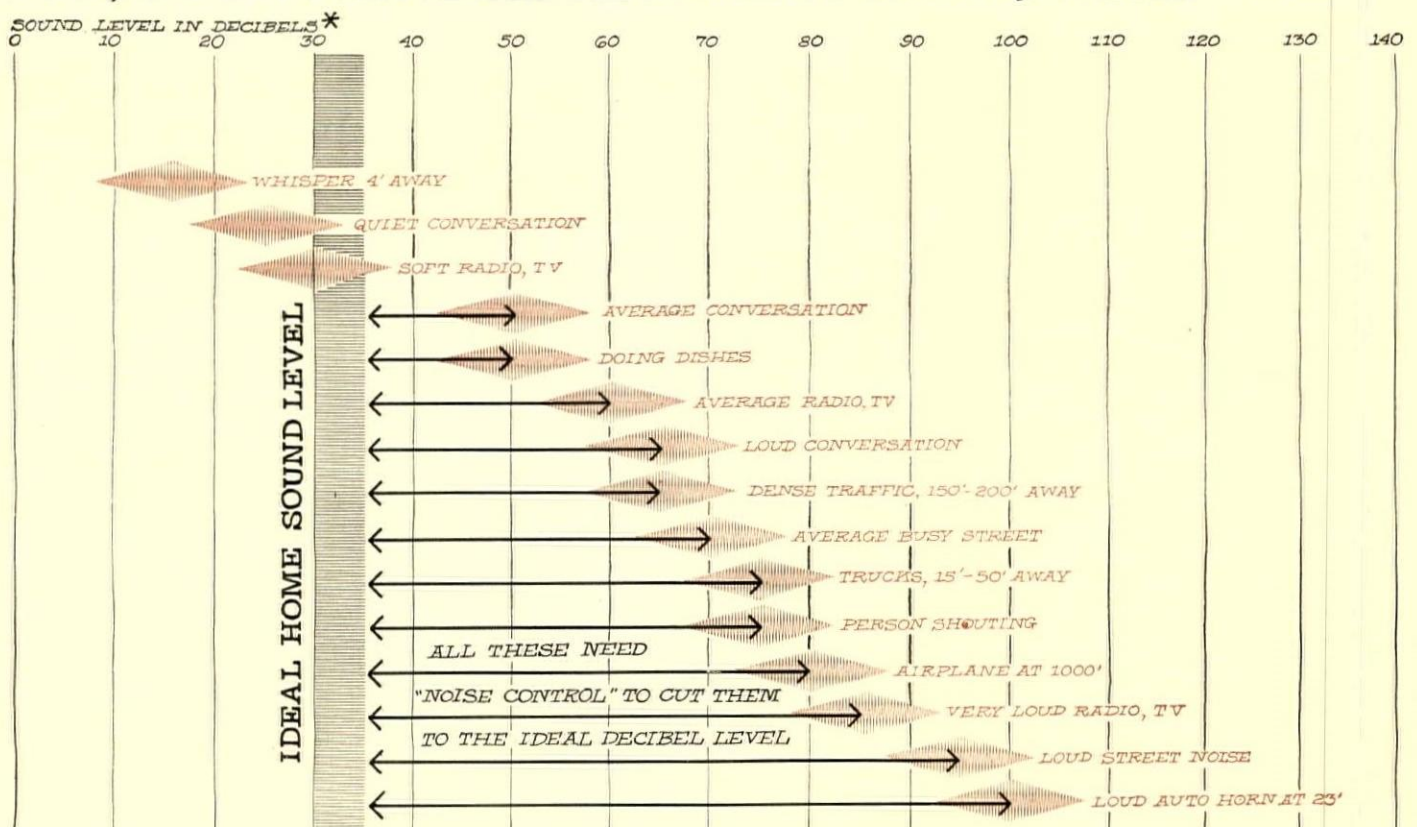
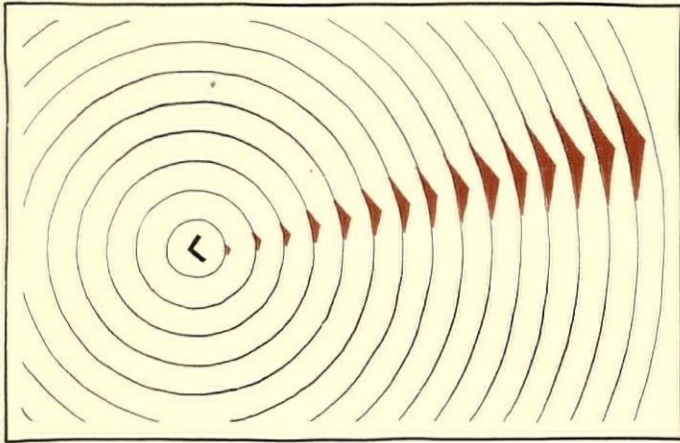

Chart shows how loud (as measured in decibels) common noise makers around the house are. It also shows how much noise reduction (in decibels) is required to bring these noises within the "ideal home sound level." And as you'll see later (p. 132), the ability of a wall (or other structure) to block noise (its "decibel loss") is also measured in decibels—so this chart can help you relate different noise problems to possible solutions. For example, the chart shows that "soft-radio, TV" has a noise level of 30 decibels—no noise problem. But an "average radio, TV" has a level of nearly 50

decibels—25 to 30 decibels above "ideal"—so you will have either to isolate the noise maker in your plan or surround it with walls that can block at least 30 decibels. It pays, when you can, to match noise problem and noise control (in decibels) as closely as possible, because using too heavy a wall is needlessly expensive, and using too light a wall won't do the job. The average range of noise levels shown on the chart can be used to estimate how loud *other* noise makers are. More accurate measures are not yet available because to date little has been done to measure residential noise.

*Decibel levels shown are a range of sound level produced at a design standard of 500 cycles per second. The decibel scale is logarithmic, not arithmetic. A 10-decibel increase in noise level corresponds to a 10-fold increase in sound intensity.

Then if you know how noise travels . . .



Sound in open air spreads outward in all directions, drops 6 decibels in level for each doubling of the distance from the source. Sounds are waves of air pressure ranging audibly from 16 to 16,000 waves or cycles per second.

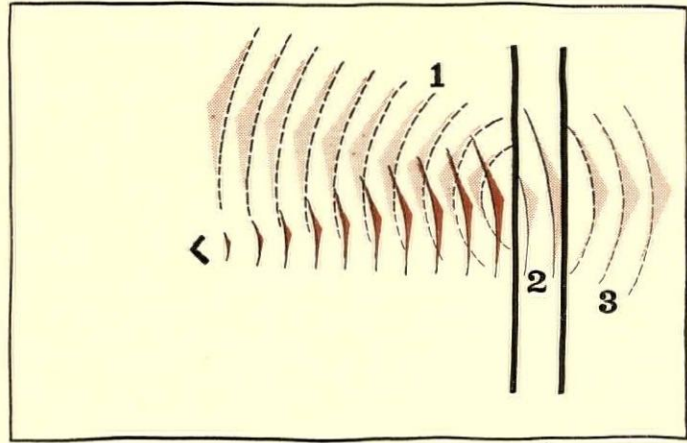

Sound striking a wall is partly reflected back into the room (1), partly absorbed by the wall (2), and partly "transmitted" (by setting up vibrations in the wall) into the next room (3).

. . . you can break the problem down into four simpler problems

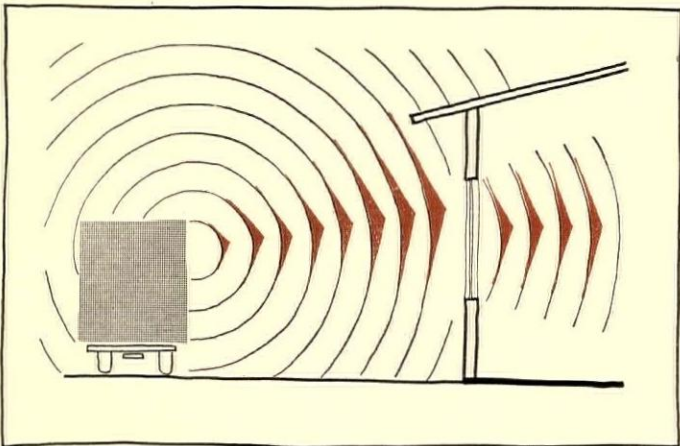

1. Blocking outside noise is difficult because windows transmit a lot of noise no matter how heavy the walls and roof are. Controls include orientation of the house, walls, trees and shrubs close to the street.

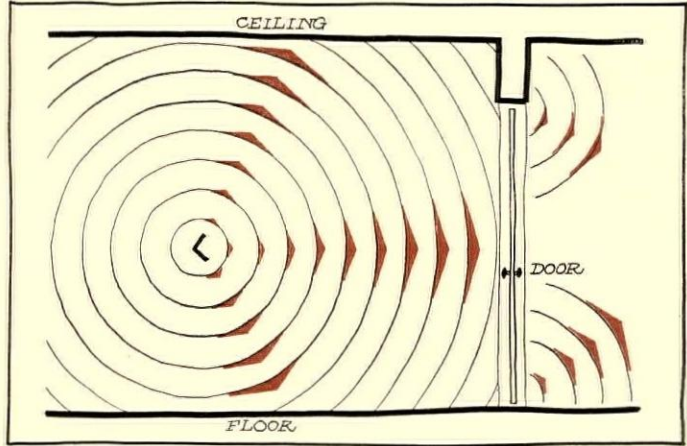

2. Blocking noise between rooms is the biggest problem in most homes. Noise travels through walls, ceilings, and floors, will flow through tiny cracks around doors. Isolating noisy rooms from quiet ones helps.

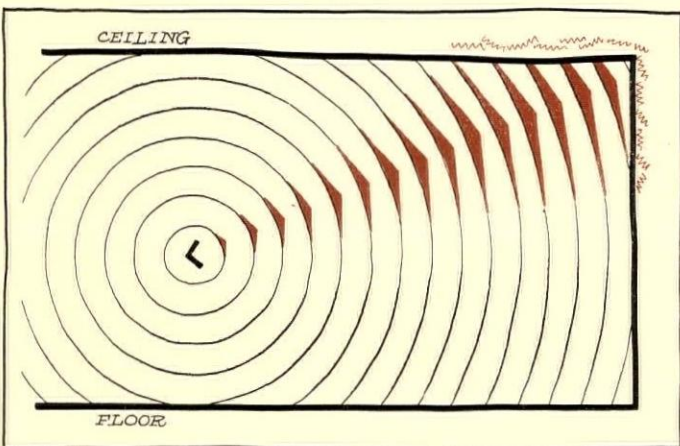

3. Controlling noise within a room is a problem of controlling reverberation—sound bouncing back off walls, floors, and ceilings. Hard surfaces will reflect up to 98% of sound waves hitting them. Biggest single help: acoustical materials.

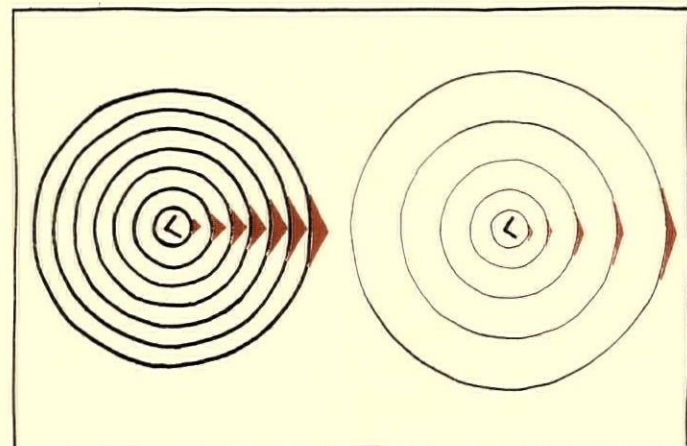

4. Quietening the noise source is the ideal solution to noise control. Everything you can do here makes the total job of controlling noise easier. Use of quiet flushing toilets, rubber pads under appliances are examples.

You can attack these problems at three stages of house planning

turn the page

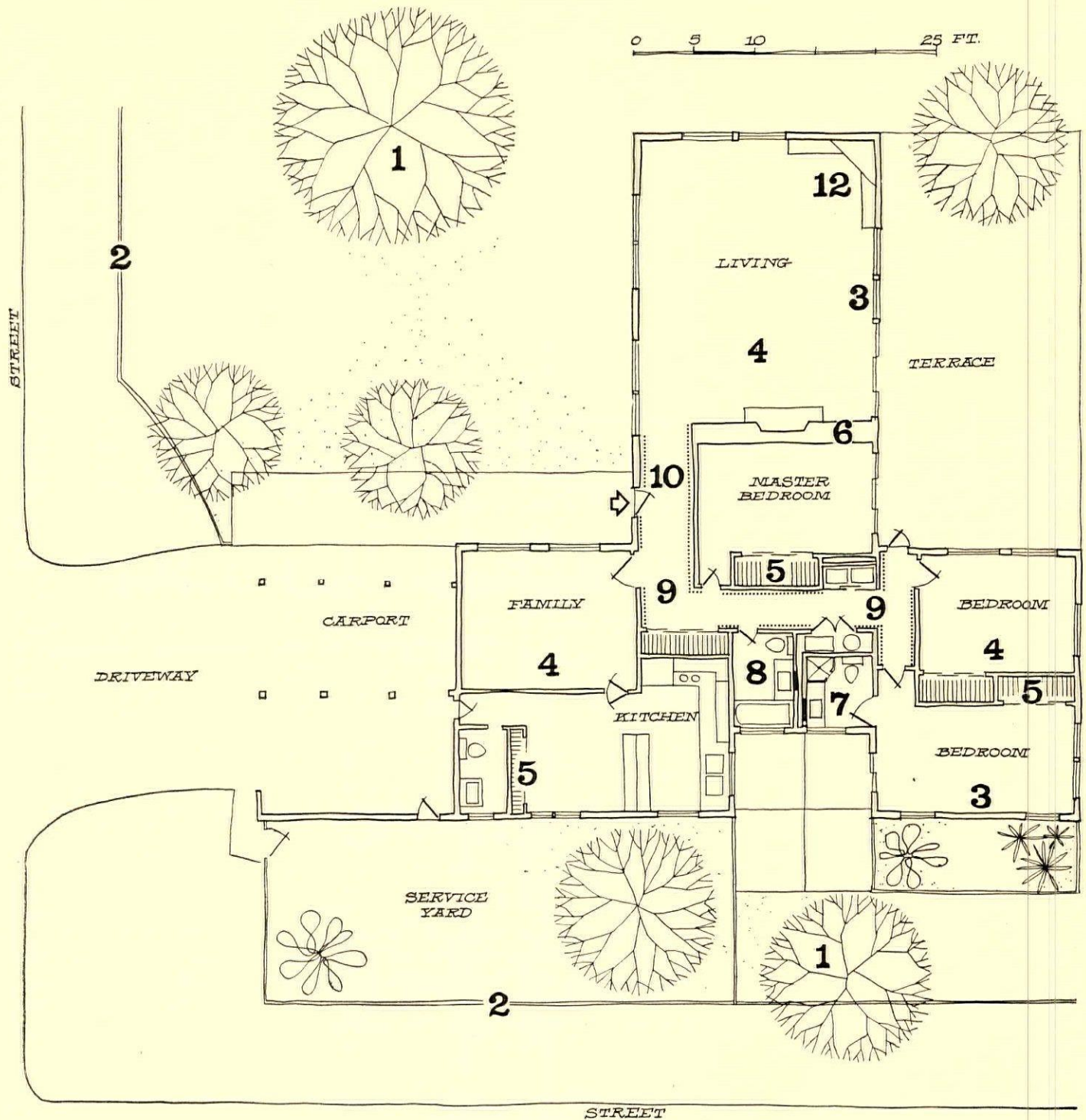

ALMOST IDEAL PLAN for a quiet house shows how noise travel can be controlled in planning stage. Numbers relate to text.

Your plan can bar outside noise, bottle up inside noise

Whether you are planning a custom house or a low cost merchant builder house, the ideas listed here will help you control noise. How many of them you can use depends on how much you can afford to spend for good noise control.

(Many of the ideas listed highlight a basic principle of planning an acoustically sound house: avoid unbroken expanses of parallel surfaces which can bounce noise back and forth. This is why large wall surfaces should be broken up with furnishings, closets, or bookshelves. This is why, ideally, the floor should have a rug, and the ceiling should be acoustically treated and be sloping rather than flat.)

1 Trees and shrubs can break up and help block street noise. So it makes good sense to preserve them during construction. Trees close to the street are more effective in controlling noise than trees close to the house. A thick planting of bushes or a high hedge is especially effective.

2 Patio or yard walls at least four feet high do an even better job of cutting street noise than trees and bushes. Block, brick, adobe or stone walls are more effective than wood walls because of their greater mass.

3 Orientation of the house to the street is all-important. The busy areas of the house should face the street. If quiet areas of the house like the bedrooms *must* be on a street side, they should present as solid a wall as possible to street noise. The most open side of the living area should face into the lot. Where one side of the living room must be on the street side, its wall should be set as far back from the street as is practical. And its window area should not be too large—since windows let in a lot of noise.

4 Zoning of the house should put the bedrooms and the living room as far as possible from busy areas. Ideally, the family room, dinette and kitchen should be located in one wing, bedrooms in another, and living room in still a third.

5 Closet walls make very effective sound barriers between rooms. Full of clothes and with the doors shut, a closet wall reduces sound transmission like a very complex partition built of many layers. Closet walls in the plan at left keep bathroom and hallway noises out of the master bedroom, acoustically isolate the other two bedrooms from one another, keep noises from the mudroom (the half bath off the carport) out of the dinette and kitchen, and keep kitchen noises from traveling down the hall to the living room.

6 Fireplace walls can isolate the living room from the bedrooms. A 13" brick wall with plaster on one side cuts noise transmission about 55 to 60 decibels. If there were no fireplace opening in the wall (and workmanship and structural isolation were perfect) a very loud conversation in the living room could hardly be heard in the master bedroom (see plan left.) Even with flue and fireplace openings in the wall, living room music or conversation will be cut to a whisper through the wall. (The construction of this kind of masonry wall is important—its sound reducing value can be increased considerably if its mass is broken up into two or more thicknesses of brick.)

7 Medicine cabinets (detailed at right) in double bathroom partitions should be offset from one another and either backed up with some solid material or mounted outside the wall. The cabinets, if placed back to back, will transmit almost as much noise as an opening from one bath to the other. Electrical boxes should also be offset, for the same reason (detail, below right.)

8 Double walls between bathrooms are best constructed with two sets of studs, as at right. A single wide stud (say a 2x6) actually assists in transmitting sound from one bath to the other. Whenever possible, water, waste and vent lines should be isolated from the structure.

Details, right, from "Acoustics for the Architect," Reinhold Publishing Co., New York, 1957.)

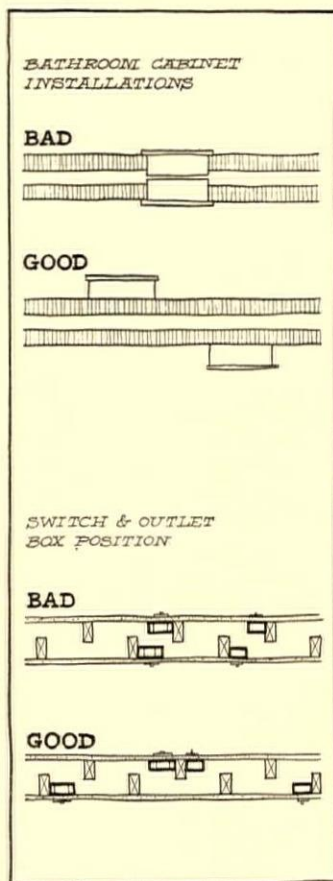

9 Bends in hallways prevent noise from booming down the hall as though it were a speaking tube. Walls in the hallway in the plan at left are lined with acoustical material (shown as dotted line against wall) to eliminate reverberation which can be particularly annoying in a long narrow space. In the plan opposite, family room sounds do not have a free passage to the bedroom wing, and will not bounce down to the living area because of the acoustical treatment in the hall. And bedroom doors do not open on a straight passage to the living area, which is desirable.

The furnace room and the laundry (opposite each other in the bedroom hall) must be treated very carefully. The equipment in these two rooms should be mounted on rubber pads, the walls and ceiling should be lined with acoustical material, and the doors should fit as snugly as though they were weather stripped. Grillwork in the furnace room door should be backed by a baffle to help block furnace noise.

10 Front door should never open directly into the living room, and if possible should not be in a wall parallel to the street. Even shut and weather stripped, the front door won't keep out as much noise as the exterior wall. The hall near the front door should be lined with acoustical materials to eliminate reverberation.

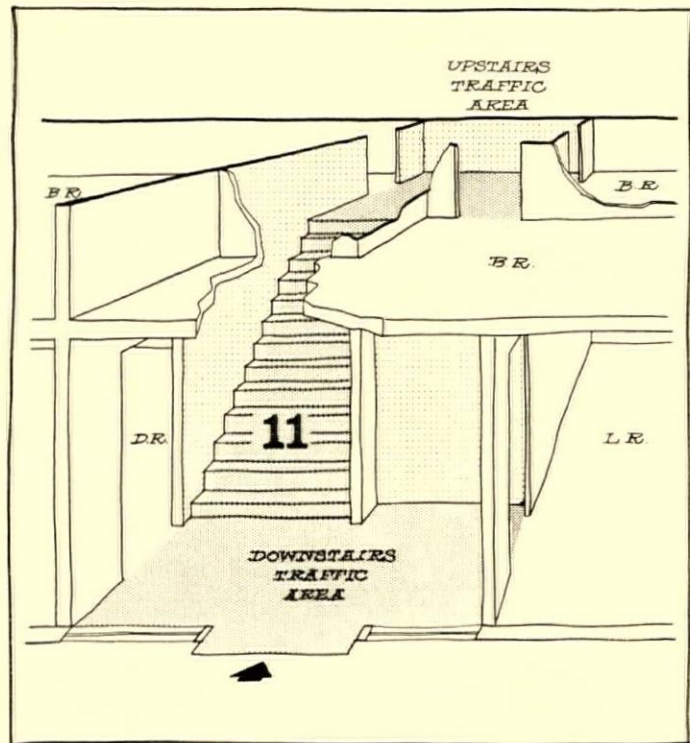

11 Stairwells (above, but not in plan opposite), act like horns in carrying noise between floors. Ideally, a stairwell should open to a traffic area (or short hall) on both the first and second floor. If the stairway must start in the living room, it should turn at a landing, so there is not a straight noise path up to the second floor. The stairwell itself should be lined with acoustical material. And a stair carpet on the treads helps cut down reverberation.

12 High fidelity is located in the living room in the plan opposite, so this is the one room where acoustical tiles might be omitted. Music—either played or reproduced—sounds better in a relatively "live room" in which sound bounces off the walls and ceilings before reaching the listener's ear. (Most concert halls are "live".) Rugs, drapes, furnishings and people usually provide just about the right sound absorbency in a music room to give a "concert hall effect." Of course, this is true only when the equipment has been properly positioned.

To see how structure controls noise, turn the page

Your structure can block noise travel through the house

How well the walls, roof, and floors of a house block noise depends on their cross-section. Generally, as the density of a wall increases, its ability to stop noise increases. The reduction in noise level between the noisy side and the quiet side of a wall is called its "decibel loss."

Decibel loss ratings (for average 500-cps. sound) for many different wall, roof, and floor cross-sections have been measured, and some are shown on these pages. With these

ratings you can figure roughly what kind of wall, roof, or floor you will need to do a particular noise reduction job. Suppose, for example, that your house will be on a busy street. The outside noise level will be about 70 decibels. To reach the desired inside noise level of 30 to 35 decibels, you'll need to use an exterior wall section with a decibel loss rating of *at least* 35 to 40 decibels (and probably much higher because of noise coming through windows).

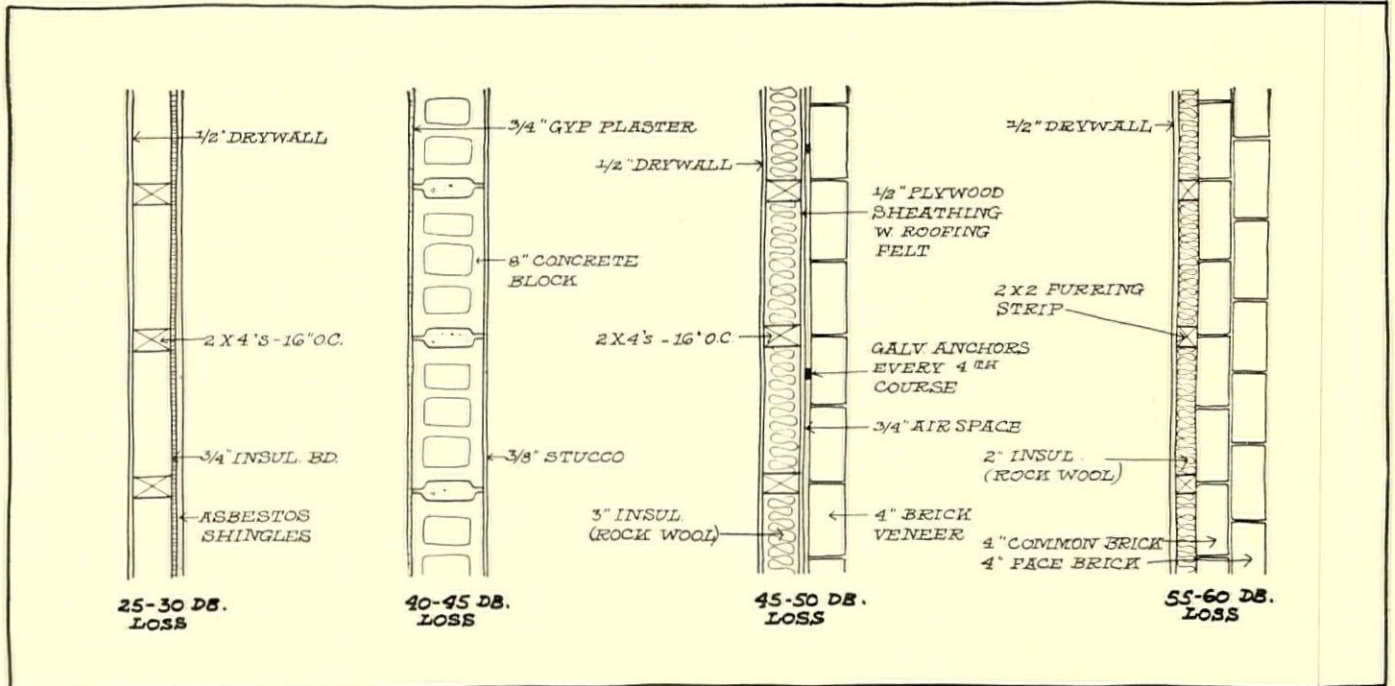

Exterior walls play a major role in keeping outside noise out. The details above show roughly how much noise reduction in decibels you can expect from four typical walls. Generally speaking, these sections will block high-pitched sound more effectively than low-pitched sound. (Happily, low-pitched sounds are less annoying to most people.)

In choosing an exterior wall to solve a particular outside noise problem, allowance must be made for the noise that

will be transmitted by windows. Windows, because of their thinner, lighter section, let in much more noise than the wall itself, and the noise let in by the wall as a whole is much more than would be indicated by a simple apportionment of window and wall area.

On the other hand, when choosing an outside wall, remember that trees, shrubs and patios walls can help cut outside noise, may permit use of a lighter wall.

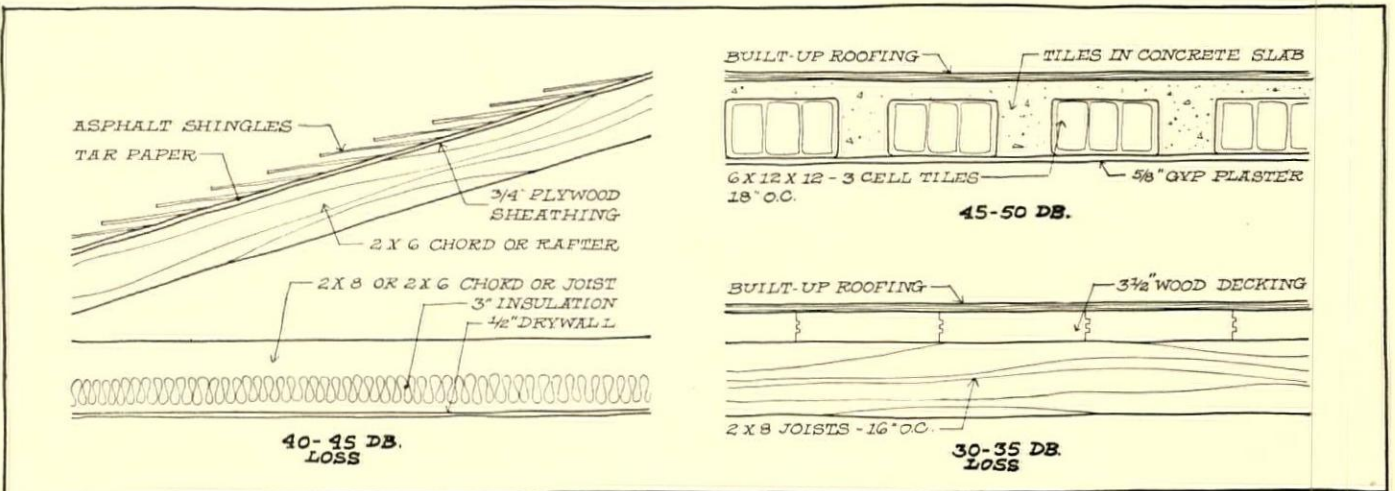

Roofs are as important as exterior walls in blocking outside noise.

A low-pitched roof will transmit almost as much street noise as the wall facing the street. And even a flat roof will transmit street noise, because the sound waves travel up through the wall-to-roof connection and start the roof vibrating. (Theoretically, airborne sound is not transmitted: it starts a vibration in structural parts which in turn starts

another airborne sound wave inside the house.)

The decibel loss figure for the pitched roof is very rough; the bigger the roof, the higher its decibel loss will be (so on a small house, wide overhangs will help slightly in cutting inside noise levels.

Truss roofs will transmit slightly more noise than roofs with rafters because there is a more direct connection between roof members and ceiling members.

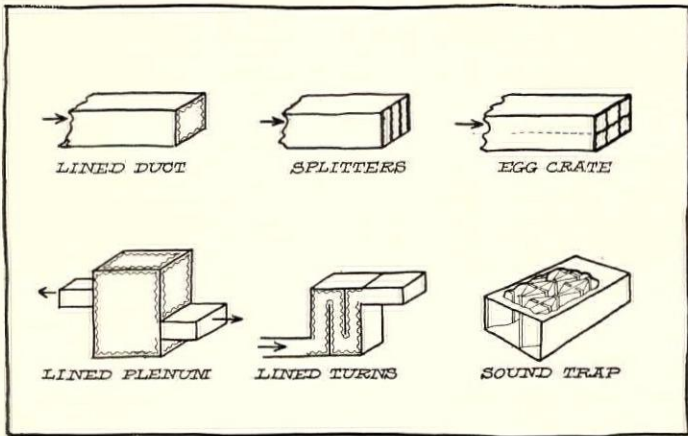

DOORS, WEATHERSTRIPPED SOUND REDUCTION

OAK - 1 3/4"	21 DECIBELS
1 3/4" HOLLOW CORE	25 "
LIGHT BIRCH VENEER	20 "
STEEL CLAD	48 "

WINDOWS, WOOD OR ALUM. FRAMES

1/8" DOUBLE STRENGTH	21-25 DECIBELS
1/8" DS, W 1/8" DS, STORM SASH, 1"-2" SPACE	30-36 "
1/4" PLATE	22-28 "
1/4" PLATE, W 1/4" PLATE STORM SASH, 1"-2" SPACE	32-40 "

NOTE: DOUBLE-GLAZED WINDOWS (EG. THERMOPLANE, TWINOW) TEND TO ACT LIKE A SINGLE PIECE OF GLASS AT LOWER FREQUENCIES, LIKE TWO PIECES OF GLASS (WINDOW WITH STORM SASH) AT HIGHER FREQUENCIES.

Ducts act just like speaking tubes, carry noise from one room to another. The details above show six ways this noise transmission can be reduced. All of these techniques are designed to cut down reverberation so that noise will not bounce freely down the length of the duct. The sound trap is a highly effective commercial product (Koppers Co.) soon to be available for homes. It is specifically designed to block noise coming from air conditioners and furnaces.

Doors and windows let in more noise than any other part of the house shell. There are two reasons: 1) they are lighter in weight than the walls around them, and they almost always have cracks around their edges (and noise can pour in through the tiniest crack). The ratings above are a fiction unless the doors and windows fit tightly.

(Drawing above left and data above from "Acoustics for the Architect," Reinhold Publishing Co., New York, 1957.)

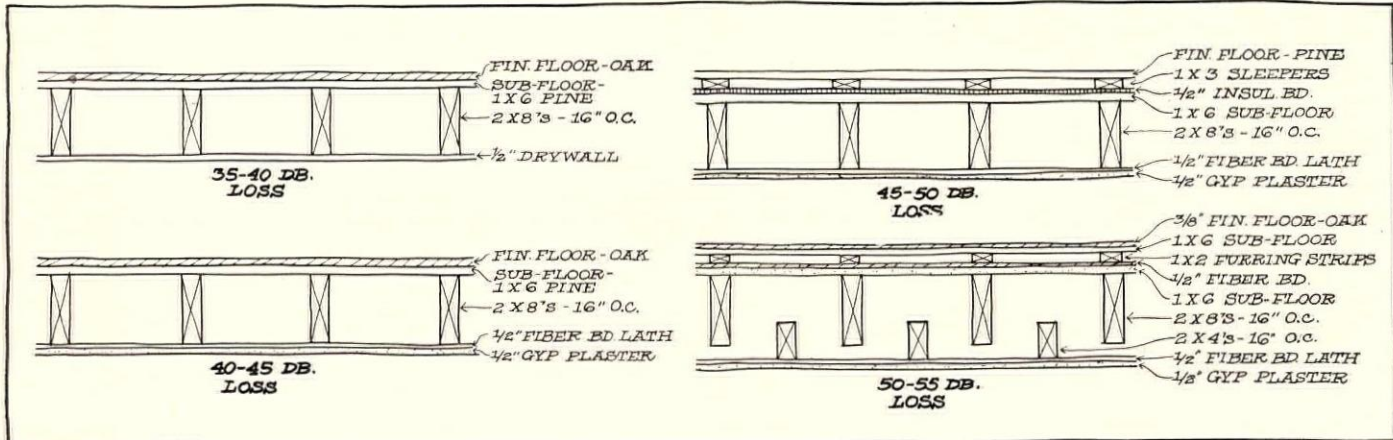

Floors are a critical part of noise control in any house built on more than one level. In a spread-out slab house, the plan can be zoned to separate noisy rooms from quiet areas, as shown on page 130. But in a two-story house, the floor between the two levels must zone the upstairs bedrooms from the kitchen, living room and family room. And in any house with a basement, the floor must do most of the work of keeping furnace, workshop and playroom noise where

it belongs and out of the living areas above. In choosing a floor for a two-story house, remember that the stairwell is likely to be the weak link. It doesn't do much good to build a heavy multi-layered floor that can cut 50 decibels in the family room to a hush in the bedroom above if there is a stairwell just outside both rooms.

(For optimum design of stairwells, see page 131). Acoustical treatment will help reduce the "horn effect."

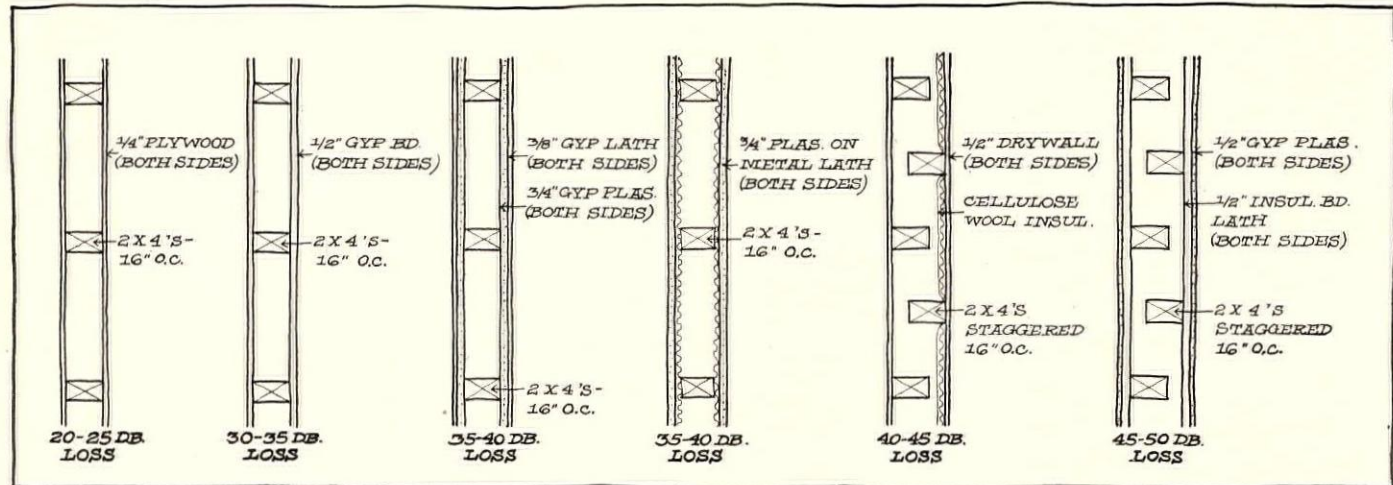

Interior walls have to do almost all the work of blocking noise transmission between rooms. Yet most interior walls are lighter than any other part of the structure. As a general rule, when you double a wall's mass you cut the sound transmitted by five decibels.

One way to build an interior wall that will cut sound without being overly massive: build it with air spaces between a number of layers. In any wall there is a sound

transmission loss at each interface. The more interfaces there are, the greater the wall's decibel loss.

But no matter how good the wall itself, for maximum noise reduction it must be sealed against sound leakage at the floor, ceiling, and outside wall; the whole structure must be stiff, doors must fit tightly. Ideally, the joists, studs, plates and sills of one room should be isolated from those of the next room.

To see how to finish noisy rooms, turn the page

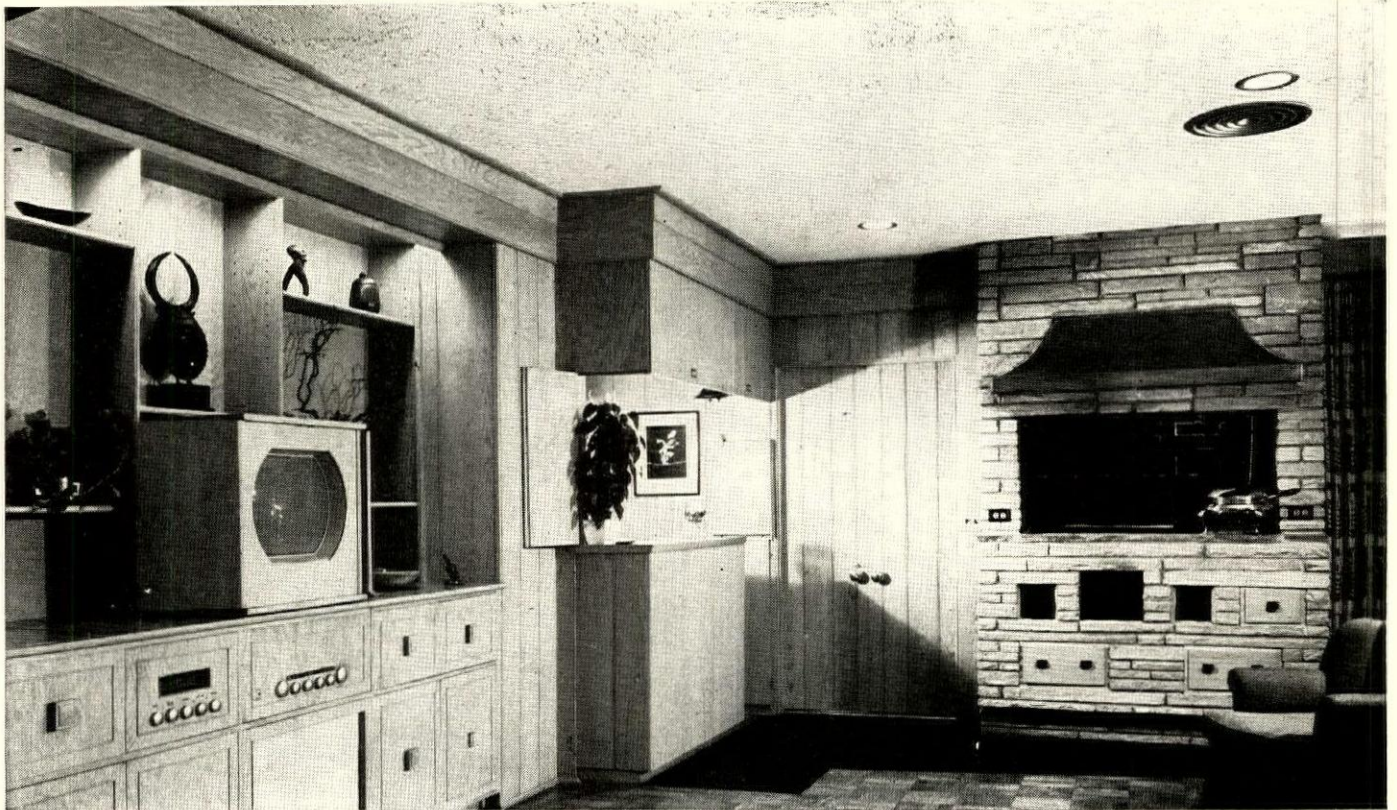

Family rooms, where most people keep the television and hold their parties, are a tough noise control problem. Not only are they noisy, but they usually have hard surfaced walls and floors that make cleaning easier but bounce back

up to 95% of the sound striking them. An acoustical ceiling (the one in this room is fissured mineral-fiber tile) can cut this reverberation sharply, make the room seem much quieter. Built-in shelves help break up sound reflections.

Your finishing touches can absorb noise in busy rooms



Kitchens rate special treatment. The equipment and activity in them is relatively noisy, and hard surfaces are everywhere. To cut down vibration noise, dishwashers, refrigerators and other equipment with rotating parts, can be



mounted on cork or rubber pads. Breaking up wall surfaces with cabinets and counters helps cut noise. Acoustical ceiling tiles are a big help, but should be a type (like plastic surfaced tile in photo left) that can be wiped clean.



Workshops can be noisier than all the other rooms of the house put together. While acoustical treatment can do nothing to cut noise traveling direct from the machine to the operator's ear, it can cut reverberation and make the room a more pleasant place to be in. And the acoustical treatment will make the noise seem less persistent in adjacent rooms. By diffusing sound, the pitch of the ceiling helps greatly in reducing the apparent noise.



Bathroom noise can be softened by using rubber or vinyl resilient flooring in combination with an acoustical ceiling. In bathrooms, the ceiling should be cork acoustical tile or other material which will not be damaged by moisture. Plastic or ceramic wall tile and other hard finishes used in baths mean high reverberation, so reducing noise at its source by using quiet-flushing toilets, mercury switches and screen diffusers in water taps is worthwhile.



Playroom noise can be extreme, especially if the room is in the basement, as above. Block or concrete walls can be covered with acoustical wallboard; the ceiling with acoustical tiles. A rug would help this room.



Hallways can act like speaking tubes or horns—with noise reverberating and booming from one end to the other—unless they are treated with an acoustical tile ceiling. Offsets, like windows at left, help break up noise waves.

To see how to treat quiet rooms, turn the page



Open plans in the contemporary house can present a big problem in noise control, since sound seems to flow around corners and over room dividers from one room to another. But this "flow" of sound is primarily reverberation—sound

waves bouncing and rebounding off hard surfaces. Acoustical ceilings can cut these reverberations sharply, are almost a must if a house of this type is to be a quiet house. Drapes and furnishings help absorb sound too.

And quiet rooms also gain from acoustical treatment



Dining areas, (left) whether open to the living room or separate, need acoustical treatment to dull the clatter of dishes and utensils. In the alcove pictured at the left, three things help make dining more pleasant:

1. The drapes and curtains that help keep noise from bouncing back off the glass wall.
2. The rug that "softens" the floor.
3. The acoustical ceiling.

Living rooms (photo at right) with glass walls or big picture windows should have acoustical ceilings because glass can reflect up to 98% of the sound striking it. Without the tiled ceiling and the wall-to-wall carpeting, noise levels in this room could be unpleasant. Though drapes will cut down sound reflection appreciably, people usually want their living room drapes open in the daytime, so most of their noise-reducing effect is lost.



Bedrooms can often gain from acoustical treatment because it gives the room a noticeably "hushed" effect. In story-and-a-half houses with bedrooms that have kneewalls (like the room pictured above), sloped and flat ceilings can often be finished more cheaply with acoustical tiles than they could be with plaster or drywall and paint. Tiles can be stapled or fastened with an adhesive to furring strips on rafters and collar beams.



Studies should be especially quiet, and acoustical tiles or planks on walls and ceiling can help give them the right atmosphere. The acoustical materials shown on these pages are of two basic types: cellulose fiber and mineral fiber. Both types can be perforated, slotted, fissured, textured, or striated. The mineral fiber type is often faced with perforated metal pans, plastic membranes (which transmit sound to be absorbed) or perforated asbestos sheets. /END

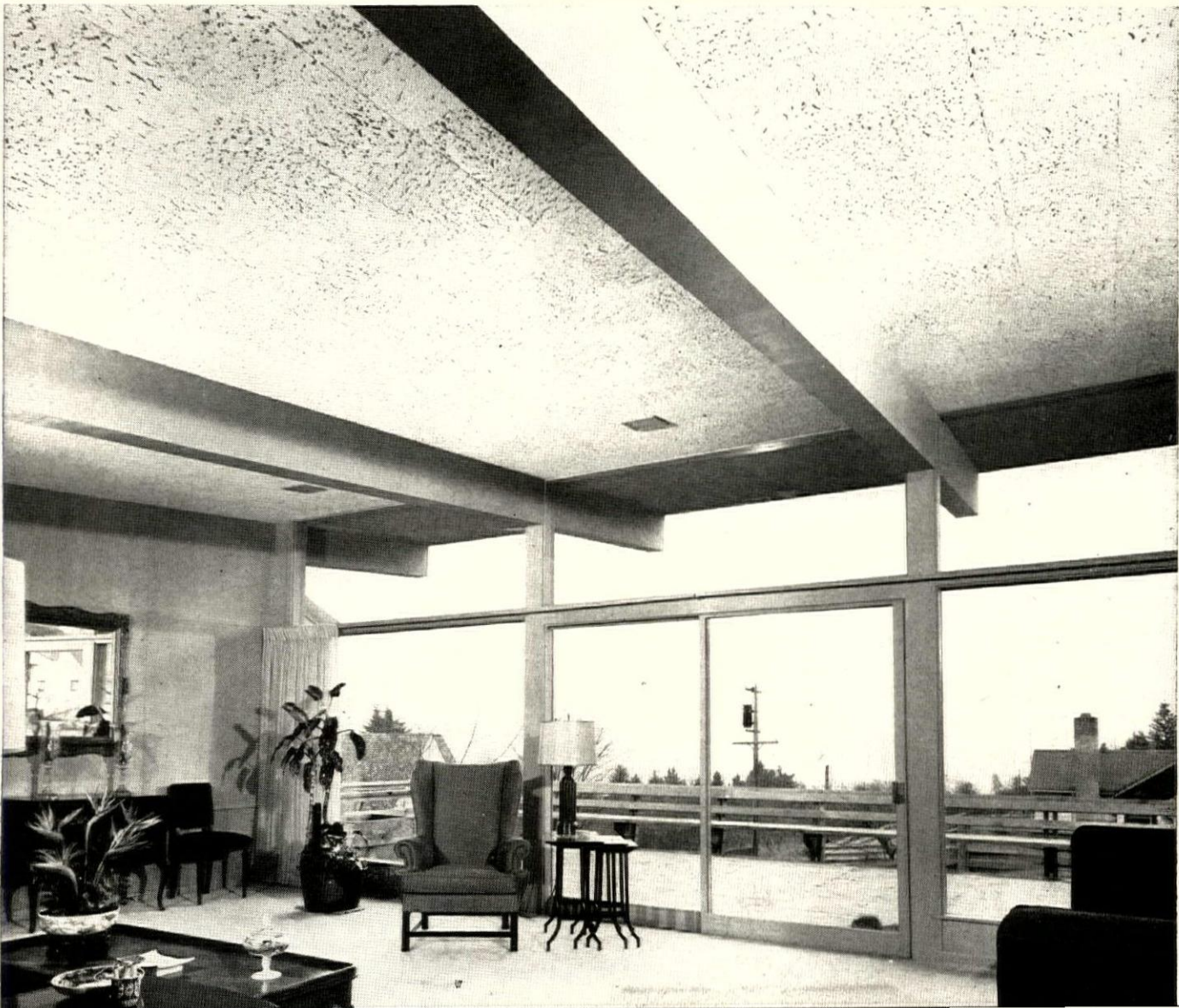

HOUSES
BUILT

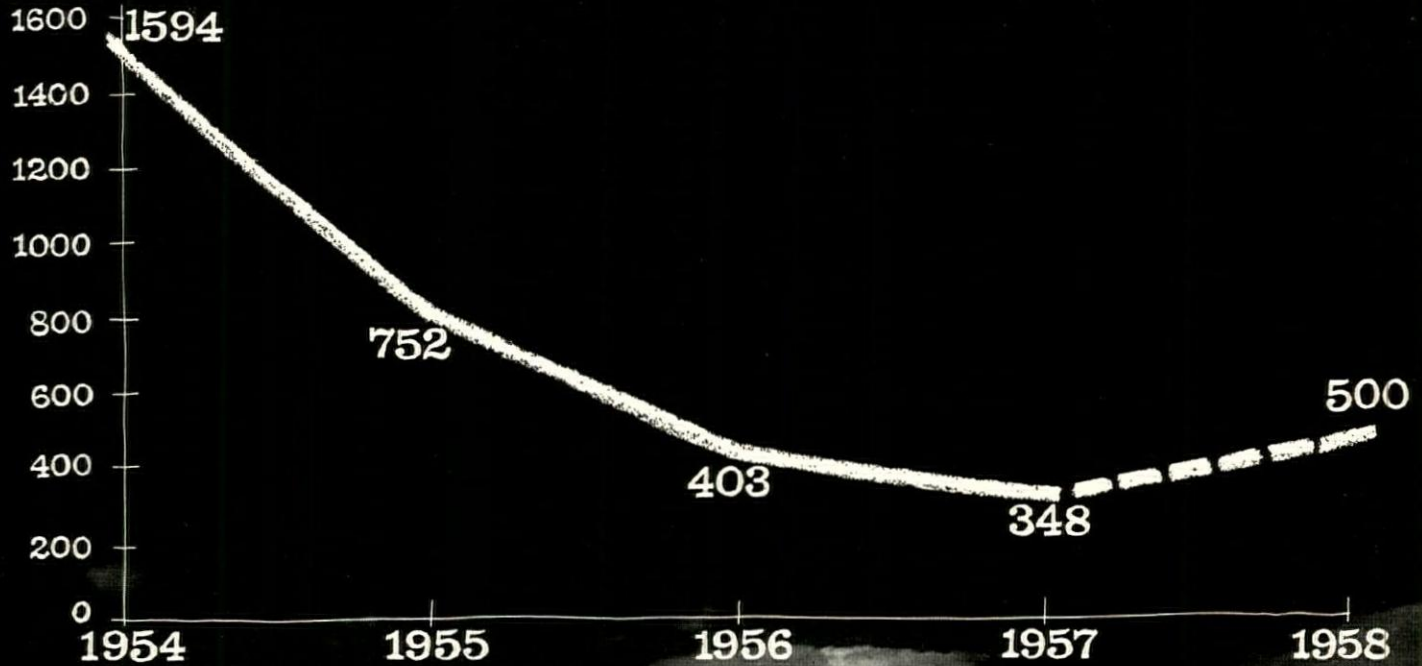

HADLEY-CHERRY'S PRODUCTION had been dropping steadily. But this year they've scheduled 500 houses—152 more than last year.

Two smart builders **START BACK UP**



RAY CHERRY

JOHN HADLEY

While most other Los Angeles builders are still cutting back, John Hadley and Ray Cherry are going ahead with plans to build a whopping 45% more houses this year than last (see chart above).

The methods they used to judge the market and decide it was time to "start back up" (see opposite page) could be a big help to you in judging the market in your area and planning your production.

And the things they are doing to assure themselves a lion's share of the bigger market (see pages 140-143) could be a big help to you in getting a bigger share of the market in your area.

Ray Cherry and John Hadley have long since established themselves as two of the smartest and most efficient builders in Los Angeles. They were smart enough to sell over 1,500 houses without FHA or VA financing in the 1954 hey-day of no-down payments. They used a new kind of financing that netted them three times as much per house as they could net with FHA or VA and they cracked the low price house market wide open (see H&H, Feb. '55).

In short, Hadley-Cherry's ideas are worth checking against your own.

Here is how Hadley and Cherry judge their market

They keep constant tab on local building statistics . . .

Hadley and Cherry continuously study statistics on manufacturing employment, sales by retail stores, deeds and subdivisions recorded, FHA insuring operations, VA applications and the like—all good measures of the prosperity of prospective home buyers and the building activity in the area.

But the statistics they find most useful are "Residential Building Permits," (far right) and "Number of Installed Electric Meters That Have Never Operated" (near right).

Here is how they interpreted these two charts last fall:

The sharp drop in permits issued through last summer indicated to them that relatively few new houses were likely to come on the market towards the end of 1957.

And the sharp drop in the number of "installed electric meters that have never operated" (one of the best measures of unsold new houses, says Cherry) indicated to them that the oversupply of new houses already on the market was being cut down at a fast rate.

(Charts at right are from "Residential Research Report"—published by Residential Research Committee of Southern California, Los Angeles. The same data for your area can probably be obtained from your bank and utility.)

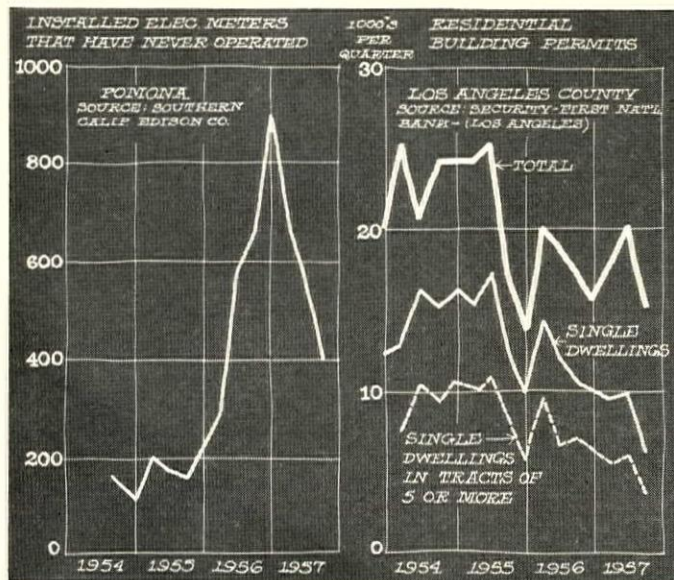

. . . and they check their ideas with their banker

"A good banker acts as a check on a builder's activity. They have a broader view than we do, can tell us if we are seeing things through rose colored glasses or through dark glasses," says Ray Cherry.

Early in December, he checked with Art Neelley (right), vice president of California Federal Savings & Loan.

Cherry had noticed that retail sales were down, even with Christmas so close at hand. His guess: people were saving their money. Neelley's confirmation: while California Federal had taken in only \$8,000 in deposits in October, deposits were up sharply in November, and he felt the savings trend would continue. (He was right: his bank took in \$3 million in December, over \$5½ million in the first ten days of January.)

Were people saving for a rainy day? There seemed to be no reason for that, since the *Los Angeles Times* was running 10 or 15 pages of help wanted ads every Sunday.

Neelley added that there was no problem of delinquent payments, that collections were exceptionally good.

Their joint conclusion: people had money to spend. H-C's decision: get them to spend the money on new houses.



H&H STAFF

"When the statistics and the bankers agree, make your move . . ."

And that's just what Ray Cherry and John Hadley decided to do last December.

"We figured we ought to start right away to get things going for mid-January opening," says Cherry. "Fortunately we had prepared some land for Spring building that was ready. We opened on January 12th.

"Right from the beginning, we had better crowds out to see our houses and made better sales records than in any of the previous six months. We sold 20 houses in the first two weeks after opening."

H-C sales to March 15: 50 houses, despite five stormy weekends.

To see the package H-C is offering, turn the page

H-C is meeting the new market with new houses

Here are some of the smart (and well liked) features . . .

JULIUS SHULMAN



Family room is new feature this year in Hadley-Cherry houses. In one of the two new models (see floor plans, opposite) it is separated from the living room by the kitchen; in the other, it works as a living-dining area.

Refrigerator and built-in oven and range (optional extras in 1957) were ordered by 51% of buyers. This year, to avoid complication of "optionals," H-C is installing these appliances, plus extra cabinets, in half its houses. Price: \$350.

H&H STAFF

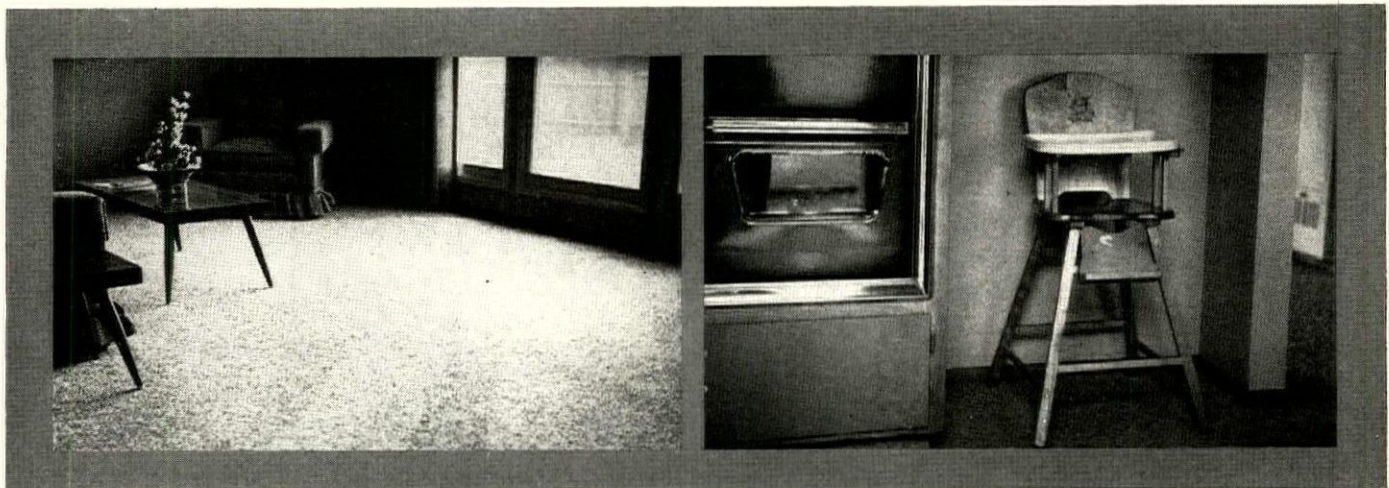

Carpeting is now included under the mortgage. Banker Neelley pointed out that many buyers bought wall-to-wall carpeting after they moved in, convinced H-C they ought to lay carpet when house was built. Cost is about \$150.

Unprescribed space in kitchen makes surprisingly big hit with women: "They want some blank space to do with as they will." H-C spotlights space with a highchair in model house, finds women use it for desk, sewing machine, storage.

JULIUS SHULMAN

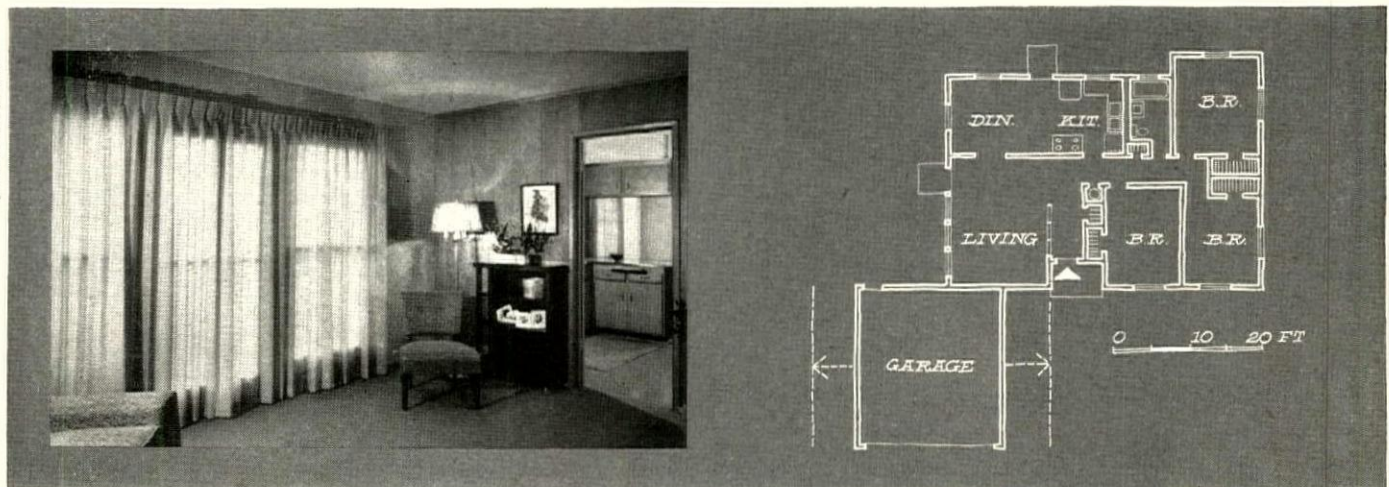

Big window wall opens house to back yard—a must in any California house. Wall is formed by floor-to-ceiling double-hung windows on either side of a glass door. Says cost-conscious Cherry: "We can build it cheaper this way."

Garage on all models can be shifted to fit the house to various size lots. This flexibility permits H-C to use the same basic house on a small (60') lot or to stretch it out on a bigger (70') lot. Dividend: fewer look-alike houses.

... in Hadley-Cherry's two new models (both under \$11,500)

JULIUS SHULMAN

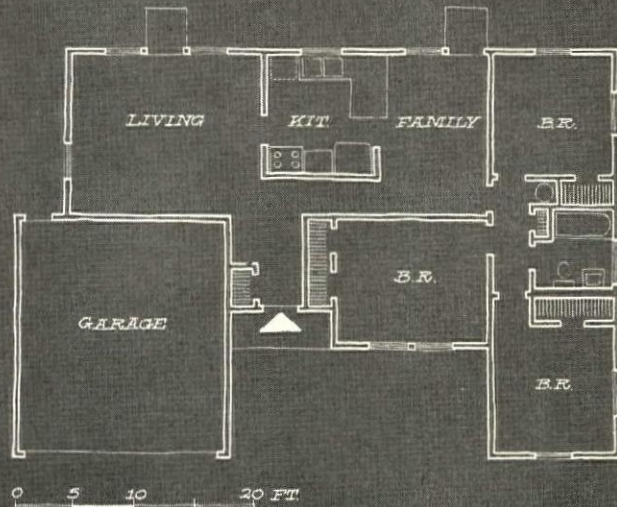

Today's best seller is this \$11,500 U-shaped model with three bedrooms and one bath. Covered front entry is feature of all H-C houses. Plan shows central entry layout that dead-ends living room; family room is only room that must handle

walk-through traffic. Placement of kitchen between living room and family room provides a measure of zoning—children can study or play in the family room, leaving the living room for adult activity.

JULIUS SHULMAN

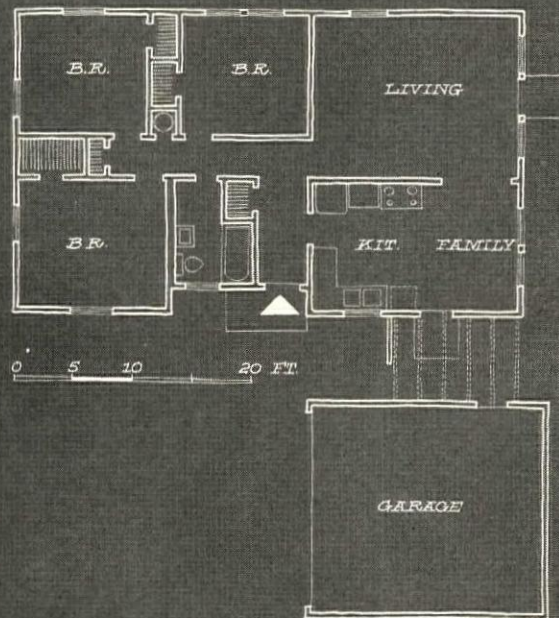

Next-best seller is this detached garage model which also sells for \$11,500. This model also has central-entry plan, living room to the rear (which most buyers like), three bedrooms. Kitchen opens on front entry or garage. The

two models on this page are outselling last year's two best sellers (which are also being offered in H-C's 1958 tracts) by two to one. "These are low-priced houses," says Ray Cherry, "but not cheap houses. There's a big difference."

To see what H-C is doing to sell this package, turn the page

H-C is meeting the new market with enough land...

Hadley-Cherry's decision to boost production didn't catch the builders short of land to build on. They try to have enough land ahead (platted, recorded, water and sewage problems solved) for a year's production.

"Too many builders had too much land out in front of them when money grew tight and the market softened two years ago. They either went broke or took a real beating," says Cherry. "On the other hand, with much less than a year's land ahead you run the risk of not being able to in-

crease production quickly to meet a market, as we just did."

Hadley-Cherry now has enough land (in five different subdivisions) for 10 months of building at their projected 500-house rate:

- 74 lots in Spruce Park, fully developed;
- 90 lots in College Park, fully developed;
- 74 lots in Pomona, ready in a few weeks;
- 86 lots in College Grove, not yet paved and water not in;
- 68 lots in Gary Gardens, not yet paved and water not in.

... more attractive financing than ever before ...

They increased their terms from 20 to 30 years. This dropped monthly payments an average of \$11. "And that qualifies a whole lot more buyers," Ray Cherry points out.

Instead of selling their houses outright as VA or FHA would require, Hadley and Cherry market their houses under a contract for sale—they retain ownership for the term of the mortgage unless their customers buy out H-C's interest beforehand. Customers can buy the deed of trust from H-C simply by putting up the cash difference between the selling price and the mortgage. In actual practice, many customers do just that within several years.

Although H-C's conventional mortgages through California Federal and Standard Federal Savings & Loan can only run the statutory limit of 25 years, Hadley and Cherry can and

in fact do extend customers' payments to 30 years since they themselves—not their customers—are obligated to amortize the mortgage within the 25-year limit.

They made their financing more flexible. For buyers who have more cash and prefer 8 lower monthly payments, H-C has worked out a flexible financing schedule which lowers monthly payments \$2 for each \$300 the customer pays down. "Tailor this flexible plan to fit your own pocketbook," say H-C ads and sales brochures.

H-C is now considering a 20-year lease-purchase arrangement under which customers can exercise an option to purchase their houses after five years. Object of this arrangement is to let H-C market a whole tract of houses to an investor after five years and realize a capital gain.

... and good quality despite low price

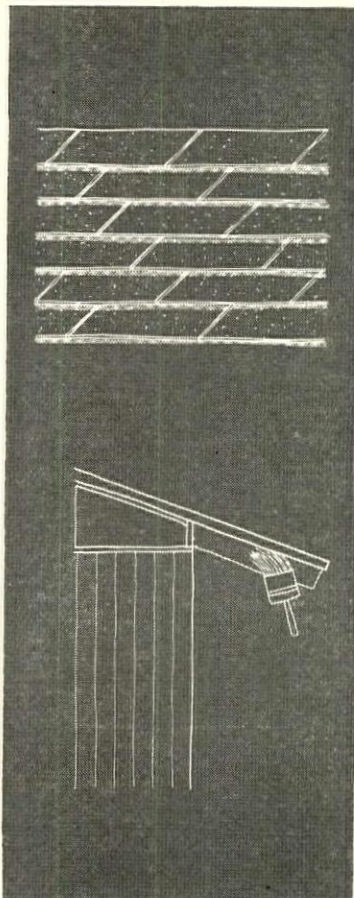

Though they build low cost houses, Ray Cherry and John Hadley have built a reputation for quality. Their secret: efficient production, close attention to details that can trim costs without lowering quality and causing call-back problems. Sample cost trimmers in their 1958 houses:

← They are switching from cedar shingle roofs to 215-lb. thick butt, shadowline shingles that look like wood (Johns-Manville). Savings per house: \$200.

→ They are running gas and water pipes overhead through the attic space instead of through the slab. Savings per house: \$25.

← They are using a one-coat eave stain instead of paint on soffits. Savings per house: \$12.

→ And they are planning a smaller model (which can sell for less money so more prospects can qualify). Savings per house: \$25 on lath and plaster for stucco, \$25 on dry wall, \$20 on concrete, \$25 on painting and paperhanging, \$50 on driveway, \$33 on sash and doors, \$35 on cabinetwork.

Says Cherry: "Today you can build small houses, but you can't build cheap houses. The public can tell the difference, and there is not much point in trying to fool them."

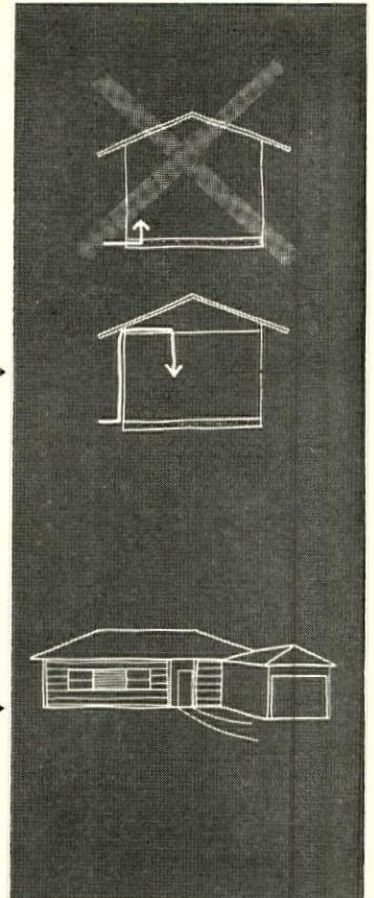

"Use an attention-getting symbol to attract eyes to your ad."

"Show your house but not your floor plan: you must create a reason for people to come out for a look."

"Highlight a feature of your financing or your house."

"Use your name. It assures prospects someone is standing behind the product."

"Leave plenty of white space to make your ad easy to read."

"State your terms."

"State your price."

"State your monthly payments."

"Stress the NEW things about your houses."

"Include a map to help your prospects find your houses."

"TELL ONLY THE ESSENTIALS in an ad" is Hadley-Cherry's primary rule for advertising. Those essentials are highlighted above.

H-C is wooing the new market with smart selling

Here are smart merchandiser Ray Cherry's six rules for merchandising:

1. "Start with a big ad (see sample above) and keep plugging. You can't possibly tell everything about a house in an ad, so there is no sense trying. Advertising should be used to create curiosity and build traffic. And we'll take all the traffic we can get. If we get people out, and they like what they see, they'll tell others. And word of mouth advertising does more to sell houses than any newspaper ad.

2. "Don't budget for selling. You must spend what is necessary to sell what you have. If your advertising isn't pulling, change your advertising. You're paying your advertising agency for good advice, use it. If your merchandising isn't working, you must find new ways to appeal to your prospects.

3. "Soft sell your prospects. There is a personal satisfaction that people get if they believe they've sold themselves, that they weren't sold by someone else. We make no attempt to corral the buyer or hard-sell him. We let him work up to a point where he wants the house because of the features we've put into it and the way we've presented it. You can't make up the buyer's mind for him, you can only help him.

4. "Get the chip off the buyer's shoulder." On opening weekends Hadley and Cherry provide coffee and cookies for lookers. Nobody can be mad at you when he's drinking your coffee.

5. "Don't overfurnish models." Hadley and Cherry buy their own furniture, add new pieces from time to time as pieces get worn or shabby looking. They budget about \$600 for furniture in each model house, deliberately underfurnish so prospects can visualize some of their own furniture in the house.

6. "Leave some blank space on your sales brochure. This space is used by our salesmen to itemize price of the house, taxes, date house will be ready, date final payment is due, any other special information that the prospect wants. Writing in points like this makes the buyer feel he is getting special attention, which he likes."

Summing up, Ray Cherry says: "People are going to look around. We don't sell people the first time. They all come back several times. We encourage them to look around, tell them: 'You'll be back.' And we can usually tell if they are coming back." /END.

MPS PROGRESS REPORT

FHA and its advisors are writing more flexibility into the new construction bible

FHA's new Minimum Property Standards, first major overhaul of its construction bible in 23 years, is taking final shape as an unusually flexible set of guides. Three years in the writing, the new MPS will replace 28 regional versions of today's Minimum Property Requirements. The new book is now scheduled to reach local offices in the fall, to go into effect about the first of next year.

Never before has FHA given the housing industry so much chance to be heard before issuing a technical regulation. Now, with the returns in, "there has to be an end to constant deliberations, with outside groups," says one FHA executive.

Some of the most difficult decisions still lie ahead of

FHA technicians and the extraordinarily able eight-man architectural advisory committee who are rushing the final version of the new book to completion. Among them: how much pressure-treated wood should be required as an anti-termite measure, how stiff should insulation requirements be, how much capacity should hot water heaters have, how thick must plaster be?

Many significant decisions have been made:

Important changes in the first 5½ chapters of the 13-chapter MPS book are outlined on the next two pages, in comparison not only with a midwestern set of today's soon-to-expire MPRs, but also with the widely circulated third draft of the new single standard (H&H, May '57).

These 11 men have made home building's next big advance possible



Neil Connor, chief of FHA's architectural standards div.



William O'Connor, deputy director, FHA arch. stds. div.



Robert Eggleston, assistant to William O'Connor.



David Slipper, pres., Webb & Knapp Communities, NYC.



Andrew Place, South Bend builder, trustee NAHB Research Inst.



Leonard Haeger, vice pres., Levitt & Sons, Levittown, Pa. bldrs.



James Lendrum, AIA, chairman, dept. of arch., U. of Fla.



Howard Vermilya, AIA, vice president, American Houses.



Edward Fickett, AIA, Los Angeles, builders' house architect.



Irwin Jalonack, L.I. housing consultant and mechanical engr.



Harold Hauf, chairman of architecture, RPI; chairman, BRAB.

When FHA's new MPS emerges from the Government Printing Office in a few months, chances are that FHA will have at last caught up with home building's revolution in technology. This monumental achievement will be largely the work of eleven men: three FHA architectural standards officials headed by Architect Neil Connor, and eight unsalaried members of its architectural standards advisory committee — men whose expert knowledge FHA could not possibly have hired. Since their first meeting in March 1955, they have:

1. Reviewed some 350 standards of engineering societies and industry.
2. Consulted some 166 trade associations.
3. Contacted through NAHB and its local chapters hundreds of builders who wanted to make a contribution or comment on the new MPS.
4. Written some 20,000 sheets of paper in going through the four drafts that it is taking to write the new MPS book.

The result is a book that should wield profound influence on building codes across the nation and, with its accent on "if it works, use it," should be welcomed enthusiastically by builders who feel they have been hampered in the past by the rigidity of MPRs.

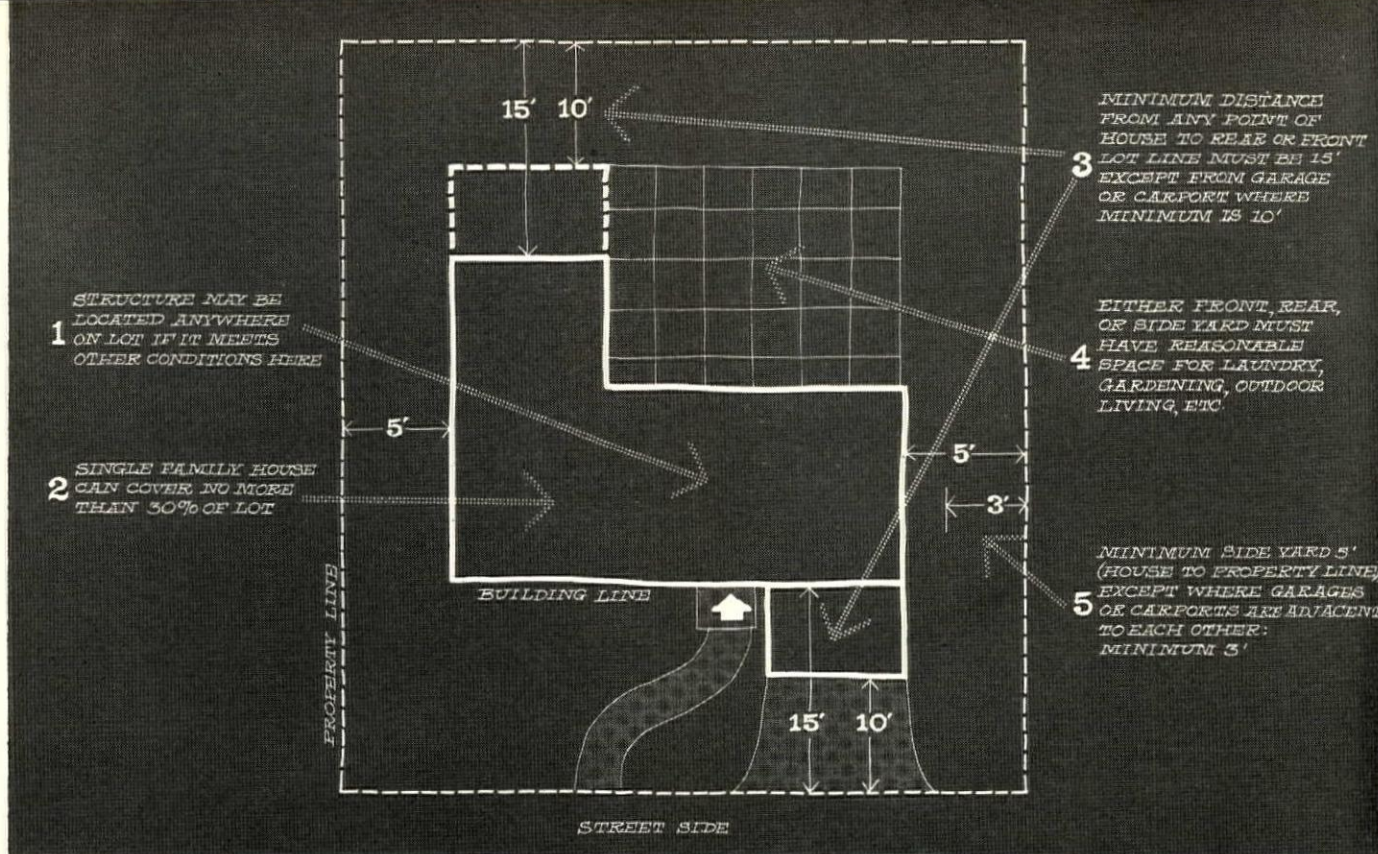

LOT COVERAGE, yard space become significant control on building density, so . . .

Plot planning is divorced from 5,000 sq. ft. minimum lots

Elastic is the word for plot planning under the new MPS. Both today's MPRs and the first three drafts of the new MPS stuck to a minimum lot size of 5,000 sq. ft. This can create problems for a special case like a hillside lot.

The new MPS will control lot sizes through the newly devised checks and balances indicated in the drawing above.

Under the new MPS a house can be placed virtually any place on the lot. It can be well to the rear, or turned around and placed well to the front of the lot so that the "front" yard is actually in the back of the house. This new flexibility should not only give builders a new tool to fight the "look alike" curse in developments but also should allow better orientation of houses to lots. It permits designs like a house of three wings built around the periphery of a lot, with the center as a patio.

For two-family detached dwellings, the same minimums will hold except that maximum lot coverage is 35%. Existing MPRs call for a 7,500 sq. ft. minimum lot.

Maximum coverage for semi-detached, or end-row one- or

two-family dwelling is also 35% in the new MPS vs. 4,500 sq. ft. for two families in this category in the MPRs.

Row dwellings, one- or two-family, can cover up to 40% of the lot. Under today's old rules, they may cover only 35% on 2,000 and 3,000 sq. ft. minimum lots, respectively.

These additional provisions (already in force) will continue:

1. Minimum plot planning must leave the property marketable, in the opinion of local FHA directors. If local practice or existing platting allow smaller lots, a house might be built on a 2,500 sq. ft. lot, perhaps even smaller.

2. If topography (hillside lots, for instance) makes the minimums above impractical, they can be overruled in special cases by local directors. Again, the property must be marketable. Plot planning will not be acceptable if it lowers the character of the neighborhood.

3. If there are compensating features, like better planned service areas or patios, an acceptable plot plan may have lower minimums.

Kitchen storage is divorced from number of bedrooms

Unlike today's MPRs which boost the amount of kitchen storage for each extra bedroom, the new MPS will have a blanket minimum with more alternatives for all houses:

- ¶ Base and wall cabinet shelving: 50 sq. ft. (the acceptable minimum for three-bedroom houses in MPRs).
 - ¶ Counter top area must be at least 10 sq. ft. (this is not ruled on at all in MPRs).
 - ¶ Minimum drawer area must be 10 sq. ft. (drawers were included as part of base cabinets but not in addition to their shelving area in MPRs).
 - ¶ If a range is provided, its usable storage space may be included in shelf area (MPRs allowed a little over the equivalent of 2 sq. ft. if a 3' range with storage was provided; it has 6 sq. ft. actually).
- Wall shelving down to 4" deep spaced as close as 5" o.c.

and base shelving down to 12" deep spaced 8" o.c. may be included in total shelving figure. Today's MPRs allow minimum depths of 11" and 22" space 12" o.c. for wall and base shelving that can be included in total figures. In the new MPS, as shelves get wider their spacing increases if they are to be figured in shelving minimums.

General storage is to be upped to 200 cu. ft. plus 75 cu. ft. per bedroom (from today's 150 and 50 cu. ft. figures), but MPS will call for only 25% of this within the dwelling.

Linen closet space minimums will be roughly the same as they used to be: 9 sq. ft. and 12 sq. ft. for 1-2 and 3-4 bedrooms, respectively; in the MPS, drawers with minimum 5" depth may fill out 50% of required shelf space.

The MPR stipulation that exterior fuel tanks are to be buried or screened is to be dropped in the MPS.

continued on p. 158



Need land? Then take a look at marshland

Many good building sites are going unnoticed because developers and builders see them only as swamps, tidal marshes or low land along lakes or rivers.

Some of these are in areas close to town that have been passed over while higher land all around has skyrocketed in price. Yet the marshy land can sometimes be bought and filled in for much less than the cost of the surrounding land.

A few smart home builders have already found it pays to be land builders as well. In Florida, thousands of acres of coastline have been turned into attractive housing sites (for example, see opposite). And builders are dredging and filling land in many other parts of the country, too—in New York (page 148), in Connecticut (page 149), in Ohio (page 150) and in New Jersey (page 152).

Who does the dredging? Some developers have bought their own dredges. The average dredge equipped to dig and pump 100 to 150 cubic yards of fill an hour costs from \$60,000 to \$95,000 depending on the amount of pipe and special equipment needed. "Buying your own" usually pays only when at least 100,000 cubic yards of fill are needed. Where less fill is required, it is usually cheaper to hire a dredging contractor.

How much land must be involved to make the operation worth while? One developer (see page 149) found it profitable to bring in a dredge to fill only four acres. Ordinarily, at least 20 acres should be involved.

What does it cost? Builders are buying and improving land at a cost of \$2,500 to \$10,000 an acre. So for an operation of this kind to be profitable, surrounding land prices must be high. This is not unlikely near cities, since waterfront property is always scarce and expensive, and always in great demand.

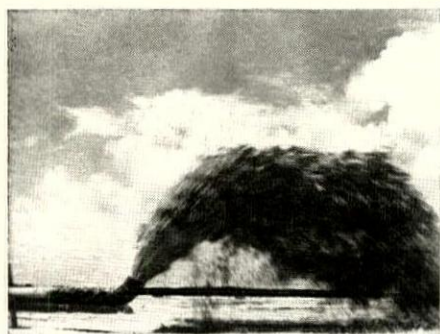

NEWLAND—at 2 cubic yards a minute.



580,000 DREDGE pumps as far as 2,000'. Unit shown is made by Ellicott Machine Corp.



984 ACRES OF SWAMPLAND will be transformed into a 1,400-house community. All homes will be on both streets and deep boat channels (see plan below). Facilities will include a 22-acre park, churches and a waterfront shopping center.

In Florida, a new Venice is being built

The small dredge pictured above is creating the land for one of the nation's most exciting new developments.

It is making 100' waterfront lots worth \$7,500 out of mosquito-breeding mangrove swamps in New Smyrna Beach, on Florida's east coast.

Builders Leonard and Walter Mulbry Jr. are developing their aptly named Venezia tract by pumping 7 million cubic yards of fill out of new boat channels onto 1,400 new lots. They expect little trouble selling these choice concrete-bulkheaded lots at \$7,500 because that's the going price of the few good waterfront lots still available in the area.

Reclamation will cost \$2 million

That's the minimum. It may be double that amount if all lots get concrete bulkheads—in which case higher sales prices will cover the added cost. In either case, the Mulbrys and their backers expect to spend another \$2 million for selling expenses and come out with \$2 million in profits.

They paid only \$123,100 for the land. They bought 84 acres from the city for \$46,000, got the other 900 acres from the state for only \$77,100. (The state's low price was based on the value to the public of eliminating mosquitoes.)

Pumping (with their own dredge) costs them no more than 25¢ a cubic yard, or about \$1,750,000 for the total of 7 million cubic yards needed.

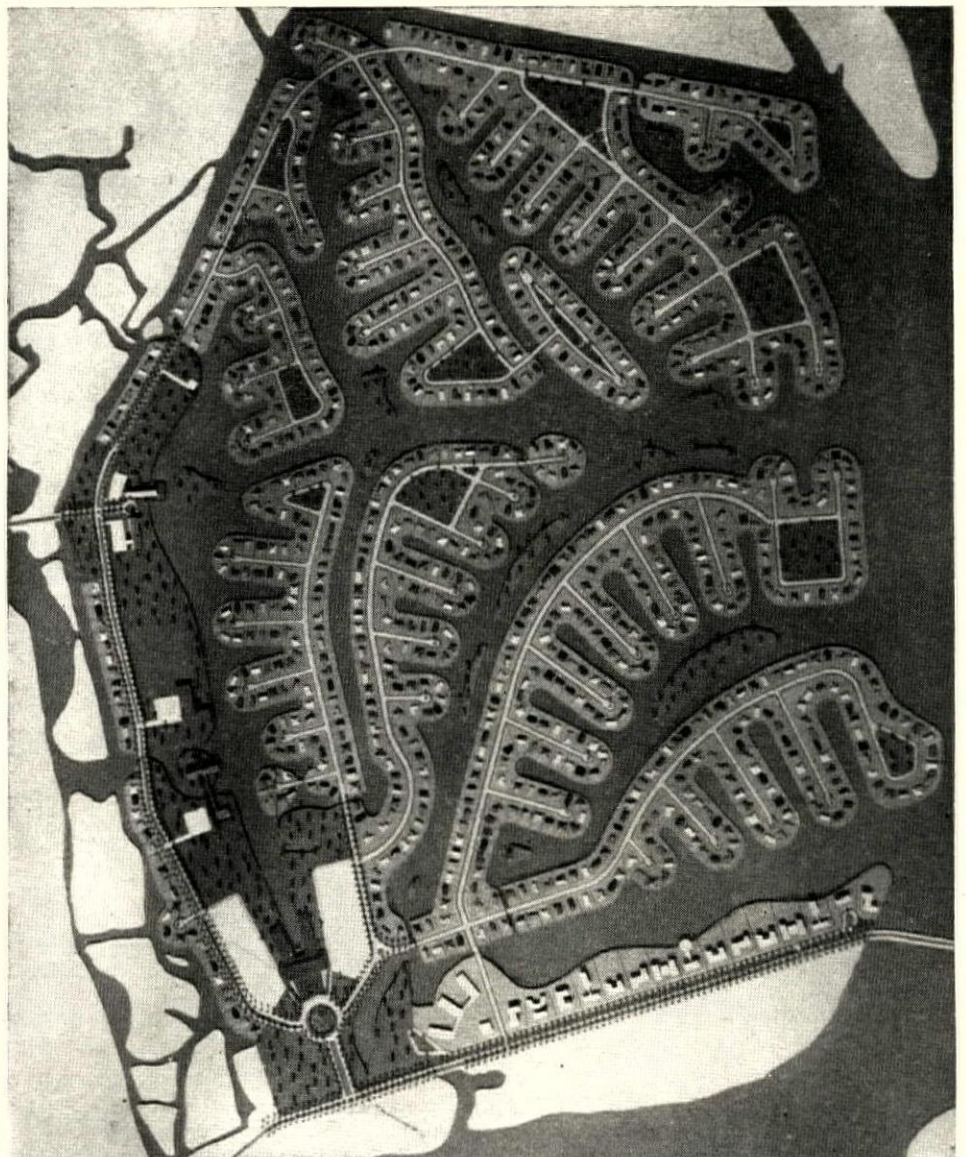

VENEZIA'S CANALS (right) are 19' deep. Site is 18 miles south of Daytona Beach.

Reclaimed marshland

continued



LAWRENCE BAY PARK TRACT includes split-level, ranch and contemporary houses designed by Architects Schuman & Lichtenstein.

On Long Island, 106 houses are rising on 44 new acres

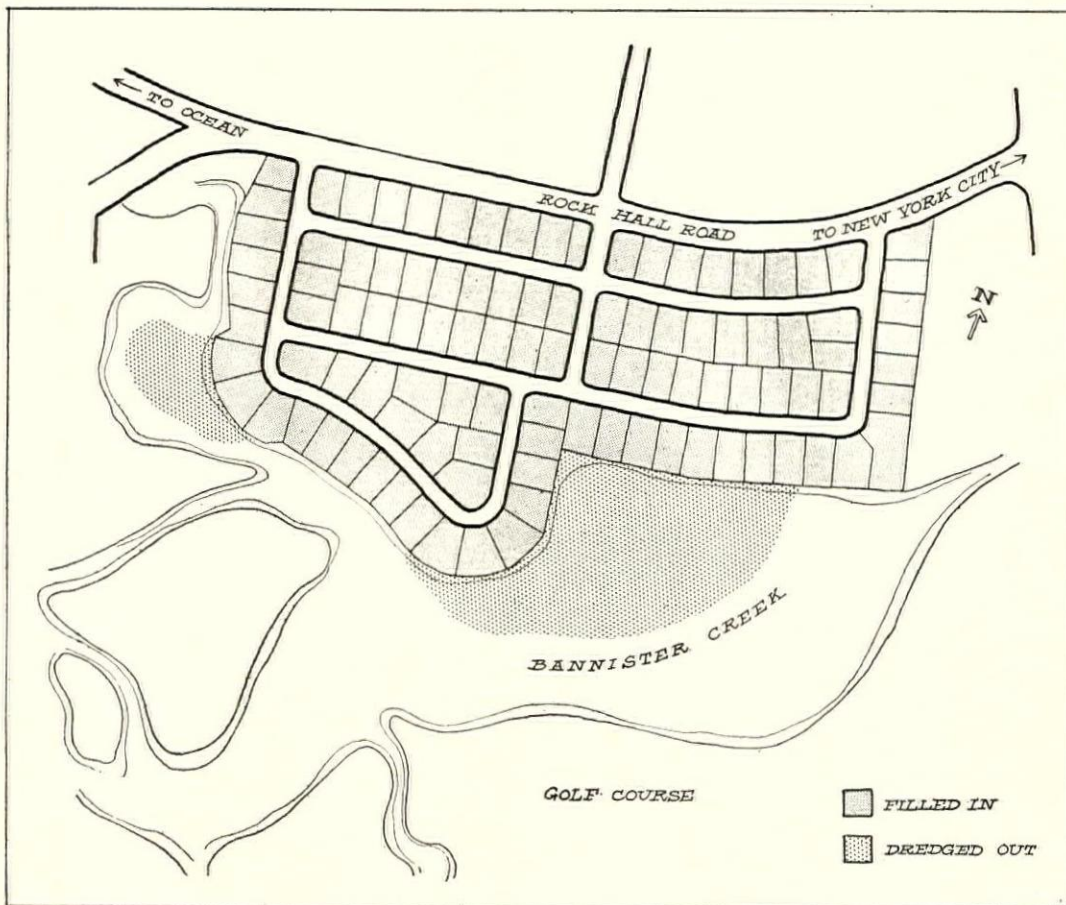

FORMER MARSHLAND has been converted into 106 lots averaging 12,400 sq. ft. with minimum value of \$13,000. Six acres of original 50 were used to provide fill and to widen the 20'-deep boat channel.

The big houses above sit on built-up land that two years ago disappeared from sight under the tide twice a day.

The \$40,000 to \$75,000 houses wouldn't be there now if Builder Melvin Senville had not seen the chance of filling in the land.

Senville paid \$50,000 for 50 woe-begone acres. The price was high for marshland but peanuts compared to the price of useful land in the area. The property is in swanky Lawrence, a village bordering on New York City, and 10,000 sq. ft. lots there sell for \$12,000. Furthermore, Senville knew, his land was bounded by a navigable channel and he would be able to offer highly prized close-to-the-city dock facilities to many buyers.

Key decision: use 6 acres for fill

Engineering studies showed 8' of sand fill would be needed, because of compaction, to raise the ground level 6' (or from 1' below to 5' above high tide). The 600,000 cubic yards of fill needed would have cost at least 50¢ a cubic yard if brought in by truck or barge.

Senville shaved this cost to 30¢ by hiring a dredge to pump the sand from six of his acres onto the other 44. This also permitted him to widen boating facilities and gave him more waterfront lots.

Senville's developing costs ran up to \$800,000 (or just under \$8,000 for each of the 106 lots). This included constructing a bulkhead, putting in a force main to carry sewage to the Lawrence treatment plant, paving the streets.



ALL HOUSES will have lovely view, most will be on water. Owners can walk to station for commuter trains to New York.

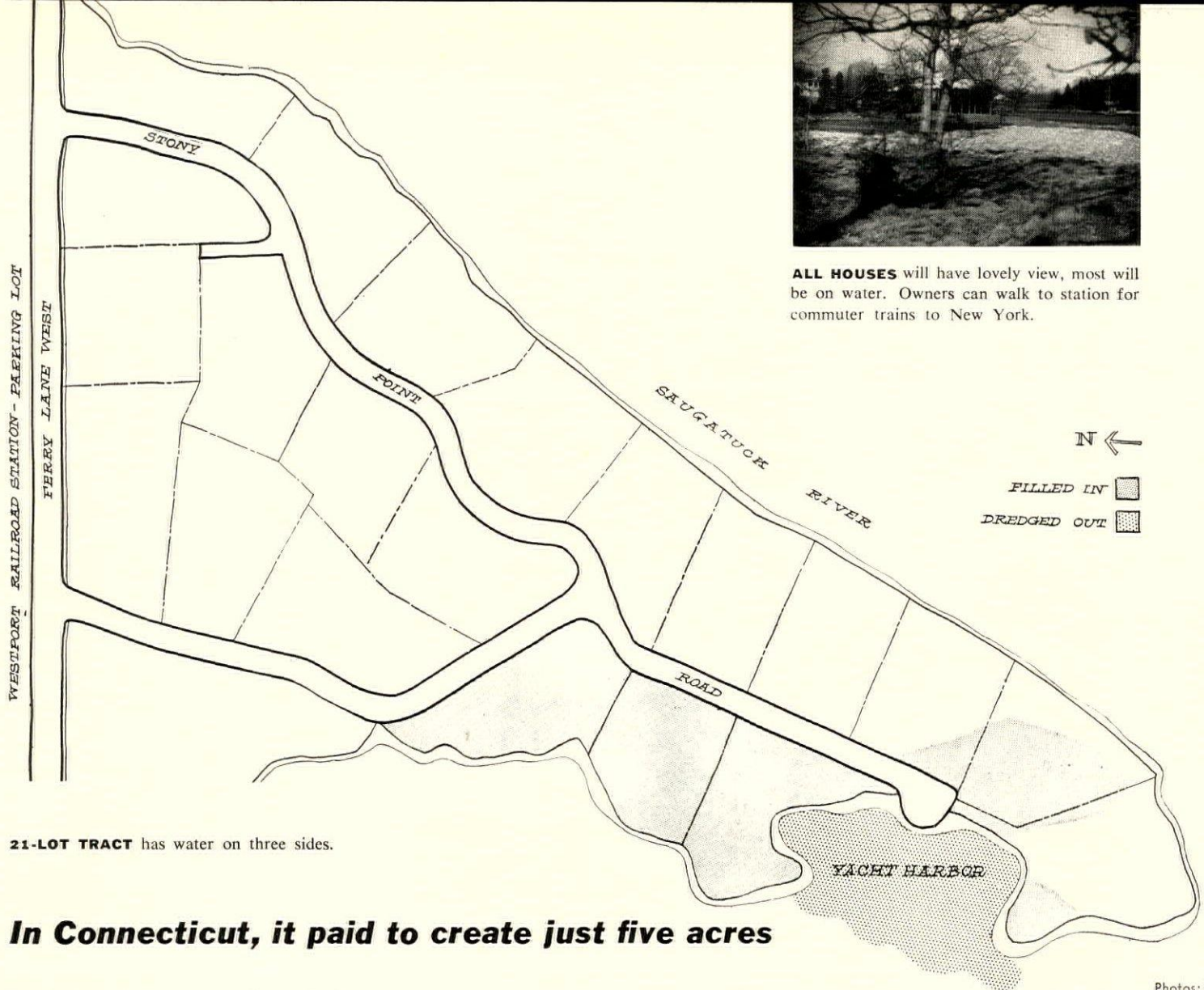

21-LOT TRACT has water on three sides.

In Connecticut, it paid to create just five acres

In 75 days last winter, a hired dredge did this job for Realtor Nat Greenberg of Westport, Conn.:

1. It filled in a marshy acre between the main body of his Stony Point tract and a hitherto isolated hillock acre (far right on drawing). This created two of his best lots, each worth \$15,000 to \$20,000. (Other lots in the tract are selling for \$10,000 up.)

2. It built up three more acre lots along a low edge of his land.

3. It created a yacht basin that increased the value of all 21 lots in the tract (by-product of the fill job).

Since only about 35,000 cubic yards of fill were needed, there was no question that hiring a dredge was cheaper than buying one. Says Realtor Greenberg: "Our deal with the dredge operator was much too complicated for me to give out exact cost figures. But we certainly got a lot for what we paid." It is significant that dredged fill for the nearby Connecticut Turnpike was selling for \$1.29 a cubic yard. Greenberg would have turned a tidy profit if he had paid this price—and he paid less.

Proof that there's nothing new under the sun: the land on the river side of the tract was filled 50 years ago with gravel from the New York City subway excavation.

NEWLY FILLED LAND is almost all shown in this photo. Trees in background are on point of peninsula (extreme right in drawing).



Photos: H&H Staff

Reclaimed marshland

continued



RECLAIMED LAND FOR HOUSES is created on a narrow, marshy sandpit off Sandusky, Ohio by hydraulic dredge (shown in cove), which pumps 135 cubic yards of fill an hour through 8" pipe. Land at lower left in photo will be developed as a park with a boating harbor.

In Ohio, an outstanding subdivision is replacing marshland

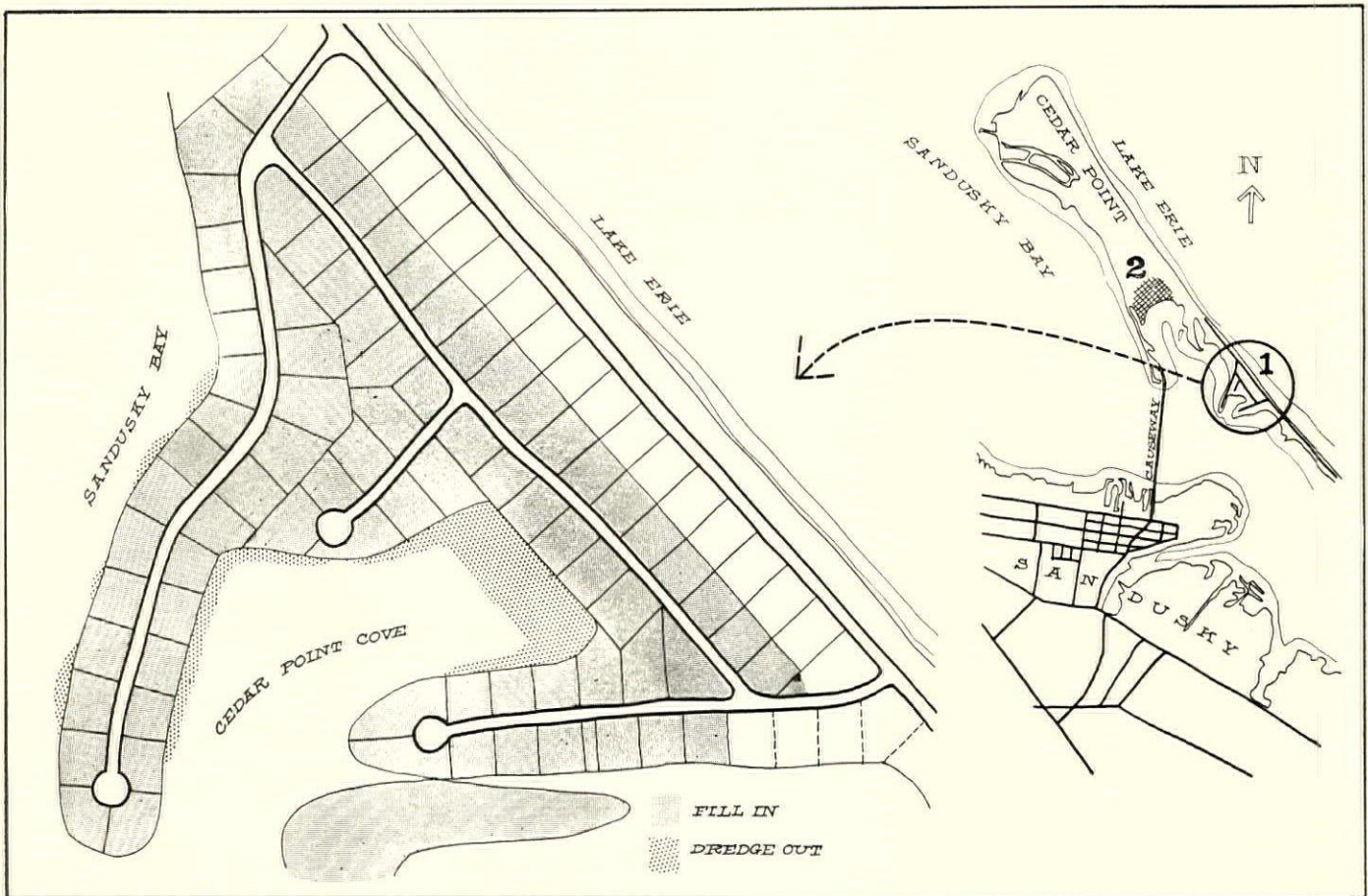

PLAN OF CEDAR POINT TRACT shown in photo above puts 75 of the 98 lots on waterfront—either on the lake, the bay or the newly created lagoon. Area map at right shows the present tract (1) and the builder's next 30-acre site (2). Sandusky is reached over new causeway.



SHEET STEEL PILING forms bulkhead for each new bay-side lot. Piling costs \$30 a running foot. Since lots average 100' wide, this raises their cost \$3,000. So bay side lots sell for as high as \$12,000, while lots on lake side (without piling) are valued at \$6,000 to \$8,000.

Here is good land planning—and dredging made is possible.

Sandusky Development Co.'s 35-acre tract has so many attractions that the houses there are selling for as much as \$75,000 on quarter-acre lots.

The location is unusual—on a long narrow sandspit in Lake Erie, a mile across the bay from Sandusky, Ohio. For years houses have been built on high ground along the lake side of the sandspit while marshy ground on the bay side went ignored.

Today the marshes on this tract have nearly all disappeared under 3' of fill which the builder pumped from the bay with his own dredge. There are now 78 new lots, plus 18 more on original higher ground. All buyers of Sandusky Development's good-looking houses will get to use the three-acre recreation island, its boat basin and the sandy lake shore beach.

\$80,000 dredge pays for itself

Builders Merl Stahl and Karl Riedel pumped 100,000 cubic yards of fill to complete their tract at a cost of about 30¢ to 35¢ a yard. They would have had to pay \$1 a yard to a dredging contractor. This means they have about saved the cost of the dredge in filling these first 35 acres.

But they will soon start reclaiming a larger tract a half-mile north on the sandspit. There they can save ten times as much—for they'll be moving a million yards of fill.



CONTEMPORARY DESIGN dominates throughout the tract. Architect William J. Gabriel designed this house and most of 30 built so far.



\$50,000 HOUSES and others ranging up to \$75,000 are built by Sandusky Development Co. All are oriented to get the best views.

continued

continued

In New Jersey, a marsh is becoming a resort area

The year-round homes and summer cottages shown below sit on land that Developer George Freibott has been slowly but steadily reclaiming for seven years.

The same \$50,000 dredge that began digging deep canals and filling the land between them is still on the job today.

Freibott has long since become convinced that marshland development is well worth the cost in time and money. Here is why: he paid \$800 each for 180 acres in 1949. He has spent \$1,500 an acre to improve it. And today the land is valued at \$12,000 an acre.

"Owning your own dredge is the only economical way to handle a tract this big," Freibott says. "If I'd hired a dredge fill would have cost me twice the 25¢ per cubic yard I'm paying." /END

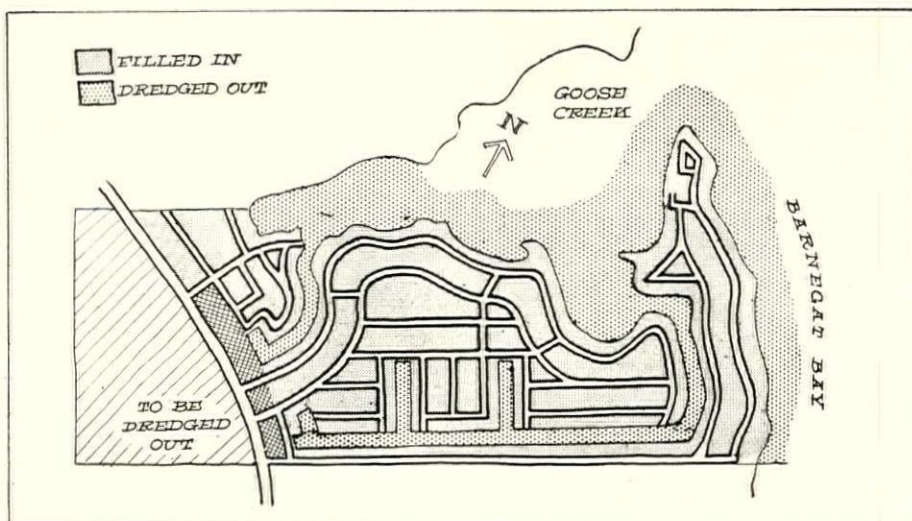

180-ACRE TRACT was originally laid out in 40' lots, has recently been rezoned for 80' lots. Lots sell for \$2,000 to \$3,000.

H&H staff



42" OF SAND was pumped onto marshland to build up Windsor Park tract on Barnegat Bay off the New Jersey mainland.

On page 168 you will find

NEW WAYS TO BUILD BETTER

A monthly report on home building ideas, products and techniques

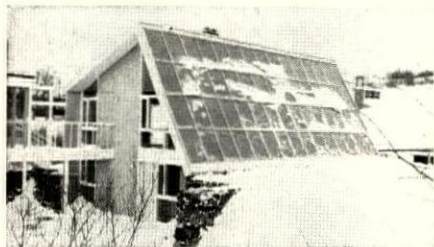

See page 168

SOLAR HEAT WORKS IN NEW ENGLAND, house No. 4 in MIT's experimental series shows. The engineering problems and architectural problems seem to be solved. Still the big problem: how to get equipment costs down to competitive levels, *page 168*



See page 172

BILL BECK'S BOX OF BLOCKS tells him just how each house is progressing and where jams are building up. See what it can do for you on *page 172*



See page 181

EIGHT SALES BOOSTERS from top-flight builders across the country are included in *What the leaders are doing on page 174*

ADHESIVE HOLDS THE DRYWALL in US Gypsum's new adhesive-nail-on method of finishing partitions. USG claims less nail popping, less finishing, less loose board, less booming when Sheetrock goes up on mastic-coated framing. *Page 181*

SHEATHE A WALL WITH ONE PLYWOOD SHEET. You can do it with Diamond Lumber's new jumbo fir panel. You'll find out about it and three new hardboards on *page 186*

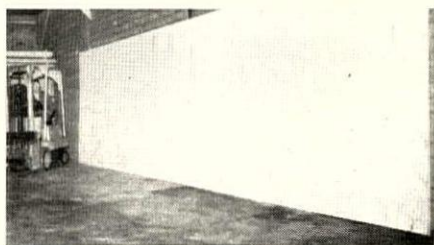

See page 186

WHAT'S NEW IN THE MARKET PLACE? This month's report on *New products* continues on *page 189*

ELEVEN NEW GUIDES TO BETTER BUILDING make up this month's *Publications* section. You'll find sources of new data on laminated timbers, panel masonry, skylights, fire protection, etc., beginning on *page 218*

B.F. Goodrich

Koroseal[®]

VINYL ASBESTOS FLOOR TILE

HELPS YOU SELL HOUSES



It's the best-known name in vinyl...it says to buyers you use the best!

Home buyers usually judge construction by what they see. They know B. F. Goodrich Koroseal, most famous name in vinyl. It tells them your homes are built with the best.

And B. F. Goodrich Koroseal adds dazzling beauty to your rooms. Choose from marbled, terrazzo or cork shades in gorgeous colors. Once over with a damp mop and it gleams (walking feet actually buff it)! Defies grease, stains, even destructive solutions. Stands up under heaviest traffic.

For further information, see Sweet's or write B. F. Goodrich Flooring Co., Dept. HH-4, Watertown 72, Mass.

SPECIFICATIONS: 31 decorator colors. $\frac{1}{16}$ " thickness for residential use. Also $\frac{1}{8}$ " and 80 gage for heavier traffic areas. Tile size 9"x9". Use on, above or below grade on wood, concrete, or composition floors.



MARBLEIZED
PATTERNS!

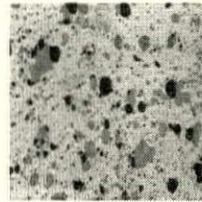

TERRAZZO
SHADES!

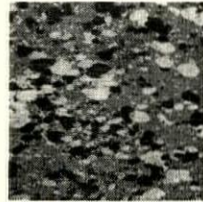

CORK
SHADES!

B.F. Goodrich flooring products



"We're sold on Gold Bond Insulation Sheathing for higher performance and low application costs"

These are the two main reasons why Mr. Bernard Labby of the Labby Construction & Development Co. of San Francisco and Las Vegas chose 31,000 square feet of Gold Bond Insulation Sheathing for the Rexford Apartments, Nevada's first cooperative apartment project.

"It is economical to use because the big 4' x 8' panels cover large areas fast. It has high racking strength, too. We wanted the best for this structure...that's why we specified Gold Bond." The best materials — quality products like Gold Bond Insulation Sheathing — helped sell over 50% of the Rexford apartment units before the building was completed!



Your Gold Bond® representative can show you how to cut costs and build well, too. Write Dept. HH-48, National Gypsum Company, Buffalo 2, New York.

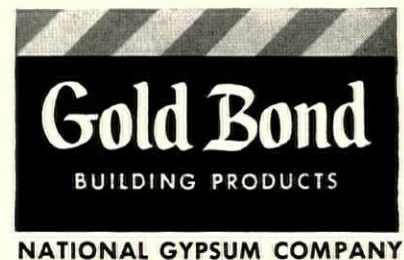

How to save TAXES

A Let's assume a new project is built at a cost of \$250,000. It has a useful life of 25 years. Here's how the annual depreciation would stack up:

Year	Straight line	Double declining balance	Sum of the digits
1	\$10,000	\$20,000	\$19,230
2	10,000	18,400	18,461
3	10,000	16,928	17,692
4	10,000	15,574	16,923
5	10,000	14,328	16,155
6	10,000	13,182	15,385
7	10,000	11,324	14,615
8	10,000	10,421	13,848
9	10,000	9,587	13,078
10	10,000	8,020	12,308

Q Who determines what shall be considered the useful life of property?

A In the long run, the Treasury still sets depreciation rates. There was much talk, during Congressional hearings on the 1954 Revenue Code, that the new law would give owners more flexibility in setting the life-span of their property. But things are still pretty much the same. That is why many builders will build conventionally with frame. It keeps the depreciation rate high (perhaps 20 or 25 years) and the cost of construction down. Items like air conditioning, elevators and electrical appliances all tend to shorten the useful life of the entire property and so increase its composite depreciation rate.

Q Which of the three depreciation methods yields more profit to a builder?

A Quicker write-off under either the declining-balance or sum-of-the-digits method produces a tax advantage if the builder-owner sells the property before the end of its useful life. The bigger depreciation deductions allowable before the sale are deductible as ordinary income. The bigger profit produced by faster depreciation is taxable only as a long-term capital gain, assuming the builder has held the property more than six months and has no capital loss from the sale of similar assets to offset such gains. Moreover, the doctor, lawyer or other business or professional man who buys the old rental units from the builder may use the 150% declining-balance depreciation on a stepped-up cost basis.

Q How does a builder qualify for capital gains treatment of a rental project?

A Capital gains applies if the property is actually held for investment, if his books and records clearly substantiate the investment nature of the property, and if the property is not offered for sale in his usual course of business.

Q Is that all there is to it?

A No, that's the terminology used by the Treasury and the courts. As a practical matter, it is hard to sustain a capital gain in real estate for a builder.

Q Don't some builders succeed in qualifying for capital gains treatment?

A Yes, many do—and rightfully. People who spend hours playing the stock market have no trouble sustaining their position as an investor. But with the builder it is different. Real estate is the builder's and land developer's stock-in-trade. Like canned goods on a grocer's shelf, it is usually classified as inventory subject to ordinary tax rates.

Q Can a builder take some of his real estate off the shelf and hold it for investment only?

A Yes, but it's tricky. The courts have said the real estate dealer may have "investment" real estate as well as "stock-in-trade" real estate if he takes good care to classify it properly and shows only investor-like actions with it. He must avoid frequent sales of the same kind of property, extensive advertising and other dealer-like activity. But duplex or larger rental properties, properly programmed, can qualify for capital gains far more easily than single-family homes, which are the *bete noir* of the builder when the showdown comes with the Treasury. Usually, too-many and too-often sales stamp the builder as a dealer. But if an entire project is sold to one buyer, or there are a limited number of sales, then a builder should be able to qualify for capital gains on some property.

Q How about letting other members of a builder's family own the rental property?

A A wife, children and trusts for them are separate taxpayers. Just because the husband-father has a broker's license and deals in real estate does not contaminate the wife and children, taxwise. They can own and sell investment real estate, taking capital gains treatment, just like any other citizen.

Q Can a builder join with other investors in a rental project and let all of them save taxes?

A Yes. Not only can they all cut their tax bills (largely through accelerated depreciation), but such syndicates are almost the only way to build really big rental projects today. Moreover, filing a consolidated tax return can save tax on the builder's construction profit whenever the construction is by a parent corporation for a subsidiary rental corporation.

Q Are there any other profit advantages to a builder in hooking up with doctors, lawyers, or other professional men?

A Yes. For instance, a builder may earn a fee by building new rental properties. When it is completed, such business or professional men may well need someone to manage the property and later sell it. So this kind of a deal can be used to make money even in a declining housing market.

Q What steps should a builder take if he is to reap this harvest?

A First, he should develop figures on the rental project (location, market analysis, type, cost, depreciation, financing). Next, he should project the tax savings. Then he has a package to show investors. Just a little imagination and creative thinking by builders this spring should return them thousands of dollars in profit this fall and for many years to come. Any kind of rental property where the market offers a little come-on will do. /END

"Now I can offer year-round comfort at a price that sells"

"A few months ago, I was trying to determine how to include air conditioning in my homes and still sell competitively.

"Gold Bond Super Thick 6" Insulation was the answer. I was able to reduce my cooling equipment costs approximately \$480 per house*... with the help of Gold Bond Super Thick in the ceilings.

"The original 3 ton requirement was reduced to 2 tons and proved more than adequate. It costs me \$220 more for additional Insulation (6" ceilings—3" sidewalls)... results in a *net* saving of \$210 on each house... a real bonus."

If you are providing air conditioning in your homes, learn how Gold Bond® Super Thick Insulation can save *you* money. And remember, electric heating calls for 6 inches of insulation as the *minimum* requirement for ceilings.

For more information, write Dept. HH-48. National Gypsum Company, Buffalo 2, New York.

*Based on published statistics. Exact costs vary with locality.

NATIONAL GYPSUM COMPANY

Gold Bond

BUILDING PRODUCTS

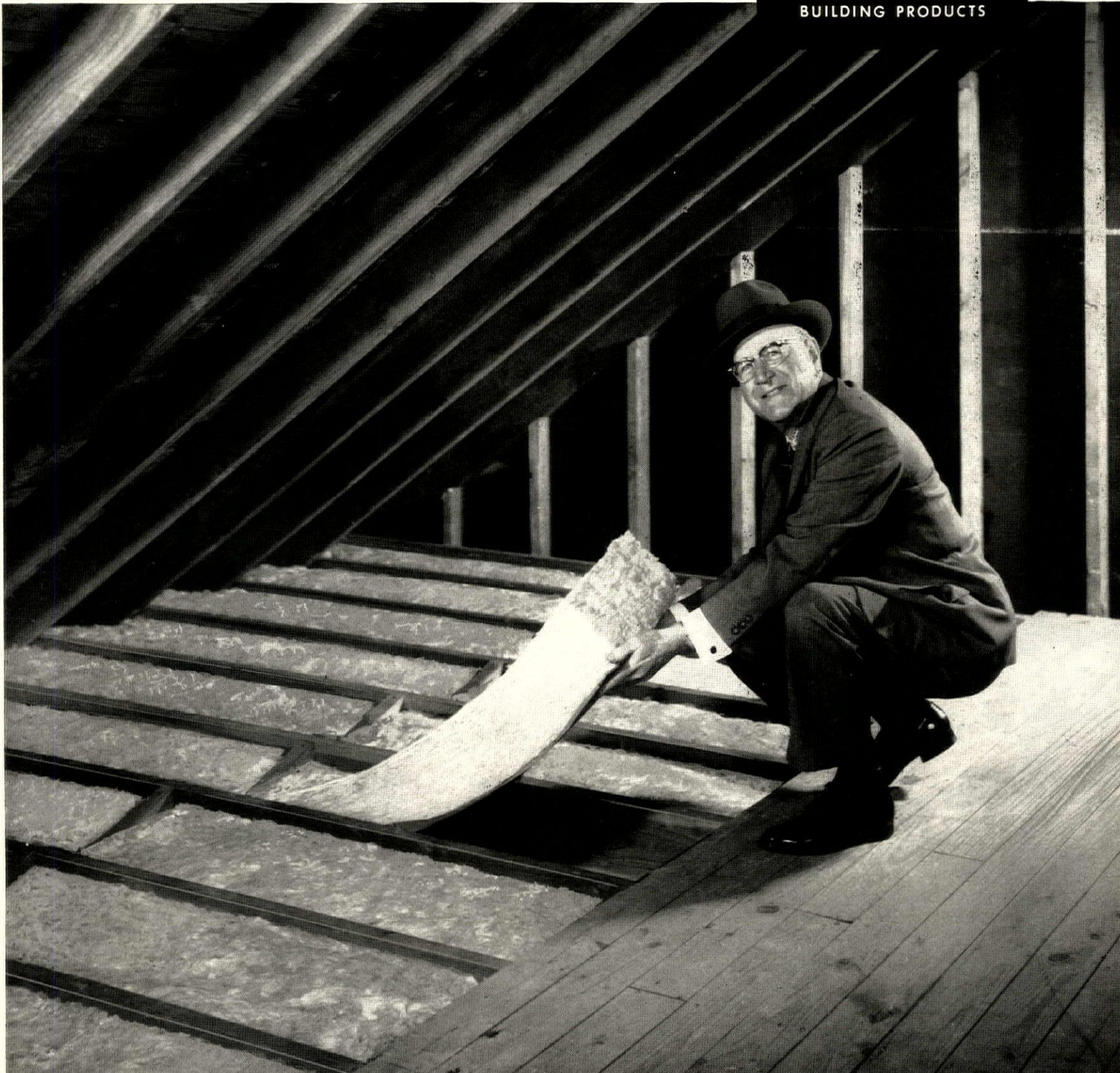

Required exhibits will be tailored to fit each case

Elevations required on plot plans will be fewer for simple sites, more for complicated lots. Along with street elevations at lot lines, and elevations at corners of dwelling, today's MPRs call for existing and finish grade at each corner of the plot. The new MPS will drop this requirement in most cases. But where special grading, drainage or foundations are necessary, the MPS will call for existing and finish grades at plot corners, existing corner grades at dwelling corners and all grades necessary to show special grading and drainage. The third draft of the MPS had complicated matters for the builder by requiring all of the above elevations or all sites, simple or complicated.

On fairly level sites, the depth of footing need no longer be shown. In the MPRs, exterior elevations had to show this, but on stock plans such as prefabbers or lumber dealers

might use, depth of footing would change with frost line and soil type of every area where they operated. In the new MPS, depth of wall footing, foundations or piers must be shown only if these are at more than one level. Otherwise, common local practice will be assumed for depth of footing not shown on elevations.

The new MPS will also make specific provisions for submitting master plot and grading plans for group applications (the MPRs did not make these provisions). If topography and lot arrangement present no individual lot problems, the MPS will allow submitting typical plot plans in place of detailing each lot on a master plot plan when drawings are submitted for group applications. The MPS third draft had made provisions for group applications but had not included the time-saver of allowing typical plot plans for simpler sites.

Inspection procedures will be tied closer to builders

FHA's whole approach to compliance inspections is to be streamlined to cut waste time and effort for the builder:

1. Builders will be able to telephone FHA field offices themselves to request an inspection. Under the MPRs, a builder must notify the mortgagee, who in turn notifies the FHA office *in writing* when construction will be ready for each inspection. The builder will, under the new MPS, be able to act as an agent of the mortgagee, if the mortgagee so authorizes him. Telephone requests for inspection will be used when the field office approves such procedure. The MPRs had not allowed telephone requests at all, and the MPS third draft only allowed them in case of emergency and then only when confirmed in writing prior to release of the report.

2. Builders will be able to discuss inspection reports directly with the field office. The MPRs stipulate that inquiries about these reports (a copy of which is left at the site) must reach FHA via the mortgage lender.

3. Elevation of the finish first floor, marked on batter boards, will not be required at first compliance inspections. MPRs allow this elevation to be established by some marker indicating its relationship to elevation of curb or crown of street. On many sites, this can be not only bothersome but also little help. Since elevations of first floor and street elevations on the plot plan are required exhibits in both MPRs and MPS, the MPS will call only for batter boards that locate wall lines.

4. A builder using plywood or pine sheathing will be able to put up his siding on the outside before the second com-

pliance inspection. Under the MPRs, a builder could not put up any siding before this inspection of structural members, roughed in plumbing, heating and electrical. In the future, he will be able to cover wood sheathing immediately because nailing is not as critical as it is in non-wood sheathing. (It's often advantageous for the builder to close in plywood or pine sheathing with siding immediately so that he won't have to rely very long on roofing felt and battens to protect it from rain.) With non-wood sheathing, however, nailing is critical and the FHA field offices will be required to inspect it at this stage. Masonry veneer will not be applied in any case before this inspection. The MPS third draft, like the MPRs called for exposed sheathing in all cases at this second inspection.

5. A delay in landscape completion will not require a \$100 escrow from the builder to get the mortgage endorsed for insurance. The new MPS will include a provision that if weather holds up landscaping, all a builder needs to close with FHA is a statement that the landscaping has been contracted, paid for and will be done by the landscaper as soon as weather permits. Under the MPRs, this situation would ordinarily have required filing a Form 2300 and putting up a \$100 escrow even for a \$10 shrub. Instead of referring the builder to other documents, the new MPS will also spell out the escrow conditions for other on- and off-site improvements which may be delayed. The MPS third draft, like the MPS, simply referred the builder to the form 2300 \$100 escrow when delayed completion held up the mortgage endorsement.

Dimensions and sizes will give planners more freedom

Among the important changes the MPS will make over MPRs are three changes in dimensions:

1. A basement room will still be allowed as habitable even if finish grade is a maximum of 48" above finish floor. MPRs allow only 30" above finish floor. This made some local practices (as in Denver) disallowable where a habitable basement room might have been planned lower. The MPS third draft had permitted a maximum grade height of 36" above floor.

2. Minimum basement ceiling height will be 6'-9" instead of 6'-10" clear under joists. This makes those local practices where mud sill is left off foundation wall (often done in Chi-

cago) allowable with the same height of block foundation wall that the rest of the country uses

3. Ceiling height under the wall edge of a sloping ceiling will be allowable as low as 6'-8". MPRs insist on 7'-6" clear in the room, whether main floor ceiling slopes or not. The MPS third draft called for an *average* ceiling height in habitable rooms of 7'-6"; if exposed beams or girders were spaced 32" o.c. or more, the average clear height could be 7'. A new ceiling height for bathrooms is likely to be included in the MPS: 6'-8" clear for ordinary bath ceilings, 7'-0" clear for luminous ceilings.

END



William F. Bernbrock, Architect; Ericson Construction Co., Builder

**Bring out the
beauty of modern
materials with *Pella*[®]
wood folding doors**

Convenience is just one big point you can talk up with PELLA WOOD FOLDING DOORS. See too, how handsomely they harmonize with the wood cabinets and furnishings, dramatically accent the masonry wall, create an eye-catching interplay of textures among appliances and floor materials.

PELLA WOOD FOLDING DOORS are the truly decorative answer to builder's problems in organizing modern open-plan living areas. Supplied ready for custom-finishing, or factory finished in pine, oak, birch and Philippine mahogany veneers. Packaged...ready for fast installation.

MAIL COUPON TODAY

ROLSCREEN COMPANY, Dept. J-73, Pella, Iowa

Please send me illustrated literature on PELLA WOOD FOLDING DOORS

FIRM _____

ADDRESS _____

CITY _____ ZONE _____ STATE _____

ATTENTION MR. _____



WOOD FOLDING DOORS

Introducing a NEW kind of ALFOL Insulation lined with vapor-sealing polyethylene

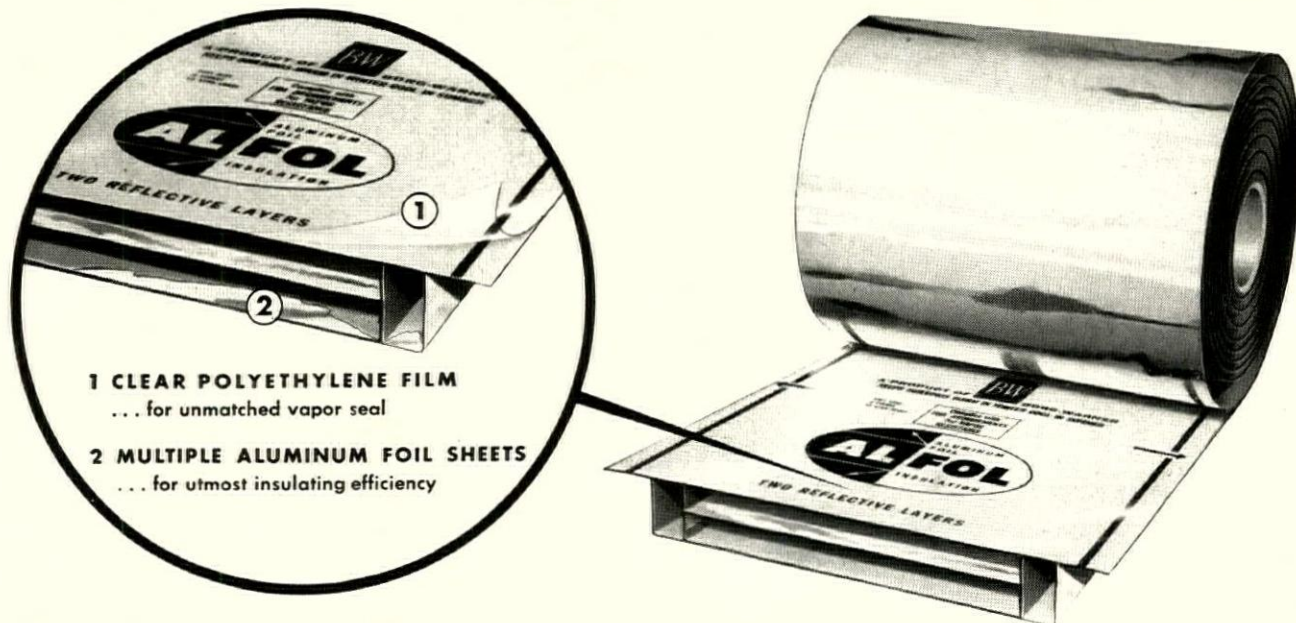

- 1 CLEAR POLYETHYLENE FILM
... for unmatched vapor seal
- 2 MULTIPLE ALUMINUM FOIL SHEETS
... for utmost insulating efficiency

Delivers the greatest moisture protection ever offered in a full insulation!
Sturdier, too, because the exposed foil surface is kraft-lined

Entirely new, this is the Alfol Type 22F Blanket. Combines the high insulating value of multi-layer aluminum foil with the unmatched vapor resistance of genuine polyethylene sheeting. Net result: the most effective built-in vapor barrier ever offered in a full-efficiency insulation!

Superior quality your customers can see
 Alfol Type 22F is easy to install, too. The heavy polyethylene backing makes it sturdier than ever. Insulat-

ing efficiency is higher. Yes, and the superiority of this new kind of insulation actually *shows*. The "poly" glistens for all to see, demonstrates at a glance the extra safety built into your homes.

Why not investigate Alfol Type 22F now. One of several new Alfol Types, it's the ideal insulation for sidewalls, ceilings, etc.—*wherever* condensation control is a "must." Return the coupon today for illustrated details.

SEND TODAY for FREE NEW BROCHURE ➔

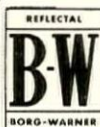

Please send full details on ALFOL Type 22F and other new types of Alfol Insulation.

REFLECTAL CORPORATION, Department C-61
 A subsidiary of Borg-Warner Corporation
 310 South Michigan Avenue, Chicago 4, Illinois

Name _____
 Firm _____
 Address _____
 City _____ State _____

8288

REFLECTAL®

Borg-Warner®

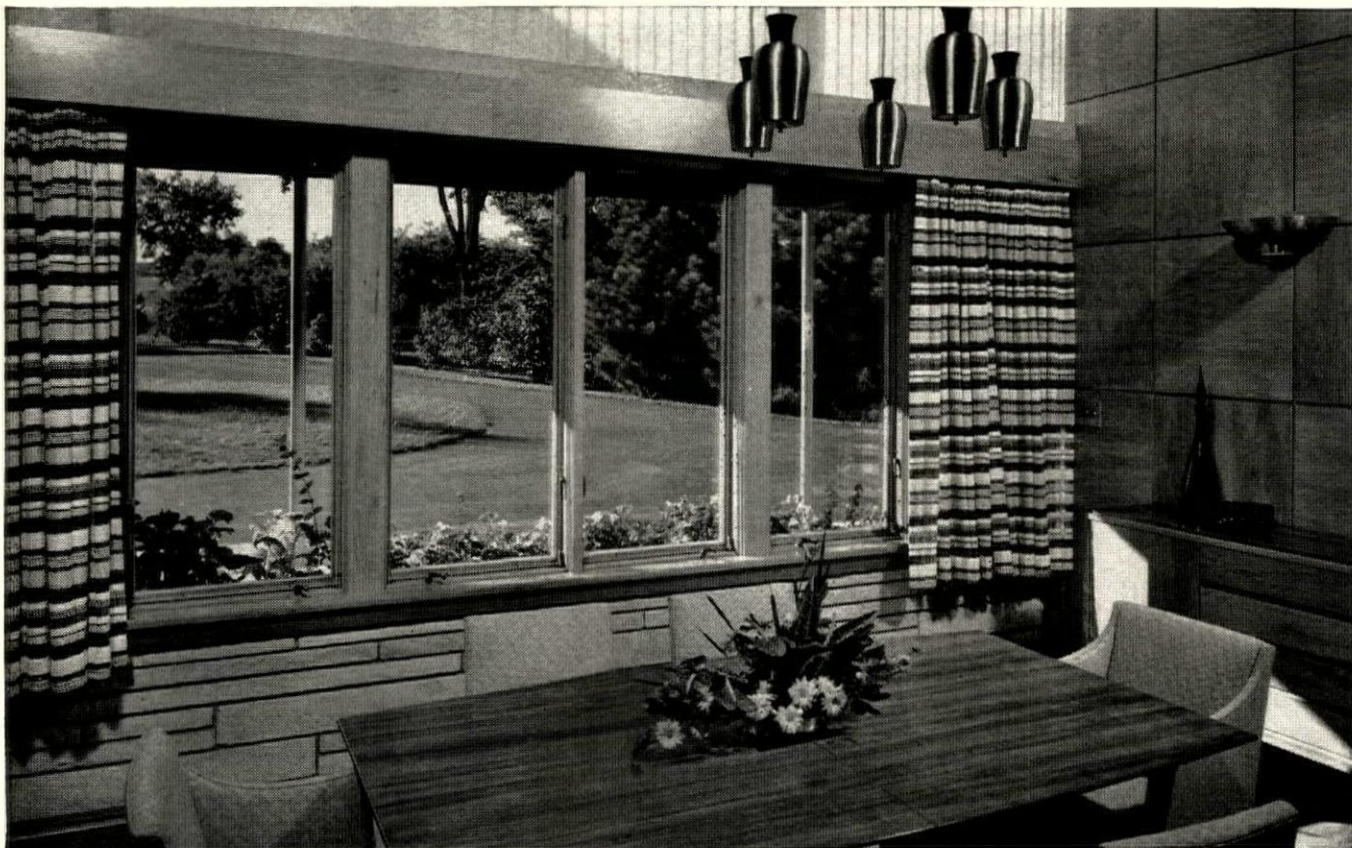

WILLIAM F. BERNBROCK, ARCHITECT; ERICSON CONSTRUCTION CO., BUILDER

MORE NICE THINGS ARE SAID ABOUT BUILDERS WHO USE
Pella **Casements with RolSCREENS**

That's because home owners with PELLA WOOD CASEMENT WINDOWS are assured of so many comforts and conveniences.

Like ROLSCREENS—the self-storing screens that roll up and down like window shades to eliminate seasonal maintenance work. Insulating glass stays in place year round, too—and is matched as a comfort maker by spring-type stainless-steel weatherstripping that surrounds all four sides of the sash. Convenience—that's the word for the way PELLA CASEMENTS can be cleaned from inside!

All these advantages come with PELLA WOOD CASEMENT WINDOWS—now available in glass sizes up to 24" x 68"—the largest wood casements available. Distributors throughout the U.S. and Canada. Consult classified section of your telephone directory.



ROLSCREEN COMPANY, Dept. J-71, Pella, Iowa

Please send me illustrated literature on PELLA CASEMENT WINDOWS.

FIRM _____

ADDRESS _____

CITY _____

ZONE _____

STATE _____

WOOD CASEMENT WINDOWS

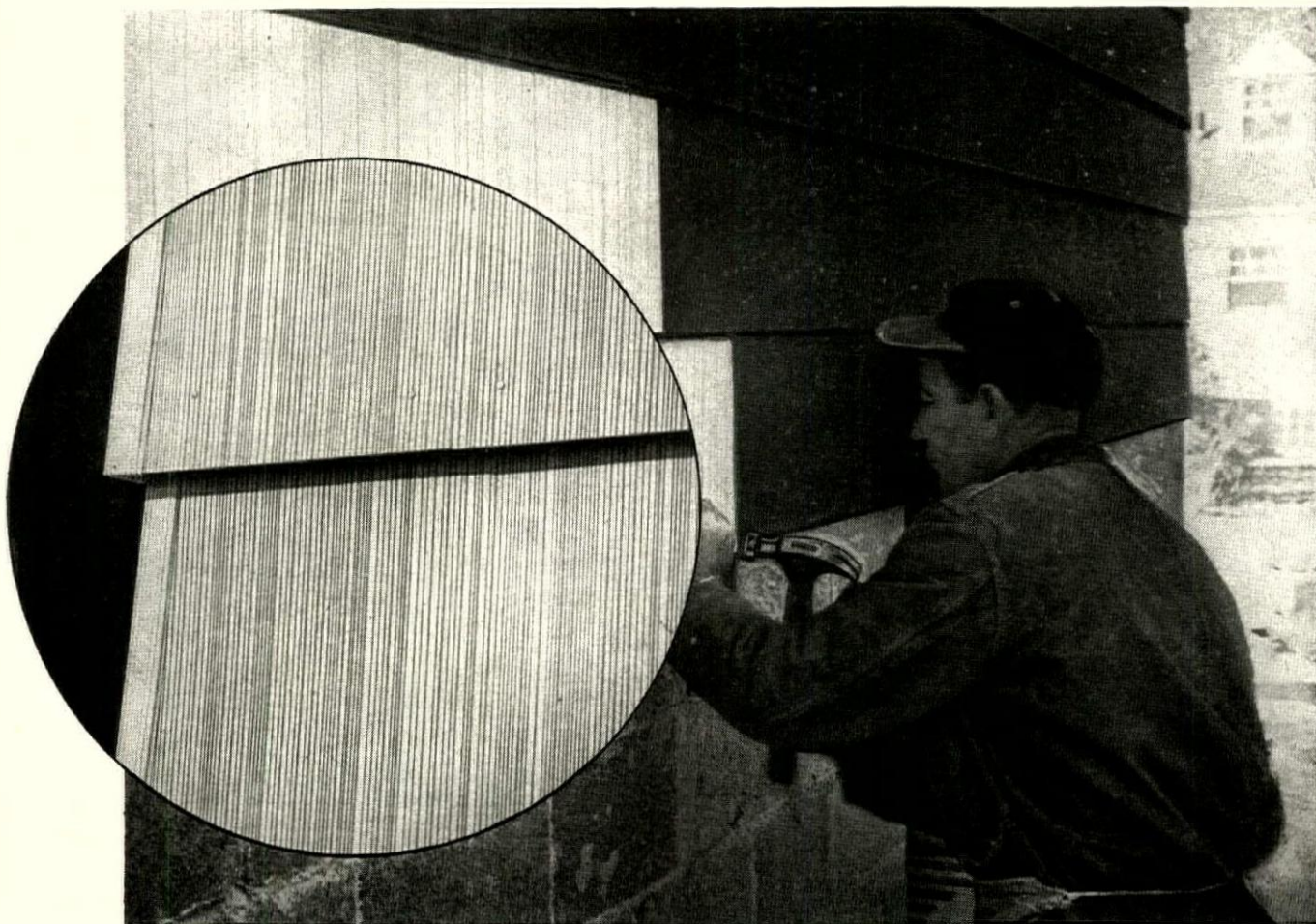

Now, luxurious "Custom-made" exteriors... faster, at less cost... with the new

Flintkote **Shado-Wall** **System**

Beginning today, you can give homes custom-styled sidewalls... at mass production costs. Thanks to another Flintkote first—Shado-Wall System for New Construction.*

This new Shado-Wall System saves you time and money, while adding unusual value to your homes.

Using 1" x 3" nailing strips you install Flintkote Shado-Sheathing over your exterior wall studs, eliminating the need for regular sheathing.

Then Flintkote Asbestos Siding

is easily and rapidly applied.

The result is a handsome, colorful sidewall with the distinctive deep shadows that say "Quality!" to home buyers.

And the combination of Flintkote Shado-Sheathing and Asbestos Siding provides extra insulation... increases wall rigidity to give both structural strength and eye-appealing beauty at the same time.

Flintkote Shado-Sheathing in 48" x 11 $\frac{3}{4}$ " x $\frac{1}{2}$ " strips serves as a self-aligning backerboard for the

Asbestos Siding. It is coated and impregnated to resist termites and moisture-penetration... and it will last for the life of the building.

Take advantage right away of the new Flintkote Shado-Wall System to give new homes the look of luxury at budget costs.

Phone your Flintkote Distributor or write for further information to: The Flintkote Company, Building Materials Division, 30 Rockefeller Plaza, New York 20, New York.

*TRADEMARK OF THE FLINTKOTE COMPANY



FLINTKOTE ...Style and Color Leader since 1901

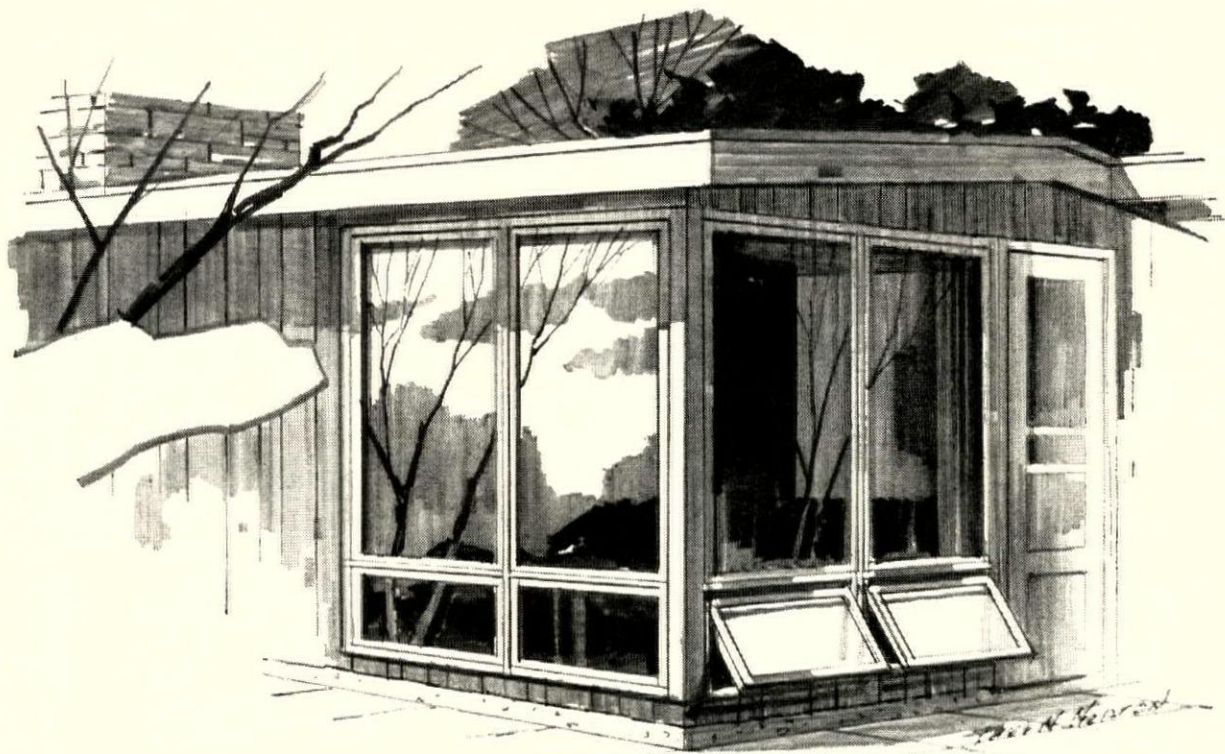

Fine windows like these ARE AN INVITATION...

...with a sales-loaded RSVP! PELLA MULTI-PURPOSE WINDOWS say it with self-storing screens and storm sash and an all-aluminum GLIDE-LOCK® underscreen operator.

Available in 12 modular, ventilating sizes, and 15 fixed sizes. For details on design possibilities and convenience features, see Sweet's Architectural File, or clip coupon today! Distributors in U.S. and Canada.

NEW twinlite "THE AWNING WINDOW WITH YOUNG IDEAS!"
Presents the appearance of a double-hung window with all the advantages of PELLA MULTI-PURPOSE UNITS. New removable muntins to enhance this traditional look are available. Diamond and horizontal patterns, too. Fixed unit at top, ventilating unit below; slim, trim joining mullion between. Eight sizes including picture window with ventilator.

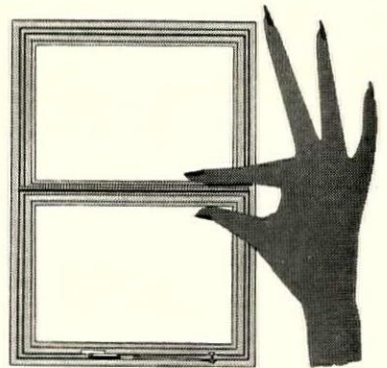

ROLSCREEN COMPANY, Dept. J-72, Pella, Iowa

Please send detailed literature on PELLA MULTI-PURPOSE AND TWINLITE WINDOWS.

FIRM NAME _____

ADDRESS _____

CITY _____

ZONE _____

STATE _____



M U L T I - P U R P O S E W I N D O W S

CHRYSLER—CENTRAL AIR CONDITIONING



by
AIRTEMP
helps you
nail the
sale!



More and more people are looking for central air conditioning in new houses. When they see the Chrysler name in homes *you* build, you're a lot closer to closing the deal. That's because Chrysler is a prestige name they trust. And because they know that any builder who uses Chrysler equipment has probably used top-quality materials in the rest of the house, too.

In addition to this sales appeal, Airtemp offers the builder—

- heating and cooling for *any* house, anywhere
- trouble-free operation that cuts after-sale complaints, helps build your reputation
- nation-wide distribution and servicing, prompt delivery
- effective, pre-tested sales-promotion materials

CHRYSLER

*For the facts, phone your nearest Airtemp outlet,
listed in the Yellow Pages. Or write to
Airtemp Division, Chrysler Corp., Dayton 1, Ohio*

Airtemp



*Designers John and Earline Brice
give a purely functional room new personality with*

PLASTIC WALL TILE

MADE OF STYRON

"It is easy to give a room real personality by styling the walls with plastic wall tile made of Styron[®]," say the Brices. "Styron colors are style-right. They're cleaner and clearer than most other types of tile. An infinite variety of designs and color combinations is possible."

The fresh new look of this laundry area is a look that sells! You can add this personalized styling all through your homes

with Styron plastic wall tile . . . wherever the look of luxury must be practical, too. Styron won't stain or water-spot . . . won't chip, peel or fade . . . wipes clean with a damp cloth.

Styron plastic wall tile helps you plan this sales-making decor for homes in any price range. THE DOW CHEMICAL COMPANY, Midland, Mich., Plastics Sales Dept. 1539.



YOU CAN DEPEND ON



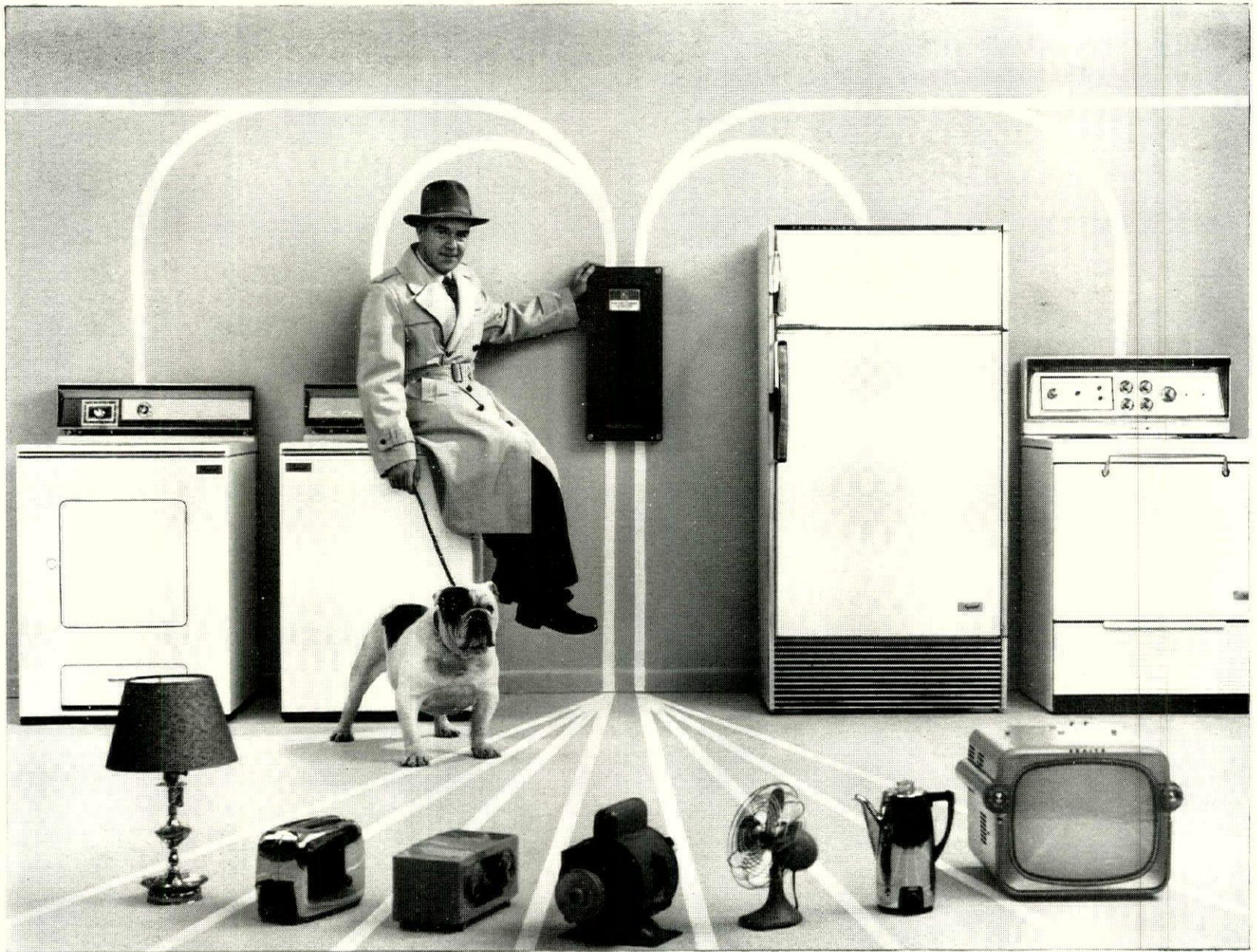

Pushmatic* protection plus plenty of circuits

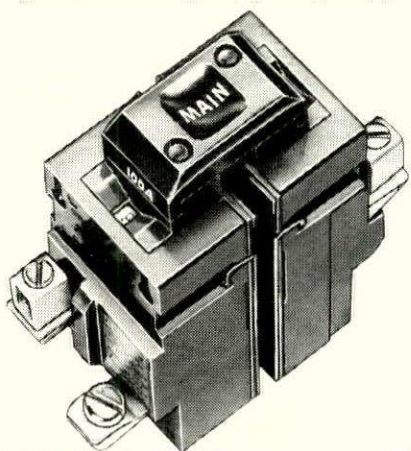

BULLDOG DUO-GUARD PUSHMATICS fit any Electri-Center panel. Main disconnects for each 100 amps of service prevent overloading of service entrance conductors. And Electri-Centers compare in price with ordinary panels.

*Circuit breaker trademark registered by Bulldog Electric Products Co.

Look at all these appliances! From small toasters to modern electrical heating, Bulldog Electri-Center® panels provide homeowners with all the circuits they need now . . . plus space to add new lighting and appliance circuits later.

In addition, exclusive Duo-Guard® Pushmatic breakers provide two-way circuit protection—guarding thermally against overloads, magnetically against short circuits. No fuses to change, either. When power is interrupted by an overload or "short", the simple push of a button puts the circuit back in operation.

Give your homes full **HOUSEPOWER** . . . maximum protection and convenience. Contact your electrical contractor or Bulldog field engineer for complete details on Bulldog Electri-Center panels.

© BEPCO

BULLDOG



Bulldog Electric Products Co., Detroit 32, Mich. A Division of I-T-E Circuit Breaker Co.
Bulldog Export Division: 13 East 40th St., New York 16, N.Y.
In Canada: Bulldog Electric Products Co. (Canada) Ltd., 80 Clayson Rd., Toronto 15, Ont.



HOW TO SAVE 30%+

on siding installation and painting costs and still maintain the quality and strength of natural wood.

SAVE 30%+ ON LABOR. Large, easy to handle 4' x 8' Simpson overlaid plywood sheets go up fast with fewer nails, less cutting, less waste, less bracing and blocking. **SAVE 30%+ ON PAINTING.** The overlaid surface has a unique velvety tooth that takes paint easier, saves paint and painting time, eliminates the need for sanding, sealing and patching. Two coats do the job of three and they last years longer between re-painting. Overlaid surface prevents checking and blistering. *Specify "Simpson Medium Density Plywood."* Write for free sample and additional information.



Simpson Medium Density Overlaid Plywood Siding is an exterior-grade fir plywood with a resin impregnated fiber (CREZON) bonded to one or both sides under heat and pressure. Color: yellow. Available through your dealer.

PD-81A

RELY ON



Simpson Logging Company
 Sales Office, Plywood and Door Products
 2301 N. Columbia Blvd., Portland 17, Oregon
 Regional Offices in New York, Cleveland, Chicago, Denver,
 Minneapolis, Memphis, Dallas, Los Angeles, Portland, Seattle.



**how to build
customer
satisfaction!**

Modernfold announces two great lines of folding doors...fabric and wood!

MODERNFOLD offers the greatest selection of quality folding doors in the industry. And now, MODERNFOLD introduces a complete line of new wood models...in selected, matched veneers, laminated to a solid core.

As always, MODERNFOLD's famous fabric covered doors provide a wide variety of wonderful weaves and patterns...all washable. Their double-strength inner-frame of steel delivers the ruggedness that insures lifetime service and shape-retaining good looks.

MODERNFOLD's research-proved superiority of construction alone is a winning sales-point. And MODERNFOLD delivers it in almost endless variety: stock doors, custom doors, economy doors, plus the new doors of wood.

MODERNFOLD's national advertising appears in *Better Homes and Gardens* and *Time*. But you can build customer satisfaction firsthand. Show the many MODERNFOLD features that mean extra quality.

Your MODERNFOLD Distributor is listed
under "Doors" in the yellow pages.

modernfold
DOORS

THE FIRST AND FINEST IN FOLDING DOORS

NEW CASTLE PRODUCTS, INC., New Castle, Indiana
Manufacturers of Folding Doors, Air Doors, Shower Enclosures,
Vinyl-coated Fabrics, and Peabody School Furniture.
In Canada: New Castle Products, Ltd, Montreal 23.

The new low-cost lock by **SCHLAGE**

TO THE TIME-PROVEN
STANDARD **A** SERIES, SCHLAGE ADDS
THE **J** SERIES LOCK FOR USE ON INTERIOR
DOORS IN LOW-COST RESIDENCES

No faceplate mortising with Schlage's surface-mounted unit

New installation flexibility
— J lock fits doors from 1 1/8" to 1 3/4"

Schlage cuts minutes from mounting time with preassembled screws

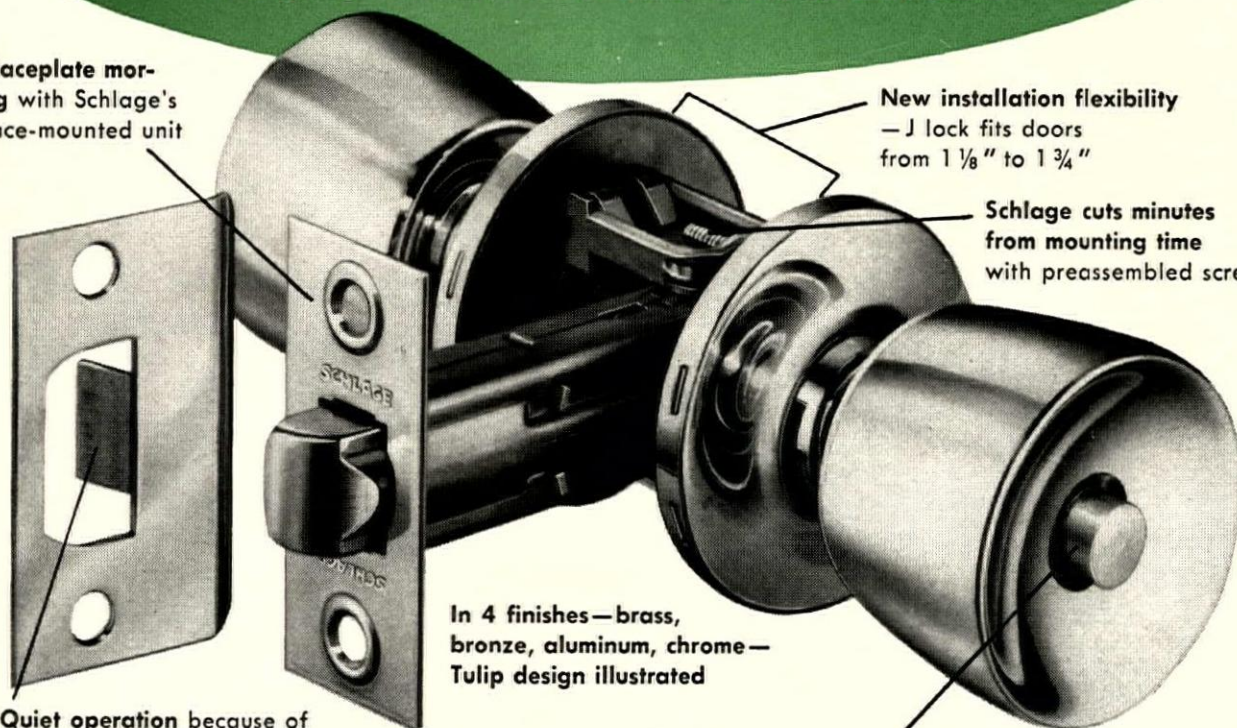

Quiet operation because of Schlage's anti-rattle adjustable strike tongue

In 4 finishes—brass, bronze, aluminum, chrome—Tulip design illustrated

All-steel construction means longer life

Schlage push-button makes lock panic-proof, lockout-proof

For exterior doors —The standard A series residential lock. Tulip and Plymouth designs of the A series are matched by similar designs in the J lock.

AMERICA'S MOST DISTINGUISHED LOCK BRAND

For information contact your jobber or Schlage representative, or write Dept. BA-4 P. O. Box 3324, San Francisco, 19. Schlage Lock Company... San Francisco... New York... Vancouver, B. C.





FROM SOUTH new MIT solar house is one big (40' x 16') heat collector, tilted at 60°—perpendicular to winter sun in this latitude.

New England house brings solar heating a step closer



FROM NORTH-EAST house looks much like an ordinary Contemporary. Construction and insulation are mostly standard. But wall supporting collector is extra heavy (2x10s, 16" o.c.), and earth mounded against north and south walls cuts heat loss.

With this new solar house in Lexington, Mass., latest (and No. 4) in a series of experimental houses, MIT architects and engineers think they've licked two of the three big problems involved in heating a house with energy from the sun:

1. *"The engineering problem—designing an efficient solar heating system—has been solved."* The engineers calculate that even in Boston's cold and often gloomy climate, the system (diagrammed opposite) will supply 75% to 80% of the heat the house will need. It stores enough heat to carry the heating load through one sunless day in very cold weather, up to three sunless days in less severe weather. If the sun stays hidden longer, a conventional oil-fired boiler supplies the supplementary heat needed. (In cold climates a supplementary system is cheaper to install than the massive heat storage equipment needed for 100% solar heating.)

2. *"The architectural problem—handling the huge and ungainly heat collector—has been solved."* The architects feel they have created a handsome and livable house. And they think at least a reasonable number of Contemporary-minded home buyers will agree with them.

3. *But the cost problem—the high first cost of solar heating equipment—has not yet been solved.* As the design staff knew from the start, this system costs too much (over \$6,000) to compete with a conventional system. But if the first cost could be cut to \$2,500—and MIT experts think it can with more efficient manufacturing and installation methods—the 75% saving in fuel costs would amortize the big extra first cost quickly enough to make solar heating competitive with conventional systems.

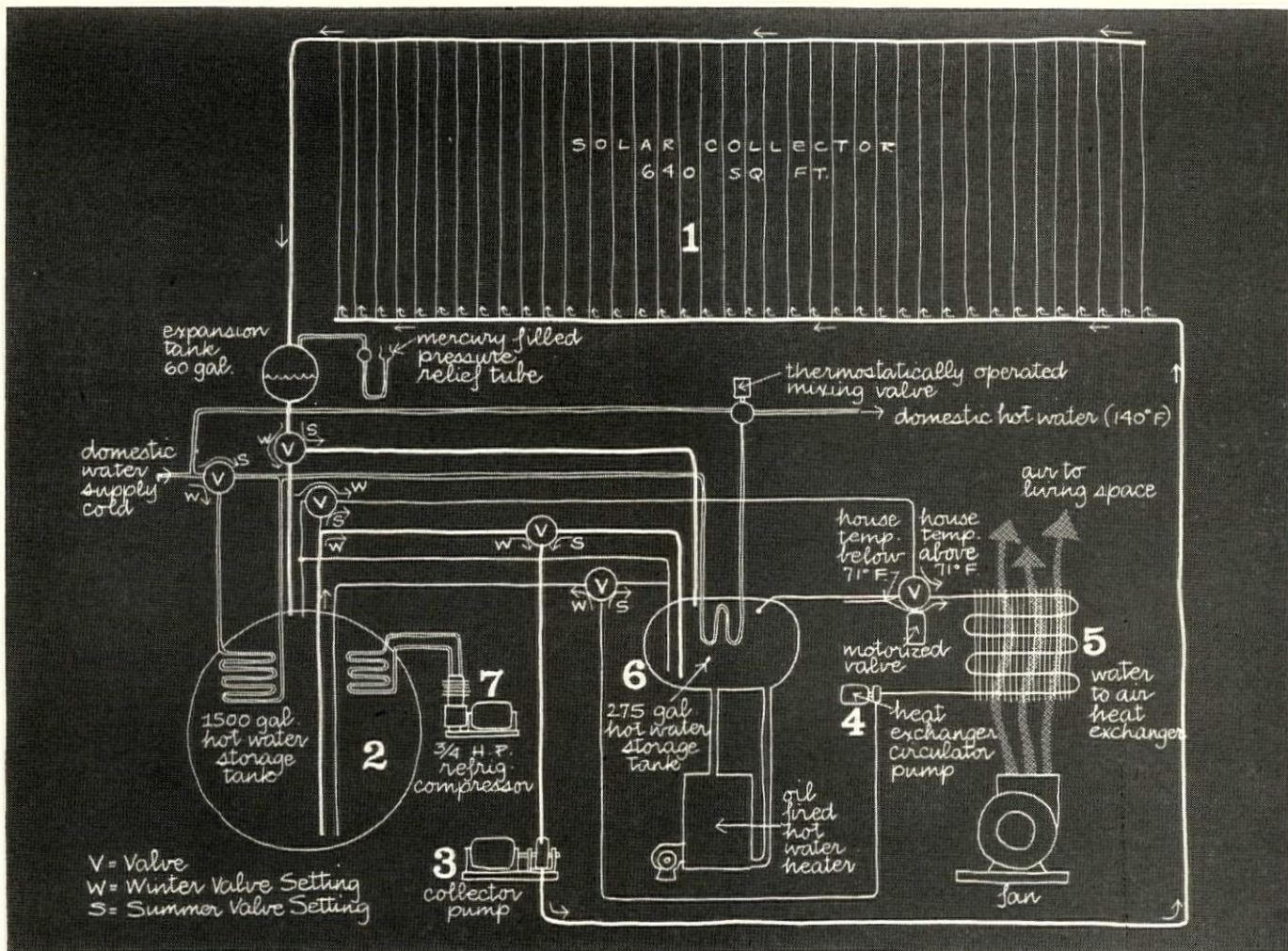

OPERATION OF THE SYSTEM, except for a twice-a-year summer-winter changeover, is entirely automatic.

Key to the system is the big solar collector. It consists of a thin, black-painted aluminum sheet, with $\frac{3}{8}$ " copper tubes clamped to it on 5" centers. $\frac{3}{4}$ " over this collecting surface are two layers of glass.

Here is how the system operates in winter:

Whenever the temperature in the collector—(1) on diagram—is higher than the temperature of the water in the large hot water storage tank (2), the collector pump (3) pulls water from the bottom of the storage tank, pushes it through the collector. After being heated on its trip through the collector, the water runs back, enters the top of the same storage tank. (On a sunny day this process can boost temperature of the water in the tank as much as 10° every 80 minutes.)

When the house thermostat calls for heat, a circulator pump (4) draws water from the tank, runs it through a water-to-air heat exchanger (5). It warms air which is forced through ducts into the house.

If the water in the tank is below 95°—as it would be after a day or so of sunless weather—it cannot heat the air enough to maintain desired temperature in the house. So, after the house temperature has

dropped another degree, a second contact is made in the thermostat which causes water from the small oil-heated tank (6) to flow through the heat exchanger. This water is always hot enough to warm the house, and when the temperature in the house rises 1°, the system is thrown back on the solar-heated tank.

Domestic hot water is heated by passing cold water through a coil in the solar-heated tank and then through another coil in the oil-heated tank. This assures that the hot water supply will be at least 135°.

For summer operation, the furnace is turned off, and valves are set to connect the small storage tank (6) to the roof collector. So, during the summer, solar energy is used to provide hot water for domestic use.

The big tank is allowed to cool, and then a small (¾ hp.) compressor (7) is applied to chill the water in the big tank to 45°. When the house temperature rises above 75°, the circulator pump draws this chilled water through the heat exchanger, and cooled air is delivered through the ducts to the living spaces.

On occasional cool nights, hot water is automatically drawn from the small tank and run through the heat exchanger to warm the house. If still more heat is needed, the furnace can be switched on.

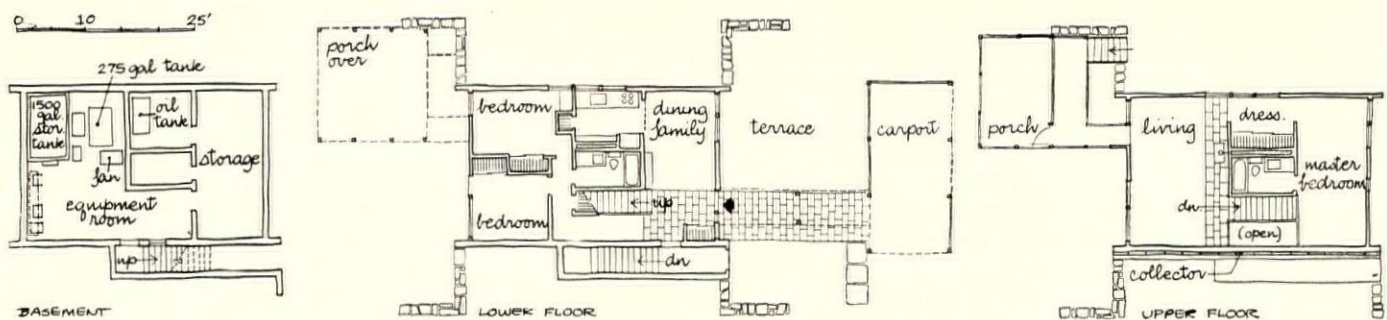

PLAN shows how half of basement is taken up by heating equipment. Spread out to make easy access for engineers taking readings, equipment could be much condensed in future houses. There are 1,450 sq. ft. of living area on floors above. Lower floor (which is below collector,

not affected by it architecturally) has two bedrooms and a bath, well isolated from activity areas. Upper floor, smaller and less flexible because of the tilt of the collector, includes the living room and master bedroom suite. Elevated screen porch acts as living room "terrace."

AIR CONDITIONING SOLD THIS HOME!



**“We’ve sold 50% of our homes with air conditioning
—it’s the main buyer interest”**

... says R. R. Harris, Owner, R. R. Harris Company, Nashville, Tenn.

“For the last three years, one out of every two buyers of our homes has insisted on air conditioning,” Mr. Harris continued. “This year we’ll build more homes than ever and include air conditioning in about ⅔ of them. Air conditioning gives us a definite competitive advantage—it’s our main buyer interest.

“We combine the cooling function with central heating by using the new Fedders 3 H.P. *Adaptomatic* heat pump unit to do both,”

continues Mr. Harris. “Our heating and air conditioning contractor, Walter Keith Co., gives us excellent service and does a very good job on the installations. They engineer the job, supervise it and take care of service warranties. Even with our oldest installation, we’ve had no trouble of any kind. We have the utmost confidence in our contractor and in Fedders equipment that’s factory-charged with Freon* refrigerants.”



Always insist on units charged with “Freon”—today’s best-known refrigerant

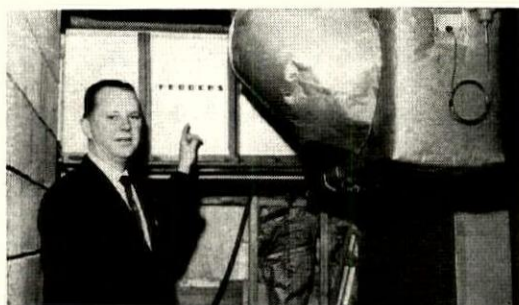

MR. WILLIAM SIMS, President of Walter Keith Co., shown at a Fedders heat pump installation in one of Mr. Harris’ houses. Since using Fedders units factory-charged with “Freon”, Mr. Sims has never had a service call on one of his installations.

For the homes you build, be sure the cooling systems are charged with “Freon” refrigerants. “Freon” helps assure the efficient, trouble-free performance your buyers expect. “Freon” is acid-free, dry and safe.

In a recent poll of owners of home air conditioning, 35% of respondents readily identified “Freon” as the refrigerant in their units. “Freon”

was the only refrigerant known by name—an impressive measure of its widespread acceptance.

To learn how air conditioning has helped others sell homes, send for the free brochure “What Successful Builders Think of Home Air Conditioning.” Write: *E. I. du Pont de Nemours & Co. (Inc.)*, “Freon” Products Division 144, Wilmington 98, Delaware.

FREON® REFRIGERANTS

*Freon and combinations of Freon- or F- with numerals are Du Pont’s registered trademarks for its fluorinated hydrocarbon refrigerants.



BETTER THINGS FOR BETTER LIVING
... THROUGH CHEMISTRY

HOUSE & HOME

NEW! and packed
with profits!



the virden
Sunshine® Ceiling

V-8046. Complete packaged ceiling \$73.25 list.
Slightly higher west of the Rockies.

**A 4' x 6' "Packaged" Unit for Bathrooms, Kitchens
For New Homes...Old Homes...Modernization**

The new Virden Sunshine Ceiling.* A complete packaged unit that installs quickly and easily to any ceiling surface. Electrical channel system fastens to ceiling — satin white suspended grid holds plastic diffusers (8½" drop). Uses six 100W incandescent lamps to flood the room with even, glare-free "sunshine". A sure-fire sales clincher in new homes. A terrific plus-profit maker for use in existing homes or on modernization jobs.

Luminous ceilings promise to be the next big development in home lighting. Virden brings it to you now in a complete easy-to-install

package. Plan now to use it in your next job, new or old. See the model now on display at your Virden distributor, or write John C. Virden Co., Dept. HH, 6103 Longfellow Ave., Cleveland 3, Ohio.



virden

Member American Home Lighting Institute

* Patent No. 2,659,807



Bill Beck and his box of blocks . . . What's in it for you?

You don't need a fancy paperwork system to control production. Simple, visual controls work just as well, if not better. That's what many builders can learn from Bill Beck's controls: the box of blocks he is scanning in the photo.

Beck, who builds a wide variety of houses in Midland and Odessa, Tex., set up his controls to keep his complex operation flexible.

"Now," he says, "I can build up to 90 different plans at once without tripping myself up." The box of blocks, which he keeps in his office, gives him a day-to-day picture of his operation and shows progress on each house.

How the system works. The box is divided into 10 columns—one for each stage in Beck's building schedule (see drawing below). This breakdown hap-

pens to suit his operation, but he feels his control system would work just as well for a building schedule divided into fewer or more stages.

Each block represents a house. Marked on it are: the address, square footage, starting date, type of financing and whether a loan has been approved. Within each column, blocks are arranged from top to bottom in order of priority. When one building stage on a house is finished, the block representing it is moved to the next right hand column.

Beck checks the control box daily, updates it on the basis of progress reports from Ott Cloud, his construction vice president. He uses it to schedule work, then dictates orders to Cloud, subcontractors and suppliers.

His system tells him when a house

is behind schedule (he simply checks against the starting date) but not what's causing the delay. To find out, he checks with Cloud.

How the system pays off. Says Beck: "These controls serve as signals. They tell me when to make decisions and what I need to know before making them." He sees three broad benefits in his system:

1. Better scheduling. "I can tell at a glance how best to use my labor, when to order material and when to re-plan because of weather delays."

2. Faster problem solving. "I can spot snags and slowdowns, then put the pressure where it belongs."

3. Better use of capital. "I can turn working capital faster by giving priority to sold rather than unsold houses."

STAKE- OUT FOOTING	FORMS & PLUMBING	POUR SLAB FRAME OS WALLS RAISE ROOF	DUCTWORK WIRING OUTSIDE TRIM	SHEETROCK TAPE & BED VANITIES	INSIDE TRIM CABINETS FURNACE EGGHELLS	CERAMIC TILE PAINT BRICK	PLUMBING WIRING FLOOR TILE	CARPET WINDOWS CLEAN FINAL PICTURES	COMPLETED BUT UNSOLD
1	2	3	4	5	6	7	8	9	10
CONV. APPROV. 7/17 12 GULF	GI 7/15 APPROV. 422 LOCUST	GI 7/16 APPROV. 421 LOCUST	FHA 4/29 APPROV. 342 CLEAR	GI APPROV. 340 WEST	GI 4/12 APPROV. 2102D ST	GI 5/5 APPROV. 470 MAIN	GI 4/18 APPROV. 472 MAIN	GI 4/15 APPROV. 340 EAST	CONV. APPROV. 4/10 310 WEST
GI 6/5 APPROV. 1001 MAIN	GI 7/15 APPROV. 421 DUREAN	FHA APPROV. 420 DAWN	GI APPROV. 344 CLEAR	GI APPROV. 400 D ST	CONV 5/21 APPROV. 526 LOCUST			CONV. APPROV. 5/12 215 N ST	GI 5/12 APPROV. 425 LOCUST
GI 7/25 APPROV. 421 LOCUST	CONV. APPROV. 7/15 2001 D ST	GI 4/4 APPROV. 806 GULF	GI 7/2 APPROV. 300 D ST	CONV 6/18 APPROV. 420 LOCUST	GI 4/18 APPROV. 428 LOCUST			CONV 5/30 APPROV. 240 N ST	CONV 5/15 APPROV. 427 LOCUST
FHA 4/28 APPROV. 1415 MAIN	GI 7/15 APPROV. 215 MAY	FHA 7/12 APPROV. 430 LOCUST	FHA 7/3 APPROV. 151 MAIN	GI 4/18 APPROV. 440 WEST	GI 4/18 APPROV. 430 MAIN			GI 6/11 APPROV. 2000D ST	GI APPROV. 7/15 315 SIMCLAIR
	FHA APPROV. 7/17 341 CLEAR	GI APPROV. 7/14 440 LOCUST							GI APPROV. 3/15 320 WEST
	FHA APPROV. 7/18 342 CLEAR	GI 7/16 APPROV. 442 LOCUST							CONV 5/20 APPROV. 240 KANSAS
		GI 7/15 APPROV. 462 LOCUST							GI APPROV. 340 WEST
		GI 5/30 APPROV. 420 DALOTA							CONV 5/25 APPROV. 422 DUREAN
		CONV. APPROV. 7/11 2001 D ST							CONV. APPROV. 5/20 434 DUREAN
		CONV. APPROV. 7/11 100 MAIN							GI 4/10 APPROV. 320 KANSAS

TYPICAL TROUBLE SPOTS revealed by Beck's controls are: 1) too many houses (10) at rough framing stage for one crew to handle; 2) too few houses in final building stages; 3) too many completed houses unsold or unfunded by final mortgages. Beck's remedies: 1) split the framing crew in half and add men; 2) put pressure on subcontractors for wiring, drywall and cabinet work; 3) stress sales, and put pressure on loan companies. Ideal situation: the same number of houses at every building stage.

continued on p. 174



WHEN THEY OPEN THIS SHOWER DOOR* . . . YOU CLOSE THE SALE

Distinctive yet functional—GULFSPRAY shower doors and tub enclosures are certain to evoke appreciative comment. Home buyers recognize that they eliminate laundering and replacement costs necessary with shower curtains. And they end almost entirely the annoyance of damp and untidy floors.

* "TexLide "standard" tub enclosure . . . combines good styling and clean design with all of the visual splendors of the harmonious blending of shining aluminum with either clear or obscure 7/32" glass. Take advantage of such fine features as precision engineering, complete shop fabrication, glazing with extruded vinyl plastic which cushions glass against shock and vibrations, smooth gliding overhead track with silent rollers, special safeguards against leakage and elegant but sturdy aluminum extrusions.

Installation? A breeze! One man can install this unit quickly

and easily. Has built-in jamb adjustment for uneven walls to speed erection. TexLide doors are interchangeable right or left, finished in Brite aluminum to match chrome bathroom fixtures and come complete with towel bar. Standard sizes to fit 4, 4½, 5, 5½' recessed tubs.

Saves on construction cost by converting tubs into enclosed showers.

In spite of the many "extras" you'll find these units moderately priced.

There's a catalog describing the complete line of Gulfspray tub enclosures, shower doors, sliding glass walls, and mirrors waiting for you if you write.

B GLASS SINCE 1872
Binswanger
AND COMPANY

207 NORTH MAIN ST. • P. O. BOX 3051 • HOUSTON 1, TEXAS
The name BINSWANGER is your assurance of 85 years of quality.

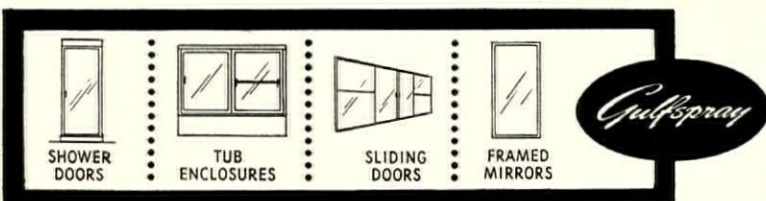

K-LATH

BETTER BUILDING AT LOWER COST



CERAMIC TILE

Drainboard, Wall and Floor Reinforcing
— Approved and specified by the Tile Council of America
— Galvanized to last
— Self-furred to put mesh into the slab
— 90% less nailing
— Lays flat
— Custom cut in sizes to eliminate job cutting

Drainboard decks 20" x 50" and 24" x 50"
Small floors 28" x 50"
Larger areas 28" x 98½"

SOFFIT AND PORCH CEILING

— Twice as strong
— One-third lighter
— Galvanized for life

— Saves 25% on material
33% on hand application jobs
50% on machine lathing and plaster application

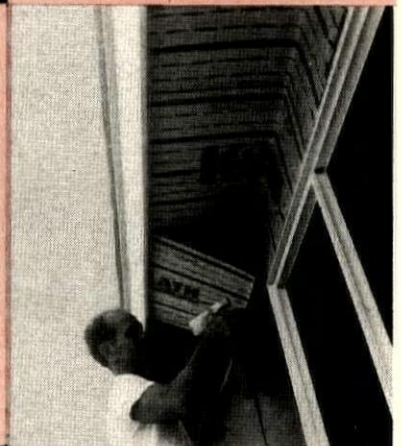

STONE AND BRICK VENEER

— Galvanized
— Strongest possible wall
— Saves time on application



K-LATH, the steel wire, electrically welded mesh and lath is specified for schools, office buildings, and hospitals where maximum strength and permanence is required.



For complete information and name of dealer near you, write:





"You'll sell more houses if you put porches on them"

That statement comes from Joe Eichler of Palo Alto, Calif., a leading builder of contemporary homes (up to 850 sales a year). He says the rear porch above is a top feature of his best seller, a four-

bedroom, \$23,000 model.

"Porches make sense, even on contemporary homes," says Eichler. "They meet today's demand for indoor-outdoor living and still provide shelter."

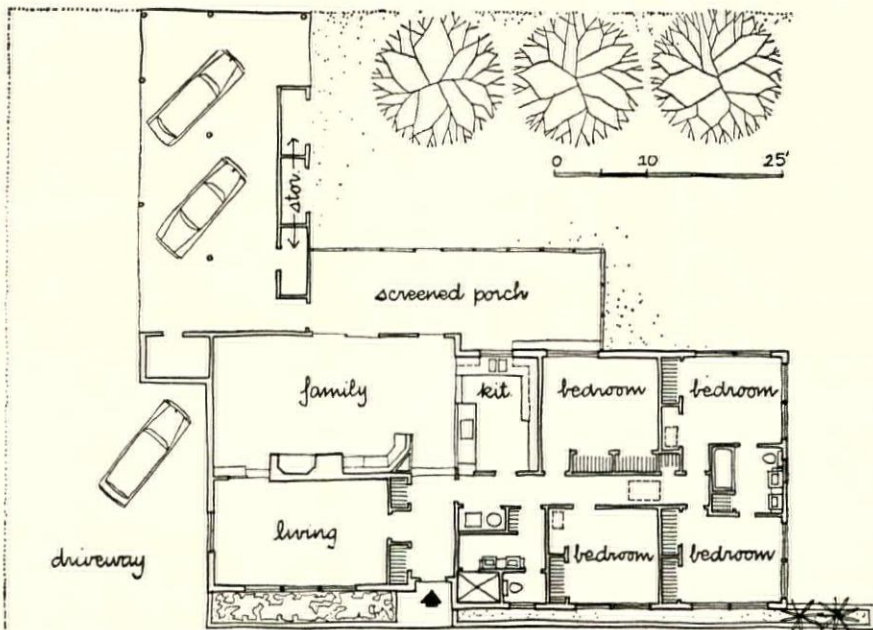
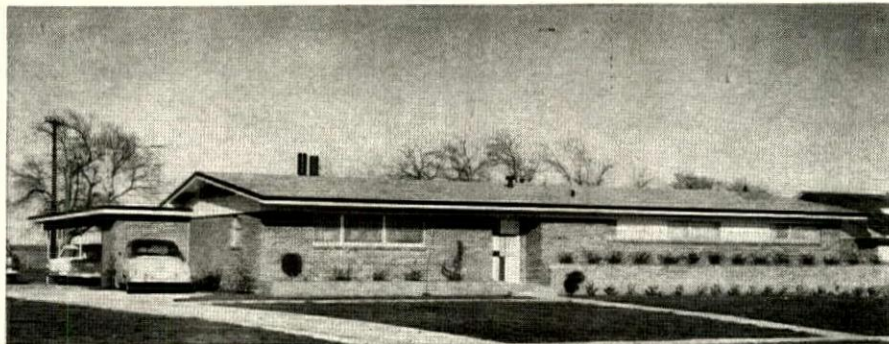

Here's a carport idea for houses with long fronts

Put the carport behind the house, and design it for angled parking, as was done with the house above.

The rear location almost hides the carport from the street, saves space next to the house, creates backyard privacy inside the "L" formed by the carport. Angled parking makes it easy to enter

the carport, eliminates the need for a costly turn-around area. Also angled is extra parking space off the driveway.

The house was built for a mortgage-firm official—John D. Hughes, city loan supervisor in Dallas for Bankers Life Co. The designer was J. M. Zollicoffer, the builder Robert Housley.

Sales boosters

Put your buyers to work for you, suggest Louisville Builders George Martin and Jesse Bollinger, who hire their early purchasers as model house demonstrators. "They know the houses because they live in them," says Martin, "and they sure make a contribution when we have a lot of traffic."

Luxury look in low-priced houses is what big Builder Al Branden (2,000 houses a year) gets by exposing laminated beams and "combing" a shadow pattern on his exposed 4 x 4 rafters. His houses sell for \$12,000 to \$14,000 in Hayward and Sunnyvale, Calif.

"House with a future" is how Rochester, N. Y., Builder Joe Entress bills his new expansion-attic homes. He concentrates on the lower-cost market, finds he can sell more house for less money if it has an expansion attic. His basic house has 864 sq. ft. of living space plus almost half that much in the unfinished area upstairs. Its price: \$12,800.

Build community spirit with "paint and plant" contests, urges John E. Bauer, former NAHB secretary and president of Precision Homes, Indianapolis prefabber. His company's merchandising brochure suggests that developers make cash awards to residents doing the best job of landscaping and painting their homes. Bauer points out: "A good neighborhood enhances your reputation as a builder."

Stuffers with utility bills advertise Perma-Bilt Homes in Sacramento, Calif. The local utility company sends 100,000 Perma-Bilt ads along with monthly utility bills to Sacramento residents. In return, Perma-Bilt specifies gas appliances in its houses.

Home phone numbers on their business cards are helpful to Real Estate Brokers Alan Powell and Sid Weston, who sell development homes built by Brown & Kauffmann in Sunnydale, Calif. (H&H, Dec. '57). Explains Powell: "Even in a tract of merchant-built houses, we want people to know we're working for them 24 hours a day."

Pitch to women works well for Lady Builder Camora Cone of Houston. She promotes her houses as "The Woman's House," emphasizes they are designed by and for women. She offers a good buy, too—1,380 sq. ft. of space, plus garage, for \$13,950.

Moviest man in Topeka, Kan., could well be Builder Jack Sargent (Jayhawk Construction Co.). Every year he and his wife move into one of his new houses. Why? "To keep up with the times," says Sargent. "We get the buyer's view of the new features in the house and find out if they're good enough to go into future models."



UNSEALED

SEALED

See the difference in one coat of paint!

SPECTACULAR
NEW SHORTCUT!

G-P Redwood
FACTORY-SEALED* SIDING

**Patent applied for*

Saves time, labor and up to 1/3 on paint!

New G-P Redwood Factory-Sealed Bevel Siding means dramatic savings because —

- Paint or stain flows on faster, covers better, lasts longer!
- No back-priming on the job! *All* surfaces are immersion-sealed right at the mill.
- This revolutionary new sealer prevents water-spotting, inhibits mold. Smudges, footprints wipe off.

Protective packaging makes it faster to handle, safe to store at job site! G-P special heavy-duty, plastic-coated paper, heat-sealed to keep out dust and moisture, protects siding until used.

Call your G-P Redwood dealer, or mail coupon for information about new G-P Redwood Factory-Sealed Bevel Siding.

World's largest producer of Plywood & Redwood



GEORGIA — PACIFIC
CORPORATION

Dept. HH 458, Equitable Bldg., Portland, Ore.
Please send me complete information on new
G-P Redwood Factory-Sealed Bevel Siding.

NAME _____

COMPANY _____

ADDRESS _____

CITY _____ STATE _____



General Electric *Thinline* air conditioners are one of the most talked about sales features of these Sherman Woods Homes.

General Electric Thinline Air Conditioners Help Builder Sell Out 50-Home Development

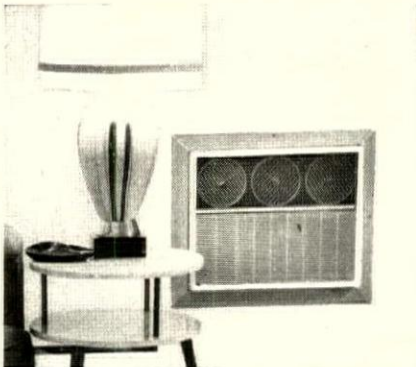

Inside the *Thinline* air conditioner blends with the décor of your room.



Outside the attractive aluminum grille keeps its good looks for years.

"BUYERS expect extras in our price range—\$28,000 to \$32,000—so we put in General Electric *Thinline* air conditioners," says Gino Fubini, builder of Sherman Woods Homes in New York's suburban Westchester County. "We advertised this 'extra' and they bought us out."

"We chose *Thinline* room units because they are easy to install and backed by G-E service. All our buyers are satisfied. Many of them have commented

on the quiet, draft-free comfort."

Easily installed *Thinline* air conditioners add built-in comfort to your homes—throughout the entire house or for any selected area. No expensive plumbing or ductwork is needed; no floor or window space is wasted.

There's a *Thinline* air conditioner for every need. Ask your General Electric distributor for full details. General Electric Company, Appliance Park, Louisville 1, Kentucky.

Progress Is Our Most Important Product



GENERAL ELECTRIC

General Electric Thinline air conditioners are easy to install.

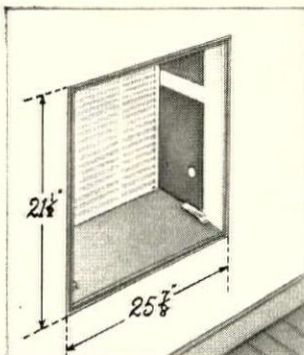

Case is installed during construction—mounts in any kind of wall. Panel protects opening until building is completed.

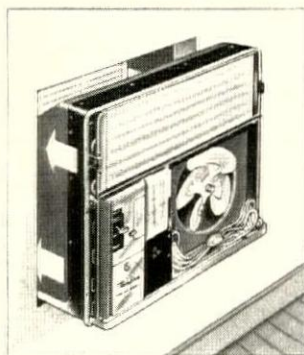

Thinline unit slides into case later. Gives you a quick and weather-tight seal. All models fit into the same case.

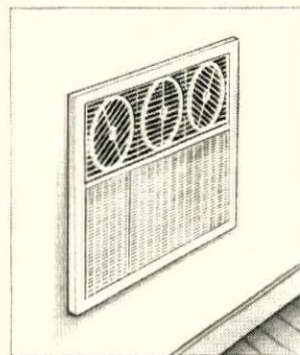

Add appearance front, air grilles. *Thinline* unit is ready to run. Grille can be painted to match décor.

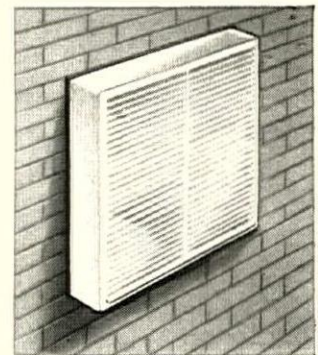

On the outside the aluminum grille will keep its good looks for years. It's easy to paint to match the exterior.



PLUS VALUES

...mean
faster sales
for you

Sales come easier when you feature ALWINTITE windows and doors with their many PLUS VALUES. To prospective home buyers their fine workmanship, beautiful luster-dip finish, and easy, effortless operation are all visible evidence of quality construction.

Builders, too, welcome their many PLUS VALUES, such as no costly service call-backs, prompt deliveries from local area warehouse stocks, reliable distributors with factory-trained window specialists at your service. For the complete story, see your local ALWINTITE distributor or write us direct.

ALWINTITE
by **GENERAL BRONZE**
GARDEN CITY, N.Y.

ENSEMBLE - OLEG CASSINI

ALUMINUM WINDOWS • SLIDING DOORS

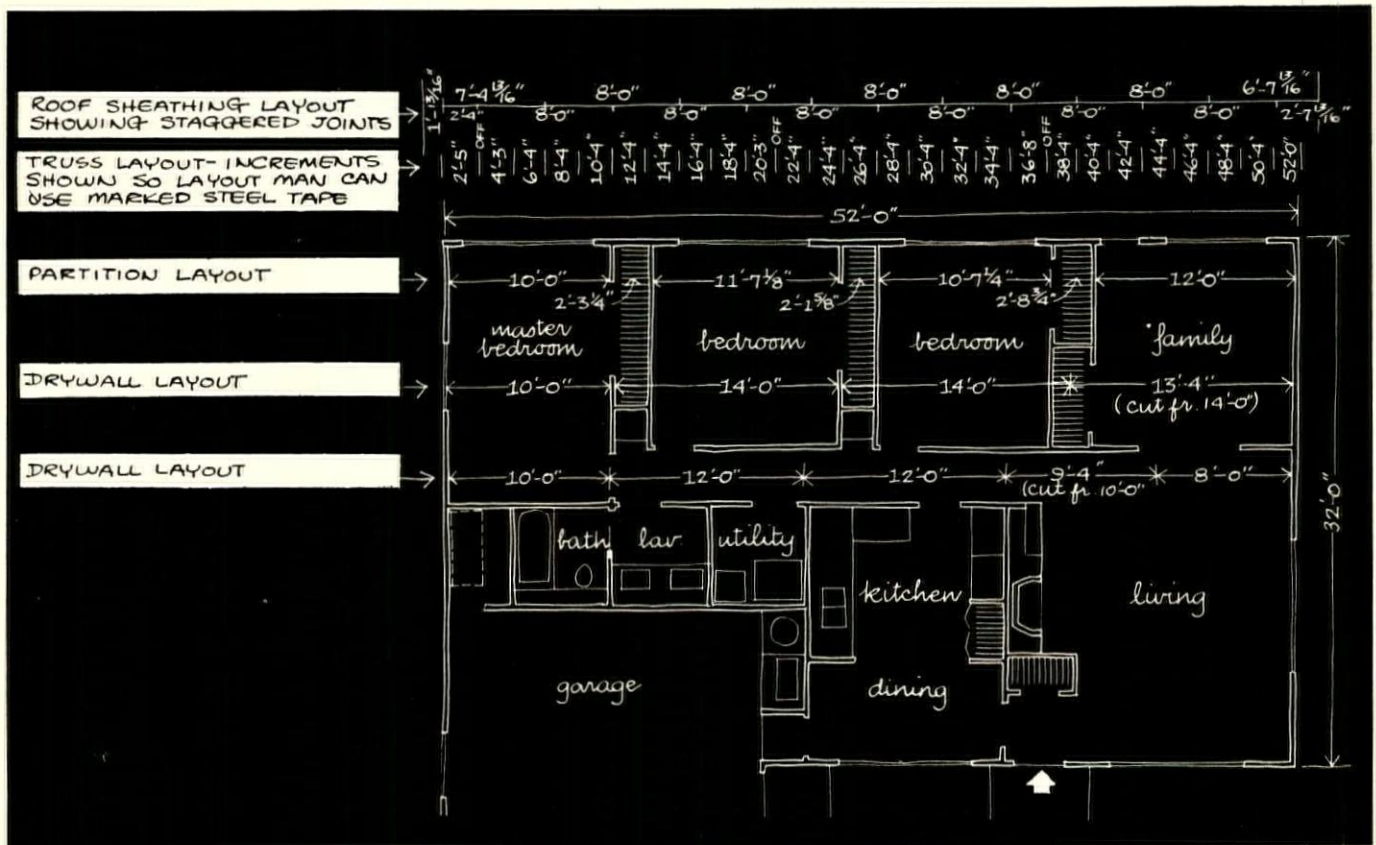

"I save \$100 a house by blueprinting each piece of material"

On floor plans like the one above, Builder Bob Schmitt of Berea, Ohio, includes layouts of his roof sheathing, trusses, partitions and drywalls. His idea: to save labor and materials by showing his men where each piece of material goes. Here are three savings he gets from extra details on blueprints:

1. He eliminates almost all cutting of roof sheathing (he uses 4'x8' plywood sheathing over trusses mounted 2' o.c.)
2. He reduces waste of long (10' and 14'), economical drywall sheets. Blueprints show where to use long sheets, when to cut them, how much to

- cut and where to use cut-off pieces (in closets).
3. He reduces taped joints on drywalls, because his partition layout is designed to cover most joints (he builds on the one-room principle—puts drywall on the ceiling and outside walls before erecting partitions).

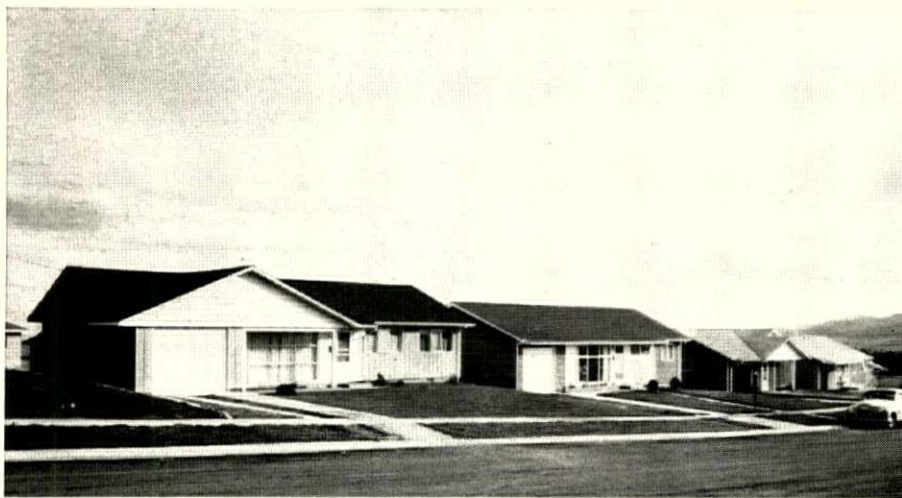

These houses were partly prefabricated 1,000 miles away

"It's cheaper to ship partly prefabricated components from west to east," says Sales Manager Eldon Reiley of West Coast Mills. That's why the houses above, erected by Smart Realty in Colorado Springs, were prefabricated by West Coast in Chehalis, Wash.

West Coast Mills (brand name—Farwest Homes) has been shipping more

and more of its products eastward. As a result, the company has now located its sales office near Toledo, Ohio, in the heart of the so-called Prefab Triangle.

Reiley says the Pacific Northwest should be the "Detroit of prefabricated houses—the lumber is here, the plywood mills are here and we get good freight rates shipping east."

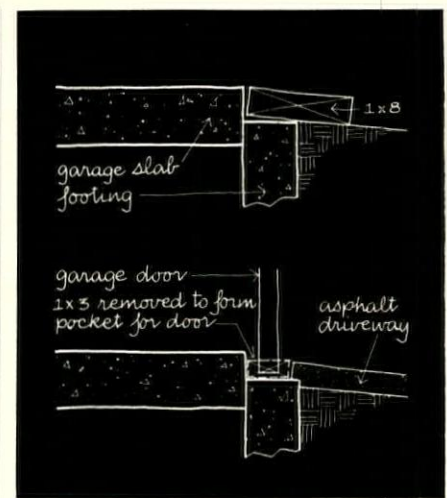

Cure for wet garages

You can keep driving rains from infiltrating under garage doors, says Ray K. Cherry of Hadley-Cherry, Los Angeles. The sketches above show how. Lay a 1x8 flat to form the edge of the garage slab; place it so the garage door will overlap the edge. To leave a pocket for the door, lay a 1x3 in the same place when you pour the driveway.

New! The Andersen Strutwall

... a new component that joins window and wall!

A man in a dark suit, white shirt, dark tie, and a dark bowler hat stands next to a large wooden window frame. He is smiling and pointing his right hand towards the window. He is holding a rolled-up document or blueprint under his left arm. The window frame is made of dark wood and has a small square logo on the upper left pane. The background is a plain, light-colored wall.

SAVES LABOR!

Cuts installation steps $\frac{2}{3}$ rds . . . saves materials! Conventional windows require three installation operations (framing, installing window, finishing), around 22 separate steps. But the new Andersen Strutwall needs only one operation—seven steps. It also eliminates the two long cripples standing on either side of conventional window below. Saves buying, cutting, fitting all the window members in front of conventional window below. Waste is practically eliminated.

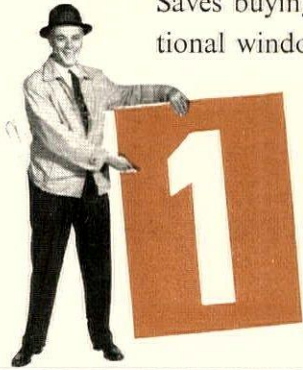

operation instead of...



New Strutwall

1. OPERATION (7 simple steps)

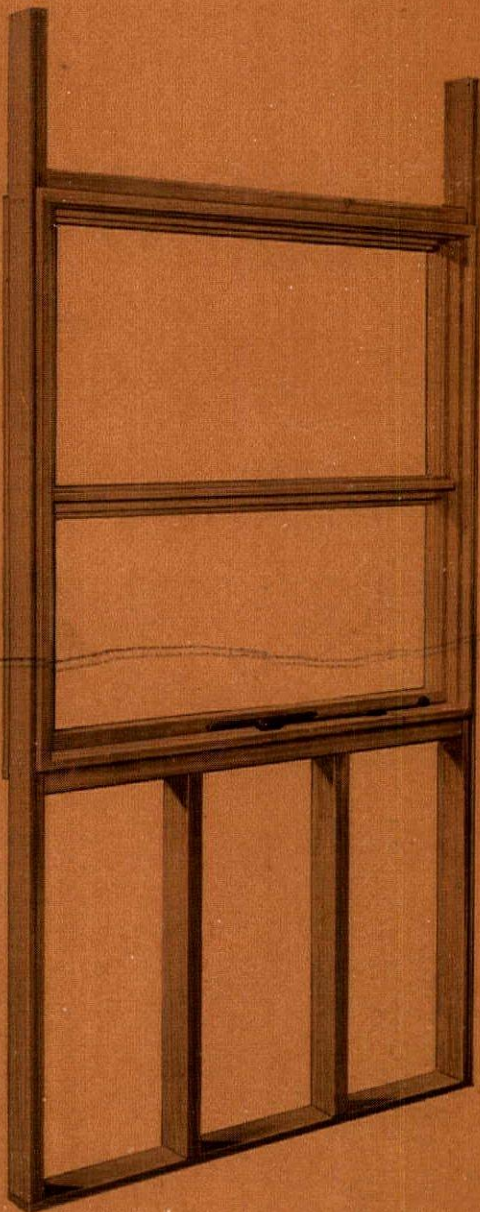

Conventional

1. FRAMING (approx. 12 steps)
2. INSTALLATION (approx. 5 steps)
3. FINISHING (approx. 5 steps)





Installs in minutes... fits tighter! Simply cut the two load-bearing struts to fit header construction you use. Nail Strutwall to adjacent studs, tilt up with wall. It's that quick and easy. In multiple openings, Strutwalls are simply butted against

each other. Nothing heavier than two 2 x 6 headers are needed in single story construction. Because all parts are nailed, or nailed and glued at the factory, the Andersen Strutwall has great resistance to racking. Gives you the tightest possible joining of window and wall.

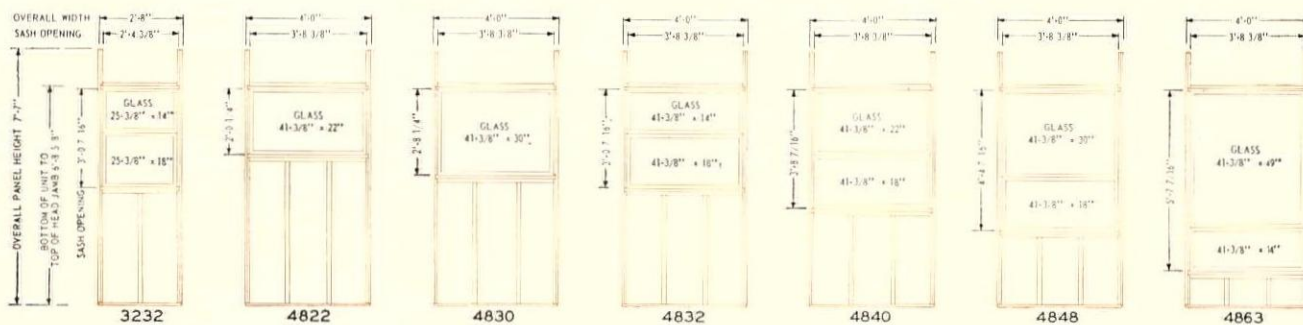

Available in 7 sizes, 2 styles! Andersen makes seven sizes of new Strutwalls, two sizes of Strutwall door frames. New

window components include both famous Beauty-Line* and Flexivent® styles. **Patent Pending*

Andersen Windowalls

TRADEMARK OF ANDERSEN CORPORATION

ANDERSEN CORPORATION • BAYPORT, MINNESOTA



Looks better... costs less installed! New Andersen Beauty-Line Strutwalls (below) and Flexivent Strutwalls add extra beauty and sales appeal to any home. On the exterior, absence of separate casing provides cleaner, trimmer lines. In

multiple openings, like this, note how there is more glass area. All of the builders who have tested new Strutwalls report a good saving in total installed costs—even when figured against inferior quality conventional windows.





STEP 1: Apply a bead of a new adhesive to the framing members...



STEP 2: Press the wallboard into place and nail it. Result:

A new drywall construction that promises less nail popping

United States Gypsum, which developed this new method of applying gypsum wall board and is distributing the new adhesive, claims these advantages for the "Adhesive-Nail-On" method:

1. "Less nail popping." There are two reasons. First, there are fewer nails to pop—under the new system, nails need be spaced only 16" o.c. on walls, 12" o.c. on ceilings. This is only about half as many nails as are needed without adhesive. Second, the adhesive takes some of the strain.

2. "Less finishing." Because there are fewer nails, less finishing time is required during the taping operation.

3. "Less loose board." Because of the holding and cushioning job done by the adhesive, nailing defects, minor framing irregularities and lumber shrinkage won't be a problem.

4. "Less 'booming.'" Impact noise is reduced because of the continuous bond between the wallboard and frame.

Application of the adhesive is said to be fast and easy. As shown in left photo above, a continuous bead of adhesive (a rubber-resin compound) is applied to the center of each framing member. The bead, about 1/4" high, is flattened to 1/16" thickness over the entire surface of the frame when the wallboard is pressed into place. On framing members where two pieces of wallboard will be butted, a serpentine or zigzag bead is laid.

The adhesive comes in 5-gal. cans; coverage is figured at 2 1/2 gals. per 1000 sq. ft. of wallboard in normal applications.

United States Gypsum Co., Chicago.

For details, check No. 1 on coupon, p. 222



ADHESIVE APPLICATOR is a caulking gun with a 3/8" wedge-shaped nozzle cut to a 45-deg. point. The gun has a 2 1/2-qt. capacity. An automatic gun has just been developed by Ames Bros. Tools, Belmont, Cal. Available on a lease basis, it has a guide which keeps the nozzle centered on the framing members, rolls on a wheel to speed application.

continued on p. 186

New! Andersen Strutwall:

TRADEMARK OF ANDERSEN CORPORATION

← Cuts installation steps two-thirds

← Provides tightest possible fit

← Saves materials

← Gives lower total installed cost

← Fits any type of frame construction

← Available to builders everywhere

Here's a great advance in building technique. A new component that makes a quality window an integral part of the wall.

Complete factory assembly of load-bearing side struts, nailers and lower jack studs gives the new Strutwall unusual resistance to racking. Provides the tightest possible joining of window and wall. Cuts installation from three operations to one—from around 22 steps to 7. Saves materials.

The new Andersen Strutwall fits any type of frame construction—including panel systems. It's been perfected and proved by field tests all over the country. It's sold throughout the United States and Canada. Get more information by contacting your lumber or millwork dealer. Or write: Andersen Corporation, Bayport, Minnesota.



TURN PAGE
FOR MORE
DETAILS!

New products

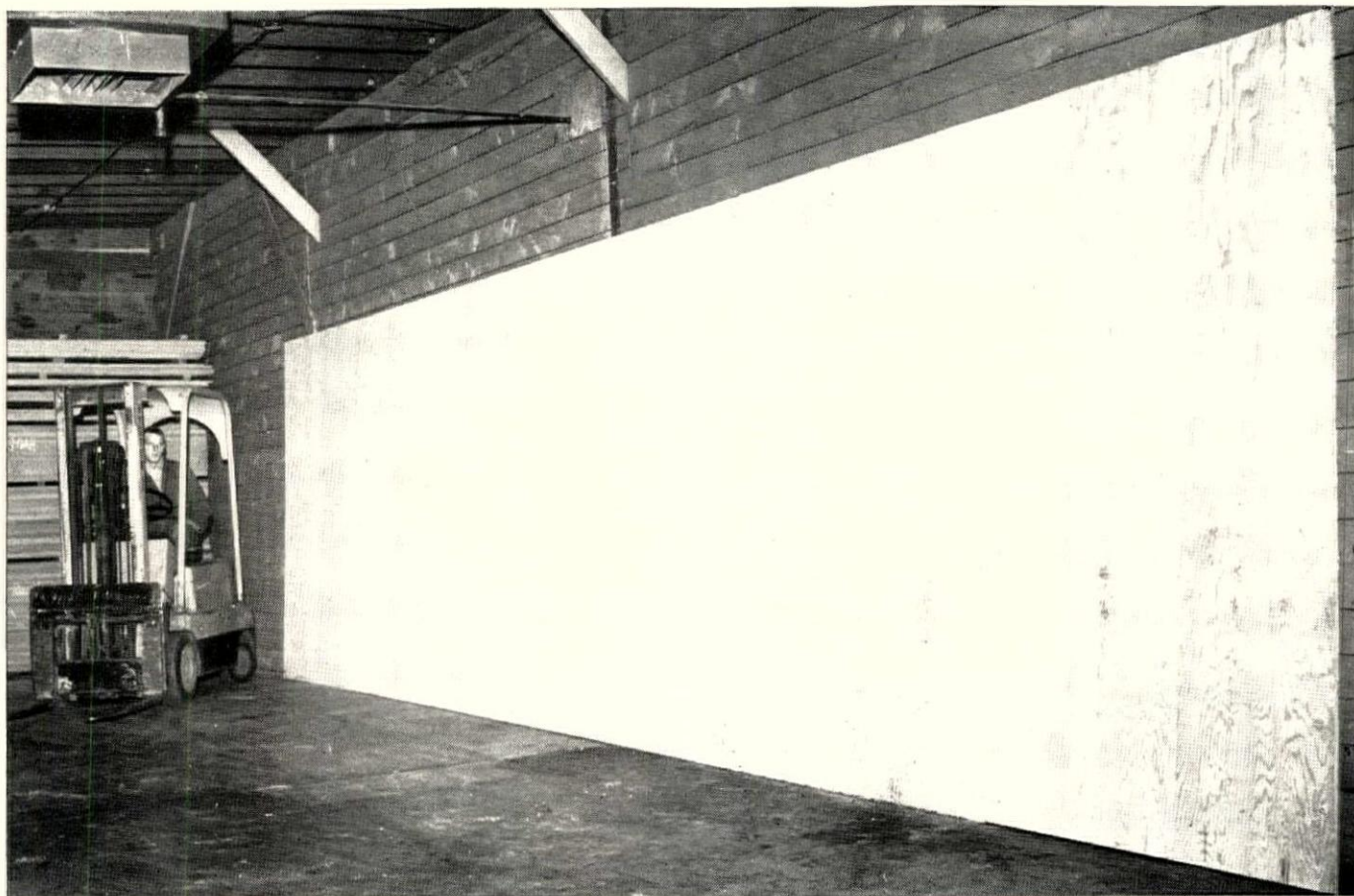

Now you can get plywood sheets as long as you want

Now you can span a roof or sheath a wall with a single sheet of plywood. The Diamond Lumber Co. has perfected a special scarf joint which makes possible almost any length you can use.

The Diamond panels are fir plywood, are made in the standard thicknesses up to one inch, and in a standard 8' width. They can be delivered primed and edge sealed or painted.

The new panels cost only a little more per sq. ft. than 4' x 8' panels of the same thickness and grade.

Diamond Lumber Co., Portland, Oregon.
For details, check No. 2 on coupon, p. 222



Here's a finished exterior hardboard

Forest Fiber's new product is $\frac{3}{8}$ " thick to reduce the warping, buckling and stress deflection to which an exterior building material is exposed. The new material can be used as exterior siding, for soffits and for other structural uses.

Available 4' wide in 2' to 16' lengths. Surface patterns include vertical groves on 4", 8" and random centers, plain or rustic textures. 16¢ to 25¢ per sq. ft.

Forest Fiber Products, Forest Grove, Ore.

For details, check No. 3 on coupon, p. 222

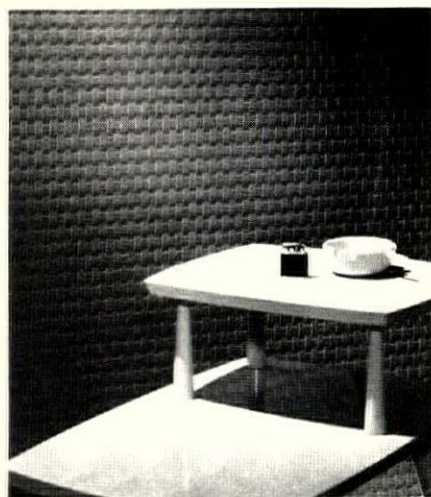

Basketweave is news in hardboard

Latest variant in one of the most useful panel products—tempered hardboard—is a board having an embossed design simulating the weave of Indian willow baskets. Like other hardboards it has no grain, is easily worked and easily formed, has great strength and will not crack or splinter.

Basketweave is available in $\frac{1}{8}$ " and $\frac{1}{4}$ " thicknesses and in 4' x 8' sheets. Retail price will be about 15¢ per sq. ft. for the $\frac{1}{8}$ "; 23¢ for the $\frac{1}{4}$ ".

Simpson Logging Co., Shelton, Wash.

For details, check No. 4 on coupon, p. 222

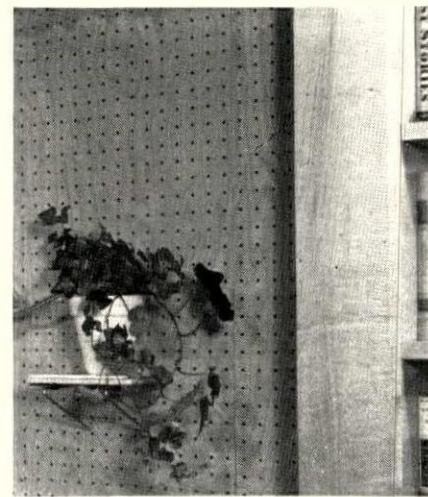

Pegboard can be decorative

The good looks of plastic faced hardboard have been combined with the practicality of pegboard in this new product adapting it for use in living areas.

The new board is available in nine pastel colors, seven wood grains and six marble patterns. It comes in a full range of standard widths and thicknesses. Holes are on 1" centers.

Price: slightly more than unperforated plastic-faced Marlite.

Marsh Wall Products, Dover, Ohio.

For details, check No. 5 on coupon, p. 222

continued on p. 189

*This complete line of
wood windows gives us a choice...
that's why we prefer*

Qualitybilt WOODWORK

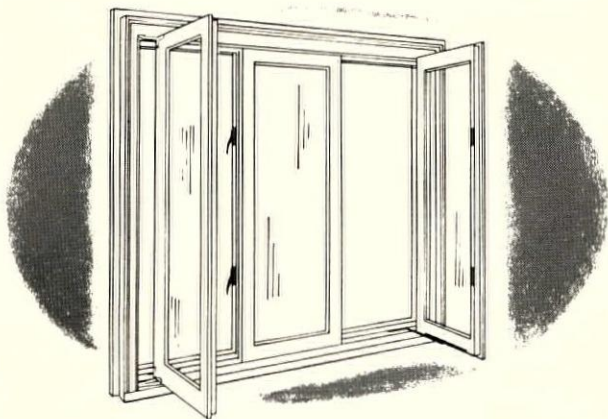

CASEMENT WINDOWS with slim mullions, exclusive, durable hardware, screens and year 'round insulation. Available with divided or single lights in all standard opening sizes . . . Picture Window combinations, using standard sizes of Thermopane, can also be supplied.

4-WAY WINDOWS are amazingly versatile. Use the Single Sash Series to form Awning, Hopper, or Casements as desired . . . the Two-Sash Series for Awning or Casement installations. Economical and practical. Hundreds of combinations possible with both Series . . . fit any requirement.

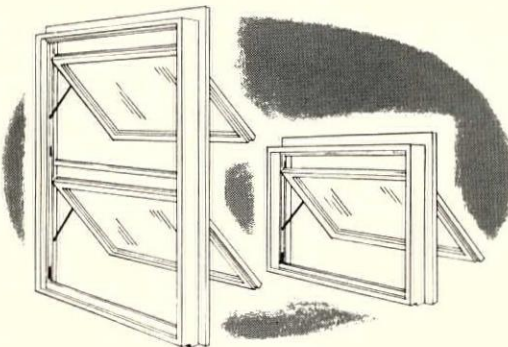

DOUBLE-HUNG WINDOWS are available in all standard modular sizes . . . and with various types of counter balancing . . . fully weatherstripped. The "Remov-a-seal" has sash balances and metal runways designed so sash can be removed or replaced instantly without tools for cleaning or painting both sides.



Send TODAY for free detailed catalogs and name of nearest distributor.

All QUALITYBILT Windows are made of W. Pine accurately manufactured and toxic treated for long life. Ask for QUALITYBILT Windows to insure getting the finest.

FARLEY & LOETSCHER MFG. CO.
DUBUQUE, IOWA

ENTRANCES • DOORS • FRAMES • SASH • BLINDS • CASEMENTS • SLIDING DOORS • SCREENS
COMBINATION DOORS • STORM SASH • GARAGE DOORS • MOULDINGS
INTERIOR TRIM • SASH UNITS • LOUVERS • KITCHEN CABINET UNITS
CABINET WORK • STAIRWORK • DISAPPEARING STAIRS • "FARLITE" LAMINATED PLASTICS

FARLEY & LOETSCHER MFG. CO., DUBUQUE, IOWA

Send complete information on:

Casement Windows 4-Way Windows
 Double-Hung Windows

... and name of nearest distributor

Name.....

Address.....

City.....State.....



Houses are easier to sell with
JOHNS-MANVILLE TILE FLOORS



Johns-Manville Terraflex in Cardinal Red and Plain White with Black, Yellow and Red feature strips.

Johns-Manville Vinyl Asbestos Tile... **the beautiful, carefree floor that house buyers want**

YOU'LL give those new homes of yours that custom-designed look, make them more salable, when you install J-M Terraflex vinyl asbestos tile.

Terraflex tile comes in a wide range of colors and styles. By varying floor designs you help give each of your houses individual personalities. Terraflex floor tile can be laid in countless designs to harmonize with various architectural home styles. Johns-Manville Terraflex adhesive permits easier and faster laying of Terraflex tile than ever before.

Full-page ads in *Life*, *This Week*, *Saturday Evening Post*, *Better Homes & Gardens* continuously tell your prospects how fabulous floors by Johns-Manville stay first-day new with so little care. Brand-conscious home buyers know Terraflex adds beauty, requires only a damp mopping to keep it spick and span.

Consider the buyer-appeal features of Terraflex for those new homes you are building or plan to build. For full details write to: Johns-Manville, Box 111, New York 16, New York.



JOHNS-MANVILLE

**THESE OTHER JOHNS-MANVILLE
BUILDING MATERIALS MAKE YOUR
HOMES EASIER TO SELL**



Pre-Primed Flex-board® comes to job site ready to take any paint. Large-size building sheets ideal for board and batten construction. Fireproof and rotproof.

Colorbestos® Sidewall saves expensive repainting for the homeowner, adds distinction and buyer appeal to the home. New Colorbestos Process assures lasting color and texture. Fireproof, rotproof and weatherproof.



Spintex® Insulation saves the home buyer up to 30 cents on every heating dollar. Keeps rooms up to 15 degrees cooler in summer—a "must" to make air conditioning practical.

Fibretex® Acoustical Panels absorb up to 75% of room noise that strikes them. Pre-decorated with handsome white finish, a modern sales asset for new homes.



Seal-O-Matic® Shingles, the only self-sealing shingle proved on over 300,000 homes. Resists wind, rain, hurricane. Saves costly roof repairs. Attractive colors and blends.



Two new talking points for kitchens

A new kind of oven vent hood (above) and a radio-intercom system (below) that you can flush-mount on the wall are two new products sure to appeal to women who spend a lot of time in the kitchen.

The new hood fits gas and electric built-in ovens of all sizes. The chrome hood extends only 3" from the built-in unit. The blower, which vents through a standard 4" duct, takes up only 4¾" of space above the oven, does not interfere with gas oven vents. Hoods come in sizes to fit 24", 27" and 32" cabinets. List prices: \$13.45 for the hood, \$36.50 for the power unit.

The radio-intercom has instructions permanently marked on the front of the master panel. An illuminated slide-rule dial tunes the FM-AM radio. Other controls let the user carry on two-way conversations—at the front door, for instance, or on the patio—or listen in on any station from any other station. A phonograph or tape recorder can also be plugged into the unit and beamed to other stations. Weather-proof stations are available for outdoor positions.

Standard model (AM radio only) lists at \$129.50; deluxe (AM and FM radio) at \$179.50. Both come with three inside remote stations, one outside remote. Extra remote stations are \$12.95 each.

Nutone, Inc., Cincinnati.

For details, check No. 6 on coupon, p. 222



**Ask your J-M representative about the
7-Star advertising and merchandising
plan to help you sell more homes**



Look to American-Standard

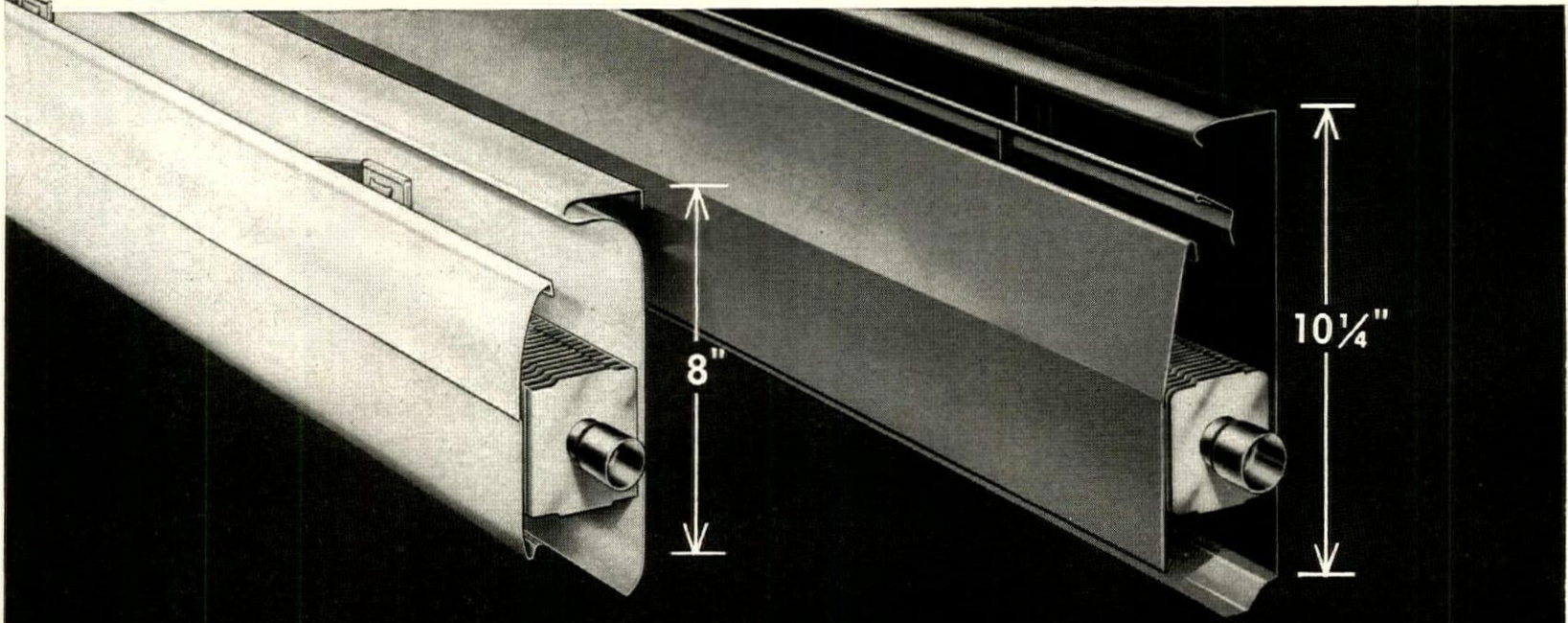

4 combinations of sizes and elements

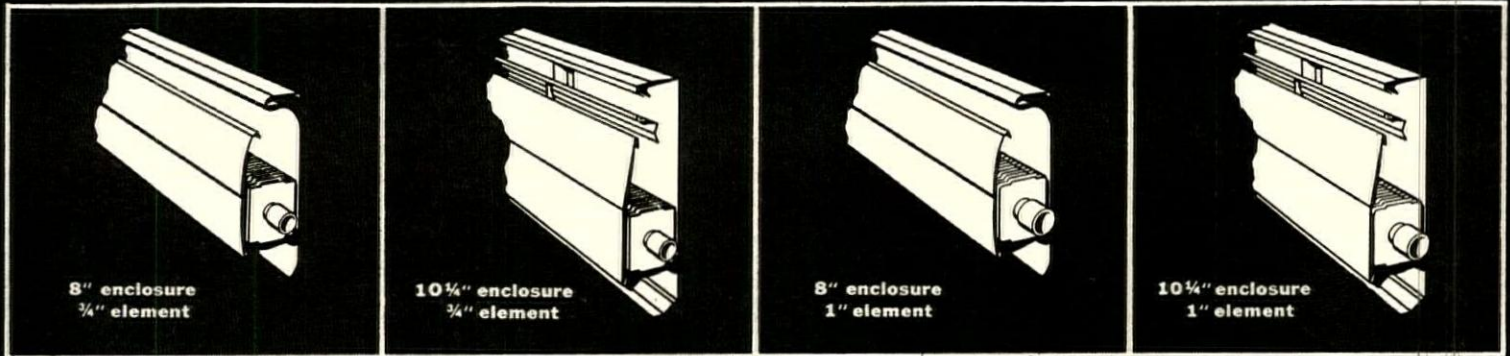

New low-cost baseboard heating at no sacrifice in quality or styling

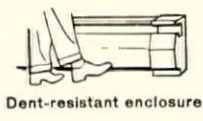

Dent-resistant enclosure

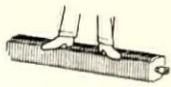

Rugged quality construction

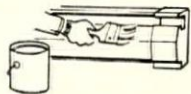

Quick and easy to paint

All-New *Heatrim Baseboard Panels* now bring you fine-quality, dependable American-Standard hot water heating at *new low cost*. Four combinations of enclosure and element give you economical, efficient heat for every type home. It's the perfect kind of heating for homes with large glass areas, and its small, flexible tubing makes it particularly well suited for "splits." New construction reduces installation costs *and* eliminates expansion noises. New 8" high model is finished with white satin prime coat—lets you save cost of painting. Both models easily recessed to depth of plaster.

AMERICAN-Standard & "Standard" are trademarks of American Radiator & Standard Sanitary Corporation

There's an American-Standard water heater for every size home



Arcoglas Deluxe

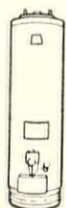

Arcoglas Standard

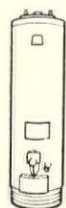

Arcosteel Deluxe



Arcosteel Standard

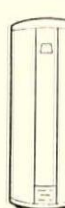

Arcoglas Deluxe

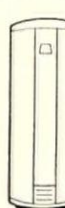

Arcosteel Standard

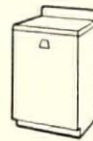

Tabletop Deluxe

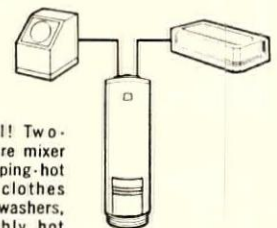

Optional! Two-temperature mixer delivers piping-hot water to clothes and dish washers, comfortably hot water to bathrooms.

4 gas models

3 electric models

for extra heating features to merchandise

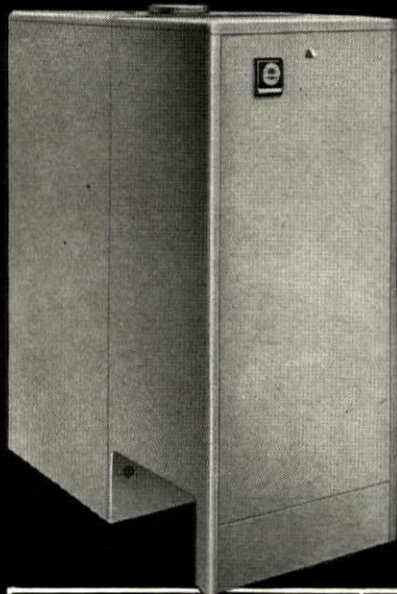

Arcoleader Packaged Oil Boiler

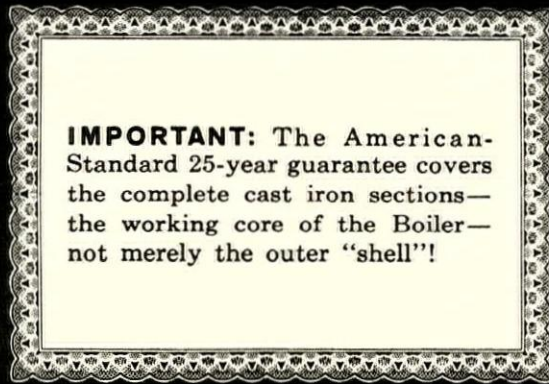

IMPORTANT: The American-Standard 25-year guarantee covers the complete cast iron sections—the working core of the Boiler—not merely the outer “shell”!



G-2 Packaged Gas Boiler

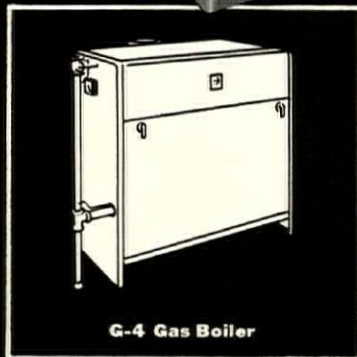

G-4 Gas Boiler

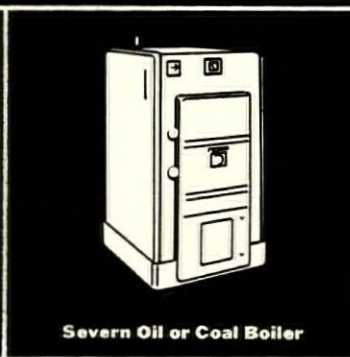

Severn Oil or Coal Boiler

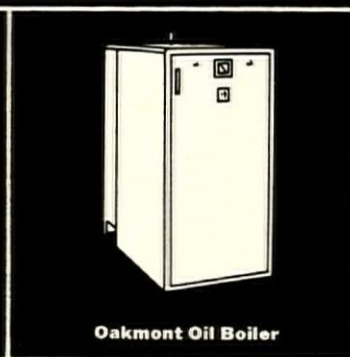

Oakmont Oil Boiler

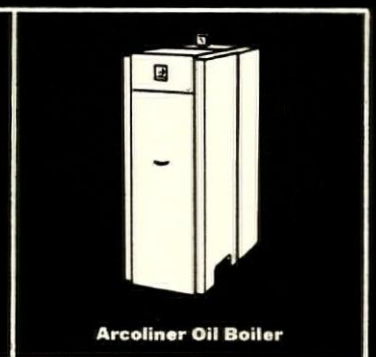

Arcoliner Oil Boiler

Now 25-year guarantee on boilers provides strong selling feature

A 25-year guarantee on cast iron sections of all these American-Standard hot water boilers is a quality feature buyers can and will appreciate. Point out this guarantee to buyers. It will help sway them to your homes, as they compare them with others. Small or large, oil or gas, there's an American-Standard guaranteed boiler at no increase in price. Packaged models reduce installation cost. Many may be equipped with built-in water heaters that save the space and cost of a separate heater. Be sure to take advantage of 25-year guaranteed boilers on your next starts.

For details, see your heating contractor or write AMERICAN-STANDARD, PLUMBING AND HEATING DIVISION, 40 W. 40 St., N.Y. 18, N.Y.

Another American-Standard development in hydronics—the science of heating and cooling with water.



AMERICAN-Standard

PLUMBING AND HEATING DIVISION

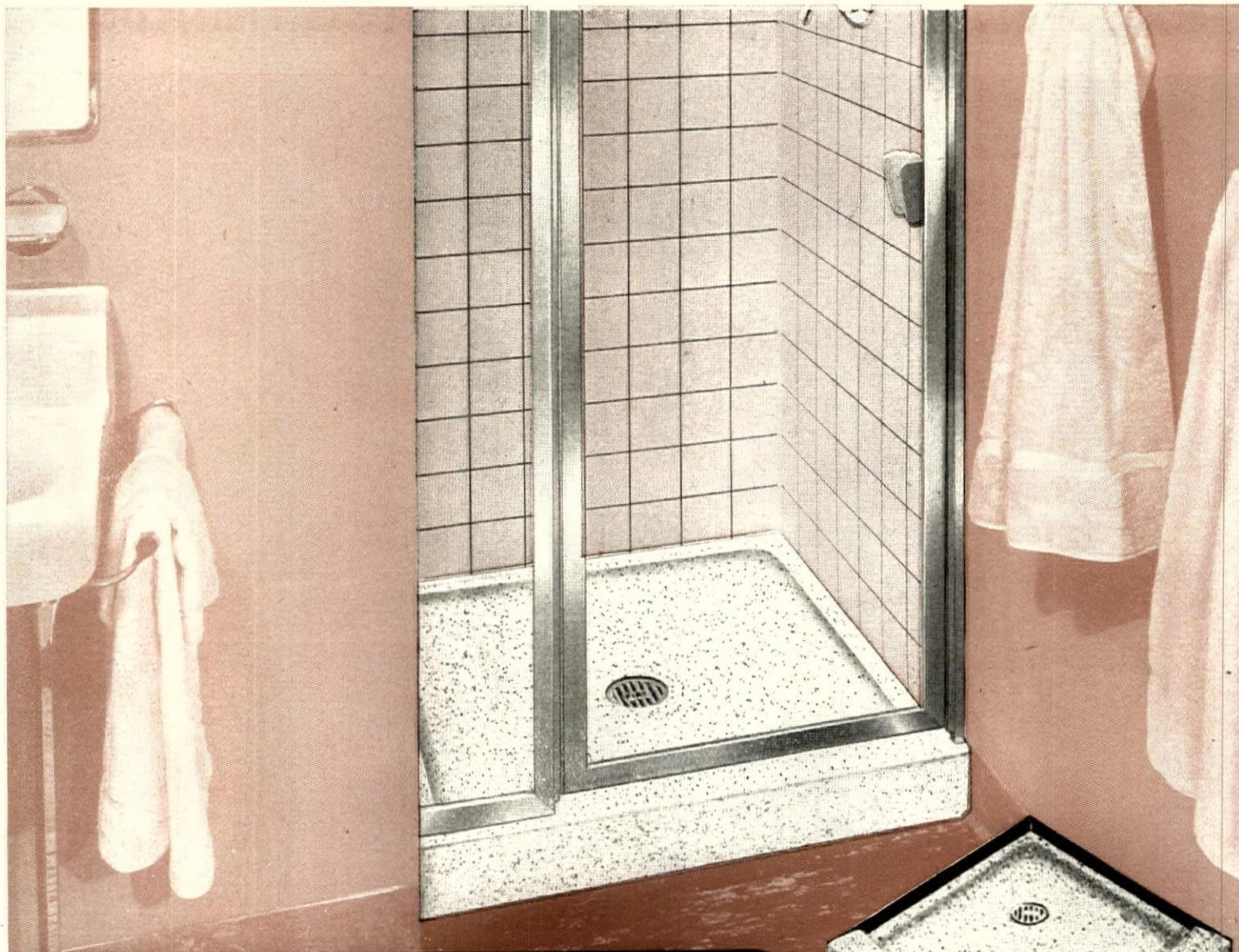

NEW FIAT PreCast SHOWER FLOOR
LOWERS COST OF SHOWER CONSTRUCTION

The new FIAT *Monterey* shower floor has a PreCast integral threshold and curb that completely eliminates the most expensive steps in shower construction: the built-on-the-job floor, threshold and pilasters. Glass filler panels at the jambs replace the pilasters, rest directly upon the curb of the *Monterey*. The FIAT PreCast Shower Floor simply slides into place—there's no need for sub-pan, mortar, tiling and hours of costly labor. Try this new shower technique that saves you money and produces added sales appeal.

The *Monterey* shower floor, PreCast of sparkling terrazzo, is permanently leakproof and furnished as a complete unit with solid brass drain and stainless steel strainer plate. There is nothing else to buy—nothing else to install! The photograph shows an excellent and economical shower combining the *Monterey* floor with a glass filler panel and door forming the front. Either hinged or sliding doors, by others, may be used as the solid threshold provides a convenient foundation for the track.



Monterey model available in six sizes—rectangular, square and corner designs.

It's so much easier to see the advantages of PreCast Floors than to read about them. That's why we would like just five minutes of your time to show you this cross section sample. Clip coupon to your letterhead and get full information. No obligation of course.



DEPT. T
 FIAT METAL MANUFACTURING CO.
 9323 Belmont Avenue, Franklin Park, Ill.

Please send complete information on your complete line of shower equipment.

Name _____
 Company _____
 Address _____
 City _____ State _____
 Type of Business _____



FIAT METAL MANUFACTURING CO.
 Since 1922... First in Showers / Packaged Showers • Doors • Floors
 / Toilet Room Partitions

FOUR COMPLETE PLANTS: Long Island City 1, N. Y.; Franklin Park, Ill.; Los Angeles 63, Calif.; Orillia, Ontario, Canada

New products



Nine vanities in Dawn Mist line

Aetna Porcelain offers its Dawn Mist vanity top separately or in eight combinations. The one-piece porcelain enamel, cast iron bowl and top has hidden overflows, twin soap holders.

Combinations of this basic top and a variety of bases, wings and connecting sections are available. Cabinetry is faced with GE's Textolite in walnut, norina, golden ballet, and white onyx. Side tops on the more expensive models are available in genuine black or white marble. Cabinetry for the two least expensive models is also available in birch. Price for the vanity top, \$55. Combinations range up to \$320.

Aetna Porcelain Enameling Co., Chicago.

For details, check No. 7 on coupon, p. 222



Vanities come with or without bowl

Raygold's new vanities come just about any way you want them: with the rim and bowl in place; with the top cut out for the sink, with or without the rim; or with no cut out. The sinks are colored porcelain enameled steel. The faucets, packed separately, are Gyro single-lever type.

The cabinets are faced with plastic laminates in a variety of wood grains, marble and spatter patterns. Hardware is brass. Size range: 24" to 72" in 6" increments. Drawers available in models 36" or over.

Raygold Industries, Copiague, L.I.

For details, check No. 8 on coupon, p. 222

continued on p. 196

UNIQUE is growing
... *NEW* products
for *YOU*

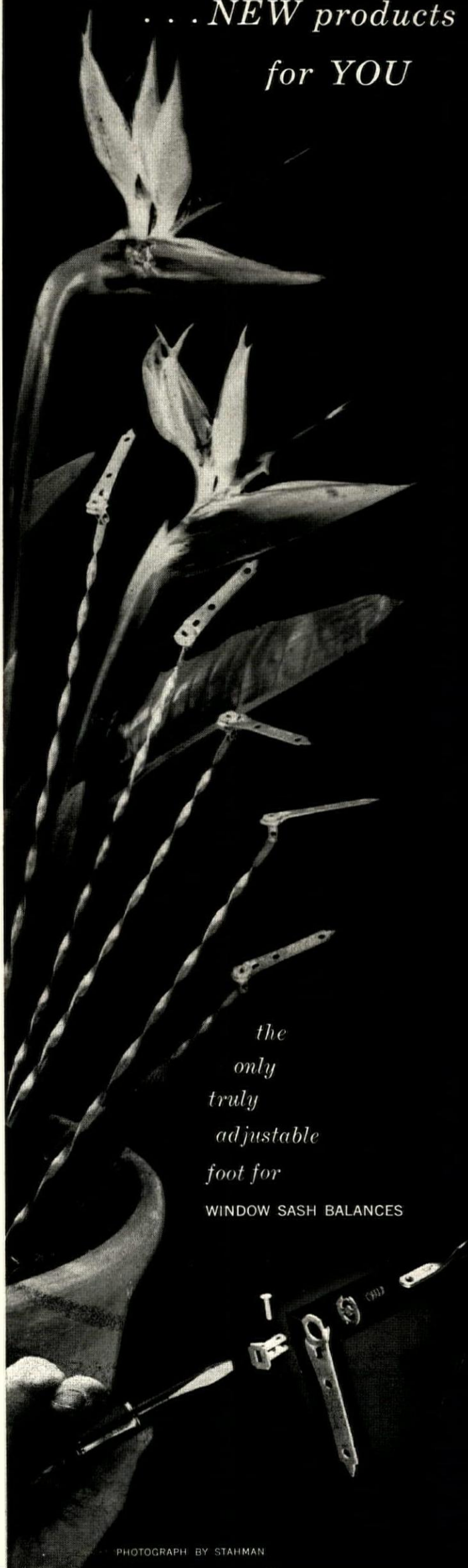

*the
only
truly
adjustable
foot for*

WINDOW SASH BALANCES

PHOTOGRAPH BY STAHPAN

UNIQUE BALANCE COMPANY
41 MAGEE AVENUE
STAMFORD, CONNECTICUT

NEW SERVI-CENTER* BY YOUNGSTOWN KITCHENS

REVOLUTIONIZES KITCHENS IN CUSTOM HOMES
... UTILITY APARTMENTS... DEVELOPMENT TRACTS

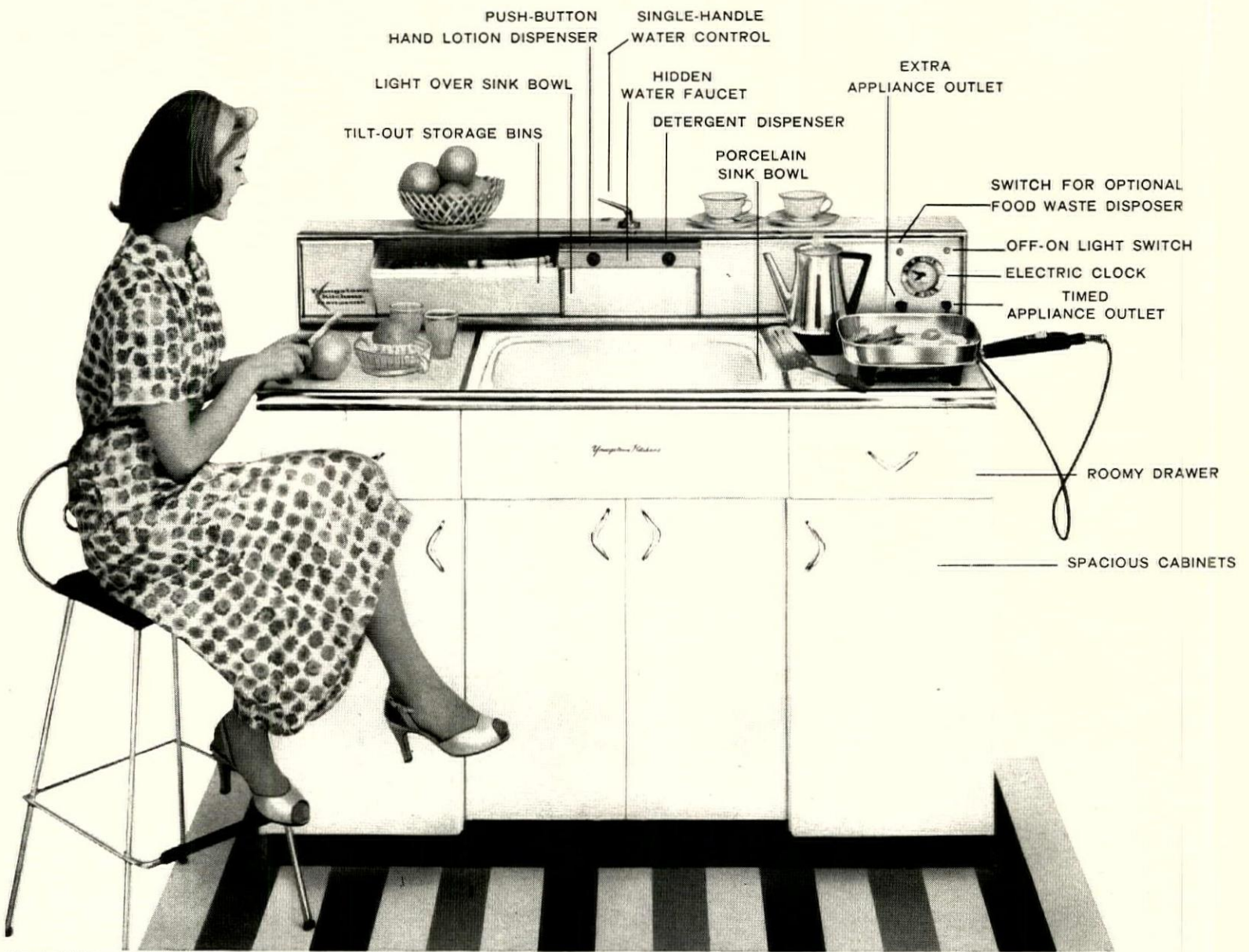

*Reg. Applied For

NEW HOME APPLIANCE combines illuminated sink bowl, handsome cabinets, Formica work counters, electric clock and outlets plus exciting new dashboard features in one complete kitchen unit! 54" and 42" sizes in White or Sandalwood colors.

Easy to install, the Servi-Center saves space...provides complete kitchen for small homes and apartments...adds custom-feature

luxury to larger homes. Exciting new kitchen features attract homemakers...help your kitchens sell your home.

Backed by a tremendous, full-color national advertising campaign, the new Servi-Center is a traffic builder...an attention-getter...marks your model home as the newest, most modern in town. Call or write your Youngstown Kitchens Distributor today.

Quick delivery from over 80 distribution points



AMERICAN-Standard
YOUNGSTOWN KITCHENS DIVISION

Dept. HH48, Builder Information, American Standard, Youngstown Kitchens Div., Salem, Ohio.

Please rush me complete information on your new Servi-Center appliance.

Name _____

Firm Name _____

Address _____

City _____ Zone _____ State _____



THE "LUCKY KEY CONTEST!"

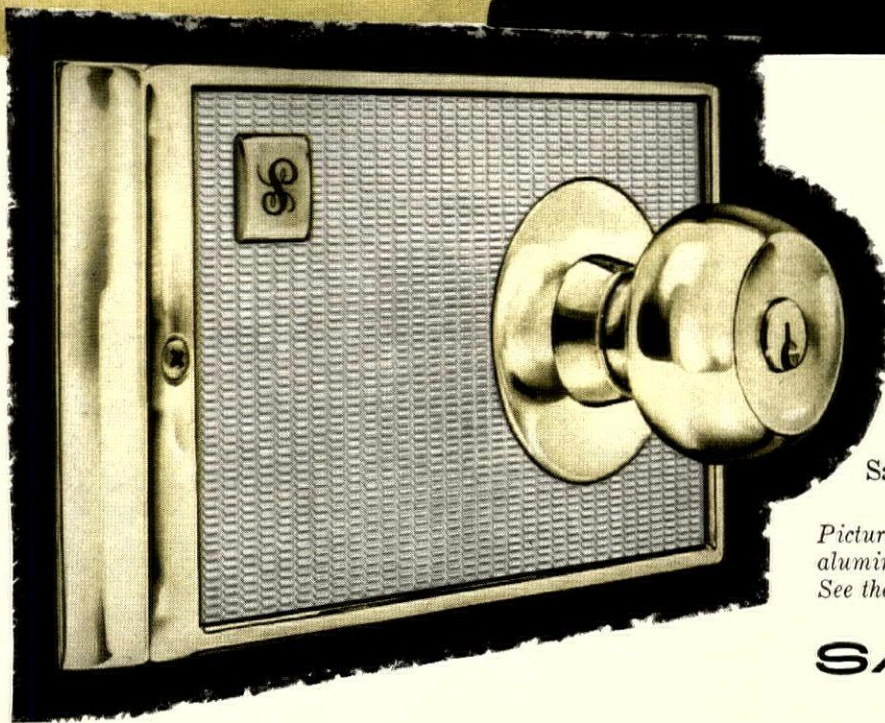

... an exclusive new Sargent Promotion

Here's the sales assist you've been looking for. An exciting traffic stimulating program geared to today's progressive home selling.

And it's free . . . from Sargent. A bin full of Westinghouse prize radios. A \$500 grand cash award. Newspaper mats, displays and a complete kit of merchandising materials are ready to back up the sales effort.

Get all the facts about the LUCKY KEY CONTEST from your distributor today. Or write Sargent & Company, New Haven 9, Connecticut. Dept. S-1574.

Pictured is a handsome new Sargent design . . . patterned aluminum panels set into an escutcheon of polished brass. See the full line of "styled for tomorrow" Sargent hardware.

SARGENT LOCKS
"... Sign of a well built house"

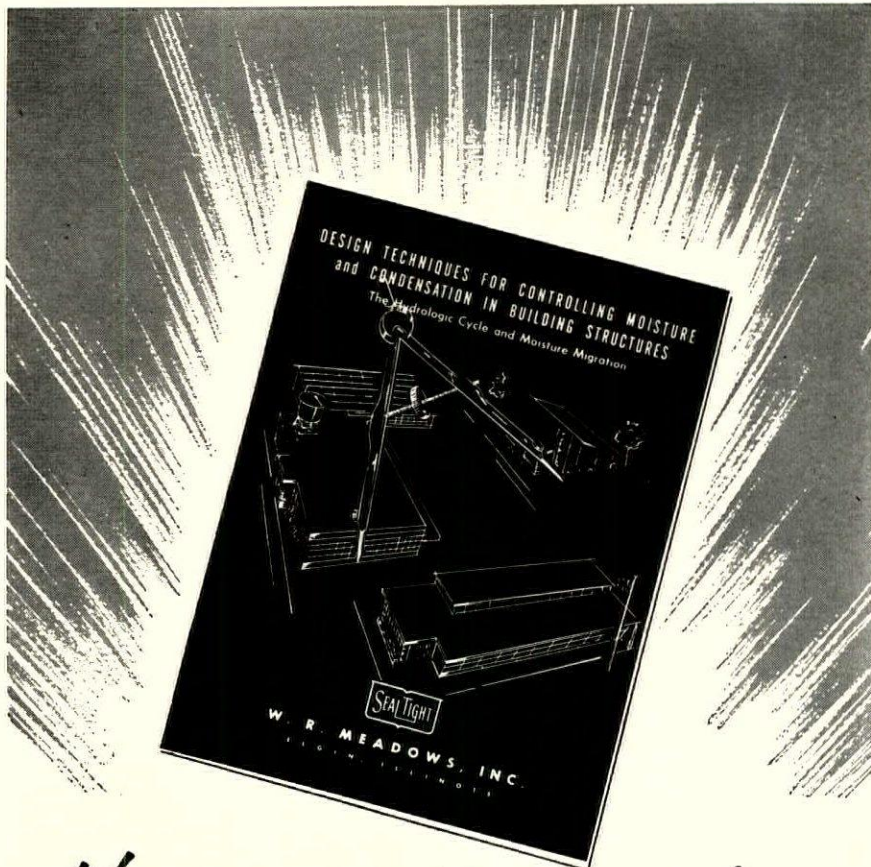

Now available free of charge

"DESIGN TECHNIQUES FOR CONTROLLING MOISTURE & CONDENSATION IN BUILDING STRUCTURES"

Modern developments in building construction, with trends toward a more monolithic structure, the increased use of insulating materials, and the use of glass and other impermeable materials in the shell area, have introduced new problems in the form of condensation and the uncontrolled migration of free water. Some of the more common types of damage resulting from condensation, are the blistering and peeling of paint, loosening of plaster, efflorescence of masonry, interior dirt patterns, mechanical destruction of structural elements, warping and rotting of floors and the incursion of termites.

Many past studies have treated vapor

problems symptomatically, attempting to deal with a manifest difficulty. Here is a technical manual, the first of its kind, explaining in the architect's and engineer's own language, moisture movement, condensation problems and modern control methods for moisture and vapor movements. The manual gives factual proof of the effectiveness of impermeable materials in restraining moisture migration.

This book, now available free of charge through the courtesy of W. R. Meadows, Inc., has been specifically prepared to assist architects and engineers in protecting structures from migration of water in its various forms. Write today for your copy.

W. R. MEADOWS, Inc.

W. R. MEADOWS, INC., KIMBALL ST., ELGIN, ILLINOIS DEPT. 10
Gentlemen,

Please send, without obligation on my part, a copy of the "DESIGN TECHNIQUES" Manual.

NAME _____ FIRM _____

ADDRESS _____

CITY _____ STATE _____

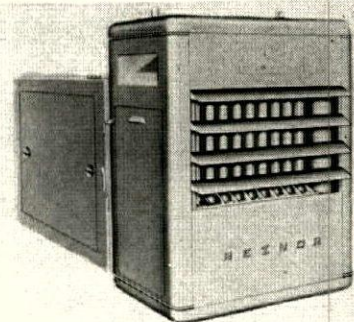

Compact gas-fired space heater

Reznor's new enclosed blower unit is specially intended for use where low noise levels are called for. Blower and controls are completely enclosed but are easily reached through a snap-out panel. Unit is shipped completely assembled. Eleven sizes: 25,000 to 300,000 Btu.

Reznor Mfg. Co., Mercer, Pa.

For details, check No. 9 on coupon, p. 222

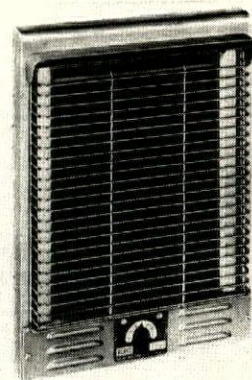

Glass heater fits between studs

Berko's new Model HBT radiant glass heater mounts flush in the wall with only two screws, for supplementary heat in bathrooms or other small rooms.

Unit is 12 5/16" wide, 17 1/4" high, and only 3" deep. 750 watts; 120, 208 or 240-volts; thermostatically controlled.

Berko Electric, Queens Village, N.Y.

For details, check No. 10 on coupon, p. 222



Fan-type heater for small rooms

Thermador's new medium wattage heater puts out enough heat to handle large bathrooms, workshops, etc.

Available for 120 and 240 volts; 1,650 watts; manual or thermostat control. Fits a roughed-in opening 10 1/8" wide, 14 3/8" high, 3 3/8" deep. About \$37.

Thermador Electrical Mfg., Los Angeles.

For details, check No. 11 on coupon, p. 222

continued on p. 200

LOW COST ZONING

with Forced Hot Water Heating

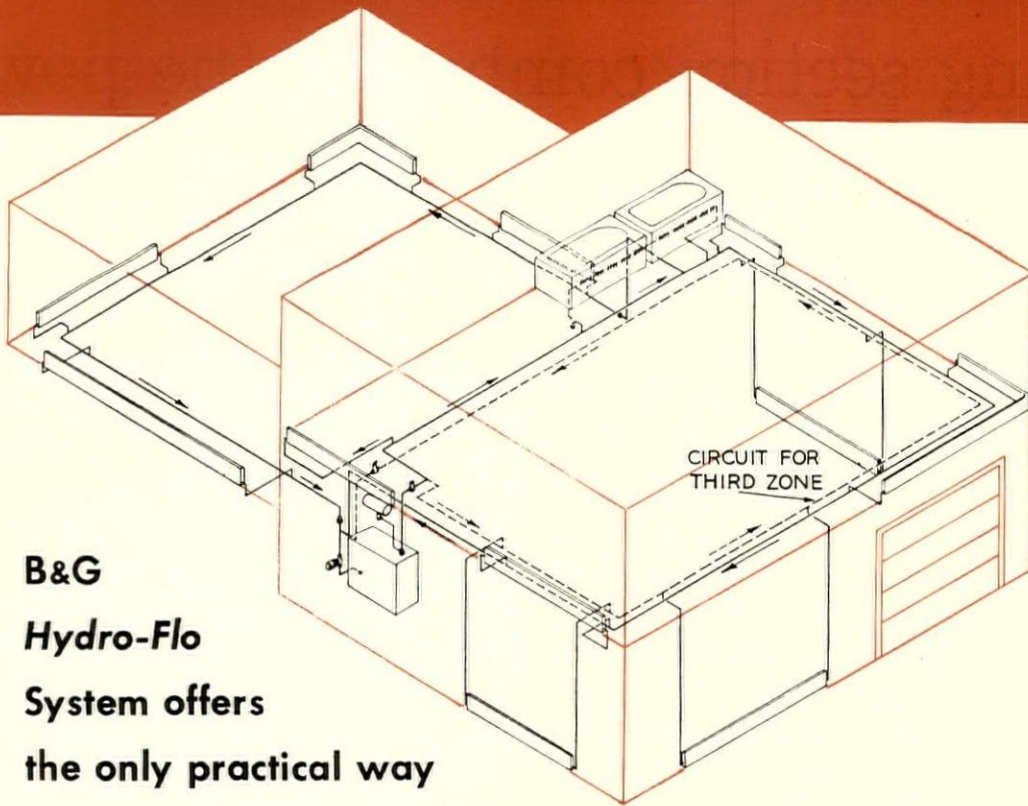

**B&G
Hydro-Flo
System offers
the only practical way
to zone-control the
heating of both conventional and split-level houses**



B&G BOOSTER
...key unit of the B&G
Hydro-Flo System

Engineered for compactness, silent operation and years of service, this electric pump circulates boiler water for heating the house. It is built with precision manufacturing methods which translate good design into superior product... permit mass production with custom-built quality.

The B&G Booster has a solid reputation for quiet, dependable and long-lived operation. That's why over two million units have been sold to date.

The growing popularity of split-level homes and their need for zoned heating gives added value to the easy zoning characteristics of the B&G Hydro-Flo Forced Hot Water System. Only a minimum of simple, dependable equipment is required.

The tri-level house illustrated above is heated with a baseboard system which can be optionally installed in one, two or three zones. For one or two zones, the basic piping plan is not changed—the three zone system requires a short additional piping circuit.

A two-zone effect can be achieved, if desired, with only one pump. The balancing valves installed in the return lines from the two piping circuits can be adjusted to maintain either a uniform temperature throughout the house or to provide different temperatures in the living-dining-kitchen area and in the bedroom-recreation-garage area.

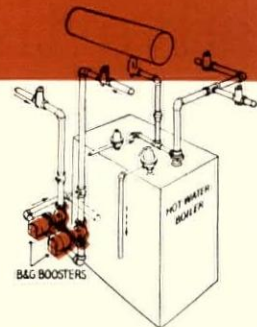

Two zone system

By introducing a second pump, completely automatic temperature control in two zones is effected. Each zone pump is controlled by a thermostat which permits the occupants to vary the temperature in the respective zones as desired. The piping differs from a one zone system only in the return connections to the boiler.

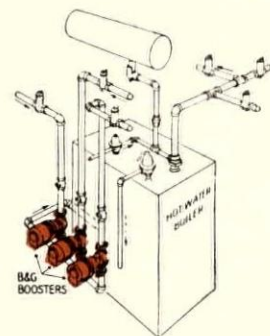

Three zone installation

With three B&G Booster Pumps installed, each level of this tri-level home is under individual thermostatic control, permitting three different temperatures in the same house. The economy in fuel and the added comfort is obvious when it is considered that each section of the house can be warmed to a degree consistent with its functions.



*Reg. U.S. Pat. Off.

Hydro-Flo[®] SYSTEM

BELL & GOSSETT

C O M P A N Y

Dept. FF-10, Morton Grove, Illinois

Canadian Licensee: S. A. Armstrong, Ltd., 1400 O'Connor Drive, Toronto 16, Ontario

THE GREATEST SALES-POWER EVER

A spectacular and exclusive multi-page advertising section combining the power of House Beautiful Magazine...

Sells both sides of the counter

An unprecedented event in central air conditioning history! "Summer is Hell" titles the biggest multi-page unit ever run in support of air conditioned homes. It is the theme of Westinghouse's "Comfort Command" promotion — 6 pages, 4 in full color — in the May issue of House Beautiful... by-lined by Bob Considine, world noted reporter-columnist.

House Beautiful is proud to have been selected *exclusively* to carry this consumer campaign. Like so many advertisers in House Beautiful, Westinghouse researched the market. They chose House Beautiful because it reaches a huge segment of the prime market for central residential air conditioning.

House Beautiful's 3½ million readers are predisposed and preconditioned to central air conditioning. Predisposed — because they have the means and the imagination to want more comfortable, more beautiful homes. Preconditioned — because House Beautiful has been selling them the value of central air conditioning for years.

Time and again builders, dealers, and retailers tell us their best prospects for products-in-the-home are House Beautiful readers. The reasons: these readers are home owners and home buyers. They have the money (median income \$10,000) to buy what they want and what they believe in. And they believe — and are presold — in the pages of House Beautiful!

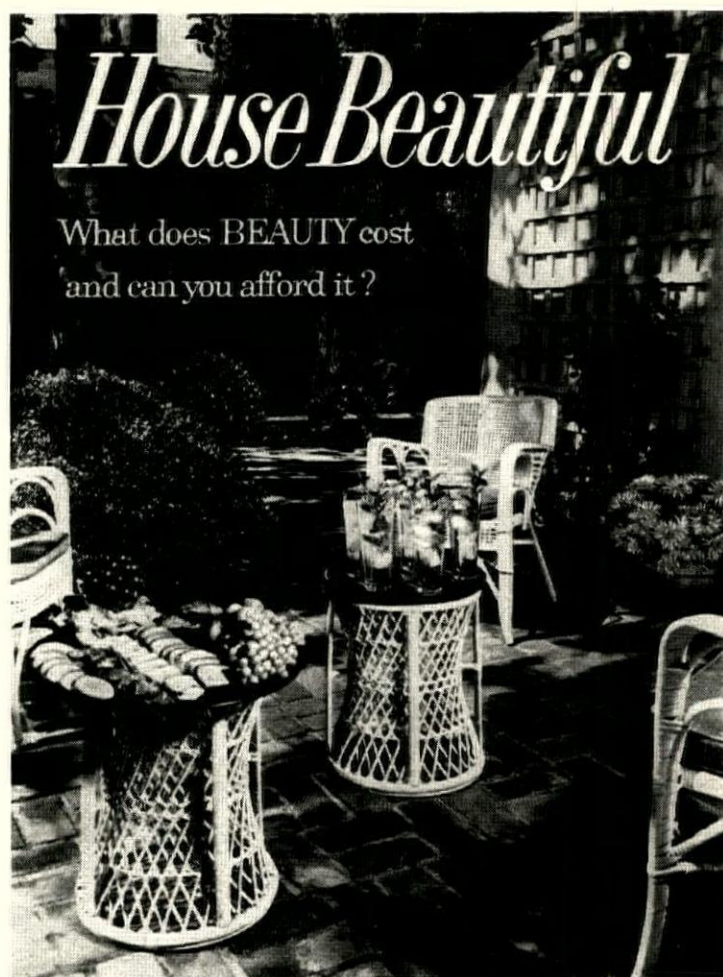

House Beautiful

572 Madison Avenue, New York 22, N. Y.

A HEARST KEY MAGAZINE

The one magazine that sells both sides of the counter—

*more than 21,000 trade subscribers
in the building industry.*

GIVEN TO AIR CONDITIONED HOMES



...and Westinghouse "Comfort Command"*

a new kind of air conditioning

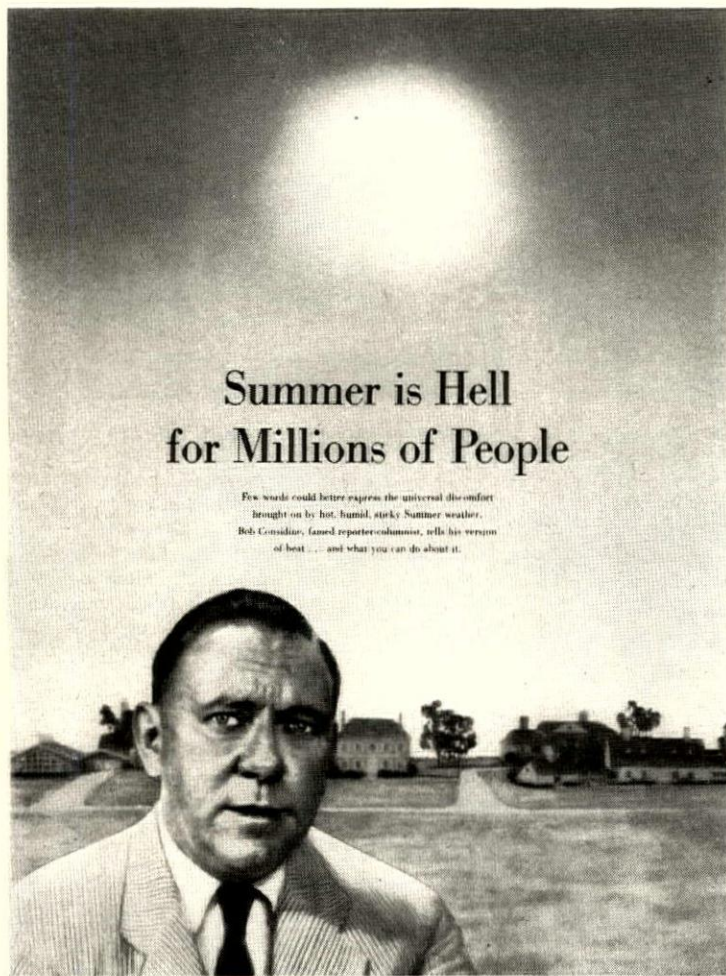

Westinghouse is helping builders create new markets for air conditioned homes, with a bold new approach to home comfort. "Comfort Command"... a new kind of air conditioning that is custom engineered for each house. And it's supported with a sales action plan aimed at prime buyers for air conditioned houses. Now, air conditioning is an important extra that will make people buy a new... better home. You can update any home built with the addition of Westinghouse "Comfort Command" air conditioning.

F.H.A.'s new philosophy toward air conditioned houses actually creates a replacement market among buyers who had to settle for less than what they wanted or needed when they bought their present home. Air conditioning is one of the more important features that FHA now recognizes as virtually a necessity in better homes... now within the means of the average home owner.

Look what F.H.A. says... "Within a few years, any house that is not air conditioned will probably be obsolescent, so FHA should start encouraging the inclusion of air conditioning." That's the cue to the potential market of 500,000 new air conditioned homes each year.

Westinghouse is ready to help you get your share. Your local Westinghouse "Comfort Command" Specialist is qualified to assist you in planning and selling air conditioned homes. Already, he is preselling people in your market to want and ask for this new kind of air conditioning. Call him. See page 6 of Westinghouse's dramatic four color ad in May issue of House Beautiful for his name.

* Trade Mark

Westinghouse

Westinghouse Electric Corporation, Air Conditioning Division, Box 510, Staunton, Virginia

*If you are not one of House Beautiful's trade subscribers, write to House Beautiful,
572 Madison Avenue, New York, 22, N. Y. on your letterhead about special trade subscription rate.*

**MEETING
YOUR RIGID
SPECIFICATIONS**

LEVITON

SPECIFICATION (5000) GRADE

In specifying a Leviton 5000 number, you are assured of getting completely dependable, top-quality Specification Grade devices.



#5521

QUIET SWITCHES

A full line of 15A and Heavy Duty 20A AC Quiet Switches.



#5219

5200 COMBINATION LINE

Complete line of duplex devices in S.P., 3 W, single or separate circuits to fit standard duplex wall plates.

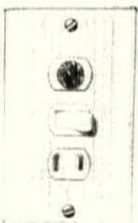

INTERCHANGEABLE LINE

A complete series of flush mounted wiring devices and straight line design wall plates to allow a large number of combinations . . . in one-gang or multi-gang arrangements.

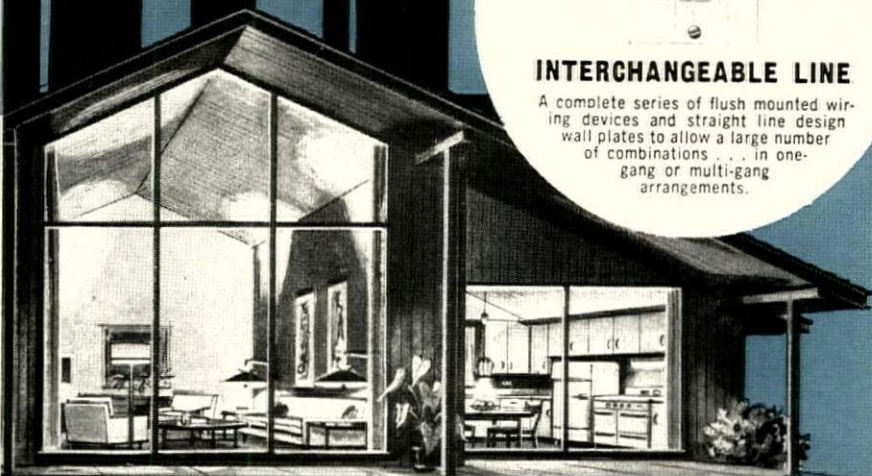

Your best jobs are done with . . .

LEVITON MANUFACTURING COMPANY, INC.
Brooklyn 22, New York

Chicago • Los Angeles • Leviton (Canada) Limited, Montreal

For your wire needs, contact our subsidiary **AMERICAN INSULATED WIRE CORP.**

LEVITON

Listed by Underwriters' Laboratories

New products

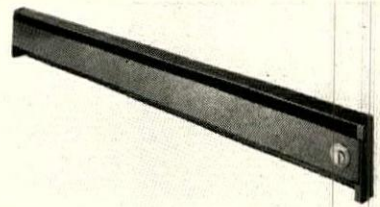

New electric radiant baseboard

The Markel Thrift-Trim baseboard units can be used singly as supplementary heaters or combined into a complete system. Each unit contains two sheathed range-type elements. Units are 2', 4', 5', 6' and 8' long, 500 to 3000 watts. They can be combined with blank panels.

Markel Electric Products, Buffalo.

For details, check No. 12 on coupon, p. 222



Oven line has "drop-leaf" doors

In Frigidaire's new line of built-ins, oven doors don't just swing down to act as a loading shelf (as shown)—a touch on a lever swings them down all the way, flush against the wall, for easy cleaning. Double-oven model (shown) has new broiler design. There are also two single ovens. All fit 24" cabinet.

Frigidaire Div., Dayton.

For details, check No. 13 on coupon, p. 222



New GE ovens slide into place

In a trial installation, a burner top and oven from GE's new line were put in place in 32 minutes from carton to completion. The three ovens in the line are all built to fit into a 27" cabinet or wall opening, are 21" x 18" x 15" inside. All are completely automatic, available in colors.

General Electric, Louisville.

For details, check No. 14 on coupon, p. 222

continued on p. 203

HOUSE & HOME

*This New Bermuda Roof
of Follansbee TERNE
is my Biggest Attraction!*



**The NEW
BERMUDA ROOF
of Follansbee Terne**

Shown above is the new, distinctive BERMUDA ROOF of Follansbee Terne. If you would like more particulars about the installation and cost of the Bermuda Roof, we will be happy to send you complete information. Other data also appears in the Architectural and Light Construction Files of Sweet's Catalog.

"You have probably noticed too that prospective home buyers aren't particularly conscious of the roof—even though the roof is one of the most important features of any house.

"Now, since I've been putting Follansbee Terne roofs on all my houses, I have something that I can merchandise. Buyers are impressed when they hear that a Follansbee Terne roof will last as long as the house stands—that Terne is fireproof, weathertight, windproof and can be painted any color, any time, to harmonize with the house exterior.

"My homes include air-conditioning and I sell the fact that a light-colored Follansbee Terne roof will reflect more of the sun's heat than any other type of roof. That means a substantial savings in air-conditioning costs for the home buyer.

"I've found that the beauty and serviceability of a Follansbee Terne roof is that added attraction that helps me sell my homes quickly."

Roofing and Sheet Metal Contractors everywhere will install Follansbee Terne Roofs.



FOLLANSBEE
STEEL CORPORATION



FOLLANSBEE, WEST VIRGINIA

Terne Roofing • Cold Rolled Strip • Polished Blue Sheets and Coils

Sales Offices in Principal Cities



meet
CYRIL
STERILE
builder

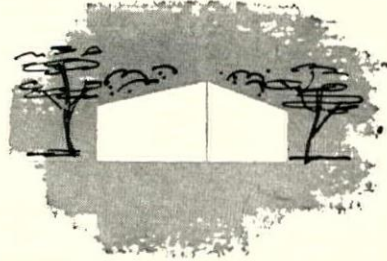

Prospective buyers are, to Cyril, an "utter bore." As a matter of fact, building homes for the common clay is really degrading. Cyril's tastes are impeccable to Cyril. The fact that prospects find his homes drab, barren and depressing only underlines Cyril's conviction that bourgeois mentality is infantile. Building trends of any kind are abhorrent . . . they only accentuate the "herd" influence. "Brand" merchandise is avoided with Spartan dedication . . . it is a further insidious inroad on "individualism." "Utility" coddles laziness. "Comfort" is a sop to self-indulgence. In a word, Cyril is a "nut." He is also broke. Cyril would no more consider using cost-cutting, easy to install, consumer approved

Columbia **ALUMINUM**
WINDOW SCREENS

than he would buy a double-breasted suit with two buttons and shoulder pads. Fortunately, there are very few Cyril Steriles.

Most builders recognize Columbia Screens for what they are . . .

. . . a complete line of both aluminum tension and tubular aluminum frame screens for all types of windows.

. . . manufactured to rigid specifications as established by our engineering division. That means delivery in the exact sizes ordered, plus the unqualified backing of the manufacturer.

. . . backed by a service organization second to none. Special sizes, special orders, special services . . . your Columbia Dealer can always deliver. And he has the entire Columbia organization right behind him.

. . . consumer accepted and respected. Columbia Screens are "brand name" screens. Your customers know all about them . . . respect the name, respect the value.

. . . cost cutting . . . time reducing . . . complaint abolishing . . . Columbia Screens install quicker, are always delivered to exact specifications, stand up over the years.



For full details, see your local Columbia Window Screen Dealer, or write to Dept. 14

THE COLUMBIA MILLS, INC.
120 W. Onondaga Street, Syracuse 1, New York

New products

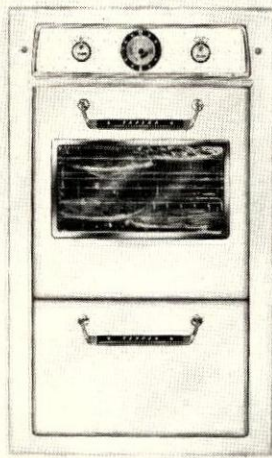

Tappan's new built-in hides vent

Unlike electric ovens, gas ovens need air to feed the flame. Vents for these new ovens are concealed in the control panel above the oven door.

Ovens are chrome-lined, have removable doors for easy clean up. They are 17" wide x 15" high x 20" deep to fit openings 22" x 18" x 24".

Tappan Stove Co., Mansfield, Ohio.

For details, check No. 15 on coupon, p. 222

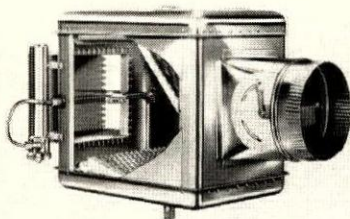

New design in warm-air humidifiers

The Lennox Humidispray can be built into any type of warm air system. In operation, some of the warm air from the furnace is passed through a fine water spray, is then mixed with the rest of the warm dry air. Spray volume is constant, humidity is varied by varying air volume.

Lennox Industries, Marshalltown, Iowa.

For details, check No. 16 on coupon, p. 222

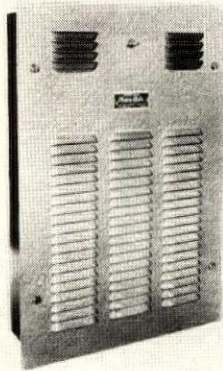

Here's a built-in air cleaner

Activated charcoal, an air filter and exhaust fan combine in this wall-mounted unit to form a simple effective air cleaner and deodorizer for game room, kitchen or bath. The charcoal freshens and deodorizes the air, the filter cleans it, the fan recirculates it. Installation is simple.

Barneby-Cheney Co., Columbus.

For details, check No. 17 on coupon, p. 222

continued on p. 207

HOW to beat rising costs with CASE[®] equipment



Crawler-mounted loaders

Five sizes — $\frac{3}{8}$ to 2-cu. yd. capacity — with advanced features for digging basements, driveways, loading trucks, finish grading.



Wheel-type loaders

Two new low-priced models — 11 and 13-cu. ft. capacity — for light loading, backfill, clean-up. Years ahead in design and performance.



Crawler-mounted backhoes

Gives you extra flotation and stability for digging septic tanks, sewer and water lines, swimming pools, etc., in soft or rough terrain.

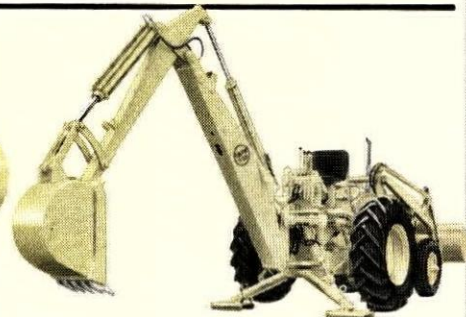

Wheel-type backhoe-loader

Most versatile machine in the low-priced field — for trenching, backfilling, loading, etc. Engineered for heavy-duty industrial service.

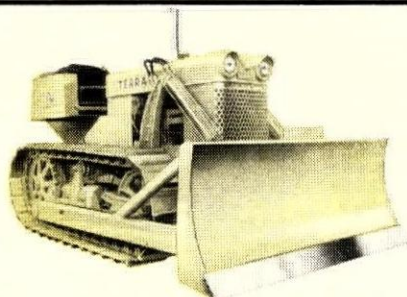

Bulldozers

42 to 100 HP with exclusive power-tilting blade for clearing and leveling land, crowning roads, building terraces, etc.

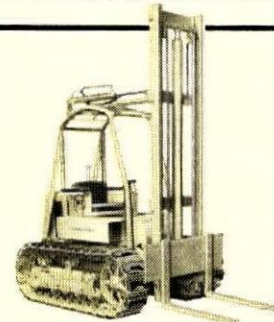

Crawler fork lift

Speeds delivery of block, brick, roofing, etc., through mud and rough terrain. Lifts to 21' height. Mounts quick-change attachments.

Whether you handle *your own* land development and excavation — or *sub-contract* such jobs — you'll find your unit-cost per-home can usually be *reduced*, by having the work done with modern Case[®] TerraTrac[®] industrial tractors and equipment. Why Case? Because Case has the *right size and type* of machines — both crawler and wheel-mounted — *plus the engineering advancements* — to do your jobs quicker, easier, at lower net cost. Case also builds and sells all tractor and attachments under *one warranty*, so you can

depend on fast, efficient service — anywhere, anytime — through your local Case Industrial Dealer. In addition, Case has its *own credit plan*, which enables you to purchase or LEASE new Case TerraTrac equipment right now — on the easiest monthly terms in the industry — *without tying up needed capital*. Mail handy coupon TODAY.

CT-CL-120

CLIP... MAIL FOR FREE CATALOG

J. I. CASE CO., Dept. B1468, Racine, Wis., U.S.A.

Send literature and prices on equipment checked:

- Crawler loaders Crawler backhoes Fork lifts
 Wheel loaders Wheel-type backhoes Bulldozers
 Send name of nearest Case Industrial Dealer

Name Position.....

Company

Address

City State.....



1st in quality for over 100 years



Barrett *RANCHLINE* † Shingles
create a stunning first impression!



"I knew
it was
The House
the minute
I saw it!"

We had been looking *everywhere* for *just* the ranch house!
And, my dear, when we drove up to *this* one! Completely
ranch style. So sleek—everything designed to make it
long and *low*. Even the roof, with those long, slim tabs,
was created for modern homes—in *pastel*! You know how
mad I am for color. We couldn't be more thrilled!"

Quick-to-see Sales-Winning Points

- Longer "Ranchline" Shingle tabs *integrate* modern design.
- Exciting colors *carry decorator theme* roof-high.
- King-size, two-tab shingles *resist wind* better—18" tabs instead of conventional 12".
- They're made by Barrett, famous in the building field.

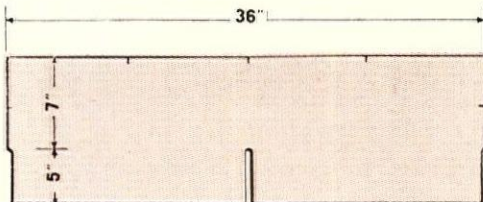

For full information about "Ranchline" Shingles and the complete Barrett line, write
BARRETT DIVISION, 40 Rector Street, New York 6, N. Y.

BARRETT ROOFS



†Trade Mark of Allied Chemical

New GENERAL ELECTRIC

Custom OIL FURNACE

A Mighty Mite for Builders

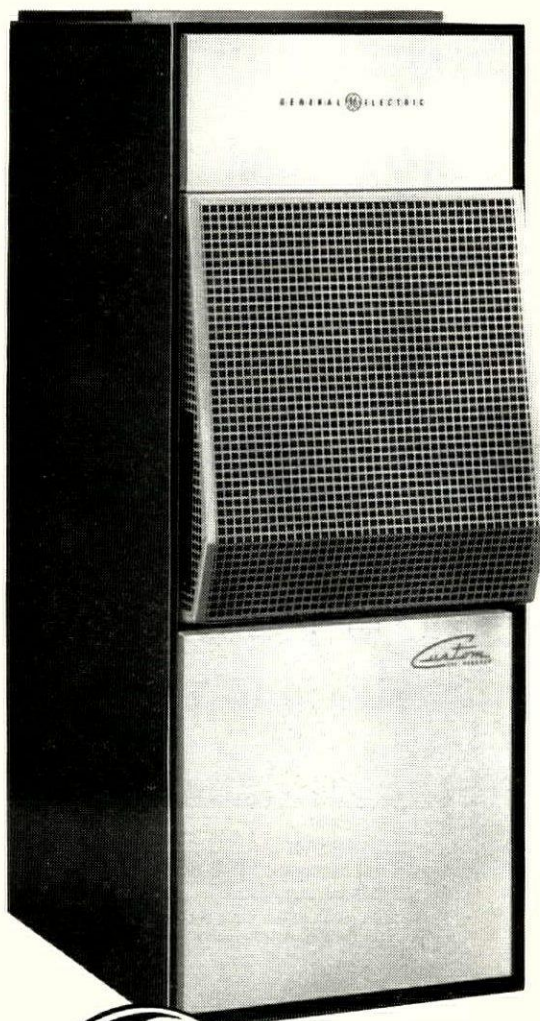

ONLY 55 INCHES HIGH!

Every model of the new General Electric Custom Oil Furnace line is only 55" high regardless of BTU output—it's the lowest hi-boy line on the market. And the smallest unit occupies only 28" x 22" floor space. Can be tucked away neatly in otherwise unusable space. Capacities from 84,000 to 112,000 BTU output.

COMPLETELY FACTORY ASSEMBLED

And this means every unit has been fire-tested at the factory—a big advantage over "field-assembled" furnaces.

"GROWS" INTO YEAR 'ROUND AIR CONDITIONING

Entire line designed with cooling in mind. Coil enclosure fits neatly atop furnace—integrates beautifully as a compact year 'round air conditioning unit.



A DREAM FURNACE THAT ADDS QUALITY TO YOUR HOMES

Smart as any kitchen appliance. Priced competitively with ordinary furnaces. Heat exchanger carries General Electric's 10-year warranty. Meets all F.H.A. requirements, plus compliance with Commercial Standard CS195-57. For full information, contact your General Electric Home Heating and Cooling dealer—in the yellow pages of your phone book. General Electric Company, Home Heating and Cooling Department, Tyler, Texas.

Progress Is Our Most Important Product

GENERAL  ELECTRIC

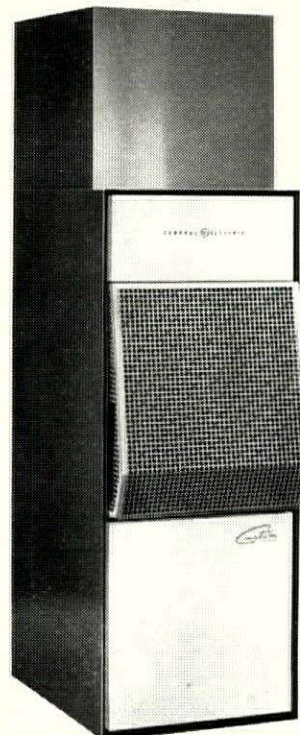



For the biggest
bonus in
insulation...choose
from these
famous-brand
blankets and batts



It's a landslide... the way homeowners today are *demanding* the **TRIPLE PLUS** of Reynolds Aluminum Foil on famous-brand batt and blanket insulation!

It makes sense, too, because the **TRIPLE PLUS** means extra comfort year-round, extra protection from moisture damage. It means smaller heating and cooling bills...savings that go on for years after they've paid back the small extra in price. Check the three pluses.

Get this big bonus in comfort, economy, security. Whether you're buying a home, building one, or merely insulating the attic of your present home, insist on one of the famous-brand products listed alongside this page. They all provide the **TRIPLE PLUS** of Reynolds Aluminum Foil.

Reynolds Metals Company, General Sales Office, Louisville 1, Ky.

THEY ALL
FEATURE THE
TRIPLE PLUS*
OF
REYNOLDS ALUMINUM
FOIL

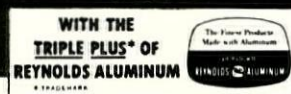

This is the Mark of Extra Value in Insulation... by the Makers of Reynolds Wrap!

THE FINEST PRODUCTS MADE WITH ALUMINUM ARE MADE WITH

REYNOLDS ALUMINUM

*Trademark

Watch Reynolds All-Family Television Show "DISNEYLAND", ABC-TV.

© 1958 Reynolds Metals Company

PLUS 1 BOUNCES OFF SUMMER HEAT!
Reynolds Aluminum Foil reflects up to 95% of all radiant heat...cools a house as much as 15°...drastically cuts air conditioning costs.



PLUS 2 THROWS BACK WINTER RADIATION!
Properly placed in walls, in ceiling, under floors, Reynolds Aluminum Foil reflects house heat back inside...cuts fuel costs.



PLUS 3 CONTROLS MOISTURE CONDENSATION!
Reynolds Aluminum Foil is a positive vapor barrier...protects homes against moisture damage just as foil packaging protects foods.



These are the different ways the TRIPLE PLUS is used

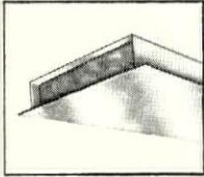

TYPE A
This insulation uses the TRIPLE PLUS all around: Reynolds Aluminum Foil completely encasing the batt on all four sides, giving the full advantage of reflective foil.

TYPE B
This insulation features the TRIPLE PLUS in another form. Reynolds Aluminum Foil one side; the other side a polished aluminum pigmented coating on kraft paper.

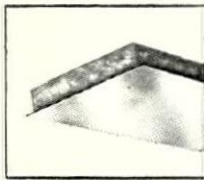
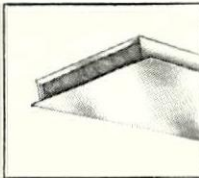

TYPE C
This type of insulation gives you the advantages of the TRIPLE PLUS in still another way... with a layer of Reynolds Aluminum Foil on one side of the batt.

... in each of these famous-brand insulations:

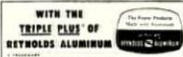

RED TOP uses Type 'A' TRIPLE PLUS

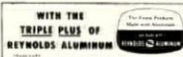

CELOTEX: Types 'A' & 'B' TRIPLE PLUS



BALSAM WOOL uses Type 'B' TRIPLE PLUS



SPINTEX uses Type 'B' TRIPLE PLUS



SEALFOIL uses Type 'B' TRIPLE PLUS

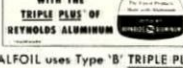

LOF uses Type 'C' TRIPLE PLUS



LOF uses Type 'C' TRIPLE PLUS



ZONOLITE uses Type 'C' TRIPLE PLUS



Fireplace complete with chimney

The new Vitroliner fireplace goes in place in four to six hours with unskilled labor, the makers claim. Shell-base, firebox, hood and stack are 16 gauge rolled iron. Firebox is refractory lined. Unit is 4'-4" wide, projects into room 2'-7", has pre-fab chimney. \$470 retail, fob Chicago.

Condensation Engineering, Chicago.

For details, check No. 18 on coupon, p. 222

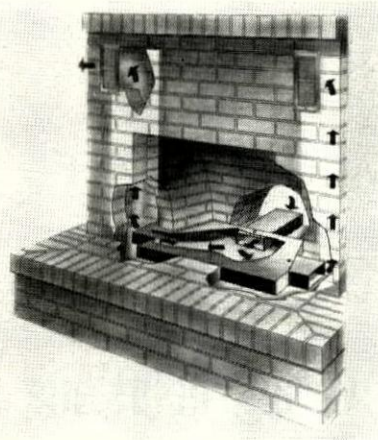

Fireplace form offers convection

The skeletonized form shown above can be quickly installed by one man. It adds warm-air convection to the fireplace's radiant heat. Available in all fireplace dimensions, unit serves as a template in constructing the fireplace. Will fit any type of fireplace.

Douglass Mfg. Corp., Los Gatos, Calif.
For details, check No. 19 on coupon, p. 222

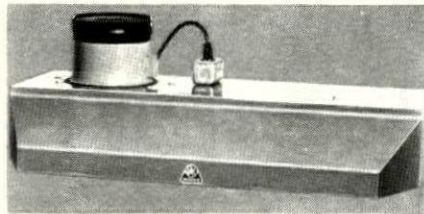

Less expensive exhaust hood

R&M-Hunter have added a budget model to their range hood line, a single packaged hood and exhaust combination to simplify at-the-site installation. 9" filter removable for cleaning. Axial flow fan. 30", 36" or 42" long. \$50 to \$52 retail.

R&M-Hunter, Memphis.
For details, check No. 20 on coupon, p. 222

Mr. Home Builder:

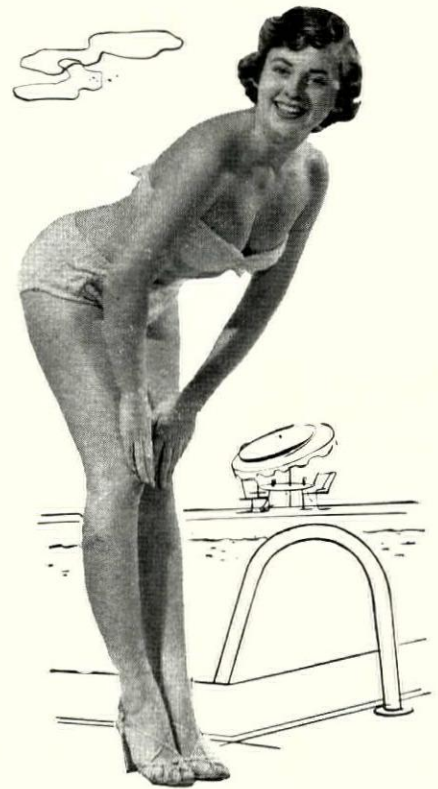

Get in the Swim
with the biggest boom since post-war housing—the swimming pool

IF YOU CAN
BUILD A BASEMENT
YOU CAN EARN...

\$1000 PROFIT
on EVERY ROMAR POOL!

- ROMAR is Easier to Sell—
- ROMAR is Easier to Build—
- ROMAR Gives More Profit Per Dollar Invested

Romar offers a **complete** pool package. All you have to do is sell and install.

For full information write to —

Romar

Division of
ROMAR FILTER CORPORATION
1802 W. North Ave. • Milwaukee 5, Wis.

continued on p. 210

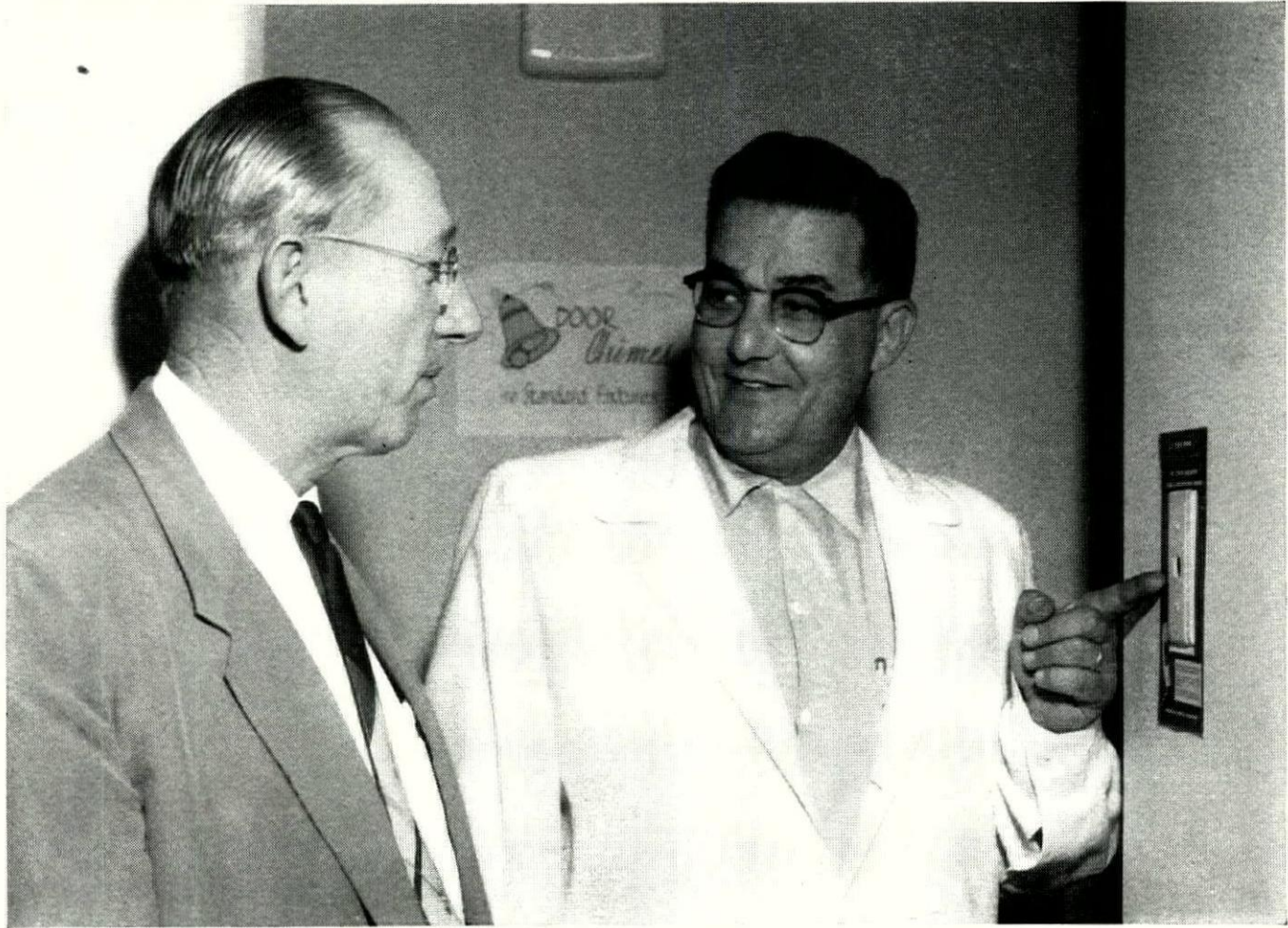

Builder Dale J. Bellamah (right) discusses the location of a telephone outlet with J. P. McBurney of Mountain States Telephone and Telegraph Company.

“Concealed telephone wiring helps me merchandise my homes”

—says Mr. Dale J. Bellamah, Builder, of Albuquerque, New Mexico

“Right now I’m building a community of some 2000 homes,” says Mr. Bellamah. “And in every home we’re putting concealed telephone wiring.

“It’s a real sales aid. It helps me merchandise my homes. We list it in our advertisements, and we point to it as an example of what we mean by our slogan, ‘First in size—first in new ideas.’

“If you’re in the business of building modern homes for people with modern ideas, you can’t expose the telephone wiring any more than you can expose the plumbing!”

Mr. Bellamah is the biggest builder in New Mexico. During the past ten years he has built upwards of 5000 homes. He has been on the

Executive Committee of NAHB among many other positions he has held in that Association, and in 1956 he was National Chairman of the Military Housing Committee. Mr. Bellamah is one of many trend-minded builders throughout the country who are convinced that concealed telephone wiring is a modern feature that helps them sell their homes in today’s highly competitive market.

* * *

Your local Bell Telephone Business Office will be glad to help you with concealed wiring plans. For details on home telephone wiring, see Sweet’s Light Construction File, 8i/Be. For commercial installations, Sweet’s Architectural File, 32a/Be.

BELL TELEPHONE SYSTEM





PAUL McCOBB* DESIGNED



PHOTO BY TOM YEE

this "patio-privacy" screen of Blue Ridge Patterned Glass to help you sell houses!

World-renowned designer Paul McCobb has a sixth sense about people and what they like. What prospective home buyer wouldn't love an area like this, designed for the sheer luxury of relaxing? You are *outdoors*, yet you're protected from the sun (or rain) by the roof and its overhang. You are *outdoors* yet you're screened from the eyes of passers-by (and protected from chilling breezes) by a handsome partition of patterned glass . . . alternate panels of beautiful Blue Ridge Corrugated and Muralex® patterns framed in rich redwood.

This is just one of eight great house-selling ideas Paul McCobb has created with Blue Ridge Patterned Glass. They're all illustrated in a new 20-page booklet. Mail coupon, for yours.



Patterned Glass by Blue Ridge

BLUE RIDGE GLASS CORP., Kingsport, Tennessee
SOLD THROUGH LIBBEY-OWENS-FORD DISTRIBUTORS AND DEALERS

LIBBEY-OWENS-FORD GLASS CO., Dept. B-748
608 Madison Ave., Toledo 3, Ohio
Please send me free a copy of booklet showing Mr. McCobb's Decorating Ideas with Blue Ridge Patterned Glass.

NAME _____
STREET _____
CITY _____ ZONE _____ STATE _____

*Paul McCobb, whose designs in furniture, fabrics, wallpaper, floor coverings and lamps have won international awards, now turns his talents to Blue Ridge Patterned Glass.

REVCO

Bilt-In Refrigeration



Architect: Don Erickson, Des Plaines, Illinois

Leader by far in built-in sales!

The flexibility and classic beauty of Revco Bilt-Ins open new horizons in design. Distinctive finishes include stainless steel, copper-glo, 28 custom colors and matching wood panel doors. Standard 3-foot modular refrigerators and freezers may be built in almost anywhere . . . singly or in combination, over and under or side by side. In any arrangement, Revco units are the easiest built-ins to install! Leading kitchen manufacturers prefabricate cabinets for Revco Bilt-Ins, or cabinets may be custom built to specifications furnished. These are the reasons why Revco is the unquestioned leader in the built-in refrigeration field.

NOW! Years ahead

Gourmet



The new Revco Gourmet refrigerator achieves *exclusive* cooling efficiency. Chilled, purified air gently circulates throughout the entire food compartment. Constant temperature is maintained *automatically* and is precisely controlled at settings from 32 to 45 degrees, to preserve foods at their peak of flavor and freshness.

REVCO

Setting trends in refrigeration since 1938.

Send for your
free copy of

"ARCHITECT'S
INFORMATION FILE"
today!



REVCO, Inc., Deerfield, Mich., Dept. HH-48

Please send me the complete Architect's Information File on Revco Bilt-In Refrigerators and Freezers.

Name _____

Firm _____

Street _____

City _____ Zone _____ State _____

New products



New bathtub enclosure line

Doors of fluted or hammered glass are framed in anodized aluminum in the new Bathe Rite line. Other features: nylon rollers and guides; large weep holes in bottom track; two towel racks. Enclosure installs with only a screwdriver. Sizes to fit 4½', 5', 5½' tubs.

Milwaukee Stamping Co., Milwaukee.

For details, check No. 21 on coupon, p. 222

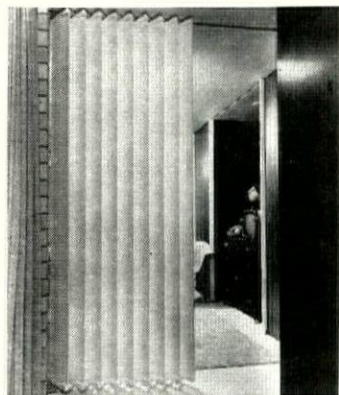

Folding door controls light, air

The louvers in the Louver-fold door can be closed tight or opened to any degree. The hollow airfoil wood panels hang from a pantograph, ride nylon rollers on a single overhead steel track. Stock doors (\$45 to \$65 retail) are 6'8" high, 2'4" to 4' wide, in Philippine mahogany; custom doors to 10' high, 24' wide in choice of woods.

Consolidated General Prod., Houston.

For details, check No. 22 on coupon, p. 222

Aluminum roof in a can

Luma-Tint, called a "colored aluminum paint for roof siding" by its makers, is more a roofing compound than a paint. It is asphalt based with aluminum pigment and asbestos fiber added, can be applied with brush or spray gun, is said to spread like soft butter.

The paint can be used on asbestos, asphalt or combination shingles, tarpapers, corrugated metal, concrete, cinderblock or stucco. It is claimed to remain elastic, reflective, and resistant to chemicals, sun and water erosion; and to be heavy and elastic enough to bridge small cracks and holes to waterproof leaky roofs.

It comes in two greens, two blues, terra cotta, copper, gray gold, silver. Price: \$6.70 per gallon (Sherwood green and Horizon blue, \$7.20).

James B. Sipe & Co., Pittsburgh.

For details, check No. 23 on coupon, p. 222

continued on p. 214

PROTECT YOUR CUSTOMERS

AGAINST
NAIL
SPOTS
with...



MAZE

STORMGUARD

STRONG STEEL NAILS
DOUBLE-DIPPED in MOLTEN ZINC

NAILS

- NO RUST SPOTS, STAINS, OR STREAKS!
- STRONGER THAN ALUMINUM . . . COST ABOUT 1/3 LESS!
- HARD STEEL CORE . . . DRIVE BETTER . . . HOLD TIGHT!

More and more home builders and prefab manufacturers are finding it pays to use Maze's specially designed, weather conditioned STORMGUARD nails for all exterior applications and materials—WOOD SIDING, CEDAR SHAKES, ASBESTOS, INSULATING, HARD-BOARD SIDING, etc. Available in matching colors. . . . Also nails for all kinds of roofing, roof decking, and trim!

HOMES BUILT WITH STORMGUARD NAILS ARE EASIER TO SELL . . . CUSTOMERS STAY SATISFIED—FEWER UP-KEEP OR PAINTING PROBLEMS!

And the difference in cost between STORMGUARDS and ordinary nails is so little!

TRY 'EM NOW!

FULL RANGE
OF SIZES

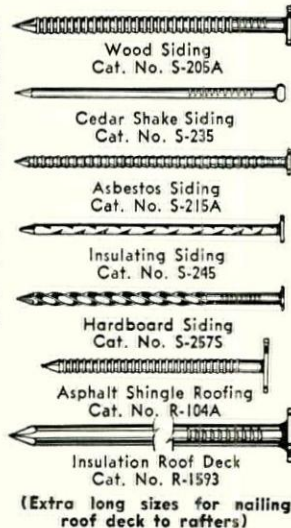

Ready-Packed in
handy 5 lb. and 50 lb. bulk
cartons

SEE YOUR DEALER, OR

WRITE FOR FREE CATALOG & SAMPLES

NAME _____

FIRM _____

ADDRESS _____

CITY _____ STATE _____



"IT PAYS TO BUY MAZE"

W. H. MAZE COMPANY

PERU 12, ILLINOIS

MASONITE

Makes the News

Exterior Grade DORLUX Panels *guaranteed for life*

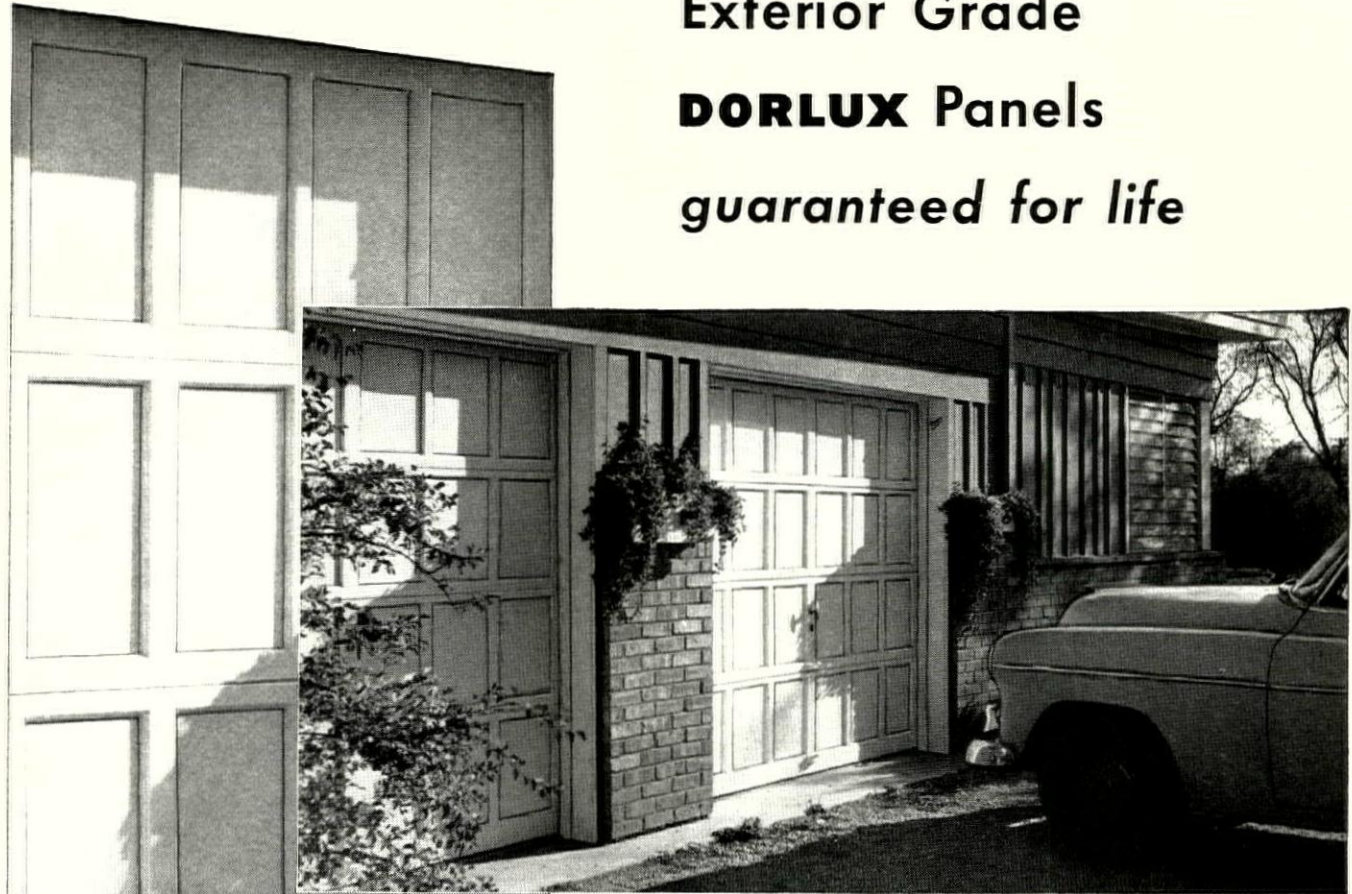

Here's an "extra value" you can offer prospects, at virtually no extra cost to you—a "Lifetime Guarantee" label on the panels of the garage door. It's a quiet but effective way to tell visitors of your care in selecting quality materials.

Most major manufacturers of upward-acting doors use Masonite® Exterior Grade Dorlux® for panels. With many, this smooth, grainless, easy-to-paint hardboard is *first choice*. Send the coupon for a free folder that tells more about the advantages of this lifetime material.



®Masonite Corporation—manufacturer of quality panel products.

.....

MASONITE CORPORATION
Dept. HH-4, Box 777, Chicago 90, Ill.

Please send me your folder describing lifetime-guaranteed Exterior Grade Dorlux for garage door panels.

Name.....

Firm.....

Address.....

City..... State.....

Zone..... County.....

320 "Medallion" Homes



Indiana builder cashing in
on merchandising power of new
Live Better Electrically Medallion Home Program
... typical of builders all over the country.



BUILDER HARRY SWANSON

Each of the 320 homes in Harry Swanson's South Bend subdivision, "Swanson Highlands," will be awarded the Live Better Electrically Medallion—the new hallmark of electrical excellence in home building. The Medallion is being promoted both nationally and locally by electric utilities, leading manufacturers and distributors to help builders profit from the growing consumer demand for better electrical living. Swanson's homes—in six models priced from \$23,000 to \$28,000—feature all the latest in electrical appliances and equipment.

"Houses of the latest electrical design sell faster," says Swanson, "and the merchandis-

ing opportunities of the Medallion Home are a bonanza to the builder." Swanson is working closely in his promotions with Indiana & Michigan Electric Company, and will launch a full-scale sales campaign this March. The



Live Better Electrically Medallion Home certificate awarded to Harry Swanson by J. Benson Hall and Harold West of Indiana & Michigan Elec. Co.

**CONTACT YOUR LOCAL ELECTRIC UTILITY
YOU CAN TAKE ADVANTAGE OF THE LIVE BETTER**

Going Up in South Bend

utility will run their own newspaper ads featuring Medallion Home living. Swanson will run newspaper ads and use radio spots over three stations.

Whether you build 6 or 600 homes a year, you can benefit from the sales power of the Live Better Electrically Medallion Home Program. The entire electrical industry will back you up. In addition to powerful utility support, you'll get promotional help from leading manufacturers whose products you feature—Frigidaire, General Electric, Hotpoint, Kelvinator, Philco, Westinghouse and Whirlpool.



Live Better Electrically Medallion is installed on new home as builder Swanson looks on.



Medallion homes now under construction at the "Swanson Highlands" subdivision. Every home has its own sign featuring electrical living.



Utility's home economist, Patricia Altenberg, demonstrates built-in electric oven to new owner of Live Better Electrically Medallion home.

IMMEDIATELY FOR FULL DETAILS ON HOW ELECTRICALLY MEDALLION HOME PROGRAM!

Designed
for the
HOME BUILDER
TECO's *New*
**TRUSSED RAFTER
BOOKLET**



USING

TECO WEDGE-FIT

RING CONNECTORS

**24-PAGE
AWARD WINNING
BOOKLET CONTAINS . . .**

▶ 12 typical TECO trussed rafter designs with specification and material lists.

▶ COMPLETE DATA to build, assemble, ship, and erect TECO trussed rafters.

You can build your own TECO trussed rafters ECONOMICALLY and with only a MINIMUM EQUIPMENT INVESTMENT.

▶ Send for FREE COPY, "DESIGN AND USE OF TECO TRUSSED RAFTERS"

TIMBER ENGINEERING CO.
1319 18th Street, N.W.
Washington 6, D. C.

HH-583

Name

Firm

Street

City State

New products

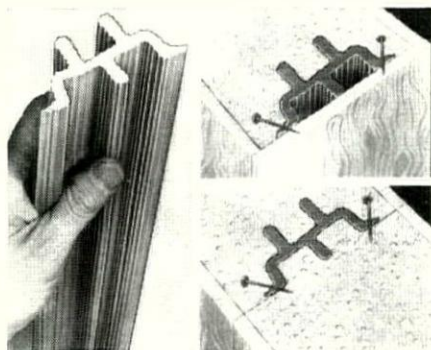

Plastic seal stops water seepage

Water Seals, Inc. insures a watertight union between two pours of concrete with a polyvinyl gasket. The Labyrinth Water-stop is 3½" wide, 1¾" high, ¼" thick in section. A flange is provided on each side for nailing and the face is corrugated to assure a good bond.

Water Seals, Inc., Chicago.

For details, check No. 24 on coupon, p. 222

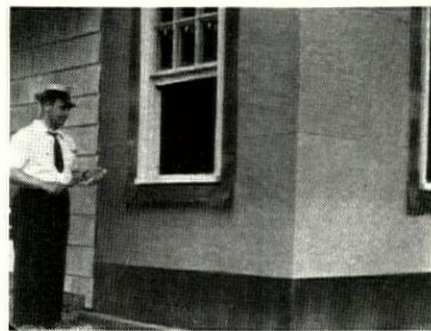

Plastic-on-paper flashing

Moistop, a durable but inexpensive flashing (3½¢ a sq. ft.) has been added to the Sisakraft line. It is made of polyethylene bonded to rot-resistant Sisakraft paper. Moistop has been available in wide rolls as a vapor barrier, now comes in 120' rolls to 60" wide for flashing doors, windows, sills, etc.

American Sisakraft Corp., Attleboro, Mass.

For details, check No. 25 on coupon, p. 222

Removable muntins added to line

Rolscreen has added this optional extra to its full line of Pella windows. The muntins come in horizontal and multipane types, snap into place with a simple ball-and-socket arrangement.

Rolscreen Co., Pella, Iowa.

For details, check No. 26 on coupon, p. 222

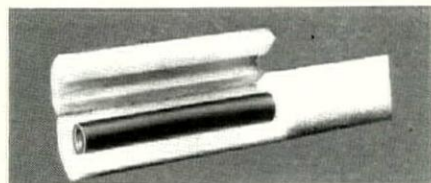

Complete cold pipe insulation

Styrofoam is being made into a low-temperature pipe covering. The lightweight plastic is rotproof, moldproof, waterproof, odorless, also has high insulating value. The new pipe covering is made with adhesive edges for quick and easy application.

Glo-Brite Products, Chicago.

For details, check No. 27 on coupon, p. 222

**CHALK UP
more Home Sales**

with this popular
built-in barbecue



**Majestic
CHAR-GRILL**

the "package" built-in
charcoal barbecue grille
with vent-hood

There's no need to improvise the proper grille-and-hood team for successful indoor charcoal cooking. Majestic has heat-engineered an ensemble that does the job right.

The Majestic CHAR-GRILL is a heavy gauge steel built-in unit, attractively squared-off to meet the latest trend in kitchen appliance styling. Models are available for installation in wood, metal or masonry. Convenience features include a removable, adjustable fire pan of heavy boiler plate steel and a handy front access door. An electric rotisserie spit and insulated wood or metal cabinet installation kit are available.

Hood has Powerful Blower

The Majestic CHAR-GRILL VENT-HOOD is a perfect teammate to the sleek barbecue grille. It is proportioned exactly to effectively exhaust excess heat. It comes equipped with a powerful built-in 400 CFM twin squirrel cage blower, twin lights, separate switches for blower and lights, aluminum washable filter and a special wall mounting kit. Three hood finishes are available—stainless steel, and coppertone or black wrinkle enamel.

Together, the hood and grille make up the right package for delicious charcoal broiling and barbecuing.

Write now for complete details on the Char-Grill ensemble!



Installation kit for standard 36" wood and metal cabinets.

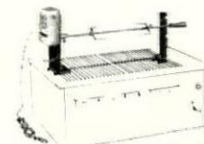

Attachable, adjustable electric barbecue spit.

INVESTIGATE CHAR-GRILL!

It fits the builder's plans
— fulfills the buyer's dreams.

The **Majestic** Co., Inc.

413-C Erie Street, Huntington, Indiana

continued on p. 218

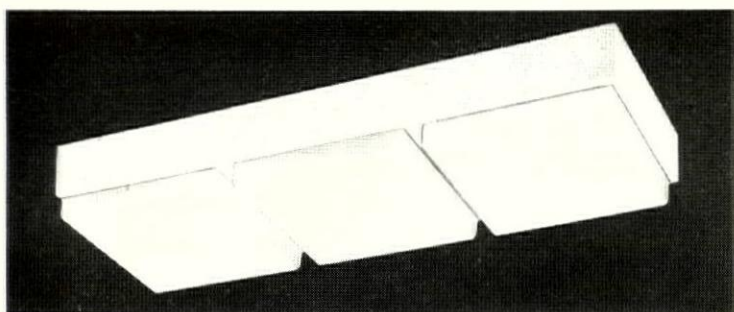
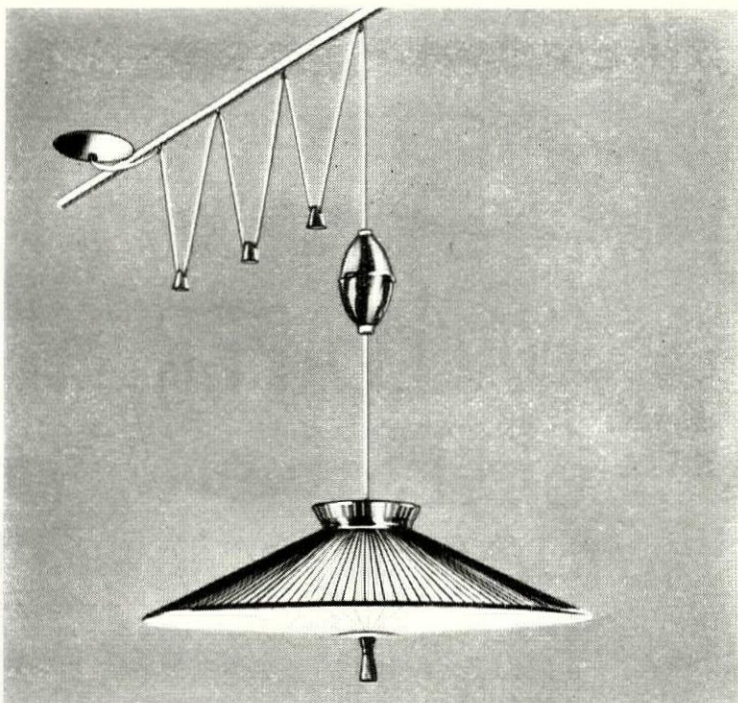

LIGHTOLIER

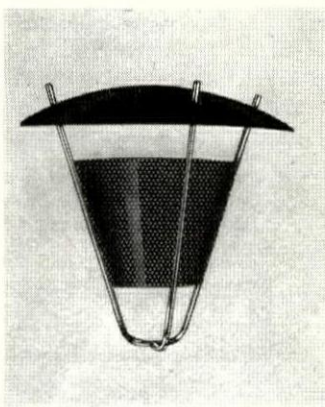
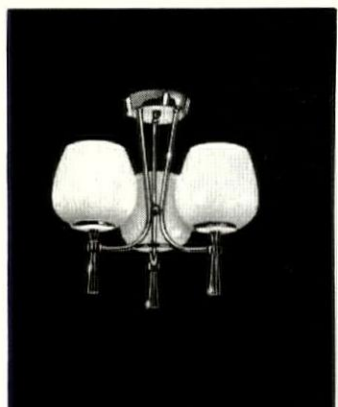
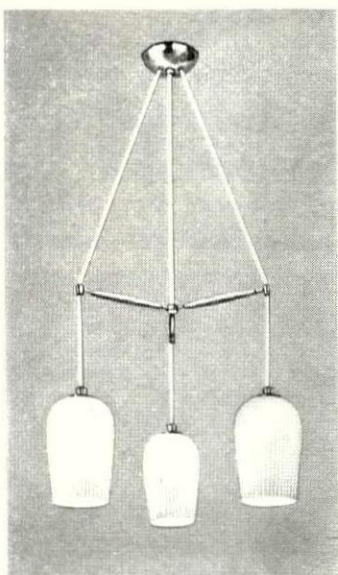

THEY REMEMBER
THE HOUSE WITH FIXTURES BY

It's a fact: your prospects remember model homes equipped with Lightolier fixtures. And for these reasons: they look so lovely, give so much light, do so much. Women know the name Lightolier, know it stands for quality, accept your Lightolier as a symbol of all the qualities in your house that they can't see. That's why it pays to install Lightolier fixtures. Another reason: a new kind of builder merchandising plan . . . a way to get our distributors to personally follow-up your prospects for you! Fill out coupon below for details!

LIGHTOLIER
Dept. HH-48
Jersey City 5, New Jersey

Please send me all the details about your builder merchandising plan.

Name _____

Firm Name _____

Address _____



at your service...

THE COMFORT TEAM FROM

Rheem offers you convenience and economy for all your home comfort essentials. In water heaters . . . warm air heating systems . . . steam and hot water boilers, Rheem meets the requirements of every home . . . providing a full line of high quality products designed to reduce construction costs and at a price that represents real value to both you and the home buyer.

Rheem makes the comfort package complete with the new Rheemaire Air conditioning system. Rheemaire cuts operating costs almost in half . . . makes home cooling as practical as home heating.

Learn how Rheem brand name acceptance can be used to add extra selling power to your homes. Consult your Rheem Plumbing Contractor and your Rheem Heating and Air Conditioning Contractor for full details.

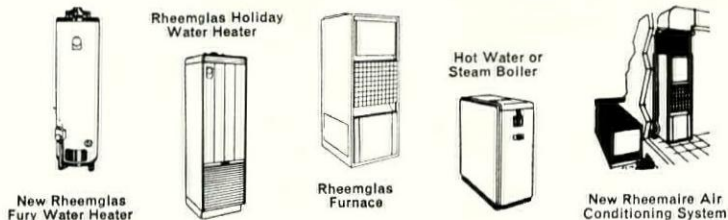

New Rheemglas Fury Water Heater

Rheemglas Holiday Water Heater

Rheemglas Furnace

Hot Water or Steam Boiler

New Rheemaire Air Conditioning System

YOU CAN RELY ON



THE BIG NAME IN COMFORT PRODUCTS FOR THE HOME

water heaters, steam and hot water boilers, central air conditioning, warm-air furnaces, plumbing fixtures and water softeners
South Gate, Calif. • Houston • Chicago • Sparrows Pt., Md.



WALLPAPER SELLS HOMES

because . . . no other wall decoration can add such a look of luxury and individuality at such modest cost. Paper your next model and see for yourself!

WALLPAPER COUNCIL
509 MADISON AVE., NEW YORK 22, N. Y.

SELLING BETTER BECAUSE THEY OFFER MORE!

BURR-SOUTHERN* BUILT-IN BARBECUES

preferred for smarter styling, greater versatility



SOUTHERN HOST

SH-424. 3-in-1, features spit cooking, broiling, shishkebab. Designed for kitchen, family room, etc. Mat black or bronze enamel, brassplated or stainless steel face plate.



SOUTHERN ADJUSTAFIRE

FP-516. Use indoors or out. Stationary grill, firebox adjusts for controlled heat. Black or bronze hammer-tone enamel. No installation needed. (Spit optional.)

Dealer Inquiries Invited. Write for details. Free barbecue plans on request.

DELIVERY MADE WITHIN 14 DAYS.

**Originators of built-in barbecues.*

BURR-SOUTHERN CORP. OF CALIFORNIA

241 N. Allen Ave.,

Pasadena, Calif.

DON'T MISS

THE ANNUAL

FEATURE ISSUE

ON

HOME MERCHANDISING

HOUSE & HOME

MAY 1958

"I Can't Say Enough for the Rilco Beams!"

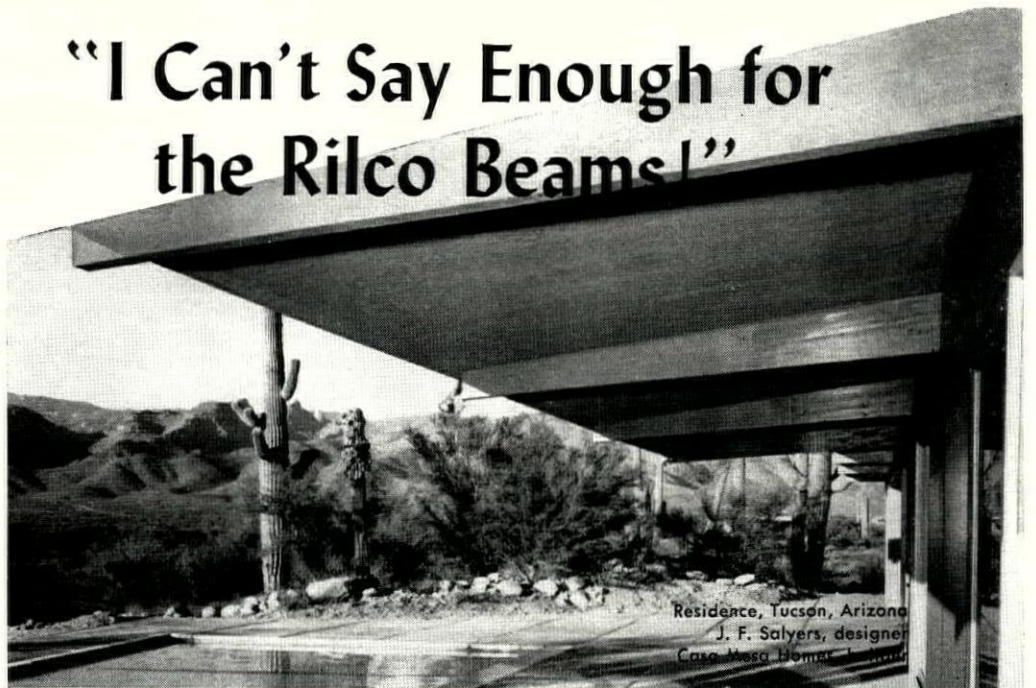

Residence, Tucson, Arizona
J. F. Salyers, designer
Casa Mesa Homes

Writes Mr. J. F. Salyers. "They all fit perfectly with no twists or crowns. No sanding or filling was required. The Rilco beams have all the advantages, plus strength, of wood and none of the disadvantages. The finished appearance is so much better that there is just no comparison.

"We have had plenty of comments about these beams and they are mostly the same: 'They are beautiful.' 'Can you work them in our plan?'"

Striking Rilco laminated members blend well with any architectural style—allow wide latitude of expression with complete design freedom. And Rilco members retain their beauty, require little if any maintenance, increase their warmth with age—resist warping, splitting, cracking.

Laminated members are available in sizes difficult or impossible to obtain in solid construction. And now Rilco stocks standard-size flat beams, assuring prompt delivery with the low price of volume production.

Rilco members and Rilco Deck may be able to help you solve a design problem. For complete information contact your nearest Rilco office.



Rilco laminated wood beams from 30 ft. to 42 ft. long were used. "They all worked PERFECTLY" said the builder.

RILCO
works wonders with wood

RILCO LAMINATED PRODUCTS, INC.

W 843 First National Bank Building
Saint Paul 1, Minnesota

District offices: Newark, N. J. • Fort Wayne, Ind. • Tacoma, Wash.

A SCREW IS AS EFFECTIVE AS THE WAY YOU DRIVE IT

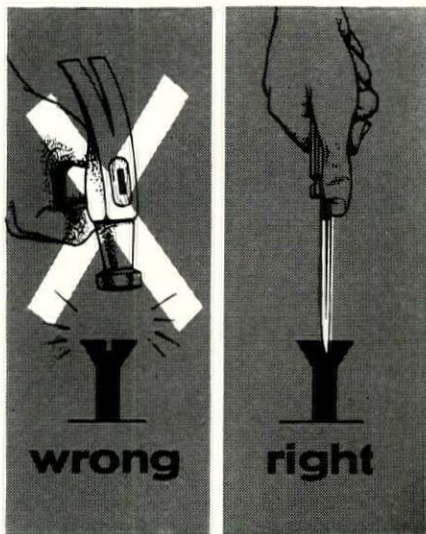

Drive a Southern Screw right, and you've got holding power and permanence that is unequalled by any other fastener. Southern makes every screw it sells—from U. S. A.-made materials and by U. S. A.-people. You can't buy a better screw than Southern Screw!

Available in all head styles, slotted or Phillips, in all wanted finishes.

Write us your requirements:
SOUTHERN SCREW COMPANY,
Box 1360-HH,
Statesville, North Carolina

**Wood Screws • Machine Screws & Nuts
Tapping Screws • Dowel Screws • Drive
Screws • Stove Bolts • Carriage Bolts
Hanger Bolts**

Warehouses:
NEW YORK • CHICAGO • DALLAS
LOS ANGELES

Sold Through Leading Wholesale
Distributors



The story of laminated timbers

The A, B, C's of how, why and when to use permanently bonded built-up timbers are given in a new book. You'll find here reprints of articles on the history and development of laminated timbers, a story about how laminated beams are designed and built to specifications, an article on the uses of laminated posts and beams in residential construction, and a summary evaluation of glued beams vs. conventional I-beams in resistance to fire and maintenance of structural strength under high temperatures.

Also included are the names and addresses of American Institute of Timber Construction members who help engineer and complete fabrication of beams and posts to individual specifications. "Structural Glued Laminated Construction" booklet from:

Koppers Co. Inc., Chemical Div., Pittsburgh 19.

For copy, check No. 28 on coupon, p. 222

Guide to overhead garage doors

Barcol's line of OVERdoors is fully described in this book which features the new Weather-King flush overhead door sections, claimed to combine high insulation value sandwich construction with weather-proof facing.

Described and illustrated are Weather-King door panels, electric operators, closing hardware, radio controls. You'll find, too, specifications and instructions for preparing building openings; installation of various models is shown with detail drawings. A special section details solutions to difficult installation problems.

Barber-Colman Co., Rockford, Ill.

For copy, check No. 29 on coupon, p. 222

New heating cable specifications

GE's wire and cable department has revised a book on heating cable, brought it up-to-date with information on cables, their application and installation.

Product information and specification data on five types of cable are given: lead-jacketed asbestos, thermoplastic-jacketed, silicone rubber, asbestos-braided, and silicone rubber resistance wire. Typical applications discussed are pipe heating and snow melting. Gives complete specifications and installation data.

General Electric, Bridgeport 2, Conn.

For copy, check No. 30 on coupon, p. 222

Here's masonry in panels

Paneled Redibrik is a new kind of masonry veneer that looks like Roman Brick but is assembled on standard insulation board, forming prefabricated panels that can be directly nailed to the studding of new construction. The new panels are explained in a booklet titled "Paneled Masonry."

Material can be used in remodeling, too. Depending upon surface conditions you can apply panels directly to old masonry walls or to easily attached wood strips which serve as a nailing base.

For remodeling, panels come 48" w. x 16" h.; an area of 5 1/3 sq. ft. For new construction you can get any size panel up to 4' x 8' or a maximum area of 32 sq. ft.

Redibrik Industries, Inc., Holland, Mich.

For copy, check No. 31 on coupon, p. 222

News about new skylights

A new booklet shows off some new skylight styles. AIA File 12-J on the Vanco Plexiglas Domelite describes its features: strength, self-cleaning properties, lightness, weather-tightness.

Specifications are given for square and rectangular models—some complete with insulated curb—for the double Domelite and for a variety of other models like the Ceilinglite, Skyshade, etc.

E. Van Noorden Co., Boston 18.

For copy, check No. 32 on coupon, p. 222

Here's help in floor treatment

This four-page estimating guide outlines uses and costs for 37 products. Brochure lists products you can use for treatment of concrete and wood floors, as well as admixtures for concrete and mortar and waterproofing and dampproofing compounds. For each product there is listed information on use, quantities required, method of application and cost. From the information given, specific products for construction or maintenance needs can be selected.

L. Sonneborn Sons, Inc., Bldg. Products Div., New York 16.

For copy, check No. 33 on coupon, p. 222

Lighting fixtures and systems

Sylvania's new booklet contains 56 illustrations of industrial, commercial and residential fixtures and systems and gives special emphasis to design advantages and construction-operational characteristics.

A special page of the booklet describes wall-to-wall lighting systems, among them Sylvania-Lume, Sylvania's modular interchangeable plastic panel system that can be designed in a variety of over-all patterns.

Sylvania Lighting Products, Sylvania Electric Products, Inc., Wheeling, W. Va.
For copy, check No. 34 on coupon, p. 222

Check-up for fire protection

A new reference book for architects, contractors, engineers deals with construction involving fire protection equipment. It's called "Checkbook" and it is a digest of essential considerations for any installation except sprinklers.

Book facilitates selection of equipment from a wide and complicated range and helps in specifications, both written and drawn, and in supervising installation.

Illustrations, diagrams and model specifications in coupon form elaborate the text.

W. D. Allen Mfg. Co., Chicago.

For copy, check No. 35 on coupon, p. 222

How to plan shoji screens

This compact planning book contains detail drawings for custom shoji screens elaborated with handsome photographs.

Various types of shoji frames are illustrated plus details on how and where to use shojis. You'll find examples for sliding wardrobe doors, wall-length screens, multiple screens that can divide rooms, panels for use in front of glass walls and doors, panels for use in front of windows.

Job sheets list type of shojis, woods used in framing, backing material.

J. M. Hirai, San Francisco 18.

For copy, check No. 36 on coupon, p. 222

continued on p. 222

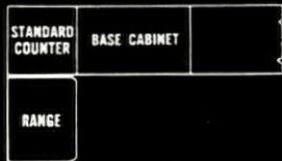

1. Straight Counter Corner
 Republic's base end closure panel for a dead corner adjacent to an appliance is in a straight line, providing greater economy because no special corner counter top is needed as with some other brands. Saves up to 30%.

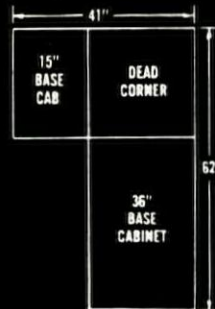
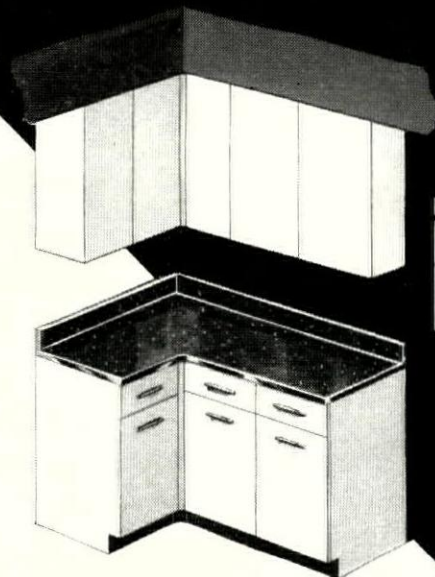

2. Dead-Corner Plan— Most economical way to turn a corner, but sacrifices two feet of corner storage below counter, three feet in wall cabinets. Stock corner fillers join the cabinets.

4

ways
to
cut
corner
costs

You can answer the requirements of any kitchen, any buyer . . . and you cut costs . . . when you select and install Republic Steel Kitchens. Work's done in a few hours, rather than putting in job-built wood cabinets that take two men up to a week to finish. And . . . there's *no* painting, *no* finishing, *no* expensive callbacks to fix warped doors and sticky drawers.

Enjoy planning freedom *plus real economy* with the flexible Republic Steel Kitchens line. Here, for example, are but four of 54 *sales and savings ideas* from our popular "Kitchens Sell Homes" booklet. Start cornering your costs . . . send for your free copy today.

REPUBLIC STEEL KITCHENS
 BUILDER SALES • DEPT. C-5229
 1028 BELDEN AVE., CANTON 5, OHIO

- Send my free copy of "Kitchens Sell Homes."
- Have my nearby Republic Steel Kitchens distributor call.



Name _____
 Firm _____
 Address _____
 City _____ Zone _____ State _____

REPUBLIC STEEL Kitchens

TURQUOISE • PINK • WHITE • YELLOW . . . at no extra cost!

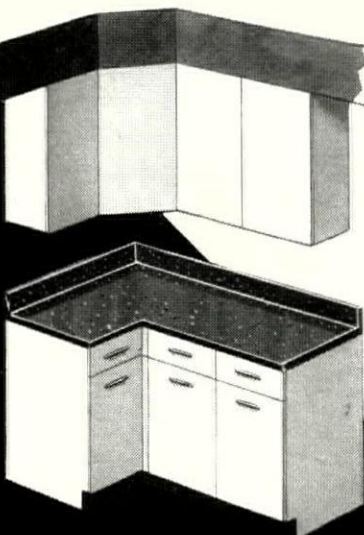

3. Reversible Corner Plan
 Republic's 44" corner cabinet can be switched right or left. Dead-Corner Plan costs 1/3 less, but reversible method provides maximum corner storage. Same stock counters as in No. 2 can be used.

4. Diagonal Corner Plan
 Spinner cabinet and stock matching counter still costs less than No. 3, looks deluxe. Full storage counter allowed here, and on wall where Republic's corner wall cabinet has been used.

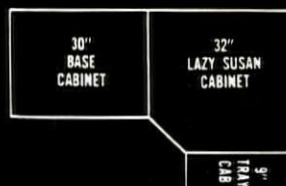
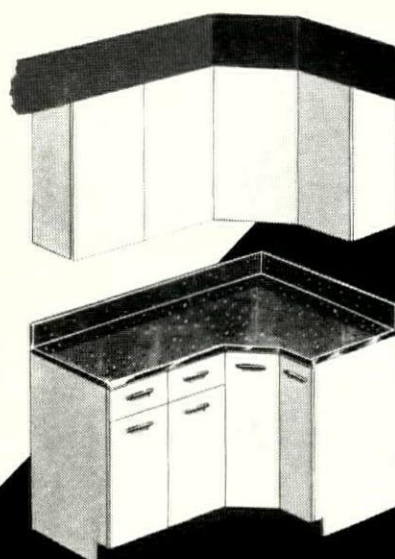

HEAT A ROOM...OR YOUR ENTIRE HOME

with
Modern

**ELECTRIC
HEAT**



- Automatic
- CLEAN
- SAFE
- QUIET
- TROUBLE-FREE

Thrift Trim

BASEBOARD HEATERS

Learn about the advantages of economical *Thrift-Trim* Electric Heating. Cost less to buy and install than other permanent types . . . give you extra comfort and economy of individual room temperature control. Inconspicuous beauty too. Ideal for offices, motels, etc.

FREE Heataire literature full of IDEAS!

MARKEL LA SALLE
ELECTRIC PRODUCTS, Inc. PRODUCTS, Inc.

Write Dept. HH, BUFFALO 3, N. Y.

Export Dept.: 15 MOORE ST., N. Y. 4, N. Y.

In Canada: MARKEL Electric Products, Ltd.,
Ft. Erie, Ont., Canada



There's an electric system to exactly suit your needs . . . baseboard, fan-forced or radiant heat!



ELECTRIC PLANT
NEWS



Here's how Onan
Portable Power
pays you
added profits!

Gives you cost-cutting power on the job . . . from the start

Carry, truck or wheel in an Onan and you're all set with plug-in power for the whole crew. No wasting time with hand tools . . . no waiting for utility lines. If you're not using electric power *full time* chances are you're losing more money than the cost of several Onan plants.

4-cycle dependability

Onan plants are rugged . . . built to take abuse from weather and workmen. Special cast-iron block Onan engine and drip-proof all-climate Onan generator are direct-connected in a rigid, compact, smooth-running unit. Out-perform and outlast "assembled type" plants using general purpose engines. *Special contractor models from 500 to 10,000 watts.*



2500-watt model serves crew of 3!

Model 205AJ-1P, most popular Onan unit with residential contractors. Complete as shown with 4 plug-ins, pilot light, carrying frame, recoil starter . . . ready to run. Dolly-mounted model also available.

New folder helps you choose the right model for your job. Write today!

D. W. ONAN & SONS INC.

3144A Key University Ave. S.E., Minneapolis 14, Minnesota

ELECTRIC PLANTS • AIR-COOLED ENGINES • KAB KOOLER • GENERATORS



now an aluminum window

DESIGNED FOR AIR-CONDITIONED HOMES



PROVEN 66% BETTER THAN RECOGNIZED AIR INFILTRATION STANDARDS

To gain real savings in air conditioning and heating operations you want to use a truly weather-tight window. All Watson windows feature thick wool pile weather-stripping, vinyl glazing and rugged aluminum design which make them 66% better than recognized standards as proven by actual air infiltration

tests by a Texas College. Precision engineered of troublefree aluminum . . . adapted to brick, frame or masonry construction . . . come glazed and ready to install—Watson windows, in a variety of styles and sizes, are guaranteed 5 years. See SWEETS or write today for complete catalog!



**WALLPAPER
SELLS
HOMES**

because . . . no other wall decoration creates that finished, "ready-to-move-in" atmosphere that so often turns prospects into buyers. Paper your next model . . . and see for yourself!

WALLPAPER COUNCIL
509 MADISON AVE., NEW YORK 22, N. Y.

Watson
RUGGED ALUMINUM

WINDOWS
W. M. PRODUCTS CO.
5425 Blossom, Houston 7, Texas
Dept. HH-2

Give your customers their choice of...

Beautiful Siding

● Many successful home builders have learned that modern home designs can be enhanced with the use of enduring wood sidings. These builders find they can take advantage of the wide choice of wood siding patterns to increase their sales opportunities.

Weyerhaeuser offers builders an outstanding selection of popular patterns. Each pattern is precision manufactured from one of the West Coast softwood species, and scientifically kiln-dried. Each bears the Weyerhaeuser 4-Square brand name, which gives your customers assurance of reliability and quality.

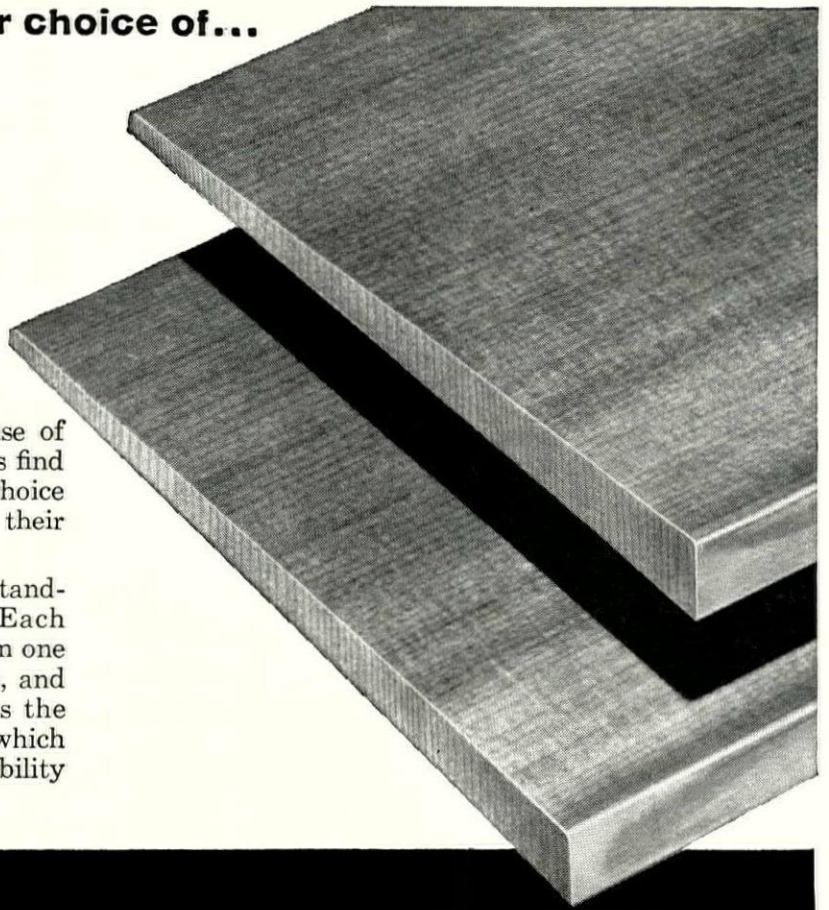

Weyerhaeuser **4-SQUARE**[®]

LUMBER AND BUILDING PRODUCTS



Natural finish Red Cedar siding gives this lovely contemporary home a pleasant informality.

Basically better because...

IT'S KILN-DRIED

- Trademarked Weyerhaeuser 4-Square Lumber is properly seasoned by scientifically controlled methods of drying. The result is lumber which has maximum strength, finishes easily, and holds nails securely. Kiln-drying also promotes dimensional stability.
- Besides being kiln-dried, Weyerhaeuser 4-Square Lumber is precision manufactured, uniformly graded and identified, and carefully handled. All these features contribute to the consistently high quality of Weyerhaeuser 4-Square Lumber, creating customer satisfaction and profitable repeat business for builders who use it. The Weyerhaeuser 4-Square trademark is your assurance that you are buying lumber and building products which are basically better.

Weyerhaeuser Sales Company
ST. PAUL 1, MINNESOTA

NEW

Sunlight

**ALUMINUM SLIDING
GLASS DOORS**

**Biggest QUALITY
VALUE of all**



TO BUILDERS: AS LOW AS
\$69⁰⁰

6 ft. wrap-around size for
single glazing. Full frt.
allowed, 12 or more

**COMPLETELY
ANODIZED**

**ADD UP ALL THESE
QUALITY FEATURES:**

- Both doors slide, to right or left.
- Ball bearing nylon rollers, and these rollers are: ADJUSTABLE ball bearing rollers on both panels.
- ANODIZED! Yes, every piece of the 6063 ST-6 aluminum is anodized!
- The only "quality-priced" sliding glass door that has SNAP-ON GLAZING BEAD.
- Full width jambs.
- Weather-proofed with SCHLEGEL weather-strip mohair. A COMPLETE seal!
- Color coded for ease in assembly.
- Available in multiples of 3 ft. (6-9-12-15, etc.); 4 ft. (8-12-16-20, etc.); or 5 ft. (10-15-20, etc.).
- Overall opening height: 6' x 9".
- For single glazing only (3/16", 7/32", 1/4").
- Specially designed handles.
- Fool-proof cadmium plated adjustable latch. Cylinder locks available at extra cost.
- Bottom roller anodized aluminum framed screens optional at extra cost.

DISTRIBUTORSHIPS AVAILABLE

Sunlight

3040 W. Lawrence Avenue, Chicago 25, Ill.
Please send all "Sunlight" details and prices.

Name _____
Company _____
Address _____
City _____ State _____
I am a Dealer Bldr. Dist. Other

How to build a better fireplace

Majestic's Fireplace Book includes just about everything you need to know on the subject. You'll find information on planning, materials and construction of fireplaces and barbecues. There are charts which tell the proper proportioning of chimney heights, fireplace dimensions, throat openings and sizes of dampers and smoke domes.

One plan shows how to put in a twin fireplace, one on the floor above the other, with venting by two flues comprising a double chimney.

Over 200 illustrations show you the company's accessories and how to use them all in constructing barbecues and fireplaces in family rooms, kitchens and

patios, and there is a variety of fireplace designs to choose from. \$1.

The Majestic Co., Inc., Huntington, Ind.
For a copy, write to Majestic.

Swatch book of color-flecked paints

A new architectural color card and brochure shows the 1958 Plextone paints—color-flecked, solid colored and textured.

You'll find 20 multicolored spray chips plus 10 new solid colored finishes which have been added to the line. In addition architects and decorators get complete information about multicolored paints and how to use them.

Plextone Corp., Newark, N.J.

For copy, check No. 37 on coupon below

Want more information?

The numbers below are keyed to the items described on the New Products and Publications pages. Circle the ones that interest you and mail the coupon to:

House & Home

Room 1021A, 9 Rockefeller Plaza, New York 20, N. Y.

NEW PRODUCTS

1. US Gypsum drywall adhesives
2. Diamond Lumber plywood panels
3. Forest Fiber exterior hardboard
4. Simpson basketweave hardboard
5. Marsh Wall pegboard
6. Nutone vent hood and intercom
7. Aetna vanity
8. Raygold vanity
9. Reznor space heater
10. Berko space heater
11. Thermador heater
12. Markel radiant baseboard
13. Frigidaire oven
14. GE oven
15. Tappan oven
16. Lennox humidifier
17. Barnebey-Cheney air cleaner
18. Condensation Engineering fireplace
19. Douglass fireplace
20. R&M-Hunter exhaust hood

21. Milwaukee Stamping bath enclosure
22. Consolidated General folding door
23. James B. Sipe Luma-Tint
24. Water Seal plastic seal
25. American Sisalkraft flashing
26. Rolscreen muntins
27. Glo-Brite pipe insulation

PUBLICATIONS

28. Koppers laminated timbers book
29. Barber-Colman garage door catalog
30. GE heating cable specification
31. Redbrik masonry panel booklet
32. E. Van Noorden skylight catalog
33. L. Sonneborn estimating guide
34. Sylvania lighting fixtures catalog
35. W. D. Allen fire protection book
36. J. M. Hirai shoji screen planning book
37. Plextone swatch book

NAME _____
OCCUPATION _____ TITLE _____
FIRM _____
STREET _____
CITY _____ STATE _____

IMPORTANT:

House & Home's servicing of this coupon expires July 1958

In addressing direct inquiries, please mention

House & Home

and the issue in which you saw the product or publication.

I wish to enter a subscription to House & Home for 1 year, \$6 2 years, \$8
US and possessions and Canada only
 New Renewal _____
Signature _____

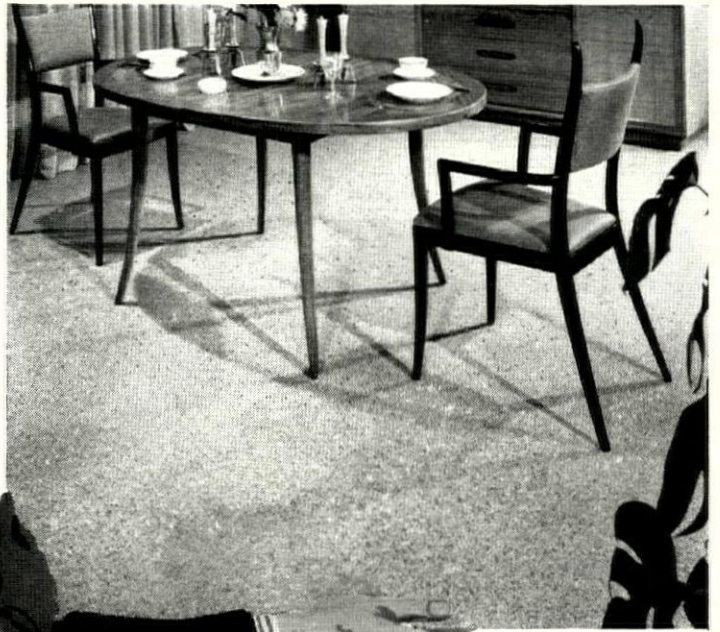

Furnishings by
Harvey Probbler

You
sell the
woman
and
she'll
sell the
husband

MATICO'S BRIGHT COLORS HELP YOU SELL THE MISSUS!

The quickest way to a man's check book is through his wife. That's why it's so important to build "wife-appeal" into your new homes. Nothing moves a gal to say "yes" faster than a colorful, gleaming Matico Tile Floor. She sees a sparkling background for her furnishings . . . a look of envy in the eyes of her sister-in-law. She'll like hearing how easy it is to keep Matico bright, how the smart colors last the long life of the tile. (You needn't tell her how Matico saves *you* time and money on installation.) Remember, for your next project, add extra "wife-appeal" with MATICO.

MASTIC TILE CORPORATION OF AMERICA

Houston, Tex. • Joliet, Ill.
Long Beach, Calif. • Newburgh, N. Y.

Vinyl Tile • Rubber Tile • Asphalt Tile
Vinyl-Plastic Tile • Plastic Wall Tile



BD499

MASTIC TILE CORP. OF AMERICA
Box 128, Dept. 14-4
Vails Gate, New York

Please send me complete information on Matico
Tile Flooring.

Name.....

Address.....

City.....Zone.....State.....

For best results we recommend Milmark® wax...cleaner...adhesives

New! A "PIT BARBECUE" IN THE KITCHEN, DEN, PLAYROOM OR PATIO WALL

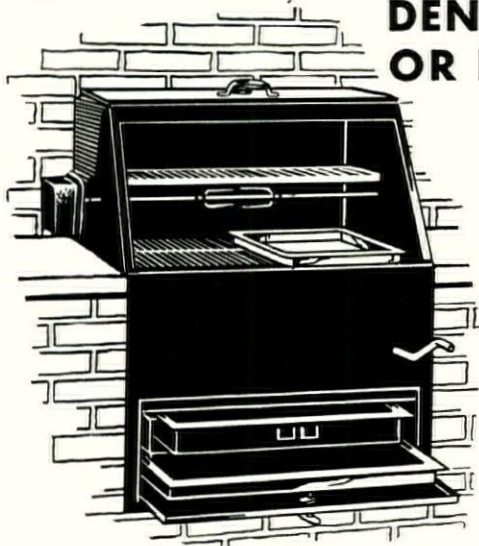

Ties in to chimney, or vents thru roof. Use standard exhaust hood. Now cook complete meals with charcoal the year 'round . . . right in the house. Broil—Roast—Bake—Smoke or Fry on

- ★ Featuring: enclosed oven with folding stainless steel door.
 - ★ Two cooking grills (932 sq. in.)
 - ★ Crank-lift, removable firebox.
 - ★ Ashdrawer. Hood thermometer.
 - ★ Dual-draft controls.
- Other models from \$99.95.
Depth 21" Length 30"

the new
HASTY-BAKE[®]

Fiesta #268
\$189.95

(Rotisserie \$19.95 extra)

Plans and specifications furnished free!

WRITE
HASTY-BAKE[®]
FOR DETAILS

Box 7367, Dept. HHJ Tulsa, Oklahoma
Dealers & Distributors inquiries invited.



WALLPAPER SELLS HOMES

because . . . no other wall decoration is so effective in making small rooms bigger, ceilings higher, dividing room areas . . . creating architecture where there isn't any.

WALLPAPER COUNCIL
509 MADISON AVE., NEW YORK 22, N. Y.

for EXTRA LIGHT, EXTRA BRIGHT BATHROOMS & SALES

STANDARD STEEL'S NEW TWIN MOR-LITE

BATHROOM CABINET

AT SURPRISING LOW COST

- featuring:
- 3-WAY 50 WATT LIGHTING
 - SLIDING PLATE GLASS MIRRORS
 - ADJUSTABLE GLASS SHELVES

SHOW your home buying prospects this deluxe bathroom cabinet combining beauty, efficiency and glamour. Demonstrate the exclusive, new 3-WAY shadowless lighting. Point with pride at the modern design, the 2, heavy-plate glass sliding mirrors, and stainless steel "picture" frame . . . give yourself this big EXTRA at real low cost.

Here's a Plus for Any Price HOME!



NEW DECORLITE GLASS DOOR TUB ENCLOSURE

What glamour, what a selling feature . . . a beautiful semi-obscure, hi-strength glass tub enclosure in fourteen sand carved designs. 100% rustproof, polished chrome-like finish. For standard, built-in or recessed tubs. 4½, 5 and 5½ tub sizes.

CALL, WIRE, WRITE, FOR CATALOGS, PRICES NOW . . .
See our Complete Line of Bathroom Accessories, Shower Stalls, Cabinets, Doors, plus many builder products.

STANDARD STEEL CABINET CO.

3701 MILWAUKEE AVE. • CHICAGO 41, ILLINOIS



- 16" Long
- Two thicknesses: 8" and 4"
- Modular Dimensioned
- Straight or Plain Face
- Large Voids
- Range of 14 Colors

Outstanding Masonry for Price-Conscious Builders

Styled in line with today's architectural trends, Cavitex has the beauty of proper symmetry along with ingrained color in a wide range. Cold-formed, its clean, sharp lines are never distorted by burning. With an 8-inch thickness for exterior walls, and a 4-inch for partition, veneer, or cavity walls, Cavitex is suited to all types of construction. Initial low cost and ease of laying combine to bring the all-masonry home to price levels that induce greater sales. Low price of Cavitex is directly due to the economies of local manufacturing. Write for literature and name of nearest local plant.



This national average price buys all the Cavitex needed for all the walls shown, even to planters, of the 3-bedroom, 50'x26' "Cavalier." (Blueprints available.) Price — which may vary by locality — typifies Cavitex economy.

W. E. DUNN MFG. CO.
424 W. 24th Street, Holland, Mich.

You Can Be a Manufacturer

More local plants are required to supply the rapidly growing demand. As a manufacturing opportunity, Cavitex can be highly profitable, either as an independent operation or as a supplementary activity—especially in project development. Each plant operates in franchise-protected territory, with Cavitex equipment available on 5-year-payment plan. Write for copy of "Opportunity, Unlimited."

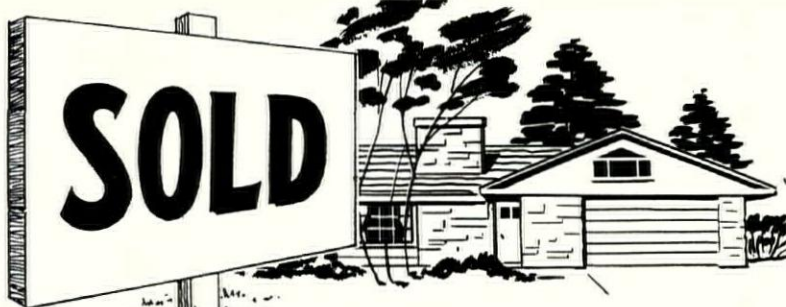

with **TEMCO** Central Gas Heating!

Engineered for greater building freedom!

Now, you can enjoy greater planning and building freedom than you ever before thought possible! Temco's full line of quality-built Forced-Air heating systems assures you a complete range of models and sizes to fit all homes, in all locations. And, you get Temco's important sales feature . . . the exclusive Ceramiclad* heat exchanger!

Pick the model that fits your blueprint!

TEMCO HI-BOY SERIES

If you're building without a basement . . . Temco's Hi-Boy installs easily in a closet, alcove or utility room. Out of sight . . . out of mind—completely silent in operation!

TEMCO LO-BOY SERIES

For basement installation . . . here's the most compact unit on the market using a round heat exchanger! Just the touch of a thermostat for clean, low-cost gas heat!

TEMCO COUNTER-FLOW SERIES

For single-floor plans . . . you have ideal perimeter heating for slab construction homes, or for homes with crawl space area!

TEMCO HORIZONTAL FORCED-AIR FURNACE

For attic, utility room or under-floor installation! Factory-assembled, wired—ready to hook up!

TEMCO PERIM-AIR-PAC

For basement, crawl space or attic! New, low-priced, factory-complete kit, including furnace ducts and accessories! Installs in only one day!

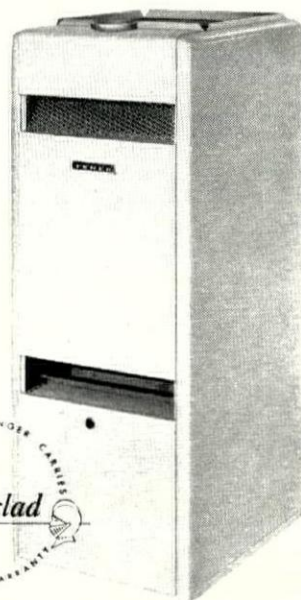

Point out these features that "pin-point" your sale!

- * Cabinets finished in handsome tan, wrinkle-baked enamel
- * Quiet blower, "File-Drawer" type assembly for easy maintenance
- * Fiberglass Dust-Stop filters to keep air fresh and clean
- * Built-in Draft diverter to control chimney down draft
- * Ceramiclad heat exchangers with 20-year warranty

Temco heat exchangers are finished in exclusive Ceramiclad, the porcelain enamel finish similar to that used for jet aircraft combustion chambers. Ceramiclad withstands far greater temperatures than any furnace will ever reach—and is impervious to condensation. A good point to remember when you tell a prospect that... There's also a Temco air conditioning unit to use in combination with every Temco furnace!

Give the home you build more sales appeal by specifying Temco equipment!

Write today for complete information:

* Trade Mark Registration Pending

TEMCO, inc.

NASHVILLE 9, TENNESSEE

"Gas Heating Specialists for the Nation"



"THE COMPLETE LINE OF GAS HEATING EQUIPMENT"

ROOM HEATERS • FLOOR FURNACES • WALL HEATERS • UNIT HEATERS
WARM AIR FURNACES • AIR CONDITIONING • GAS WATER HEATERS



Kegley, Westphall & Arbogast, Los Angeles, California

**A GRACEFUL
ENTRANCE
OPENS THE
DOOR TO SALES**

Home buyers appreciate the first impression they receive from a doorway made distinctive with figured glass. Note how this simple use of Mississippi Broadlite adds a touch of luxury that sells on sight. Greet your prospects with glamor and gain sales. Use translucent, light diffusing glass by Mississippi to add eye appeal that pays off in greater buy appeal.

Glass does so much to any home to make it more attractive . . . floods interiors with flattering "borrowed light" . . . makes rooms seem larger, friendlier, more desirable.

Give your homes the extra sales appeal that only glass can add. Buyers want that "different look." See your nearby Mississippi Glass distributor and select from a wide range of patterns and surface finishes that can enhance your homes.



WRITE TODAY FOR FREE CATALOG.
ADDRESS DEPARTMENT 9.



**MISSISSIPPI
GLASS COMPANY**
88 Angelica St. • St. Louis 7, Missouri
NEW YORK • CHICAGO • FULLERTON, CALIFORNIA

ADVERTISERS INDEX:

This advertisers index published by HOUSE & HOME is an editorial service to its readers. HOUSE & HOME does not assume responsibility to advertisers for errors or omissions in preparation of these listings.

Page:		Page:	
164	Airtemp Division (<i>Chrysler Corp.</i>)	36	Kentile, Inc.
14	Alliance Ware, Inc.	180	Kewance Mfg. Co.
204	Allied Chemical & Dye Corp. (<i>The Barrett Div.</i>)	2, 3	Keystone Steel & Wire Company
20, 21	Aluminum Company of America		
22	American Air Filter Co., Inc. (<i>Electro-Klean Dept.</i>)	66, 67	Lennox Industries Inc.
86, 87	American Gas Association	200	Leviton Manufacturing Co.
Cover III	American Hardware Corp., The (<i>Russell & Erwin Div.</i>)	70	LOF Glass Fibers Co.
94	American Houses, Inc.	58, 59	Libbey-Owens-Ford Glass Company
44	American Motor Corp. (<i>Kelvinator Div.</i>)	215	Lightolier, Inc.
212, 213	American-Standard Corp. (<i>Plumbing & Heating Div.</i>)	64	Line Material Industries (<i>Division of McGraw Edison Co.</i>)
194	American-Standard Corp. (<i>Youngstown Kitchens Div.</i>)		
208	American Telephone & Telegraph Co.	214	Majestic Co., Inc., The
182, 185	Andersen Corp.	88	Manitowac Equipment Works
42, 43	Armstrong Cork Co.	220	Markel Electric Products, Inc.
		10	Martin-Senour Co., The
204	Barrett Division, The (<i>Allied Chemical & Dye Corp.</i>)	211	Masonite Corp.
197	Bell & Gossett Co.	223	Mastic Tile Corp. of America
69	Bestwall-Certain-Teed Sales Corp.	210	Maze Co., W. H.
173	Binswanger & Co.	64	McGraw Edison Co. (<i>Line Material Industries</i>)
38, 39	Bird & Son, Inc.	196	Meadows, Inc., W. R.
209	Blue Ridge Glass Corp.	78, 79	Minnesota & Ontario Paper Co. (<i>Insulite Division</i>)
31	Bruce Co., E. L.	225	Mississippi Glass Co.
18	Bryant Manufacturing Co.	227	Moe Light Division (<i>Thomas Industries, Inc.</i>)
164B	Bulldog Electric Products Co.	4, 5	Murray Corp. of America, Inc. (<i>Easy Washing Machine Div.</i>)
216	Burr-Southern Corp. of California		
24	California Redwood Assn.	8	National Clay Pipe Manufacturers, Inc.
28, 29	Capitol Products Corp.	155, 157	National Gypsum Co., The
9	Carolina Mirror Company	Cover IV	National Homes Corp.
50, 51	Carrier Corp.	23	National Lock Co.
203	Case Co., J. I.	166	New Castle Products, Inc.
46, 47	Ceco Steel Products Corp.	1	Nutone, Inc.
164	Chrysler Corp. (<i>Airtemp Div.</i>)		
15	Cloud Oak Flooring Co.	220	Onan & Sons, Inc., D. W.
202	Columbia Mills, Inc.	6, 7	Overhead Door Corp.
74	Crane Co.		
		95	Red Cedar Shingle Bureau
179	De Vac, Inc.	160	Reflectal Corp.
164A	Dow Chemical Co., The	62, 63, 71	Republic Steel Corp.
82, 83	Douglas Fir Plywood Assn.	219	Republic Steel Kitchens
224	Dunn Manufacturing Co., W. E.	210	Revco, Inc.
170	DuPont de Nemours & Co., Inc., E. I.	206, 207	Reynolds Metals Co.
		216	Rheem Manufacturing Company
4, 5	Easy Washing Machine Div. (<i>Murray Corp. of America, Inc.</i>)	217	Rilco Laminated Products, Inc.
		159, 161, 163	Rolscreen Co.
187	Farley & Loetscher Manufacturing Co.	207	Romar Filter Corp.
192	Fiat Metal Manufacturing Co.	25	R. O. W. Sales Co.
73	Fleet of America, Inc.	Cover III	Russell & Erwin (<i>Div. of the American Hardware Corp.</i>)
162	Flint Kote Co., The	17	Russell Co., The F. C.
201	Follansbee Steel Corp.		
54, 55	Ford Motor Co.	195	Sargent & Co.
12, 13	Frigidaire Division (<i>General Motors Corp.</i>)	167	Schlage Lock Co.
		165	Simpson Logging Co.
177	General Bronze Corp.	164C	Simpson Redwood Co.
176, 205	General Electric Co.	218	Southern Screw Company
68A-D	General Electric Co. (<i>Hotpoint Div.</i>)	224	Standard Steel Cabinet Co.
100	General Electric Co. (<i>Laminated Products Dept.</i>)	11	Structural Clay Products Institute
12, 13	General Motors Corp. (<i>Frigidaire Div.</i>)	99	Stylecraft Homes, Inc.
180	General Tire & Rubber Co., The (<i>Pennsylvania Div.</i>)	222	Sunlight Co.
19, 175	Georgia-Pacific Corp.		
92	Gerber Plumbing Fixtures Corp.	225	Temco, Inc.
84	Glamour Glass Wall Dor Corp.	93	Thermador Electrical Manufacturing Co. (<i>Div. of Norris Thermador Corp.</i>)
Cover II	Gold Seal Division (<i>Congoleum-Nairn, Inc.</i>)	228	Thomas Industries, Inc. (<i>Moe Light Division</i>)
154	Goodrich Co., B. F.	214	Timber Engineering Co.
98	Hager, C., & Sons Hinge Mfg. Co.	193	Unique Balance Co., Inc.
75	Harnischfeger Homes, Inc.	48	Universal-Rundle Corp.
224	Hasty-Bake Mfg. Co., Inc.		
77	Home Comfort Mfg. Co.	30	Van-Packer Co.
68A-D	Hotpoint Co. (<i>Division of General Electric Co.</i>)	171	Virden Co., John C.
198, 199	HOUSE BEAUTIFUL Magazine		
217	HOUSE & HOME		
		220	W. M. Products Co.
26	Inland Homes Corp.	216, 220, 224	Wallpaper Council
97	Insular Lumber Sales Corp.	227	Western Pine Assn.
78, 79	Insulite Division (<i>Minnesota & Ontario Paper Co.</i>)	90, 91	Westinghouse Electric Corp.
32	International Harvester Co.	221	Weyerhaeuser Sales Co.
		34, 35	Whirlpool Corp.
56	Jacuzzi Bros., Inc.	27	Wire Reinforcement Institute
188, 189	Johns-Manville Corp.	16	Woodall Industries, Inc.
173	K-Lath Corp.	96	Yeoman Brothers Company
44	Kelvinator Division (<i>American Motor Corp.</i>)	33	York Corp.
		194	Youngstown Kitchens (<i>Div. of American Standard Corp.</i>)



Notice how the wide lighting trough breaks up the expansive wall and adds a feeling of intimacy to the tables below.

Lodgepole Pine's workability is illustrated in the dimpled beams emphasized by indirect lighting.

"We achieved a distinctive atmosphere with Lodgepole Pine,"

says Mr. Robert E. Harrington, proprietor of Nendel's famous restaurant in Portland, Oregon

"People come back to a restaurant that has good food *and* a warm, distinctive atmosphere," says Mr. Harrington. "That's why the designer and I specified Lodgepole Pine for this new dining area." The indirect lighting, graceful fireplace and soft-textured woods create a relaxing room. The unusual dimpled effect on the beams was achieved with a ball peen hammer.

Lodgepole Pine's workability makes it ideal for special effects. It can be used for detailed mouldings, or as paneling for large surface areas. It is readily workable by hand or machine tools. Lodgepole Pine takes paint or stain with ease, or it can be waxed to show its straight grain and knotty pattern.

You will find Lodgepole Pine a practical, economical wood. Light in weight, it is easily handled and installed. It is dimensionally stable due to its low shrinkage and swelling. Sealing is unnecessary because the knots do not

have a tendency to bleed resin. Lodgepole Pine resists splitting by nailing or other construction operations. It is available in sizes and patterns to fit most building needs.

For more information on Lodgepole Pine and other economical, all-purpose woods from the Western Pine Association Mills, write: WESTERN PINE ASSOCIATION, Dept. 302-V, Yeon Bldg., Portland 4, Oregon.



Western Pine Association

member mills manufacture these woods to high standards of seasoning, grading and measurement

**Idaho White Pine · Ponderosa Pine · Sugar Pine
White Fir · Incense Cedar · Douglas Fir · Larch
Red Cedar · Lodgepole Pine · Engelmann Spruce**

Today's Western Pine Tree Farming Guarantees Lumber Tomorrow

"Naked" Homes Are Hard to Sell!

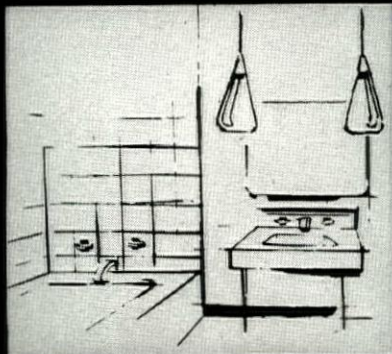

Now "Dress" Every Room
with "Inspiration-Lighting"
for Faster, Easier
Sales!

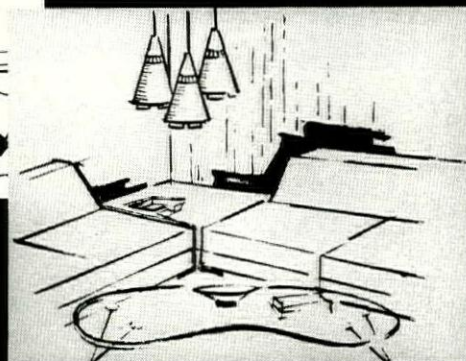

Inspiration-Lighting
by **MOE** *Light*®

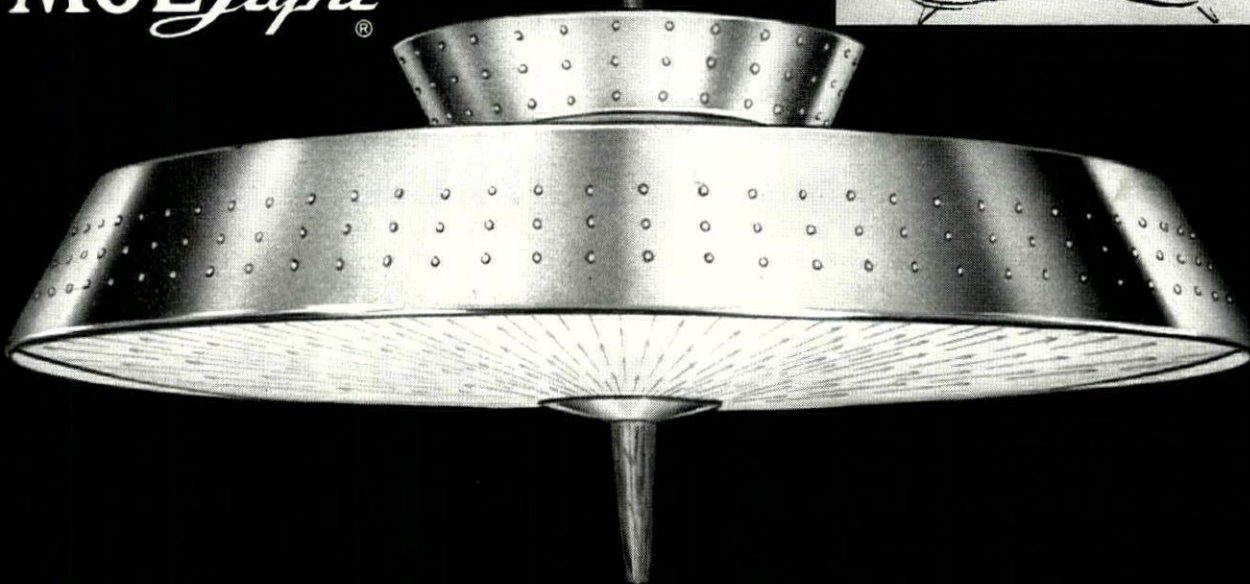

Cold, "naked" rooms leave prospects cold...bare of buying impulse. Dress up your homes... warm up your prospects' buying impulse with Moe Light *Inspiration-Lighting*... and see how much EASIER your homes sell. FASTER, too. You *double* your productive sales-opportunities because evening selling becomes as effective as week-end selling.

The room-scenes shown above are taken from actual homes built by a highly successful Florida operator who made *Inspiration-Lighting* one of his most effective selling tools. Mail coupon NOW for the whole "success story"!

THOMAS INDUSTRIES INC.
LIGHTING FIXTURE DIVISION
Executive Offices: 410 S. Third St., Louisville 2, Ky.
Leaders in Creative Lighting

Send for **FREE** "idea book"

THOMAS INDUSTRIES INC.
Lighting Fixture Division
410 S. Third St., Louisville 2, Ky., Dept. HH-4



Send me, FREE, your *Inspiration-Lighting* catalog in full colors, showing how to light homes for faster, easier sales.

Name _____

Company _____

Address _____

City _____ Zone _____ State _____