

AMERICA'S BIGGEST INDUSTRY MONTHLY FOR AMERICA'S BIGGEST INDUSTRY

MARCH 1959 SIX DOLLARS A YEAR — ONE DOLLAR A COPY

# House & Home



**75,000 vacation houses:  
a new and growing market**

IN EXHAUST FANS..

*It's NuTone for Power*

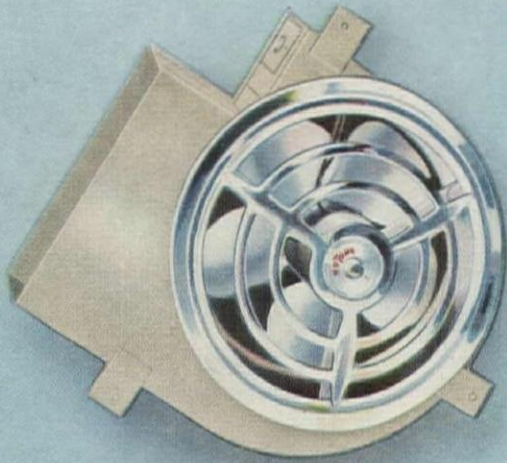

NUTONE MODEL 851-N  
One of Eight Types for Ceiling

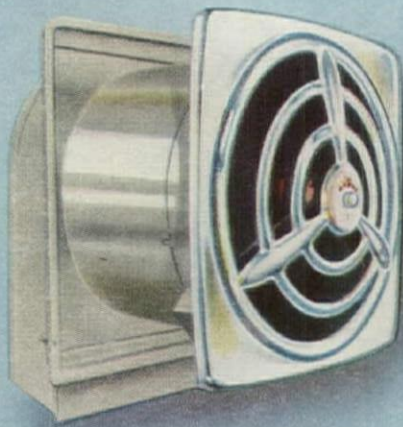

NUTONE MODEL 817  
One of Four Types for Wall



*For Fresh  
Clean Air*

Every home needs good ventilation in the kitchen to keep air fresh and to prevent greasy film from settling on walls and furnishings.

NuTone EXHAUST FANS pull out odors, grease, moisture and excess cooking heat before they circulate into other rooms of the house.

You can choose the exact type best suited for you, but no matter which NuTone Exhaust Fan you select..you can be sure you have the most modern, most efficient kitchen ventilation of all.

NUTONE OFFERS YOU AMERICA'S MOST COMPLETE LINE OF EXHAUST FANS FOR THE KITCHEN.



8 inch Wall



10 inch Wall



8 inch Ceiling



10 inch Ceiling



Vertical Discharge



BLOWER TYPES



IN RANGE HOODS..

*It's NuTone for Beauty*

8 LUXURIOUS FINISHES AND SOLID METALS .. SO RICH..SO DURABLE..SO EASY TO CARE FOR.

SATIN ANODIZED ALUMINUM

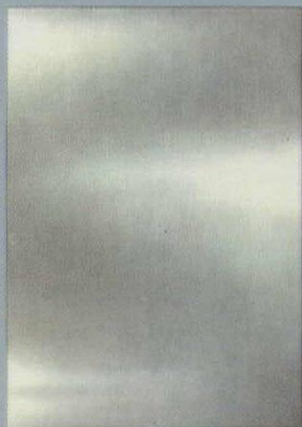

RIBBED COPPER ANODIZED



BAKED WHITE ENAMEL

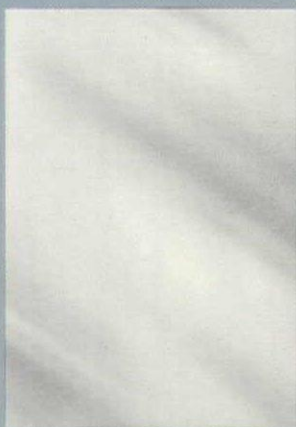

COPPER ANODIZED ALUMINUM



ANTIQUE COPPER ENAMEL

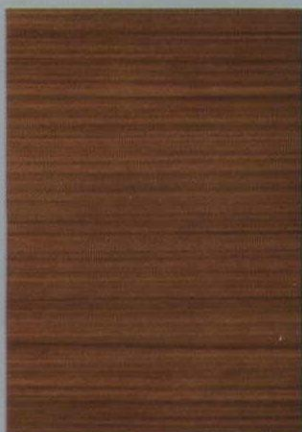

STAINLESS STEEL



COPPER ENAMEL

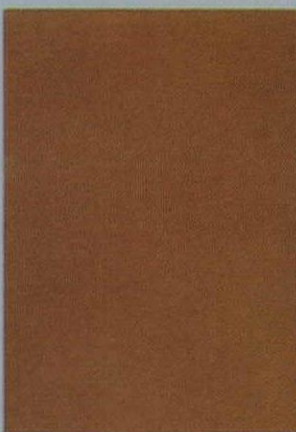

BRUSHED CHROME  
For Oven Hood



SEE NEXT PAGE →

*For Color  
in Kitchens*

There's no limit to the COLOR you can add to your kitchens with the many different finishes of NuTone Hood-Fans. Not just 2 or 3...but 8 new, mirror-smooth finishes to blend with any color scheme of wood or steel cabinets.

Why not put this sales feature in your homes? Leading Builders agree.. "The Kitchen sells the Home..and NuTone Hood-Fans sell the Kitchen!"

NUTONE OFFERS YOU AMERICA'S MOST COMPLETE LINE OF HOOD-FANS.

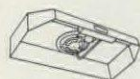

1100 SERIES



1200 SERIES



1500 SERIES



1600 SERIES

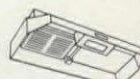

1700 SERIES



# "Cheerful Earful" & "Delightful Sightful"

...that put prospects in a buying mood

Make your homes more inviting with this friendly "hello" at your doorways. NuTone Door Chimes are beautiful to hear . . . attractive to see . . . add elegant charm to your hallways . . . living rooms . . . or kitchens. Brilliantly designed in Contemporary and Traditional models to suit any interior. 23 handsome styles ranging from low cost two-note chimes . . . to exquisite eight-note Westminster-chord masterpieces. Built-In or Surface-Mounted Models. Also . . . 15 smart Pushbuttons . . . and Transformers.

SEND FOR FREE DELUXE CATALOGS IN BINDER.

Write NuTone, Inc., Dept. HH-3, Cincinnati 27, Ohio

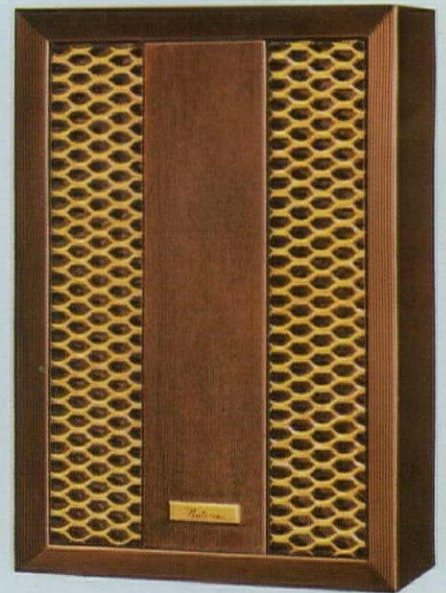

L-39 NEW 4 OR 8-NOTE DOOR CHIME

Custom styled cabinet with rich textured gold anodized grille and wood grain plastic cover. \$25.95 list

U.S. & Foreign Patents Pending

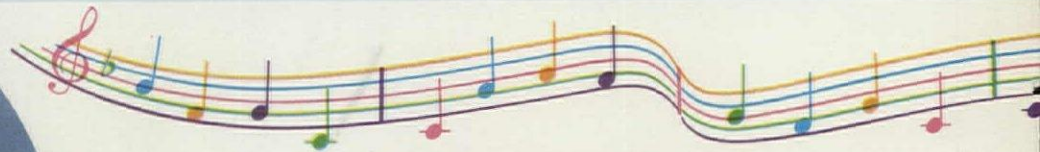

# NuTone

## DOOR CHIMES

ADD EYE LEVEL BEAUTY TO  
YOUR HOMES AT MODEST COST

Here Are Other NuTone Chimes for 2 or 3 Doors

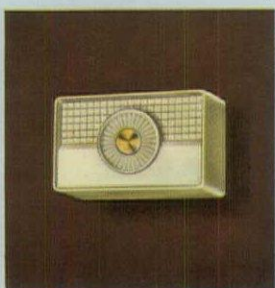

L-12 2 Notes \$4.95 list

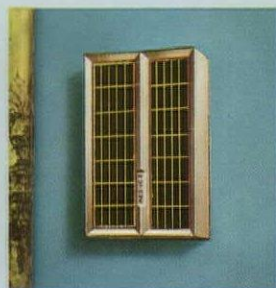

L-17 2 Notes \$6.95 list



L-20 2 Notes \$10.95 list

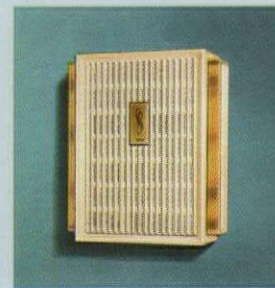

L-21 Repeating \$9.95 list

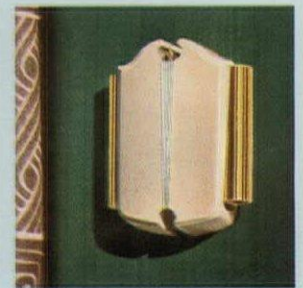

L-22 2 Notes \$9.95 list

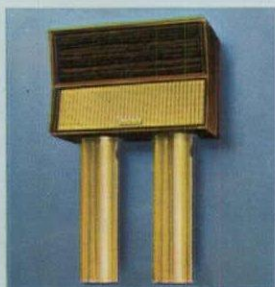

L-23 2 Notes \$8.95 list

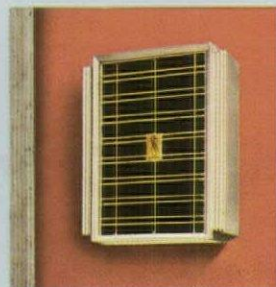

L-30 Chord Tone \$13.95 list

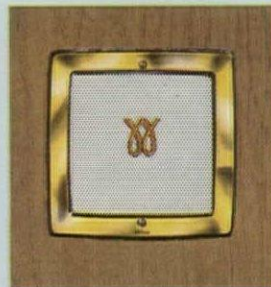

L-15 Built-In \$9.95 list

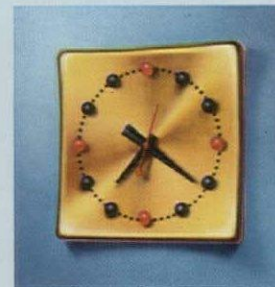

L-36 Clock & Chime \$22.50



L-60 Westminster \$69.95



## Wood-Mosaic Hardwood Block Floors



The Correlaire, one of four luxurious models being built by Centex, in beautiful Elk Grove Village.

### **Selected by Centex for Elk Grove Village**

Centex Construction Company of Dallas, one of the largest Home Builders in the United States, is using Wood-Mosaic Hardwood Floors in all the homes at Elk Grove Village, northwest of Chicago. To date, approximately 3/4 million square feet of Wood-Mosaic Block have been used in these homes. This is an excellent example of the universal appeal of Wood-Mosaic hardwood floors to the builder and the customer. Among the exclusive features offered by Wood-Mosaic Block is its "Diamond Lustre" finish (a vinyl-alkyd finish baked on at the factory) which will give Elk Grove Village residents four times greater wear than ordinary finishes and requires a minimum of maintenance to retain the original beauty of these attractive floors.

Be sure to investigate Wood-Mosaic Hardwood Floors for your future jobs, either commercial or residential.

Wood-Mosaic Floors are available in your area. Write us today for complete information, samples and nearest outlet.

### **"SUREFIT" MILLING**

- Faster laying. • Smooth surface.
- Precise fit.

### **"DIAMOND LUSTRE" Finish**

- A baked-on Vinyl-Alkyd. • Stain resistant.
- 4 times greater wear than ordinary finishes.
- Cuts maintenance to a minimum.

**Pay no more for the finest floor!**



## **Wood-Mosaic**

WOOD-MOSAIC CORPORATION, LOUISVILLE 9, KY.

WOOD-MOSAIC CORPORATION OF CANADA LTD.,  
WOODSTOCK, ONTARIO

*Maker of the World's Finest Hardwood Floors since 1883*

# PUT YOUR MONEY IN GRACIOUS LIVING...

*but don't "Gold-Plate" the drain!*



**Specify Republic Steel Pipe for maximum economy in waste line service**

Most people who purchase a new home look forward to years of tasteful living, surrounded by the marks of modern grace and comfort. Providing features that make this possible—without undue costs to the buyer—can be a real problem for builders. One way to solve this problem, while still maintaining high standards of quality, is to choose fully dependable, yet economical, building materials. Such a material is Republic Steel Pipe for waste lines.

Steel Pipe is low in initial cost—yet its price and availability remain relatively stable. Republic Steel Pipe also helps you achieve higher standards of workmanship. It is absolutely uniform, for sure

speedy installation. Further, since one grade of steel pipe meets all requirements, inventory problems are reduced, and there is no chance of installing the wrong grade. Reputable plumbers everywhere, with years of steel pipe experience, can economically install a steel pipe waste line system that will last the life of the building.

These and other steel pipe advantages bring substantial economies—economies that can be utilized to provide a more livable, more salable home. For complete details, contact your Republic Pipe Distributor, or write Republic Steel Corporation, Department HO-6913, 1441 Republic Building, Cleveland 1, Ohio.

## REPUBLIC STEEL



*World's Widest Range of Standard Steels and Steel Products*

# new

## kwikset

### entrance handle lockset

Now available—a lower cost, high quality entrance handle, ideally suited to new construction and the residential replacement market. Superbly styled to provide regal splendor for every entry way, these distinctive handle sets have the look and feel of strength and security. Expertly crafted from cast brass, bronze and aluminum, they are available with either Kwikset “400” Line Bel Air or Standard design interior knobs and may be keyed with any Kwikset entry model.

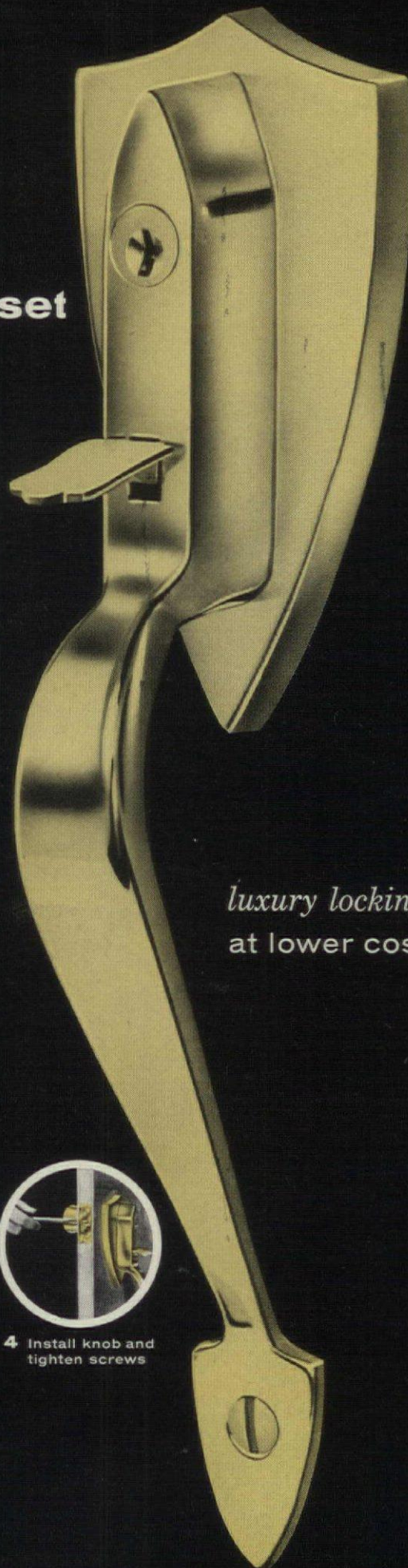

*luxury locking  
at lower cost*

#### exclusive installation advantages

Kwikset entrance handle sets are the *only* handle sets that can be installed with the same tools and in the identical trouble-free manner as all Kwikset “400” line locksets. Also available for use with 5” backset latch.

#### ONLY FOUR SIMPLE STEPS



1 Mark and bore holes

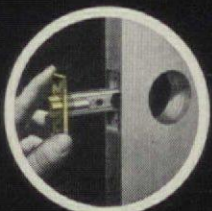

2 Install latch



3 Install exterior handle



4 Install knob and tighten screws

**kwikset**  **locksets**

*America's largest selling residential locksets*

**KWIKSET SALES AND SERVICE COMPANY**

A Subsidiary of The American Hardware Corporation, Anaheim, California



## THESE "Hydronic" HOMES SOLD FAST!



### THE B & G BOOSTER

Engineered for compactness, silent operation and years of dependable service, this electric circulating pump is the basic unit of the B & G Hydro-Flo System.

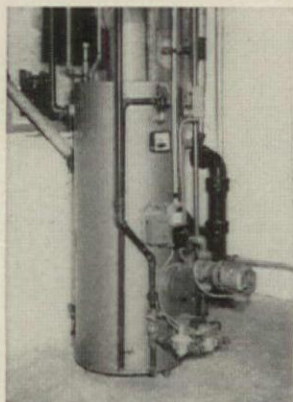

Typical space-saving B & G Hydro-Flo System heating plant. The boiler has a built-in water heater.

In this home development, 300 homes were sold over one weekend. Not the least of the factors which influenced such a rapid sale is the fact that these homes are equipped with "hydronic" baseboard forced hot water systems, using B & G *Hydro-Flo* equipment.

B & G *Hydro-Flo* Heating is the feature which lifts homes out of the rut...adds distinction and value far beyond the actual cost. No other type of system can offer so many possibilities for more comfortable, more convenient living.

The B & G *Hydro-Flo* System can be installed initially as a forced hot water system with all the benefits of controlled *radiant* warmth. It can be inexpensively zoned to permit the proper distribution of heat, particularly valuable in split-level homes.

Other *Hydro-Flo* features, such as summer cooling with chilled water and snow melting panels, can be included, either when building or any time thereafter.

For all the facts send for illustrated booklet—see why more and more builders are turning to *hydronic* heating with the B & G *Hydro-Flo* System.



\*Reg. U.S. Pat. Off.

# Hydro-Flo<sup>\*</sup> SYSTEM

## BELL & GOSSETT

COMPANY

Dept. FQ-10, Morton Grove, Illinois

Canadian Licensee: S. A. Armstrong Ltd.,  
1400 O'Connor Drive, Toronto 16, Ontario



BUILT-IN SALES CLINCHER

**Admiral built-ins sell homes!**

**Cost less...install easier!**

NEW CUSTOM-BEAUTY! NEW EFFICIENCY!

To the housewife, the kitchen is the heart of the home. That's why homes with Admiral Kitchens are easier to sell. Admiral built-ins are loaded with exclusive features that have instant appeal to women. What's more, these advantages are pre-sold nationwide by Admiral's continuing powerful national advertising.

By any measure, Admiral built-ins give your house a built-in sales clincher that can open and close the sale. They're easier to install...actually cost you less! It will pay you well to investigate Admiral built-ins now!



Giant non-fogging picture window lets you look into oven from across kitchen.



Rotary Roaster in oven bastes as it roasts as it turns—automatically!



Automatic Temperature Control Units make utensils like automatic skillets.



 MARK OF QUALITY THROUGHOUT THE WORLD

# Admiral®



Sold in 90 countries. Manufactured in the U.S.A., Australia, Argentina, Brazil, Canada, Italy, Mexico, Philippines, and Uruguay. Admiral Corp., Chicago 47, Ill., and Port Credit, Canada.

MAIL THIS COUPON TODAY

Admiral Corporation, Built-in Appliance Division, Dept. HH-39  
3800 Cortland St., Chicago 47, Illinois

Please send more details and the name of my nearest Admiral distributor.

Name \_\_\_\_\_

Address \_\_\_\_\_

City \_\_\_\_\_ Zone \_\_\_\_\_ State \_\_\_\_\_

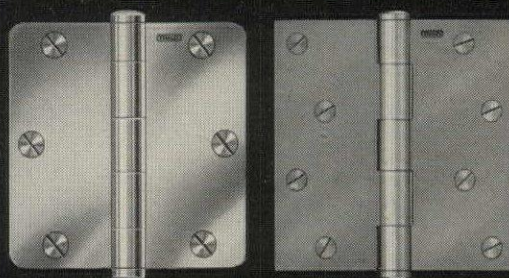
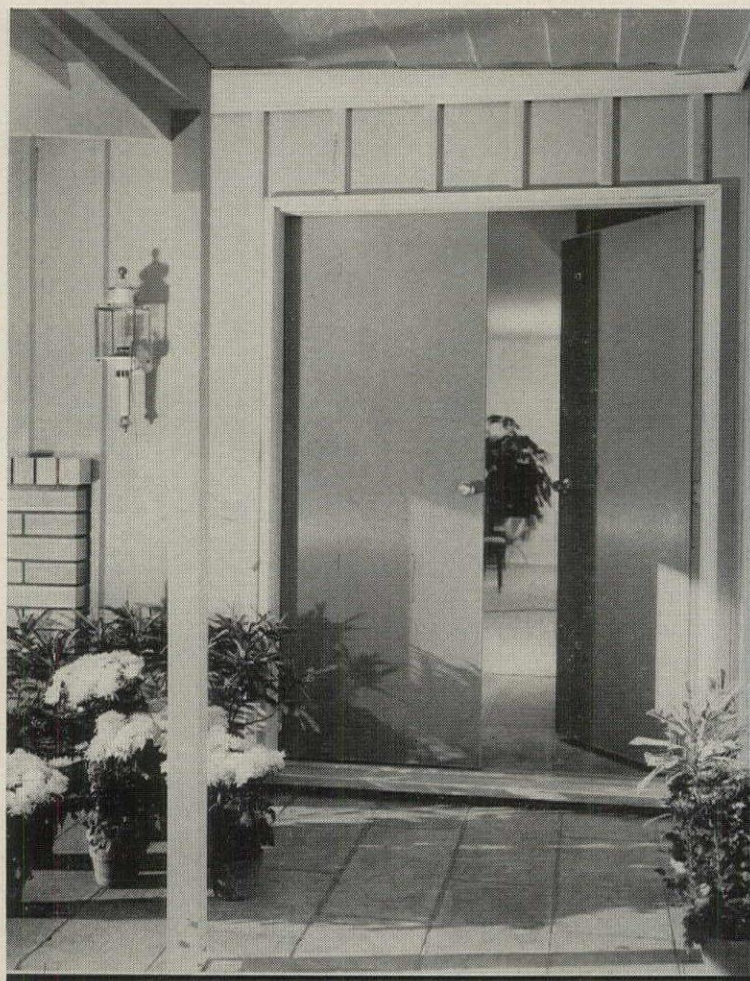

RD 241      241  
Standard of the World

Pin is  
guaranteed  
not to  
rise

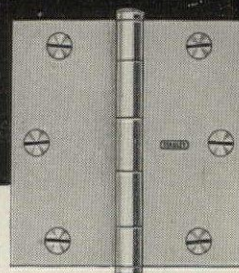
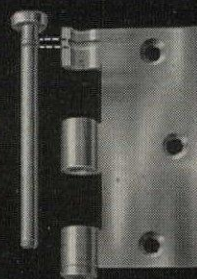

Leader in the  
Low-Priced Field.

## Starting here 741 **STANLEY HARDWARE** adds value to your homes

As long as the door pictured above is part of the house, it will swing trouble-free on famous Stanley 241 hinges—the hinge with the pin that is guaranteed not to rise. For removal, the pin must be tapped out through the patented hole in the bottom tip.

This is the first in a series of advertisements that will picture how, from front entranceway to breezeway, Stanley hinges, pocket door frames, cabinet hardware and hardware for sliding, bi-folding and bi-passing doors can add touches of *permanent quality* throughout the houses you build. Always look to Stanley for leadership.

Use Stanley Hardware in your homes and let prospective home buyers know you do. STANLEY is a name they know . . . a name they associate with QUALITY. Stanley Hardware, Division of The Stanley Works, Dept. C, 49 Lake Street, New Britain, Conn.

Deserving a place in your plans for progress

HARDWARE

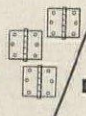

AUTOMATIC  
DOOR CONTROLS



ALUMINUM  
WINDOWS



AMERICA BUILDS BETTER AND LIVES BETTER WITH STANLEY

# STANLEY

This famous trademark distinguishes over 20,000 quality products of The Stanley Works—hand and electric tools • builders and industrial hardware • drapery hardware • door controls • aluminum windows • stampings • springs • coatings • strip steel • steel strapping—made in 24 plants in the United States, Canada, England and Germany.

A 9-page report to builders from  
Douglas Fir Plywood Association

# 20 ways to build more house for the money with FIR PLYWOOD



- 5 ways to cut costs with Exterior fir plywood siding
- 4 ways to build better for less with fir plywood sheathing
- 6 ways to cut on-site labor with fir plywood components
- 5 ways to add sales appeal with fir plywood built-ins



20 WAYS TO BUILD

MORE HOUSE

FOR THE MONEY



# FIR PLYWOOD SIDING:

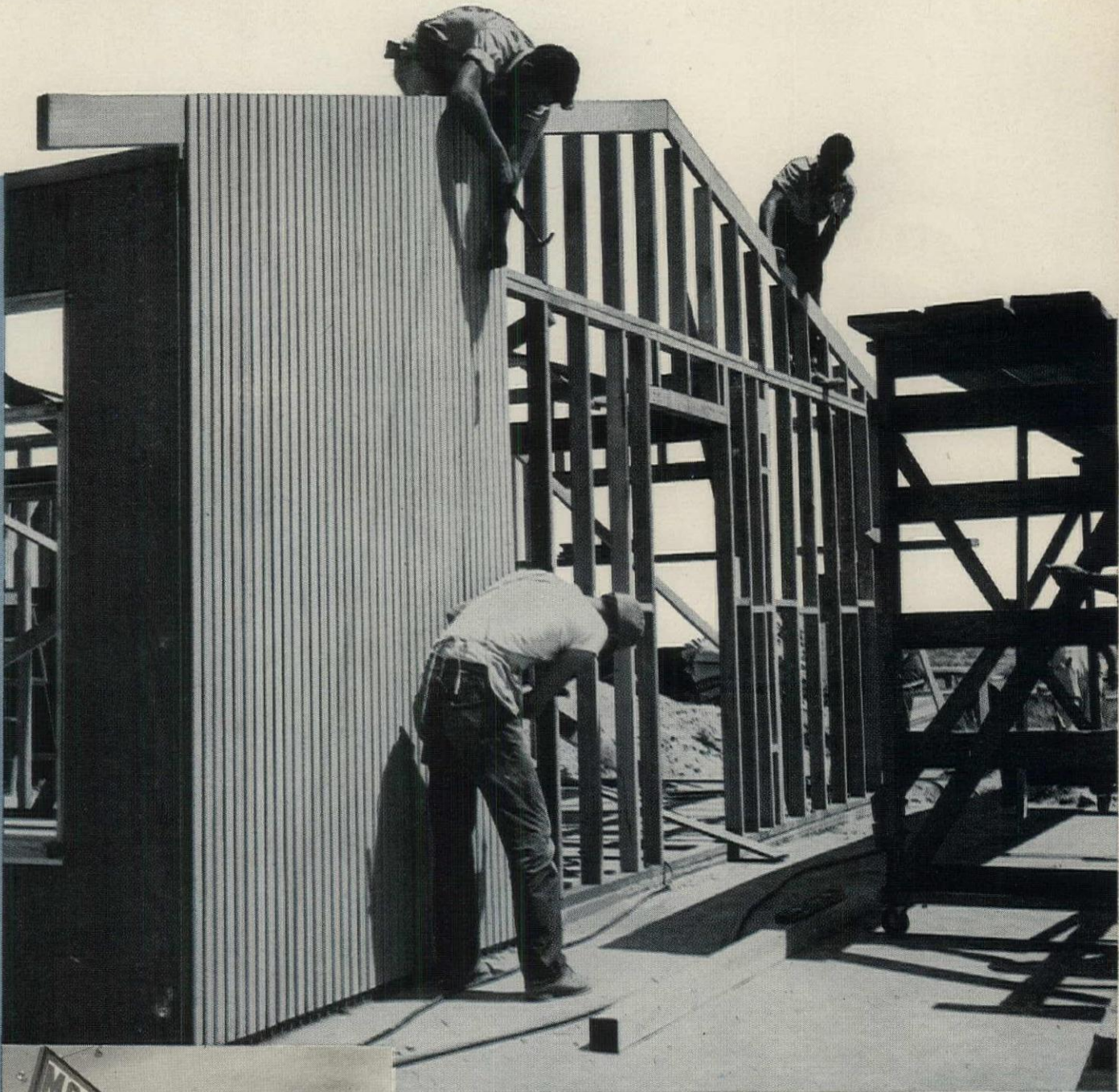
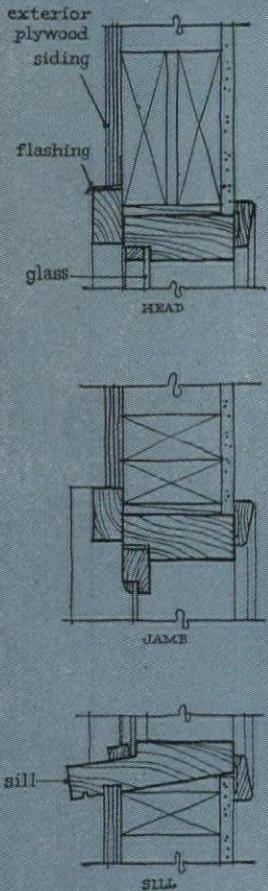

Richard Grant used Texture One-Eleven® combined siding-sheathing, saved 18 man hours on wall construction, plus materials.

Rowland Van Ness used Exterior fir plywood and batten siding to eliminate all sheathing, bracing and blocking.

1

## Save \$100 and more per house by applying Exterior fir plywood directly to studding

Why install both sheathing *and* siding when you can do the job in one operation with Exterior plywood. Plywood combined siding-sheathing has ample bracing strength and meets FHA requirements.

Savings in time and materials are substantial. Builder Rowland Van Ness, San Jose, for example, reported  $\frac{3}{8}$ " Exterior plywood siding-sheathing has saved more than \$150 per house.

Another builder, Richard Grant, developer of the 1,200 home Parkside tract in San Mateo, estimated savings of \$125 per house with Texture One-Eleven® combined siding-sheathing.

For more information about Exterior plywood siding-sheathing, write Douglas Fir Plywood Association, Tacoma 2, Washington.

# five ways it can help you cut costs



2

## Single wall construction for mild climates

A single thickness of  $\frac{3}{4}$ " Exterior plywood, serving simultaneously as siding, sheathing and interior paneling, helped Nu-Way Construction Co., South Pasadena, sell this add-a-room package for only \$5.50 per sq. ft. Construction is post and girder with plywood rabbeted into posts and sills. Standard unit is 15' x 20'.



BEFORE



AFTER

3

## "Japanese" panel siding speeds remodeling

A quick face lifting was accomplished on this OHI remodeling job by applying Exterior plywood directly over the old siding. To create oriental effect, 1 x 3 battens were used over vertical panel joints and above and below windows to provide louvered effect. The plywood panels are painted white, battens dark brown.

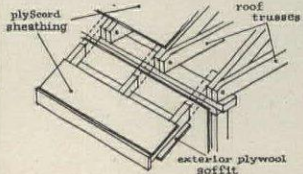
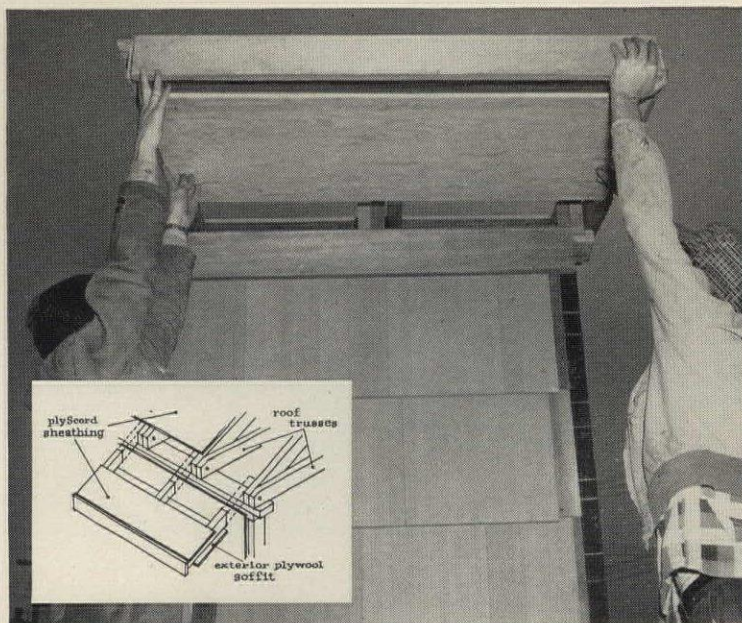

4

## Eave component reduced site labor 50%

This fir plywood eave overhang component was developed by A. C. Milne and John K. White of American Houses to speed and simplify construction. The unit is 8' long, combines outlookers, fascia, plywood sheathing and soffits. The unit slips into place; the outlookers are nailed to the upper chord of the roof truss.



5

## Prefab gable ends halve construction costs

Prefabricated Texture One-Eleven plywood gable ends developed by Brockbank Builders, Salt Lake City, Utah, helped speed construction by more than 50 per cent. The shop-built sections reduced on-site labor by eliminating piecemeal framing and fitting. T-1-11 requires only inexpensive shake stain finishes.

For your own protection, specify only DFPA trademarked plywood

(CONTINUED)

20 WAYS TO BUILD

MORE HOUSE

FOR THE MONEY



# FIR PLYWOOD COMPONENTS:

Fir plywood stressed-skin panels reduce on-site labor by as much as 80 per cent

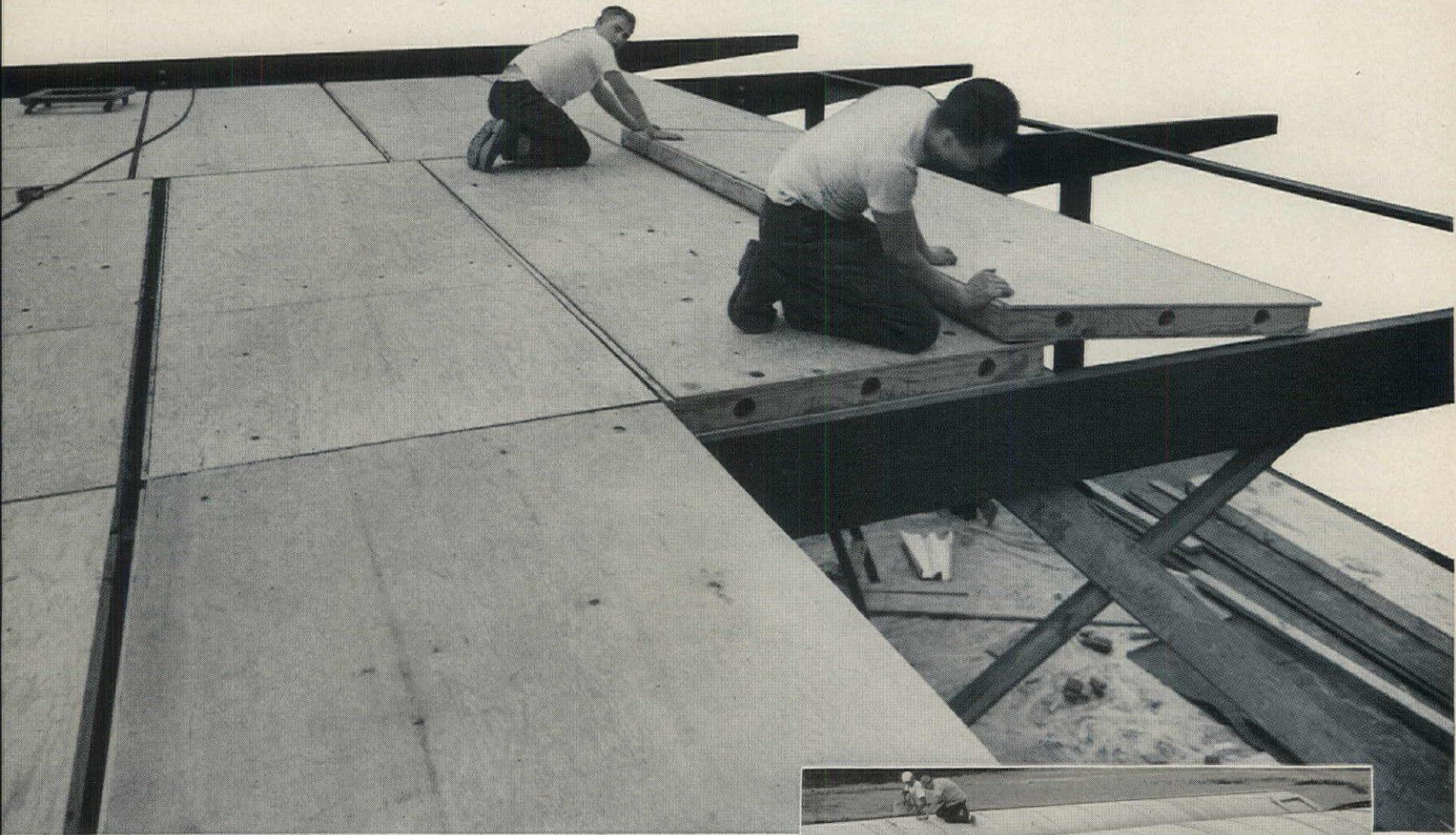

6

**Flat stressed-skin panels** helped hold construction costs to \$8.20 per square foot on this 2,200 gross-square-foot house built by John Odgers, Seattle.

The house is built on two levels with the 4' x 12' stressed-skin plywood components serving as a combined first story ceiling and second story subfloor, and a finish ceiling and roof decking on the upper level. In addition to simplifying construction and reducing site labor, the panels permit large clear floor areas, spanning 12 feet or more without supplementary support. Panels fabricated and installed by Panelbild System, Inc.; architect: Robert Hugus.

Drawing shows basic construction of roof panels; floor panels are similar except that 2x6s are used for framing and 3/4" and 1/4" fir plywood is used for top and bottom skins.

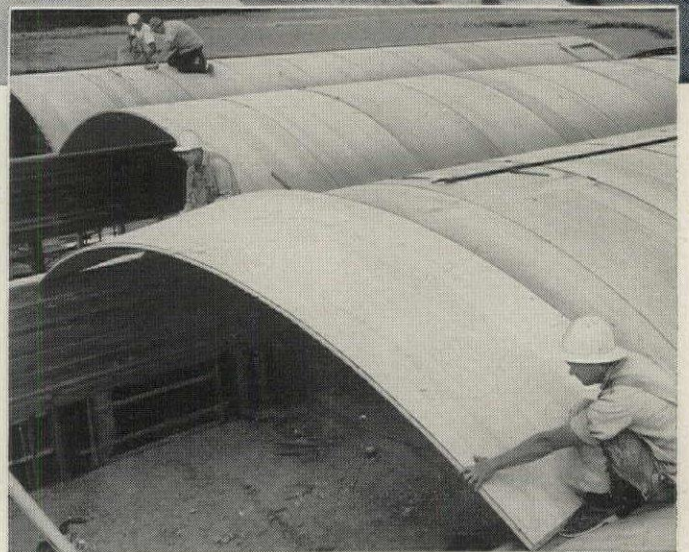
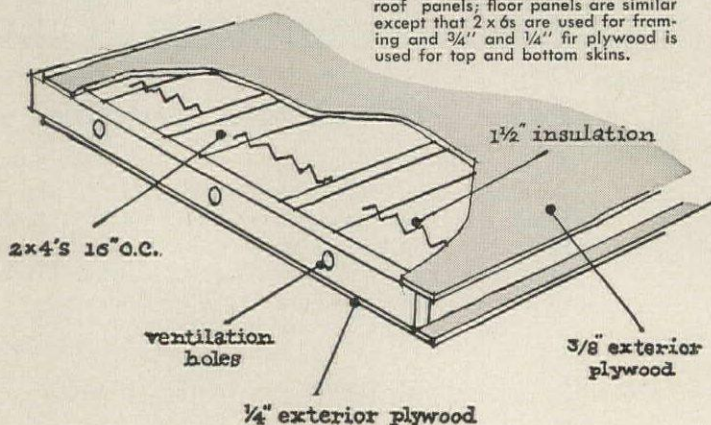

7

**Curved Panels** on this school building span 16 feet, cost only \$1.10 per square foot in-place. These panels are of sandwich construction, with 5/16" upper skins and 1/4" fir plywood lower skins glued to a 3/4" honeycomb paper core; edges are tongue and grooved. Contractor: Standard Construction Co.; components fabricated by Panelbild Systems, Inc.; architect: Robert Billsbrough Price.

Like the flat panels shown at left these curved components rely on thin stressed-skin plywood coverings to achieve strength and stiffness without bulk or dead weight.

# ideas for tomorrow's house you can use today

**Fir plywood box beams and truss gusset plates offer strength, safety and savings**

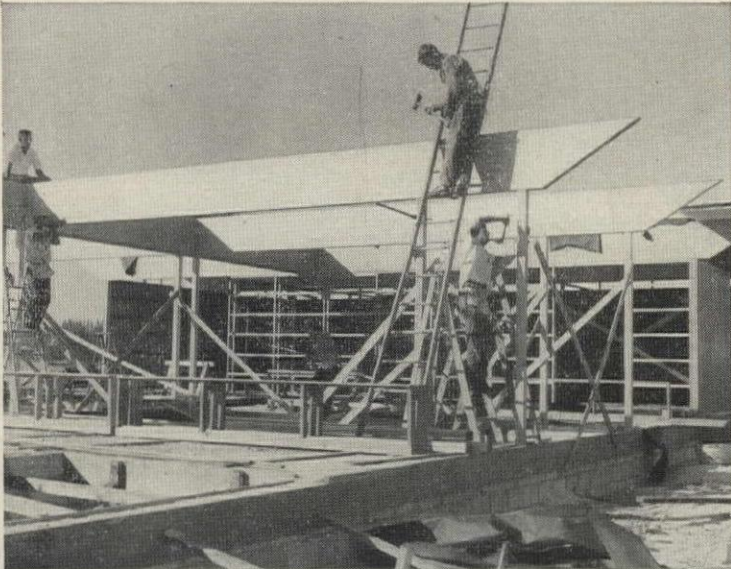

**8**

**Fir plywood box beams** are light, strong, dimensionally stable. They can be engineered for any load or span and fabricated in almost any shape dictated by design or appearance considerations. For floor, roof or ridge beams, garage door or window lintels, there is no cheaper—or better—way to do the job.



**9**

**Fir plywood gusset plates** are the surest and simplest way of fastening joint truss members together. Plywood provides greater rigidity, reduces deflection. It can be used for either nail or nail-glued construction. The trusses themselves eliminate load bearing partitions, take less time and material to build.

**Fir plywood wall components like these make building fast, easy and profitable**

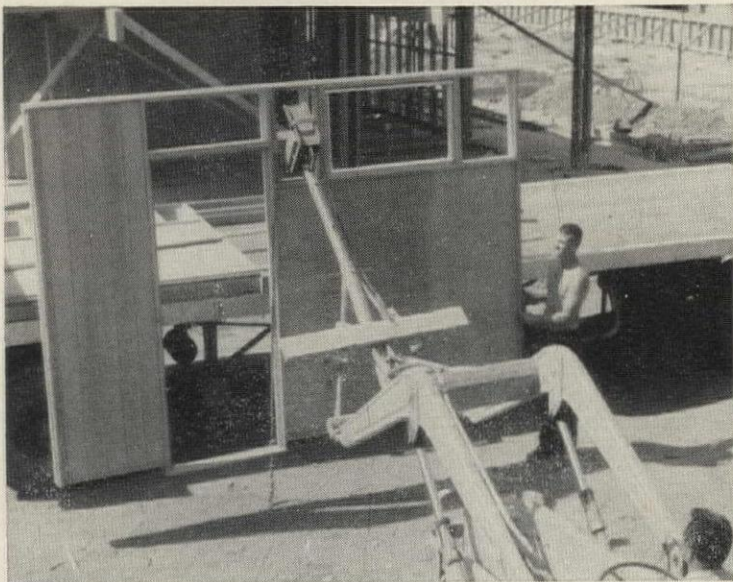

**10**

**Prefabricated plywood wall panels** used for a 50-room motel job in Palo Alto helped Contractor Don Gordon build five buildings in less than 100 days at a cost of less than \$9 p.s.f. The fir plywood components were assembled in jigs and trucked to the job site where they were boom-lifted into position.



**11**

**Panelized plywood wall sections** permit three workers to erect walls in only 90 minutes on Lu-Re-Co homes built by Hebb & Narodick, Seattle. Components (including trusses and plywood sheathed gable ends) are credited by construction foreman with saving as much as \$300 per house in labor costs alone.

**For your own protection, specify only DFFPA trademarked plywood**

(CONTINUED)

20 WAYS TO BUILD

MORE HOUSE

FOR THE MONEY



# FIR PLYWOOD SUBFLOORS

# 2·4·1<sup>®</sup>

1½"-thick plywood combined subfloor-underlay panels

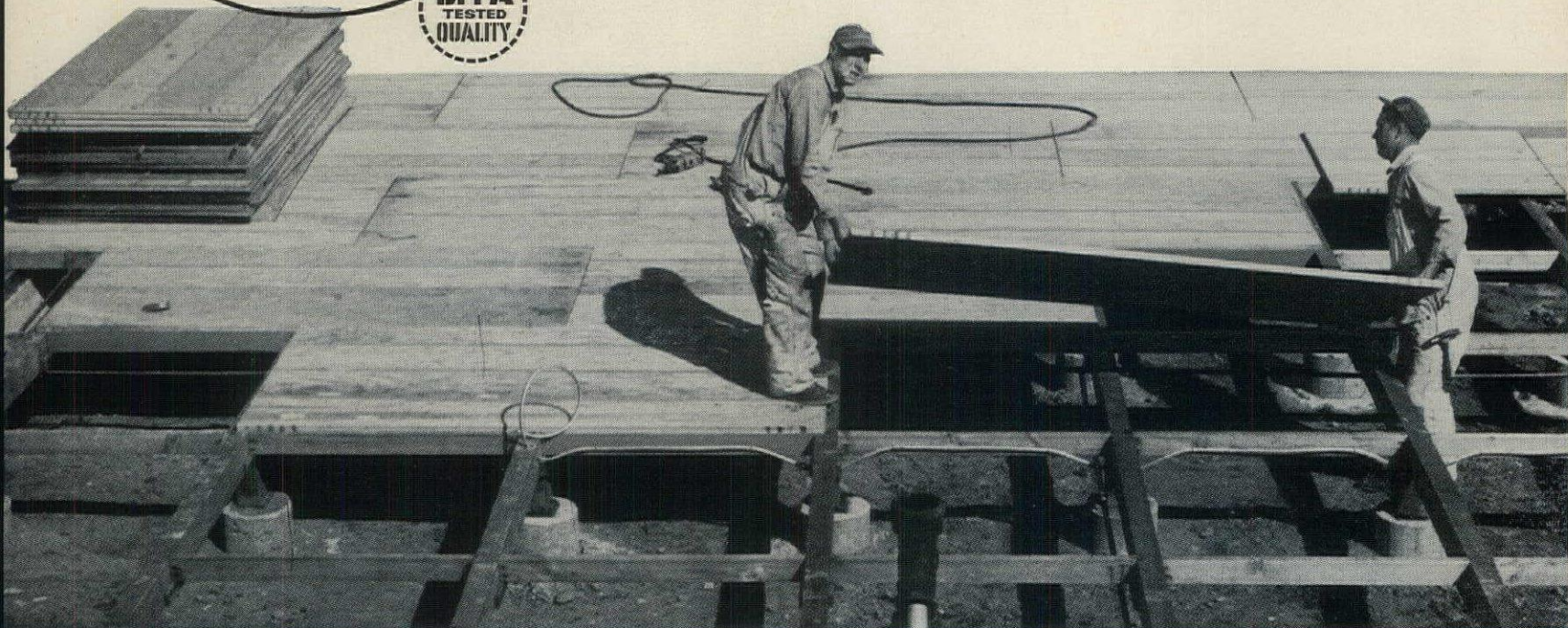

## 12 Why August Garcia is sold on 2·4·1<sup>®</sup> plywood

August Garcia and Ed Rosenbaum, builders of the 234-home Mardell Manor project used 2·4·1 plywood with Exterior (waterproof) glue because the panels stand up better under repeated wetting and drying encountered during construction delays of as long as four weeks. With 2·4·1 there is no shrinkage or swelling or knots to loosen and drop out. The plywood forms a smooth, tight base for finish flooring.

Builder Garcia estimated savings in labor and materials more than offset 2·4·1's higher initial cost. "But most important," he says, "it lets us give customers a better house. We have yet to have a flooring complaint. That's why I'm 100 per cent sold on 2·4·1."

## 13

### ...and how Dale Forsberg used it with a new spline joint to save over \$200 per house

Forsberg Construction Co., Minot, S. D., has saved as much as \$225 per house with 2·4·1 plywood over girders on four-foot centers, using splines instead of 2 x 4 blocking to support panel edges. The system saves both labor and materials—plus contingent savings on application of finish floors. A four-man crew can install 1,120 sq. ft. of 2·4·1 subflooring in just under three hours.

For more information about 2·4·1 combined subfloor-underlay panels, write Douglas Fir Plywood Association, Tacoma 2, Washington.

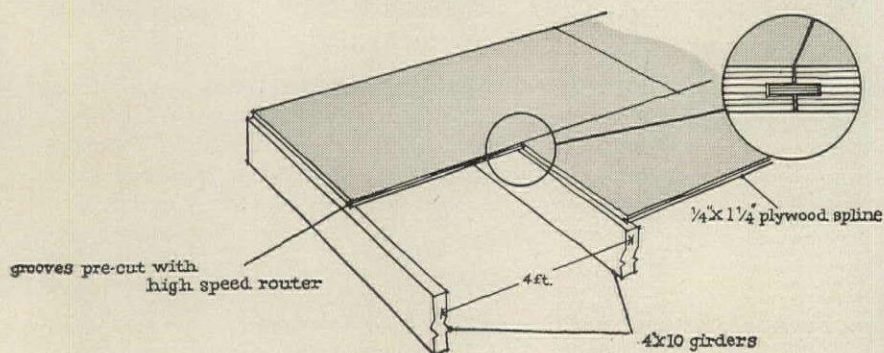



# and SHEATHING: better construction, lower cost

14

## "Blanket" sheathing saves time and labor costs on Long Island homes

H. M. Gorelick, Inc., developed a system for "blanketing" a house with PlyScord sheathing that not only results in stronger, tighter construction but also saves two man hours or \$7.00 per house.

Carpenters cover the entire outside wall with PlyScord without regard to window or door openings. After the entire surface is sheathed, window and door openings are cut out from the inside with an electric saber saw. Cut out portions are dropped on the ground and salvaged for re-use.

On a typical unit with 432 sq. ft. of wall area, it took two men only one hour and thirty five minutes to apply the sheathing and cut openings. Using the conventional method of measuring, scribing and sawing took two and a half hours.

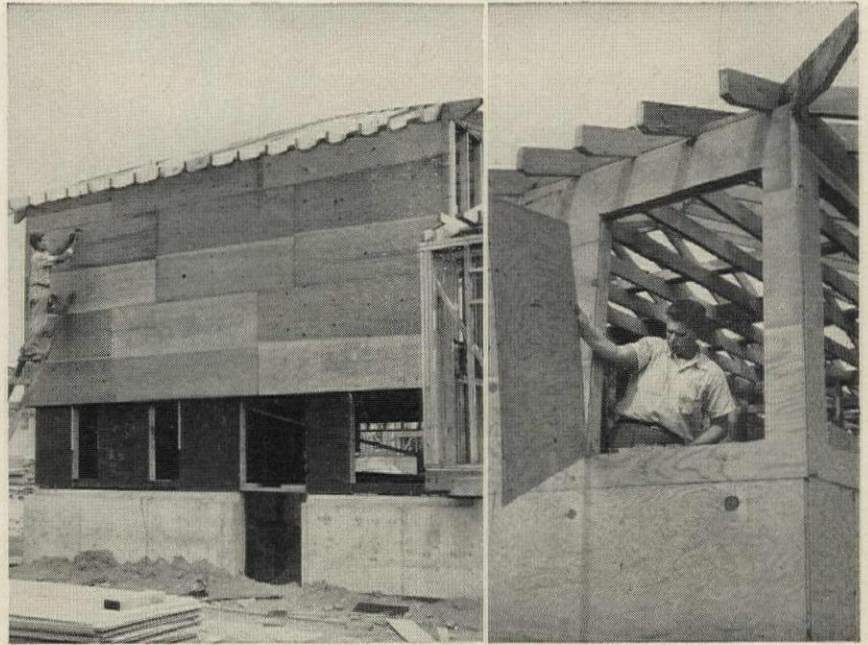

15

## PlyScord® wall and roof sheathing speeds work on New Hampshire public housing job

The combination of PlyScord and Plyclips is credited with making possible a 50 per cent labor savings on this 31-building New Hampshire public housing project. Over 160,000 sq. ft. of plywood was used for both wall and roof sheathing.

The contractors, Beacon Construction Co. of Boston, report plywood's large size and workability helped speed work, and that the use of Plyclips to support panel edges on the roof sheathing eliminated the need to cut and apply blocking between rafters.

Plyclips are a relatively new item, but are available throughout the country in all standard plywood thicknesses and cost only about \$3.50 per 100. For more information write Douglas Fir Plywood Association, Tacoma 2, Washington.

For your own protection, specify only DFPA trademarked fir plywood

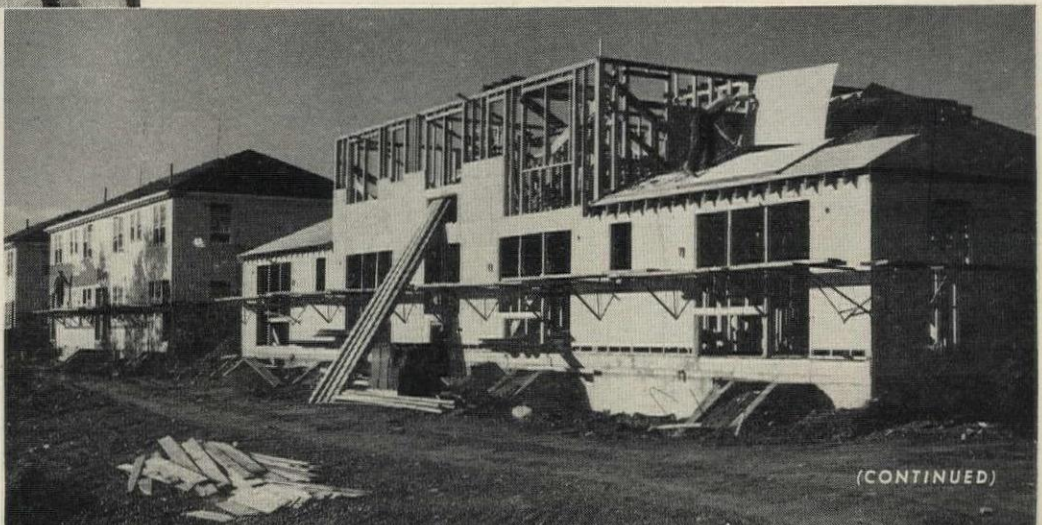
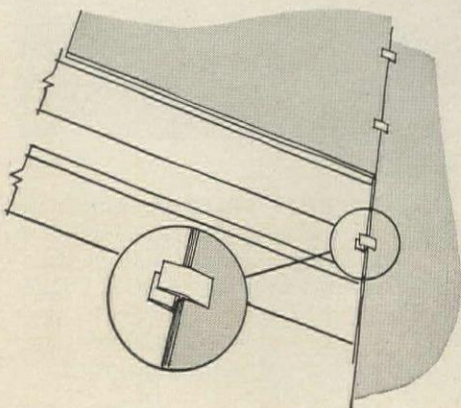

(CONTINUED)



# FIR PLYWOOD BUILT-INS



16

## Plywood shelf-door wardrobes double usable storage space

Here's a new way of handling wardrobe storage developed by Architect Mary Lund Davis in cooperation with *Better Homes and Gardens*. It's loaded with ideas that can be profitably adapted to most speculatively built houses.

The basic idea is simple: 1/4" fir plywood doors stiffened on four sides with 1x4 lumber. Shelves also add stiffness and provide up-front storage for small items. Doors open to provide free access to built-in fir plywood drawers and storage trays. By varying placement of shelves and interior fittings, the shelf-door principal can be adapted to meet storage requirements in any room.

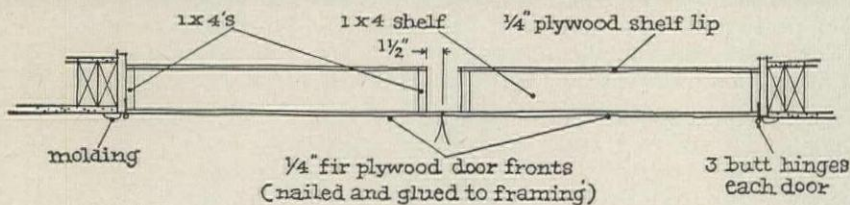

Your sales story is built-in, too, when you offer your prospects plenty of storage space.



17

**Bedroom built-ins** like these make a big hit with families with children. Built-in desk and drawer units plus roomy plywood shelf-door wardrobe permit owners to move in with minimum investment for furnishings.

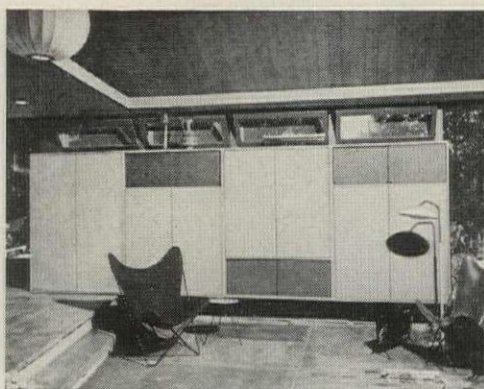

18

**Storage walls** of fir plywood are a real "plus" when it comes to making sales in today's competitive market. Light, strong fir plywood speeds work, simplifies framing and carpentry work for your crews; takes any finish.

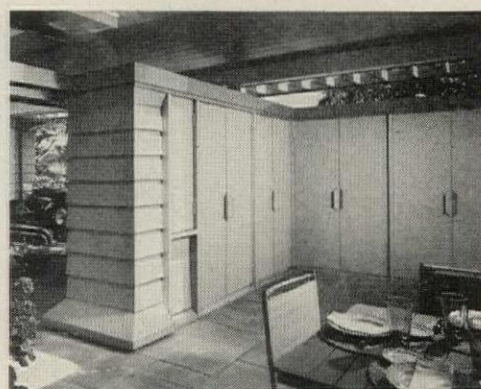

19

**Carport storage** makes up for the lack of storage space in homes without garages or basements. Exterior plywood "built-ins" like this give your customers a place to store outdoor furniture, garden and patio equipment.

# boost your loan value as well as sales appeal

## 20 New idea in fir plywood cabinet construction saves you time and money

This unique system for modular cabinet construction makes use of satin finish aluminum frames and fir plywood to make flush cabinets with the popular new "sheer" styling. Developed by Architectural Hardware Corp., the metal framed plywood units save over a third of the time and up to 15 per cent of the cost of conventional cabinets.

Plywood sides, top and bottom are cut into simple rectangular shapes and slipped into top and bottom frames which interlock parts to form a single rigid unit. No other fastenings or special joinery are required.

The system can be used for both upper and lower units and is flexible despite its reliance on standardized sizes. Frames may be purchased separately or complete with pre-cut fir plywood. For information write, Douglas Fir Plywood Association, Tacoma 2, Washington.

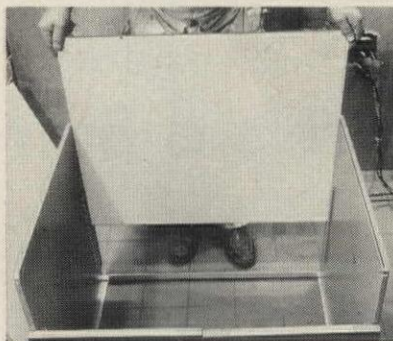
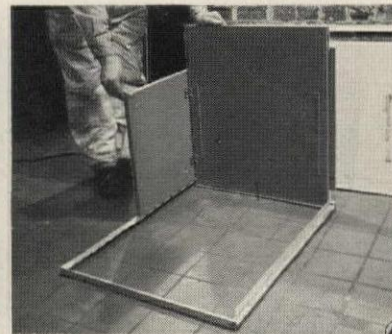

## ONLY QUALITY PLYWOOD IS DFPA TRADEMARKED

Plywood construction is the finest, strongest money can buy. But to do the job it must be made right *inside and out*. Quality is critical.

That's why it makes sense to insist on DFPA grade-trademarks on every panel.

DFPA trademarks identify plywood produced under the industry-wide DFPA quality control program which includes both continuous factory inspection and laboratory testing. Quality is never compromised. Where plywood does not meet DFPA standards, use of grade-trademarks is withdrawn.

DFPA trademarks are backed by over 25 years experience in plywood testing—plus the reputation and integrity of over 100 DFPA-member mills which produce more than 90 per cent of all Douglas fir and Western softwood plywood.

**DOUGLAS FIR PLYWOOD ASSOCIATION, TACOMA, WASHINGTON**  
—a non-profit industry organization devoted to research, promotion and quality control



Since 1934, the DFPA-industry quality control program has served customers and specifiers by providing unbiased and authoritative certification of fir plywood quality.

**Only plywood which bears the DFPA trademark is manufactured under the industry-wide Douglas Fir Plywood Association quality control program. Always look for the letters "DFPA"**

*This hinge didn't even rate  
in the time of Catherine the Great*

Oh Catherine the Great

Had a very strange trait —  
The sight of these hinges  
Set her off on long binges.

Were she here today,  
"Architects," she'd say,  
"Give me Soss Hinges.  
I'll stop these binges."

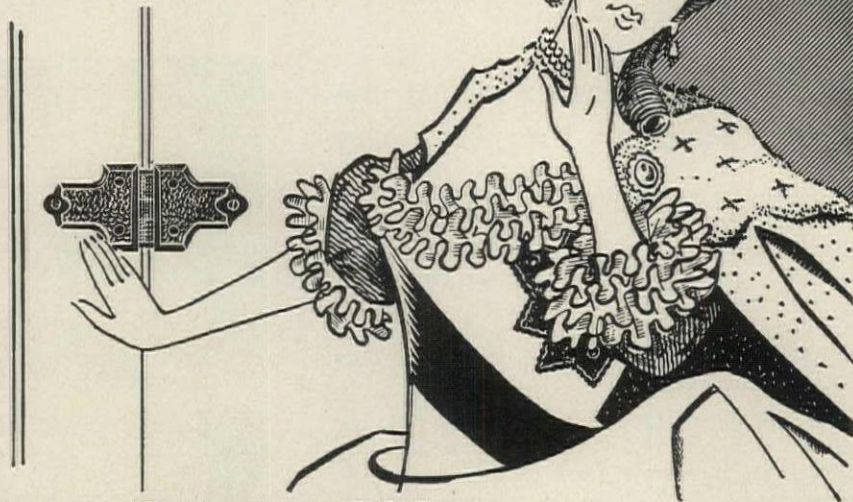

**TODAY** there's a Better Way....  
thanks to **MODERN**

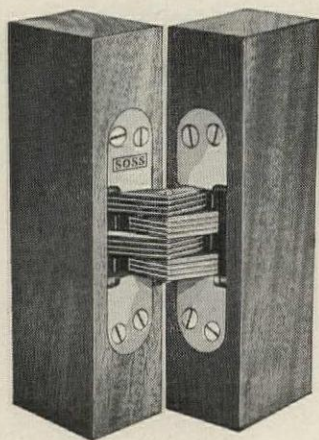

The

**SOSS**  
INVISIBLE  
HINGE

Eliminates ugly protruding hinge butts. Entire hinge is hidden from view when doors or lids are closed. Used the world over, in all type buildings, whenever the ultimate is demanded in materials and design. Available in a wide range of sizes for nearly every wood or metal application.

**SOSS**  
LEV-R  
LATCH

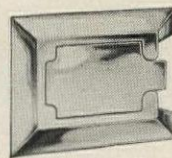

Replaces knobs. Makes it possible to easily open doors with the flick of a finger. Extremely low in cost. Can be installed on any door in less than 5 minutes! Modern design beautifully compliments contemporary architecture. Available in all standard U.S. finishes.

**SOSS**  
OLIVE  
BUTT

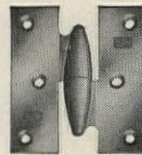

In those instances where it is mandatory to use a butt hinge this one does the job in a very complimentary way. The low price makes it doubly attractive.

For complete information and prices on these advanced SOSS Products see your nearby building supply dealer or hardware dealer, or write:

**SOSS MANUFACTURING COMPANY**

P.O. Box 38 • Dept. HH-3 • Harper Station  
DETROIT 13, MICHIGAN

# FOR HEALTH'S SAKE

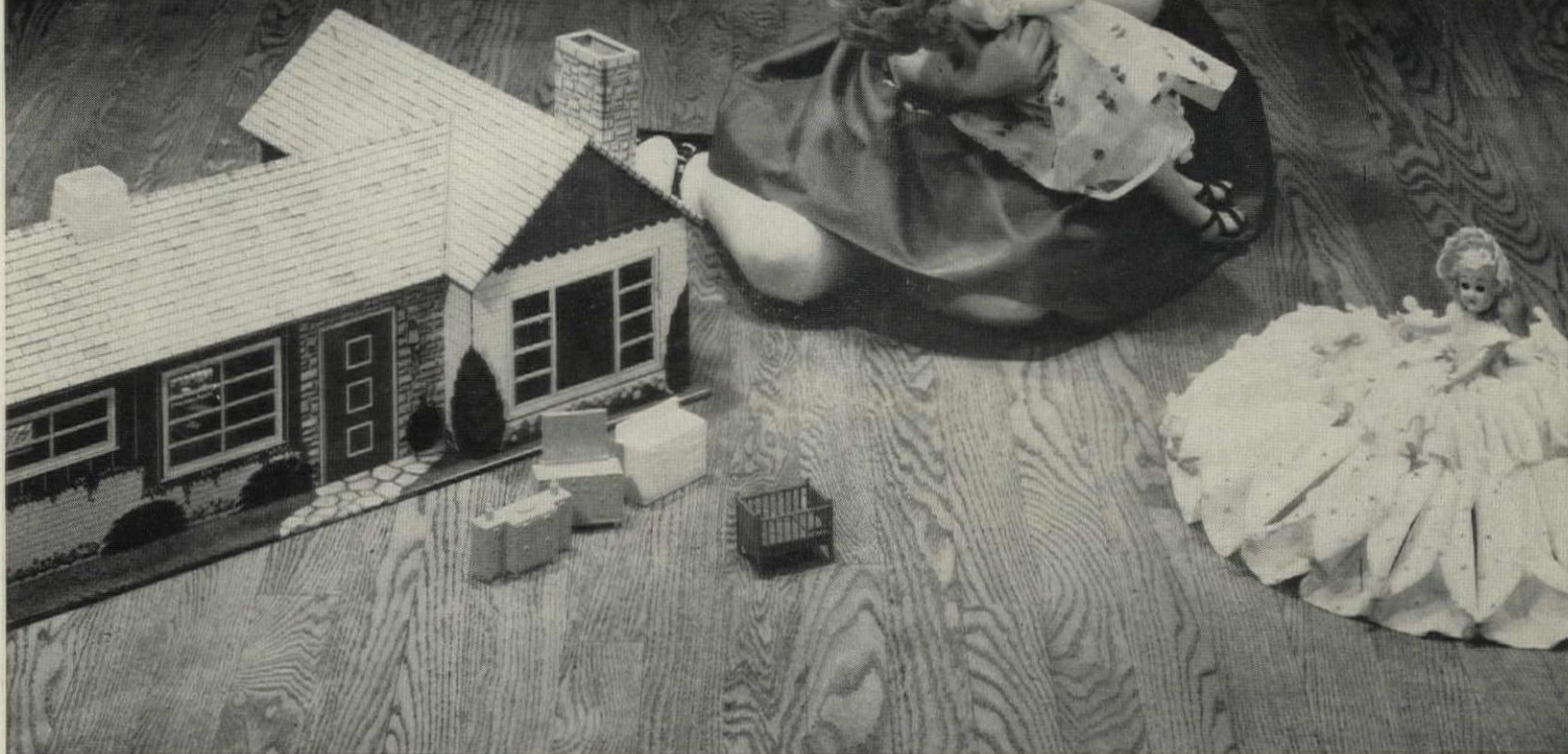

## Homes built on concrete slab need the warmth and resilience of OAK FLOORS

**F**OR greater sales appeal in your slab-on-ground homes, use Oak Flooring... preferred by home buyers everywhere. Oak Floors provide needed resilience and warmth so necessary to health and comfort. Their beauty and durability are added sales features.

The screeds-in-mastic installation method provides a sound nailing surface for Strip Oak Flooring over concrete and is used by many leading builders. It's easy, fast and effective... has the approval of lending agencies... and meets the budget of lowest priced homes. Try it in your slab-on-ground homes for greater sales appeal.



Write for free Installation Manual.  
NATIONAL OAK FLOORING MANUFACTURERS' ASSOCIATION  
834 Sterick Building • Memphis 3, Tenn.



Over concrete, install Strip Oak Flooring this low-cost way... on screeds imbedded in mastic.

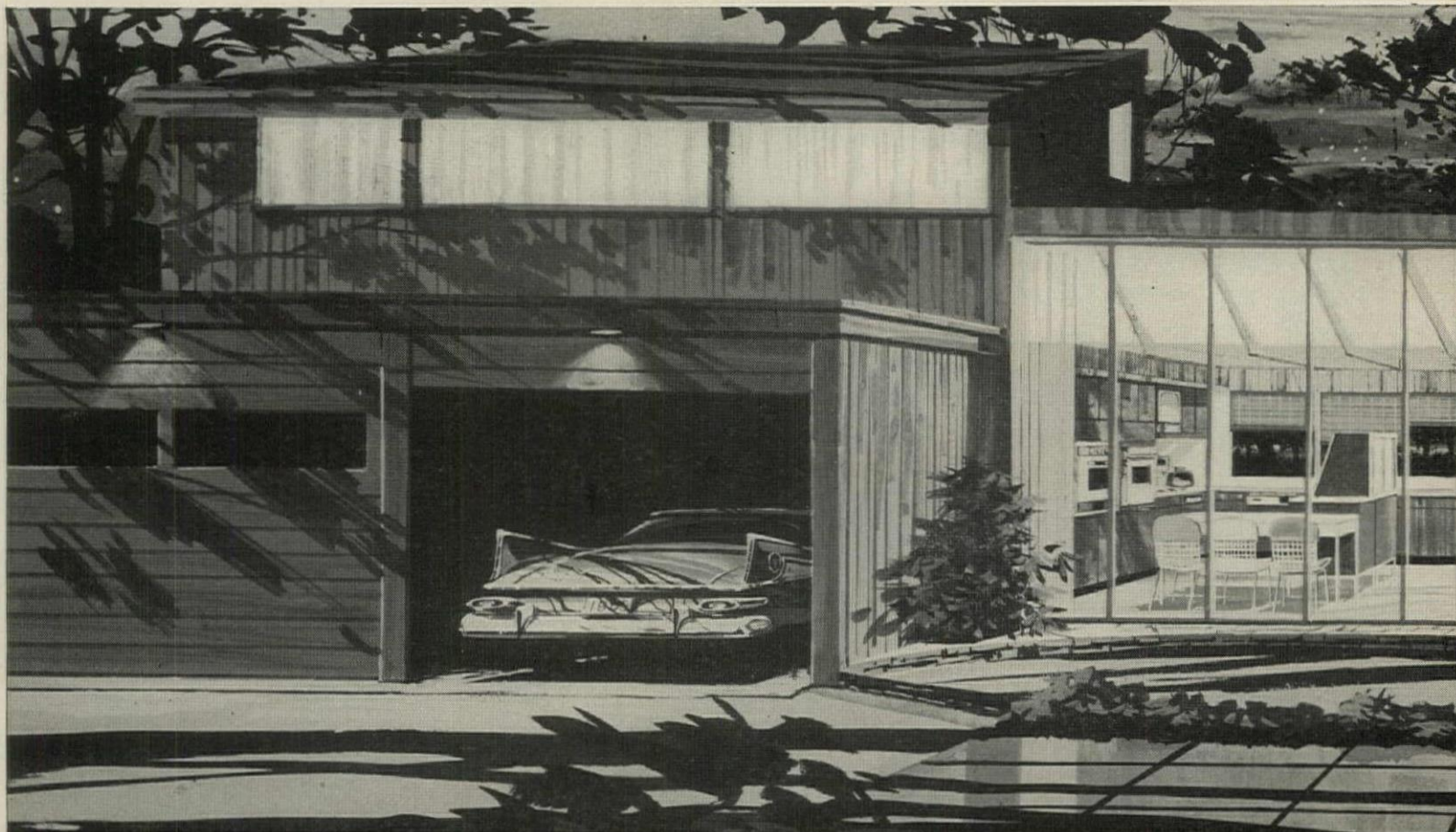

# THE TOTAL ELECTRIC HOME

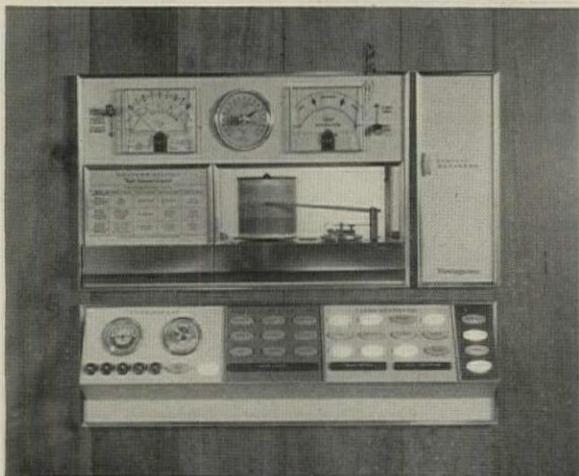

*Total Electric Living as expressed in these Home Centers will be featured in Westinghouse advertising to home buyers.*

**LAUNDRY CENTER**—This new Westinghouse Laundromat actually *thinks* for itself. . . its program computer chooses exact cycle for each fabric! Dryer shuts itself off the instant clothes are dry. Clothes hampers contain germicidal Odor-Out lamps.

**FOOD PREPARATION CENTER**—Makes preparing and cleaning up after meals fast and fun. Refrigerator keeps meat fresh 7 days without freezing. Electronic range cooks complete meals in a few minutes.

**WEATHER CONTROL CENTER**—Contains master switch and thermostat for electric heating and air conditioning. Operates precipitron and germicidal lamps which eliminate dust, pollen and air borne health hazards. Controls lights, de-ices sidewalk, turns on lawn sprinklers. Includes wind gauges, barometer, inside-outside thermometers, and humidity indicator. While Westinghouse does not build a Weather Control Center, we will be glad to furnish suggestions and list of components needed.

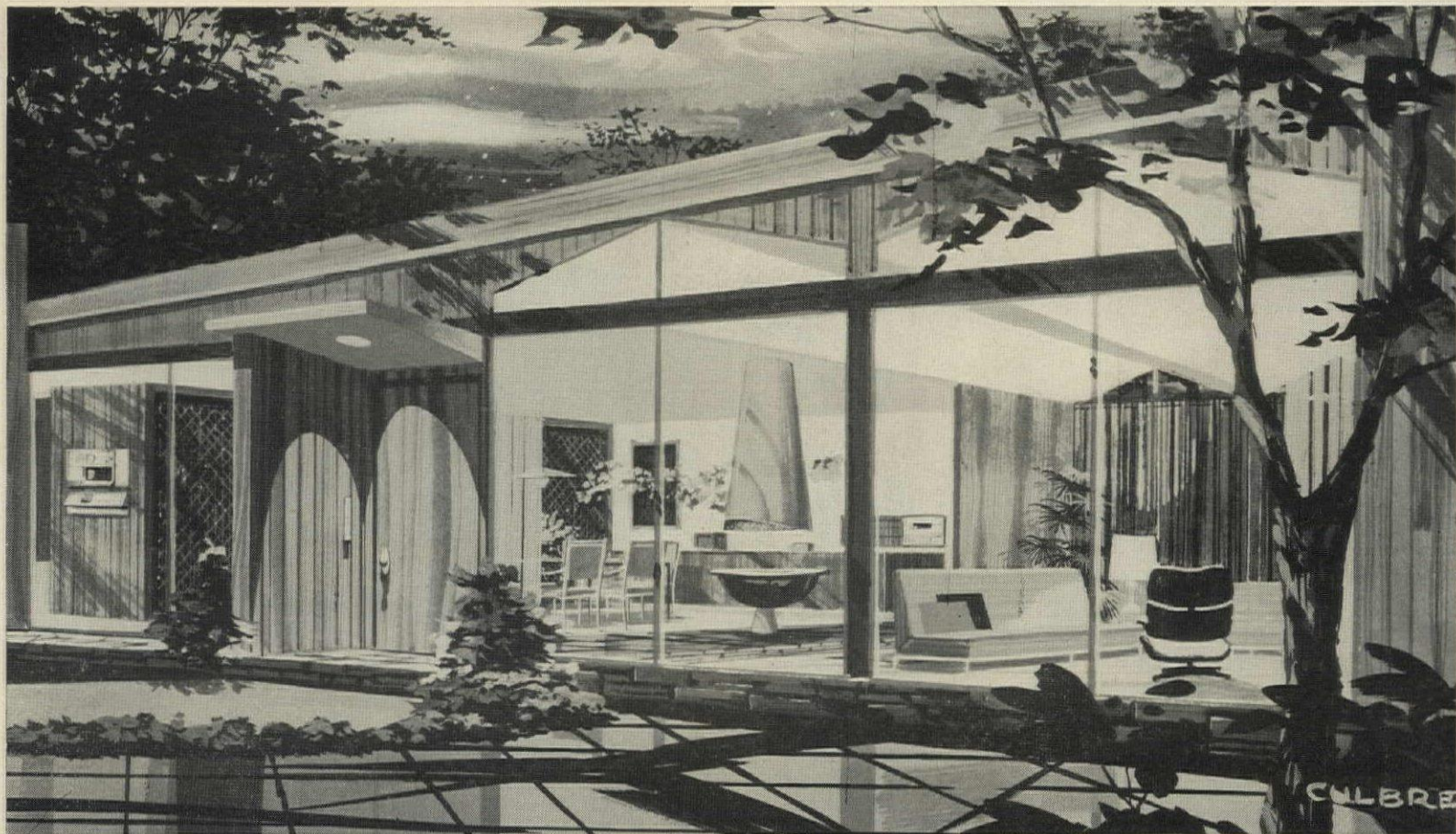

# WESTINGHOUSE

stimulates new interest in home ownership with a dynamic new program to sell the concept of Total Electric Living

*... where electricity does everything  
... heats, air conditions, launders, illuminates,  
cooks, preserves food, entertains.*

Now, through the concept of the Total Electric Home, Westinghouse sets out to promote electrical living in its most advanced form—homes that rely solely on clean, safe electrical power for the operation of heating, air conditioning and appliances.

Westinghouse will promote this idea aggressively on television, in magazines, and in newspapers. As a result, Westinghouse will stimulate new interest in home ownership and help to bring you more enthusiastic buyers who are dissatisfied with their older, out-of-date homes.

The Total Electric Home Program will pioneer new ideas in home planning, several examples of which are shown opposite. All the ideas are practical . . . all of the Westinghouse products shown—even Electric Heating—are on the market today. The heart of this home is *Electric Heating* . . . and in many areas electric

utilities are working with builders to push this great improvement in home comfort.

As the Westinghouse Total Electric Home program gathers speed you will find it profitable to make the homes you build Total Electric.

Total Electric Home Department, Westinghouse Electric Corporation,  
3 Gateway Center, Pittsburgh 30, Pa.

**Westinghouse**  
**TOTAL ELECTRIC HOME**  
HEATING · COOLING · APPLIANCES



YOU CAN BE SURE...IF IT'S **Westinghouse**

WATCH "WESTINGHOUSE LUCILLE BALL-DESI ARNAZ SHOWS" CBS-TV MONDAYS

**Westinghouse**  
**TOTAL ELECTRIC HOME ... Where Electricity Does Everything!**  
HEATING · COOLING · APPLIANCES

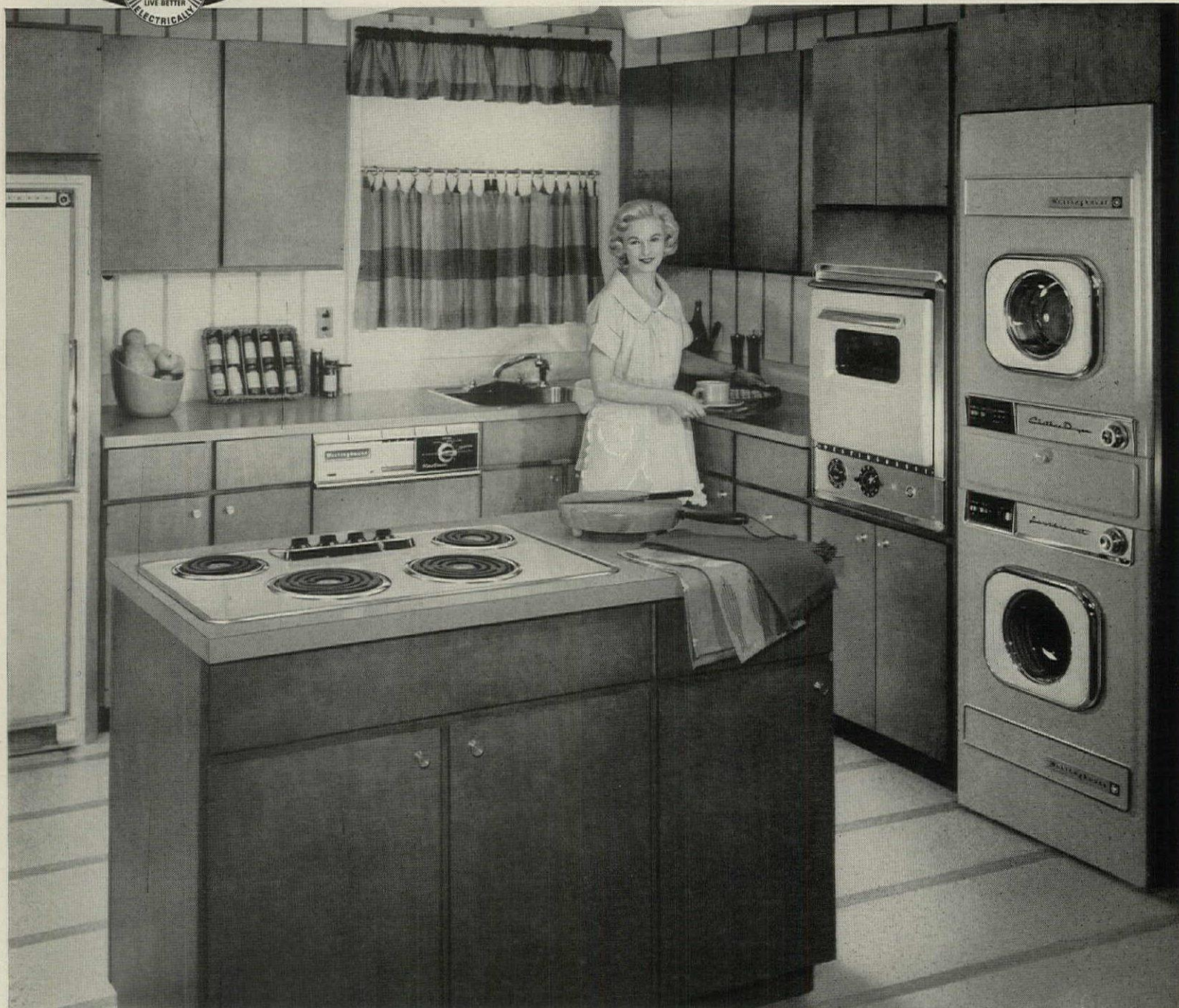

**YOU CAN OFFER EXCITING KITCHENS LIKE THIS** when you use the all-new line of Westinghouse Built-Ins *plus* Westinghouse Heirloom Maple Wood Cabinets. The cabinets are designed to match and sized to accommodate all Westinghouse Built-Ins. Also available is a complete line of Westinghouse Steel Cabinets in attractive Confection Colors. For further details on the most extensive line of built-ins on the market today and matching cabinets, go to *one* source . . . your Westinghouse Distributor. Or write to Westinghouse Electric Corporation, Contract Sales Dept., Major Appliance Division, Mansfield, Ohio.

**YOU CAN BE SURE...IF IT'S** **Westinghouse**

WATCH "WESTINGHOUSE LUCILLE BALL-DESI ARNAZ SHOWS"—CBS-TV MONDAYS



# BUILD EXCITEMENT INTO YOUR HOMES WITH NEW WESTINGHOUSE BUILT-INS AND CABINETS

\*\*\*\*\*

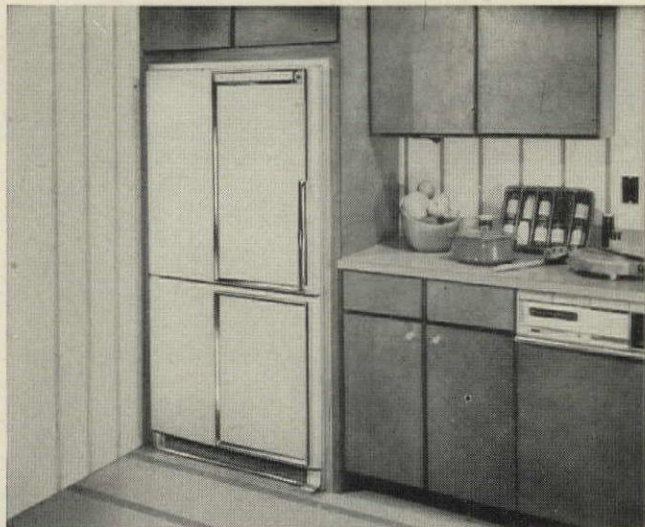

**REFRIGERATOR-FREEZER IS TRIM AND TERRIFIC.** Trim because it has no coils on back . . . because it needs no extra space for door swing. Concealed hinges permit opening to a full 90° within cabinet width. Terrific is the word for this built-in's exclusive Cold Injector that keeps meat fresh up to 7 days without freezing.



**DISHWASHER GUARANTEES 140° HOT WATER.** That's the temperature needed to get dishes really clean. Only this new Imperial Roll Out model provides it, regardless of tap water temperature, with its unique Hot Water Booster. Attractive Choose 'N Change front panels are available in 9 colors and finishes. Holds service for 10.

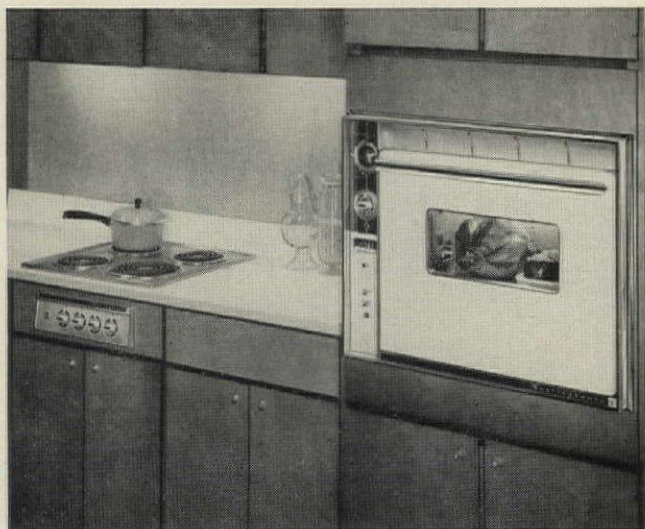

**OVEN HAS DRAMATICALLY NEW DESIGN.** Controls are ideally located in vertical panel at side . . . out of heat zone, yet easiest to reach. Available in built-in or stack-on models, it features the Serv-Temp Roast Guard, Built-In Rotisserie and Lift-Off Door. New range platform has remote controls, 1001 heats. Check for availability dates.



**PUSH-BUTTON LAUNDRY BUILDS-IN ANYWHERE.** Put it in the kitchen, bathroom or hall closet. Matching Clothes Dryer installs on top of Laundromat to save space. 25" wide Space-Mates also build-in undercounter or up in the wall. Together, they wash and dry 18 lbs. of clothes at the same time . . . are completely automatic.

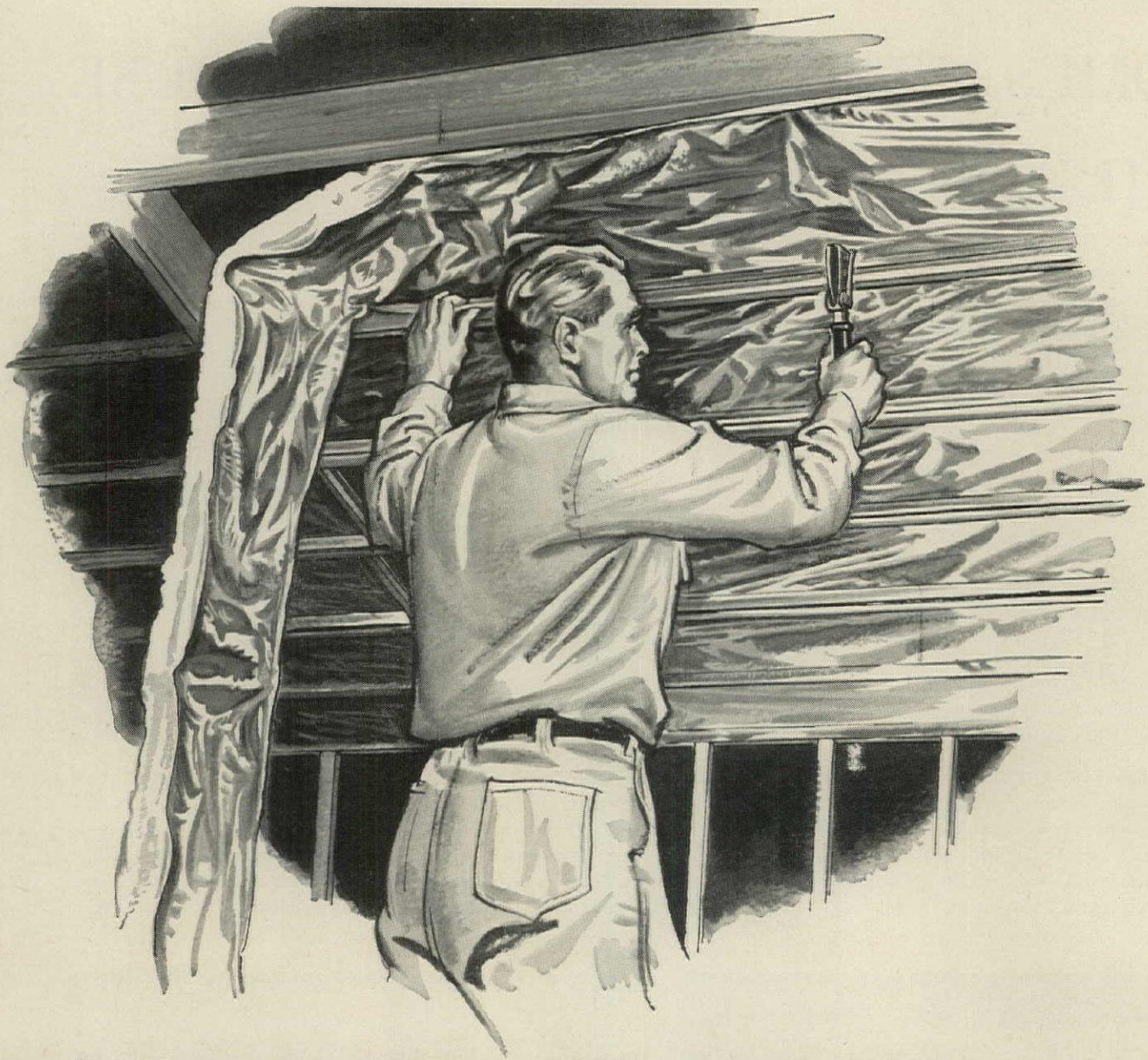

For the Construction Industry . . . the big news for 1959 is

## JOHNS-MANVILLE FIBER GLASS

With L·O·F Glass Fibers Company joining the J-M family, your Johns-Manville Representative can now serve you with quality J-M fiber glass construction materials for these services:

**Home insulation**—lightweight *J-M fiber glass* insulation provides year-round comfort . . . improves efficiency of heating and air-conditioning systems. Exceptionally resilient and compressible, it saves space in transit and in storage.

**Plumbing, heating and air-conditioning systems**—lightweight, easily handled *J-M*

*fiber glass* pipe insulations, duct liners and wraps.

**Sound control**—large size, attractive, non-combustible *J-M fiber glass* panels for acoustical ceilings.

**Skylights, partitions, awnings**—shatter-proof, translucent *J-M Corrulux®* panels reinforced with *J-M fiber glass*.

**Underground pipe protection**—a complete line of *J-M fiber glass* wraps for reinforcing and shielding coatings on pipe lines.

All buyers of fiber glass products will now be served by an enlarged field staff

of Johns-Manville sales and technical personnel operating out of 56 sales offices. This news means expanded distribution facilities . . . the addition of 7 strategically located plants . . . an expansion of research and development of fiber glass products.

Call your Johns-Manville Representative or write to Johns-Manville, Box 16, New York 16, New York. In Canada, address Johns-Manville Company, Limited; 565 Lakeshore Road East, Port Credit, Ontario.

# JOHNS-MANVILLE



Only three nails required per shingle . . . 1,900 fewer nails on a 20 square roof . . . nailing marks insure correct and fast application.

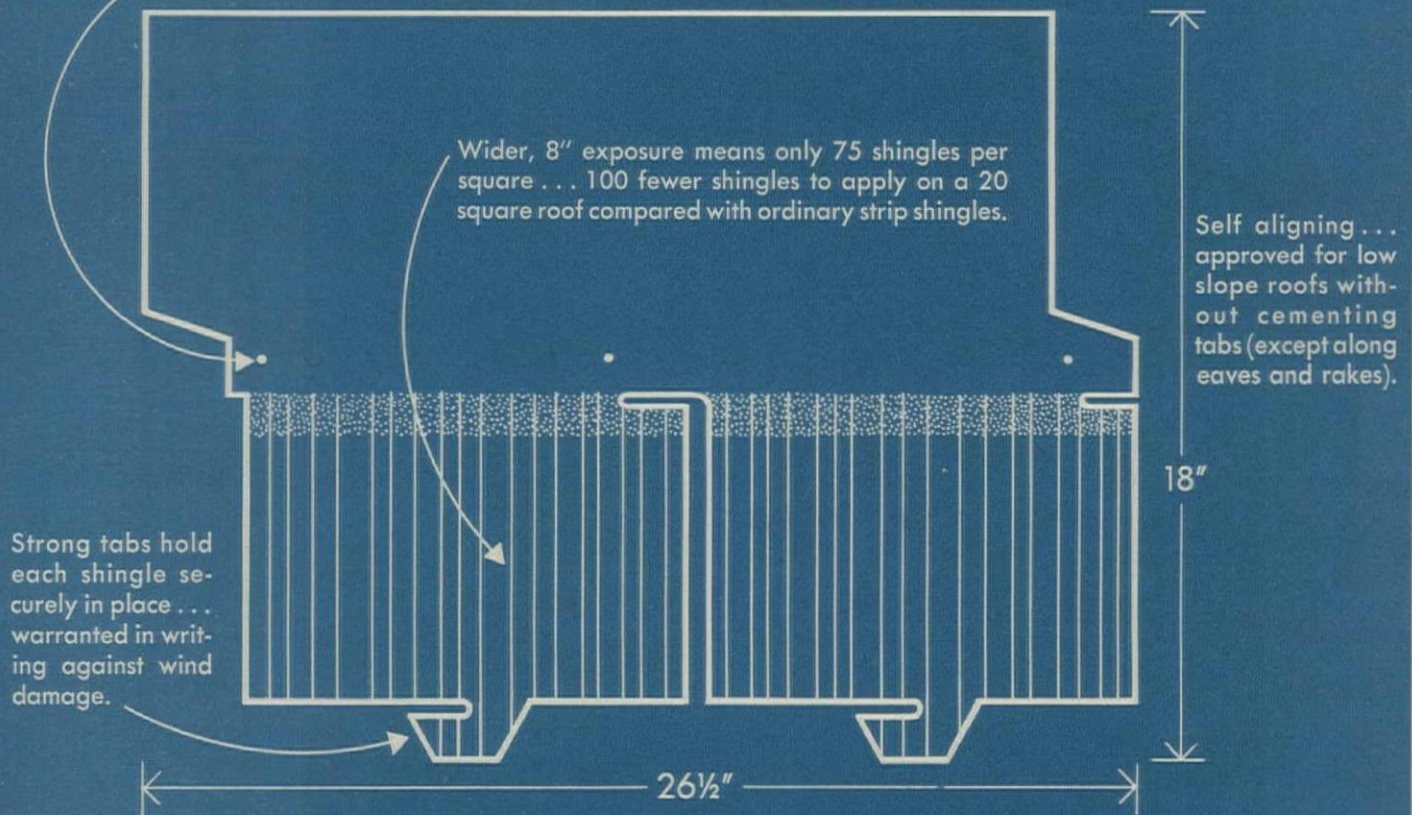

AVAILABLE IN  
*Trend Colors*

ANOTHER  
**RUBEROID**  
DESIGN...

FOR HOMEBUILDING ECONOMY!

## LOK-TAB<sup>®</sup> asphalt shingles

Lok-Tabs are designed by Ruberoid to cut application costs, yet at the same time provide a better and stronger roof. Ruberoid offers a written warranty against wind damage on every Lok-Tab roof. Lok-Tabs give you a new roof selling feature for your new homes *and* cut your building costs.

The Lok-Tab is another product originated by

Ruberoid and designed to improve new homes and cut building costs. It's part of a line that has been serving builders better since 1886. On your next house or project, check with your Ruberoid dealer. Learn how you can build a better looking home *and* cut your costs with quality Ruberoid building products. For more information on Lok-Tab asphalt shingles, write:

The RUBEROID Co.

**RUBEROID**<sup>®</sup>

500 FIFTH AVENUE, NEW YORK 36, N. Y.

# All new...built-to-sell

# ROPER

## BUILT-IN GAS RANGES



## Help your kitchens sell your HOMES!

Build extra selling power into your homes! Install brilliant, all-new Roper gas built-ins. Smart, modern styling sells on sight. Roper's reputation identifies your homes as top quality. Customer satisfaction assured by Roper dependability and cooking advances. Easy, economical to install. Feature fast, clean, modern Roper gas built-ins . . . and sell!

**MAIL  
COUPON  
TODAY**

Geo. D. Roper Sales Corp., Kankakee, Illinois  
Please rush full information on the new Roper  
Gas Built-Ins.

Firm \_\_\_\_\_

Individual \_\_\_\_\_

Street Address \_\_\_\_\_

City \_\_\_\_\_ State \_\_\_\_\_

I am a \_\_\_\_\_  
(type of business)

My building material supplier is \_\_\_\_\_  
(name)

(city)

HH 3 59

### ROPER ADVANCES MEAN BETTER COOKING...BETTER SELLING!

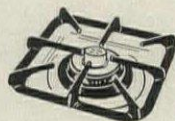

#### TEM-TROL TOP BURNER WITH "FLAME-SET" CONTROL

Fully automatic . . . won't burn foods. No potwatching. "Flame-Set" allows choice of starting flame size.



#### HUDEE RIM

Cooking top mounts snug and flush with counter top. So good looking. Easy to clean. Won't catch dirt.



#### "THERMO-SPIT" ROTISSERIE

Dial on spit shows internal temperature of meat as it barbecues. Accurate . . . no guesswork. Easy to read.



#### SMART NEW STYLING

Crisp, clean lines look well in any kitchen. Choice of four colors or rich Satin Chrome metallic finish.

**GEO. D. ROPER SALES CORP.**  
a subsidiary of Geo. D. Roper Corporation  
Kankakee, Illinois

No. 333  
Patent Pending  
Steel Case  
U.S. 15 Dull Nickel Finish

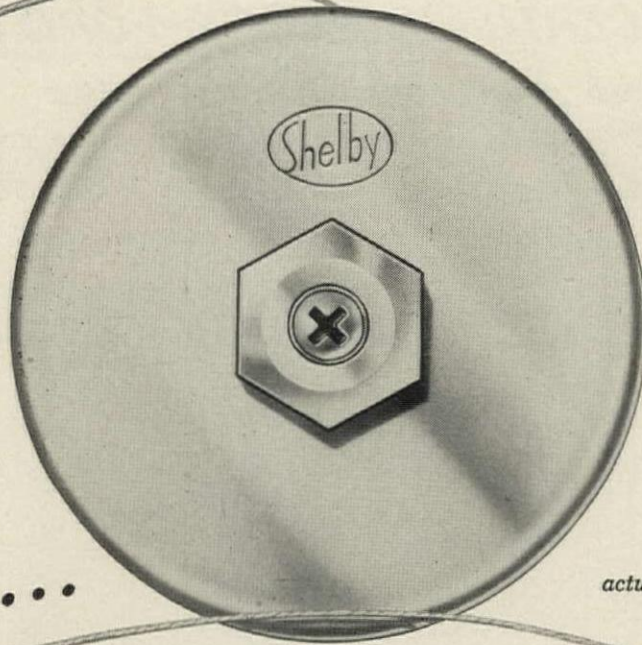

actual size

at last...

## a Closer for Sliding Glass Doors

...and only Shelby has it

- SMART • PRACTICAL • ECONOMICAL
- EASY TO INSTALL • ADJUSTABLE SPEED

*Open door . . . walk through . . . door closes!*

Now every sliding glass patio door can become truly contemporary by adding a Shelby Sliding Glass Door Closer. Designed for all plate and crystal sliding glass patio doors up to 4 feet wide and 6 feet 8 inches high.

*Easy to Install*—A simple do-it-yourself job. Requires only one screw and a hook to put closer into operation.

*Simple to Adjust Speed*—Door speed can be set so that door will glide shut with a quick and firm, or slow and gentle, action.

*Can be Reversed*—Closer comes assembled for doors operating from Right to Left. Simply remove cover, reverse mechanism and replace cover. Closer will then operate on doors sliding from Left to Right.

Wind, bugs, rain, dust and insects are no longer a chronic problem to the homemaker. No more worry about rain-soaked carpets or draperies. No need to worry about high air conditioning or heating bills because of an open door. With the Shelby Sliding Glass Door Closer, any glass door will glide shut instantly, smoothly, quietly—every time.

Remember . . . if it isn't a Shelby, it isn't a "Reel" sliding glass door closer!



THE SHELBY SPRING HINGE CO., Shelby, Ohio, U.S.A.

manufacturers of quality builders hardware since 1898



**NOW! CERTIFIED PROOF—FORD TRUCKS COST LESS...**

# '59 Ford Trucks Win — average 25.2%



'59 Ford pickups running one of the Economy Showdown courses set up by the research engineers. Like all the new '59 pickups tested, these are regular stock models with a standard six-cylinder engine, 3-speed transmission and standard rear axle ratio.

- **Biggest comparison tests of truck gas mileage ever conducted by an independent research firm!**
- **Pickup models of all six makes tested in all kinds of driving!**
- **Both new and used trucks tested—534 units all told!**

The difference between the right truck and the wrong truck can cost you *hundreds of gallons of gas* the first year alone!

A pretty startling figure? It's just one of many findings from the most far-reaching tests of truck fuel economy ever made.

These tests dug out the actual facts on gas mileage the only way they could be gotten—every truck pitted against its brother in an Economy Showdown.

To keep the tests fair and impartial, Ford Motor Company went to America's leading independent automotive testing firm. The project was outlined, the funds provided, and the Economy Showdown became solely the research organization's baby.

#### FIRST TESTS—NEW '59 TRUCKS

Standard six-cylinder models of the six leading half-ton pickups first were put through exhaustive road trials. All '59 trucks—Ford and competitive—were bought from dealers, just as you would buy them. After at least 600 miles break-in, all were brought up to manufacturer's recommended specifications.

The trucks were then tested at constant speeds of 30, 45 and 60 miles an hour. Next came stop-and-go tests, ranging from moderate city traffic to normal retail delivery operation. Acceleration rates were carefully timed in each gear to insure accurate results for all makes. Here are the results—certified by America's foremost independent automotive research organization.

All tests  
conducted and results  
**CERTIFIED**  
by America's foremost  
independent automotive  
research organization\*

\*NAME AVAILABLE ON REQUEST.

Send inquiry to: P.O. Box 2687  
Ford Division, Ford Motor Company  
Detroit 31, Michigan

# Economy Showdown USA *better gas mileage!*

## CERTIFIED SHOWDOWN RESULTS

The '59 Ford Sixes, *in every test*, averaged more miles per gallon than every other make!

Combining all tests, the '59 Fords led the average of all other '59 pickups by 25.2%.

To put it another way, for every 1,000 miles driven, the '59 Fords gave an extra 252 miles *gas free*.

For the typical truck owner driving 10,000 miles annually, this would amount to a saving of 129 gallons of gas the first year alone.

HOW NEW '59 SIXES RATE IN GAS MILEAGE						
'59 FORD SIXES GIVE	25.2% more miles per gallon than Make "C"	31.1% more miles per gallon than Make "I"	9.6% more miles per gallon than Make "G"	42.6% more miles per gallon than Make "D"	22.0% more miles per gallon than Make "S"	25.2% more miles per gallon than the average of all makes
IN ONE YEAR (10,000 miles) FORD SAVES	129 gallons of gas	160 gallons of gas	49 gallons of gas	219 gallons of gas	113 gallons of gas	129 gallons of gas

## WHAT'S THE SECRET?

How can a '59 Ford Six make four gallons do the work of five in other trucks?

First, of all pickup Sixes, only Ford has modern Short Stroke design. This new type of engine is basically far more efficient than the long-stroke Sixes of other pickups—most of which were born before World War II!

Second, to this modern engine Ford has added a new economy carburetor. By metering fuel more precisely in both low- and high-speed ranges, Ford's new carburetor boosts gas mileage in every type of driving. And it's *standard at no extra cost*.

## WHAT SPEED GIVES BEST ECONOMY?

Economy Showdown tests reveal that, with any make truck, actual miles-per-gallon depend upon the kind of driving you do. In normal retail delivery operation, for example, gas mileage drops to less than half that obtained at a steady 30 miles per hour.

High speeds are hard on economy, too. At 60 mph, it takes 16 gallons to go the same distance that 10 gallons will take you at 30 mph.

You can't always tailor your driving to get absolutely maximum economy, of course. But of this you *can* be sure. No matter where or how you drive, no other leading truck will give you the gas savings of Ford's modern combination: Short Stroke Six plus new economy carburetor. Economy Showdown USA proved it!

Your Ford Dealer now has the full report of Economy Showdown USA. Why not call him today and get the whole story firsthand?

## HOW GAS MILEAGE DROPS FOR OLDER TRUCKS

Everybody knows that gas mileage falls off as a truck gets older. But how fast, how far? 499 pickups were tested. In these tests, the '59 Fords were tested without break-in.

As you can see, gas economy tends to drop sharply somewhere between the second and fourth years . . . levels off after six years. Had the new '59 Fords been broken in (as all 1959 trucks were in the tests above), they would have achieved a much greater advantage.

'59 FORD GAS MILEAGE BETTER BY			
25.6%	27.5%	24.6%	15.2%
9- to 11-year old trucks	6- to 8-year old trucks	3- to 5-year old trucks	1- and 2-year old trucks

## HOW DIFFERENT KINDS OF DRIVING AFFECT GAS MILEAGE

Here is how gas economy in various Showdown tests compared with economy at 30 mph—the point of maximum mileage.

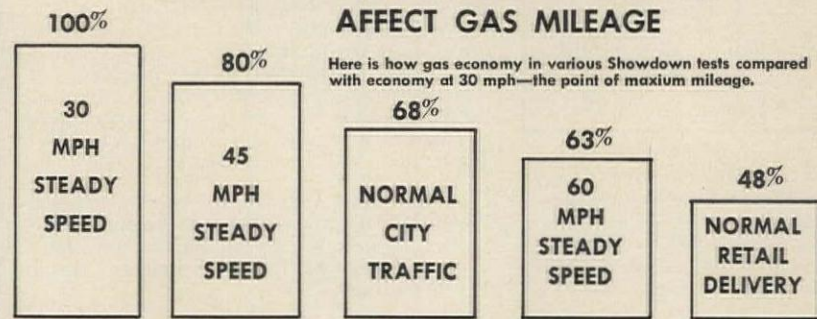

**GO FORD-WARD** for savings  
**FORD TRUCKS COST LESS**

LESS TO OWN . . . LESS TO RUN . . . LAST LONGER, TOO!

# Builders: The revolutionary "Magic Circle" Hinge makes all other hinges obsolete...and only Ready Hung Doors have it!

*2-1/2 times stronger than  
ordinary hinges*

*Positive automatic  
self-alignment*

*Non-rising Missile tip  
hinge pin*

*Beautifully styled—  
luxury finishes*

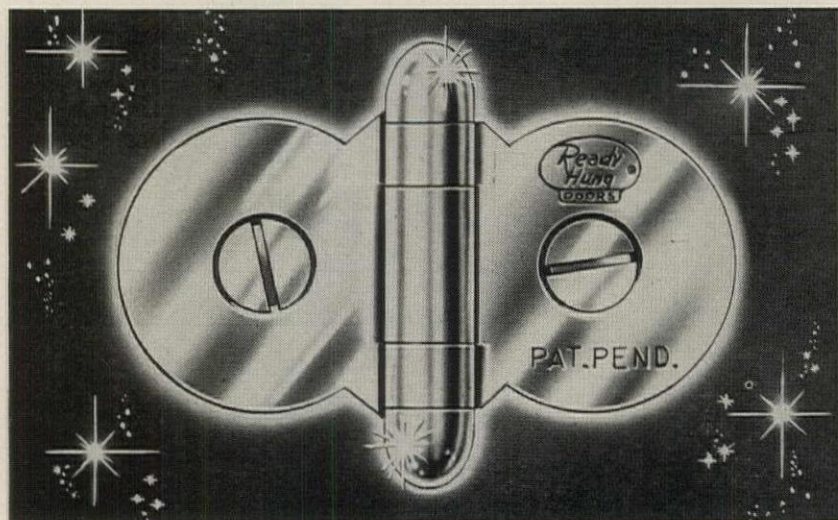

"Magic Circle" Hinges have successfully performed for the equivalent of 70 years of residential service in exhaustive laboratory tests.

Ready Hung Doors have done it again — the first new hinge idea in 200 years. The amazing "Magic Circle" Hinge gives Ready Hung Doors a quality exclusive no other door can match . . . and at no extra cost.

**2 1/2 TIMES STRONGER.** The single, large diameter screw, with its exclusive deep thread design, gives "Magic Circle" holding power 2 1/2 times greater than the ordinary 3 screw rectangular hinge.

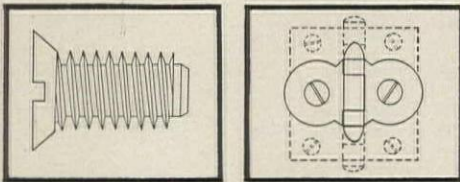

**POSITIVE SELF ALIGNMENT.** The "Magic Circle" single centered screw assures automatic hinge alignment — simply by closing the door. Prevents binding — stress on screws and hinge pins — assures permanently smooth, quiet operation.

**BEAUTIFULLY STYLED NON-RISING HINGE PINS** with missile tips, add charm and sales appeal to any home — are removable, yet "Magic Circle" has a special locking feature which prevents them from working loose.

**EXCLUSIVE ON READY HUNG DOORS.** Now Precision Engineered Ready Hung Doors come equipped with this exclusive "Magic Circle" plus. Door, with frame trimmed on both sides and hardware installed, comes completely assembled in one package—is easily installed in less than 20 minutes. Nothing to do but drive nails. Adjustable jambs adapt to any wall from 4 3/8" to 5 1/2". Units for other thicknesses available.

No other door unit . . . nor on-the-job construction can match the beauty, efficiency, and money saving features of Ready Hung Doors, with the exclusive "Magic Circle" Hinge.



"Magic Circle" Lock and Strike Plate match the charm of "Magic Circle" Hinges, without adding to the cost.

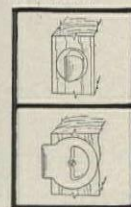

*first with  
the finest*  
in door and frame  
packaged units

PAT. NO. 2489029  
©RHD Corp.

## READY HUNG DOORS ARE MADE BY THESE LEADING WHOLESALERS

ALBANY, N. Y.  
Iroquois Millwork Corp.  
BILLINGS, MONT.  
Building Service, Inc.  
BIRMINGHAM, ALA.  
National Woodworks, Inc.  
BOSTON, MASS.  
A. W. Hastings & Co., Inc.  
Somerville 44, Mass.  
BUFFALO, N. Y.  
Iroquois Door Co.  
The Whitmer-Jackson Co.

CHICAGO, ILL.  
Morgan Sash & Door Co.  
CINCINNATI, OHIO  
Acme Sash & Door Co.  
CLEVELAND, OHIO  
The Whitmer-Jackson Co.  
Massillon, Ohio  
DAYTON, OHIO  
Dayton-Akron Sash & Door Co.  
GRAND RAPIDS, MICH.  
Porter-Hadley Co.

HOUSTON, TEXAS  
Southwest Sash & Door Co.  
HUNTINGTON, W. VA.  
Iron City Sash & Door Co.  
INDIANAPOLIS, IND.  
Midland Bldg. Industries, Inc.  
KANSAS CITY, MO.  
Rust Sash & Door Co.  
LOS ANGELES, CALIF.  
Ready Hung Door Mfg. Co.  
Burbank

MARION, IND.  
General Millwork Corp.  
NEW YORK, N. Y.  
Bailey-Whalen Co.  
West Orange, N. J.  
OAKLAND, CALIF.  
Ready Hung Door Mfg. Co.  
PITTSBURG, PA.  
Iron City Sash & Door Co.  
ROCHESTER, N. Y.  
The Whitmer-Jackson Co.

SAGINAW, MICH.  
Flint Sash & Door Co.  
ST. LOUIS, MO.  
Imse-Schilling Sash & Door Co.  
ST. PAUL, MINN.  
Minnesota Wood Specialties, Inc.  
SEATTLE, WASH.  
Tye Lumber & Mfg. Co.  
SIOUX FALLS, S. DAKOTA  
Jordan Millwork Co.

SPRINGFIELD, MO.  
Southern Supply Co., Inc.  
SYRACUSE, N. Y.  
Iroquois Door Co.  
TOLEDO, OHIO  
Allen A. Smith Company  
TORONTO, CANADA  
C. Lloyd & Son Limited  
READY HUNG DOOR CORP.,  
FORT WORTH 2, TEXAS



outstanding performance on the job...

## Glass Fibered LITE-MIX Plaster

**another** Bestwall exclusive!

No other plaster can match the performance of Bestwall's glass fibered "Lite-Mix". The even distribution of uniform glass fibers gives superior keying on open lath, greatly reduces droppings, does not ball up and dry the surface.

This outstanding product gives you continued performance too, for "Lite-Mix" fibered plaster assures constant strength, gives longer wall and ceiling life with increased crack resistance.

All three "Lite-Mix" plasters—Fibered, Unfibered and Masonry Mix—are light in weight and premixed with perlite for greater fire resistance, better thermal and acoustical insulation. Your Bestwall representative has full information on "Lite-Mix", the outstanding plaster line by Bestwall.

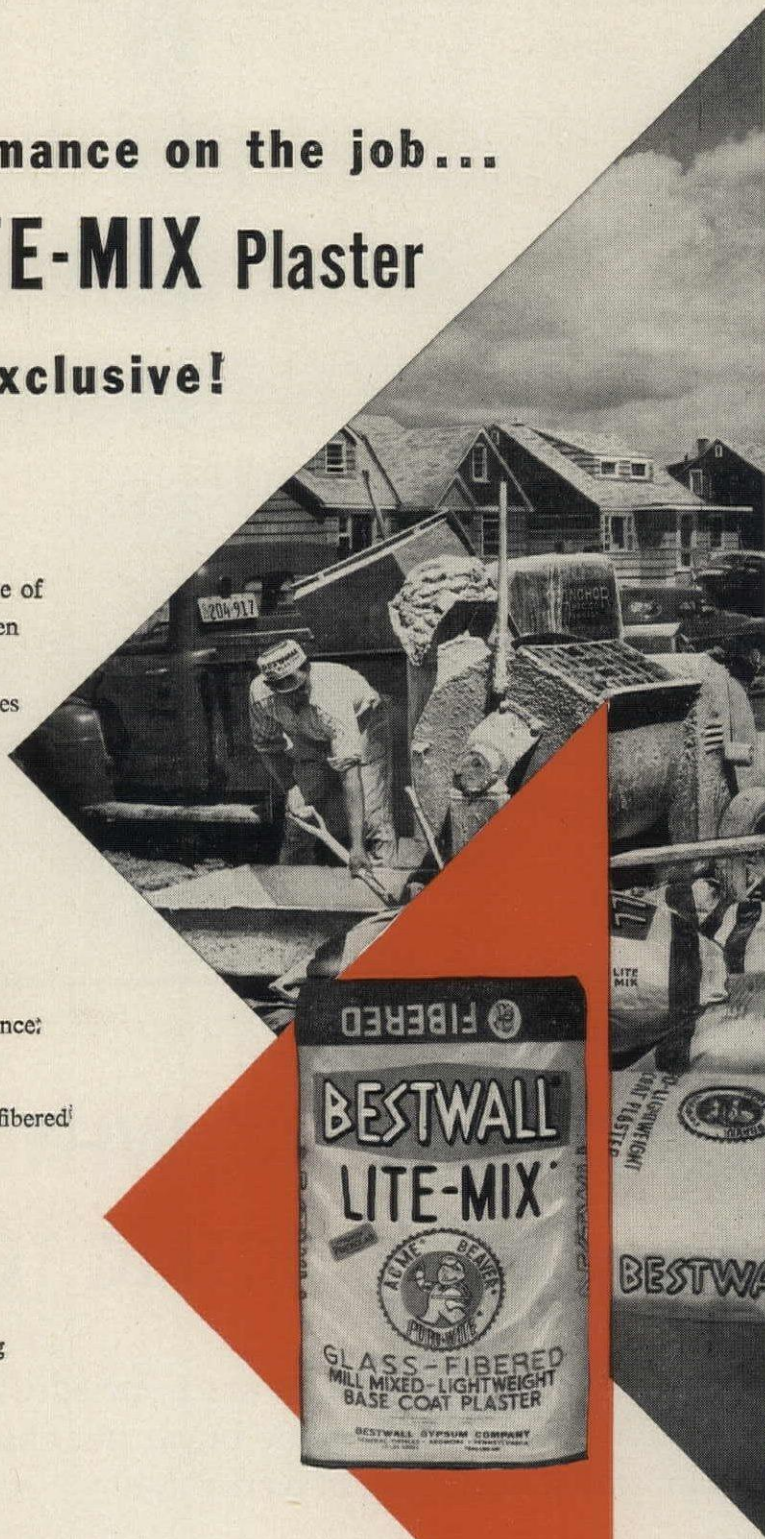

BESTWALL GYPSUM COMPANY • Ardmore • Pennsylvania • Plants and offices throughout the United States.

# Textolite Ideas



## 4 GOOD REASONS WHY IT PAYS TO SHOW GENERAL ELECTRIC TEXTOLITE® TOPS

... the same 4 points you want to be sure of  
when you're offering your home buyer her choice of  
laminated surfacing patterns and colors

**1** Will your prospect find a color and pattern she likes? She's bound to, because Textolite gives so many choices. Only Textolite can offer 12 matchless woodgrains, 5 marbles, 7 Heyday and 11 Ming patterns ... plus the 6 fabulous new Spungolds!

**2** Will she accept the brand? With Textolite, she has to—because Textolite is made by General Electric—one of the world's best-known manufacturers!

**3** Can you promote it? Textolite is now being pre-sold to your prospects in the most concentrated advertising and promotion campaign the industry has ever seen! Tie-in

possibilities are limited only by your imagination!

**4** Will you get delivery in time for the job? With Textolite, you will, because complete stocks are warehoused right in your area!

For more good reasons why it pays to show Textolite tops, see the full line of Textolite patterns and colors in the 1959 Sweet's Light Construction File, Catalog 9a/Ge. Or write to: Laminated Products Dept., General Electric Co., Box 495, Marion, Ohio, for a free, full-color line folder. And for answers to any questions you might have, call your Textolite distributor. (He's listed in the Yellow Pages under "Plastics.")

**Textolite**®  
LAMINATED SURFACING  
GENERAL  ELECTRIC



The Chateau, luxury model in National Homes Viking line. Sliding windows and doors, produced by Capitol Products Corporation, Mechanicsburg, Pa., are made with quality Olin Aluminum.

## How Olin Aluminum service helped launch the fastest selling homes in America

Assignment: Start from scratch. With nothing but a builder's blueprint to work from, design, manufacture and deliver in 13 days a completely new type of window for the Viking Fairlane Home. That's how Mayfair Industries, depending on Olin Aluminum service, captured a substantial window order from National Homes.

Quickly, we developed dies and produced extrusions in our Gulfport, Mississippi Plant . . . and the pilot lot of single-hung and unique top-pivoted picture windows were manufactured and rushed from Mayfair's Lafayette, Louisiana Plant to National Homes in Lafayette, Indiana. **All this in 13 days.**

Whether you have "impossible" deadlines to meet . . . or just need a regular shipment of mill products, call your nearby Olin Aluminum Sales Office or Authorized Distributor. Metals Division, Olin Mathieson Chemical Corporation, 400 Park Ave., New York 22, N. Y.



*New Standards of Quality and Service in the Aluminum Industry*

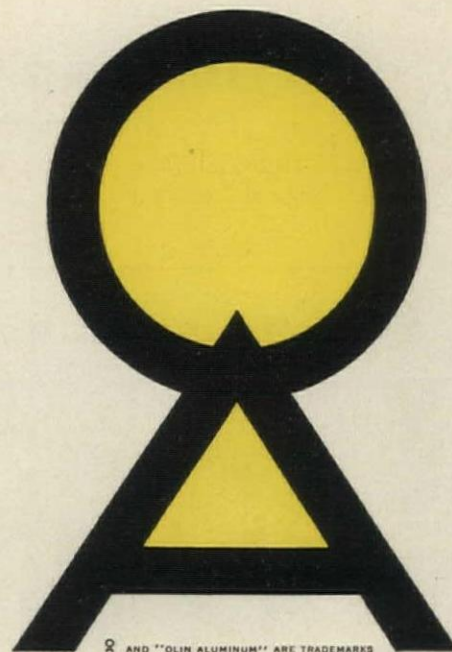

® AND "OLIN ALUMINUM" ARE TRADEMARKS

# Cincinnati Builder provides effective home cooling with R&M-Hunter Fans



Ray Sharp of Sharp & Isfort, leading Cincinnati builders, is past president of the Ohio Home Builders Association.

## "Much less expensive than air conditioning" says Builder Sharp

Sharp & Isfort, builders of quality homes in the Cincinnati area, are big boosters for R&M-Hunter Ventilating Fans. Mr. Sharp says:

"R&M-Hunter Fans provide cool comfort for home owners without the big initial expense and operating cost of air conditioning equipment. Every buyer of our homes has been more than satisfied with the results produced by this modern ventilating system. In the ten years we have used R&M-Hunter Fans, there has been no service problem whatever."

**Every size and style of house** can be cooled with an R&M-Hunter Fan. Certified air deliveries range from 5200 to 22500 cubic feet per minute. 1959 line includes single-speed and two-speed models. Prices start at \$127 list. Look in Sweet's File for complete data. Consult your local phone book for name of nearest distributor.



### VENTILATING FANS

*The peak of quality*

HUNTER DIVISION • ROBBINS & MYERS, INC.

2856 Frisco Ave., Memphis 14, Tenn.



Mrs. Janet Metscher (above) is one of the many satisfied owners of Sharp & Isfort homes with R&M-Hunter Fans.

### 3 WAYS TO INSTALL R&M-HUNTER VENTILATING FANS



**1.** In normal installation, R&M-Hunter Fan (Package Type) is placed on attic floor with automatic shutter in hallway ceiling.

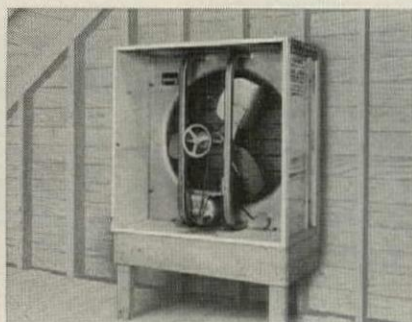

**2.** In gabled homes, where attic is airtight, the "A" Type Fan can be mounted as shown to discharge directly to outside.

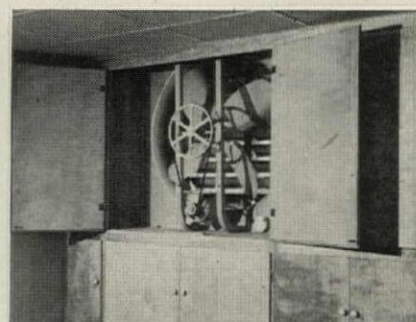

**3.** Where the attic space is limited, fan may be installed in basement or sidewall for efficient whole-house ventilation.

# Roundup:

## Will 5¼% VA loans trigger another boom?

Will this be one of housing's best years? The best two in history—1950 and 1955—boomed to 1.3 million on easy-money VA no-down payment mortgages. Now, many a builder is optimistically predicting another '50-'55-like boom if the VA interest rate is boosted to 5¼% (see p 42). They have company. NAREB President James Udall and Kenneth G. Heisler, managing director of the Natl League of Insured Savings Assns, also see 1.3 million as a good possibility. HOUSE & HOME's Revised 1959 forecast: about 1,250,000 starts (see p 51).

The outlook is not without a few clouds. Items: 1) mortgage bankers are already predicting tighter money, warning that VA 5¼ mortgages may be selling at a 5½ point discount by mid-June in the South, Southwest and West, and 2½ everywhere else but New York and New England (see p 64); 2) New York Savings bankers report an ominously high percentage of washouts on commitments, meaning sales in many areas have not kept up with starts; 3) housing starts in January dropped to a seasonally adjusted rate of 1.35 million, down from 1.43 in December—a fact some housing economists argue means the upsurge in housing has crested.

## Norman Mason shakes up top echelon at HHFA

New HHFA Administrator Norman Mason is surprising many old Washington hands with the scope of his sweeping and shuffling in the government housing agencies (see p 103). Since he succeeded Al Cole in January he has: 1) pushed Cole's deputy, Walker Mason, onto a shelf labeled vice president of FNMA; 2) brought up his ex-special assistant at FHA, Walter Rosenberry (a fellow lumber dealer) to replace Mason; 3) exiled Cole's assistant administrator for programs, Annabelle Heath, to San Francisco as a regional administrator; 4) brought in Henry O. Talle, defeated GOP representative from Iowa (and ranking Republican on the House housing subcommittee), to replace Miss Heath; 5) fired popular and able Justin Herman, a Democrat, as regional administrator in San Francisco to make a berth for Miss Heath.

There's a good reason for such moves—besides the pressure of politics. Mason, a shrewd administrator, is taking no chances of having his administration undermined by key men from someone else's team. Not sweeping out the old hands has been cited often as one of Al Cole's mistakes.

## Should FHA insure loans for land development?

FHA has proposed that the Administration ask Congress for legislation to let FHA insure mortgages for developing of raw land. Such a program, many economists contend, might slow the soaring costs of acreage by bringing more of it into competition for housing sites.

FHA's proposal envisages loans limited to 50% or, at the most, 75% of land valuation. The plan is not in Administration housing proposals so far because it was presented to the Budget Bureau too late. But insiders say it may still be offered to Congress. FHAides realize "the risk would be great" in such loans. So local FHA offices would set wide leeway in handling them.

## Building Trades Boss Gray stays on—for a while

Independent and crusty old Dick Gray, head of the AFL-CIO Building Trades Dept, will not be retired—as widely rumored before the department's mid-winter meeting in Miami Beach. The presidents of the building trades haven't been able to agree on a successor. Gray, now 72, has been tagged for retirement since the department's convention in December 1957. He then publicly proposed a one-year wage moratorium—an idea the individual union presidents refused to consider.

## Builders excluded from group studying lower labor costs

Union building trades and general contractors have agreed on a joint search for ways to cut construction cost. Though housing represents a third of US construction, homebuilders are not being asked to participate.

The "joint industry committee" was formed in Miami Beach at the AFL-CIO Building Trades Dept midwinter meeting. Members include the unions, AGC and National Contractors Assn, whose 19 giant members specialize in heavy construction.

The unions would like homebuilders represented, if only to start a national liaison which might help local organizing efforts in open shop towns. AGC blocked the idea. It argues the committee was started so labor and contractors could make joint cause for contracting-out in industrial plants. More and more industries are doing their own contracting, using their own industrial workers.

Homebuilders may still benefit from an attack on costs though it will hardly mean lower hourly wages. But as one builder points out: "There are a lot of things besides wages the committee can tackle. If the unions get serious, they can increase productivity 5 to 10% easily."

NEWS continued on p 42

## NEWS INDEX

Housing policy.....	42
The 1959 housing bill.....	42
Housing market.....	51
VA comeback likely.....	54
Market briefs.....	61
Local markets.....	61
Mortgage market.....	64
Views on the news.....	69
Opinions.....	69
Segregation.....	73
Urban renewal.....	83
NAHB convention.....	86
The fight over FNMA Program 10.....	86
Convention briefs.....	87
Chance for tax savings.....	91
Materials & prices.....	98
People.....	103
Close-ups: FHA's Zimmerman.....	103
Canada.....	111
Statistics & indexes	
Housing starts.....	54
FHA & VA applications.....	54
Mortgage quotations.....	65
Union wage rates.....	95
BLS materials prices.....	98
Boeckh housing costs.....	98

# FOUR SLIDING GLASS DOORS FOR

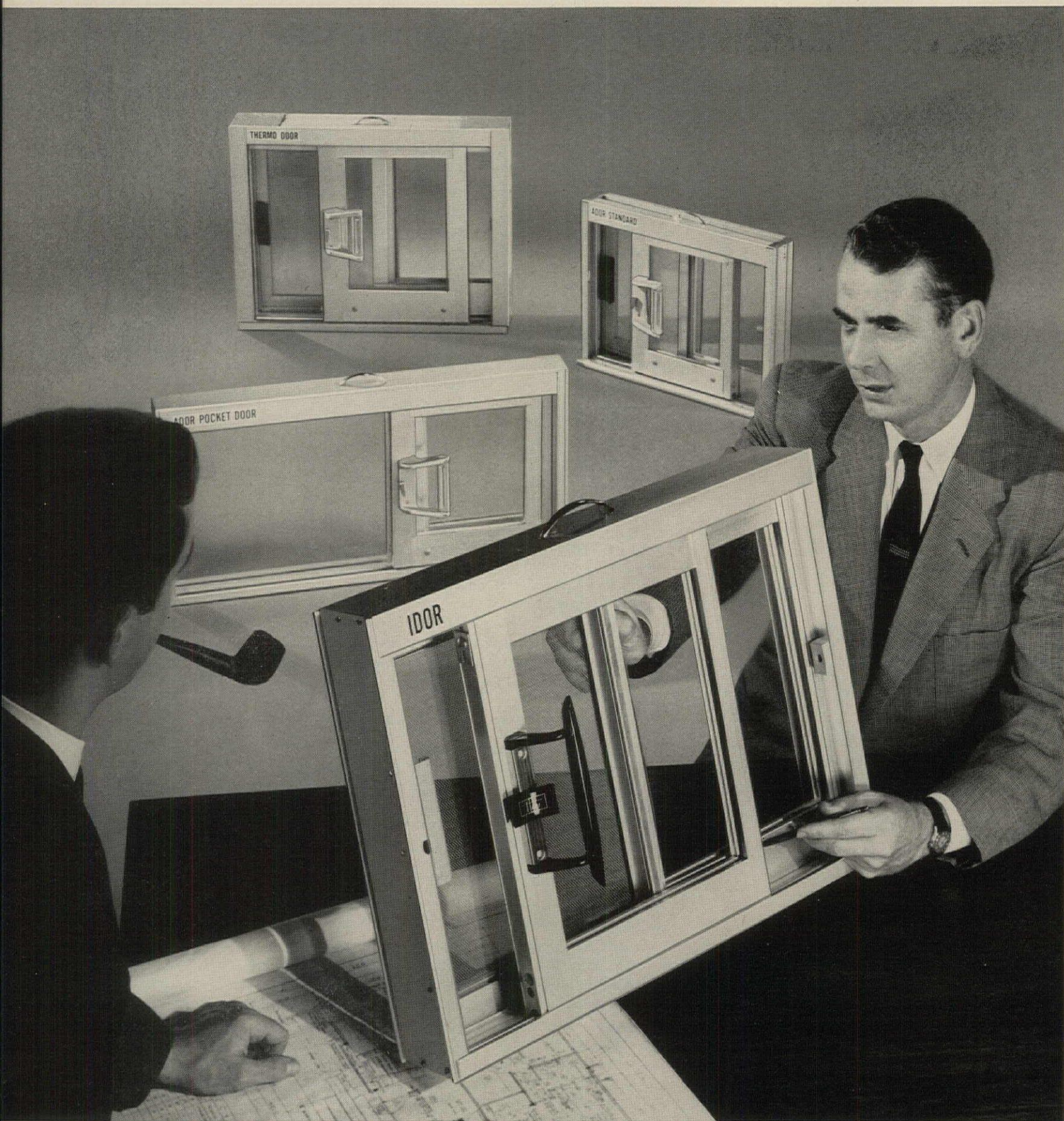

First complete line of sliding glass doors for every type of installation is found in these four basic designs by Ador. In foreground is the new budget-priced Idor. In background (front to rear) Ador Flush Threshold "pocket" Door, Ador luxury look Standard Door, and insulated Thermo Door for 1" dual glazing.

# EVERY DESIGN NEED

## Ador offers first complete line of sliding glass units

Widespread use of sliding glass doors has focused new attention upon the specification of sliding units. A variety of door designs are called for to meet today's special requirements of climate conditions, widely ranging price consideration, and differing types of construction.

Unique in the sliding glass door field is the Ador line—first with a complete line of quality doors. Every conceivable installation need is answered by four carefully engineered Ador door designs:

- 1. Custom Feature Standard Ador**—with its fine design and quality details offers today's greatest value in an aluminum sliding glass door.
- 2. Flush Threshold "Pocket" Ador**—For multiple sliding or pocket installation, permits all sections to slide out of sight.
- 3. Insulated Dual-Glazed Thermo Door**—First sliding glass door designed exclusively for 1" dual glazing to assure year around comfort in extreme climates, hot or cold.
- 4. Budget-Priced Quality Feature Idor**—completes the Ador line, is a startling new product which offers all the important extra-value quality features at a low "best-buy" price.

Exclusive complete-line selection is evidence of Ador's continuing design leadership. All units, regardless of price, incorporate positive 4-way weatherstripping, beautiful custom design hardware, finger-tip easy operation and cleanly designed rigid tubular aluminum construction.

For specifications and literature write to Ador Sales, Inc., 2345 West Commonwealth Avenue, Fullerton, California. Or call your local Ador dealer or distributor.

*Ador*

America's foremost all-aluminum sliding glass door



Latest Ador design is the Idor, first lifetime aluminum sliding glass door to provide 10 important quality features at a smart budget price. Exclusive new decorator hardware compliments every room.

Living comfort is assured by the Thermo Door with fully insulated frame and 1" dual glazing. Controls heat loss in winter; lowers air conditioning costs in summer.

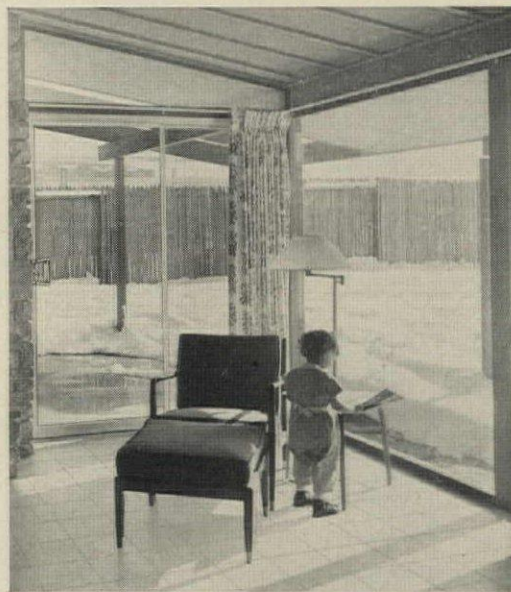

Multiple sliding "pocket" installation is the Ador Flush Threshold door shown in this smart studio salesroom. Threshold sets in slab or mounts on sub floor.



Preferred 2 to 1 over all other aluminum sliding glass doors is the Standard Ador; here a dramatic wall of glass is formed by doors and matching transoms.

## What the Senate & House housing bills provide

### Senate (as adopted Feb 5)

**VA**—Boosts interest ceiling from 4¼% to 5¼% and repeals 1958 law requiring VA rate to be ½% below FHA 203 (b) rate. Authorizes \$150 million more for direct loans. Extends privilege of automatic guaranty to mortgagees certified under FHA-CAP who are also approved by VA. Lets VA blacklist builders or lenders if FHA has done so.

**FHA authorization**—Boosts it \$5 billion until June 30. Provides another \$5 billion for fiscal 1959-60 but cancels unused authorization from expiring fiscal year after June 30.

**FHA sales housing (mortgage limits)**—Keeps Sec 203 at \$20,000 for 1-family houses, but boosts it from \$20,000 to \$25,000 for 2-family houses. Keeps present \$27,000 limit for 3-family houses, \$35,000 for 4-family units. Boosts Sec 203 (i) from \$8,000 to \$9,000.

**FHA trade-ins**—Makes non owner-occupants (eg builders and realtors) eligible for same loan-to-value ratio as owner-occupants provided 15% of loan goes in escrow until property is sold to owner-occupant. If not sold in 18 months escrow funds go to reduce loan.

**FHA interest rates**—Boosts ceiling from 4½% to 5% on Sec 207 rental, 213 management co-op, 803 military, 229 old folks, 810 defense area loans—with additional permission for FHA to go to 5½% if money market requires. Keeps basic 5% ceiling for 213 sales co-ops but lets FHA go to 6% (as for 203s) if money market requires.

**FHA rental housing**—Boosts per-unit and per-room mortgage limits as follows:

	PRESENT LAW		SENATE BILL	
	Per room	Per unit*	Per room	Per unit*
Garden type .....	\$2,250	\$8,100	\$2,500	\$9,000
Elevator type .....	2,700	8,400	3,000	9,400
Boost in high cost areas ....	1,000	....	1,250	....

\* If under four rooms

**FHA insurance premium**—Not in bill.

**FHA Sec 220 (urban renewal)**—Boosts mortgage limit for sales housing from \$20,000 to \$22,500 for 1-family units, from \$20,000 to \$25,000 for 2-family units, from \$27,500 to \$30,000 for 3-family units. Boosts limits for rental projects to conform with 207. Lets FHA change loan ratio for rentals from 90% of replacement cost—assuming the other 10% is for profit—to 100% of replacement, excluding profit and risk allowance. (FHA now requires 3% cash equity by sponsors. Bill leaves this to agency discretion. To prevent windfalls, cost certification is retained.) Lets FHA exclude landscaping costs from statutory room and unit cost limits for multifamily rentals, while including them in the mortgage.

**FHA Sec 221 (relocation of displacees)**—Boosts maximum loan from \$9,000 to \$10,000 per unit in normal areas, from \$10,000 to \$12,000 in high-cost areas. Makes 2, 3 and 4 family structures eligible for first time, with mortgage limits of \$18,000 (\$20,000 high cost areas), \$25,000 (\$27,500) and \$32,000 (\$35,000), respectively. Lets FHA include community and commercial facilities to serve needs of occupants under mortgage. Broadens eligibility to include displacees in "environs" of cities with workable programs.

**FHA Sec 213 (co-ops)**—Restores co-ops' advantage over sales housing terms by boosting loan ratio from 90 to 97%—of replacement cost. Lets FHA include community and commercial facilities under all types of co-ops (only management-type are now eligible).

**FHA Sec 231 (old folks housing)**—Creates new Sec 231 with 100% loans for nonprofit sponsors and 100% loans (excluding profit allowance) for others. Abolishes old program for housing the aged under Sec 207.

**FHA nursing homes**—Under Sec 231, lets FHA insure loans up to \$12½ million each up to 75% of value at 5-6% interest for convalescent and nursing homes.

**FHA repair loans (Title I)**—Extends program 1 year to Sept 30, 1960.

**FHA military housing**—Extends program 1 year. Extends maximum amortization from 25 to 30 years. Creates new Sec 810 for loans to essential civilian employees of armed forces on 203 and 207 terms—a virtual revival of old Title VI.

**Federal Natl Mortgage Assn**—Authorizes no new funds. Boosts maximum mortgage purchasable in secondary market program from \$15,000 to \$20,000, but retains \$15,000 limit for special assistance (except for 220s, which become eligible up to the FHA insurance ceiling—eg \$18,500 plus cost of nondwelling facilities for high-cost area rentals). Revives par purchase for special assistance loans until Aug 1, 1960.

**VHMCP**—Extends it another two years.

**Foreclosures**—New authority lets FHA extend time granted an owner to cure defaults. Lets FHA take an assignment of a defaulted loan in lieu of foreclosure. Lets FHA include defaulted interest in debentures.

**Urban renewal**—Provides 6 year, \$350 million-a-year program, but requires this to be boosted by \$150 million-a-year any year when applications exceed \$350 million. Effect is two year, \$500 million-a-year program.

**Public housing**—Authorizes 35,000 more units. (With carryover of 16,000 units authorized but not under contract, this would permit about 51,000 more units.) Strips PHA of power to set income limits and rents in projects, leaving this to local authorities subject only to a "statutory ceiling." Waives 20% rental gap for displacees. Lets over-income families stay.

**College housing**—Authorizes \$300 million more for loans at same subsidized interest formula—with \$50 million for non residential structures and \$50 million for housing nurses and interns.

### House (as reported by the housing subcommittee)

**VA**—Same interest rate boost as Senate, but in separate legislation which also: 1) authorizes \$300 million for direct loans, 2) repeals tie-in to FHA rate, 3) requires builders to keep deposits from buyers in separate accounts, 4) provides complete blacklisting reciprocity between VA and FHA and 5) lets FHA-CAP mortgagees make VA-guaranteed loans.

**FHA authorization**—Boosts it \$6 billion expiring July 1, but provides only \$4 billion for the entire fiscal year 1959-1960.

**FHA sales housing**—Boosts mortgage limit for Sec 203 to \$25,000 for 1- and 2-family homes. Cuts down payments in middle price ranges (from 15% to 10% on portion of valuation between \$13,500 and \$16,000, from 30% to 10% from \$16,000 to \$18,000 and from 30% to 25% above \$18,000). Boosts amortization from 30 to 35 years. Boosts Sec 203 (i) mortgage ceiling from \$8,000 to \$9,000 and makes existing units eligible for first time, but with 90% loan-value ratio for units not inspected during construction by FHA or VA.

**FHA trade-ins**—Same as Senate.

**FHA interest rates**—Boosts 207 to 5%, but no change for 213 or 803.

**FHA rental housing**—Boosts dollar limit on mortgages from \$12½ million to \$20 million. Boosts loan ratio from 90 to 95%. Boosts per room and per unit ceilings 10 to 30%—to \$2,850 per room for garden units, to \$3,315 per room, for elevator units, and to \$9,500 per unit for small elevator apartments.

**FHA insurance premium**—Lets FHA—at its discretion—cut it to ¼%. (Present law gives FHA leeway from ½ to 1%.)

**FHA Sec 220**—Makes same changes as for 203 on mortgage ceilings, down payment, trade-ins. Boosts mortgage limits of 220 rental to correspond to 207.

**FHA Sec 221**—Boosts maximum mortgage same as Senate. Shifts valuation basis for nonprofit-sponsored rental 221s from value to cost. Creates new 221 rental program for profit-making groups with 90% loans based on cost (if new) or value (if rehabs).

**FHA Sec 213**—Boosts dollar limit on loans from \$12½ million to \$20 million. Boosts per-room and per-unit ceilings to correspond with 207 boosts. Boosts loan ratio from 90 to 97% of cost (85 to 90% for investor-sponsored co-ops and from 95% to 100% for co-ops with 50% veterans). Lets community facilities be included in sales co-ops (now restricted to management-type). Lets both community and commercial facilities be included in investor-sponsored co-ops (now restricted to management-type). Lets existing dwellings be co-op'd.

**Old folks housing**—Sets up \$100 million direct loan program under HHFA (but does not appropriate funds). Forces HHFA to make 98%, 50 year loans at subsidized 3½% rate to nonprofit groups. Defines "elderly" as 62 or over.

**FHA nursing homes**—Creates new nursing home section, but limits loans to 75% of value and to \$1 million, at 5%.

**FHA repair loans**—Same as Senate.

**FHA military housing**—Extends program to Sept 30, 1960. Extends amortization same as Senate. Requires payment of time-and-a-half for overtime on Capehart projects. Requires Defense Dept, when taking over Wherry Act units, to make deposit in court equal to FHA replacement cost when mortgage was issued, minus unamortized debt. Creates new Sec 810 as in Senate version.

**FNMA**—Boosts maximum purchasable loan from \$15,000 to \$18,000 for secondary market, to \$17,500 for special assistance. Authorizes standby commitments for existing houses. Revives mandatory par purchase for special assistance until Sept 30, 1960 (but exempts recent months when this has not been law). Cuts commitment and purchase charges for special assistance from 1½ to 1%, and slices required initial payment for a commitment from half of total to quarter. Boosts special assistance fund for 213 co-ops by \$25 million for current fiscal year and \$50 million for next year, with half earmarked for consumer co-ops, half for builder "co-ops." Prohibits exchange of FNMA liquidating portfolio mortgages for government bonds, as planned by Administration.

**VHMCP**—Same as Senate.

**Foreclosures**—Same as Senate.

**Urban renewal**—Provides \$500 million a year grants for 3 years through fiscal 1960-61. Boosts relocation payments to individuals from \$100 to \$200, for businesses from \$2,500 to \$3,000.

**Public housing**—Authorizes about 280,000 more units, at 35,000 a year. Ends requirement that rents be 20% of income, lets local agencies set them. Cuts 20% rental gap to 10% for displacees. Would not let over-income tenants stay.

**College housing**—Authorizes \$400 million more at same interest rates, with \$40 million reserved for cafeterias and student centers and \$40 million for housing nurses and interns.





**SENATE HEARINGS** found government spokesmen struggling to sell the President's housing plans to a largely hostile banking committee. Listening to a question from the left wing of the Democratic side of the horseshoe-shaped committee table are (l to r): Urban Renewal Commissioner Richard

E. Steiner, Community Facilities Commissioner John Hazeltine, Acting Deputy FHA Commissioner Beverley Mason, HHF Administrator Norman P. Mason, Public Housing Commissioner Charles E. Slusser, President J. Stanley Baughman of Federal Natl Mortgage Assn.

## New profits in the new housing bill

Higher interest rates for VA, rental FHA units, bigger Fanny May loans will expand markets

The 1959 housing bill, at least in the form in which it passed the Senate February 5, is loaded with new ways builders can make more profit. And this is still very close to the form in which the legislation is most likely to emerge from Congress.

The squabble between President Eisenhower and Congress over spending for urban renewal, college housing, public housing and VA direct loans has captured the headlines. But it has obscured much of the measure's real significance to industry.

As these lines were written, even the most seasoned of housing pundits backed away from predicting whether Congress would ultimately come up with legislation the President would veto on spendthrift grounds. The Democratic leadership of Congress was doing an adroit job of compromising just enough to make it harder and harder for the President to veto the bill. At mid-month, some key GOP Congressmen were betting that Ike will sign it, reluctantly.

Biggest shot in the arm for housing (and almost the only one well reported by the daily press) has now passed both Houses of Congress, but in different form. It is the boost in the legal ceiling for interest on VA guaranteed home loans from 4¾% to 5¼%. This will rescue the VA program from death by slow strangulation from lack of money. Many builders optimistically prophesy it means a 10 or 15% boost in 1959 housing starts. Mortgage men, less prone to inflated optimism, are not so sure (*see p 54*). The truth may well lie somewhere in the middle.

At least seven other new ways to make more money are in the two versions of the 1959 law. Items:

- **Trade-in financing** under FHA is eased so significantly it will probably convert the fledgling trade-in business from a necessary nuisance to a leading sales feature of new homes. The change is supported by

all political factions and would have become law last year if an omnibus housing bill had been adopted. It lets non-owner occupants (ie, builders or realtors) qualify for the same high percentage mortgage as owner-occupants, provided 15% of the loan is put in escrow until the house is resold. If the house remains unsold after 18 months, the 15% is applied to reduce the mortgage. Biggest boost from the change will be the end of double closing costs from rewriting mortgage loans when builders resell houses taken in trade.

**Easier FHA terms:** The Senate bill boosts the maximum mortgage ceiling for two-family homes under FHA's main Sec 203 from \$20,000 to \$25,000, which will help builders of duplexes. The House subcommittee bill goes further, boosts the 203 ceiling to \$25,000 for *both* one- and two-family homes. This is a step long urged by most elements of the industry; since

1934, the FHA ceiling has risen only 56%, while costs have trebled. The House bill would also chop FHA down payments sharply in the \$15,000 to \$20,000 house brackets. (*See opposite page for details on this and other features of the pending law.*) For instance, an \$18,000 FHA house would require only \$855 down instead of \$1,380; a \$20,000 FHA house would require only \$1,355 down instead of \$1,980.

**Higher interest rates** on FHA rental, cooperative and military housing will make them financable without today's discounts of 3 to 8 points—so high they are beginning to choke off construction, especially of Sec 207 rentals. The Senate would let 207 go up a full 1%, to 5½%; the House 5%. This should give rental building a big shot in the arm, especially with . . .

**Higher cost limits for Sec 207:** the Senate version boosts the per-room cost ceilings by \$250 for garden apartments, \$300 for elevator apartments. It raises the extra allowance for designated high-cost areas from \$1,000 to \$1,250-a-room. The House proposes even bigger (10 to 30%) increases, despite FHA opposition. Moreover, the House would raise the loan ratio to 95%, which ought to guarantee that an efficient operator could build rental units with only 3% cash investment (because FHA would impose that much equity requirement administratively as it now does for Secs 213 and 220). Cost certification, of course, will continue to prevent windfalls.

**Bigger Fanny May loans:** the Senate voted to boost from \$15,000 to \$20,000 the maximum FHA or VA loan Federal Natl Mortgage Assn can buy. Industry has long

*continued on p 47*

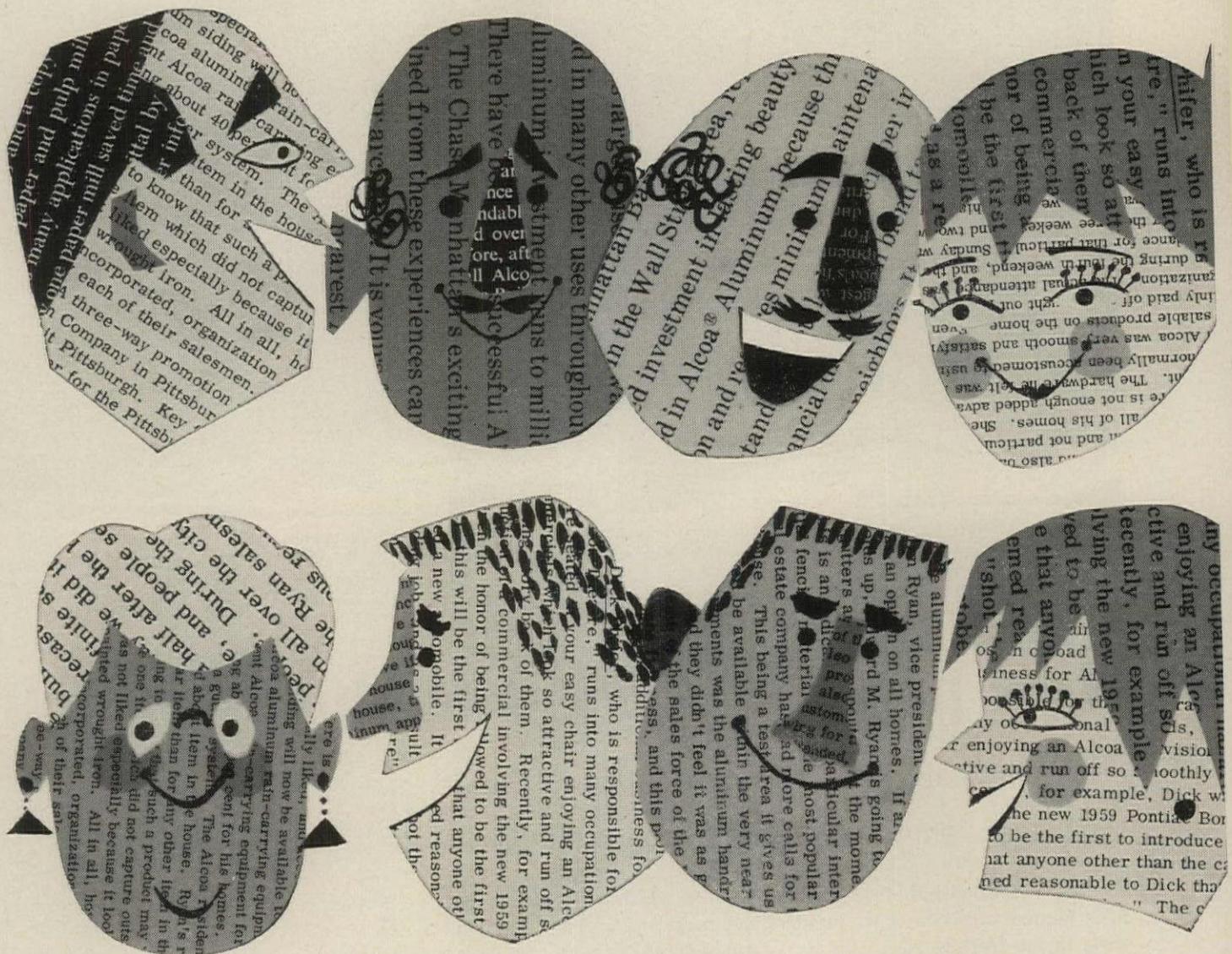

# THIS YEAR THE BIG NEWS IS FROM

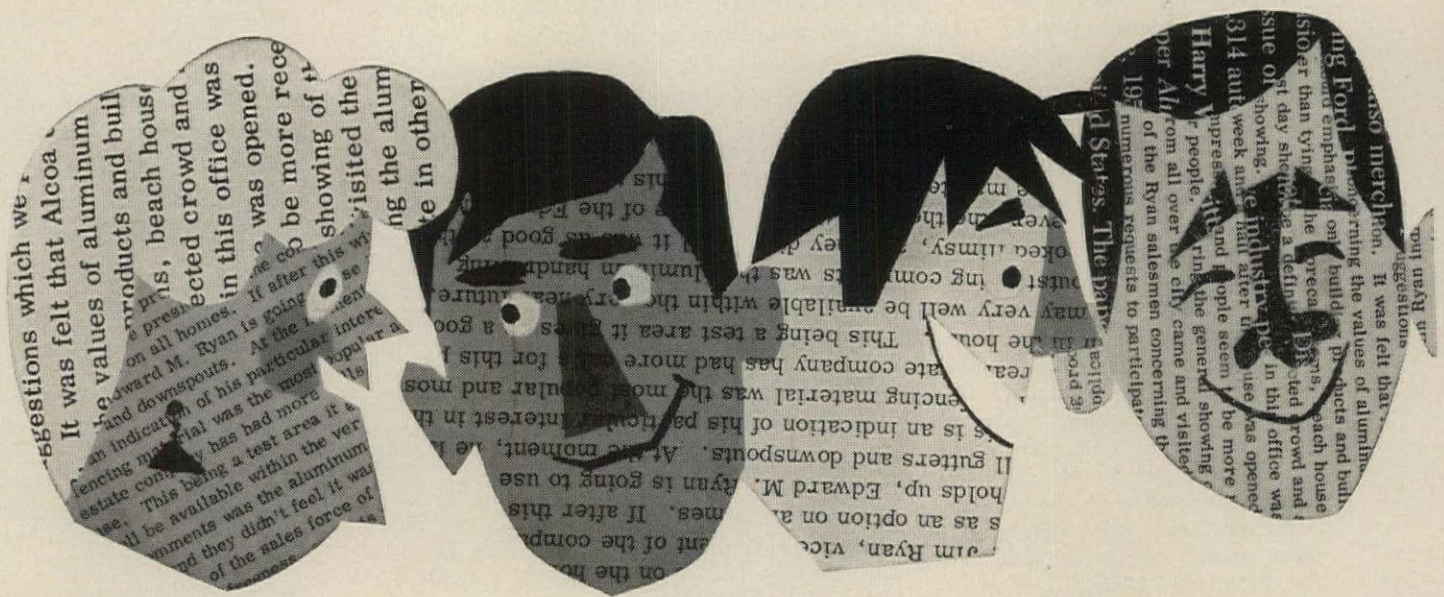

# Giant Sales Boost for Dealers Selling Building Products of Alcoa Aluminum

ALCOA'S '59 PROMOTION TO REACH 67,000,000—PLUS!

**PITTSBURGH, PA.**—Aluminum Company of America has launched a mammoth new promotional campaign to help manufacturers and dealers sell more awnings, screens, windows, doors, insulation, hardware and other building products made of Alcoa® Aluminum.

With a combination of network radio, national consumer advertising, two network television shows and dealer displays, Alcoa will bring the story of lighter, brighter living to prospects and buying influences across the nation.

## ALCOA BUYS EIGHT FULL WEEKS ON NBC—"MONITOR"

**PITTSBURGH, PA.**—On March 21, Alcoa began a schedule of 80 five-minute vignettes on *Monitor*—the top-rated NBC radio program that reaches an estimated total audience of over 16,000,000 every week end.

The theme of the vignettes is: Better Homes for a Better America. These vignettes consist of interviews with important spokesmen in the building industry and related fields. One minute and twenty seconds of each vignette is devoted to the Alcoa commercial message. Ten vignettes are scheduled per week end for eight continuous weeks.

## TIE-IN OPPORTUNITY

Dealers and manufacturers can exploit this sales-building promotion to direct prospects right to their doors by purchasing adjacent spots through their local NBC stations. It means they will be contacting prospects at the moment they're thinking about a new home or home modernization.

## ALCOA SCHEDULES ADS IN HOUSE & GARDEN AND SUNSET MAGAZINES

**PITTSBURGH, PA.**—More than 1,000,000 readers of *Sunset* and *House & Garden* magazines will read about Care-free building products of Alcoa Aluminum

every month during the selling season. Included will be thousands of actual prospects, all of them looking for the Alcoa Care-free tag as a guide to lighter, brighter living.

## TWO ALCOA NETWORK TELEVISION SHOWS BRING THE CARE-FREE STORY TO 50,000,000

**PITTSBURGH, PA.**—During 1959, the popular *Alcoa Theatre* and the new dramatic show, *Alcoa Presents*, will feature hard-hitting commercials on residential building products of Alcoa Aluminum.

Many thousands of actual prospects will be among the audience of over 50,000,000 watching these shows over 200 or more stations. Dealers can cash in on a preconditioned market by purchasing spot announcements before or after the show. Details are available from local NBC and ABC stations.

## ALCOA OFFERS FREE STORE DISPLAY FOR DEALERS

**PITTSBURGH, PA.**—To help dealers tie in with its big '59 promotion, Alcoa has made available a colorful mobile display free of charge.

Intended to act as a reminder to sales people, as well, the display's outstanding value is in establishing dealers as headquarters of Care-free building products of Alcoa Aluminum. Local Alcoa sales offices have full details.

Your Guide to the Best in Aluminum Value



For Exciting Drama Watch "Alcoa Theatre," Alternate Mondays, **NBC-TV**, and "Alcoa Presents," Every Tuesday, **ABC-TV**

# ALCOA

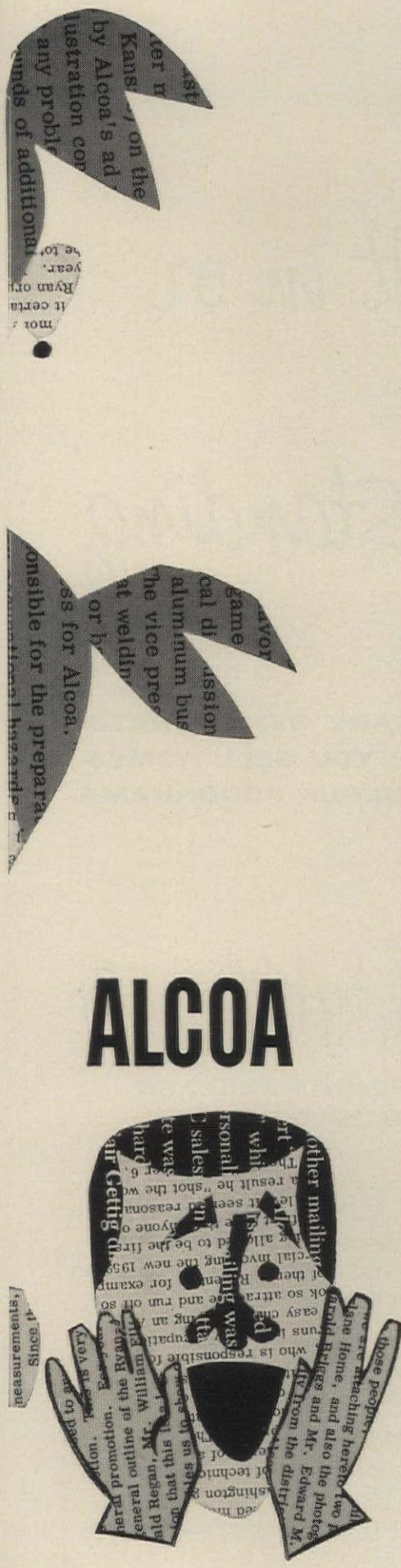



*built-in or*

*free-standing*

**NO ORDINARY REFRIGERATOR  
CAN HELP YOU SELL HOMES  
LIKE FABULOUS FOODARAMA**

*fabulous* **FOODARAMA** *by Kelvinator*

**A 12 CU. FT. DELUXE REFRIGERATOR AND A 6 CU. FT. UPRIGHT FREEZER  
ALL IN ONE CABINET ONLY 41" WIDE, 63" HIGH AND 25" DEEP**

With a family-size home freezer in just 10 inches more space than needed by an ordinary refrigerator, Fabulous Foodarama by Kelvinator actively contributes to your selling story. It gives your homes advantages your competition can't touch! And with handsome square-corner

styling and fan-cooled mechanism, Foodarama can be built-in *completely!* It costs much less than the valuation you can place on it. Be the first in your area to profit by the sales and publicity advantages only Foodarama can give you. Send for the complete story today.

**SELL HOMES FASTER WITH AMERICA'S MOST ADMIRER, MOST DESIRED APPLIANCE.**

**BUILT BETTER TO SERVE BETTER**

***Kelvinator***

Division of American Motors Corp., Detroit 32, Michigan

American Motors Means  More For Americans

Live Better Electrically 

**MAIL THIS COUPON TODAY!**

**KELVINATOR DIVISION, Dept. HH-3  
14250 Plymouth Road, Detroit 32, Michigan**

Please send complete details of the Special Foodarama Builder Plan.

Name \_\_\_\_\_

Company \_\_\_\_\_

Street \_\_\_\_\_

City \_\_\_\_\_ State \_\_\_\_\_

## New housing bill: big shots in the arm for co-ops, Secs 220, 221

continued from p 43

urged this move as being in line with today's costs. The House would hike the limit only to \$18,000. Another new gimmick in the House version—this one opposed by the Administration—would extend the standby, FNMA commitment to existing houses. Up to now, it has been confined to new building. Real estate men want old homes included so they will have complete assurance FNMA will actually buy a loan. They don't now, because the agency often changes its rules as to the type of house and locations it will accept.

**FHA co-ops** get an astonishing shot in the arm, despite a warning from new FHA Commissioner Julian H. Zimmerman that the House version, at least, will "encourage high cost or luxury type construction with virtually no down payment." The Senate bill restores co-operatives' once-traditional edge over 203 sales housing. Under it, a builder could sell a \$20,000 house for \$600 down with a 40-year mortgage. Today, he must get \$1,000 down. His competitor down the street, selling under Sec 203, must get \$1,980 down on a \$20,000 FHA house, and can offer only a 30-year loan, which means higher monthly payments. Moreover, co-op loans are based on replacement cost, while 203s are appraised on reasonable value. Both Senate and House would let 213 sales co-ops include community facilities—a further preferential treatment.

Big Builder John F. Long of Phoenix pleaded eloquently for this one. He argued that it will help builders avoid putting up tomorrow's slums: "Communities all over America are being rapidly developed without any provisions for recreational areas because the builders cannot afford to donate such facilities and the municipalities are not financially able to furnish them at the time they are needed. The result is . . . thickly populated and overbuilt subdivisions. These, like their predecessors can easily become blighted areas."

Long reported that after he donated a 15-acre park at his Maryvale tract in Phoenix juvenile delinquency dropped 50% in seven months, according to local police. And the cost? "A 30-unit project could be served by a one-acre park with

swimming pool (for) \$5.14 per month for each co-op member for debt retirement and maintaining the park."

**FHA urban renewal** building gets every incentive short of windfalls in the Senate bill. No. 1 is a boost in the maximum FHA Sec 220 mortgage for one-family houses from \$20,000 to \$22,500. This would spur builders to put up more costly homes under Sec 220 than any other FHA program—another, if small, instance of how housing legislation is being warped to serve social instead of economic goals. For rental 220s, the Senate bill would make it clear that FHA can include both commercial and community facilities in the mortgage. This seems to say that if the project is big enough, the government might underwrite the risk of building a profit-laden shopping center to serve it.

### Pro forma yelps

With all these goodies in sight, home builders understandably have muffled their complaints about features of the bills they disapprove. NAHB President Carl Mitnick squawked to the banking committee, for example, about all the public housing in the Senate bill. But it struck onlookers as pro forma howling. Builders want a bill badly, and in a hurry. This good natured exchange of sallies illustrates the tone:

**SEN CLARK:** I suggest that perhaps you stress the point a little too far, when you say that what is good for your association, is necessarily good for the country at all times. I happen to think it is, but it is a little hard to identify yourself with General Motors.

**MITNICK:** I introduced myself as a builder, and I certainly am just that.

**SEN CLARK:** Maybe what we ought to do is just change your anti-recession bill of last year and call it an anti-inflation bill this year and pass it.

**MITNICK:** If you pass it, we would not care what you call it.

### No pipeline to the Treasury

One business booster that isn't in either the Senate or House measures is more

money for Fanny May's controversial special assistance Program 10.

Inclusion of Treasury-financed mortgage loans at subsidized prices looked to Congressional leaders like a sure way to invite a Presidential veto. Moreover, Chairman John Sparkman (D, Ala.) of the Senate housing subcommittee, father of this anti-recession boost for cheap new homes, is on record that it would be unwise to continue it. Chairman Albert Rains (D, Ala.) of the House housing subcommittee had another \$1 billion of par money for Program 10 in his version of the 1959 legislation. But the subcommittee deleted it.

### Brinksmanship, housing-style

By mid-month, Congress' effort to devise a bill President Eisenhower will swallow had produced some whittling of original proposals to boost US commitments to pour money into housing programs. The Senate cut the college housing loan fund from \$400 to \$300 million, deleted entirely a \$125 million revolving fund for guaranteeing college loans, sliced the VA direct loan authorization in half from \$300 to \$150 million.

The House, however, voted for a \$300 million direct loan kitty. In all, the Senate voted some \$1.8 billion more spending authority than the President wants. Democrats argue only about \$200 million of it will be spent during the next fiscal year. But that is enough, reply Republicans, to put Ike's budget out of balance.

The Senate bill has a provision letting over-income tenants stay in public housing. PHA points out this could lead to legal attacks on the constitutionality of state laws authorizing local housing authorities. The problem is that almost all the state laws say their aim is to provide housing for low-income families. If Congress converts public housing into a middle-income program, opponents might be able to wreck it in state courts.

NEWS continued on p 51

### FOUR WITNESSES WHOSE PROVOCATIVE IDEAS STIRRED HOUSING HEARINGS



Photos: H&H staff

**BALANCE THE BUDGET** by letting Fanny May sell debentures, pay back the Treasury \$1.2 billion locked up in FNMA's management & liquidating portfolio, urged Lender Charles Wellman. FNMA's \$100 million M&L surplus could cover gap between 3.6% yield of mortgages and 4¼% on debentures.



**CUT HOUSING COSTS** by stabilizing its volume, instead of letting it become the first victim of Federal Reserve moves to tighten money to balk inflation, urged Economist Robinson Newcomb. He noted that "costs have dropped very sharply" in roadbuilding, where public aid is "very stable."



**CHANGE BOOKKEEPING** on urban renewal from authorization to appropriations, urged former Mayor Charles P. Taft of Cincinnati. Reason: this will reveal how little of huge sums under discussion can be spent in any one year. "You can't move people that fast," he argued, so \$6 billion will last over 17 years.



**COMPEL INTEGRATION** by federal fiat, urged Frances Levenson, executive director of Natl Committee Against Discrimination in Housing. She charged urban renewal is "actually harming" minority families' housing chances, called federal acquiescence in local patterns of segregation "unconstitutional."

Now is the time to sell

# IQ

INDIVIDUALITY  
AND  
QUALITY

sell both...at a good profit...with the  
CURTIS IQ program

Who's willing to live in a "look-alike" house? Fewer and fewer families. More home buyers today can afford a house with a distinct personality, one that meets their particular needs, one they can really be proud of.

**You can give them individuality with Curtis doors and windows...97 different window styles and combinations...88 different door styles to distinguish your designs.**

There's a big demand for quality, too. HOUSE & HOME reports a "shortage of more than 15 million better homes that people could now afford to buy...a shortage of quality homes even bigger than the shortage of shelter right after the war."

**You can step into this market with Curtis guaranteed quality doors and windows. Millions know the Curtis name; millions prefer Curtis quality.**

Now is the time to let Curtis help you build a reputation for homes of individuality and quality. Get in on the Curtis I.Q. profit-building program right away. The coupon will bring full details.



J. E. Merrion and Co., award-winning Chicago builder, uses Curtis double-hung windows to help sell the individuality and quality of its Country Club Hills homes.

# CURTIS has the sales tools to boost your profits



**NATIONAL ADVERTISING**  
a big schedule of full-page, full-color advertising in *Better Homes & Gardens*, plus full-page advertisements in *New Homes Guide* and other consumer building manuals.



**CURTIS GUARANTEE CERTIFICATE**  
a powerful sales-making tool, as many builders have found!



**BUILDER AWARD PLAQUE**  
certifying you as a quality builder who brings home buyers a high degree of individuality of design with quality materials and workmanship.



**IDEA BOOKLET**  
sketches and ideas for builders to use in staging a unique, new model-home promotion.



**SALESMEN'S SALES CLINCHER**  
a display folder giving facts and figures proving that it pays to buy a quality home, based on a realtor survey.

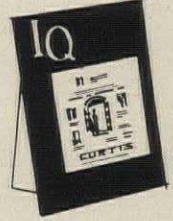

**POINT-OF-SALE DISPLAYS**  
national ad display easel...window stickers... signs to identify your model homes... plus literature, ad mats, radio and TV scripts, publicity and other localized sales helps.

**Make this your big-profit year  
Mail the coupon today!**

# CURTIS

**Individuality and Quality in doors, windows  
and FashionWood kitchens**

Curtis Companies Incorporated  
200 Curtis Building, Clinton, Iowa

HH-3-59

I want to know more about Curtis I.Q. plan for more sales and profits.

- Please have your representative explain the plan to me.
- Send full information.

Name.....

Address.....

City..... Zone..... State.....

HELPS YOUR SALESMEN SELL BETTER, SELL FASTER

# New SELL-A-HOME program sells every feature in your model home



## KEEPS CUSTOMERS SEATED TILL THE BINDER IS SIGNED!

After the customers have seen the model, the salesman can show them *pictures* of any feature of the home they'd like to see, then complete his sales talk (with help from the selling booklet) and present the binder for a signature.

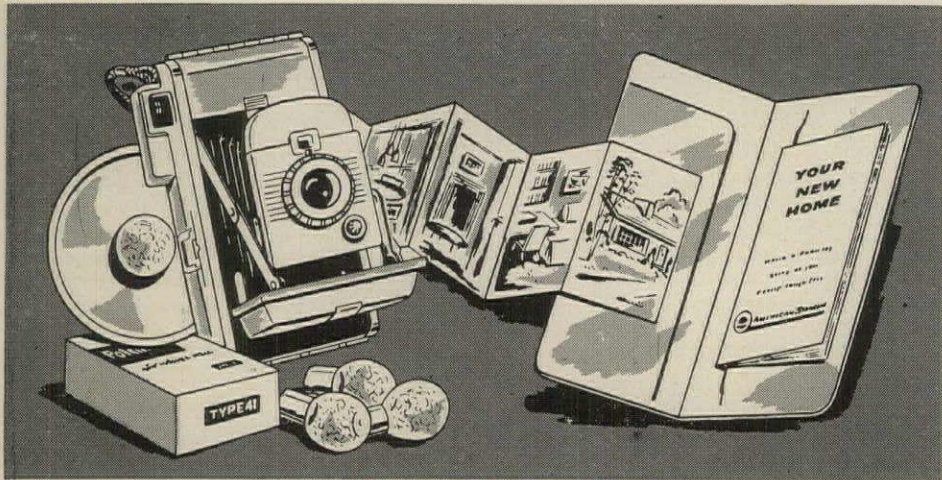

## LOOK WHAT YOU GET IN THE SELL-A-HOME PROGRAM!

First, a Polaroid camera, to take pictures of the home, of prospects and of features they'd like to remember. Second, a supply of film and flash bulbs. Third, a wallet presentation for your salesmen, with a pull-out picture folder and the new custom-tailored selling booklet "Your New Home."

## Picture-story presentation is custom-tailored to the homes you are selling

The Sell-A-Home program helps *any* salesman—beginner or old pro—sell better than ever!

Here's what's in the Sell-A-Home program. You get a wallet presentation for each of your salesmen. The wallet contains the new room-by-room selling booklet, "Your New Home," and a fold-out sleeve for photos. You get a Polaroid camera and a supply of film and flash bulbs.

Using the Polaroid, you take pictures of all the important features that make your home a real buy. You put copies of the pictures into each salesman's wallet. Now he can show a customer *any* feature he wants to see, *any time* during the sales talk.

Next, you write in each salesman's selling booklet information on the standout features of your model home. (The book reminds you, room by room, of all the features you should mention, and suggests selling arguments your salesman can use on customers.)

**Sell-A-Home was the talk of the Chicago Builders' Show!** Hundreds of builders signed up for additional information at the show. To find out how *you* can get in on the Sell-A-Home program, get in touch with your American-Standard Air Conditioning Division distributor, or send in the coupon below—today!

American-Standard Air Conditioning Division  
40 W. 40th Street, New York City

Sirs: Your Sell-A-Home program sounds interesting. Please send me more details and tell me how I can get in on the program.

Name \_\_\_\_\_

Company \_\_\_\_\_

Address \_\_\_\_\_

City \_\_\_\_\_ Zone \_\_\_\_\_ State \_\_\_\_\_

AMERICAN-Standard and Standard® are trademarks of American Radiator & Standard Sanitary Corporation



# AMERICAN-Standard

AIR CONDITIONING DIVISION



## HOUSING MARKET:

**Project design is 'dreary, unimaginative,' AIA wails**

Long simmering discontent inside AIA with the Public Housing Administration has erupted at last into an open break.

The nation's 13,000 organized architects thus aligned themselves with labor, public housers and local officials in attacking the PHA regime of Commissioner Charles E. Slusser. They have not, they made clear, stopped espousing public housing.

What bothers architects was outlined to the Senate banking committee by J. Roy Carroll Jr, FAIA, of Philadelphia:

- Current projects, with few exceptions, are "dreary, unimaginative masses that can hardly be characterized as architecture." This is not architects' fault. Rather it is unimaginative administrative interpretations of PHA regulations which "strait jacket the architect." Designing public housing has become so frustrating few architects are even interested in trying. "Public housing is bogged down in an administrative morass."

- Professional contracts architects must sign on public housing projects are unfair. For example, "an architect can be held responsible for additional costs resulting from unfavorable site and soil conditions. Often these conditions are not known to the architect, nor to anyone else, when he enters the contract."

- "The fee schedule is entirely inadequate and should be junked." It is not attractive enough to bring the competent and dedicated architects public housing needs.

Carroll's recommendation: PHA should make "an exhaustive study of its policies, procedures and regulations . . . The program needs a complete overhauling, not just a few minor revisions . . ."

Sen Prescott Bush (R, Conn.) questioned whether his views really represented all architects, Carroll testified: "Over 60% of the complaints received at The Octagon (AIA headquarters) involve PHA . . . and we deal with about 75 or 80 federal agencies."

Sen Joseph Clark (D, Pa.) inquired how long ago AIA began complaining to PHA about "cumbersome and unfair" contracts. Replied Executive Director Edmund R. Purves: "We started making protests, I think, a good ten years ago."

Sen CLARK: I see. Thank you.

Two weeks later, PHA mustered this reply:

- *Architects* for public housing are picked, not by PHA, but by local authorities. "PHA has never been given a detailed bill of particulars either by local authorities or architects indicating their specific criticisms of the . . . relationship."

- *On delays:* most of them arise from "fundamental problems" like 1) lack of cheap enough vacant or slum sites, 2) local citizens' objections to sites in some neighborhoods, 3) consequent delays by local governments in choosing controversial sites.

- *On administrative practices:* PHA "follows normal procedures for construction of buildings by public agencies."

- *On contracts:* PHA requires no more architect responsibility "than is customary in the building business."

- *On fees:* "Many architects state the PHA fee schedules are adequate provided no excessive local delays occur." Carroll's AIA committee agreed last October to "submit specific complaints," but still hasn't.

**1959 reforecast—homebuilding will have best year since 1955**

Miles Colean boosts his original prediction; expects momentum from '58 plus conventional financing vigor to push starts over 1.2 million

Housing will have a better year in 1959 than it did in 1958—though not much. But it *will* be the best year since 1955.

Private starts should climb to something between 1,160,000 and 1,190,000 this year (vs 1,130,600 in 1958). Add in 60,000 public starts (including Capehart Act military housing) and the 1959 total should be between 1,220,000 and 1,250,000 (vs 1,197,000 last year). This is up slightly from HOUSE & HOME's September forecast of 1,215,000 starts for 1959 (1,155,000 private, 60,000 public).

Basic strength of private housing depends upon the momentum already set up by 1) the heavy volume of outstanding FHA-VA commitments, 2) the vigorous advance of conventional financing and 3) rising personal income.

Last year, conventional and all-cash financing accounted for 733,100 units, a gain of 37,000 over 1957. Due especially to the exceptional growth of the assets of savings & loan associations and mutual savings banks, conventional financing should produce even more starts in 1959 than in 1958. A solid 760,000 from this source and all-cash financing now seems sure.

The uncertainty this year, as in other years, centers on FHA and VA housing. Together they should account for between 400,000 and 430,000 starts. But what Congress finally does about VA's politically-frozen interest rates (see below) could shift the total as much as 50,000 units either way.

**One-family starts to soar**

Single family houses will account for most of the overall increase in starts this year with 975,000 units. Another 35,000 units will be built in two-family buildings and 160,000 in multi-family structures.

Unless Congress frees, or at least raises, fixed VA and FHA interest rates to make these mortgages acceptable in today's money market, all predictions may miss their mark. (The Senate has voted to raise the VA rate to 5¼% and boost the rate on Sec 207, FHA's primary rental program, from 4½ to 5%.)

Without increases, the VA program will continue to wither away; and the volume of rental housing will be artificially restricted to a level less than that of 1958.

**Needed: FHA rate boost**

But this is not the whole problem. The statutory interest ceiling on FHA home mortgages is already 6%. But the Administration has continued to hold the level at 5¼%, in spite of the substantial discounts at which insured mortgages have been selling (see *Mortgage Quotations*, p 65).

When (or if) FHA will adjust its rates more realistically to the current market no



**FORECASTER COLEAN**

Only "if" is Congress

one can be sure. There seems no chance that the market will adjust itself to the established rate as it did last spring after the Fed loosened money rates to fight recession.

The result will be less money available for housing and more uncertainty about housing production. FHA's inability to make firm commitments due to depletion of insuring authority adds to the uncertainty.

**Happy hangover**

No. 1 item working to prop up housing this year is its 1958 momentum. It provides an exceptionally strong counter-force to possibly unfavorable developments later on.

Last year's second half boom pushed private starts for 1958 to 1,130,000 (BLS preliminary estimate)—60,000 higher than the HOUSE & HOME forecast of 1,070,000

Reasons for the higher production last year were: 1) the relatively favorable relation between fixed interest rate FHA loans and the general interest rate structure and 2) the \$1 billion of par purchase special assistance funds for low priced houses through FNMA.

The latter financed an estimated 60,000 units started last year equalling the gap between the forecast and actual performance. Public housing starts of 67,500 were only slightly over the 65,000 forecast.

NEWS continued on p 54



*"my masons like*

# KEYWALL

GALVANIZED MASONRY JOINT REINFORCEMENT

*best"*

That's the conclusion of



The National Wax Company has 41,000 sq. ft. of floor space in its new headquarters in Skokie, Illinois. Ragnar Benson engineers specified Keywall in every concrete masonry course outside and as a tie for the brick facing. Keywall was specified in every other course for interior walls.

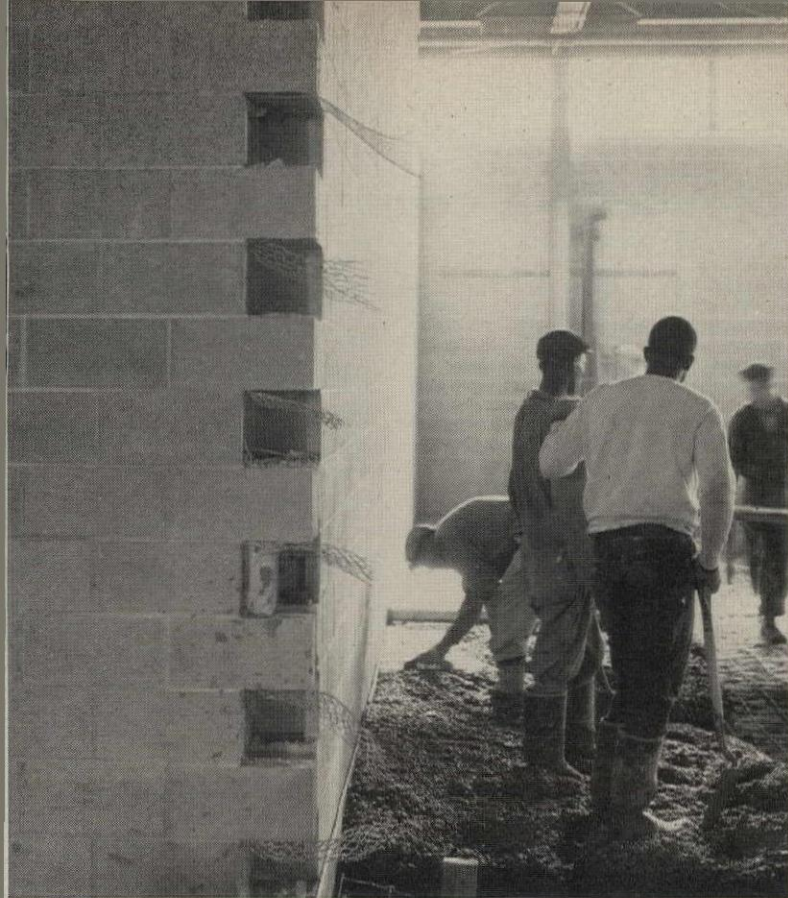

When partition walls are to be built later, Keywall may be cut to extra length to serve as a wall tie. Then Keywall ends may be moved out of the way until needed. Smooth edges of Keywall won't cut or tear hands.

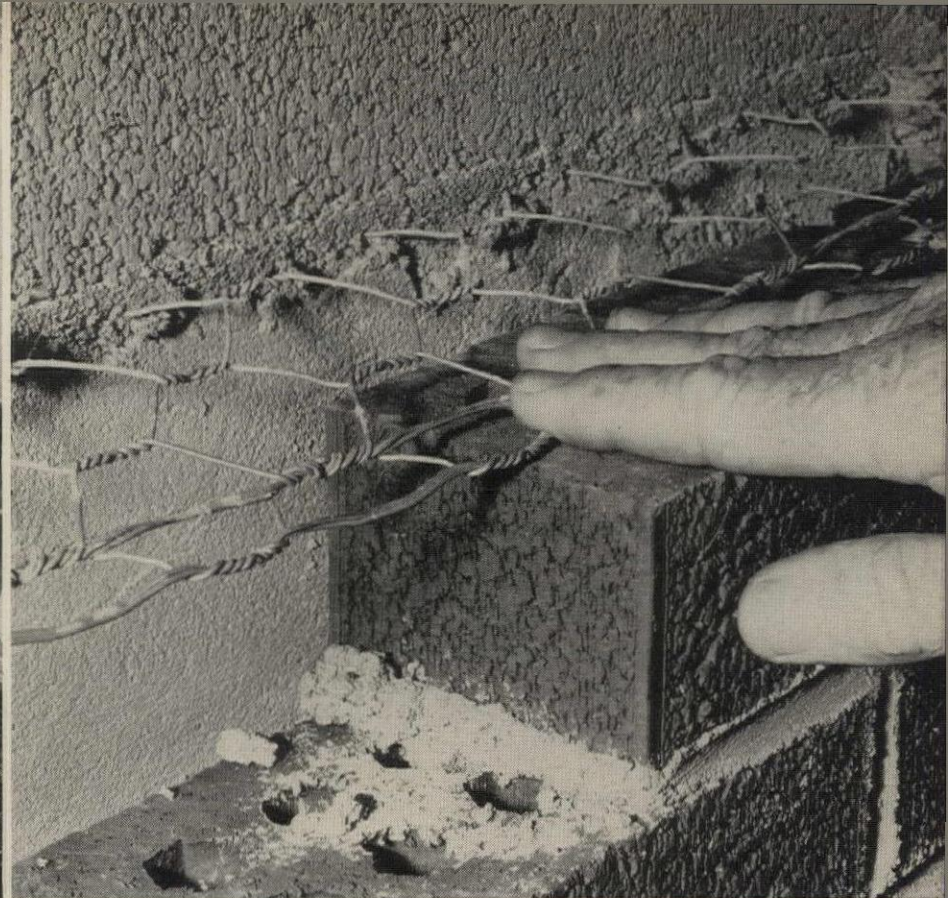

Note how readily Keywall adjusts to variation in brick and masonry courses. Here it serves as tie between brick and block.

**Joe Alberti, masonry superintendent,  
Ragnar Benson, Inc.,  
Chicago Engineers-Builders**

Mr. Alberti, as well as his masons, is enthusiastic about this new joint reinforcement. Ask one, Joe Wittye, for his opinion, "I'd use Keywall in my own home." Then ask Ragnar Benson designers, "We're specifying Keywall wherever masonry reinforcement is needed."

You get the same enthusiastic agreement whenever you go on a job where Keywall was used. Architects have seen its superior ability to reduce shrinkage cracks. Its design assures full embedment and strong bond. Masons prefer to use Keywall. They use it as specified. Keywall takes little space on the scaffold. Unrolls in place on the wall. Cuts easily. Installation is fast—without waste. No wonder that on job after job, builders are switching to Keywall.

## **KEYSTONE STEEL & WIRE COMPANY**

Peoria 7, Illinois

Keycorner • Keybead • Keymesh • Keywall • Welded Wire Fabric • Nails • Non-Climbable Fence

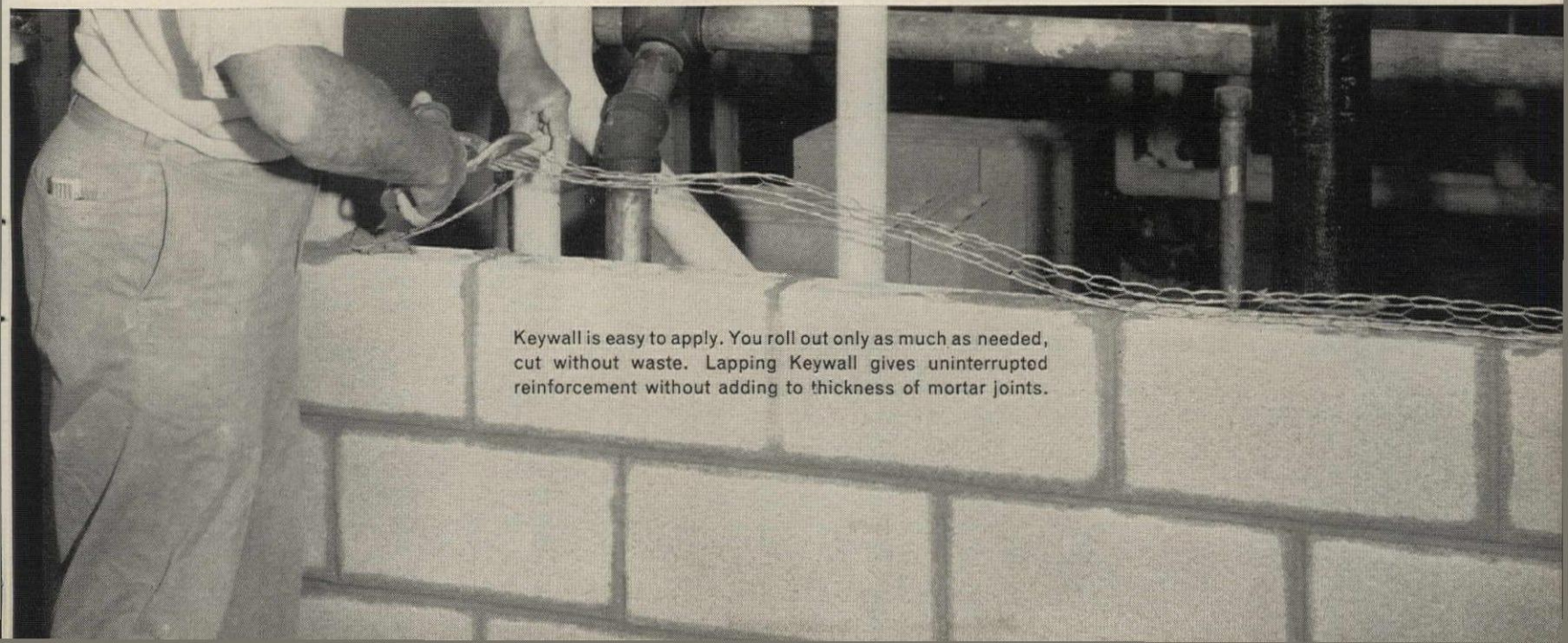

Keywall is easy to apply. You roll out only as much as needed, cut without waste. Lapping Keywall gives uninterrupted reinforcement without adding to thickness of mortar joints.

# Builders predict 5 1/4% rate would produce VA comeback

Most forecast 10 to 15% more starts would result this year. Some mortgage bankers are skeptical

By John Senning

VA housing, which has looked dead no fewer than three times in three years, seems poised for another comeback.

If the interest rate boost from 4 3/4% to 5 1/4% already approved by both houses of Congress becomes law, most builders and about half the mortgage men expect VA to regain its past prominence. And to big tract builders, who equate the GI program with their greatest years (1950 and 1955), few prospects sound juicier.

A HOUSE & HOME survey of top housing markets in the US shows that most builders predict revival of VA will boost starts this year 10 to 15% above the level they would reach if VA stays at 4 3/4%. Some VA deals, of course, would be at FHA expense.

But the chance of a VA upsurge is producing optimism even before it is a fact. NAREB President James Udall and Kenneth G. Heisler, new managing director of the Natl League of Insured Savings Assns, both predict starts will reach 1.3 million this year. This would make 1959 one of housing's three biggest postwar years.

On the other hand, Frank Cortright, former NAHB executive vice president, now a mortgage broker and builder in San Francisco, expects the rate boost will only help homebuilding maintain its 1958 pace. "Without it," he adds, "we'd have fallen off substantially." He estimates an unworkable VA interest rate would cut sales as much as 20 to 30% this year.

There are more pessimistic viewpoints. Many a housing man shares the feeling of Mortgage Banker Donald McGregor, executive vice president of Houston's T. J. Bettes, who does not expect to see more than 1 million private starts this year.

He questions whether the public will buy any more homes than this. So does Mortgage Banker Hector Hollister of Frederick W. Berens, Inc of Washington D.C., who comments: "Last year we had money running

out of our ears; yet builders still have not used up the money they got then."

Not one mortgage man queried by HOUSE & HOME predicts without reservation that 5 1/4% will even be a competitive rate for all of 1959 (see p 64).

## Back to the fold

A rate boost would bring back into VA many builders who have quit it entirely for FHA—some more than two years ago. An example: Dick Carmody of Dallas who quit VA in disgust because of too-high discounts in 1956. His comment now: "On the basis of the bill [to raise the interest rate] I'm gambling a deposit on 49 lots on which I intend to build VA homes."

Other builders who were about to give up VA now plan to stay in. Says Gene Fisher

of F&R Construction Co in Miami: "We had planned to get out of the VA program entirely and go to a cheaper FHA program. But if the rate goes up . . . we will ask for both VA and FHA."

And Giant Builder Tom Lively, president of Centex Construction Co of Dallas, Chicago, and Hawaii admits he was sweating: "We are just at the point where we cannot afford to build GI at all. Last year 7% of our [2,261] starts were VA. This year we are planning 3,000 but without VA we would have to cut back 30%."

A boost in the VA rate would stop rigging the money market in favor of cheap houses. Last year, much VA production was priced at \$13,500 or less because it was financed under the Fanny May \$1 billion special assistance program 10 which had a \$13,500 limit. Big discounts on the private money market made any other VA financing unattractive.

"Now," predicts one eastern investor, "activity is sure to shift to what the private market [lenders] wants in houses."

## Many stay with FHA

Many onetime VA builders say they will stay with FHA and/or conventional financing they developed while VA was moribund. Among them: 1958's biggest homebuilding firm, the Mackle Co of Florida. Says Frank Mackle, one of the three Mackle brothers: "We couldn't be less interested [in VA]. We have gone entirely to the FHA program and I doubt that we will ever get back into VA housing. The Mackle Co is now in the retirement house business."

Builder Clayton Powell of Savannah, who is pioneering the use of components and other technical innovations (H&H, Feb '58), finds it hard enough to win approval for his pace-setting plans with one agency—FHA. Says Powell: "Having to work with two agencies in a situation like ours is like having two wives."

Bob Fox, one of two brothers-partners in Fox-built homes of Plymouth Meeting, Pa, notes that his firm used to build VA. But now it has moved into a higher price range (\$20,000 and up) and will stay with FHA and conventional loans which require some equity.

Builders in New Jersey, Philadelphia, Indiana and Portland are considering a return to VA, but not with much pleasure. In all three areas, they complain, VA appraisals are too low, processing is marked by nit-picking. Says a Portland builder: "VA is too hard to work with and they're getting worse this year. Last year I sold about 20% of our homes under VA but I plan none this year whether or not the rate goes higher."

## Unhappy about rate boost

Not all builders who have been building VA are overjoyed with the prospect of lower discounts.

Bernard Janis of Janis-Mank Construction Co, Miami, who started 400 homes last year, 70% of them VA, complains: "Personally I am not for the increase to 5 1/4% because it will bump the monthly payments. We have enough trouble now qualifying buyers. That extra \$5 is going to keep the average veteran from qualifying. We are going to think in

continued on p 61

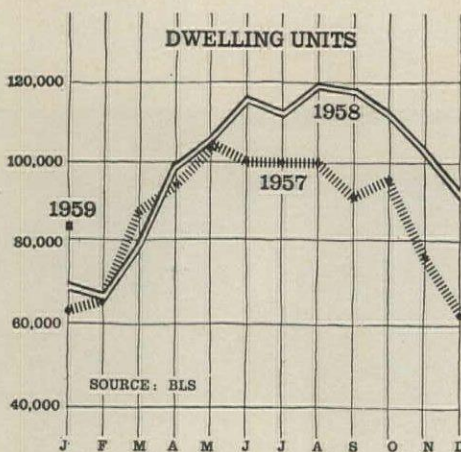

**HOUSING STARTS** in January slipped to 86,000 (83,300 private and 2,700 public), off 3.3% from December. The seasonally adjusted annual rate of 1.35 million was off 5% from the four-year high of 1.43 million in December.

But housing is still off to a much better start than it was last year. This January's starts were 25% above the 69,000 of January last year, when the seasonally adjusted annual rate was only 1.03 million.

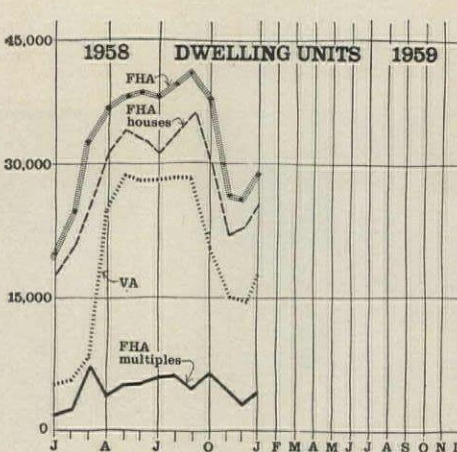

**FHA APPLICATIONS** on new units climbed sharply in January to 28,829—up 11.4% from December and 49% from January, 1958. Of these applications 25,529 were for new 1- to 4-family units, a gain of 11.2% from December and 47.8% from January of '58. Project units totalled 3,300 units, 13.5% over December and 65% greater than in January of 1958. VA appraisal requests on new units soared to 17,931—up 21.2% from December, 241.4% from '58.



AMERICAN  
MARIETTA



AMERICAN  
MARIETTA

**Peel-Proof\***

**HOUSE PAINT**  
HF-1 WHITE

**FLAT FINISH**  
*No Peel - No Blister\**  
WITHSTANDS SEVERE WEATHERING

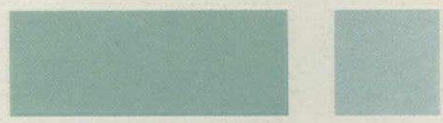

HF-8 TURQUOISE



HF-11 CHARCOAL

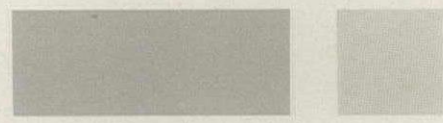

HF-10 STONE GRAY



HF-9 ASH GRAY

See following page...

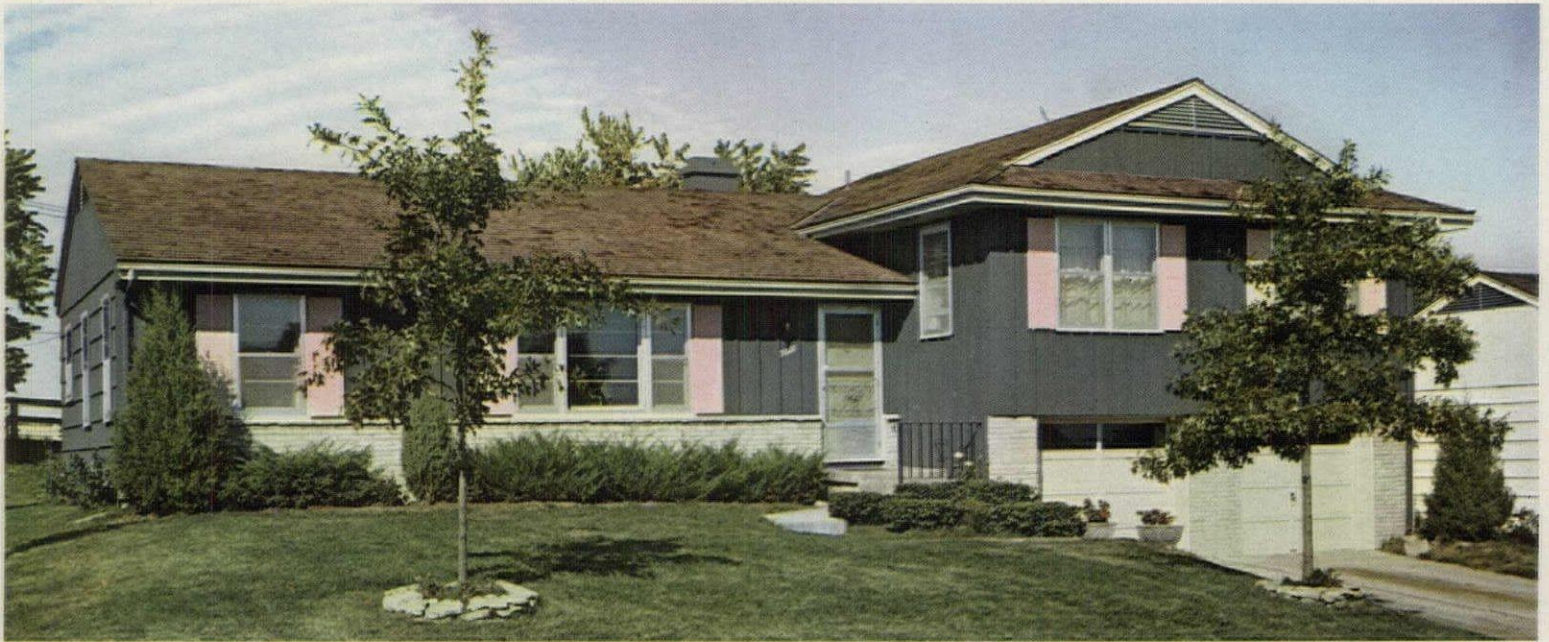

Peel-Proof Charcoal—Pink trim. Painting Contractor: A. T. Switzer Co. Builder: James H. Stanton Construction Co.

American-Marietta **PEEL-PROOF** was used on these typical new homes in the greater Kansas City area. Notice the richness of the lo-luster finish. And imagine the added selling appeal in a guaranteed house paint.

*If you'd like to feature this sensational guaranteed paint in your area, send in this coupon*

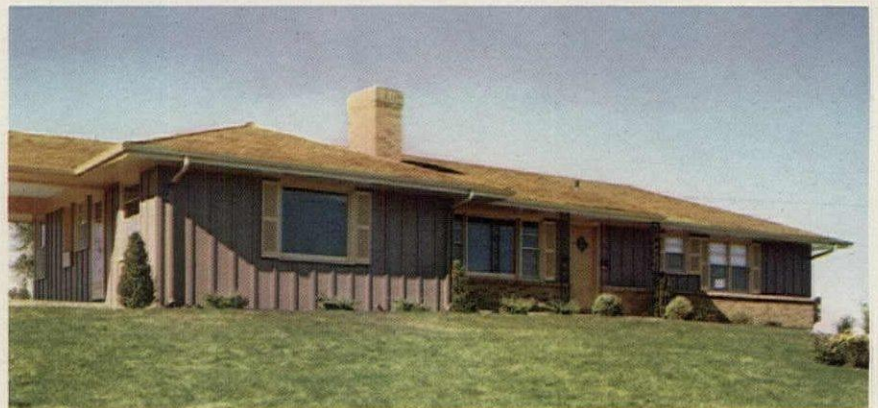

Peel-Proof Chestnut Brown letdown—Ivory Cream trim. Painting Contractor: Ammon Painting Co. Builder: Paramount Homes, Inc.



Peel-Proof Stone Gray with Bermuda Pink trim. Painting Contractor: L. C. Riley. Builder: Byers Construction Co.

AMERICAN-MARIETTA COMPANY  
101 East Ontario Street  
Chicago 11, Illinois

- Please send me the address of my nearest supplier of Peel-Proof House Paint.
- Please send me more information on Peel-Proof House Paint.

Name \_\_\_\_\_ Title \_\_\_\_\_

Company \_\_\_\_\_

Address \_\_\_\_\_

City \_\_\_\_\_ Zone \_\_\_\_\_ State \_\_\_\_\_ H. H. \_\_\_\_\_

## LOCAL MARKETS:

## Centex joins the Florida migration

terms of a slightly smaller house to keep payments down."

Ned Eichler of Palo Alto, Calif, vice president of his father's firm (Joseph L. Eichler), shrugs off the new VA outlook: "It will be no help to us. It will boost monthly payments \$9 in our bracket (\$19,950 to \$24,500) . . . We don't have down payment problems. Monthly payments are the biggest problem we've got."

And Sam Hechtman of Detroit, whose Practical Home Builders was one of the area's biggest producers in 1958 (810 starts), worries about qualifying buyers: "From that side the rate increase is bound not to help much, especially if there is an extension [of the mortgage term] to 35 years. This would help the average veteran only 12 or 13¢ per \$1,000 on his monthly payments. Investors would get a better yield with the rate increase but will they accept the 35-year terms?"

**Lower prices?**

If discounts on VA loans shrink four points when the rate is boosted by ½%, will this mean lower prices on VA homes?

Many builders make it no secret that in some areas VA pads appraisals to cover some of the points builders pay for money.

But San Diego's Nels Severin, immediate past president of NAHB and one of the few who denies such padding, foresees no price cuts: "It merely means builders will make a profit for a change. They'll still have to take a discount. But discounts have come out of the builder's profits."

Builder Harold Sarshik of Haddonfield, N. J. agrees: "The builder has been absorbing that discount to a large extent. It might mean now that we'll make some money for the first time in two or three years on VA homes."

Big Detroit Builder Irving Rose, while doubting he can cut his own prices because of other rising costs, disagrees: "While a decrease in price levels isn't possible in our case it could be for builders elsewhere. The reduction in rate could mean a \$600 difference in some cases."

Big Phoenix Builder John Hall (1,260 starts in 1958) may increase the proportion of VA starts from last year's 40%—believes his prices can come down about 3% across the board with the higher rate.

## MARKET BRIEFS

**6% broker's commissions**

The trend to 6% commissions on used house sales has spread to Los Angeles.

Walker & Lee, biggest US realtor of new houses and also big brokers of existing houses, have made the jump from 5%—on used homes only. General Sales Manager Frank Hart is confident other realtors in the area will quickly fall in line.

**FHA MPS' effective July 1**

FHA's new minimum property standards, which will give all areas of the US the same construction requirements for the first time, will go into effect July 1.

Between April 1 and June 30, builders may use either the old minimum property requirements or the new MPS. But FHA warns whichever rules a builder chooses, he must use them *in toto*.

The choice must be made when the builder files his application with FHA.

**Miami:** Another of the nation's big mobile builders, Centex Construction Co of Dallas, is moving into the hotly competitive Miami market.

Centex has joined Arvida Corp to form a new corporation, Centar Development Co—owned two-thirds by Centex and one-third by Arvida. Centar has paid \$4.9 million for 3,000 acres of Arvida's land west of Boca Raton, plans a city of 10,000 homes there. Boca Raton is about 40 mi north of Miami—between Fort Lauderdale and Palm Beach.

The new enterprise represents an interesting merger of big money. Arvida was organized to hold and finance development of the huge Florida land holdings of Arthur Vining Davis, 91, retired chairman of Alcoa and still Alcoa's biggest stockholder.

On the other side of the deal the sons of wealthy oilman Clint Murchison\* hold a substantial interest in Centex. They have helped President Tom Lively build Centex into one of the nation's biggest homebuilding firms—now building in Dallas, Chicago and Honolulu. A subsidiary builds apartment houses and Centex itself has built thousands of Capehart Act military housing units.

Centex will find some old friends in the Miami market. Among the mobile builders already there: Willard Woodrow of Los Angeles, who opens his first homes March 8; Heftler Construction Co of San Bernardino; Praver & Sons of Kansas City and Tandy & Allen of Hillsdale, N.J. But more important to Centex, its closest major competitors will be Miami's Mackle Co, 1958's biggest builder, in Pompano Beach; IBEC (International Basic Economy Corp) of Puerto Rico, also in Boca Raton; and Martin Cerel of Boston, in West Palm Beach.

*Last year was a year of contrasts for housing's biggest, most volatile market—southern California. Detailed reports from HOUSE & HOME correspondents:*

**Los Angeles** has reached the saturation point for houses priced above \$17,500, says Builder M. J. Brock Jr, new president of the Los Angeles, Orange and Ventura County home

\* Who is reported selling out many of his holdings and retiring because of ill health.

builders. "I would give a word of caution to builders in our area who contemplate construction in that class. But I would point out also that in the \$12,000-\$15,000 market there is still a demand," says Brock. As for overall home building in the area for '59: "My feeling is one of caution. I feel that our area housing development will be about the same as it was in '58."

If true, the prediction is a glum one: year-end figures on Los Angeles County building permits in '58 show 25,869 singles, 36,408 multiples, making it the poorest housing year since '51 and the second lowest year since World War 2.

**Santa Maria-Lompoc, Calif.:** Vandenberg AFB, "the Cape Canaveral of the West" is bringing a housing boom to these two towns 175 mi up the coast from Los Angeles. Motels are full, families living in trailers as the missiles industry moves in to service the base. Land prices have zoomed from \$2,000 to \$8,000 an acre in one year in the area (largely devoted to flower seed growing). Dwelling permits rose 950% in Lompoc, closest to the base (from 76 in '57 to 723 in '58) not counting 580 Capeharts on the base itself. In more distant Santa Maria, permits for 11 months more than doubled, from 201 to 444. The boom is bringing Los Angeles builders into the area in shoals.

**San Diego**—a town with a permanent cold war defense housing boom—continues as California's hottest local market. But now the first signs are appearing that a slowdown may be in sight.

Demand has been spurred by the still-growing aircraft plants in the missile business (Ryan, Convair, Rohr) and naval and marine installations. This has lured more and more giant developers south from Los Angeles. Result: a new record in residential building last year, topping the 1952 Korean War high. Dwelling permits for the city and two suburbs:

	1957	1958
San Diego .....	9,258	11,041
El Cajon .....	722	1,564
Chula Vista .....	541	1,399

NEWS continued on p 64



**BILLBOARDS** which have illegally cluttered up San Francisco residential areas for more than 20 years are coming down at last.

Of 474 boards located in residentially zoned areas, 308 had been ripped down by Jan 1. Sixty more are due to come down to make way for new freeways. The future of 49 is still being debated and 57 may be left as zoning is changed to adjust

to the changing uses of some neighborhoods.

The move to tear them down was a by-product of urban renewal and freeway construction programs. City officials insist they have no choice but to order the signs demolished. Federal and state authorities, who have a hand on the purse strings of urban renewal and road building programs, demand it.

# "See, it's real *Thermopane*<sup>®</sup> ... that's good!"

This is a man who knows what he wants in a home—and windows glazed with genuine *Thermopane* insulating glass is one of them.

He is but one of hundreds of thousands of prospective home buyers who have been educated to the advantages of *Thermopane* by 16 years of intensive and vigorous advertising in national magazines and on top-rated TV shows.

He knows that with L·O·F *Thermopane* in the windows his family will be warmer in winter, cooler in summer, more comfortable all year 'round. And he knows that he won't have to buy and fuss with storm windows. (That, in itself, is a big sales point!)

There's no better way to merchandise houses than to feature the quality, nationally-advertised materials used in them . . . to prove that you have not used *substitute* materials. We can help you there . . . with literature, signs and displays made expressly for use in model homes. Just phone your local L·O·F Glass Distributor (listed in your phone book yellow pages), or write Libbey-Owens-Ford Glass Co., 939 Madison Ave., Toledo 3, Ohio.

## TWO KINDS OF L·O·F THERMOPANE

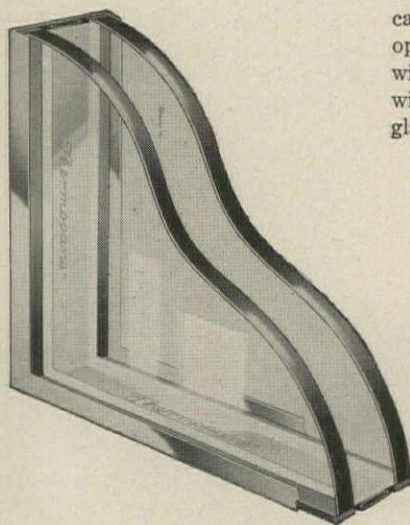

*GlasSeal*<sup>®</sup> *Thermopane* for double-hung, casement, awning — many types of opening windows. Super *Thermopane* with *Bondermetic Seal*<sup>®</sup> for picture windows, window walls and sliding glass doors.

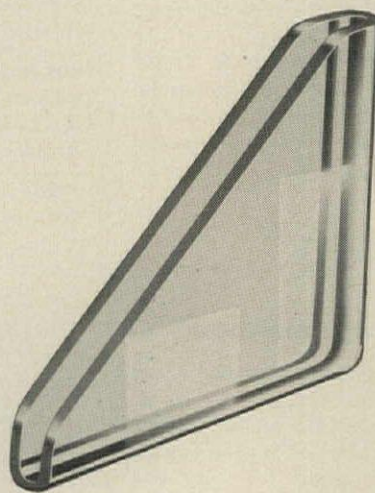

*Thermopane*  
INSULATING GLASS

Made in U. S. A. solely by LIBBEY·OWENS·FORD a *Great Name in Glass* Toledo 3, Ohio







## Price of money poised for new rise; bigger discounts expected in spring

Discounts are going to get even larger this spring. You can just about count on it.

Few builders believe it, though virtually every indicator points that way. FHA-VA builders throughout the US are delaying their financing in the hope—probably vain—that a housing law will work some magic to change the trend of the money market.

Says Maurice O'Hearn of Bankers Mortgage Co, San Francisco: "Builders think the bill will mean higher *prices* for them. Bankers think *discounts* will go higher." He predicts: "Builders are going to have a hard time getting all the money they want or need this year."

**A boost in the VA interest rate from 4¾ to 5¼% will still confront builders in the South and West with sizeable discounts.**

If the ½% interest rate hike is fully reflected in discounts—it should mean a bottom price for VAs of 96, four points better than the present 4¾% market. But when a rate is boosted, discounts seldom shrink by the full amount. Thus O'Hearn and others on the West Coast predict their VA 5¼ market will be at 94½-95. And by mid-June O'Hearn expects the price to be down to 94.

And as VA goes down, FHA will slide with it. Other mortgage men predict an FHA-VA market in the South, Southwest and West of 95-96 for most of the spring. Predicted market in other areas (outside New England and New York): 97-97½.

Discounts in some cities—Detroit, Washington and St Louis—have already started edging up.

**The trend toward fatter discounts is foreshadowed by yields on government bonds, now at a record high.**

The yield difference between government bonds and insured or guaranteed mortgages is typically 1 to 2%. When it slips close to 1%, mortgage men figure FHA and VA prices are due to fall. In mid-February, the spread was approaching 1%. Several government issues were yielding between 3.9 and 4%. One was yielding 4.08%. Yield on an FHA 5¼ sold at 96 (after ½% servicing) is 5¼%.

Moreover, if housing continues to boom and particularly if VA makes a strong comeback in higher priced houses (see p 54), heavy demand for mortgage money will probably push discounts up. The Home Loan Bank Board estimates \$29 billion will be required for mortgages in the purchase of single family homes alone this year—\$1 billion more than in 1958.

**With these pressures at work, why didn't discounts start inching up in more cities in January and February?**

Replies one lender: "The simplest explanation I can give is that money rate pressure has been on the up side but the supply [of mortgages] has been on the down side."

Several items, besides the lack of immediates, helped to buoy up FHA-VA prices the first two months of the year. Some savings banks were reporting a high percentage of washouts on commitments made last year. One got only 30% delivery on one block.

The high level of washouts had one disturbing aspect. It seemed to indicate the level of sales last year did not match the level of starts.

Increasingly stiff competition from local lenders—banks and S&Ls—plus the firmly pegged secondary market prices of Fanny May have also helped hold up over-the-counter prices.

**As discounts do go up it's sure to increase pressure for a boost in the FHA rate from 5¼%—but chances for an increase now look slim.**

Congress, after raising the VA rate to FHA's level, is sure to oppose any early change in FHA which would again put VA at a disadvantage.

But probably the strongest opposition to a boost comes from the Treasury. After its flop trying to market a long term refunding issue in February, the Administration is reported anxious to keep FHA's rate strapped down in hopes the Treasury can develop more investor-interest in its own issues.

### Spot loans depress market

FHA spot loans, made on existing houses, have quietly become a major influence in the New York wholesale mortgage market. And they are boosting discounts on loans for new homes.

Since terms on new and existing houses were equalized in 1957, the volume of FHA spot loans has risen steadily. But it spurted most last year when Congress cut down payments and money eased enough to send investors looking for FHA mortgages in volume on existing as well as new construction.

Now, packages of from \$500,000 to \$1 million worth of spot loans are being offered in the New York market at prices as low as 89—as much as six points below the market on new construction mortgages. But the prevailing market is 93½-95.

Says Mortgage Broker Tom Coogan, president of Housing Securities: "These packages cover houses of a wide variation in age and condition. Many are on minority housing. A big percentage results from refinancing by owner-occupants who want to pay off a high-interest second mortgage and a conventional first to get a single FHA loan. And many of the houses are in poor locations.

"Most of these loans are simply unacceptable to Fanny May because of this quality aspect. So they come into the New York wholesale market as distress paper."

### Price of frozen interest: 10%

Big mortgage discounts—the results of frozen interest rates—inflated the price of one Detroit builder's house by 10%.

Who says so? The realtor who sold it. Robert Trombley, president of Home Values Inc, told the Detroit News all about it. When Fanny May Program 10 came along last year with par FHA and VA money (instead of 6½ and 7-point discounts available on the free money market), he was able to offer a better house for \$13,500 than he was selling for \$14,900 late in 1957. Both houses were built by Kaufman & Broad.

Says Trombley: "The special assistance meant that Kaufman & Broad could easily lower the price of their home by \$1,450 and still make the same margin of profit." K&B still have 107 of 550 Program 10 commitments, covering \$7 million worth of housing, says Trombley. After they are gone, discount-inflation will be back in sales prices, he forecasts.

### More money—maybe

Legislation which may make more money available for home mortgages and would surely make it easier to get construction loans has been introduced in Congress.

Commercial banks now cannot invest more than 60% of their savings accounts in real estate mortgages. Construction loans count against that quota.

A financial institutions bill would let banks classify construction loans as short-term business loans, not to be counted against the real estate loan limit.

For commercial banks which have been investing in both residential mortgages and short-term construction loans, this should free millions of dollars for long-term mortgages and give banks more freedom in making construction loans.



# Full 90% conventionals draw few takers, Dime Bank finds

Only 25% of borrowers under New York State's new law permitting 90%, 30-year mortgages by state-chartered savings banks and S&Ls have asked for the minimum down payment and maximum terms.

H&H staff



JACKSON

"We were really surprised . . . we thought the proportion would be considerably larger," admits Frederick W. Jackson, affable vice president and mortgage head of the Dime Savings Bank of Brooklyn.

The 798 loans made in nine months under the law represent only 2% of the bank's portfolio, but account for a "rising 20%" of current mortgage activity, Jackson says. "Well over one-third (of the mortgages) have been between 85-90%, with most carrying a loan-

to-value ratio of 85%," he says. "A sixth are in the 80-84% bracket, one-eighth between 75-80%, and a tenth below 75%."

In spite of the surprisingly low number who took maximum terms, says Jackson, "a substantial number of families would have been denied home ownership if it were not for that permissive 10% down."

Jackson hails the 90% conventionals as a "most valuable financing tool," calls them a way out for builders tired of "expense, delay and red tape involved with government-backed mortgages." The Dime's verdict (as one of a very few yet making such loans): "We love them. Our builders love them. And home buyers love them."

Jackson notes that federally-chartered S&Ls have since been given permission to make 90% 25-year loans. But builder George C. Martin, Louisville, Ky, also on the panel, observed: "There's absolutely no indication that any of our [S&Ls] will go to 90%—only a few go to 80% and most go only to

75%." Reason: no insurance feature.

Discussion Leader Dale Bellamah, biggest builder in New Mexico, asked Jackson: "Isn't it an abuse of your law to make, as I understand you do, a 95% loan, with the builder participating for 5%?"

Jackson: "No, it isn't. Our exposure is still only 90%. If the builder wants to venture 5% on top of that, we make monthly collections on 95% basis, and remit his proportionate share to him quarterly. He doesn't get his 5% out from the top. We calculate he gets out within 6-7 years. And not much use is being made of that, anyhow."

One more upstate New York bank, the Kingston Savings Bank, has also started making 90% conventionals but restricts them to its home county.

And in Portland, Ore. at least one local S&L is now making 90% loans—setting aside a ½% interest surcharge as loss insurance.

NEWS continued on p 69

## MORTGAGE MARKET QUOTATIONS

(Sale by originating mortgagee, who retains servicing.) As reported to HOUSE & HOME the week ending Feb. 13, '59

### FHA 5 1/4s (Sec 203) (b)

Spec Asst	Scdry Mkt	Minimum Down* 30 year		Minimum Down* 20-25 year		10% or more down 20-25 year	
		Immed	Fut	Immed	Fut	Immed	Fut
96	97	96-97	96-97	97	97	97-98	97-98
96	98	par-101*	par-101*	par-101*	par-101*	par-101*	par-101*
—	—	96-97	96-97	96-97	96-97	96-97	96-97
96	97	96-98	96-98	96-98	96-98	96-98	96-98
96	97	97-99	96-97	97-99	96-97	97 1/2-99	97 1/2-99
96	96 1/2	96-97 1/2	96-97 1/2	97-98	97-98	97 1/2-99	97 1/2-99
96	96 1/2	96-97	96 1/2-97	96 1/2-97 1/2	97-97 1/2	97 1/2-98	97 1/2
96	97	96 1/2-97	96 1/2-97	96 1/2-97	97-97 1/2	97-97 1/2	97-97 1/2
96	97	96-97	96-97	96-97	96-97	97-98	97-98
96	96 1/2	96-96 1/2	96-96 1/2	96-96 1/2	a	97-par bh	96-97
96	97 1/2	99	98 1/2	99	98 1/2	par	99 1/2
96	98	99	99	99	99	99	99
96	96 1/2	97	96j	97	96j	97 1/2	97 1/2
96	97 1/2	98 1/2-par	98 1/2-par	98 1/2-par	98 1/2-par	98 1/2-par	98 1/2-par
96	96 1/2	96	96	96	96	96	96
96	97	94 1/2-97	94-97	95-97	94 1/2-97	96-99	95 1/2-98
96	97 1/2	98 1/2	98	98 1/2	98	99	98 1/2

\*3% down of first \$13,500; 15% of next \$2,500; 30% of balance.

SOURCES: Atlanta, Frank Edwards, vice pres, Tharpe & Brooks Inc; Boston, Robert M. Morgan, vice pres, Boston Five Cents Savings Bank; Chicago, Maurice Pollack, exec vice pres, Draper & Kramer Inc; Cleveland, William T. Doyle, vice pres, Jay F. Zook Inc; Denver, C. A. Bacon, vice pres, Mortgage Investments Co; Detroit, Stanley M. Earp, pres, Citizens Mortgage Corp; Houston, Donald McGregor, exec vice pres, T. J. Bettes Co; Jacksonville, John D. Yates, vice pres, Stockton, Whatley, Davin & Co; Los Angeles, Chris Gebhardt, asst vice pres, The Colwell Co; Newark, Arthur G. Pullis, Jr, pres, Franklin Capital Corp; New York, John Halperin, pres, J. Halperin & Co; Oklahoma City, B. B. Bass, pres, American Mortgage & Investment Co; Philadelphia, Robert S. Irving, exec vice pres, W. A. Clarke Mortgage Co; St. Louis, Sidney L. Aubrey, vice pres, Mercantile Mortgage Co; San Francisco, Maurice V. O'Hearn, vice pres, Bankers Mortgage Co of Calif; Washington, DC, Hector Hollister, exec vice pres, Frederick W. Berens Inc.

### VA 4 3/4s

City	30 year no to 2% down		25 year 5% down		20-25 year 10% down or more		Conventional Interest Rates
	Immed	Fut	Immed	Fut	Immed	Fut	
Atlanta	a	a	a	a	a	a	5 1/4-5 3/4
Boston local	99-101	99-101	99-101	99-101	99-101	99-101	5-5 1/2k
out-of-st	92-93	92-93	92-93	92-93	a	a	—
Chicago	a	a	a	a	a	a	5 1/2-5 3/4
Cleveland	94-95 <sup>b</sup>	92-94 <sup>b</sup>	a	a	a	a	5 1/2-5 3/4
Denver	91-93	91-93	92 1/2-93 1/2	92-93 1/2 <sup>b</sup>	94 <sup>c</sup>	a	5 1/2-6
Detroit	92-92 1/2	92	a	a	92 1/2-93 1/2	92 1/2	5 1/2-6
Houston	92-93	92-93	92-93	92-93	a	a	5 1/4-5 3/4
Jacksonville	92-92 1/2	92-92 1/2 <sup>b</sup>	a	a	a	a	5 1/2-6
Los Angeles	92-92 1/2	92-92 1/2	92-92 1/2 <sup>b</sup>	a	92 1/2-93 <sup>b</sup>	a	5 3/4-6.6
Newark	96	95	96 1/2	95 1/2	98	97	5 1/2-5 3/4
New York	97 <sup>f</sup>	97 <sup>f</sup>	97 <sup>f</sup>	97 <sup>f</sup>	97 <sup>f</sup>	97 <sup>f</sup>	5 1/2-5 3/4
Okla City	92-92 1/2 <sup>i</sup>	a	92-92 1/2	a	92-92 1/2	a	5 3/4
Philadelphia	a	a	a	a	a	a	5 1/2
San Fran	92 <sup>b</sup>	92 <sup>b</sup>	a	a	a	a	5 3/4-7.2
St Louis	d	d	a	a	a	a	5 1/4-6
Wash, DC	93 1/2	93	96	94 1/2	96	94 1/2	5 3/4-6

▶ Immediate covers loans for delivery up to 3 months; future covers loans for delivery in 3 to 12 months.

▶ Quotations refer to prices in metropolitan areas; discounts may run slightly higher in surrounding small towns or rural zones.

▶ Quotations refer to houses of typical average local quality with respect to design, location and construction.

Footnotes: a—no activity, b—very limited market, c—very limited demand, d—some offering at 91-92, e—local activity at 97, f—includes construction loans, g—some 5% and some 5 1/4%, h—by local banks to depositors, i—no merchandise, j—just over 3 mos and limited amounts, k—some instances of cutting to 4 3/4%, w—FNMA pays 98 for FHA 5 1/4% mortgages of \$13,500 or less after 3/4 point purchasing and marketing fee and 3/4 commitment fee, x—FNMA pays 1/2 point more for loans with 10% down or more, y—FNMA net price after 1/2 point purchase and marketing fee, plus 2% stock purchase figured at sale for 50¢ on the \$1, z—price after 3/4 point purchasing and marketing fee, plus 3/4 point commitment fee; applies only to VA mortgages of \$13,500 or less.

## NEW YORK WHOLESALE MORTGAGE MARKET

### FHA 5 1/4s

Immediates: 95-96  
Futures: 95-96

### VA 4 3/4s

Immediates: 91-91 1/2  
Futures: 90 1/2-91 1/2

### FHA 5 1/4 spot loans

(On homes of varying age and condition)  
Immediates only: 93 1/2-95

Prices for out-of-state loans, as reported the week ending Feb 13 by Thomas P. Coogan, president, Housing Securities Inc.

Note: prices are net to originating mortgage broker (not necessarily net to builder) and usually include concessions made by servicing agencies.

## FNMA STOCK

	Month's			
	Jan 12	Feb 12	low	high
Bid	55 1/4	59 3/4	55	59 3/4
Asked	57 1/4	61 3/4	57	61 3/4

Quotations supplied by C. F. Childs & Co.

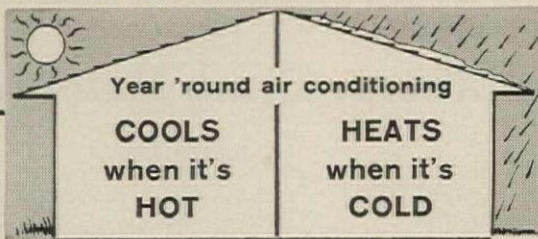

**AIR CONDITIONING PLUS HEATING FROM A SINGLE, COMPACT "CLIMATE MACHINE" THAT'S ENGINEERED AND PRICED FOR \$12,000 HOMES AND UP**

# This new heat pump electric heating—plus Now sparking new part of

**All the benefits of electric heating at far less cost to the homeowner—plus summer cooling! That's your big selling package with the Fedders Adaptomatic heat pump air conditioner. Its year 'round comfort services, extra cleanliness, automatic convenience and the basic economies of heat pump heating are proving irresistible to homebuyers everywhere.**

No matter what you're building or where, this dramatic sales feature will cost you little more than you're spending for heating alone... will add thousands of dollars in extra value... and extra sales appeal as it is doing all over the United States:

**Chicago** — 102 Fedders Adaptomatic Heat Pumps going into Leonard Gervasio's Lombard Lilac Gardens and Norman Schlossberg's Merideth Homes... **Atlanta** — Fedders Heat Pump featured in C. J. League and W. L. Jackson's 100-home River Springs Forest sub-division... **Lima, Ohio** — Buyers select Fedders Heat Pump for 27 of first 30 homes sold (at \$1,100 premium) in Dick Tettman's new 201-home sub-division... **Miami** — Fleetwood Manor, 500-home development featuring Fedders central heat pump, sold out in days.

From all over America, the evidence is piling in: something has happened that makes everything you have read or heard about the heat pump air conditioner out of date. It is no longer restricted to warmer climates, no longer reserved for custom-built homes.

The Fedders 3 HP Adaptomatic Heat Pump provides air conditioning in summer... the world's cleanest, most modern automatic heating in winter. And it's priced far below any combination of separate cooling and heating equipment available — costs only little more than a conventional heating system alone.



*The Big News in homebuilding... as featured in full page newspaper ads*

# provides the lowest-cost all-year air conditioning. home sales in every the U.S.

*3 HP Adaptomatic Heat Pump incorporates pressurized condenser air system that permits installation in any interior location in existing house plans. Measures only 42" x 36½" x 21".*

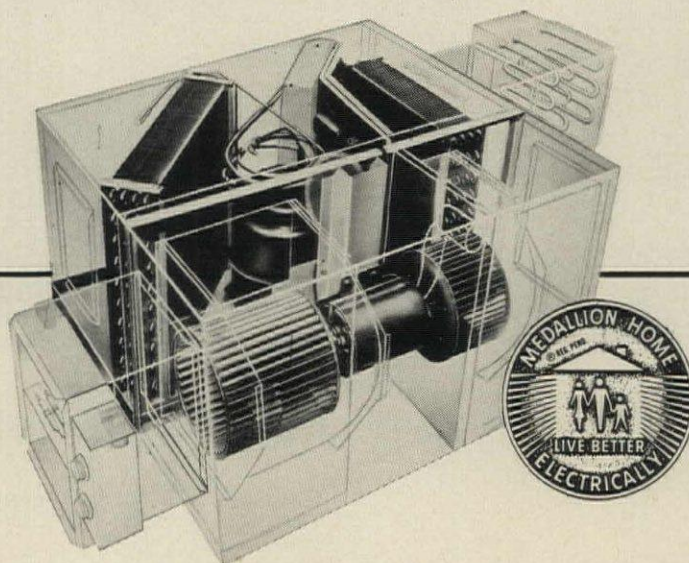

If you've thought of complete heat pump installations as costing \$2,500 to \$3,000, slash that figure by better than 50%. If you've imagined they require skilled, high-priced mechanics, just call your regular contractor. The all-in-one Fedders Adaptomatic Heat Pump is smaller and lighter, goes in faster than flame-fuel heating plants. It's factory assembled and tested, completely pre-wired when it's delivered to your building site. All accessories and controls are included.

Now for slightly more than you'd spend for an ordinary heating system, you can air condition your new homes summer and winter . . . and add more than \$1,000 in extra market value. This is the big feature on which to hang your merchandising and sales efforts, the most dramatic advance in homebuilding today.

Local electric power companies and cooperatives all over the U. S., which have tested and recommended the Fedders Adaptomatic Heat Pump, stand ready to help you promote and merchandise in substantial and effective ways as part of their all-out LBE Gold Medallion Home program.

Fedders provides attractive merchandising displays, consumer literature, ad mats that help you capitalize on the home comfort system of the future. Moreover, Fedders has a special plan to help development builders test the sales power of the Adaptomatic Heat Pump in model homes at extremely low cost. Call your wholesale distributor or mail the coupon direct to Fedders today.

## FEDDERS

### Adaptomatic

#### HEAT PUMP AIR CONDITIONER

Fedders-Quigan Corp.— Dept. HH-39  
Maspeth 78, New York

Gentlemen, please send me, without obligation, complete information on your Adaptomatic Heat Pump model home plan.

PLEASE PRINT

NAME.....

STREET ADDRESS.....

CITY..... STATE.....

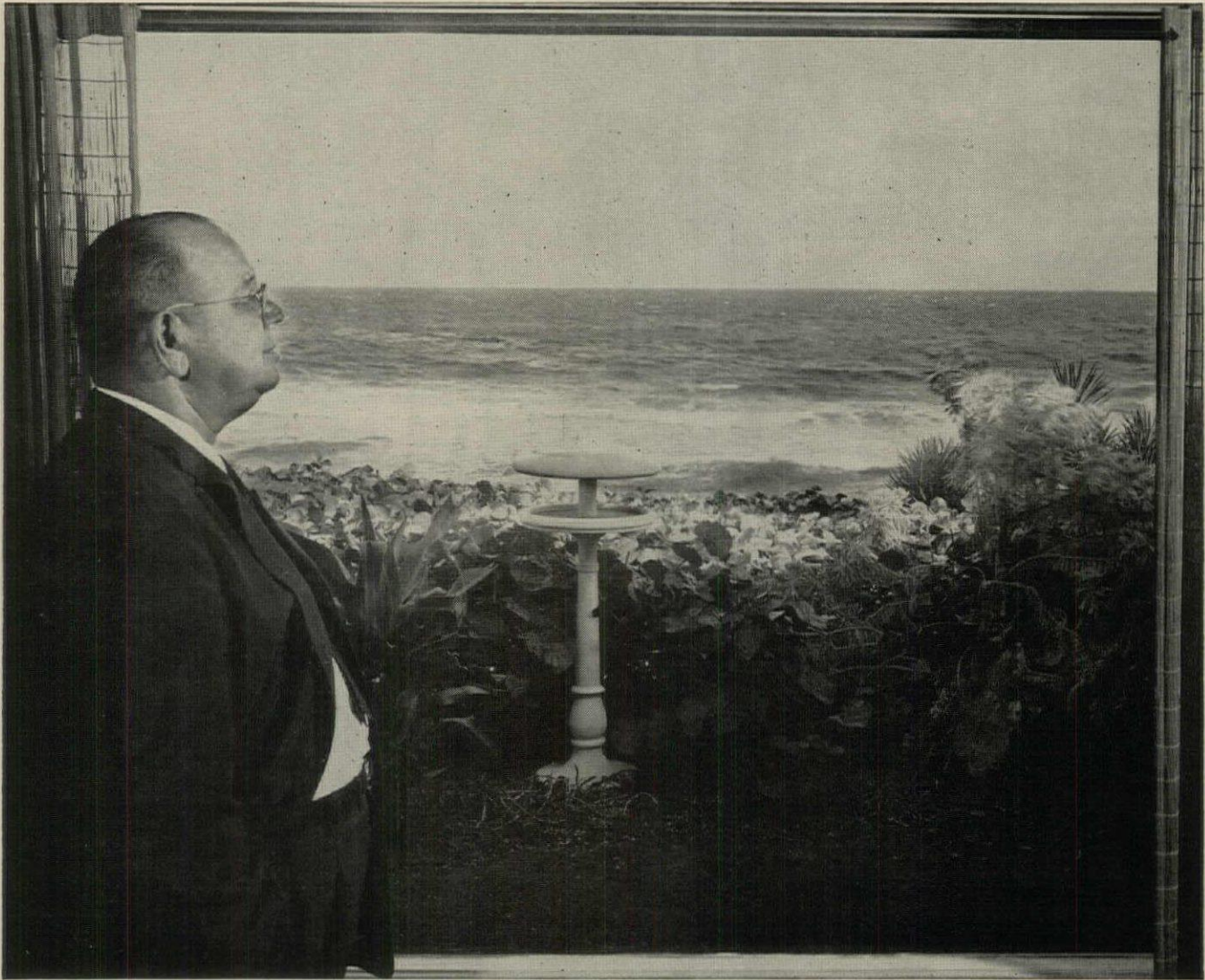

Home buyers find **AMERICAN Lustragray** glass provides  
 "the most comfortable living under the sun"

*Lustragray window walls provide this beautiful Florida home with privacy from the exterior, "clear glass" non-glare vision from the interior.*

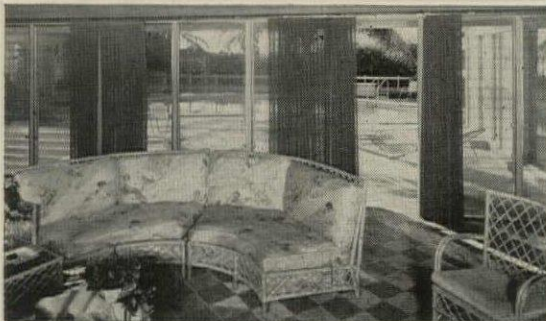
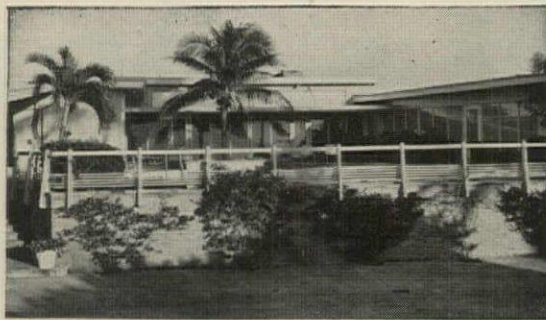

**Clint B. King, retired executive, has this to say about the Lustragray glass in his Hillsboro Beach, Florida home:** "Sun glare was a real problem at our beachside home until we replaced the glass in window areas with AMERICAN Lustragray. Now we can relax and enjoy our view of the Atlantic in comfort. I've also had many compliments on the attractive appearance of the glass. I'd recommend it to anyone. Its small additional cost is refunded every time we look through a window."

These Lustragray benefits, plus its heat-absorbing qualities, will help you sell homes faster. Consult your phone directory now for your nearest AMERICAN distributor or glazier.

**AMERICAN WINDOW GLASS DIVISION**



General Offices: FARMERS BANK BUILDING • PITTSBURGH 22, PA.

AMERICAN-SAINT GOBAIN CORPORATION is a merger of the former American Window Glass Company, Pittsburgh, Pa., and the former Blue Ridge Glass Corporation, Kingsport, Tenn. (which was a wholly-owned subsidiary of Saint-Gobain of Paris, France). American Window Glass Division plants are located in Arnold, Jeannette, Ellwood City, Pa.; Okmulgee, Okla. Blue Ridge Glass Division plant is located in Kingsport, Tenn.

WSW 7472 A

## Opinions

Noteworthy comment on matters of moment to housing:

TIME: Walter Bennett



**Gabriel Hauge**, former economic advisor to President Eisenhower, in a Chicago speech:

"In both economic analysis and policy, the pendulum has swung too far toward public interference in markets of various kinds. There has been a growing disposition to regard free markets as strictly fair-weather phenomena. This retreat from competition, usually in the name of stability, is largely the legacy of the great depression of the 30's and the world war of the 40's . . . It springs from a desire for security, for immunity from change, elusive and impossible as such immunity is in our rapidly changing world. . . .

"By overindulging these attitudes and fears we may well have achieved something in the short run for the various economic groups concerned. But these advantages have been bought at a high price for the economy as a whole—a growing rigidity in structure and a tendency to rising costs and, consequently, of prices. One of the key factors responsible for the long-run inflationary threat we face today is surely to be found in this legacy from the days of the great depression . . ."

H&H staff



**Charles Wellman**, executive vice president, Glendale (Calif.) Federal S&L:

"It has served no public purpose for us to go from 900,000 housing starts at the beginning of 1958 to an annual rate of 1.4 million at the end of 1958."

H&H staff



**George Seltzer**, Cleveland builder, in an address to the savings & mortgage division of the American Bankers Assn.

"As a builder I have been active in urban renewal for several years. At times I've felt like an orphan because I have had so little company from my fellow builders."

AP



President **Charles H. Kellstadt** of Sears, Roebuck & Co to the 30th annual meeting of the State Street Council in Chicago:

"Chicago's back yard is drab and dreary and has too many slums. We can't dress up with a clean shirt and soiled underwear. Urban redevelopment is a must. Business hasn't provided nearly enough leadership in renewal programs. In its desire to remain politically sexless, it has become impotent."

## VIEWS ON THE NEWS:

## Will Congress unshackle housing from its political money-chains?

By Gurney Breckenfeld

Homebuilders and Congress seem to be awakening together to the fact that politically frozen interest rates are better housing's worst enemy.

This transformation is part remarkable and part political.

Since HOUSE & HOME first drew attention to the fact way back in December 1956 ("How Government Has Unstabilized the New House Market"), more and more experts have correctly identified the feast or famine character of money for FHA and VA mortgages as not only the leading, but almost the only, reason why housing starts have plunged up and down since 1950 like a roller coaster. This point has been hammered home in articles, speeches and, most importantly, in compelling testimony presented to the Senate banking committee this year.

Nobody has contradicted witnesses who have testified that:

- This unstable level of housing production adds fantastically to the price of new housing. It helps create unstable employment in house building, which leads (as Sen William Proxmire notes) to demands for higher pay.
- The instability itself springs largely from price-fixing interest rates. And the program chiefly affected by price-fixing interest is VA homes, because its rate has usually been kept lower than FHA's.

NAHB, in its plea to Congress, said flatly there is no need for pumping Treasury money into Fanny May to support a par market for mortgages on low-priced new homes if Congress would just raise the VA interest rate enough so builders could operate under it. Realtors and lenders have been saying the same thing for a long time.

By a curious twist, President Eisenhower's outbursts against special interests who raid the Treasury for money to support their pet schemes has produced fresh political support for taking the lid off VA rates. Why? Northern, liberal, big-city senators and congressmen are most interested in urban renewal and public housing. They were impressed indeed when witnesses called attention to the fact that spending money to support the normal mortgage market is bound to make it harder to find federal funds for renewal and public housing.

So, for their own reasons, liberals seem to be deciding to part company with the neo-Populist champions of cheap money from the South & West. The effect is to leave proposals to back private building with public money minus enough support to make them law.

Democratic votes have maintained artificially-low VA interest rates. But now, the heavily Democratic (10-5) majority of the Senate banking committee admits this doesn't work.

Says its report to Congress: "There appears to be a preponderance of evidence showing that the VA program with a statutory interest rate ceiling of 4¾%, has not met the housing needs of worthy veterans because the fixed interest rate does not attract mortgage funds. In addition, to offset the low interest rate, the

practice of discounts in VA mortgages has become so prevalent over the last several years, that many builders who are forced to absorb these discounts have discontinued their operation under VA. This has resulted in fewer and fewer homes being made available to the veteran buyer."

So Congress has gone 40% of the way toward the fiscal logic the Administration recommended: instead of giving VA power to let its interest rate fluctuate the same way FHA's does (i e up to 6%), it has moved to boost the ceiling from 4¾% to 5¼%.

We hope this marks the start of a drift away from the notion that a legislative body can spur an economy by fixing prices, or that it can legislate prices at all—unless it is willing to clamp controls on *all* prices, wages and profits.

• • •  
**WASHINGTON INSIDE:** Watch for the McClellan labor rackets committee to come up with some eye-popping revelations of organizing tactics used against homebuilders by the Hod Carriers and Laborers Union. Most of the strange practices seem to center in the segregationist South. And there is some evidence, committeemen confide, that one federal agency is being made a cat's-paw to promote unionization by subterfuge.

Capitol Hill sources buzz that Fanny May will cut the stock purchase requirement for its secondary market program from 2 to 1% as soon as a 5¼% VA interest rate becomes law.

NEWS continued on p 73

# Fashion Plate ...

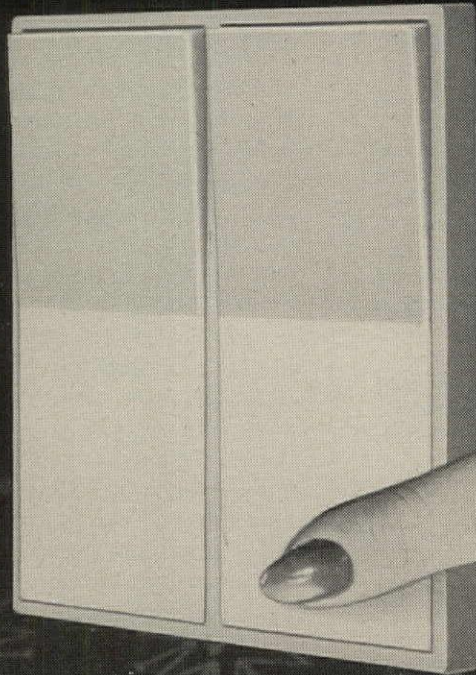
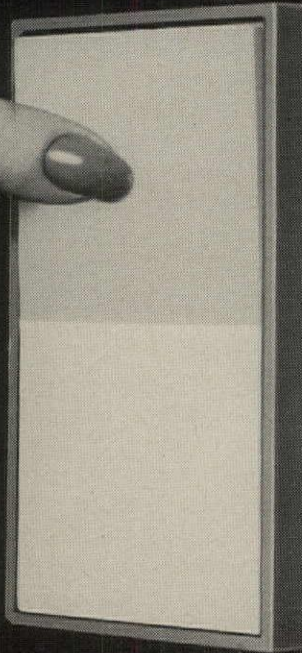

UNLIMITED DECORATIVE EFFECTS!  
Fashion Plate is available in black or white  
back plate, with ivory or clear actuators . . .  
blends well with any decorating scheme.

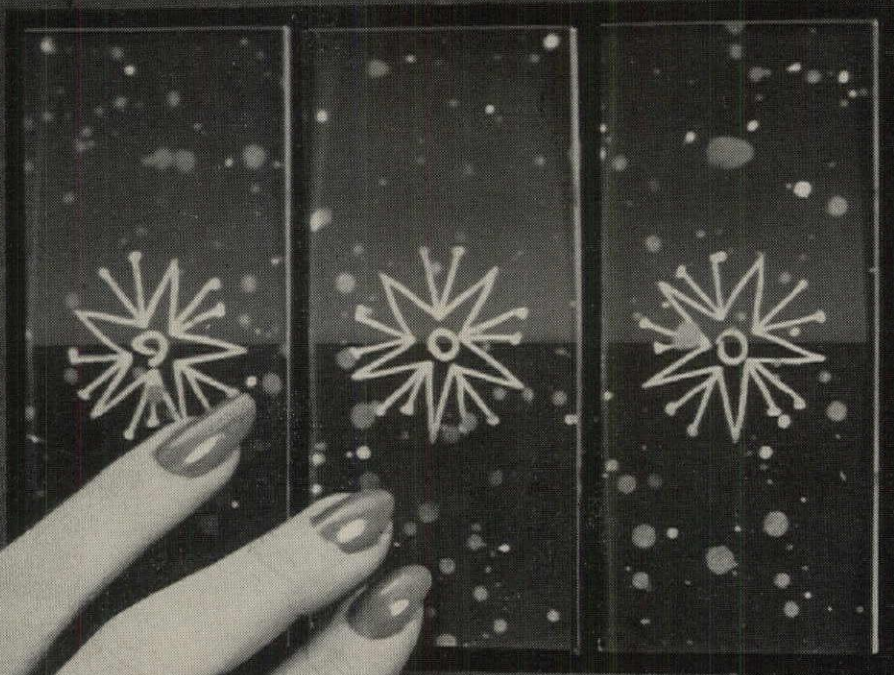



## HERE'S WHAT WOMEN LIKE ABOUT FASHION PLATE

The decorative angle—combinations of black and ivory—white and ivory—or wallpaper, fabric or paint backing a clear actuator . . . the wipe-clean advantage of plastic . . . no jutting toggle to catch or tear . . . ends broken fingernails, chipped nail polish . . . its easy, quiet, positive action . . . the completely different appearance!

# EXCITING NEW WAY TO TURN LIGHTS ON-OFF!

Fashion Plate wall switches put the spotlight on quality in every room of every house you build!

Here's the amazing new wall switch from Bryant that has obsoleted every other switch on the market today! It's the hottest new idea for turning on lights in 25 years! FASHION PLATE\*!

You will find Fashion Plate one of the easiest, fastest, best ways for the folks who sell your houses to say **QUALITY**. From front door to back, Fashion Plate is a symbol of whole-house quality. It's a powerhouse sales tool, too! Watch prospective buyers try it—test it—in

each room. It's an opportunity to tell *your* quality story over and over again!

Fashion Plate is in the news. Since its introduction only a few short months ago, dozens of articles and pictures have appeared in newspapers and magazines about it. And requests from readers have flooded in from all parts of the country! Fashion Plate is the kind of product they *expect* to find in a finely built home!

\*Trade-Mark

J-99004

## INSTALL FASHION PLATE IN JUST ONE MODEL HOME

and watch the comment. It commands attention—let's you tell your story of whole-house quality. Ask your electrical contractor and Bryant distributor, or write, phone or wire Bryant direct!

### A QUALITY PRODUCT!—backed by the name **BRYANT!**

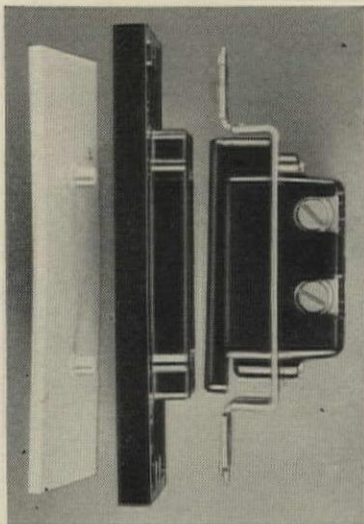

Smooth, quiet action. Low installation cost. No plate screws needed . . . just press on plate!

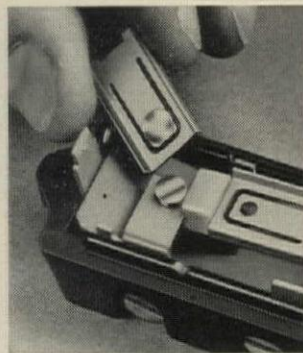

Silver alloy contacts insure long life. Quick make, slow break contact action. Positive pressure between contacts.

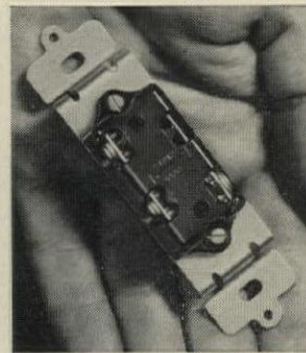

Compact design . . . fits all standard switch boxes.

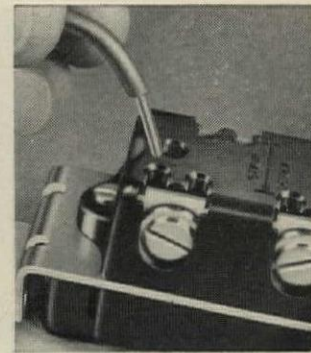

Time-saving, clamp-type, back wiring terminals. Splice-eliminating feed-thru terminals on single-pole and 3-way switches.

AVAILABLE FOR MOUNTING SINGLY—OR IN TWO- OR THREE-GANG COMBINATIONS

# Fashion Plate

The exciting things come from

# **BRYANT**

THE BRYANT ELECTRIC COMPANY  
BRIDGEPORT 2, CONNECTICUT

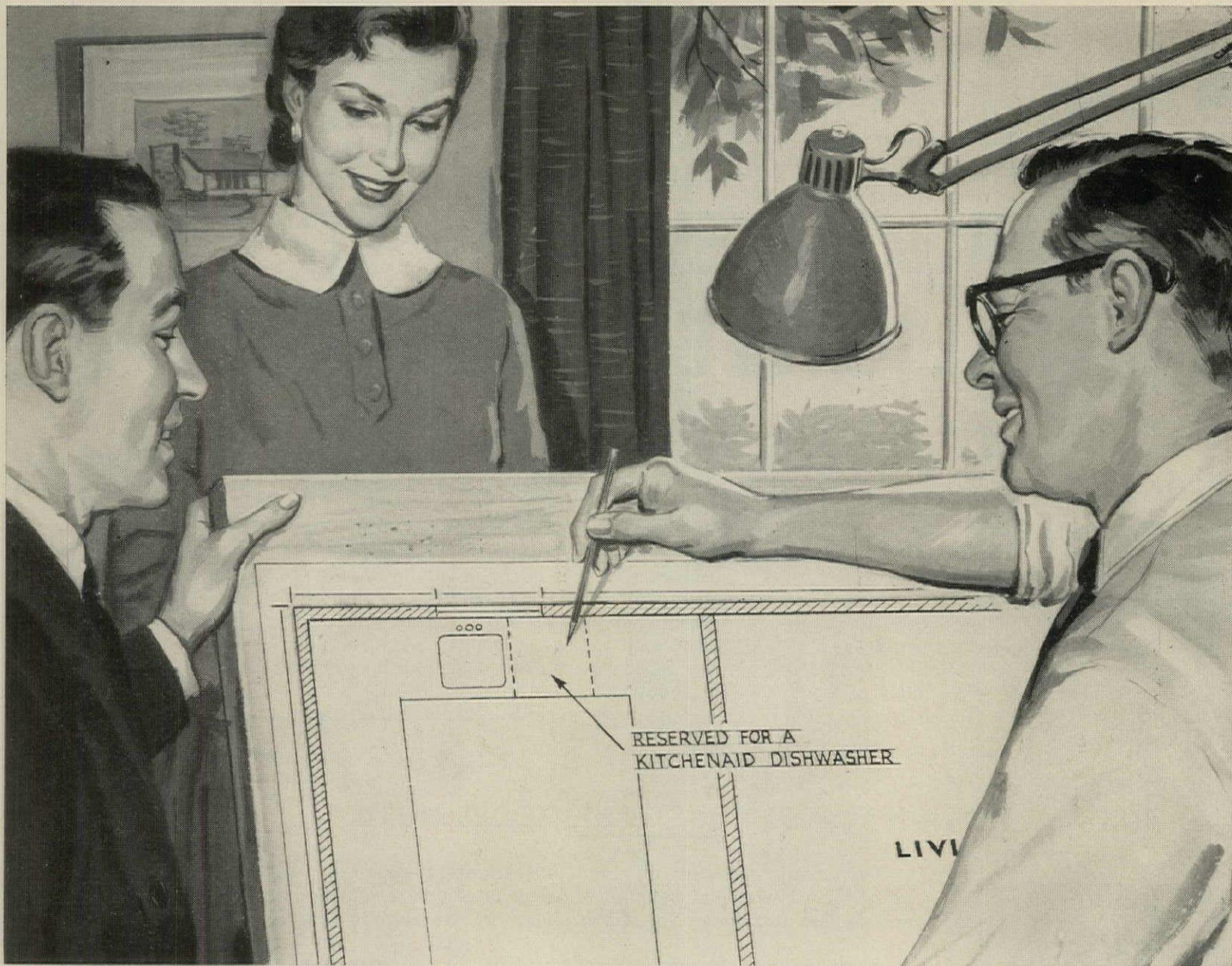

## An important TWO FEET in building plans!

The 24 inches you allow in your building plans for a built-in KitchenAid automatic dishwasher can be the most profitable footage in your entire house. KitchenAid will help you sell. It is the one appliance that makes a real difference.

But why not any dishwasher? Why KitchenAid? Very simple. KitchenAid has been time-tested and proved by performance to be the best dishwasher in the industry. It's in a class by itself! Dealer records show that service calls on KitchenAid are rare. When service is needed, it can be accomplished entirely from the front without unplumbing. It helps your future business to specify appliances that don't

require service and adjustment frequently.

With KitchenAid, installation is easy and economical for any model in the line. Special construction permits unit to slide in easily over roughed-in plumbing. All connections are made from the front. Choose from gravity-drain or automatic pump-drain, free-standing, undercounter, combination dishwasher sink or built-in counter-height models. KitchenAid is the *only* home dishwasher with Hobart revolving power-wash action and a separate motor and blower-fan for circulated electric hot air drying. Add another mark of *quality* to your homes by building in a KitchenAid automatic dishwasher. You'll like the results.

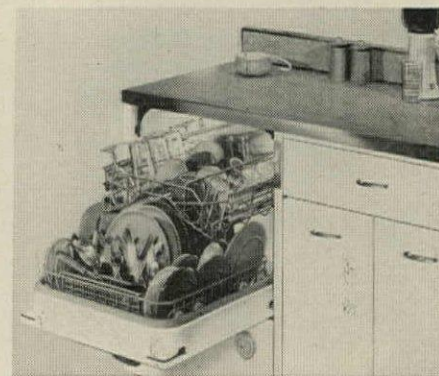

Undercounter models are available in a number of finishes, including antique copper tone and stainless steel.

# KitchenAid®

The Finest Made... by



The World's Largest Manufacturer of Food, Kitchen and Dishwashing Machines

KitchenAid Home Dishwasher Division  
The Hobart Manufacturing Co., Dept. KHH  
Troy, Ohio (In Canada: 175 George St., Toronto 2)

- Please send literature.  
 Please send name of nearest distributor.

Name.....

Firm.....

Address.....

City.....Zone.....State.....

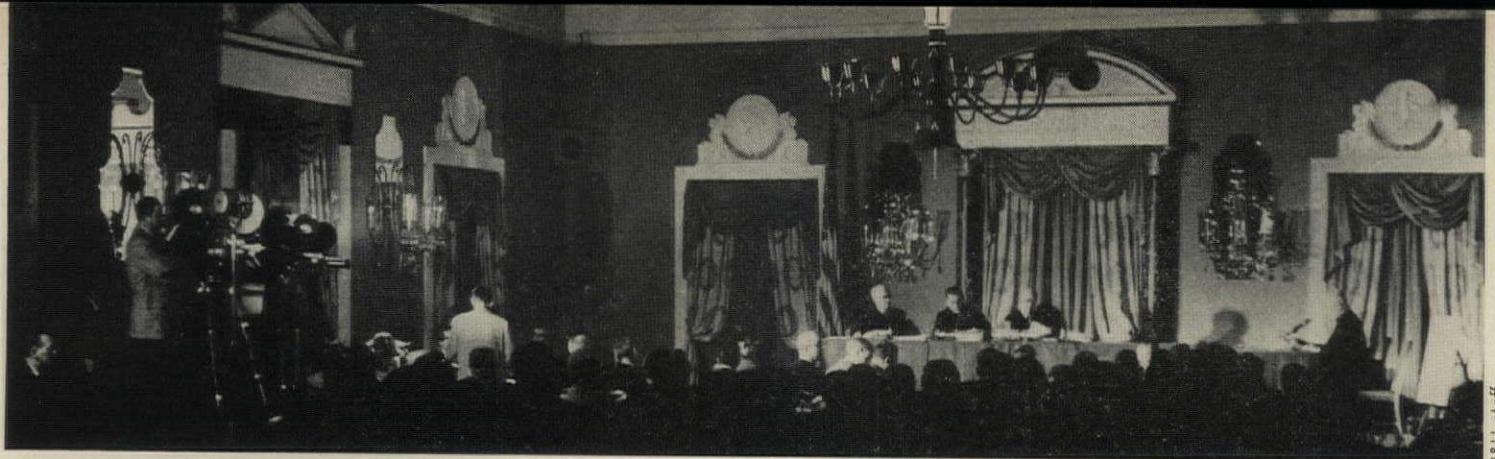

H&H staff

**FULL GLARE** of all-out probe (from TV lights, l) bathed hearings, but revealed nothing startling. Most innocuous was 25-min statement against discrimination read by Francis Cardinal Spellman (far r), archbishop of New York. He referred only once to housing, was asked no questions by Commis-

sioners (on dias, from l) Doyle E. Carleton, former Florida governor; Rev Theodore M. Hesburgh, president of Notre Dame; Dean Robert G. Storey of Southern Methodist law school. Missing is Chairman John Hannah, president of Michigan State, who opened hearings, left after first day session.

## SEGREGATION:

# Klieg-lit hearing airs cries for more federal action

"It would be unrealistic," New York City's Mayor Robert F. Wagner told the federal Civil Rights Commission, "to assume that any set of laws . . . will automatically abolish discrimination overnight."

Blinking in the glare of television floodlights, surrounded by the scurry and clatter of press photographers at work, Bob Wagner gamely read on from his speech welcoming the commission to New York: "It must be accompanied by broad educational programs . . . to establish democratic principles in housing . . . the federal government must set a moral climate."

Two weary days and 36 fast-talking witnesses later, the commission closed its first look into the nation's minority housing problems. It packed back to Washington a ream of testimony that boiled down to little more than Bob Wagner's opening bromide, buttressed and re-buttressed.

Consensus of most: that the "moral climate" to be set by the federal government should include open occupancy requirements for all federally-aided housing, public and private (including FHA and VA), plus new programs to increase the supply of low-moderate income housing and encourage private industry to build open occupancy housing at all levels.

Lone dissenter was Gen James Andrews, speaking for the Real Estate Board of NY: "To introduce compulsory integration into private housing seems to us monstrous . . . and could become the first step toward demolition of all our private rights."

"There are many good people who believe that private housing can be integrated ra-

cially today . . . we suggest they translate their conviction into action and construct housing for integrated occupancy. Perhaps we all will learn something."

To which Big UR Builder James Scheuer answered: "I have personal knowledge of the integration of existing projects involving several thousand units of housing . . . If I did not think that a policy of nondiscrimination was good business as well as good morals, I could not possibly invest, for myself and others, large sums of money in such a program."

Chimed in Builder-Banker Emil Keen, past president of NY homebuilders: "Builders alone cannot successfully create open occupancy developments. At the very least, mortgage lenders must be similarly inclined." His pump-priming suggestion (which he had sought unsuccessfully to sell *in toto* to NAHB directors): that the President release \$250 million in available FNMA funds to buy mortgages on open occupancy developments at par, to "encourage builders to experiment in this relatively untried field."

Negro Businessman (and ex-ballplayer) Jackie Robinson told of his own vain search for a home in the city: "We finally were able to settle in Stamford (Conn.) due to the strong efforts of some very wonderful people there." And of taking part in a plan to build 1,300 integrated apartments in Brooklyn, only to have the project stymied: "The authorities said we couldn't build because the ground wasn't sufficiently firm. . . . Today, there are apartment houses on that site . . . for whites only."

But most testimony was dry exposition of

New York's antibias machinery, earnest but well-worn descriptions of how segregation blights lives, communities. Example: "If the population density in some of Harlem's worst blocks were translated in larger terms, we could fit the entire population of the United States into three of this city's five boroughs." Said one nationally known expert on minority housing problems, himself a witness: "This is the most complete catalog of clichés on the subject I have ever heard."

Racing through a jammed schedule of witnesses, the commission took little time to question many. When it did, the tone was gentle. Main question (asked by Acting Chairman Rev Theodore M. Hesburgh, president of Notre Dame university): What effect would federal antidiscrimination action have on the future of the national housing program, especially in the South? Answers varied from admissions of concern that it might result in money troubles for federal housing programs, caused by segregationists in Congress, to James Scheuer's blunt, "It's time to fish or cut bait."

Banker Earl Schwulst, chairman of the Commission on Race & Housing, hit federal inaction for fostering inequalities in private housing (FHA & VA), and PHA took a special blast from Roy Wilkins, executive director of NAACP. He said it "still follows a laissez-faire policy which allows local authorities to enforce segregation." Wilkins called FHA more enlightened because it "now fully supports . . . the principle of open occupancy" [even though lack of local statutory support makes the support ineffective in many areas].

NEWS continued on p 76

Photos: H&H staff



**VICTIM ROBINSON**, ex-Dodger star: "Beanballs are still being thrown in the housing field as well as on the baseball field."



**REALTOR ANDREWS**: "We must confront reality as we find it . . . allow our people . . . to continue to live as they have in the past."



**BANKER SCHWULST**: housing is "the only commodity not available on equal terms to all members of our society."



**BUILDER KEEN**: home builders did not create the discrimination problem, but "we cannot ignore our obligation to find solutions."

# High



*High Fashion* Truscon Metal Lath and Accessories provide walls and ceilings that are truly straight, reinforced for greater strength. Easy to install with no muss, no fuss. Recommended for the finest homes.



*High Fashion* Truscon Steel Sliding Closet Doors open with a finger tip—close with a whisper, roll smoothly and silently on nylon rollers. More floor space, more storage space. Easy to install.



*High Fashion* Republic Steel Kitchens set the style for modern living with built-in work center conveniences homemakers want most. Stay-lovely base and wall cabinets to meet every kitchen plan.

# Fashion

## TRUSCON

### 138 DOUBLE-HUNG STEEL WINDOWS

Choose the simple elegance of Truscon Series 138 Double-Hung Steel Windows for lasting beauty and home value. Trim, slim steel sections are graceful, never out of style, blend with all architecture from traditional to modern.

All steel construction. No shrinking, no warping, no splintering. Full length stainless steel weatherstripping keeps outside air out, ideal for air conditioning. Chemically treated and prime coat enameled for easy paint-to-match decorating. Sizes for every room . . . including the new high-wide-and-handsome "picture window" up to 5' wide, 6' 5½" high. For low installed cost, low maintenance cost — weathertightness and simplicity of operation — insist on Truscon 138 Double-Hung Steel Windows. Call your Republic-Truscon dealer representative. Or, send coupon for more information.

**WEATHERTIGHT**—all steel construction, plus, full length stainless steel weatherstripping keeps outside air out, inside air in . . . ideal for comfort control air conditioning.

**BALANCE SPRINGS**—each sash is suspended by stainless steel tapes from two enclosed motor-spring type spring balances. Designed for smooth operation and years of service.

**STURDY CONSTRUCTION**—steel is strong, resists twisting, can't warp or swell, shrink or rot, rattle or stick. Frame and sash members are made of heavy-duty 18-gage steel.



**EASY TO OPERATE**—Truscon Series 138 Double-Hung Steel Windows are easy to open, easy to close, with finger-tip action for ventilation control. Simple, safe, sure operation.

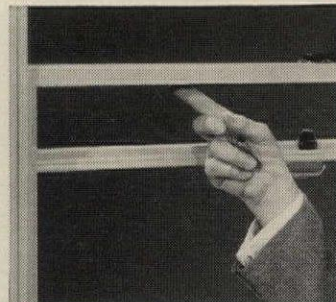

## REPUBLIC STEEL

*World's Widest Range  
of Standard Steels and  
Steel Products*



**REPUBLIC STEEL CORPORATION**  
DEPT. HO-6602-A  
1141 REPUBLIC BUILDING • CLEVELAND 1, OHIO

I want to know more about the following Republic-Truscon home building products:

- Truscon Series 138 Double-Hung Steel Windows  
 Metal Lath and Accessories       Sliding Closet Doors  
 Republic Steel Kitchens

Name \_\_\_\_\_ Title \_\_\_\_\_

Firm \_\_\_\_\_

Address \_\_\_\_\_

City \_\_\_\_\_ Zone \_\_\_\_\_ State \_\_\_\_\_

**Gov Stratton says owner has housing rights, too**

Illinois' Gov William G. Stratton has taken a stand firmly opposed to extending civil rights to the sale of privately owned housing.

"You are in effect telling a man his home is no longer his castle," Stratton told a governors' conference on civil rights in Detroit. "I think you would destroy the right of private property if you went that far." He added that he could not conceive of a court upholding a law which tells an individual property owner he cannot sell to anyone he chooses.

**Open occupancy building lands 77% white tenants**

A private Chicago apartment project is giving new evidence that integrated housing does not automatically become non-white housing, even at the edge of a Negro ghetto.

The first of five 19-story buildings planned for Draper & Kramer Inc's Prairie Shores development, now fully rented, shows two outstanding characteristics:

- Tenancy has settled at 77% white—with no need to impose quotas on tenant selection, says Ferd Kramer of the mortgage and management firm.
- Most tenants are married couples or single persons, with only a few children in the building, mostly pre-school, none of high school age.

Apartments in the 342-unit building are designed for just such a tenancy, include only efficiencies, one-and-two-bedroom units.

"Nobody is trying to make a sociological point," says Kramer. "These people just recognized a hell of a good buy when they saw it." Units rent for an average of \$33/room, against \$45-65 for comparable new rental housing in the city. Can it make a profit? "We think it is economic," says Kramer.

Lying near the shore of Lake Michigan, just west of Michael Reese Hospital, the project is in accord with long-standing area renewal plans which were sponsored by the hospital. It is just next door to Chicago's well-publicized pioneering experiment in private open-occupancy housing, Lake Meadows, which carved the heart out of some of the worst of the city's Negro slums.

Like Lake Meadows, Prairie Shores is built on cleared slum land purchased at use value (50¢/sq ft) from the Chicago Land Clearance Commission. But its racial mix is in sharp contrast to Lake Meadows' 20% white occupancy.

At least part of the high white occupancy in Prairie Shores is, Kramer admits, due to the potential market for the new building—Michael Reese has long needed nearby housing for doctors and nurses, had difficulty getting enough staff personnel because of the lack. But a survey of 200 white tenants shows that only 28% are Michael Reese people, another 11% medical professionals from other hospitals. The rest run the gamut from Kramer himself, who sold his oversize North Shore residence to move into the new building, to a radio-TV repairman.

"Seven out of 10 came from areas where they had little or no contact with Negroes before," says Kramer. Advertising for the project was city-wide in newspapers and radio—but supplemented with vigorous canvassing of industrial and business firms.

NEWS continued on p 83

No. 266—Double width size 16' x 7' with Glide-O-Matic Self Opening, double adjustable brakes, prefitted, prebored door sections. Just one of the many sizes in the Deluxe No. 200 Series—for those who want the best.



**BEAUTIFUL STYLES FOR EVERY PURSE**

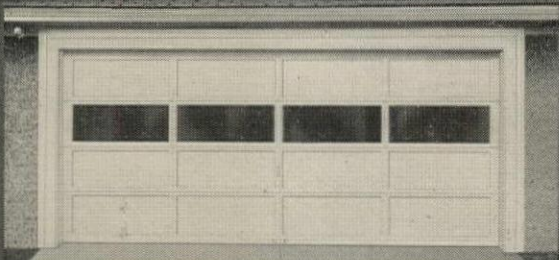

No. 426—Double width, size 16' x 7' with patented Safety Catch, prevents back-and-forth movements when opened. 17 other sizes and styles in the No. 400 Series—priced to sell competitively, but including many exclusive Frantz features.

**SMOOTHEST TROUBLE FREE OPERATION**

No. 1259—Single width, size 9' x 7'. Other sizes are also available to fit single and double width openings. Here is a low cost door that is a "miracle" of value and a miracle in operation. One of the most featureful in its price line ever designed.



**EASIEST OF ALL TO INSTALL**

**FRANTZ GARAGE DOORS**

*with the features your customers want most!*

Over 100 designs and sizes in Frantz sectional and one-piece doors, extension spring and torsion spring types... for residential or industrial use... give you the widest selection possible. Open a Frantz Door and you will quickly see its amazingly easy operation. Anyone can install a Frantz Door, too. The instructions are so detailed, the steps so simple. And Lumber Dealers know the high quality of Frantz Construction—zinc-plated hardware, with wood sections styled by master craftsmen that are unsurpassed for beauty and lasting satisfaction. National advertising is stepping up the demand for Frantz Doors. Why not get your order in now!

Get these new catalogues at your Lumber Dealer



**FRANTZ MANUFACTURING CO., STERLING, ILLINOIS**

## URBAN RENEWAL:

## New York, nudged by federal threat, finds self-help ways to fight slums

Last June, New York City solemnly assured the federal government that it was making progress in "a continuous effort to improve code enforcement . . . looking to the correction of substandard and the protection of standard housing."

The assurance was one of several vital to recertification of the city's "workable program"—without which it cannot qualify for continued federal grants for public housing or slum clearance. HHF Administrator Al Cole may have blinked, but he signed the certification.

By November, federal brass was balking instead of blinking. Walter Fried, regional HHF Administrator, chided the city for letting slums grow faster than UR could do away with them. He hinted that unless enforcement was pepped up, the government might pull out of the show. The hint was gentle, but barbed. It carried a warning that other cities working with federal funds could well heed. And as New York, the nation's biggest city, scurries to preserve its lion's share of urban renewal funds\*, it provides some classic studies in good and bad anti-slum tactics.

Fried's barb was thrown at the dedication of the first three buildings in Manhattan's \$15 million Park West redevelopment project, before the very officials who are responsible for the city's housing code enforcement. Pointing out that \$60 million in federal money has already been sunk into one part of the city's deteriorating West Side, Fried said: "Despite the magnitude of this . . . investment of the taxpayers' money, we are making only a slight dent in the blight we can see all around us. Meanwhile, other parts of the neighborhood continue to deteriorate . . . unless there is marked improvement in the conservation efforts of the city . . . the federal government shall be compelled to review the entire Title I program in New York City with a view to necessary changes."

### Massive attack—and backfire

Result: a "massive attack" on slums ordered by Mayor Robert Wagner. First move: task forces of inspectors hit 11 buildings on the West Side, found 1,000 violations, only to have a teenage boy crushed to death in one of the buildings five days later as he tried to escape from a falling elevator. City officials explained that the mass of violation reports produced by the "crash" inspections had buried an earlier complaint about the unsafe elevator.

This lurching start was almost immediately followed by a storm of scandals involving charges of bribe-taking by slum building inspectors, and the resignation of the deputy commissioner, Mrs. Bernice P. Rogers, who had led the task force. Despite the city's assurances to HHFA only seven months before, she now charged her staff was inadequate for its job and so demoralized it "cannot cope with current problems" (*Feb. News*).

The headline-grabbing act continues to backfire as more building department bribe scandals erupt, but Mayor Wagner has shifted his sights from frontal assault to long-range strategy, is belatedly asking a legislative program designed to give the city elementary tools it needs for the enforcement job. Among them: a proposal to make slum fire insurance rates depend on compliance with building codes, provide for denial of insurance in extreme cases. Under the plan, resi-

dential buildings will be inspected by a rating firm as well as city departments, findings exchanged and fire rates set according to presence or absence of violations. A proposed amendment to the state insurance law would provide for voiding insurance where uncorrected violations lead to conviction.

### Closing up ratholes

Other requests to the legislature and the city council would:

1. Amend the city code to allow the city to take over dangerously neglected buildings as receiver if the owner is absent or cannot be located for prosecution.
2. Streamline slumlord prosecution by giving magistrate courts power of final disposition, instead of allowing a second trial in general sessions court, as at present.
3. Set a minimum fine of \$25 for all first violations of the city's multiple dwellings law. There is no minimum now.
4. Require landlords to certify that information on building registration certificates is correct; make falsification a criminal act.
5. Make registration certificates prima facie evidence of ownership in legal proceedings against a building.

### Meanwhile, back in the slums . . .

As the city makes the belated and perhaps naive discovery that lengthy, costly prosecution under its police power is not the only way to force slumlords into compliance, skirmishes against the few slum operators who have been taken to court, and further fireworks in the building department, are providing added diversion. Items:

- Agents for the tenement in which the boy died were fined \$2,675 and one of them sentenced to a term of one year. He is appealing. The state rent commission reduced rents in the building from 18% to 34%, on grounds of poor maintenance and lack of elevator service.
- Solomon Chodorov, 55, despite his protests that he is only a rent collector for Boyd-Wyckoff Management Corp, spent six days in jail, then was placed on a year's probation for failure to provide heat in a tenement managed by the firm.
- Fire inspectors closed another Boyd-Wyckoff tenement as unsafe when they found supporting timbers rotted away in the basement. Seeking Chodorov to serve summonses

spawned by the inspection, they knew just where to look: in municipal term court, where Chodorov was on trial for other violations (among them: a no-heat charge on that very building).

- The building department, caught napping, hailed four inspectors who had gone through the building in recent weeks, asked them to explain why they did not, as they should, go into the basement and find the rotted beams themselves.

- Efforts to find the real owners of the Boyd-Wyckoff buildings became a game of hide and seek when a 22-year-old real estate salesman listed as president of the owner companies appeared to say he had no connection with them, but might have signed incorporation papers at the request of his former employers at Boyd-Wyckoff. At this, building department sleuths who have sought in vain since July to chat with Banton Wyckoff of the management firm, threw up their hands, called for police help. Top cop Stephen Kennedy agreed to use his men, armed with warrants for Wyckoff's arrest.

- New York District Attorney Frank Hogan's special grand jury on building graft indicted a department complaint taker for seeking a \$350 bribe, heard testimony about a "man upstairs" who set the price which the employe allegedly asked.

- Rev James A. Gusweller, who started the new graft scandals with year-end disclosures of bribe-taking in his slum-laden West Side parish, revealed that a retired building inspector had told him of a "smooth-working clique" for extortion and real estate manipulation that allegedly reached from the top to bottom of the building department. The minister was not, however, able to persuade his source to go to authorities with his testimony.

- Peter J. Reidy, appointed to head the building department in its December shakeup, defended his department: "I can't believe the district attorney or the (city) department of investigation aren't as good as they used to be, or that grafters have become so much smarter." Then, foot firmly in mouth, he added: "The only other conclusion is that whatever graft there is in the department is not of 'system' proportions."

- The city investigations dept, which has been conducting its own investigation of building graft in comparative quiet, added seven lawyers and three engineers to its staff, assigned to scrutinizing Reidy's department.

- The building graft probe extended to another borough as Brooklyn District Attorney Edward S. Silver pressed charges against a Brooklyn building dept aide for mutilating and destroying records on several buildings.

Silver asked that the county rackets grand jury be ordered to seek further evidence of graft in the office. A flood of complaints from other parts of the city, spurred by newspaper accounts, indicates the probe will spread.

### Slum doctors' dilemma

But as the city struggles toward honest, effective enforcement, one dilemma lurks unsolved: occupancy laws, designed to prevent overcrowding, and basic to the whole problem of slums, are unenforced as a matter of policy. One official says, "Where would these people go? . . . there isn't enough housing in the city. Can we throw children out on the sidewalks?"

Yet the longer the laws are unenforced, the worse the problem gets.

NEWS continued on p 86

\*\$178 million, 14% of the national total of \$1.3 billion in outstanding capital grant reservations.



# Win yourself this carload

*while you get acquainted with America's broadest*

*Big promotion going on!* Two weeks from now, this same Flintkote flatcar starts rolling into big space ads in LIFE and SATURDAY EVENING POST. Other powerful selling ideas are coming up in READER'S DIGEST too. The purpose: to demonstrate that Flintkote makes the broadest line of building products in America, and to help everyone who moves Flintkote products into the homes of America.

While the whole country's getting a look at the length and breadth of Flintkote's line . . . you can cash in . . .

win yourself every can, case and carton you see above!

Or you can win the equivalent in cold cash . . . \$5000. Or win one of 121 other cash awards!

#### EASY TO ENTER!

Read the official entry rules (right). Complete the entry blank in this ad and mail it to FLINTKOTE CARLOAD CONTEST, Box 7A, Mount Vernon 10, New York. Hurry! Each entry must be postmarked no later than April 15th, 1959 and received by April 21st, 1959.

#### Nothing to buy!

#### 122 chances to win!

#### GRAND PRIZE

#### Three choices:

- The products shown on the flatcar illustrated.
- The equivalent in Flintkote Building Products of your choice.
- The cash value, \$5000.00.

#### Plus 121 Cash Awards

- 2nd Prize . . . . . \$500 cash
- 20 third prizes, each \$100 cash
- 100 fourth prizes, each \$25 cash

***Enter today! Flintkote's \$10,000 CARLOAD CONTEST***



# Guess

*how many building products the Flintkote Company makes and guess the total shipping weight of the products on this flatcar.*

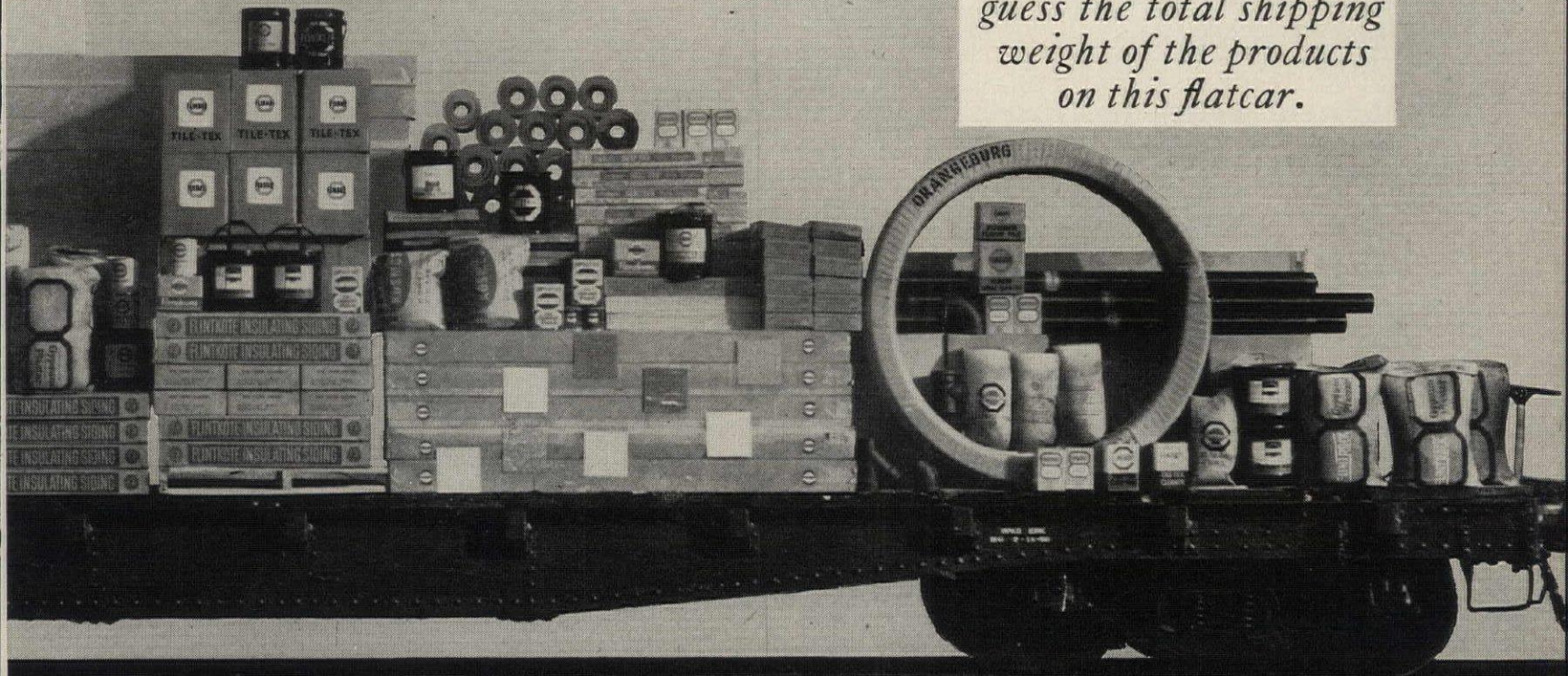

**(or \$5,000 in cash)**  
*line of building products*

## FLINTKOTE CARLOAD CONTEST RULES

(1) Only one entry per person. Each entry must be mailed separately and may be submitted on either the official entry blank or on ordinary paper bearing your name and address.

(2) Entries will be judged by the Reuben H. Donnelley Corporation on the basis of accuracy of answers to (a) the number of different products the Flintkote Company makes and (b) the total shipping weight of all the products shown on the flatcar in this advertisement.

(3) In the event of a tie, tied contestants will be asked to complete the following statement in twenty-five words or less: "The Flintkote line of products is a good line because . . .". Ties will be broken by judging these statements on originality of thought, logic, clarity and conciseness of expression. In the event of a final tie, duplicate prizes will be awarded. The decision of the judges is final.

(4) This contest is open to all dealers, distributors, builders, specifiers and architects in the continental United States and Canada, except employees (and their immediate families) of The Flintkote Company, its affiliates and their advertising agencies.

(5) This contest is subject to all Federal, state and local laws, ordinances and regulations, and is not open to contestants in any area where state or local laws, ordinances or regulations render participation illegal.

(6) All entries, contents and ideas therein become the property of the Flintkote Company to be used as it sees fit.

(7) Winners will be notified personally or by mail about six weeks after the close of the contest. Names of the winners will be available about 60 days after the close of the contest to those sending stamped, self-addressed envelopes to FLINTKOTE CARLOAD CONTEST, Box 7A, Mount Vernon 10, New York.

### OFFICIAL ENTRY BLANK FLINTKOTE CARLOAD CONTEST

The number of building products made by the Flintkote Company is .....

The total shipping weight of the products shown on the flatcar is ..... Pounds, ..... Ounces.

Mail to:  
FLINTKOTE CARLOAD CONTEST,  
Box 7A, Mount Vernon 10, N. Y.

NAME \_\_\_\_\_  
COMPANY \_\_\_\_\_  
BUSINESS ADDRESS \_\_\_\_\_  
CITY \_\_\_\_\_  
STATE \_\_\_\_\_  
ZONE \_\_\_\_\_



## NAHB CONVENTION:

# Builders veto leaders, ask more US money for mortgages

## Directors want \$1 billion more for Fanny May Program 10, but agree VA rate boost simpler

Should homebuilders seek a pipeline to the US Treasury to let them respond to the popular clamor for more low priced new homes even though such a subsidy might prove only a short-term benefit that could plague them with trouble later?

Or should those who might profit forego subsidy now for the long term good of their \$20 billion industry?

These trying questions underlay a memorable debate by NAHB directors—the hottest controversy (and least reported story) of the January convention. The issue: should NAHB ask Congress to vote more Fanny May special assistance funds for its celebrated Program 10—par money for FHA and VA mortgages on homes priced at \$13,500 or less?

At San Antonio last September, NAHB's 1958 board of directors voted to refrain from pressing for more Program 10 funds. It was a self-denying motion. The \$1 billion of Fanny May Program 10 money, set up by last April's Anti-Recession Housing Act, was all committed. Builders who took quick advantage of it had apparently become the beneficiaries of a \$1 million windfall they never sought (the idea was spawned by Sen John J. Sparkman (D, Ala.) chairman of the Senate housing subcommittee). In accordance with the law, Fanny May had borrowed the \$1 billion from the US Treasury—a setup denounced at the time by President Eisenhower as an inflationary addition to the national debt. Fanny May loaned the \$1 billion at par—a price that was, depending on the state involved, anywhere from 2% to 6% above the then-market rate for FHA and VA money. The average Fanny May Program 10 loan was \$12,000. An average 4% subsidy on the loans that financed its 82,998 homes apparently meant some \$1 million in extra profits for the builders who got in on the plan.

But how many builders had moved fast enough to get some of the Program 10 money? Far from a majority of NAHB's estimated 16,000 builder-members. As the convention opened, the 1958 directors overruled NAHB's executive committee and reversed their San Antonio stand.

### Sparkman surprises

The question might have died there. But next day, Sen Sparkman surprised convention-goers by announcing he opposed any more subsidized Fanny May money for \$13,500 homes.

NAHB leaders agreed with Sparkman. So when the 1959 NAHB directors met for the first time as the convention neared its end, word seeped out that reconsidering the association's stand on Program 10 would be the first order of business. The directors more than filled up the spacious Waldorf room of the Conrad-Hilton. They took up routine matters, waiting for the executive committee—delayed in a session in another room.

Then the officers and executive committee-men strode in; it took only a few minutes to get into the Program 10 debate. Small Builder Ernie Zerble of Mason City, Ia., moved that the directors ask Congress to limit Program 10 funds to 50 commitments per builder—a result of complaints that big builders and mortgage bankers got most of the original \$1 billion. "We want to prevent a cornering of the market," pleaded Zerble.

The argument was academic. His motion and others were tabled as the core issue came to the floor: should NAHB ask any more money for Program 10 at all?

### 'Out-Bellamah Bellamah'

Rodney Lockwood of Detroit, a past president (1949) of NAHB, opened the debate. He promised that if Congress did authorize more Program 10 money he would "out-Bellamah Bellamah." He referred to Dale Bellamah of Albuquerque, who got commitments for \$15 million of the Fanny May Program 10 money and was still an outspoken advocate of more.

But, Lockwood added: "I think it is wrong for us to ask for more money for this program . . . We know the Administration is opposed to it . . . We would be damaging our public relations posture to reverse our

**NEW OFFICERS** elected by NAHB in Chicago (l to r): Leonard Frank, 54, Hicksville, N.Y., veteran Long Island builder and vice-chairman of the National Housing Center, treasurer; Martin L. Bartling, 42, Knoxville, Tenn., builder of the 1958 Knoxville research house and trustee of the NAHB Research Institute, first vice president; Carl T. Mitnick, 54, Merchantville, N.J., president; E. J. Burke, 38, third-generation builder from San Antonio, Tex., second vice president; W. Evans Buchanan, 44, Washington, D.C., former local chapter president. Buchanan had the only opposition. But the other candidate, John Beatty of Miami, withdrew before the election.

stand [of San Antonio] and come out for special assistance when the Administration and our best friend in Congress (Sen Sparkman) oppose it.

" . . . If we cause the federal budget to go out of balance we will force the government to sell more and more bonds, forcing higher and higher yields and thus hurt us by forcing up discounts and interest rates on the open market."

The most effective spokesman for the southern-southwestern block of directors favoring Program 10 was Donald L. Stone of San Jose. He called Program 10 "the motivating factor that brought out money from other lenders last year."

He continued: "We led the country out of recession and we didn't do it without Fanny May special assistance. Now we need support for the mortgage market again because of fixed interest rates. I believe some areas will be devoid of mortgage money without this program. We must ask for it if we are to have a chance to get it."

### Business too good?

Tom Coogan, another NAHB past president (1950) and now a New York mortgage broker, disagreed: "I think some of you attach too much importance to what special assistance did last year. Remember money had been easing before we even got that money . . . I think you would be placing your officers in a very embarrassing position by asking more special assistance. In our own good best interests we should not do it."

Objected Director Bill James of Myrtle Beach, S.C.: "It seems to me our builders are divided between builders and mortgage-builders and . . ." NAHB President Nels Severin gaveled him into silence. "Let's not start dividing this group up," he cautioned.

James grinned and replied: "Well, don't misunderstand me. I really like you fellas." The directors laughed. Severin is a mortgage banker, too. James took another tack: "We are being discounted out of business. I know that my membership back home wants me to vote for special assistance. But next time let's keep it in the hands of homebuilders."

### Like farm subsidies

At the request of someone from the floor, Severin gave up the gavel to state his own attitude, left no doubt that he opposed more Program 10 money (even though he could profit from it personally), fears it could jeopardize the entire housing bill.

"With starts at this high rate we can't persuade anyone that we have to have

Treasury money to keep going . . . You are asking for a program that is just like the subsidies the farmers get . . . Let's not build a reputation as an industry that always has its hand out," he implored.

Though no one realized it at the time, Builder-Realtor Frank Burns of Denver then offered the amendment which made policy on Program 10 palatable to everyone. He proposed an amending phrase that Congress authorize more special assistance funds or boost the FHA-VA interest rates to reflect the current rate of money. It was approved.

Roland S. Catarinella of Pittsburgh, had the last words: "Our answer to the public housers in this country must be a big program of low and middle cost housing. We need special assistance to do it."

Then the vote—by upraised arm—was 123 for more special assistance, 116 opposed.

### Graceful way around

The top men of NAHB seemed to be saddled with a policy they opposed. But they handled the hot iron with aplomb.

The final NAHB policy statement carried only this reference to special assistance, not even identifying it by name: "Insistence on an unmarketable VA interest rate forces acceptance of proposals to correct recurrent instability in our industry to purchase of mortgages with federal funds."

Asked about policy on Program 10 at his first press conference after his election, new NAHB President Carl Mitnick replied: "If we get a realistic increase in the VA rate we would not ask for this [the \$1 billion special assistance]. To do volume building in this country you have to have a VA program. We are not for direct loans."

He carried this same message to Congress. More money for Program 10, he told the Senate banking committee, is an "alternative" which "provides only temporary relief." But he added: "We are forced to suggest this if the simpler and more effective step of permitting adjustment of the interest rate is not taken."

By mid-February, it seemed clear that Congress would choose Mitnick's "simpler and more effective" means to revive the dying VA program. In the House, the veterans affairs committee plumped for a ½% boost in the VA rate (to 5¼%). The Senate did the same. Neither the Senate version of the 1959 Housing Act (see p 42) nor the bill reported out by the House housing subcommittee provided any more money for the short-lived, controversial Program 10.

Photos: H&H staff



**HOUSING CREDIT** machinery needs "basic overhaul" to end mortgage money "feast or famine," warned NAHB's John Dickerman (promoted to executive vice president). He rapped "political solutions . . . with the US Treasury as the crutch."



**INFLATIONARY PROGRAMS** urged by Rep Albert Rains (D, Ala) won applause from audiences: 1) \$1 billion of direct HHFA 50-year loans for community facilities at 3%; 2) another \$1 billion of Treasury money for FNMA Program 10.



**BUILDINGS WRITE-DOWN** for slum rehabilitation similar to land write-down in slum clearance was suggested by Chicago Builder David Zisook. He said illegally converted buildings could not be corrected profitably otherwise.



**UNSTABLE MARKETS** will continue as long as Congress keeps price-fixing FHA and VA interest, warned Executive VP Grover Ensley of Natl Assn of MSBs. Pumping up FNMA "threatens existence of a private homebuilding industry," he predicted.

## CONVENTION SIDELIGHTS

### Only the name changed?

NAHB has decided that a central mortgage bank by any other name—even Fanny May—would be as sweet.

Its 1959 policy statement, as expected, asks for expansion of Fanny May to perform mortgage bank functions—but the phrase "central mortgage bank," term of reference in all discussion, never turns up.

Reason: among government economists the phrase conjures up an image of a land bank which would monetize mortgages by issuing currency. Builders fear few prospects more—and NAHB has nothing like this in mind. It asks that the Fanny May be recognized only as a government agency to stabilize mortgage credit, rather than a potential private corporation. The rejiggered FNMA would be authorized to:

- Issue short and long term obligations, pledging its mortgage portfolio.
- Sell more securities to the public.
- Make short term loans against the collateral of FHA and VA mortgages.
- Set the FHA and VA interest rates.

FNMA President J. Stanley Baughman dropped a hint at the convention that the Administration will oppose most or all of these changes. Said he: "Major changes can have . . . serious disrupting effects . . . I suggest that any changes should be made gradually—that is, be evolutionary, not revolutionary."

### More research houses

At least one and possibly three NAHB research houses will be built this year.

The research institute will give Michigan State University funds for one house, with details still to be worked out. The institute's trustees have also agreed to co-sponsor with "an appropriate manufacturer" an aluminum house. A proposal from Structural Clay Products Institute that NAHB join it as co-sponsor of a masonry products house is under consideration.

The research institute has adopted new and strict criteria for future research houses. Overriding aim: "to avoid even the appearance of utilizing the research house as a sales promotion effort."

Some NAHB brass who have accepted consultant fees from product manufacturers are coming under sharp criticism inside the builder organization.



MITNICK, MALIK & SEVERIN

A firm voice for world slum fight

### Can US rehouse the world?

"America . . . cannot be satisfied with seeing that homes are built for its own people while millions remain homeless throughout the world."

The convention's final session heard this reminder from Dr. Charles Malik of Lebanon, president of the UN general assembly. He urged a 10 to 50-year plan, starting right away, to enlist US technical skill and money to help peoples everywhere wipe out slums. But he warned: "It takes more than political decision and technical efficiency to realize this vision. An enthusiasm, a passion, a process must . . . capture imaginations and loyalties of people."

### Soft-sell for facilities

NAHB is stepping up its efforts to cope with increasing demands by local communities that builders pay for expensive sewer systems, give cash grants for schools, donate land for parks and other community facilities.

It is taking a soft-sell approach. It is planning a series of "community growth conferences" across the nation at which all sides of this continuing squabble over who-should-pay-for-what will be invited to speak.

This practically guarantees that some experts will belabor builders at their own meetings. But Bob Ledermann, NAHB's new urban renewal-community facilities director, explains builders are taking the view that "what's good for the community in the long run will be good for homebuilders." He adds: "We think all views should have an airing. Let the chips fall where they may."

First two meetings in April or May are planned for Milwaukee, "where things are in a ferment," and Columbus, Ohio.

NEWS continued on p 91

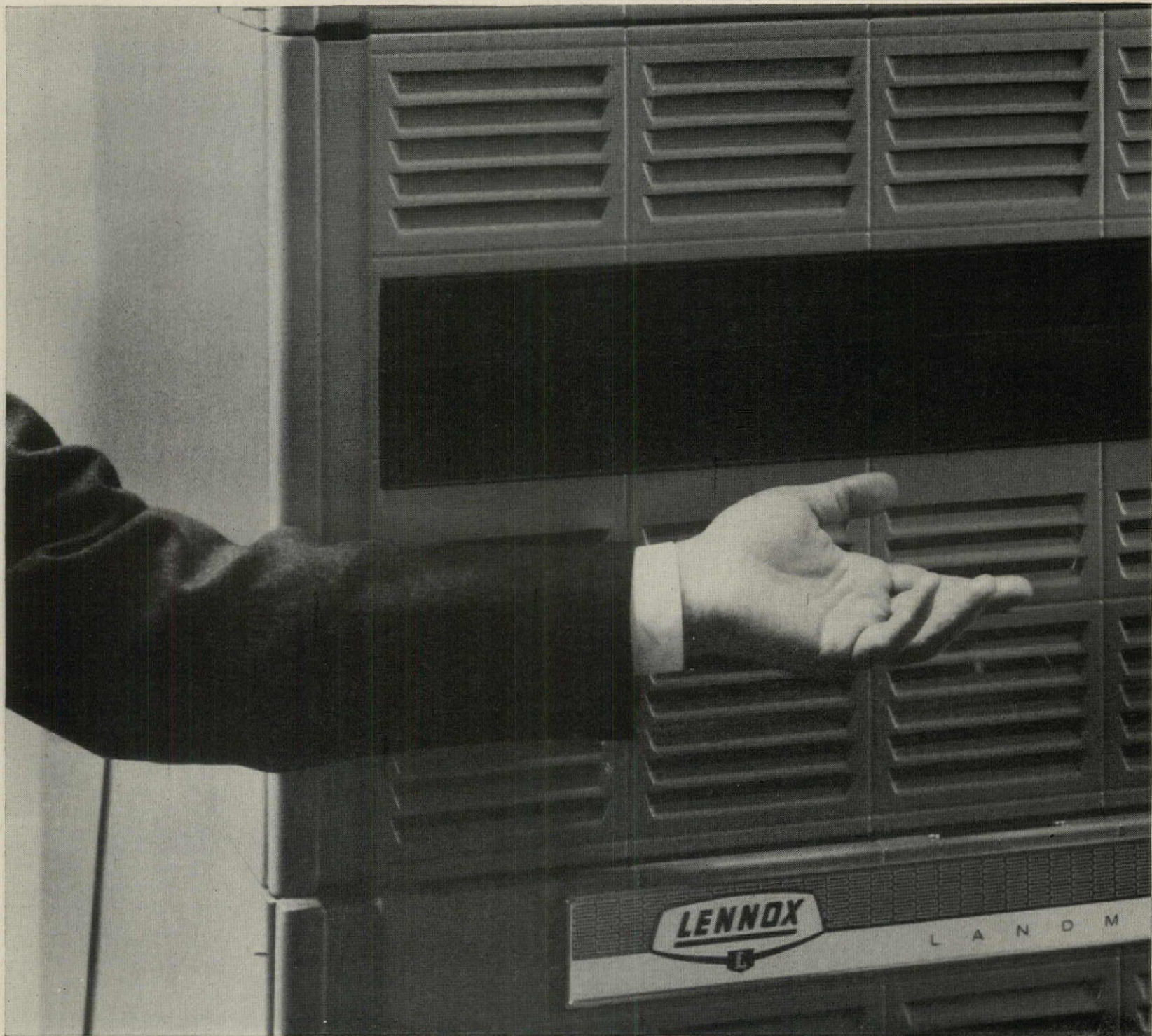

# HOW LENNOX QUALITY WORKS TO SELL YOUR HOMES



## More people know Lennox—prefer it over all other makes of warm-air heating and air conditioning

Good home designs attract prospects, but it takes more than that to sell them. Today's smart buyers want to be sold on the *quality* that goes into your homes, too!

Here's where the Lennox name pays off. For . . .

- Lennox is the most widely advertised name in warm-air heating and air conditioning.
- Lennox is the most widely used brand in warm-air heating and air conditioning.
- Lennox is the name more people know, trust, prefer—in warm-air heating and air conditioning.

Three good reasons why the Lennox name, more than any other in the industry, can do a better job of selling

the *quality* of your homes. *Which means more and faster home sales for you!*

### LENNOX QUALITY WORKS FOR YOU IN OTHER WAYS, TOO.

For example: *all* Lennox heating and air conditioning equipment is planned, installed and serviced by your local Lennox Comfort Craftsman—a man who is engineer-trained, deals directly with a nearby factory, offers the world's largest line of heating and air conditioning equipment.

Get facts on the Lennox merchandising program, which includes professionally planned advertising materials, in-home displays, personalized builder brochures and billboards. For sample merchandising aids, write Lennox, Marshalltown, Iowa.

**LENNOX** ...world leader in indoor comfort for homes, business, schools



©1959 Lennox Industries Inc., founded 1895; Marshalltown and Des Moines, Ia.; Syracuse, N.Y.; Columbus, O.; Decatur, Ga.; Ft. Worth; Los Angeles; Salt Lake City. In Canada: Toronto, Montreal, Calgary, Vancouver, Winnipeg.

## Reflection of Quality in Garage Doors

No matter how you look at it, a RO-WAY Garage Door reflects the finest in quality.

In styling, for example, you can see at a glance how its clean, simple lines enhance the design of the homes you build.

In construction, its selected woods and husky hardware are put together with cabinet-maker skill for lasting service . . . muntins, rails and stiles precision squared for perfect fit; mortise and tenon joints both glued and steel pinned for extra strength; sections rabbeted to make weather-tight joints; surfaces smoothly sanded for finest finish.

In operation, too, every RO-WAY door is unsurpassed. With specially designed Taper-Tite track, ball bearing rollers, and springs tension-balanced to the weight of the door, smooth, quiet performance is assured for years.

Yet, with all this quality RO-WAY garage doors are competitively priced. So why settle for less? Call your RO-WAY distributor for full details—he's listed in the Yellow Pages.

*For added convenience, install the famous RO-WAY Model 80 Electric Operator with push-button or remote radio control*

### ROWE MANUFACTURING CO.

1108 Holton Street • Galesburg, Illinois

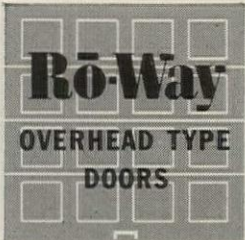

*there's a Ro-Way*  *for every Doorway!*

RESIDENTIAL • COMMERCIAL • INDUSTRIAL

## Are you going broke? New study tells how to avoid it

- For the last 12 years net profits of the average US homebuilder have shown an almost uninterrupted decline—from over 5% to less than 2% (after taxes) on net sales.

- In the same period failures among building contractors (including homebuilders) have risen—from fewer than 200 in 1948 to more than 800 in 1957.

- Only one of 10 US homebuilders has a strong enough financial standing to qualify for a straight commercial bank loan on the assets of his business.

These facts on the plight of the builder as a businessman are dramatized in a new book just produced by US Gypsum in cooperation with NAHB. The punch of "A Blueprint for Profit" is that it tells builders what they should be doing to be better businessmen.

US Gyp believes the study is the most extensive of its type ever undertaken. The analysis and recommendations were by Cresap, McCormick & Paget, the management consultants. Their analysts studied all existing material on the subject, then interviewed more than 110 builders and 25 other individuals who know the business in 22 markets throughout the US.

### Pound of prevention

The resulting 152-page book (it weighs 1 lb), is supplemented by a 30-min color film illustrating the 12 principles of business management developed in detail in the book.

Retiring NAHB President Nels Severin, after looking over one of the 3,000 copies distributed at the convention, praised it and commented: "Maybe the study doesn't go far enough but it is a monumental undertaking and will contribute in a major fashion to the development of our industry."

If builders match this enthusiasm after they study the book, US Gypsum has announced it will spend more money to make new surveys and reports to expand it.

### Complex business

Cresap, McCormick & Paget admit the builder's business is a complex one—because of the many different functions involved and his dual role as a producer and a retailer.

But based on this study, the analysts conclude: "There are strong indications that his [the builder's] position is not as healthy as it should be . . . The typical residential builder has a reputation among businessmen who deal with him, for borrowing heavily, for taking undue risks and for being too casual in the management of his financial affairs . . ."

"Builders . . . still do not enjoy the full support of the business community and the complete confidence of the community at large . . . They have more difficulty obtaining loans and are frequently required to pay higher rates for the use of funds than other businesses of comparable size . . ."

"Many housing economists, moreover, now agree that while the typical builder has made commendable progress over the past 10 years, his present rate of progress is not sufficient to meet the challenge of the future. Yesterday's product, it is felt, is far from adequate for tomorrow's needs. Improvements in the product and its price must be coupled with comparable improvements in management if

full market potentials are to be realized."

Lack of managerial capacity and skill is the underlying weakness in the typical builder's position, the experts report. "Even among the more successful builders, one out of five on the average is deficient in his handling of the functions of business management," they report.

They cite Dun & Bradstreet's report on business failures in the construction industry to support their statement. It shows that in 1957 21.6% of business failures in construction resulted from a lack of managerial experience. Another 24.2% resulted from unbalanced experience—not well

rounded in sales, finance, purchasing and production. (But incompetence—a lack of basic ability in the technical end of the business—was still the chief cause of failures with 38.9%).

"Although many builders are becoming increasingly aware of this need for better business management, few of them so far have schooled themselves in the principles involved," the analysts report.

They spell out these principles with suggestions on what builders should be doing that many of them are not. Sample advice:

- Realize that money management more than

*continued on p 95*

## Profit on liquidation land sales wins capital gains tax treatment

Homebuilders and realtors may now qualify for capital gains tax on some land deals, thus save thousands of dollars on their tax bills.

The legal precedent is still not firmly fixed. But Sylvanus Felix, Oklahoma City tax attorney and builder, says recent developments in the tax courts are encouraging.

"It is possible now," he reports, "to acquire a large tract of land, sell part in the ordinary course of your trade or business and sell the other part as a capital asset and get favorable capital gains treatment on the latter."

Internal Revenue Service opened the way to this new tax treatment a year ago. It



FELIX

held that an individual who had bought 300 acres, part of which he subdivided and sold, was entitled to capital gain on the sale of 65 acres which were not subdivided. During 1958 this principle was affirmed in three other cases.

In one, a builder quit a tract he was developing, sold off his 14 remaining lots in one lump. In another case, a big builder who owned 1,500 rental houses decided to get rid of them, sold them to individuals. In both instances they were allowed to claim capital gains since they were held to be only liquidating an investment—not selling the property in the ordinary course of their business.

Felix warns: "IRS will not relax its efforts to deny capital gains treatment and will do so successfully wherever it has any grounds whatsoever."

"For this reason you must carefully plan every transaction from start to finish where you expect a capital gain benefit. Every step of the way should be documented as fully as possible. Sales should not be made in the ordinary course of your business. Liquidation of an investment for good and valid reasons is an excellent ground for securing favorable capital gain treatment."

IRS also makes a frequency of sales test, has no hard and fast rule. But the builder who sells more than two parcels in a year may have difficulty in winning capital gains treatment.

Three technical changes in the tax laws last year can also save builders money, reports Felix. Items:

1. A small business corporation may now elect *not* to be taxed as a corporation but rather as a partnership. Shareholders must unanimously vote to include their pro rata part of the corporation's income in their own income, whether distributed or not. Operating losses can be carried back or forward by the individual rather than the corporation.

"This is a real break for the builder who wants to take current earnings out of his corporation without double taxation," Felix explains. A "small corporation" is one with 10 or fewer stockholders (with no alien among them), all of them individuals. It must have only one class of stock. It cannot derive as much as 80% of gross income from foreign sources or 20% of gross income from rents, royalties, dividends, interest and gain on sale of stock.

2. For 1958 and succeeding years, a net operating loss may be carried back three years rather than two. It can still be carried forward five years.

3. Property owners forced to sell get wider leeway on tax-free reinvestment of the proceeds. A tiny change in a key phrase makes all the difference.

The change benefits persons who lose property through condemnation or destruction—but for which they are paid.

The law, oblivious to inflation, had required that such owners buy a similar or related property to avoid a tax on the profit. Now, the law requires the substitute property be "of a like kind."

"This 'like kind test' provides a much easier alternative than the 'similar or related property test,'" says Felix. "You can now use the condemnation award on an office building to buy new land, improved or not. As a general rule, so long as you buy new land with the proceeds of any insurance or award covering the converted land, no gain is recognized."

“Andersen Windows  
are so weathertight they  
lick our tough wind problem,  
so trouble-free we’ve  
never had a kickback...”

**Says Nebraska builder of quality homes**

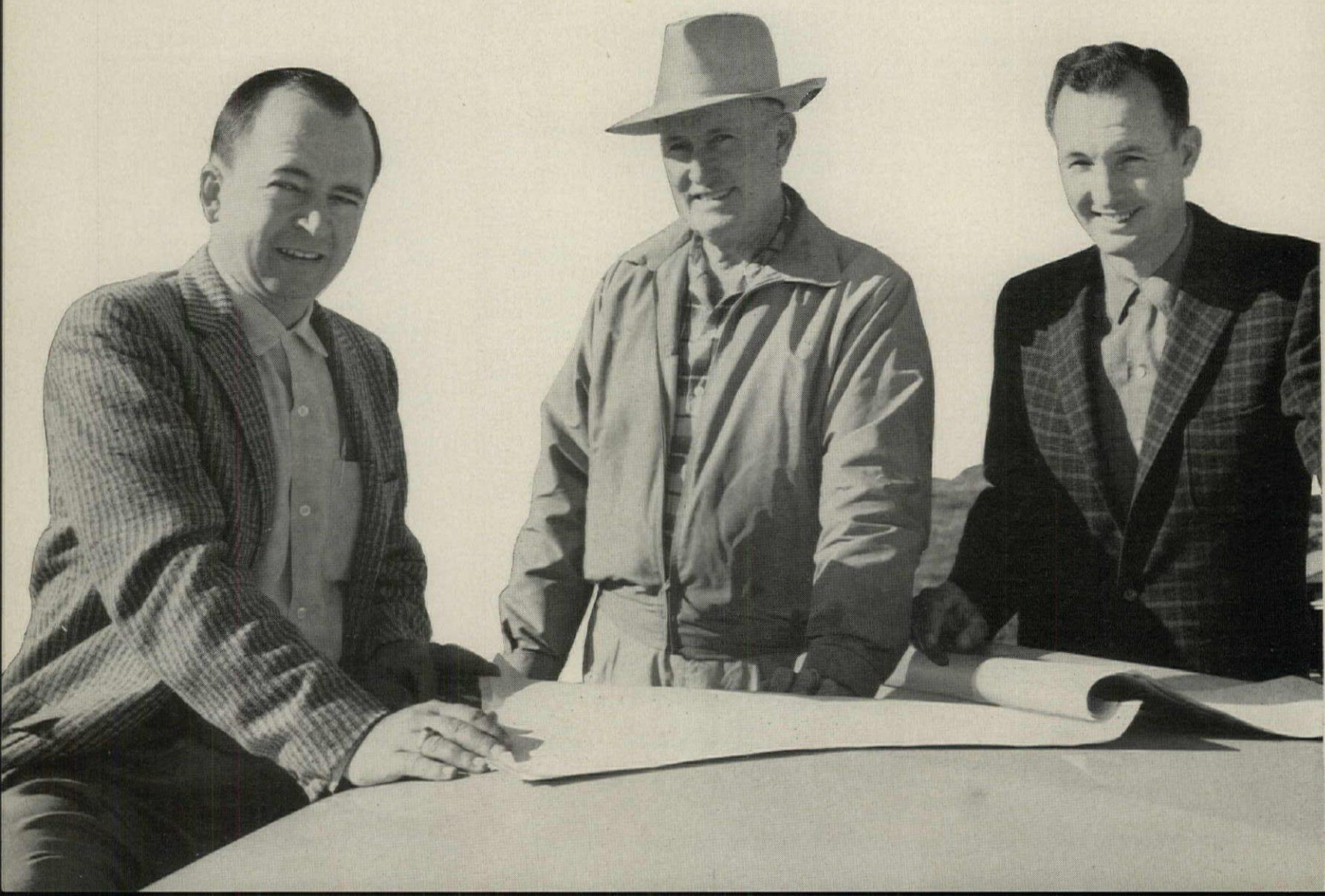



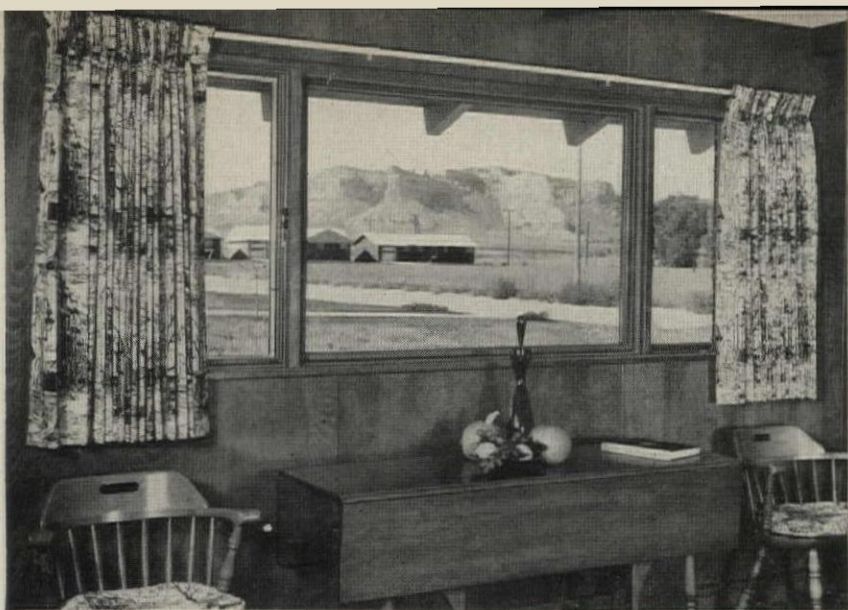

**Extra weathertightness!** Andersen Casements, on each side of fixed glass, seal out high Nebraska winds that buffet the front of this house. Andersen Casement Windows are actually five times more weathertight than Industry Standards require.

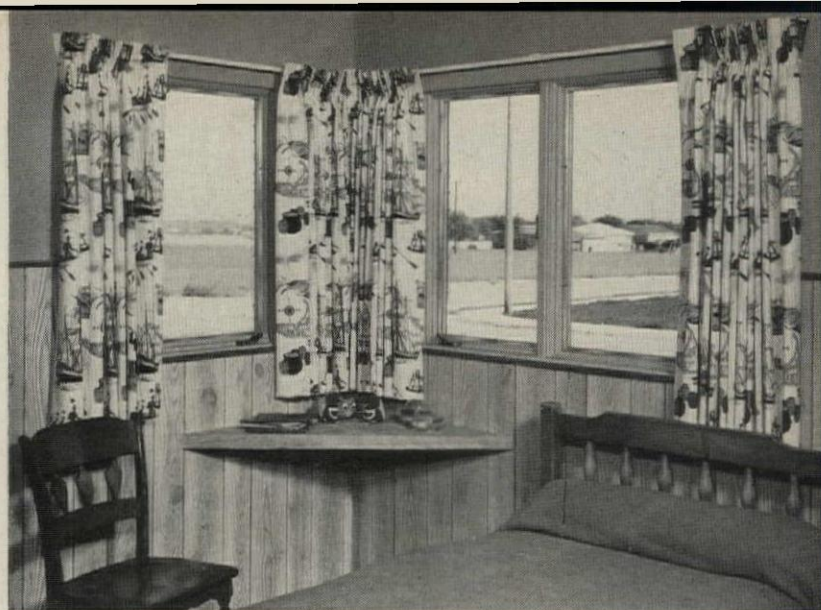

**Extra sales appeal!** Handsome wood sash and frames of Andersen Casement Windows add character, natural warmth and beauty to Reeder Construction Company homes. Penta-treating protects permanently against termites and decay.

“After trying out Andersen Casement Windows, we switched to them 100%,” say Dewey and Delmer Reeder, father and son building team, Gering, Nebraska.

“We have such high wind out here it’s a major problem. Even when most windows are closed, the wind and dust come through so fast the weatherstripping whines. There’s none of that with Andersen Windows. They close weathertight . . . and I mean *really weathertight!*”

“Another thing . . . Andersen Windows are so trouble-free

we’ve never had a single kickback. They definitely have helped build our good reputation and the steady sales we’ve had over the years.”

**Try Andersen Windows.** They’ve helped builders everywhere eliminate trouble, sell homes more easily. They can do the same for you. For more information, see your lumber and millwork dealer, Sweet’s File, or write: Andersen Corporation, Bayport, Minnesota.

# Andersen Windowalls

ANDERSEN CORPORATION • BAYPORT, MINNESOTA



**Dealer Ivan Doll (left) with Dewey and Delmer Reeder.** Reeder Construction Co. development in background features Andersen Windows in \$20,000 to \$40,000 homes.

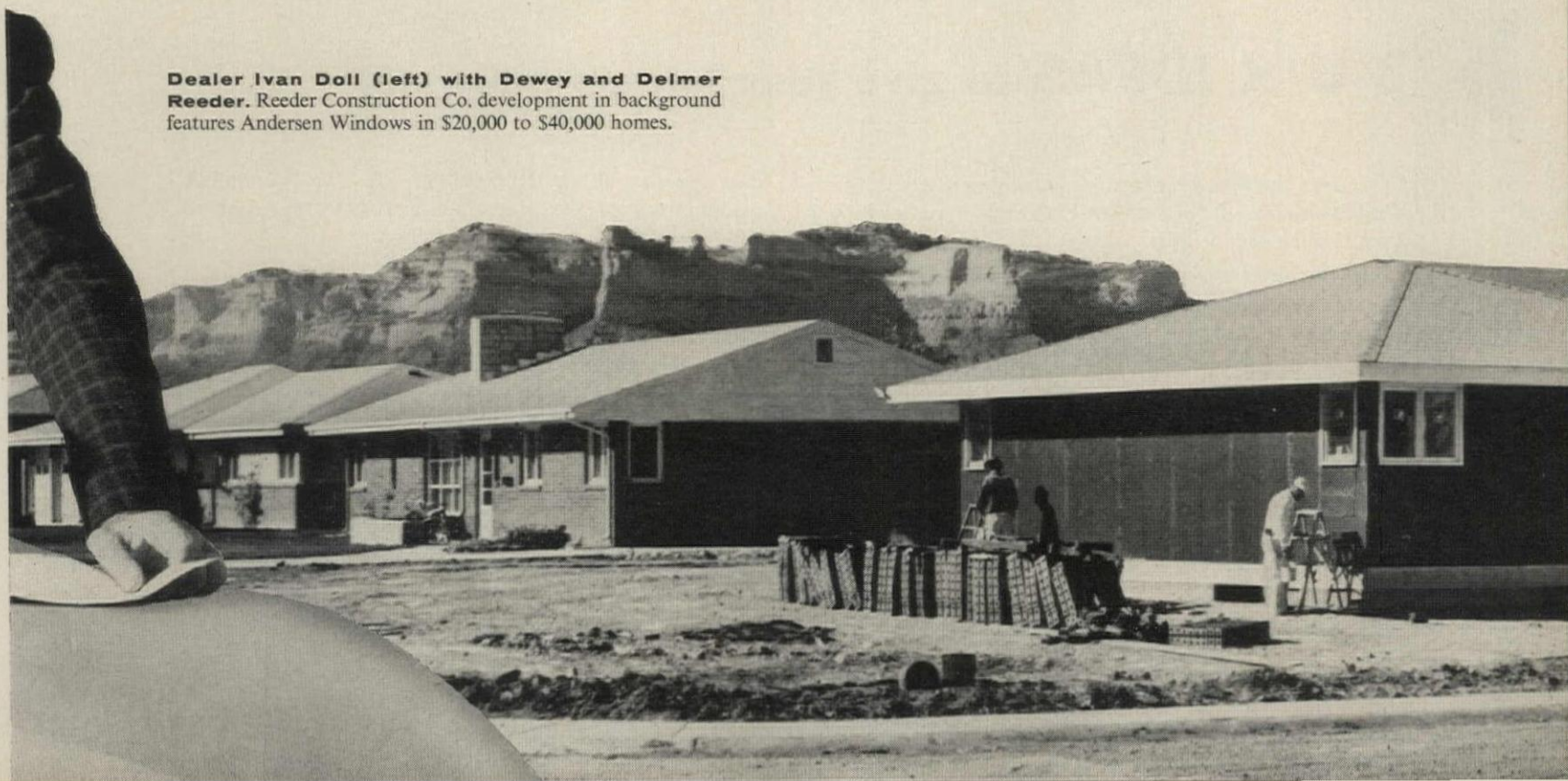

THERE'S A NEW TREND IN BATHROOMS



Small space with big convenience. This bathroom is only 6'8" x 7', and the powder room only 6'8" x 4'. The U/R fixtures are: Versa-Tile® combination counter top and lavatory, Como water closet and Master Meadow recess bathtub.

### 3 U/R IDEAS to give your homes more sell

Yes, there are three modern home-selling ideas in this Ving Smith design for a smart Universal-Rundle "New Trend" bath and a half.

**1. Idea for delightful bathroom beauty.** With its charming cast concrete wall, sparkling hanging light fixtures, and homey details, this striking blue-and-white room is richly useable. Your homes can have buy-it-fast appeal this U/R "New Trend" way.

**2. Idea for compact convenience.** The adjoining powder room adds extra usefulness in small space. The gleam-

ing vitreous china surfaces of the U/R Versa-Tile combination counter top and lavatory are easier to clean, with color-matched loveliness.

**3. Idea for unbeatable value.** Small wonder that more and more builders are specifying U/R plumbing fixtures. Their long-lasting, super hard surfaces, their distinctive design help your homes to offer far more for the money.

Builders and architects are urged to write for the newest U/R catalog to Universal-Rundle Corporation, 546 River Road, New Castle, Pennsylvania.

Universal  Rundle

MAKER OF THE WORLD'S FINEST PLUMBING FIXTURES

Plants in Camden, N. J.; Milwaukee, Wisc.; New Castle, Pennsylvania; Redlands, California; Hondo, Texas.

continued from p 93

getting it, spells the difference between failure and success. "The builder who borrows money and fails to control its flow or, while regulating it, allows his debts to pyramid out of proportion to his invested capital is far worse off than the builder who was unable to borrow at all. There seems to be a pressing need for builders . . . to get to know their bankers better."

• *Take advantage of every discount available.* "A discount of 2% net 30 means the builder is paying 2% interest for a period of 30 days and that he is in effect borrowing money at the rate of approximately 24% a year. Thus a builder who buys \$120,000 worth of materials per year at the rate of \$10,000 per month to complete houses selling at \$200,000 and fails to take his discount is reducing his profit by \$2,400 or from 10% to 8.8% and is also damaging his credit reputation . . ."

• *Set up an accurate cost accounting system* (suggested forms for this are shown in an appendix). The analysts note that lack of true cost knowledge seems to be a primary cause of builder failures. "An accounting system is not just a convenience," they point out, "but an absolute necessity."

• *Save another 5% on costs by proper scheduling.* The management men concede few builders seem to recognize this fact. In detailing how a builder can set up a tight schedule (and get a house built in 30 days), the analysts report many builders complain that a schedule is useless. So many things can go wrong the schedule is seldom met.

Replied the experts: "The point is that such contingencies will occur more frequently and become more serious when there is no procedure for their control."

## Urban renewal: neglected bonanza? Expert sees it as 16% of market

Builders are ignoring big profit opportunities by spurning urban renewal. They are passing up a source of choice land in cities just at a time when the market for close-in town houses—luxury or upper-middle bracket row housing—is rising.

These points are raised by experts who have been there and know.

"Home builders shooting for 1.4 million units in '59 won't make it without an urban renewal program," predicts William L. Slayton, vice president of the big UR firm of Webb & Knapp. Noting that the amount of desirable land within reasonable distances of cities is dwindling, and the cost of improving it skyrocketing, Slayton contends: "Urban renewal holds the key to two problems—land and money. Streets, sewers and utilities are already installed, and a liberal FHA 220 program makes the money, problem easier.

"Many are fed up with suburbia and its long commutes. They want back into the cities. This is only now being recognized.

"The popular idea is that urban renewal is only for large operators like Webb & Knapp, and only for rental properties. This is false. We have sale housing. It can be financed under 220 like 203, with some better conditions. The kind of housing that you can build under urban renewal is different from suburban housing. It is row housing, high density, but it is sales housing and any builder can get into it."

Renewal building could account for as much as 1/6th of residential dollars volume in the next 10 years, estimates Mortgage Banker Albert Keidel Jr, vice president of James W. Rouse & Co, Baltimore. "It's hard to see how builders can ignore it," he adds.

Admitting that renewal has been slow to get going—"local public agencies have been inexcusably slow in making land available for redevelopment"—Keidel notes that after 10 years of preparation, the number of renewal loan applications doubled in the 11 months from Jan '58 to Dec '58.

"There are little trickles of land coming on the market now and more land is going to be forthcoming—but it isn't unlimited. Better go after some of it now," he warns. "The first project is the hardest. The time needed . . . is enough to curl your hair. But just think back to your first 203 project."

If land acquisition problems—getting it released by local authorities—can be overcome, "urban renewal can be big business for the smaller businessman," predicts John Tolan Jr, assistant to the president of Barrett Homes, which has just completed one of the nation's first unassisted Title I projects in Richmond, Calif. (*Jan, News*). But he, too, says time is a problem.

"Urban renewal staffs have emphasized the long-range plan. Builders need short-range plans to work with," he says. But in spite of headaches from red tape, "we liked it and we'll do it again."

## Strikes may be the cheapest way to hold down soaring labor costs

Homebuilders must be ready to take strikes or accept the unpleasant likelihood that union building trades will step up their demands.

Two panelists at a convention session on lowering labor costs made this same point in pleas to builders to put more starch in their negotiating.

Said Helen F. Humphrey, a Washington labor consultant: "It is always less costly to show some courage. I find that when employers don't fold fast in the face of union demands it has not been more costly over the long run.

"Don't assume that any point will produce a strike. And remember that strikes are just as costly to union members as they are to you. They have credit hanging over them, just as you do."

Be careful of non-economic contract demands, Miss Humphrey counseled. Carelessness about these items can cost every builder thousands of dollars over the life of a contract, she warned.

Irvin Yackness, executive vice president of the Detroit home builders, recounted this example: "We had a carpenters' strike last year simply because the union demand was so extensive."

The union not only wanted 45¢ more an hour. They demanded that 1) each builder post a \$2,500 bond to guarantee the contract, 2) one of every six carpenters be 65 or

older, 3) a builder who subcontracts his rough carpentry be required to sub out his trim work also, 4) supervisors be the joint choice of union and builder, 5) a steward be given time off to inspect every job for contract performance and 6) the union have the right to check the builders' books.

The Detroit builders took a five-week strike, settled finally for 15¢ an hour but resisted all other demands.

Commented Yackness: "The success or failure of labor relations is a matter of economic strength—the ability to close down an industry. How close is the balance of economic strength between employers and unions? This decides the success of negotiations."

Yackness reported that suppliers, subs and mortgage men cooperated with Detroit builders during the strike—agreed to forego many bill and note collections temporarily.

Another key factor in successful negotiations is cooperation with the other industry employers. In Detroit, the AGC and the subcontractors negotiate jointly with builders. Said Yackness: "Don't negotiate alone. If you do you find that the unions will use one group against the other."

He continued: "We decided early in Detroit that we must have a large labor committee representative of all builders by size and location. Any association which has a contract

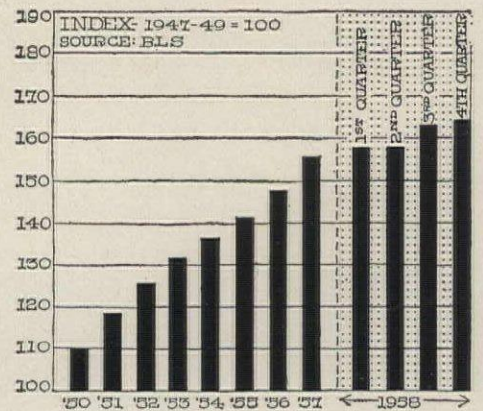

**HOURLY WAGE SCALES** of union building trades inched up 2.4¢ (0.7%) in the last quarter of 1958. This pushed the average rate to \$3.38 an hour—64% above the 1947-49 average. BLS reports scales were higher for one-fourth of the workers in seven trades surveyed in 100 cities.

Bricklayers, with gains averaging 5.6¢, won the biggest boosts. Scales for plumbers moved up 2.9¢ and carpenters, 2.6¢. Average hourly wage by trade: bricklayers, \$3.93; carpenters, \$3.49; electricians, \$3.71; painters, \$3.29; plasterers, \$3.78; plumbers, \$3.76; laborers, \$2.50.

must also have someone who works fulltime on labor matters and an attorney to give expert legal counsel."

Detroit builders also have a vice-chairman and subcommittee for each trade, charged with keeping the full board informed of current problems and enforcement of the contract. *NEWS continued on p 98*

## DeVAC GLASSWALLS®

# HIGH, WIDE and HANDSOME

Your new home and remodeling prospects will be sold on DeVAC GlassWalls at first sight. The clean, modern lines of these porch enclosures frame a wide-angle, floor-to-ceiling view of all outdoors. Weather-tight in winter, wide-open in summer, they provide the kind of versatile living space everyone wants today. The three sliding glass panels that raise and lower

independently are an exclusive, sales-clinching DeVAC feature.

DeVAC offers you a product with a proven appeal in both the new construction and remodeling markets, and backs your selling efforts with an all-out program of consumer advertising. Sell complete porches, or convert porches and breezeways. Every homeowner is a prospect!

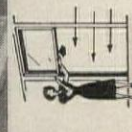

All panels at top-ventilation below head level.

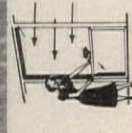

All panels at bottom-draft is off your feet.

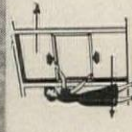

Panels all at center-creates "thermo-air" circulation.

**DeVAC, Inc., Dept. HH-3**  
5900 Wayzata Blvd. • Minneapolis, Minn.

Please send me complete information on DeVAC GlassWalls.

NAME \_\_\_\_\_

COMPANY \_\_\_\_\_

ADDRESS \_\_\_\_\_

CITY \_\_\_\_\_ STATE \_\_\_\_\_

*DeVAC Glass Walls: Extruded from high-grade heavy-duty aluminum . . . precision engineered for trouble-free performance . . . full-length Fiberglas screens. Send coupon for complete specifications and application details.*



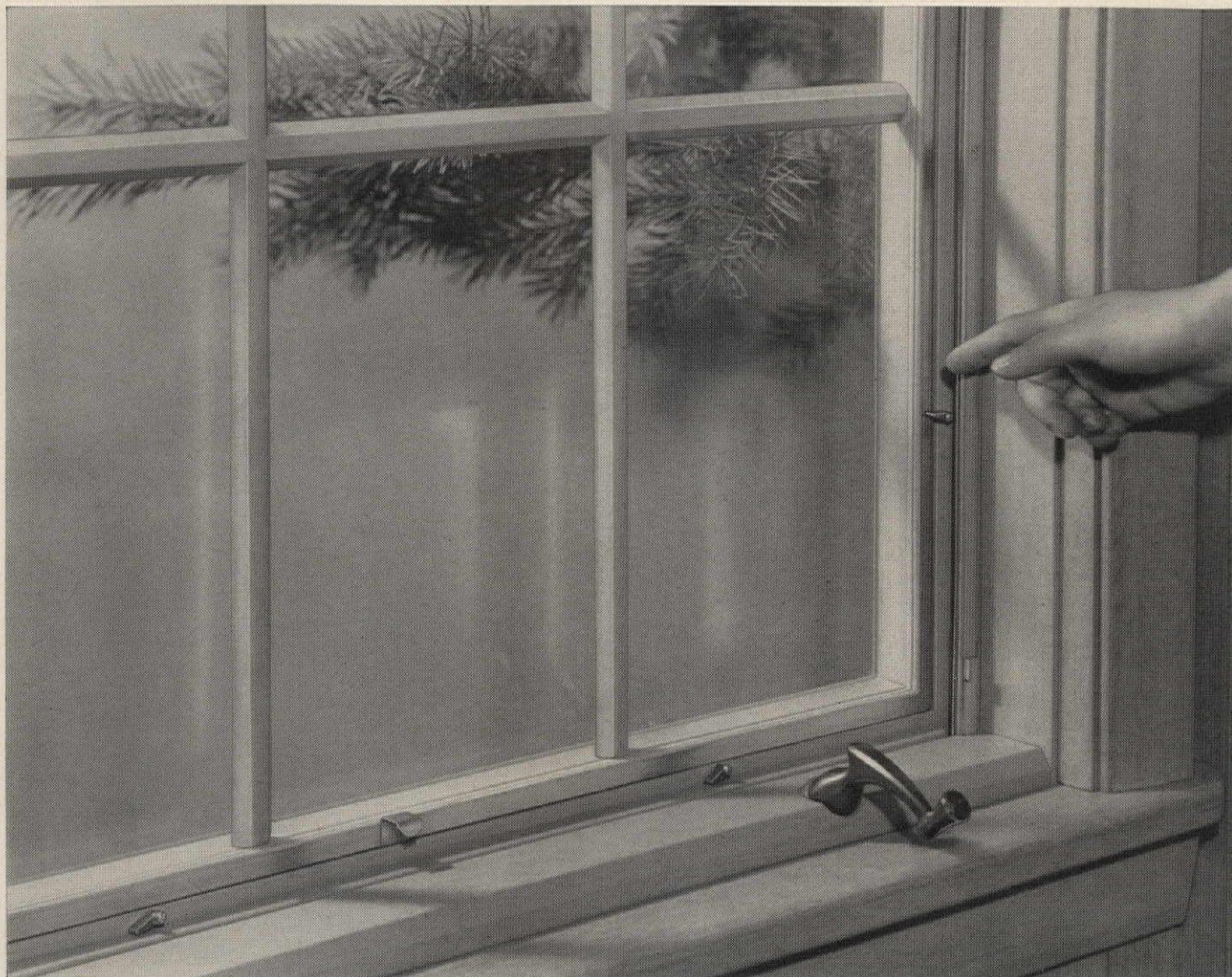

## THERE . . . SHE'S FOUND IT

"See, Tom, you just turn these catches to remove the inside storm panel on these PELLA CASEMENT WINDOWS." Like most of today's home buyers, this lady has seen, heard or read about PELLA WINDOWS' self-storing storm panels. Now she's checking this convenience feature for herself.

She also knows about the exclusive PELLA ROLSCREENS that roll up and down like window shades; . . . the double-action sash

hinge that makes it possible to clean outside glass from inside the home; . . . and the muntin bars that snap out, leaving one large glass area for faster, easier cleaning.

PELLA WOOD CASEMENT WINDOWS can help make the houses you *build* . . . the homes that buyers *want*. Try them on your next job. See the PELLA distributor listed in your classified telephone directory or mail coupon.



### DUAL GLAZING PANELS

store inconspicuously  
inside the sash;  
remove easily  
for cleaning.

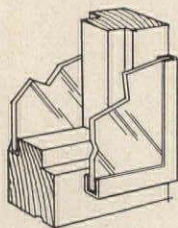

.....  
**ROLSCREEN COMPANY**, Dept. KB-16, Pella, Iowa  
 Please send me literature on PELLA WOOD  
 CASEMENT WINDOWS.

NAME \_\_\_\_\_

FIRM NAME \_\_\_\_\_

ADDRESS \_\_\_\_\_

CITY & ZONE \_\_\_\_\_

STATE \_\_\_\_\_

.....

# Gold Aluminum

A NEW FINISH FOR LOCK TRIM . . .

28G

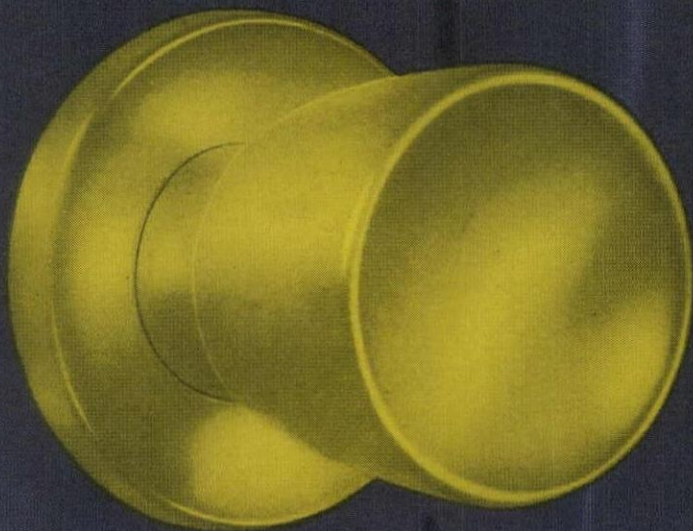

FULLY TESTED FOR MORE THAN 15 YEARS

- Permanent Finish
- Fade-proof
- Highly resistant to abrasion
- Non-tarnishing
- Non-corrosive

SCHLAGE's gold anodized aluminum is an entirely new finish for lock trim. The beauty of the gold finish adds richness to your entrances and interior doors; it will last on and on, unaffected by corrosion or salt air.

Tested and proved for over 15 years, this gold aluminum needs no lacquer; it is a permanent finish that penetrates deep into the metal and will not wear off. Order Gold Aluminum 28G to add richness to your contemporary homes. See your jobber or Schlage representative or write P.O. Box 3324, San Francisco 19. Schlage Lock Company...San Francisco...New York...Vancouver, B.C.

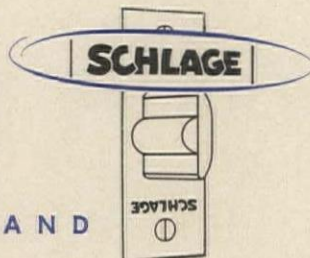

AMERICA'S MOST DISTINGUISHED LOCK BRAND

## FIVE OLD &amp; NEW HOUSING AGENCY FACES



## PEOPLE:

## Shakeup in housing agencies makes Walter Rosenberry deputy HHFA boss

As usual when agency bosses change, the promotions of **Norman P. Mason** from FHA commissioner to HHFAdministrator and of **Julian H. Zimmerman** from HHFA general counsel to FHA commissioner started a major shake-up in executive ranks of the two agencies.

With him to HHFA, as deputy administrator, Mason took **Walter Rosenberry**, his special assistant at FHA. Deputy HHFAdministrator **Walker Mason**, former Providence, R.I. utilities executive with no housing background but good political standing, was shunted into a newly created spot as vice president of Fanny May.

And former Rep **Henry O. Talle** (R, Iowa), ranking minority member of the housing subcommittee of the House who was defeated for re-election last fall, was named assistant HHFAdministrator for program policy. Miss **Annabelle Heath**, who came to HHFA with her longtime boss, Al Cole, was kicked downstairs to regional HHFAdministrator at San Francisco, replacing **Justin Herman**, a holdover from the Democratic administration.

Rosenberry, a jovial, story-loving teetotaler of 51, has been handling Congressional liaison for Norman Mason since joining FHA in 1957. An adroit behind-the-scenes negotiator, he is still a virtual unknown to most segments of the housing industry, although his career as a lumber executive spans a quarter century.

Minnesota-born, Idaho-raised, Rosenberry majored in sociology at Dartmouth ('30), married Sarah Maud Weyerhaeuser. He later joined the lumber empire's staff, became, at 25, general manager of 30 Minnesota lumber yards operated by Rock Island Lumber Co. In 1937, he was named an executive committee member of Allied Building Credits and the Grand Ave State Bank of St Paul, both dominated by Weyerhaeuser interests.

Divorced in 1949, Rosenberry organized his own lumber company operating out of Billings, Mont. and Spokane.

Walker Mason, 61, has been the No. 2 man in the top federal housing agency since April 1957. Under former HHFAdministrator Albert M. Cole, he pushed hard to decentralize HHFAdministration to give more responsibility to its six regional offices, cut the volume of paper flowing to Washington for decisions on items like workable program certifications, urban renewal project applications, college housing and public facilities loans.

Mason was Boston regional director for the War Production Board; from 1946 to 1950 was executive vice president of Narragansett Electric Co, formerly was chairman of the Providence Community Fund.

To make room for him at Fanny May, the job of that agency's vice president & general counsel, **Robert Newton Reid**, was split in half. Reid, who came to Fanny May in 1950

from the Reconstruction Finance Corp, remains as general counsel.

"Doc" Talle, 67, a mild mannered former professor of economics at Luther College, Iowa, served 20 years in the House. He had

## CLOSEUP:

## Julian Zimmerman, FHA's new chief

**Julian H. (for Harris) Zimmerman**, 41, who succeeded **Norman Mason** as FHA commissioner in January, is a tall (6'½"), bulky (190 lbs), black-haired Kansan who was a weekly newspaper publisher and a lieutenant colonel in Army G-2 before he turned to law.

For the last year and a half, as HHFA's general counsel, he has been the Administration's most effective housing man on Capitol Hill. His adroit, yet forthright manner won respect from all factions and it was this performance in a tricky job that made him a logical contender for the FHA post.

Born in Wichita, Zimmerman spent a year at Southwestern College, a Methodist school at Winfield, Kan., and a year at Emporia State Teachers College. In 1938 he took a job with the Bureau of Engineering and Printing in Washing-



ZIMMERMAN

been GOP leader in housing since 1957, acquiring a reputation as a strong foe of housing's drift toward social welfare orientation.

For HHFA general counsel to replace **Julian Zimmerman**, **Norman Mason** snatched **Lyman Brownfield**, 45, a Columbus, Ohio attorney, away from FHA. He had been appointed FHA general counsel only a month earlier, succeeding **George P. Bickford** of Cleveland, who returned to private practice. Brownfield was the fifth FHA general counsel in the Eisenhower administration.

Amid the shuffle, **Dr Martin R. Ream**, 51, a public finance expert and former professor, quit as FHA's assistant commissioner for programs.

Miss Heath accompanied former HHFAdministrator **Cole** to Washington as secretary when he went to Congress in 1945. When he moved to HHFA in 1953, she went along as executive assistant, was promoted to assistant administrator in 1955.

Her assignment to the San Francisco job stirred speculation that the two remaining Democratic holdovers in regional HHFA offices, **John P. McCollum** in Chicago and **Waldemar H. Sindt** in Ft Worth, would soon be replaced by Republican appointees.

The ousted **Justin Herman**, 49, a onetime newsman, is a registered Democrat who has been in government for 25 years. He was West Coast regional director of the old Natl Housing Agency before **Ray Foley**, first HHFAdministrator, named him to the regional HHFA job. Herman turned down an offer to head the Sacramento Redevelopment Authority, planned to go into private development and renewal work.

**George A. Tobin** is new president of Tilo Roofing Co Inc, succeeding his brother, **Robert J.** who continues as chairman; **H. A. Sawyer** stepped up from president to chairman of Lone Star Cement Corp, succeeding **R. A. Hummel**, who retired but continues as director.

ton. As a clerical mechanic, "my job was to do anything I was asked to do," he says. He spent his free time as an active National Guardsman. The unit was called to service in February 1941 with Zimmerman as a second lieutenant. He left the Army in July 1946 after service in both Europe and Africa.

Returning to Kansas, Zimmerman and his wife bought a weekly at Clearwater. "If I had known anything about newspapers, I would have known we couldn't make a success out of it," he says. Two years after taking the Clearwater News' equipment out of the warehouse, Zimmerman found himself chiefly "a good printer—I could set two galleys of type an hour on the old linotype."

Zimmerman is still proud that as Clearwater's editor he played a big role in getting a sewer system and blacktopped streets in the little town not far from Wichita—and without federal handouts such as HHFA now distributes. In February 1949, Zimmerman sold the News, took over a bankrupt, antiquated publishing company in Wichita with a partner. They published a neighborhood

continued on p 107

"I wouldn't build a home without TWINDOW

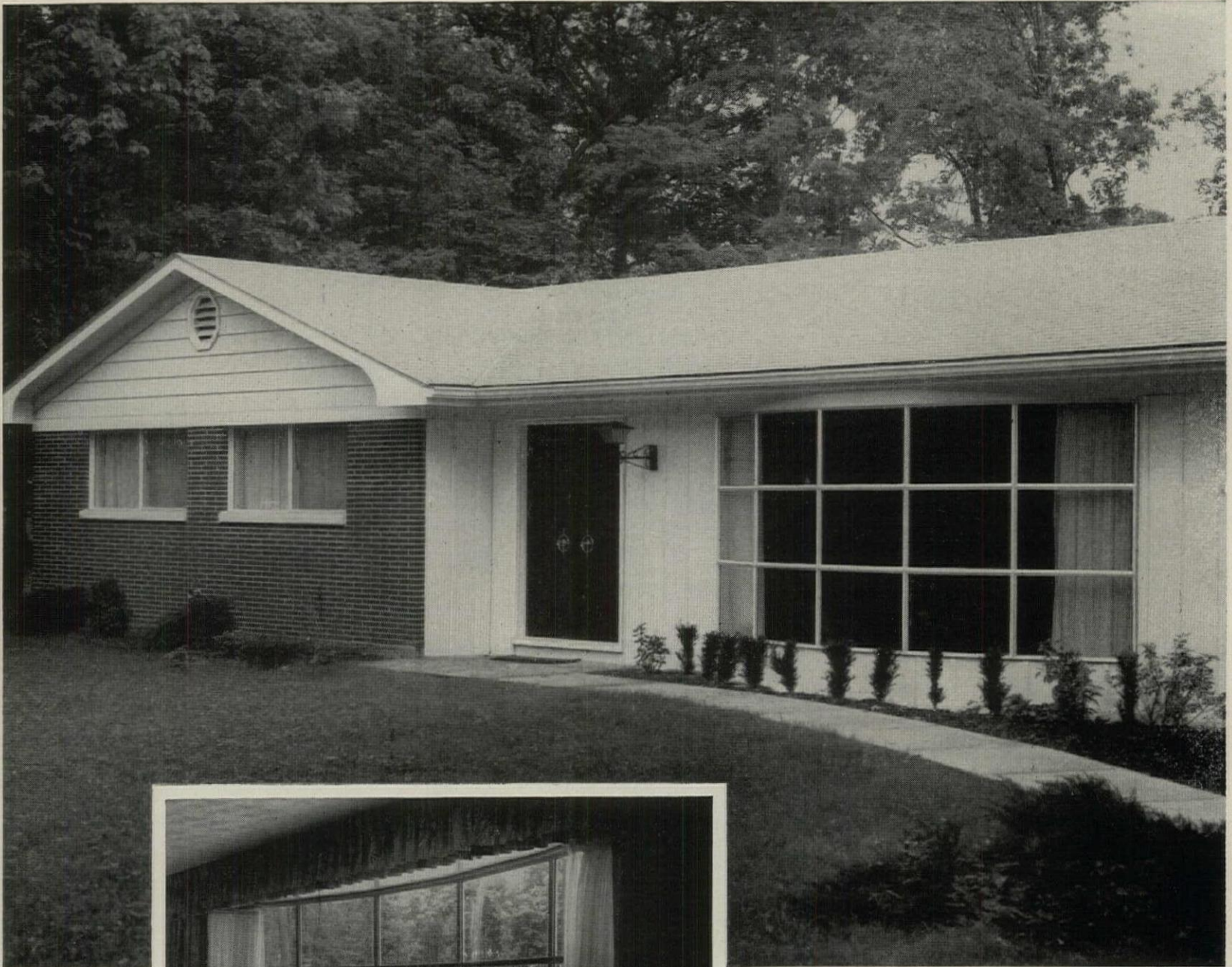

TWINDOW is adaptable to traditional as well as modern styles. This bay window was constructed of 15 lights of TWINDOW—Glass Edge units set in Maco-craft aluminum sash.



throughout,"

says Howard R. Byers,  
Byers and Stein, Fort Wayne, Indiana



William Stein



**BYERS AND STEIN** build about 10 custom homes a year in the Fort Wayne area at prices ranging from \$30,000. Because they put strong emphasis on quality, the inclusion of TWINDOW is only natural. They say that the quality-influence of TWINDOW carries over to other features of the house and adds to its salability.

Mr. Byers has very definite opinions of the value of TWINDOW. He says: "I wouldn't build a home without TWINDOW throughout. TWINDOW is just as important as the use of wall and roof insulation, if a builder really wants to build a quality home." Mr. Byers concludes: "I am one builder who is completely sold on TWINDOW."

Mr. Byers' customers recognize TWINDOW as a mark of a quality home, and yours will, too. From the practical standpoint, you can demonstrate that savings in fuel and air-conditioning costs more than pay for the additional cost of TWINDOW.

We invite you to write for our free booklet on TWINDOW. It is filled with valuable information on sales points, handling and installation. Write to Pittsburgh Plate Glass Company, Room 9140, 632 Fort Duquesne Blvd., Pittsburgh 22, Pennsylvania.

#### TWO TYPES OF TWINDOW



TWINDOW-  
METAL EDGE

**TWINDOW-METAL EDGE.** This type is ideal for large windows and where maximum insulation is needed. It's made up of two panes of  $\frac{1}{4}$ " clear-vision Plate Glass, with a  $\frac{1}{2}$ " sealed air space between. Its stainless steel frame, a TWINDOW feature, eliminates bare edges . . . makes handling safe, quick and easy.



TWINDOW-  
GLASS EDGE

**TWINDOW-GLASS EDGE.** This type is just the thing for modern window-wall construction. Having exceptional insulating properties, it is constructed of two panes of  $\frac{1}{8}$ " PENNVERNON® — the quality window glass — with a  $\frac{3}{16}$ " air space between. TWINDOW — glass edge units are available in popular sizes for a variety of styles.

# TWINDOW®

... the windowpane with insulation built in.



PAINTS • GLASS • CHEMICALS • BRUSHES • PLASTICS • FIBER GLASS

**PITTSBURGH PLATE GLASS COMPANY**

IN CANADA: CANADIAN PITTSBURGH INDUSTRIES LIMITED

## "Telephone planning is a 'must' in every home we build"

—SAYS HOWARD B. QUINN, QUINN HOME BUILDERS, INC., CHICAGO, ILLINOIS



Thirty minutes to the southwest of the center of Chicago lies Beverly Terrace, a gracious community of 200 homes in which "extra" conveniences are the rule, not the exception.

A striking example: each home contains no less than 10 telephone outlets.

"We've earned a reputation for quality construction, de luxe equipment and built-in features," says builder Howard Quinn. "And an abundance of telephone outlets, with wiring neatly concealed in the walls, is just the kind of feature that helps set our homes apart.

"People are delighted when we point out how flexible their telephone service can be—with extensions indoors and out. The wiring's all there whenever they want to use it.

"We're in business to sell homes—and telephone planning helps us do it. It's as simple as that. So it's a 'must' in every home we build."

\* \* \*

*Your local Telephone Business Office will gladly help you with telephone planning for your homes. For details on home telephone installations, see Sweet's Light Construction File, 8i/Be. For commercial installations, Sweet's Architectural File, 32a/Be.*

**BELL TELEPHONE SYSTEM**



*Beverly Terrace homes like the one below even include outdoor telephone facilities. At lower right, Howard Quinn and Illinois Bell Telephone Company's Bill Dutcher inspect a jack-type outlet on the patio.*



weekly, a daily court paper and something called "Charley Jones' Laugh Book." After a year or so, the partners sold out to a man who wanted the printing plant to publish religious tracts (along with the "Laugh Book").

Then, in his early thirties, Zimmerman did something he had long wanted to do: he went back to school. At the University of Kansas, he sampled accounting, logic, history and science. The next year he entered law, received his degree and passed the bar examination in January 1954.

Zimmerman worked several hours a day at the University of Kansas printing shop when he first went back to school. As a third-year law student, he went to work for a firm in Lawrence—first without pay, later on a small salary. After he had his degree, he spent about a year as executive secretary to Kansas Gov Edward F. Arn, then entered the Wichita law firm of Kahrs & Nelson.

"I was a good lawyer from the day I started," says Zimmerman. "I loved it, and I won cases I had no business winning." Early in 1957, he came to Washington as assistant general counsel of HHFA, moved up to general counsel that August.

Zimmerman likes to hike into the mountains to camp and trout fish, enjoys an occasional game of tennis.

If he has any ideas for changing FHA, Zimmerman is keeping them discreetly to himself. Says he: "HHFA and FHA have a common interest in housing. Norman Mason is head of the team. I am going to be a member of that team."

### Korb elevated to presidency of Harnischfeger Homes

Harnischfeger Homes, which produced less than 1,000 prefab units last year, has picked the No. 3 man of its parent Harnischfeger Corp to become president and treasurer.

He is **Thomas W. Korb**, 46, a lawyer who has been with Harnischfeger Corp since 1943, most recently as secretary-treasurer and general counsel, member of the board of directors and the executive committee.



KORB

At the same time, Korb has been named chief executive officer of Harnischfeger Homes Acceptance Corp, which the company is merging with Harnischfeger Homes largely for technical reasons.

Harnischfeger has been making prefabs for 24 years, but has never bulked large in the business. Its marketing area is the 500 mi radius around its Port Washington, Wis. plant. This concentrated its sales in Wisconsin, Illinois, Indiana and Ohio.

Korb says he plans to cultivate more sales in this area before making any plans for expansion. But he adds: "There is a possibility Harnischfeger Homes will go to the public for equity capital sometime in the future."

Harnischfeger's best seller last year was a \$15,000, 1½-bath traditional style house of 900 to 1000 sq ft Korb says his company will stick with the same models this year.

He dismisses aluminum homes recently brought out by some of his competitors as "a gimmick—an advertising feature, an attention-

getter." He explains: "Our first venture in prefab was in steel. We have had a very close association with metals people. We spent a lot of money on the dew point problem. Because some other firms are featuring an attention-getter doesn't mean they're ahead technologically." But he concedes: "Aluminum will have considerable application in homes of the future."

### Ex-HLBB member replaces Braman at Natl S&L League

Ouster of **Harold Braman**, 57, as managing director of the Natl League of Insured Savings Assns marks the start of a major effort by the league to take a more forceful role in shaping the nation's housing and mortgage lending policies.

Braman's successor, **Kenneth G. Heisler**,

H&H staff



S&L LEADERS HEISLER, BENT, CURRY

A new team for the little league

53, is a former (1951-53) member of the Federal Home Loan Bank Board. He has been the league's general counsel since 1953—the same year Braman was named manager when **Oscar Kreutz** resigned to become executive vice president of the First Federal S&L in St Petersburg, Fla.

League membership, which reached 800 several years ago, shrank to about 500 last year. One reason: the rival US Savings & Loan League (4,500 members) stepped up recruiting efforts after talks aimed at merging the two leagues failed in 1954.

Under the presidency of energetic **James E. Bent**, president of Hartford (Conn.) Federal S&L, the National League is acquiring more steam. Symptomatic of its new look is the fact that **Charles Wellman**, the articulate executive vice president of Glendale (Calif.) Federal S&L who is chairman of its legislative committee, was the only lender who testified at the Senate banking committee's housing hearings (see p 43). "We feel private lenders have an enormous obligation to take a stand on general housing legislation," says Wellman, "instead of confining their efforts to the special provisions applicable only to them."

Oregon-born, Heisler joined the Home Loan Bank Board in 1934 after winning a Harvard law degree. He became associate general counsel eight years later and general counsel in 1946. To fill his job as general counsel, the league promoted Associate Counsel **Bryce Curry**, 35.

Braman, a former Associated Press foreign correspondent, joined the National League in 1945 as assistant manager after serving as a department head at the HLBB. The League said he "requested retirement."

PROMOTED: **Steve Slipher**, smooth-operating Washington lobbyist for the US Savings

& Loan League, from staff vice-president to legislative director; his assistant, **Glen Troop**, from assistant vice-president to staff vice-president.

Ferro Corp of Cleveland, world's leading maker of porcelain enamel frit (the compound that, fused on metal, makes the enamel), and owner of the dies once used in manufacturing the enameled-steel prefabs of ill-fated Lustron Corp, is laying plans to produce a new line of porcelain enamel prefabs and house components.

First step: the firm has hired Architect **Carl Koch** of MIT, who designed the Lustron house and two other prefabs. Koch & Associates will design three new porcelain enamel houses for Ferro in the next six months.

**Glenn A. Hutt**, Ferro vice president and director of commercial development, indicated Ferro is not plunging blindly. He called the move "the first phase of a many-stage progress." The firm has pioneered enameled metal houses, built its first for the 1933 Century of Progress exposition, in Chicago.

### San Francisco administrator quits after slum ties bared

Ex-Realtor **Chester R. MacPhee**, 53, sometimes called the "father" of San Francisco's renewal efforts, has quit his \$24,000-a-year lifetime post as the city's chief administrative officer after only six months on the job.

Reason: twice during his tenure local probers have found, among MacPhee's nearly \$½ million in personal real estate and loan investments, connections with firms dealing in slum properties scheduled for clearance.

First jolt for soft-spoken, grey-haired MacPhee came in October, when front-page headlines blared that he, two superior judges, and a grand juror were directors or share-holders in Del-Camp Investments Inc, which owned 45 properties in the city's Western Addition redevelopment area. The firm itself had already made headlines by demanding the city redevelopment agency pay \$175,000 for two properties appraised by city officials at \$122,500.

All of the officials immediately shed all connection with Del-Camp, dumping their stock at no profit. MacPhee sadly denied to reporters that he knew his \$5,000 investment was in slum tenements. "I'm just sick about it," he said then. Because no sale had been made to the city, MacPhee was cleared of possible conflict of interest which could have cost his job.

The second jolt, in January, involved actual sale of a two-story flat to the city redevelopment agency for \$12,500. MacPhee was found to be a 6% stockholder in the S&L which held a \$7,000 first mortgage, and one of three partners in the firm which held the trust deed covering the loan. City Atty Dion Holm announced he would make a "thorough study" of the case. Although MacPhee's benefit from the deal looked minuscule—fee for the trustee in such a transaction might, said officials, run to \$4—the headlines were not.

Within a week, MacPhee strode into the office of his good friend and boss, Mayor **George Christopher**, handed in a resignation letter calling the furor "unjustified harassment." As for earlier hints that he could keep his job and calm the storm by dumping his investments, he said, "I consider it to be unfair

continued on p 110



designed for each other!

# ONLY EDWARDS

has everything you need for a low cost, zone control hydronic heating system

Everything you need for efficient, low cost zone control heating—heating unit, zone control valves, and baseboard elements—are now available from **one** dependable source: Edwards Engineering!

Only Edwards offers a completely integrated, zoned heating system, with components that have been designed to go together for the life of the system. You shop just once for everything, with one manufacturer guaranteeing everything. Your initial cost is lower—the Edwards zone control system is the most economical on the market. Your installation costs are lower—two men do the job in one day! That means higher profits for you and the world's finest zone control baseboard heating system for your customers. That's an unbeatable combination for selling homes.

**EDWARDS ZONE-A-MATIC HEATING UNIT** is guaranteed for 20 years, handles from 1 to 6 **pre-wired**

motorized zone control valves. All-copper tankless hot water heating coil; simple to install; complies with ASME code; completely assembled and pre-wired; compact and good-looking.

**MOTORIZED ZONE CONTROL VALVES** feature completely enclosed, hermetically sealed mercury switches; completely silent with positive shut-off valve. No thermal leakage when closed. Uses standard 3-wire low-voltage thermostat; electric power drawn only during opening and closing; excellent for hot water or steam systems.

**BOX-FIN BASEBOARD ELEMENTS** are factory cut to **any desired length**, making installation simple, economical, and eliminating ugly joints and splicers. No metal to metal contact; available in white, chrome, copper-tone and wood-grain.



Write today for the full-color story...

## EDWARDS ENGINEERING CORP.

309 Alexander Avenue, Pompton Plains, New Jersey

Member of BHC: Better Heating-Cooling Council



Courtesy Pittsburgh Plate Glass Company  
Manufacturers of "Twindow" Glass

From every viewpoint..

# BILT-WELL Casement Windows

Add Sales-Appeal to your homes

## On the outside...

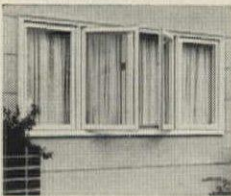

### Modern, Uncluttered Exterior

Hinges, fastened to the frame, head jamb and sill, are completely concealed. No exposed hardware to rust, corrode or mar the clean, simple lines of the window. Lack of exterior hinges makes the BILT-WELL Casement burglar-proof, too!

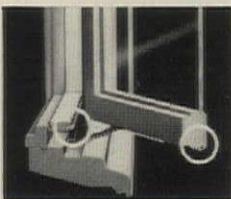

### Fuel-saving Weathertightness

Two complete, independent systems of weatherstripping keeps cold air out, warm air in. Tests show BILT-WELL Casement Windows save as much as \$28.00 a year on average twenty-window home.



### Design Flexibility

Unique utilized sill permits changing of exterior appearance simply by varying window arrangements. Units can be joined in any number of combinations without the need for special sills or extra framing.

## On the inside...

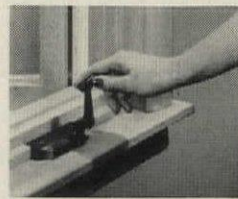

### Finger-tip Operation

Trouble-free worm gear operator on sill provides easy, quiet, maintenance-free opening and closing.



### Maximum View

The precision construction of BILT-WELL Casements assures necessary strength with minimum framing, providing larger glass area.

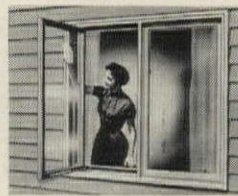

### Easy Cleaning

Sash swings out to a full 90° to permit washing of inside and outside of glass from the inside.



### Simple Maintenance

Lightweight storm and screen panels are designed to lock quickly onto the inside of the sash.

No other window on the market offers the extra consumer-appealing features and cost-saving installation advantages of the BILT-WELL Casement Window. Yet, BILT-WELL Casements are competitively priced. Ask your building supply dealer about them today, or write CARADCO for full specifications.

## BILT-WELL WOODWORK

Manufactured since 1866 by **CARADCO, INC.** Dubuque, Iowa  
(formerly Carr, Adams & Collier Company)

For complete information on BILT-WELL Products see 1959 Sweet's Architectural 17c/Car and 24b/Car, or Sweet's Light Construction 6c/Car and 12a/Car.

*Berko's ceiling  
heater-lighting  
combination can...*

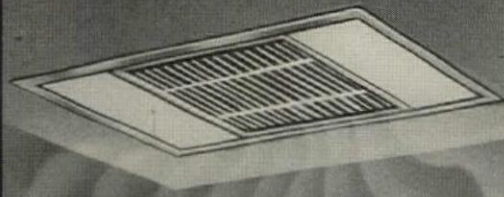

**SELL COLD MORNING COMFORT**  
*for you at a down-to-earth cost!*

Maybe your homes are as nice as all the rest . . . maybe even a little better. But you know how few prospects can appreciate the quality you build into a house. That's why Berko's Pyrolite<sup>®</sup> heater makes so much sales sense. Turn on the wall switch and the bathroom's immediately bathed in light and luxurious radiant heat. It's something he sees, something he feels . . . and likes about the house, especially when he realizes sudden cold snap mornings during the in-between seasons means he doesn't have to start up the whole central heating system.

It makes sense for you, too! Installation is low cost and simple. Saves pipe and duct work of normal heating installation. There are Berko units of every type . . . for the attic, the laundry room, garage, playrooms . . . for the whole house, in fact. Make sure to get the facts from your local electrical contractor or distributor today or mail coupon for more information.

# BERKO

GLASS ELECTRIC RADIANT HEATING

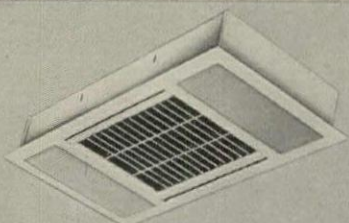

HEATING and LIGHTING COMBINED in new "Pyrolite" ceiling unit. 1000-watt recessed fixture provides luxuriant heat for immediate comfort. Heat and light have individual controls. For bathrooms, kitchens, porches, all areas where supplementary or occasional heating may be needed.

BERKO Electric Manufacturing Corp., Dept. HH359  
212-40 Jamaica Avenue, Queens Village 28, New York

Please send me complete literature and specifications on the full line of Berko Radiant Glass Electric Heating Units.

Name \_\_\_\_\_

Company \_\_\_\_\_

Street Address \_\_\_\_\_

City and State \_\_\_\_\_

and unjust to expect any man to sacrifice investments which represent savings of a lifetime . . ."

Although Mayor Christopher stoutly maintained his confidence that MacPhee had "done nothing wrong," he was obviously relieved at the resignation. After all, nobody could be sure how many more political booby traps lurked in MacPhee's holdings.

The explosion was the latest in a series of crises which have rocked the city's rudderless, glacier-slow ten year redevelopment history. While nobody appeared to believe the MacPhee case involved any real dishonesty, it gave a liberal lesson, for use by other cities, about who could profit from slum clearance. City Hall pundits, observing that MacPhee had in fact attacked his job with competence and vigor, making enemies in the process, hinted that more tact might have saved all the headaches. Meanwhile, Mayor Christopher called in the city's public works director, **Sherman P. Duckel**, 59, a veteran politician, as MacPhee's successor, asked him to submit a list of personal investments for study before final appointment.

## Senate banking committee boss cool on renewal, PHA

The new chairman of the Senate banking committee, the nation's most influential shaper of housing legislation, doesn't think much of the committee's two pet items for reshaping US housing, urban renewal and public housing.

Sen **A. Willis Robertson** (D, Va.) takes a consistently conservative view toward federal involvement in matters he thinks are state and local responsibilities. He was one of the handful (10) of Democrats who voted against his own party's housing bill in the Senate. At that juncture, he had not yet succeeded to the banking chairmanship. Majority Leader **Lyndon Johnson** asked Sen **William Fulbright** (D, Ark.) to stay on until the Senate passed the housing bill. Then Fulbright stepped up to succeed Sen **Theodore Green** (D, R.I.) as chairman of the foreign relations committee. Green, 91, resigned his chairmanship because of failing eyesight and hearing.



ROBERTSON

Robertson calls the whole approach of public housing wrong not only because it is expensive (\$13,500 average unit cost) but because it is ineffective and intrudes the federal government where it doesn't belong. Says he: "If public housing were carried to the ultimate volume of starts that has ever been proposed, it would only take care of 10% of those eligible."

The gentleman from Virginia is far happier with FHA, although flatly opposed to easing loan-to-value ratios or amortization one iota more. Longer loans might produce buyers who "never really expect to own their own homes," he warns. If they get to feel that way about their houses, "they won't keep them up."

S&L circles have worried that Robertson might shift jurisdiction over S&L legislation from the housing subcommittee headed by Sen **John J. Sparkman** (D, Ala.) to the banking subcommittee which he heads himself. But Robertson disclaims any such plan.

## Non-member Elbel flings NAHB show's No. 1 fling

Kansas City builder **Don Elbel** is not a member of NAHB—but this didn't stop him from throwing the convention's No. 1 headline-catching party.

He rented the plush Terrace Casino of the Morrison Hotel, invited 1,200 builders and producers. He plied them with free drinks and sandwiches, then brought on his \$75,000 main attraction—32 barely clothed girls, flown in for one night from the Dunes Hotel in Las Vegas along with 50 other members of the Minsky Follies cast.

The show brought down the house. Cried one St. Louis builder as he stopped pounding his table momentarily: "This is the sort of thing this industry needs. We're too stodgy."

An appliance producer, though enjoying the show, demurred: "The only people who are going to survive in this industry are the ones who are making an honest effort to stay in business. This sort of thing doesn't contribute to that."

Elbel, 40, has so far shown an ability to survive while making a splash with his cash. He made no direct sales pitch at the Chicago party. He spotted 55 men around the room to answer questions about his businesses (homebuilding in Kansas City, Wichita and Coffeyville, Kan, and Phoenix; the First Mortgage & Realty of Phoenix and Wadsworth Homes, a prefab firm, in Kansas City).

Two years ago, Elbel made his splash by inviting builders to view in person the impressive décolletage of actress **Anita Ekberg**.

**DIED:** **Herbert S.** (for nothing) **Greenwald**, 43, restless seeker after "the perfect physical machine for living," champion of **Mies van der Rohe's** chaste, glass-clothed "perfect cube" designs in apartment buildings, and one of the nation's three biggest urban redevelopers\*, Feb 3, in the New York crash of an American Airlines Lockheed Electra that took 65 lives.

Greenwald, a dapper pipe-smoking man who called himself a "believer in the city" and seldom built anything but apartments, conceded that his belief had made him a multimillionaire. But he credited chance with getting him into the business. A graduate in philosophy of the University of Chicago, he was persuaded to invest \$25,000 in an apartment building scheme in '39, had to take it over to save his money. From this, he went on to build more than a score of apartment buildings, including Mies' world famed glass tower on Chicago's Lake Shore Drive. He had construction completed or under way totaling more than \$270 million, was currently at work on redevelopment plans for Manhattan's Battery Park and Newark's \$17.5 million North Ward renewal project.



GREENWALD

**DIED:** **J. Frank Barrett**, 70, onetime carpenter who with **Harry H. Hilp** founded Barrett & Hilp, San Francisco contractors, in 1912, built it to a \$20 million-a-year construction

\* The other two: James Scheuer and William Zeckendorf.

giant; Jan 11, of cancer, in St Mary's hospital, San Francisco.

Since '53, when the partnership became two companies, Barrett headed Barrett Construction Co, which is currently building a \$6 million State Building in San Francisco, \$6.3 million of hospital additions, including one at St Mary's. Though residential construction was only a minor part of his recent operations Barrett was a big-scale builder (290 houses in '57 and '58). He built 16,000 homes during his 46 years in the business.

## CANADA:

### NHA mortgage guarantee will be boosted to 100%

A boost in the guarantee of NHA mortgages from 98 to 100% is being asked by the government. Approval is considered certain.

This would be the first step in a program to make NHA mortgages more attractive to private lenders. It also foreshadows a move to create a central mortgage bank to buy and sell NHA mortgages—possibly to United States investors.

A 100% guarantee, which would match the US' FHA insurance and VA guaranty, would of course remove any element of risk for a lender. It is one more step in a chain which seems to be leading Canada into the same stance as the US—wherein the government, not private lenders assumes all the risk of low-equity home financing.

Works Minister Howard Green, the government's official housing spokesman, told Parliament the move should make NHA mortgages attractive to "trustees of pension funds, executors and trust companies."

Agrees a Toronto investment dealer: "I can put my hands on about \$300 million provided I get the 100% guarantee."

### The most important industry

The Conservative government now regards the 163,000 starts of 1958 as one of its major accomplishments and best sales points.

Green left no doubt of this during the debate on the speech from the throne. Announcing that the government had set aside \$250 million more for direct loans (raising the total to \$1 billion), Green explained: "This was done primarily for three reasons: 1) to maintain the housebuilding industry, which I believe is the most important industry in Canada; 2) to provide employment; 3) to give young Canadians a chance to own their own homes."

Green has also announced that Central Mortgage & Credit Corp, Canada's housing agency, has been encouraged to step up its own central mortgage bank functions by administrative changes.

Besides the 100% guarantee, lenders will now be reimbursed up to \$150 instead of \$125 for legal fees incurred in a foreclosure. (There are only 61 approved lenders.)

### Easier to buy & sell

To make it easier for CHMC to buy and sell mortgages, two other changes will be made: 1) the corporation will sell mortgages to any investors who want them and retain or farm out servicing. Now, it can sell only to the 61 approved lenders who can make loans for their own portfolios; 2) the present

**OTHER DEATHS:** **E. E. Gilmore**, 68, chairman of Gilmore Construction Co, Omaha, and past president of Omaha Builders' Exchange, Jan 22 in an Omaha hospital following a long heart illness; **John Maynard**, 44, president of Fulton Morrissey Co, advertising agency for a score of major building products firms, Feb 1 apparently from an overdose of sleeping pills in his Chicago home; **Herbert C. Smith**, 53, assistant manager of the Nat'l League of Insured Savings Assns, Feb 11 in an automobile accident at Slidell, La.

\$25 million ceiling on the amount of mortgages CMHC can buy from all of the approved lenders will be lifted. There will be no limit provided it stays within the direct government loan fund of \$1 billion.

Maximum NHA loan is only \$12,800 (which encourages more and more second mortgage financing).

### Housing standards eased; builders amazed but happy

A long list of important changes to Canada's housing standards, worked out in January, are now in effect.

The changes are aimed at ending differences between the standards and the National Building Code—of which the housing standards are theoretically part. They relax many rules—so much so that one builder member of NHBA's research committee admitted happily: "Some of them frankly amazed us."

Some of the more significant changes:

- Studs in outside walls may be spaced 24" on centers, instead of 16".
- Thinner plywood sheathing is allowed for subfloors and panel edge support requirements are relaxed.
- Utilities rooms in basementless houses may be smaller (up to 35 sq ft may be cut from the previous 120 sq ft minimum) when crawl space for attic furnaces and automatic dryers are included.
- New wood framing design tables let builders make better use of new techniques (eg post & beam, plank roof).
- Board subflooring can be laid at right angles to joists. It is stiffer and less wasteful that way, say builders.
- Cross bracing or diagonal bridging between floor joists can be replaced by other simpler methods, eliminated altogether when lath or drywall is applied to the underside.
- Basements may have thinner concrete block walls, smaller footings.
- Room sizes and clearances may be figured between rough framing rather than finished surfaces.
- Metal joist hangers are no longer mandatory.

The housing standards are a temporary set of rules which replaced the old CMHC building standards last spring (*April '58, News*). They will govern all NHA building until a special housing section for the National Building Code is issued next year.

The changes were developed at a meeting between the research committee, the Central Mortgage & Housing Corp (Canada's housing agency) and the Division of Building Research Officials. DBR pushed the changes out quickly, still stung by criticism for sitting on other changes for nine months last year.

Weyerhaeuser 4-Square  
**IDAHO WHITE PINE**  
**AGAIN IS PLENTIFUL**

*in Sterling and Standard Grades*

● Builders are receiving this news with great enthusiasm . . . Weyerhaeuser 4-Square Idaho White Pine is again readily available in Sterling and Standard grades. These grades are ideal for paneling, cabinets, interior and exterior trim, built-ins, boards and battens, and for scores of other uses.

Because Idaho White Pine serves many uses so well, is easy to work, and possesses enduring beauty, builders and owners prefer this fine species.

That is why builders are glad to know that a plentiful supply of Weyerhaeuser 4-Square Idaho White Pine is **READILY AVAILABLE** in the yards of their retail lumber dealers.

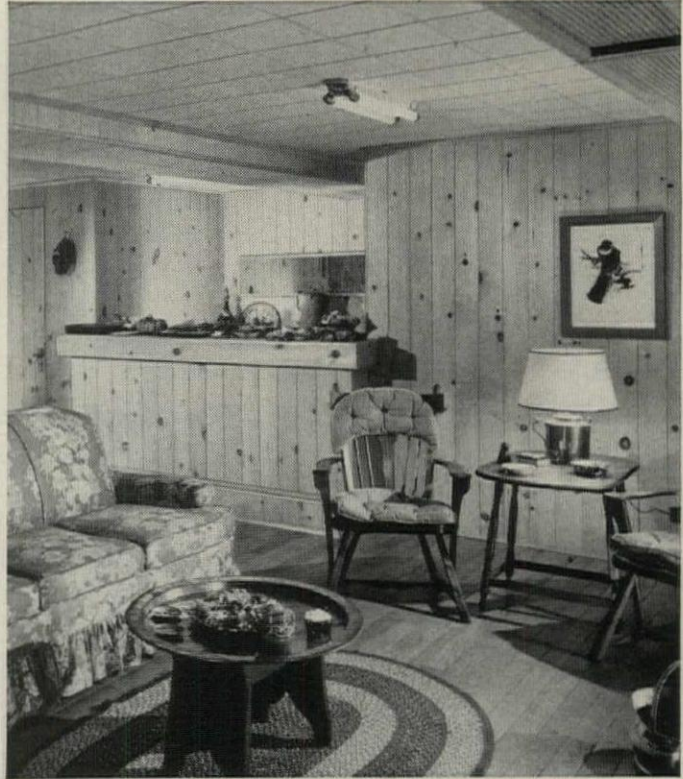

**Weyerhaeuser** **4-SQUARE**<sup>®</sup>

**LUMBER AND BUILDING PRODUCTS**



**IDAHO WHITE PINE**

*First Choice* **FOR MANY USES**

Carpenters enjoy working with Idaho White Pine. It saws easily and sands quickly to a smooth finish, nails well, and takes stains and paints beautifully.

Builders use Weyerhaeuser 4-Square Idaho White Pine with full confidence because it serves well for a broad range of uses . . . outside and inside. It is the fine species that has always delivered extra building and decorative values for which white pine has been famous for generations. Many builders rely on it as their preferred multi-purpose lumber.

Your Weyerhaeuser 4-Square Lumber Dealer will be glad to inform you as to the many desirable Idaho White Pine items which are readily available in Sterling and Standard grades.



**Weyerhaeuser Sales Company**

FIRST NATIONAL BANK BUILDING • ST. PAUL 1, MINNESOTA



Builders construct  
higher quality houses  
that sell faster with

# Siding of Care-free Alcoa Aluminum

**Aluminum's Built-in Sales Appeal.** Of the building products widely used throughout the country, perhaps none has gained popularity as rapidly as aluminum. Easy to work with, competitive in cost, attractive and requiring practically no maintenance, siding made of Alcoa® Aluminum is a potent selling force that converts lookers into buyers. It gives the homeowner a better house for his money, enables him to save as much as \$200 a year, every year, on the cost of painting and repairs alone.

The trend toward more and more use of quality building products made of Alcoa Aluminum is unmistakable—home buyers *want* and *look* for the Care-free living that comes with aluminum.

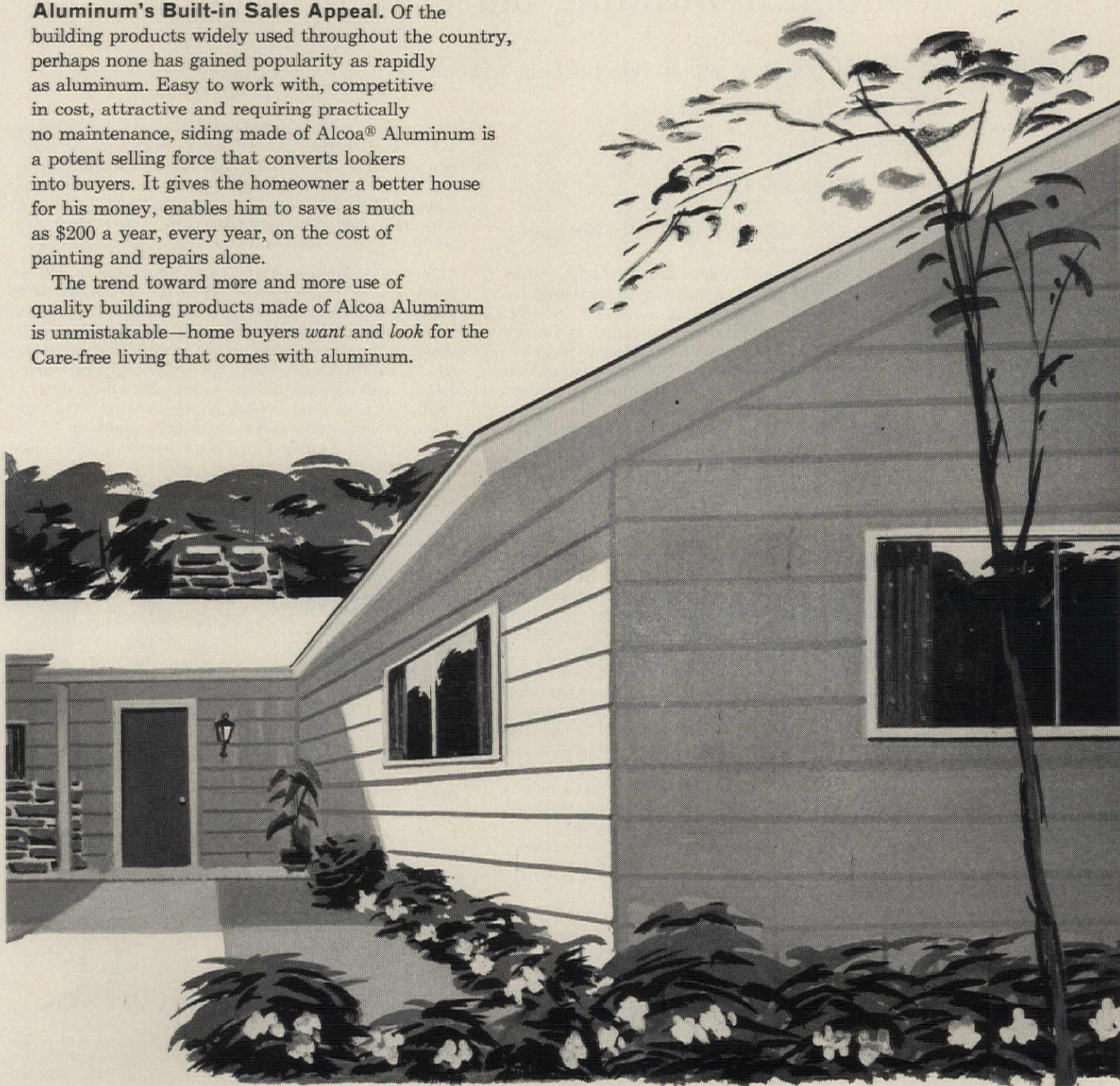

Aluminum Company of America, Pittsburgh 19, Pa.

# Aluminum siding... over the years, the most Care-free, economical building material of them all

Produced by quality siding manufacturers in a variety of attractive, long-lasting colors... designs and sizes... unique construction features

*For New Construction and Remodeling—Contemporary and Traditional Homes*

**Cuts Installation Time, Reduces Labor.** Light, precision-formed aluminum siding and accessory parts go up faster with less work. Interlocking sections fit snugly. Countersinking and puttying are eliminated. An entire house can be sheathed in aluminum siding in less time than with other materials. It's the building product you can work with 12 months of the year, fair or foul weather. Work stays on schedule, interior construction starts sooner, houses are finished, *ready for sale*, earlier.

It can be applied to practically any type of wall by your present help—no special tools are needed.

Unmatched for economy—one square of aluminum siding covers 100 square feet. There are no split or warped pieces. Painting is eliminated.

**Bright, Eye-Appealing Colors That Stay Care-free, Help Sell the Houses You Build.** The oven-baked vinyl or alkyd enamel finishes incorporated into present-day aluminum siding will outlast most mortgages. Extreme weather conditions, even highly corrosive industrial atmospheres, have little effect on its surface.

For two-way protection, manufacturers usually bond the finish to both sides of high-strength Alcoa Aluminum alloy. Attractive colors now available include—white, buff, gray, yellow, pink, blue, light and dark green and red. Unlike ordinary paint finishes that soon fail, these firmly bonded colors will not blister, peel or flake off.

Deep butt shadow lines further enhance and accent aluminum siding's smooth, soft appearance. Its good looks are never marred by unsightly nail heads.

Simply washing with hose and cloth restores its bright, clean beauty. Truly Care-free, attractive aluminum siding helps sell the houses you build.

**Durable, Corrosion-Resistant Aluminum Siding Guards Exteriors to Reduce Depreciation.** Corrosion-resistant aluminum siding can't rot or deteriorate—it defies the elements. Its permanence assures higher resale value and reduces the rate of depreciation. Aluminum protects the homeowner's investment and pride of ownership throughout the life of the house. Aluminum protects against termites, vermin, flames—*permanently*.

When you build with aluminum, you build houses worth more now and in the years to come. Its advantages provide the sales clincher that is paying off for builders throughout the country.

**Aluminum's High Insulating Quality Makes Important Savings in Fuel Costs.** Aluminum's superior insulating characteristics provide added economy and more comfort for the homeowner. Its insulation value is equivalent to several layers of asbestos, 18 inches of concrete or six inches of brick. Heating and air-conditioning costs are lower—through-wall heat losses are minimized. Because it reflects up to 95 per cent of the summer sun, interiors

stay cooler for welcome relief during the hot months.

For even better insulating efficiency, many siding manufacturers incorporate into the panels up to 1/16-in. insulating boards, Fiberglas\* or other quality insulating material. This built-in insulation further contributes to the panels' strength and rigidity. Their sound absorption qualities help deaden and shut out disturbing noises.

**Care-free Aluminum Reduces Maintenance to a Minimum—Saves Homeowners as Much as \$4,000 in 20 Years.** More than half of your prospective buyers are former homeowners—they remember all too well the evenings, week ends and vacation time lost in never-ending maintenance chores, the constantly increasing cost of materials and labor. Aluminum siding supplies double-barreled sales appeal. It does not rob the family of leisure hours and saves up to \$200 annually for its owners. It minimizes repair and painting costs, cuts down on fuel bills and reduces rate of depreciation.

\*Trademark of Owens-Corning Fiberglas Corp.

ALUMINUM COMPANY OF AMERICA, PITTSBURGH, PA.

## TYPICAL ALUMINUM SIDING APPLICATION PROCEDURE

Light,  
uniform sections  
and accessories  
install quickly,  
easily



According to manufacturer's recommendation, exterior walls are first covered with sheathing paper, perforated aluminum foil or aluminized paper. Covering material is stretched tight and fastened with 1/2-in. staples or large-headed roofing nails.

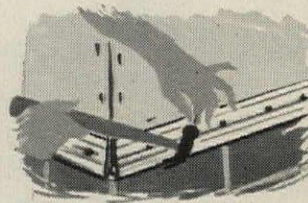

Chalk line is snapped around base of house to determine level line on which starter strip is installed. Starter strips are securely nailed on the base line at specified intervals.

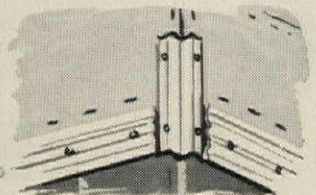

Inside corner strips (and outside corner strips, if used) are applied before siding goes up. Channeling or window and door trim is then applied for weathertight seal.

**VARIETY OF SPECIAL AND OPTIONAL  
FEATURES INCORPORATED IN  
DIFFERENT BRANDS OF  
ALUMINUM SIDING**

Most aluminum siding manufacturers today provide an exposed face of approximately 8 in. with up to 3/4-in. butt depth. Panel lengths vary from 10 ft to 12 1/2 ft and are fabricated from durable, .024-in. and .019-in. aluminum stock. All panels provide an interlocking system of one design or another, as well as vent or weep holes along the underside of the butt.

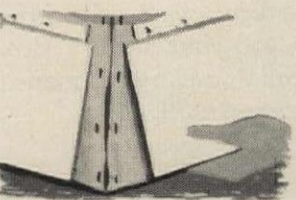
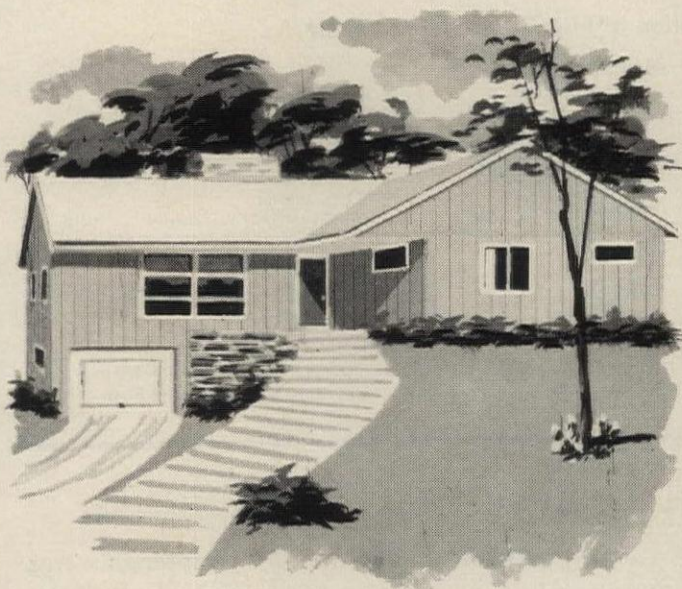

Siding panels are then applied by inserting into starter strips and nailed snug. Panels join firmly or interlock in succeeding courses to cover entire area. Vertical joints are staggered throughout the installation.

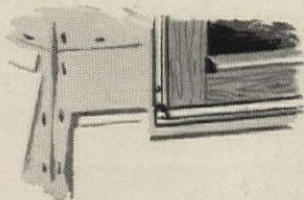

To finish off around windows, doors and eaves, siding is trimmed to fit as work progresses upward.

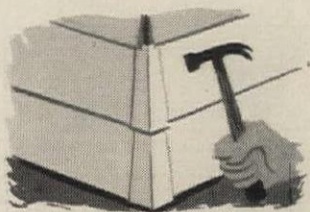

Individual or profile outside corners are applied after all siding has been installed. Pieces are snapped into place and nailed as work progresses. Corner pieces are applied starting from bottom or top, depending on manufacturer's design.

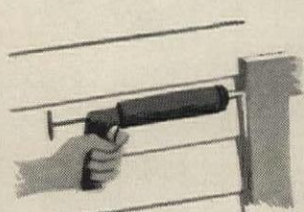

All exposed or cut edges around windows, doors, etc., should be carefully calked. Complete installation by removing dirt or finger marks from siding with damp cloth.

**Exclusive and generally common features  
found in today's aluminum siding**

**Concave panels** that may be applied vertically for modern treatment, or horizontally for traditional effect. Siding remains under constant tension for added strength and rigidity. Installation begins at top of exterior walls.

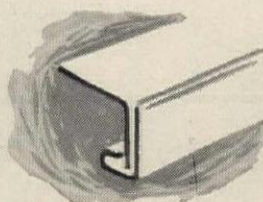
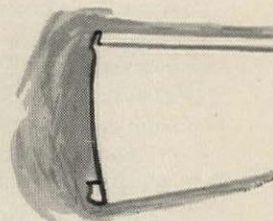

**Two-piece window and door accessory trim** that flashes and seals openings simply, quickly.

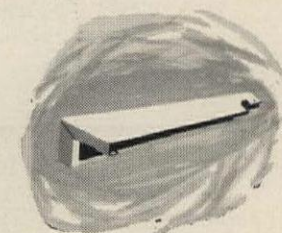

**Choice of profile or continuous strip corners** in matching colors.

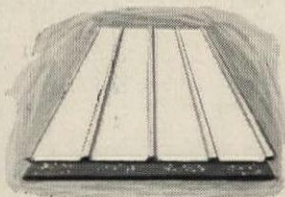

**Panel system** designed to eliminate supports, backers or starter strips.

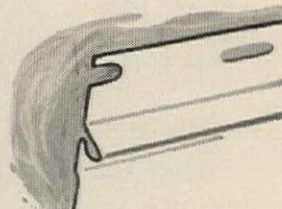

**Concealed nailing slots** that allow for expansion and contraction of siding.

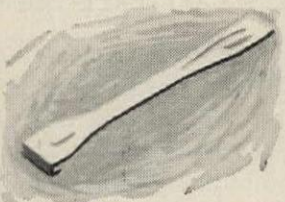

**Heavy-gage back-up supports** for use at wall openings and under each vertical joint for greater rigidity and tighter fit.



**Interlocking, self-leveling panels** for fast, economical application.

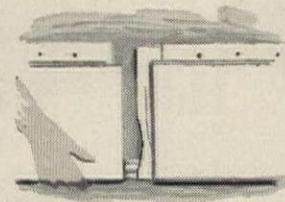

**Prenotched panel ends** for fast, tight fit at overlapping joints.

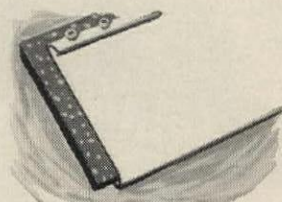

**Panels with factory-installed insulation board** for added strength and insulation value.

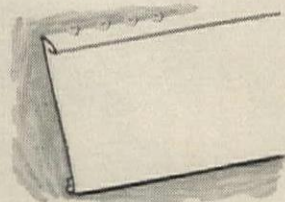

**Exclusive 5 process baked enamel** that stays white.



**Full-floating, insulated panels** that install without nails touching metal.

**PERFORMANCE DATA AND EVALUATION OF ALUMINUM SIDING**  
Thermal Insulation or "U" Value

Typical Wall Construction	Thermal Resistance of Wall Components	
	Case 1 (Without Backer-Board)	Case 2 (With Backer-Board)
Outside surface— $1/f_o$	0.17	0.17
Aluminum siding (No backer-board, $3/8$ -in. air space)	0.26	—
Aluminum siding (With aluminum siding backer-board)	—	1.95
$3/4$ -in. sheathing—insulation board	2.06	1.16
$3 5/8$ -in. air space	0.92	0.92
$1/2$ -in. plaster on $3/8$ -in. gypsum lath	0.42	0.42
Inside surface— $1/f_i$	0.68	0.68
"U" Value—Btu/Sq Ft/Hr/F	0.286	0.229

**Laboratory and Field Test Evaluation of Aluminum Siding Finish**

<b>Flexibility:</b> Descriptive Specific—Test	Exceptional No Film Fracture, 180° Bend on Aluminum	<b>Salt Spray Test:</b> Descriptive Specific—Test	Excellent 20% Concentration, 97°F, 2,000 Hours
<b>Impact Resistance:</b> Descriptive Specific—Test	Exceptional 28-in. Drop Test—No Film Fracture	<b>Fade Resistance:</b>	Excellent
<b>Adhesion:</b> Descriptive Specific—Test	Exceptional Knife Test—Difficult to Remove (Greater Tenacity)	<b>Peeling and Scaling Resistance:</b>	Excellent—Elastic, Highly Flexible and Adhesive Film Precludes Peeling or Scaling
<b>Humidity Test:</b> Descriptive Specific—Test	Excellent 100% Relative Humidity, 110°F, 8,000 Hours	<b>Film Erosion Resistance:</b>	Excellent—Due to Slower Chalking Rate and to Highly Flexible and Adhesive Film
		<b>Over-all Weathering Resistance:</b>	Exceptional—Superior Performance Resulting in 50% Longer Film Life

**THE ALCOA CARE-FREE TAG CAN SPUR HOUSE SALES FOR YOU, TOO!**

When you build with siding made of Alcoa Aluminum, you gain the mighty selling power of the Alcoa Care-free tag. Promoted on two network television programs, radio, national magazines and local newspapers, it identifies quality building products made of Alcoa Aluminum. Preselling more than 40 million people on Care-free aluminum building products—it helps sell the houses *you build*.

Join the trend to aluminum for maintenance-free homes. Alcoa invites you to share in its facilities and the more than 30 years of knowledge and experience in developing products and techniques.

For the names of manufacturers who make siding of *quality* Alcoa Aluminum, call your nearest Alcoa sales office or write: Aluminum Company of America, 1969-C Alcoa Building, Pittsburgh 19, Pa.

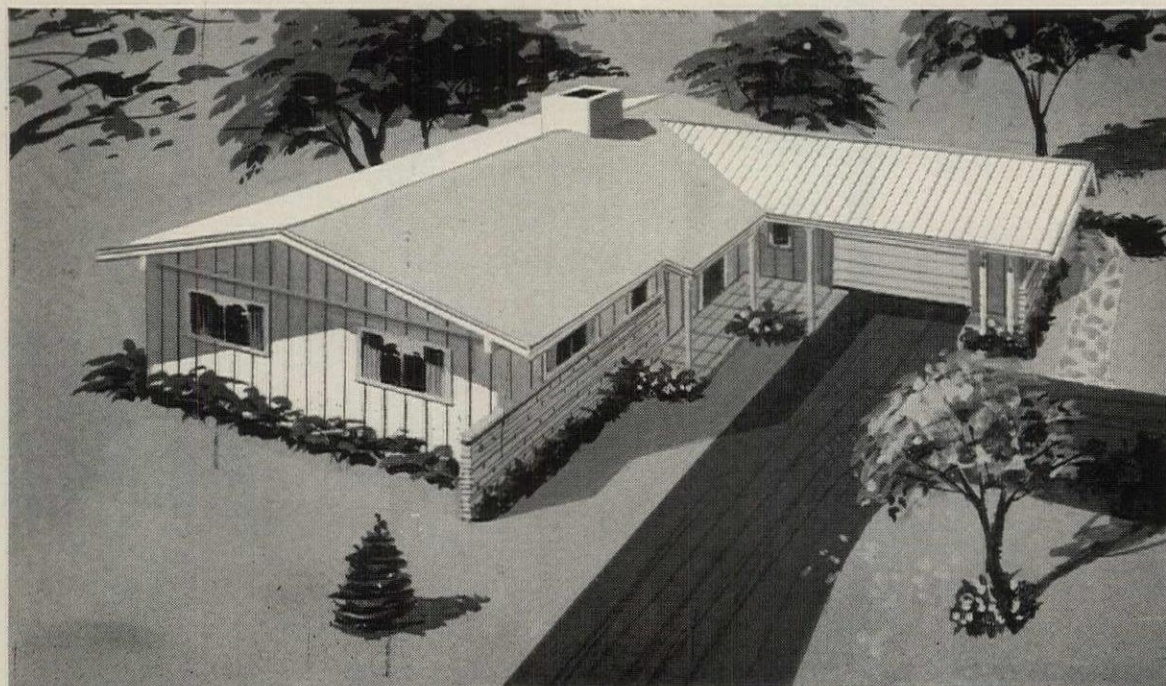

Look for this Alcoa Care-free tag on the aluminum siding you buy.



**Trade-in editorial**

I want to commend you for this very fine editorial [H&H, Jan]. I heartily endorse the program advanced. One of the great challenges in our industry is to provide a better plan for families with existing homes to trade-up.

J. W. UNDERWOOD, *president*  
*The Underwood Companies*  
*Jackson, Miss.*

Your editorial sets a stage that would create a virtual utopia for the home builder. I would be heartily in favor of utopia.

Nevertheless, I think you missed the real problem. The bugaboo of the house trade-in plan is mainly the fact that the American home owner has not been educated to the way a house must be traded. He still feels he should be able to buy a new home (or even an old home), live in it for a few years, and sell for a profit. Many builders are financially able to handle trades under the existing laws, but cannot get into the market in any volume because the home owner will not accept a realistic price for his home (market value less 10% to 15% for handling, carrying, and contingencies).

My company would be most pleased to sell any home we take on trade for the amount we have in it. It would be nice to make a profit, but we are interested only in moving the new house. In fact, we go so far as to tell the customer that when his trade-in home is sold by us, we will refund to him any profit that might be made.

RALPH O. TAYLOR, JR., *president*  
*Sturgeon & Taylor Development Co*  
*Kansas City, Mo.*

The article is very timely. Practically every other type of industry has a trade-in allowance.

HARRY P. SIMPSON, *president*  
*Minot Federal Savings & Loan Assn*  
*Minot, N.D.*

The trade-in problem is our greatest bottleneck in the home market. Your five-point program is at least a partial solution.

The non-liquid nature of the existing house is a barrier even to the psychology of the person interested in a better home, let alone to his financial ability to buy.

For the past three years, we have been making trade-in loans to our local builders and brokers on the basis of a 15-year amortized loan with semi-annual payments, for 80% of the appraisal. This arrangement gives the holder approximately seven months to dispose of the property before any loan payment is necessary. Under normal circumstances, this is ample time. We are now trying to encourage trade-in activity by utilizing our new 90% loan authority for financing the resale of the trade-in property.

There is a great amount of educational work to be done, both the public and the builder. The automobile user is used to the idea of depreciation and does not expect to trade his old car at the equivalent price for a new car. But there is not one home owner in a thousand who does not expect to sell his old home for a price that will recover at least all the money he has ever put into it, plus the broker's commission.

The same customer who agrees to a trade price for his old home when he is

anxious to buy a new one will later criticize the builder or broker who was able to sell the old home for more than the trade price—even though the final sale recovered only the builder's or broker's costs. This creates a public relations problem and makes brokers and builders unwilling to take trade-ins.

In our lending area, we are working with two new corporations, formed for the sole purpose of acting as "secondary housing markets" or as warehouse owners of homes. They are in a better position than the broker or the builder to deal at arm's length with the owner and to be realistic about trade prices. We will make to these corporations the 80% 15-year semi-annual payment loan described above. It is still too early to tell how successful these operations may be or what volume of business they may be able to generate.

A. D. THEOBALD, *president*  
*First Federal Savings & Loan Assn*  
*Peoria, Ill.*

The five points you put forth to aid builders and realtors in making trade-ins are excellent. This type of program is vital to the up-grading of housing for all America. A cooperative effort by the home builders and by NAHB in Washington would certainly be in order to put through such a program.

SIDNEY W. DIAMOND  
*General Insurance-Real Estate*  
*Poughkeepsie, N.Y.*

I am more pessimistic than you.

During the past ten years there has been a tremendous building program. People with very small equity have little to trade in on the new house. As to the older houses—FHA probably would not finance them or the VA either, if they are very old. We have had quite a number of these presented to us—houses where the owners have traded in. We sometimes finance them where they are in good shape, but I resent having to handle the leftovers.

On the matter of a bank or a savings and loan making a short-term loan on the old house, there would always be the question of whether they would find they have a permanent loan, which they don't want, instead of a short-term loan. Cars are generally easily disposed of but houses can be pretty slow collateral.

FRED C. MORSE, *president*  
*The Mutual Savings Institution*  
*Austin, Texas.*

**Uniform plumbing code**

The Code Round Table program (H&H, July '58) is a first sincere attempt to develop unified thinking and a program of standardization in the construction industry.

Selfishly loading a code with unnecessary requirements has led to confusion within the industry and additional expense to the public. Good codes initially built sound business, which a few in the industry may have forgotten in pushing for code reform.

We too, embrace most of the conclusions within the six point reform program. We have progressed without fanfare for 29 years to include approximately 1,000 governmental agency-users of the Uniform Plumbing Code throughout the eleven western states. The Uniform Plumbing Code is the only document of its kind.

The National Plumbing Code, which the panel apparently endorsed as the ultimate, is not a code, but is in fact only a report of a coordinating committee (of which we were and still are a member). This document is not all-inclusive on the subject of plumbing. Neither is it in such status as to be readily adopted by reference by a legislative body—the Uniform Plumbing Code is both.

We take issue with two points: 1) annual revision and 2) who shall prepare and revise codes. Advise, assistance, and sponsorship by industry, yet. But code writing must be left completely in the impartial hands of the governmental administrative official.

JOHN F. BAXTER, *executive secretary*  
*Western Plumbing Officials Assn.*  
*Los Angeles*

**Blunt talk by a designer**

Congratulations on the new [Jan] issue. Your research certainly is impressive, particularly as to the tremendous growth anticipated here in California ("Big changes of the 1960s"). Now all we must do is convince a few million more people that architects are a necessity, not a luxury, and convince an equal number of officials that there are better ways to plan and build than those now being used.

I am particularly interested in the Round Table on plastics. Here again, we mainly have to fight the building inspector and then public taste, as the manufacturers seem ready to go ahead.

Plastic piping and the like will surely come very soon, but the main problem is the one we fight every day: the contractors do not want to do anything new, so they charge more for what we know to be cheaper faster methods. We will also have to convince all trades and unions that increased efficiency means more work, not more unemployment. This is your challenge because you will have to convince the builders, lenders, unions, and many others before we ever get a chance to use our technology and training properly.

FELIX M. WARBURG, *designer*  
*San Rafael, Calif.*

**The big change of the 1960s**

I have read a good many forecasts and reports on the population explosion expected in the 1960's, but none so meaningful to the opportunities and problems that lie ahead in the housing field as H&H's January cover story. Congratulations to you and your staff.

BERNARD E. LOSHBOUGH, *exec. director*  
*ACTION-Housing Inc*  
*Pittsburgh.*

"How the Big Change of 1960 Will Affect You" is a thoughtful and stimulating presentation. Would it be possible to get 500 reprints?

R. M. HUMPHREY, *president*  
*First Federal Savings & Loan Assn*  
*Everett, Wash.*

**Research houses**

Congratulations on the fine story you published (H&H, Jan) on NAHB's South Bend and Knoxville research houses. You made a fine contribution in terms of interesting your readers in doing something about developing a quality house for less money.

PAUL B. SHOEMAKER, *vice-president*  
*Masonite Corp*  
*Chicago.*



NEWS STAFFERS are (l to r) Associate Editors Robert Seaver, Richard Saunders, John Senning, and News Editor Gurney Breckenfeld.

## Four newsmen home from the newsfront

Dear Subscriber:

This picture was taken just after H&H's four fast-moving news editors returned from this month's news-gathering trips and were starting to write the preceding pages of housing news (pp 39-111).

In this letter I'd like to tell you a little about where they went and whom they saw—so you can see how, month after month, they get the news on important housing subjects like legislation, mortgage money, labor, statistics, materials prices, zoning, and community facilities.

Starting in January, they rushed the last of their February news copy to the printer four days ahead of schedule so they could join other HOUSE & HOME editors for the opening of the NAHB Convention in Chicago. (Their reports on the convention start on p 86.)

Before the convention had closed, News Editor Breckenfeld was flying to Washington to attend the Senate Banking Committee's five-day hearing on the 1959 Housing Act. He stayed on in Washington to interview Julian Zimmerman, new FHA commissioner. (For a close-up of a man who has not been in the limelight until now, see p 103.)

Breckenfeld, a graduate of the University of California, came to Time Inc from the San Francisco Examiner in 1951. He has been news editor of HOUSE & HOME since it was started in 1952. An astute student of housing as well as a crack reporter and writer, Breckenfeld has twice won Jesse H. Neal editorial achievement awards of merit. He just co-authored a book, "The Human Side of Urban Renewal," with Martin Millsbaugh, assistant Urban Renewal commissioner.

Covering the Banking Committee's hearings in Washington with Breckenfeld was our Washington Editor, Richard Saunders. (Their report on the widening schism between private and welfare-state advocates over the role housing should play in the nation's economy starts on p 43.)

Saunders is the dean of Washington's housing correspondents. He joined ARCHITECTURAL FORUM, HOUSE & HOME's sister publication, in 1934; has been our Washington editor since 1952. An expert on FHA since its earliest days as a New Deal experiment, Saunders knows intimately the policies and personalities of this and other government housing agencies.

Associate Editor John Senning returned directly to New York from Chicago to take up the chores he shares with Breckenfeld as editor to the dozens of correspondents from coast to coast who funnel housing news into HOUSE & HOME. He also began phoning all over the country to get market quotations on FHA and VA mortgages. (For a unique and exclusive stock-market-type report on mortgage discounts, see "Mortgage Market Quotations" p 65).

Senning, born in Chicago and educated at the University of Arizona, came to us from the Miami Herald where he won an AIA award for the best architectural article in a newspaper.

Associate Editor Robert Seaver stayed in Chicago for two days after the NAHB Convention to talk with Chicago experts on transit and urban renewal, and to visit a firm of mortgage bankers whose apartment project on the edge of the city's Southside Negro neighborhood has an astonishing 75% white occupancy. Seaver was back in New York in time to cover—with pencil and camera—the Civil Rights Commission hearings on segregation in housing. (For his report, see p 73.)

Seaver, raised in Illinois and educated at Harvard, came to us after working on Chicago and New York newspapers and magazines. In Chicago he won (with six others) an American Newspaper Guild Page One Award for a series on Chicago's slums.

The hard work and reporting skill of these four newsmen have earned them respect throughout the housing industry. It is by now an old saying in the field: "I have to read HOUSE & HOME to find out what's going on in housing."

Sincerely,

Editor & Publisher

Published by TIME Incorporated

EDITOR-IN-CHIEF.....Henry R. Luce  
EXECUTIVE ASSISTANT.....Albert L. Furth  
PRESIDENT.....Roy E. Larsen

EDITOR & PUBLISHER  
P. I. Prentice

MANAGING EDITOR  
Robert W. Chasteny Jr.

EXECUTIVE EDITOR  
Carl Norcross

ASSISTANT MANAGING EDITORS  
John F. Goldsmith  
Walter F. Wagner Jr.

NEWS EDITOR  
Gurney Breckenfeld

ART DIRECTOR  
Jan V. White

ASSOCIATES  
Edward Birkner, James P. Gallagher  
David R. Kerr, Kathryn Morgan-Ryan  
Robert W. Murray Jr.  
Richard W. O'Neill, Arthur David Piper  
John Senning, Robert Seaver  
Richard Saunders (Washington)  
Clifford S. Smith, Paula Treder, AIA

ASSISTANTS  
Marcia Frank, Natalie F. Siegel  
Olive F. Taylor, Jenepher Walker

CONSULTANTS  
Carl Boester, Miles L. Colean, FAIA  
Thomas P. Coogan, Ruth Goodhue  
James T. Lendrum, AIA, David C. Slipher

PRODUCTION MANAGER  
Lawrence W. Mester

CIRCULATION MANAGER  
William L. Taylor

BUSINESS MANAGER  
Archibald Peabody Jr.

DIRECTOR OF MARKETING  
Arthur S. Goldman

ADVERTISING DIRECTOR  
Richard N. Jones



Volume XV, No. 3

**HOUSE & HOME** is published monthly by TIME INC. Time & Life Building, 9 Rockefeller Plaza, New York 20, N. Y. Yearly subscription payable in advance. To individual or firms (and their employees) engaged in building—design, construction, finance, realty; material distribution, production or manufacture; government agencies and supervisory employees; teachers and students of architecture and trade associations connected with the building industry; advertisers and publishers: U.S.A., Possessions, Canada, \$6.00; elsewhere, \$8.50. Single copies, if available, \$1. All copies mailed flat. Please address all subscription correspondence to **HOUSE & HOME**, 9 Rockefeller Plaza, New York 20, N. Y. When ordering change of address, please name the magazine and furnish an address label from a recent wrapper, or state exactly how the magazine is addressed. Both the old and the new address are required. Allow four weeks for the change. © 1959 by TIME INC. All rights reserved.

**TIME INC.** also publishes **TIME**, **LIFE**, **FORTUNE**, **SPORTS ILLUSTRATED** and **ARCHITECTURAL FORUM**. Chairman, Maurice T. Moore; President, Roy E. Larsen; Executive Vice-President for Publishing, Howard Black; Executive Vice-President and Treasurer, Charles L. Stillman; Vice-President and Secretary, D. W. Brumbaugh; Vice-Presidents: Edgar R. Baker, Bernard Barnes, Clay Buckhout, Arnold Carlson, Allen Grover, Andrew Heiskell, C. D. Jackson, J. Edward King, James A. Linen, Ralph D. Paine Jr., P. I. Prentice, Weston C. Pullen Jr.; Comptroller and Assistant Secretary, John F. Harvey.

## STORY OF THE MONTH

124 *Would you be able to compete in Dallas?*

## BUILDER STORY

134 *What happened when a 12-house builder switched to components*  
183 *The "sold out" house that buyers insist on buying*

## DESIGN

140 *Is this the ultimate in indoor-outdoor integration?*  
154 *Portfolio of today's vacation houses*

## MERCHANDISING

146 *How to sell houses*

## MORTGAGE MONEY

167 *How Fort Worth's FHA office makes appraisals in a gold fish bowl*

## TECHNOLOGY

172 *The case for electric heat*  
179 *Here's a new LuReCo panel—with a built-in header*  
180 *From Michigan State: here's a new low-cost beam*  
181 *Here are six new truss details from the Small Homes Council*  
182 *Conventional roofs are still the cheapest, Small Homes Council reports*

## NEW WAYS TO BUILD BETTER

189 *Showcase*  
201 *More technical news from the Small Homes Council*  
206 *What the leaders are doing*  
210 *Sliding-glass door round-up: what's new for 1959*  
222 *Other new products*  
256 *Reviews of new technical literature*

## NEWS

*What's in prospect for the 1959 Housing Act*  
*How many starts this year: a fresh look*  
*Mortgage market: will 5¼% be high enough?*  
39 *Index to these and other News reports*

## DEPARTMENTS

116 *Letters*  
269 *Advertising index*

## COVER

House in Horsehead Bay, Wash.  
Marshall W. Perrow, architect;  
Lawrence Halprin, landscape architect.  
Photo by Charles R. Pearson.

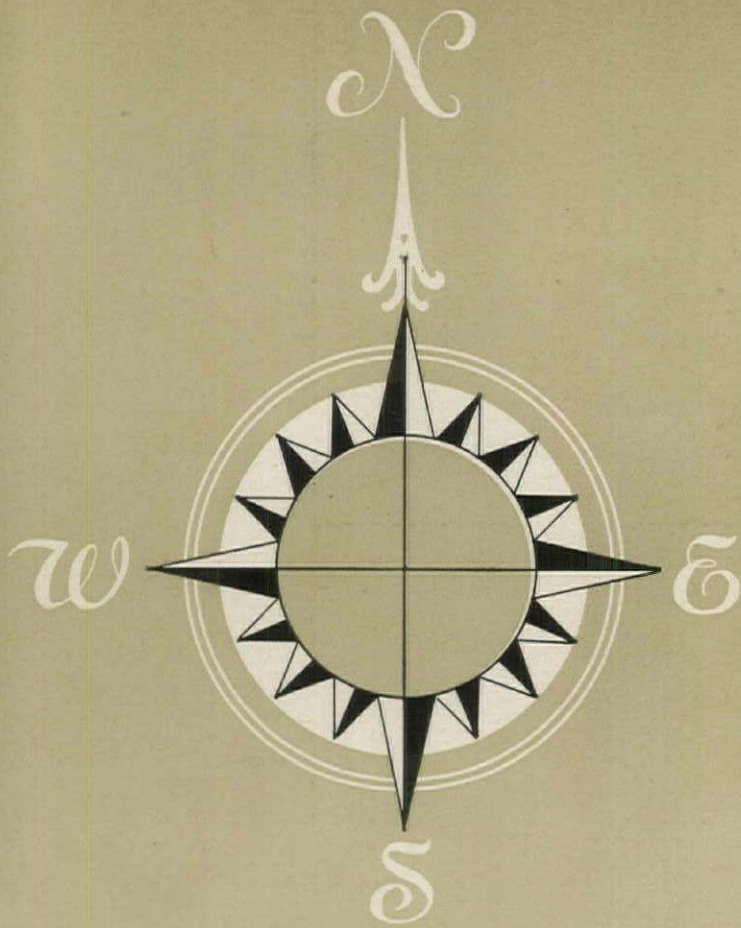

ALL OVER THE COUNTRY builders are offering much more attractive houses. As you travel you see builders offering more value for the money, builders offering better design and construction, builders offering more of the conveniences people want inside and out. And you see builders using more advanced technology, more quality products, more sophisticated merchandising techniques.

All over the country these progressive builders are taking advantage of opportunities that are open to *every builder, everywhere.*

For example, look at DALLAS







## ... and its new top-value houses

Dallas is a fine example of how much better homebuilders are building today than they were three or four years ago.

In 1955 most Dallas builders were caught by a buyer's market, caught with a lot of wornout designs and no idea how to sell them (H&H, Jan '56). Only a few builders who had had the foresight to offer something new were doing all right.

Today the Dallas homebuilding picture is one of the brightest in the US—in sales, in values offered, in real competition. Look at the difference:

In 1955 few Dallas builders offered good design. Now design is better in every price class.

In 1955 few offered indoor-outdoor living. Now nearly everyone provides it.

In 1955 most offered bare houses. Now most include built-ins and other luxuries, like wall-to-wall carpeting, even in small houses.

In 1955 few knew much about selling. Now they are top merchandisers who plan their selling from the ground up.

In 1955 almost all built with traditional craft methods. Now many are using the latest cost-cutting construction techniques.

On the next eight pages you will see what Dallas builders are doing. You will see their better design (*pp 126-127*), their construction methods (*pp 128-129*), their built-in conveniences (*pp 130-131*), and their smart merchandising (*pp 132-133*).

# Look at the variety and the value

People can buy houses in any price class in Dallas today. And they can find much better design than a few years ago. Many leaders say that better design has been a major factor in their success. Several builders report they are making further, and sometimes radical, improvement in the design of the new models which they will bring out this spring.



## You see indoor-outdoor living everywhere

This \$24,000 Regency Homes model shows how much attention Dallas builders are giving to indoor-outdoor living. The 8'x30' covered terrace has a barbecue, and sliding glass doors open onto

it from the family room and two bedrooms. The 2,100 sq ft air-conditioned house has four bedrooms, 2½ baths, and carpeting throughout. Regency expects to sell 175 houses this year.

Ulric Meisel



## This contemporary is the newest hit

Nine families paid \$25,950 for this contemporary within 16 days after it was opened in January by the new Kay Lee building company. It has over 1,800 sq ft of air-conditioned living space, a big rear patio, and all appliances built-in.

H&H Staff

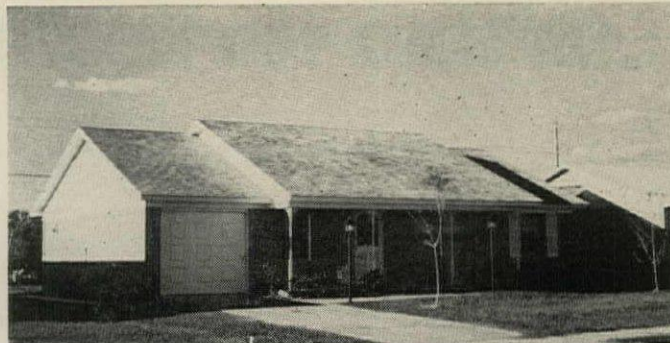

## Here is a big favorite at \$14,000

Five hundred houses like this were built and sold in 1958 by Centennial Construction Co in its first year. Though the design was so-so, sales were spectacular because the houses were jam-packed with extras in kitchens and baths.

N. Bleecker Green

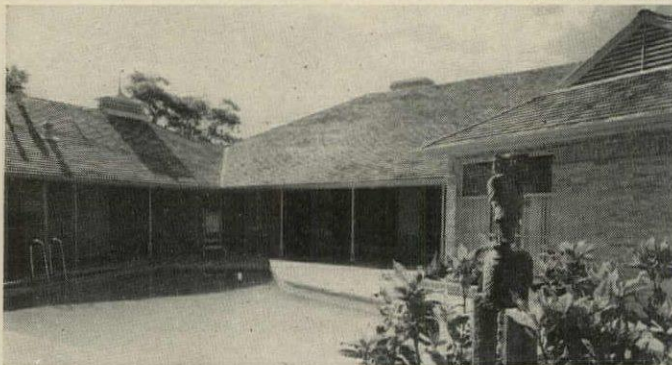

## This speculative house sells for \$85,000

Builder George Sebastian's big built-for-sale house has a heated swimming pool, three bedrooms and a library (all with private baths), servants' quarters, and every built-in luxury. Some houses sell for as much as \$125,000.

H&H staff



## You still see many big colonials

Builder Billy G. Underwood uses slab foundations to help bring his colonials close to the ground so they do not look boxy. He also builds contemporaries. Last year he sold 40, this year expects to sell over 100 at \$22,000-\$32,000.



**This \$8,250 house has three bedrooms**

It is the first of 2,000 in all price classes which Vernon & James Smith Co plans in its big community for Negroes near the new Bishop College campus. This model has three bedrooms, one bath, central heating, an attached garage, and 900 sq ft of living space.

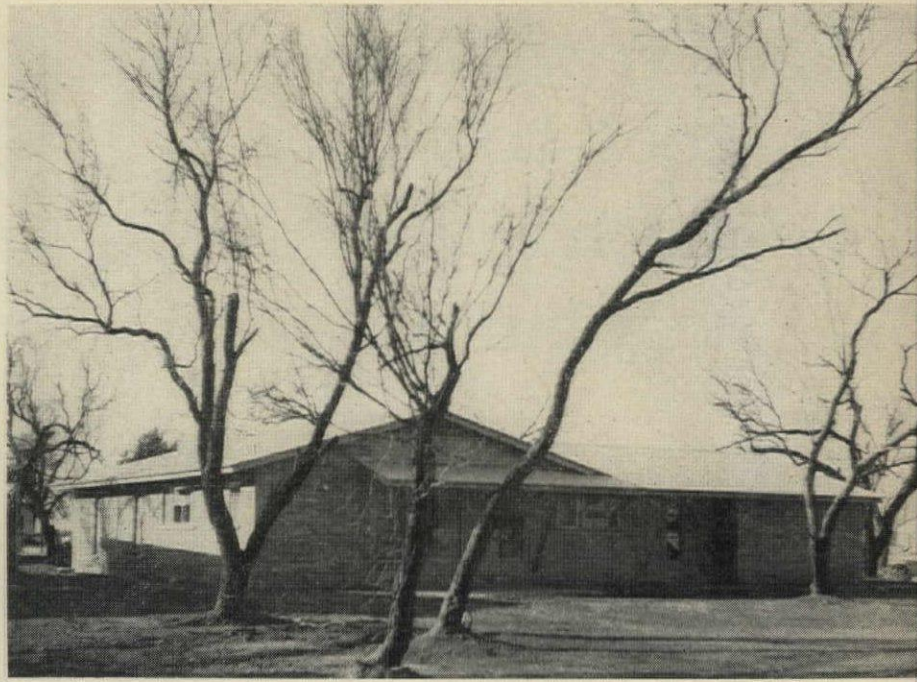

**You are looking at the rear of a \$14,000 house**

You can see that even small houses in Dallas are now showing signs of the architect's hand—in this case, Milton Barrick's. Good design and good floor plans last year started off Real Estate Development Corp's new Northgate tract with 150 sales of the \$13,500-\$16,500 models.

I. B. Lindenthal

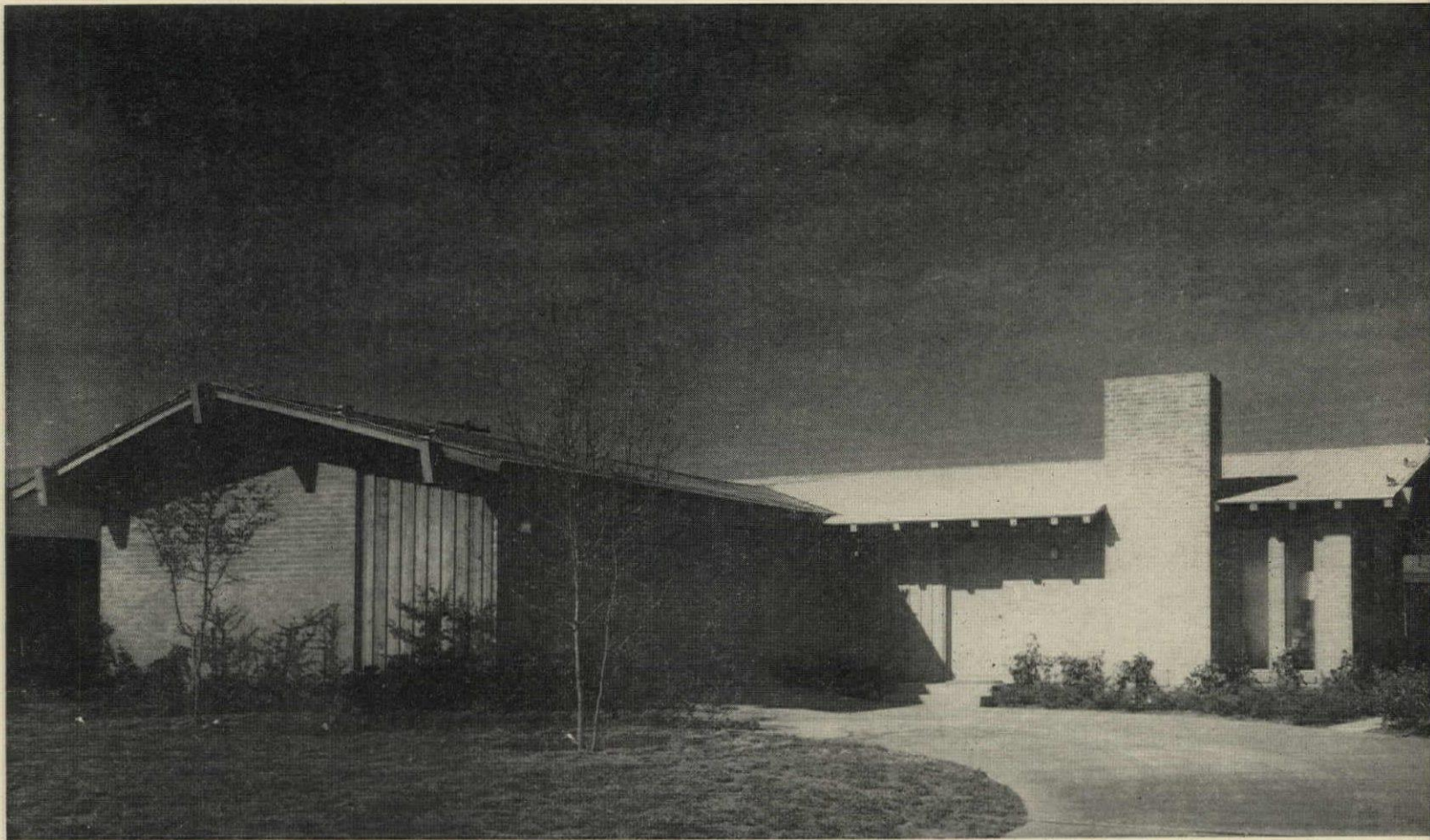

**Here is Fox & Jacobs' new best-seller in the \$14,000-\$18,000 price class**

Dallas' famed building team of Dave Fox and Ike Jacobs offered four designs in their new Accent tract last fall. The best-seller by far was this contemporary—somewhat to the partners' surprise, since they had been warned of a trend

toward older styles. The house was designed in cooperation with Los Angeles Designer Tony Pereira and F&J's Designer Parker Folse, who went all-out on contemporary design and decoration inside the 1,700 sq ft house too.

*continued*

## Look how much better they build

Today's aggressive competition is forcing Dallas builders to give homebuyers much greater values than were general a few years ago. One way some builders increase values and pay for all the extras they are putting in the house, is by adopting new cost-cutting techniques. Many other builders still are prevented from making sweeping technological changes because they subcontract almost all of the actual construction. One such builder's answer to this problem: hire a time-and-motion man to study the subs' practices and suggest cost-cutting changes.



### More builders are using components

In the past eight months Southwest Housing Co has been building up a strong demand for its new components like the truckload shown above. A dozen builders have recently switched from conventional building to using Southwest's panels and trusses made to

the builders' specifications.

Southwest has \$40,000 of equipment, much of it designed by Architect-Manager Thomas Russ. He and partners Vernon and James Smith expect to sell several hundred component houses this year in Dallas and Corsicana.

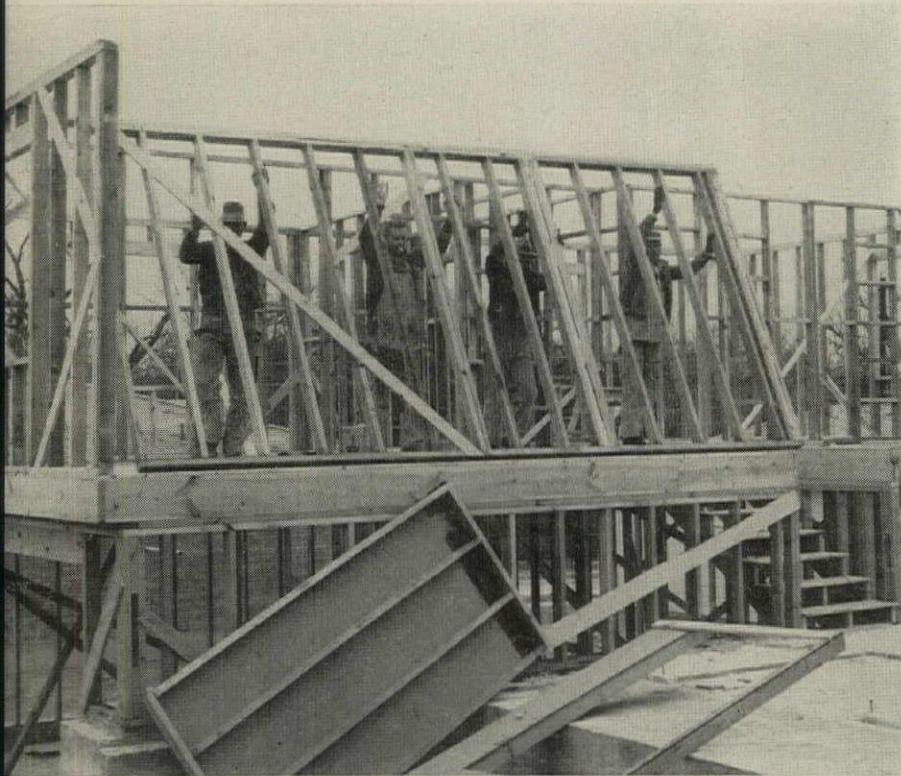

### This split level is made with panels

Builder Joe Maberry's latest model, an 1,800 sq ft split-level, was framed in just one day because he used panels and trusses ordered from Southwest Housing. The trusses cost \$12 each, were set 24" oc. Four common laborers took four hours to get the roof up. Conventional roofs in Dallas County take a week with skilled carpentry labor.

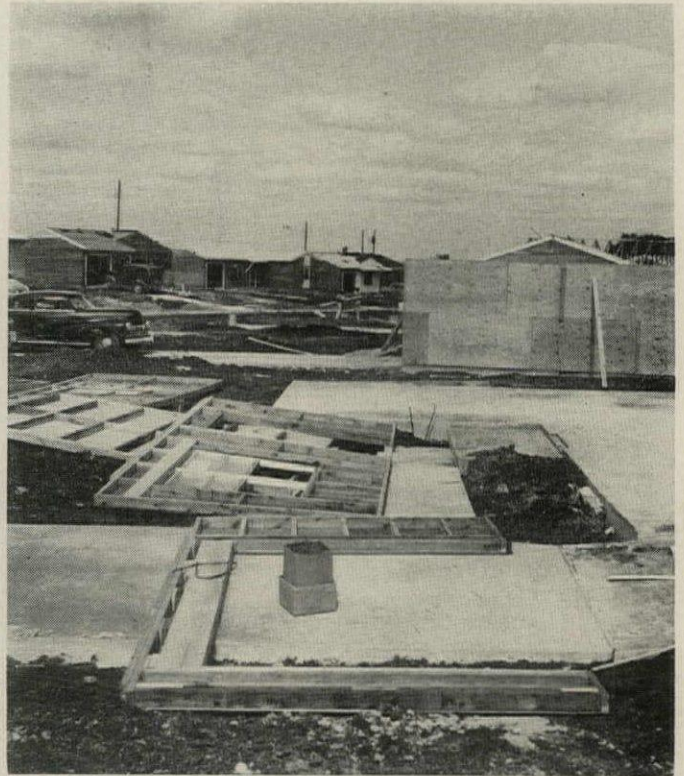

### Here is assembly-line production

Vernon and James Smith, architects and longtime conventional builders in Dallas, have turned to new cost-cutting methods in their big houses as well as small ones. Wall-length panels shown above were tested in the first 100 houses built for Negroes (see p 126). These builders use glue-nailed trusses, gained FHA approval for them in the Dallas area.

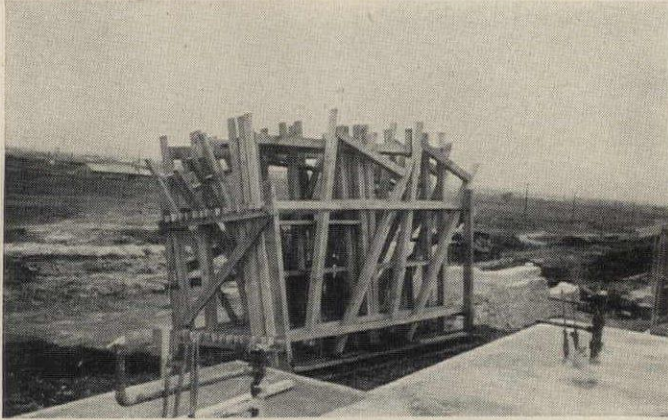

**A PALLET RACK** filled with parts is moved by fork lift.



**JUNK WAGON** makes it easy to collect debris and odds and ends.



**FLATBED TRAILER** carries components right up to the job.

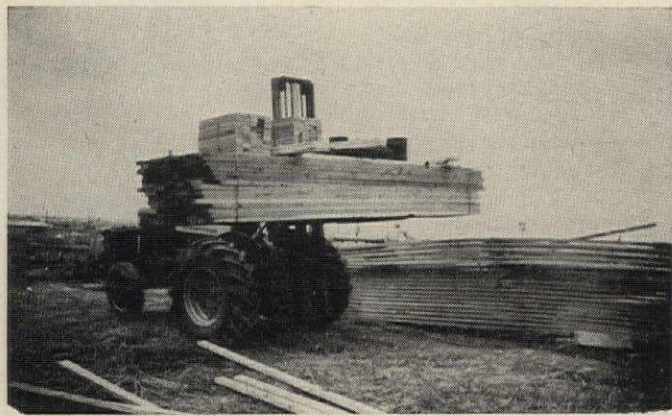

**FORK-LIFT TRACTOR** can tote material easily on rough terrain.

### Here is how operations are being mechanized

The pictures above and right are all new time-and-money savers used by Fox & Jacobs, who have long pioneered in advanced construction techniques in Dallas. These methods have enabled F&J to get the jump on their competition—and much the same can be said of Centex and other Dallas leaders who have stressed cost-saving practices.

The lesson has not been lost on other builders. Many have copied these techniques and developed their own smart building methods. Here are two examples:

Mahaffey-Wagner Construction Co is making its own trusses and panels in its "inventory yard" and hauling them to building sites, a house-load per trailer. Aldon Wagner says this system sharply cut costs and speeded construction time in building their 238 houses last year in the \$10,000 to \$14,000 price range.

Knighton & Cox, who build about 25 custom houses a year at \$25,000 to \$60,000, report big savings by making all their own millwork: moldings, built-ins, cabinets, and the like. They say this system can cut the erection time for a big house as much as 25 days.

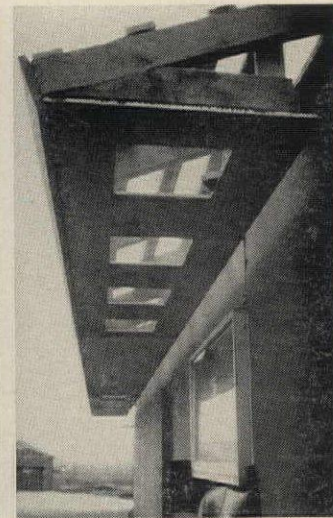

**TWO COST CUTTERS:** long-handled paint rollers, and a suspended soffit that eliminates horizontal 2x4 lookouts (H&H, Jan p 198).

### This inside brick wall cuts costs, helps sales

So says Builder Leland Lee, who puts Mexican brick veneer on both sides of a 14' wall in each of his 1,800 sq ft houses. "Good paneling costs as much," he says. "In addition, it means I don't need to put insulation in the wall. I save enough this way so that every 14th house I build can be insulated practically free."

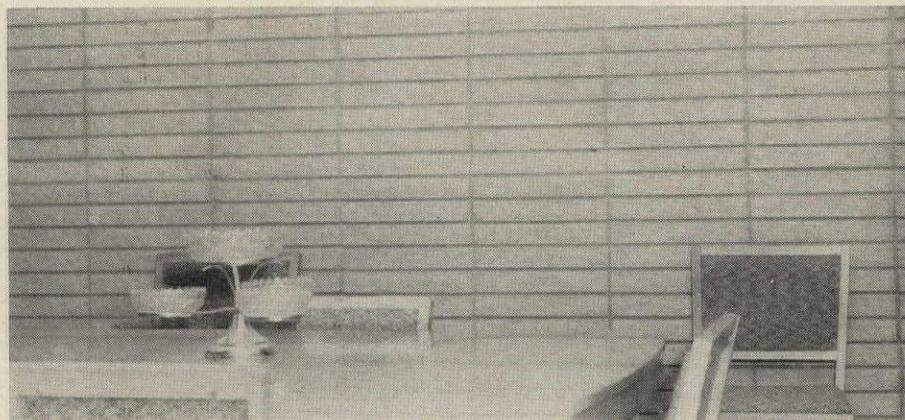

*continued*

## Look at all the built-in luxury

The biggest change in Dallas since 1955 is the switch to offering the utmost in built-in conveniences. Completely equipped kitchens are standard in many of the lower-priced houses, and extras may amount to over \$1,000 more than allowed in FHA appraisals. Here, for example, are some of the many conveniences offered in one \$23,000 house built by Vaughan Williams Jr: special storage spaces for umbrellas, golf clubs and card tables and chairs; built-in hi-fi; built-in workbench; fold-down step under the lavatory and lowered tub in the boys' bath; outdoor passthrough for fireplace logs, and private patio off the master bedroom.



### Baths are jam-packed with extra features

The bath and a half shown above is in Centennial's \$14,000 houses! Count these extras:

- Indirect lighting overhead.
- A dressing table and large mirror.
- Colored bath fixtures.
- Sliding mirror doors on cabinets.

Woven metal linen cabinet doors.  
"Glasslike" ceramic floor tiles.

Waterproof wallpaper.

And the bathtub has a dome light, a handsome sliding enclosure, and is insulated and elevated to make it easier to bathe small children.

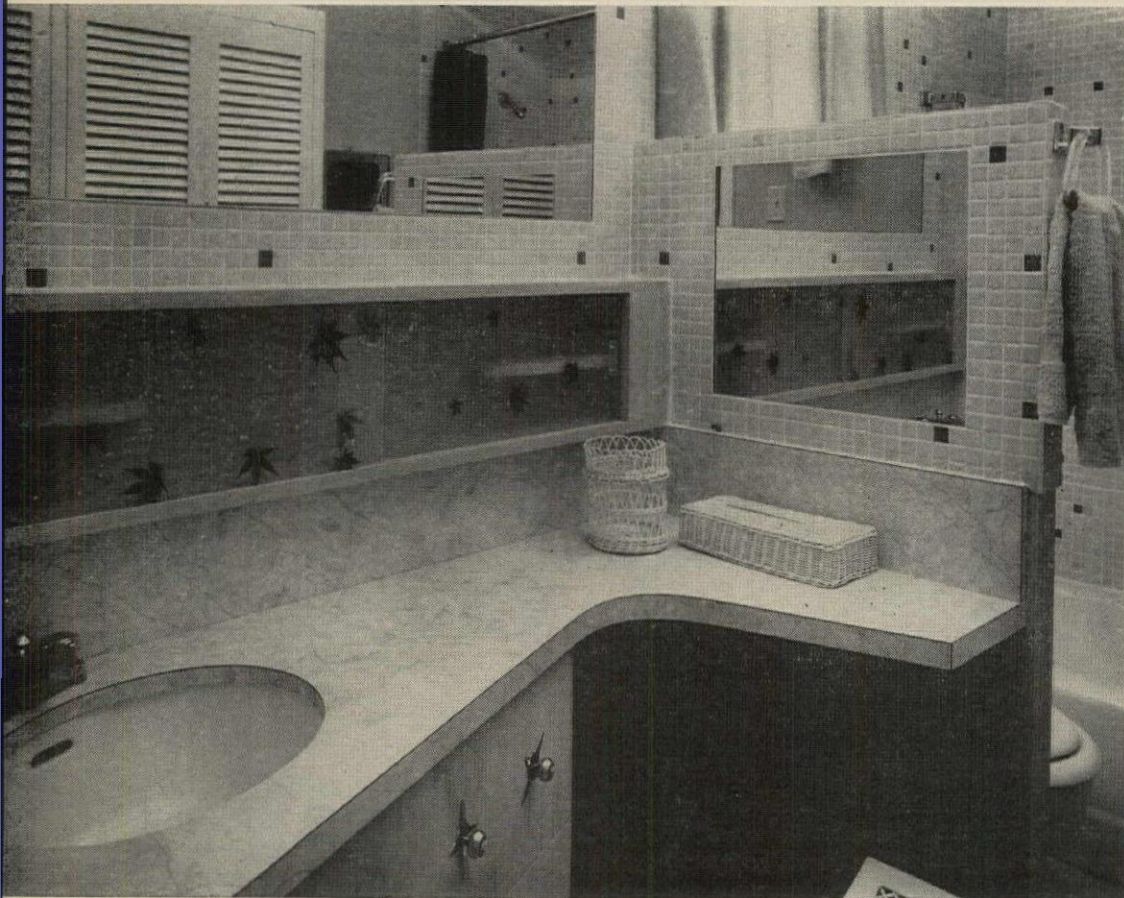

Photos: Ulric Meisel

### Count these fine details

Northgate houses at \$14,000 up have two full baths. One bath (above and left) has a compartmented shower completely tiled, a dressing table with laminated plastic top and back splashes, a magazine rack, louvered doors to linen cabinet and clothes hamper, a wall heater with blower for drying hair, and indirect ceiling lights.



**This is the kind of kitchen buyers get in a \$14,000 house**

Dallas builders certainly do not skimp on kitchen extras. This view from the family room in Centennial's 1,300 sq ft three-bedroom model shows no end of built-in luxuries.

Buyers get a family-size breakfast bar around a big work counter that has indirect lighting above. At one end is a built-in blender and mixing center. The ceiling is furred down over handsome cabinets. Beyond the work center is a

double sink with built-in vegetable spray and plastic laminated countertop. There is indirect lighting, copper range hood, fan and copper tile above the burner top, as well as a built-in oven. The floor is surfaced with vinyl tile.

Just to the right of the oven is a large pantry with space for washer, dryer, and freezer. At far left is the back door and a wide window, both glass from floor to ceiling.

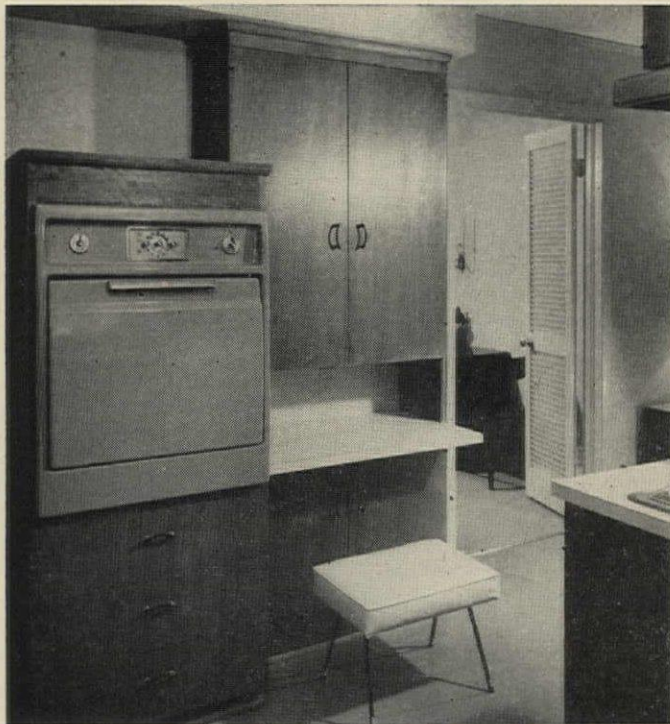

**Built-ins like these are popular in all price ranges**

Mahogany cabinets and drawers are plentiful in the Northgate kitchen shown at left. The view here shows a desk located midway in a 25'-long kitchen-family room area in a 1,560 sq ft model that sells for \$14,000 without appliances.

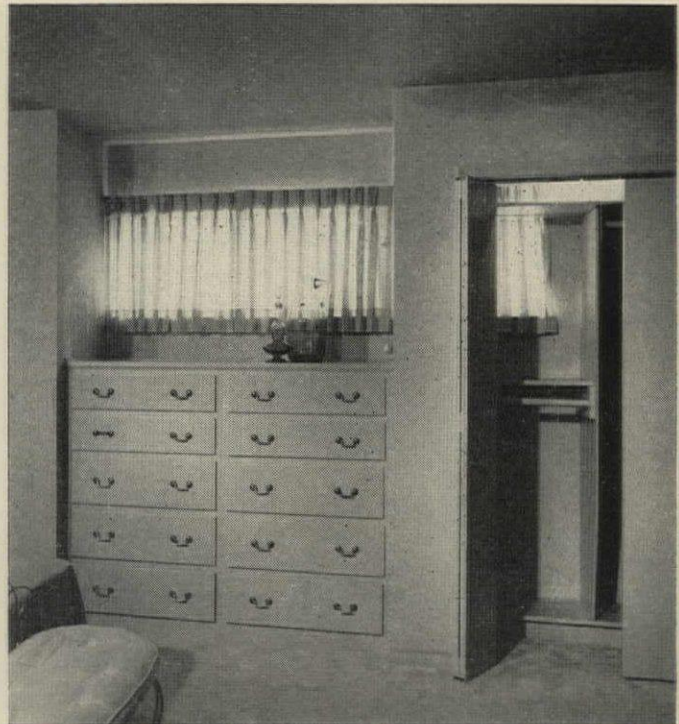

At right is a typical bedroom in one of Builder Billy G. Underwood's \$22,000-\$32,000 models. All bedrooms in his houses have these big built-in dressers and special closet shelving. He says built-ins prove "irresistible to women buyers."

*continued*

# Look at the model house merchandising

Dallas home builders have become masters of merchandising. Most big builders furnish several models and some hire West Coast designers. A sign of the times: Centex's new sales manager is Walter Underwood, formerly a top merchandiser at Neiman-Marcus stores.

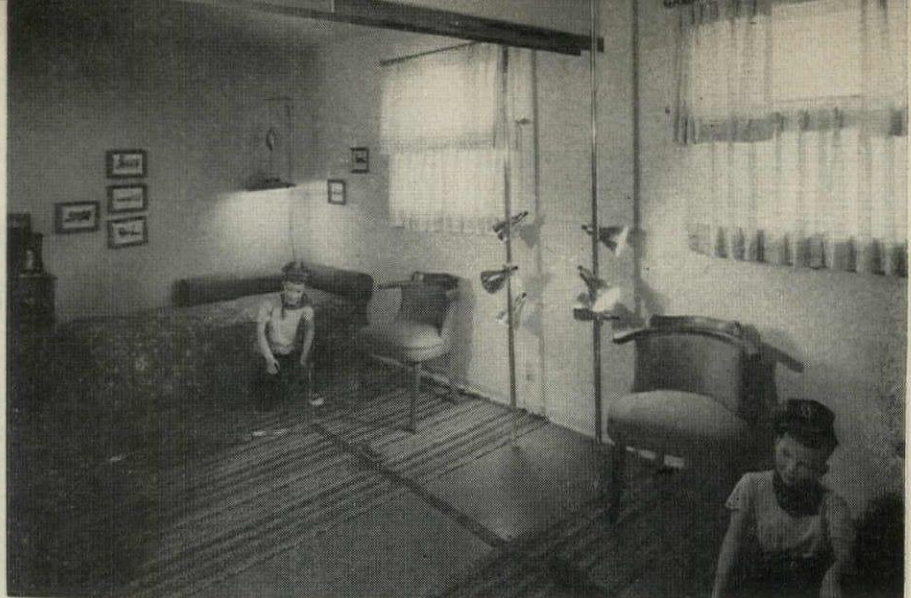

I. B. Lindenthal

## Life-size manikins liven up boys' rooms

Designer Tony Pereira used these two young "railroad men" in a Fox & Jacobs model to emphasize the advantage of having a sliding wall be-

tween two children's bedrooms. The life-like manikins are so startling, he says, that they caused many visitors to urge friends to visit the model.

Photos: H&H Staff

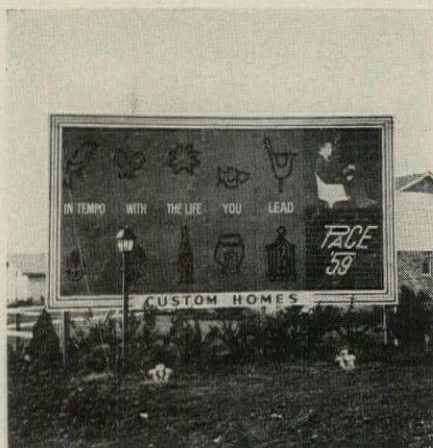

## Trade-in gets a big plug . . . so does design and location

Happy Homes' big sign at left tells prospects to ask for a trade offer. This company makes trading easy by offering to take title to the old house. Half its sales are made this way. (And half of its buyers take airconditioning at \$1,000 extra.)

At center is Kay Lee Corp's distinctive sign to stress the design of their Pace models. At right is Sparkman Club Estates' clever appeal to buyers who drive by on their way out from the city looking for a new house.

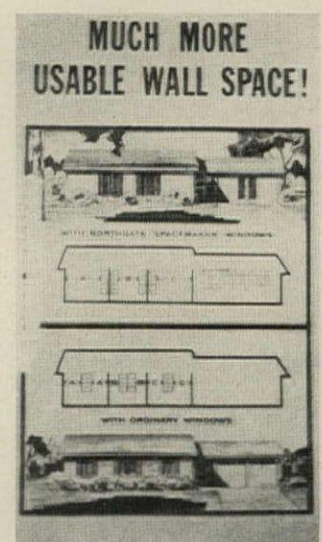
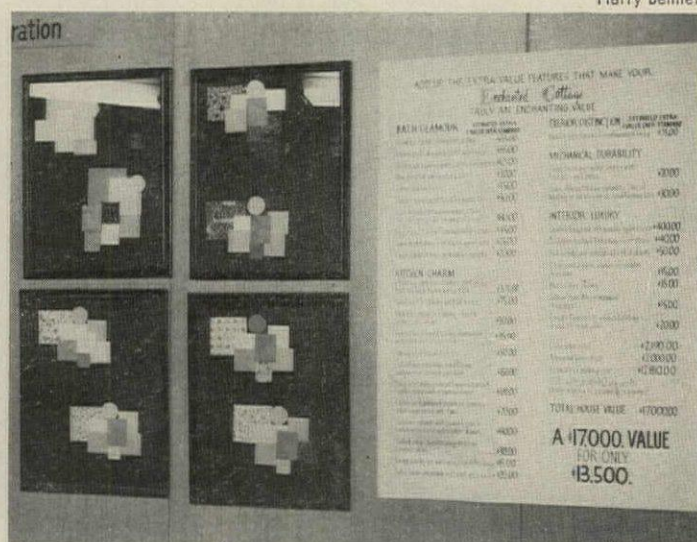

## Displays at the site sell people on quality products and equipment

Centennial Construction Co uses the brand names sign at left to show the quality of materials in its \$14,000 houses. In its garage "store" (center), Centennial shows color choices and a long printed list giving retail prices of all its extras,

which add up to more than \$2,000. (The \$13,500 total price was in effect last summer.) At right is a smart merchandising idea used on one panel in a garage sales office at one of Northgate's six furnished models.





Walter Lanley



### Rooms have a "lived-in" look

Everything in this bedroom shows it is a teen-age girl's. The room is in one of Centex Construction Co's many furnished models at three Dallas tracts. Designer Tony Pereira furnished each model with a specific family in mind.

### Outdoor living is played up, too

Many signs like this one inviting visitors outside to look at the paved terrace are used by Centennial Construction. Prospects have the full run of the house. Dallas builders seldom rope off rooms or limit use of chairs and sofas.

I. B. Lindenthal

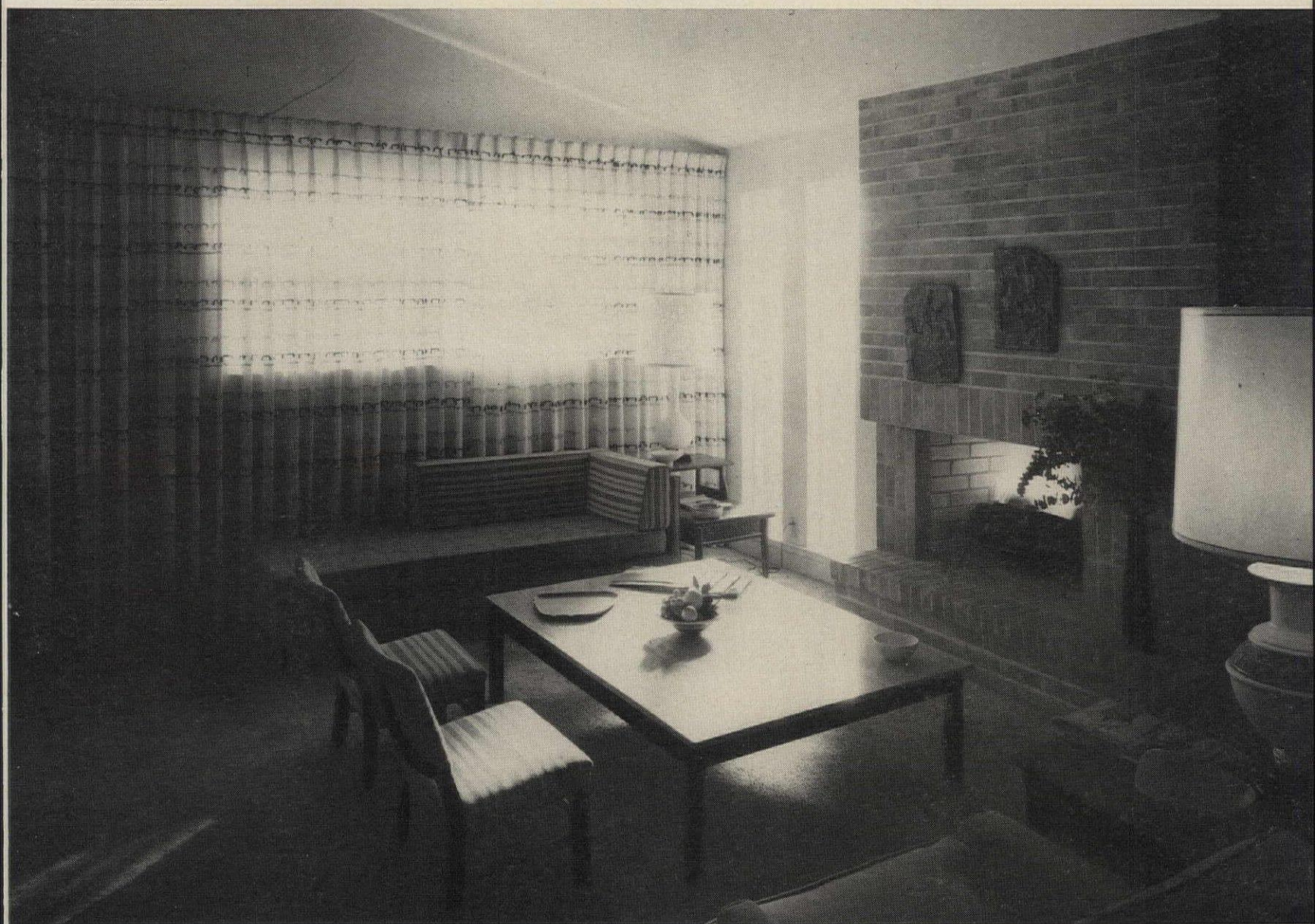

### This model house living room sums up the Dallas story

It is the living room of Fox & Jacobs' most popular model (see p 127). It shows:

Dallas builders are going a long way to offer good design. They are doing their best to offer high quality workman-

ship—notice the fireplace, for example.

And they are certainly making the most of the impact of top model house merchandising. As Dave Fox says, "I wouldn't think of not furnishing a model house today." /END



**HOUSE PRODUCTION** skyrocketed for Builder Dyches when he switched to components and started building on a 15-day schedule in mid-1957.



This is Savannah Builder Woodrow (Woody) Dyches.

Two years ago (see graph opposite) he was building 12 houses a year.

Last year his production was 85 houses, and this year he has scheduled 95 houses.

## What made this builder suddenly grow?

Woody Dyches started growing by: 1) switching to components, and 2) adopting a fast building schedule. Here is his story:

"As a conventional builder," says Dyches, "I was on a treadmill. I could make more money selling two of my lots than I could selling a house and a lot.

"I guess I was like most smaller builders. I just didn't know how long it was going to take me to build a house, or how much it was going to cost. I operated on old standard rules of thumb. I did know one thing—I wasn't making much money.

"Three years ago I began wondering about my methods when I noticed that Clayton Powell—a relative newcomer

in Savannah [see H&H Aug '55]—was outstripping me in sales. I analyzed his operation, found out that he was buying prebuilt and prefinished parts for his houses, and building faster than anyone else in town. So I was ready and willing when Powell suggested I join forces with him to set up a component-manufacturing plant to supply both of us with building parts.

### Here's what happened when Dyches switched to components

"First, my costs went down and my production went up.

"Second, I was able to tighten up my building schedule, which cut my costs even more. Building faster both built up my capital and turned it over faster.

"And third, I found that using components and building on a tight schedule gave me my first real understanding of costs."

"As I ordered components from a standard price list, I found I was automatically getting the exact cost of my materials, house by house. I learned about labor costs because I could see clearly just how much work was be-

ing done by how many men in how much time. And when I put my operation on a firm schedule, I found I was *controlling* my labor costs. In short, using components and a tight schedule gave me a built-in cost system."

Almost as soon as Dyches began building with components, he hiked his production sharply (see chart opposite). He had no trouble selling his expanded output because:

- 1) He had always had a reputation as a quality builder (when he built under FHA he had the highest FHA rating in the state).
- 2) His lower costs let him offer more house for the money.
- 3) He adopted conventional collateral financing which let him offer houses priced at \$11,250—\$13,000 for as little as \$500 down.

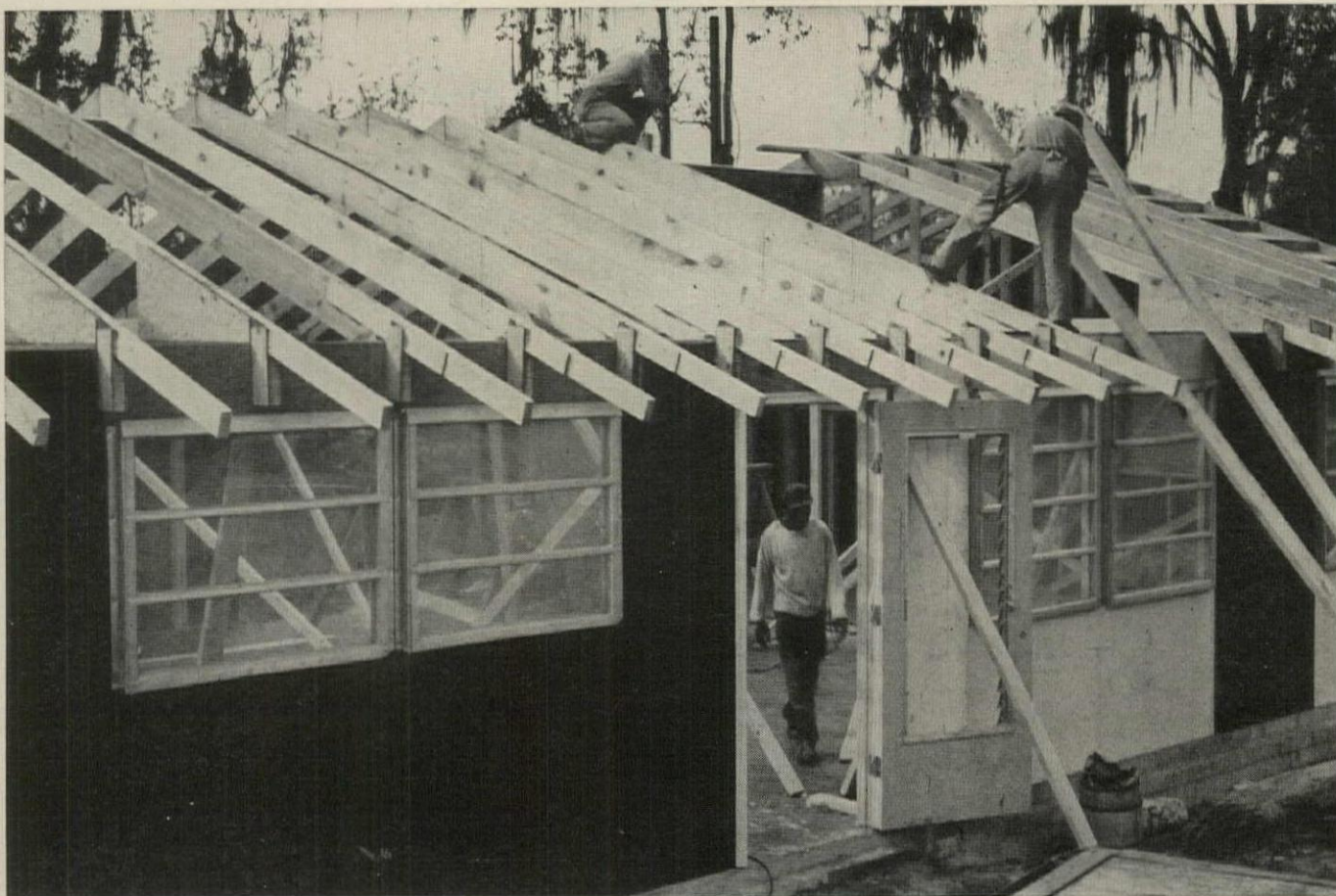

**COMPONENTS** fit precisely on site. Shown here: wall and door panels, trusses, cathedral-ceiling components. For details, see drawings.

## Building with components helped Dyches grow

"As a conventional builder, I was lucky to make \$1,000 a house; barely enough to buy land ahead," says Dyches.

But soon after he switched to component building, he started building up capital because his costs were lower and his profits higher.

Dyches explains it this way: "The components [see drawings] I build with now cost a good deal more than the materials—the small pieces—I used to build with. The reason is simple: the cost of a component includes the cost of a lot of labor to put it together.

"But assembling a house using components takes a lot less on-site labor than I used to need to 'piece together' a house conventionally. Further, this labor is a lot more pro-

ductive because there's no time wasted measuring, marking, and scratching heads. So the cost of materials and labor is lower when you build with components than when you build conventionally.

"But even if it weren't, I would still be saving money by building with components. Here's why:

"When you build with components, you save money because 'indirect' costs go down. You need less bookkeeping to schedule men and materials because there are fewer pieces and fewer jobs to keep track of. You need less supervision.

"And when you build with components, you can build a house in fewer days. So you save money on your construction loan and you tie up your capital for a shorter time."

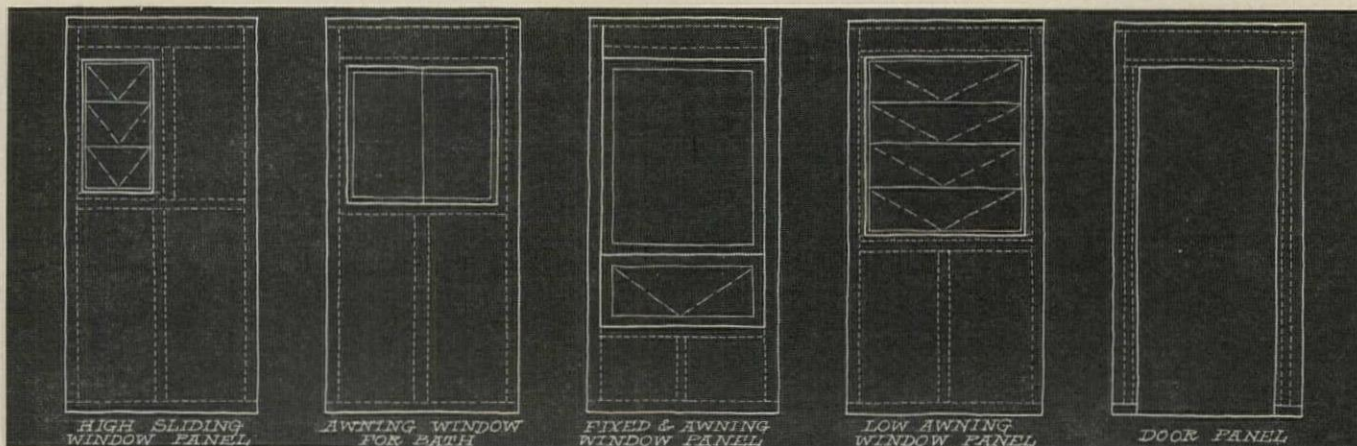

**WINDOW AND DOOR PANELS** have an integral plywood beam built by glue-nailing plywood between the top 2x4 of each panel and the 2x4 directly over the rough opening. This system was developed by

the component manufacturing company Dyches shares with Clayton Powell and is similar to the system developed by the Small Homes Council (see p 179). All panels are on a 4' module.

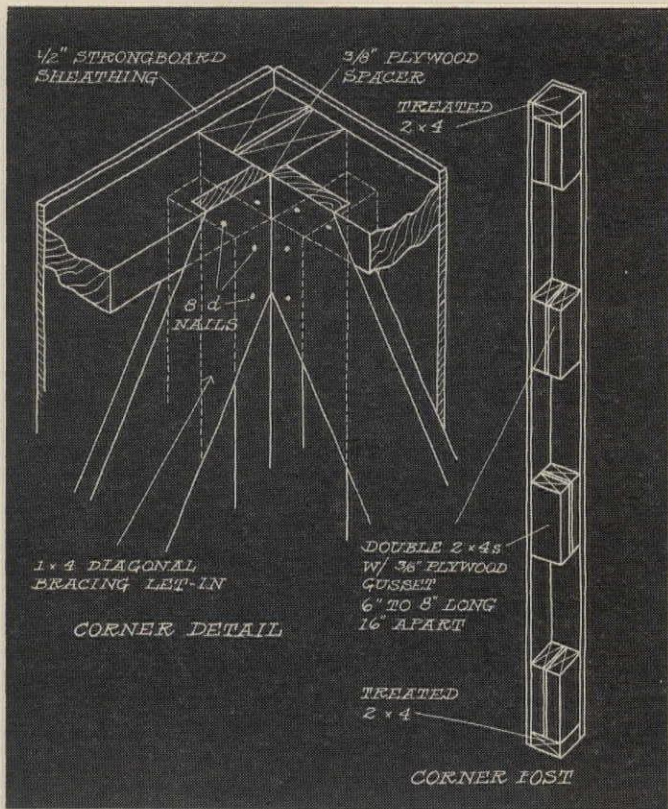

**CORNER POST**, made of short pieces of 2x4 and plywood, was designed to reduce weight, eliminate the twisting moment of a solid post. Since sheathing is not plywood, FHA requires corner bracing.

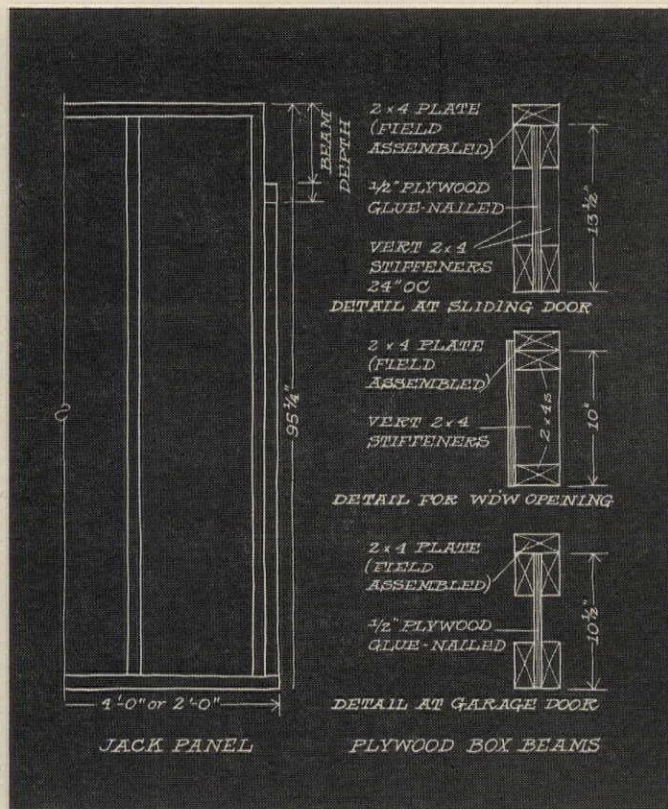

**JACK PANEL** used to support beams (shown in cross-section) has an extra stud which varies in height according to beams. Beams are different depth for garage, window, and sliding glass door openings.

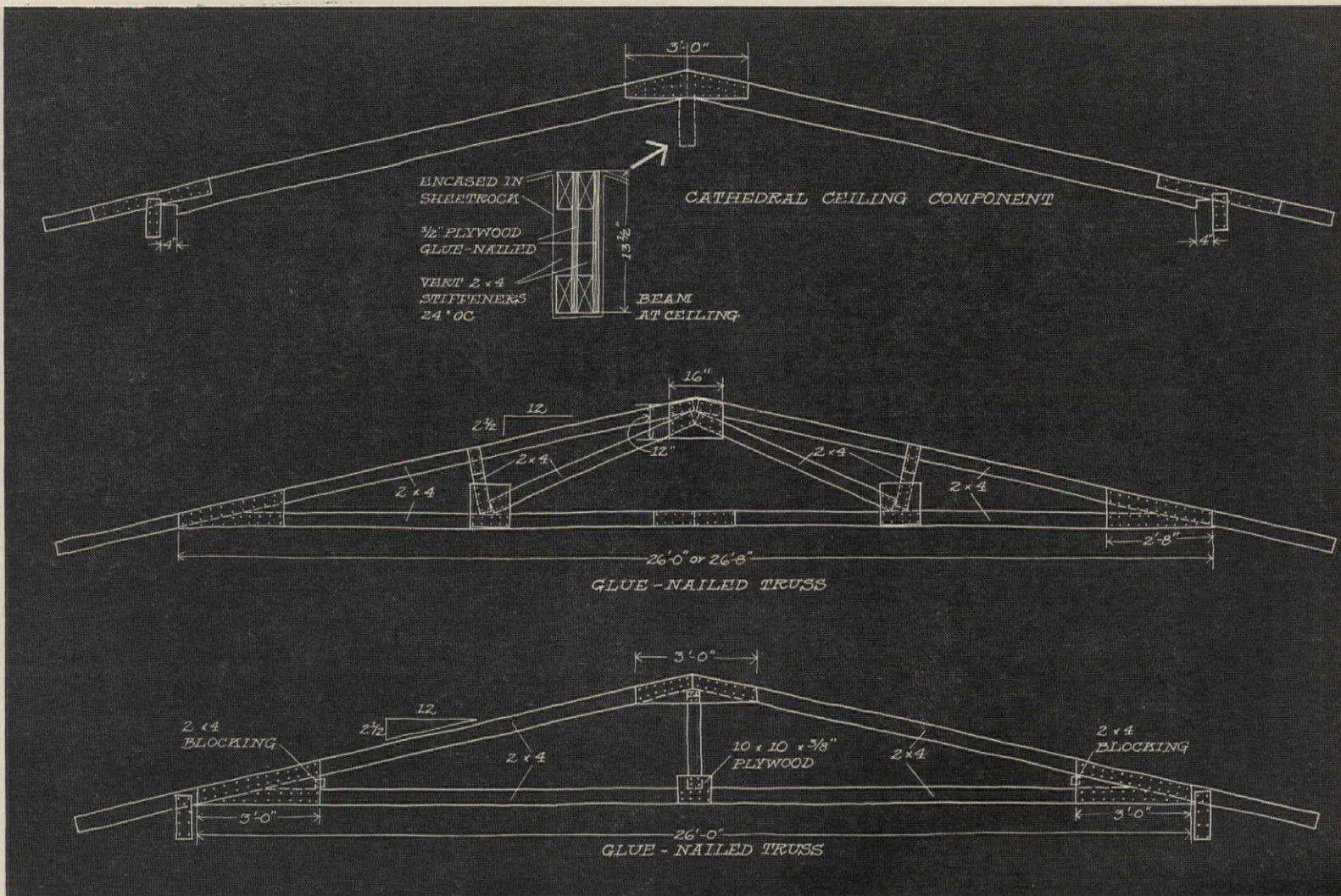

**CATHEDRAL CEILING COMPONENT** (top) can be combined with low-pitched truss (center), or king post truss (bottom) on the same house to provide interior architectural variety. The 2x4 lookouts on the 2x8

rafter blend with the 2x4 overhang on the trusses to give a single roof line and a single eave line. Heel blocks on the units act as guides to plumb walls: once one wall is plumb, other wall automatically plumbs.

To see how a fast schedule helped Dyches grow, turn the page

Here is Dyches' 15-day building schedule					
<b>DAY 1</b>	A four-man carpenter crew erects wall panels and trusses on a finished slab. Concrete drive and walk is put in before building starts to facilitate delivery of materials.	<b>DAY 2</b>	Two carpenters and two helpers move inside the house to build interior partitions from pre-cut studs. They use prehung doors. The plumber sets his tub and puts his vent stack through the roof.	<b>DAY 3</b>	Heating subcontractor installs the furnace and ducts while the electrician is wiring. The roofer puts down the shingles. The electrical inspector arrives promptly in late afternoon.
<b>DAY 4</b>	Two carpenters finish their outside work (overhead garage doors and the like) while the drywall crew takes over the whole interior. Outside, the brickmasons start to veneer.	<b>DAY 5</b>	Brickmasons continue outside, drywall crew tapes joints inside. Tiling sub puts ceramic tile in bath.	<b>DAY 6</b>	Masons continue outside, drywall crew continues inside. Ornamental iron is set outside.
<b>DAY 7</b>	Drywall men continue.	<b>DAY 8</b>	Drywall men finish up. Taping job is done over a 4-day period, so men have time to do job carefully.	<b>DAY 9</b>	Two skilled carpenters check to see if house is ready for painters. They install prefinished kitchen cabinets. Cabinets are put in before painting because it is easier to protect the cabinets than the paint job.
<b>DAY 10</b>	Painters begin work inside. Dyches does not subcontract this job. Painting time is cut since Dyches uses a lot of prefinished paneling and acoustical ceilings.	<b>DAY 11</b>	Painters continue to work inside.	<b>DAY 12</b>	Painters complete work inside.
<b>DAY 13</b>	Flooring subcontractor takes over inside, lays a variety of tiles: wood, vinyl, cement asbestos. Painters move outside to finish-coat pre-primed soffits, cornice.	<b>DAY 14</b>	Two finish carpenters install base mold heat registers, miscellaneous items. Electrician hangs fixtures and plumber completes his work.	<b>DAY 15</b>	Yard is graded and shrubs planted. Windows are washed, bath fixtures, sink, and floor cleaned. Debris is burned and house is made ready for occupancy.

## Building on a fast schedule helped Dyches grow

"A good, tight building schedule is the key to making the most of your time and your workmen's time," says Dyches.

"Any builder who doesn't realize this is in the same shape I was in when I built conventionally—so engrossed with the day-to-day problems of ordering materials, supervising the labor force, scheduling subcontractors, and trouble shooting that he can't look or plan ahead further than the next house.

"Once I started using components I was able to up my house production from one a month to one a week, with just about the same work force. As soon as the men got used to building with components, I increased my production to two houses a week and put each house on a 15-day building schedule [see above]. This boost in production of course meant increasing my work force, but it multiplied my profits.

### Here is how Dyches schedules his starts

"Under my present schedule, I start a new house every Monday and Thursday. Since they're finished in 15 working days, I never have more than six houses 'on the production line' at any one time. My schedule is so firm that every subcontractor can report for work on a house without being given a specific order. The only time I have to give orders is when bad weather stops me—and since my houses are closed in in one day [see opposite] this seldom happens.

"My subcontractors know I mean business. Once an electrician failed to complete his wiring before the carpenters were scheduled to nail on the drywall. I told them to go ahead. When the electrician complained, I told him that they were on schedule and he was off schedule. He fished his wire through the wall—he knew he had to keep my contract.

"Once you set a schedule, you have to stick to it. There are lots of good reasons for building on a tight schedule:

"1) You save on construction money: the shorter term you borrow, the less interest you pay.

"2) You tie up your own capital for a shorter period.

"3) Your overhead is lower. When you can produce 85 houses a year with 14 workmen on your payroll and only have to keep track of six houses at a time, you cut down on bookkeeping and supervision.

"4) Your labor is more productive. When you put things on a schedule, you are setting goals for your men to meet. When my men come to work each morning they know what they are supposed to do that day—and because the schedule also gets the materials they need to the right place at the right time, they get the job done without working any harder than they did when they built conventionally."

# Here is how Dyches closes in a house between 8 am and 4:30 pm

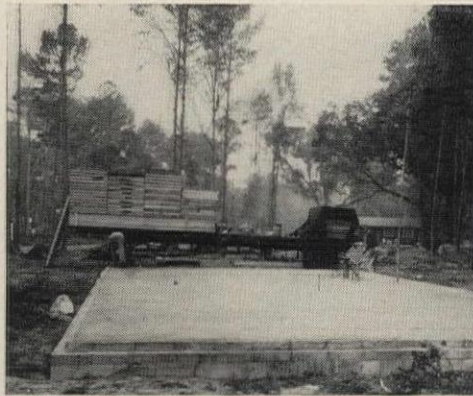

**TRAILERLOAD** of building components awaits unloading by rough-framing crew (three carpenters, a helper) and two laborers.

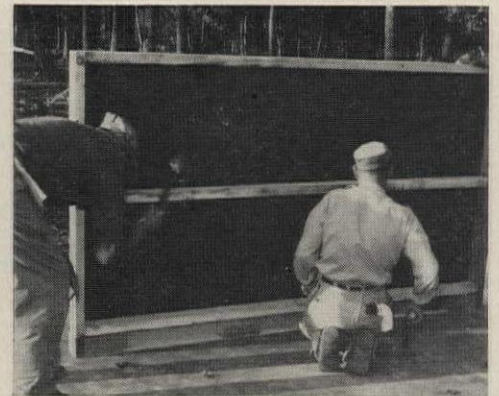

**SOLID CORNER PANEL** is nailed to corner post lying flat. Adjoining corner panel is nailed to the post in upright position.

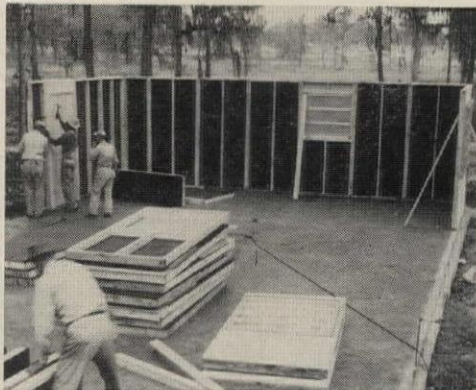

**WALL PANELS** are joined quickly together because five 16d nails were pre-driven into terminal studs of each panel at the plant.



**TRUSSES** go up as soon as all wall panels have been erected, generally before noon. Here, 4-in-12 king-post trusses are used.



**SLOPING CEILING** components (used over the living room) are set atop plywood box ridge beam resting on posts between trusses.

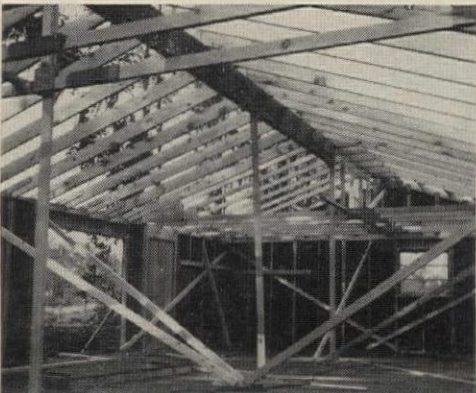

**MOST ROOF COMPONENTS** are in place by mid-afternoon. Trusses are brought into the house through sliding glass door openings.

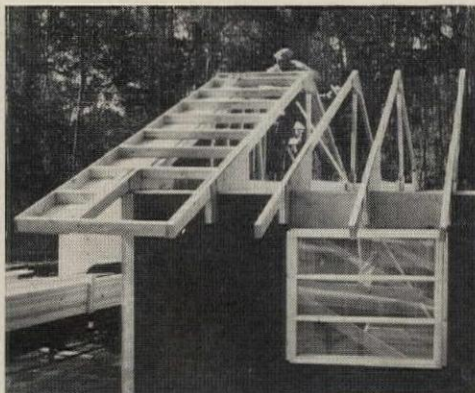

**LADDER PANEL** for the overhang on the gable end is the last roof component to be nailed into place before roof is sheathed.



**PRE-BUILT FRIEZE** board blocking is nailed to the underside of the gable end before the house is brick veneered.



**SOFFIT**, fitted into groove of fascia, also bears against a metal angle nailed to the heel block on trusses, to prevent buckling.



**ALL CLOSED IN** by 4:30 pm, the house is ready for the plumber and carpenters to work inside the next day. Dyches modeled his building schedule

after Clayton Powell's (H&H, Feb '58); thinks every builder could speed his building by studying other builders' schedules. /END



**SLIDING GLASS WALLS** are all that divide dining-living area from outdoors; the quarry tile floor continues out at both ends of room.

## Is this the ultimate in indoor-outdoor integration?

ARCHITECTS: *Buff, Straub, and Hensman*

LOCATION: *Altadena, Calif.*

*(This is Arts and Architecture's Case Study House No. 20.*

*For construction details see H&H, Oct '58, p 136.)*





Photos: Julius Shulman

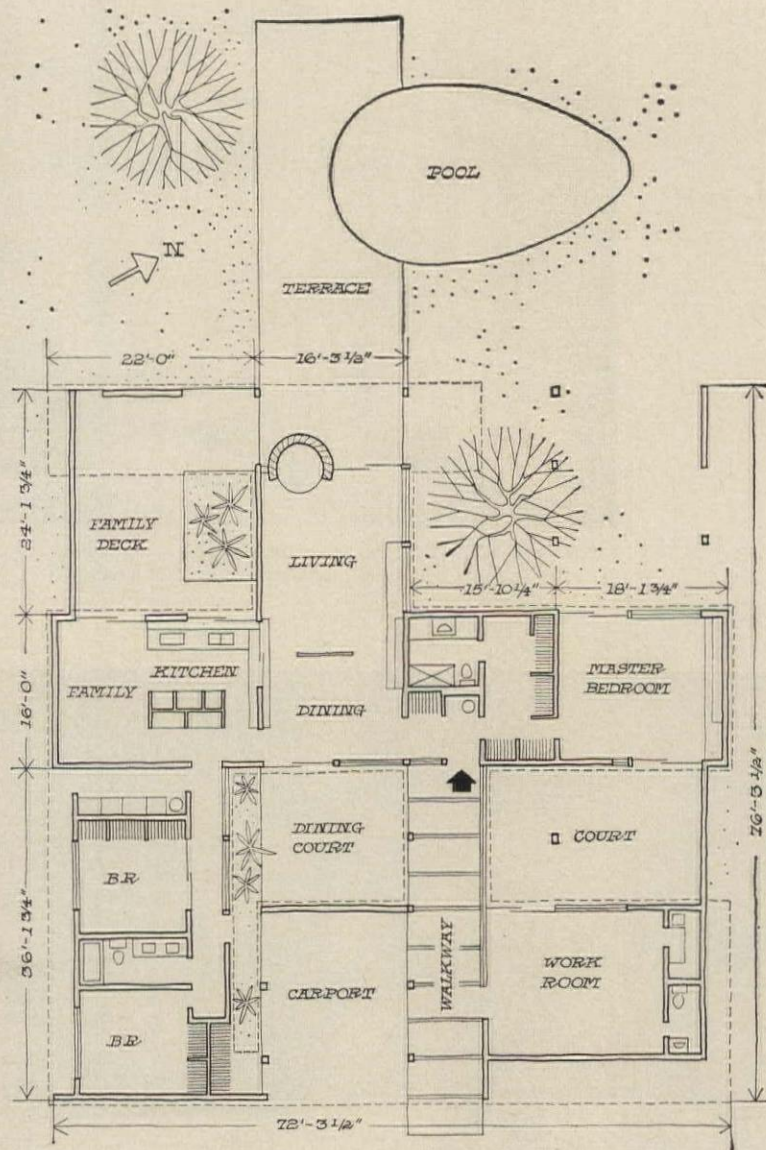

**PLAN** shows how courts, decks, and terraces were used to develop spaces that are semi-indoors, semi-outdoors in location as well as feeling. (Only baths are fully enclosed.)

**POOL** at rear of house intersects terrace that helps extend living room space. Roof beams continue out to make a court around giant tree. Behind tree is master bedroom.

The indoors and outdoors are so closely integrated in this house that it is, at times, almost impossible to see where one ends and the other begins. The architects themselves think that if they had gone further, they might have destroyed the sense of shelter that a house should give.

Here, open courts, roofed walks, and glass-walled rooms all serve to make the transition from complete enclosure to completely open site so gradual that it is hardly noticeable.

*continued*

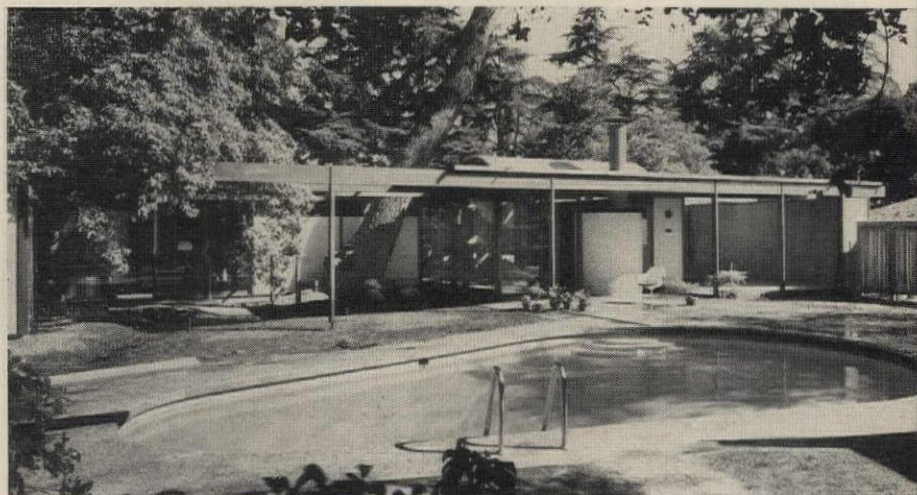



**ENTRANCE WALK**, roofed and graveled, leads past dining court, left, to inner entrance, right. (Outer entrance is shown below.)

Photos: Julius Shulman

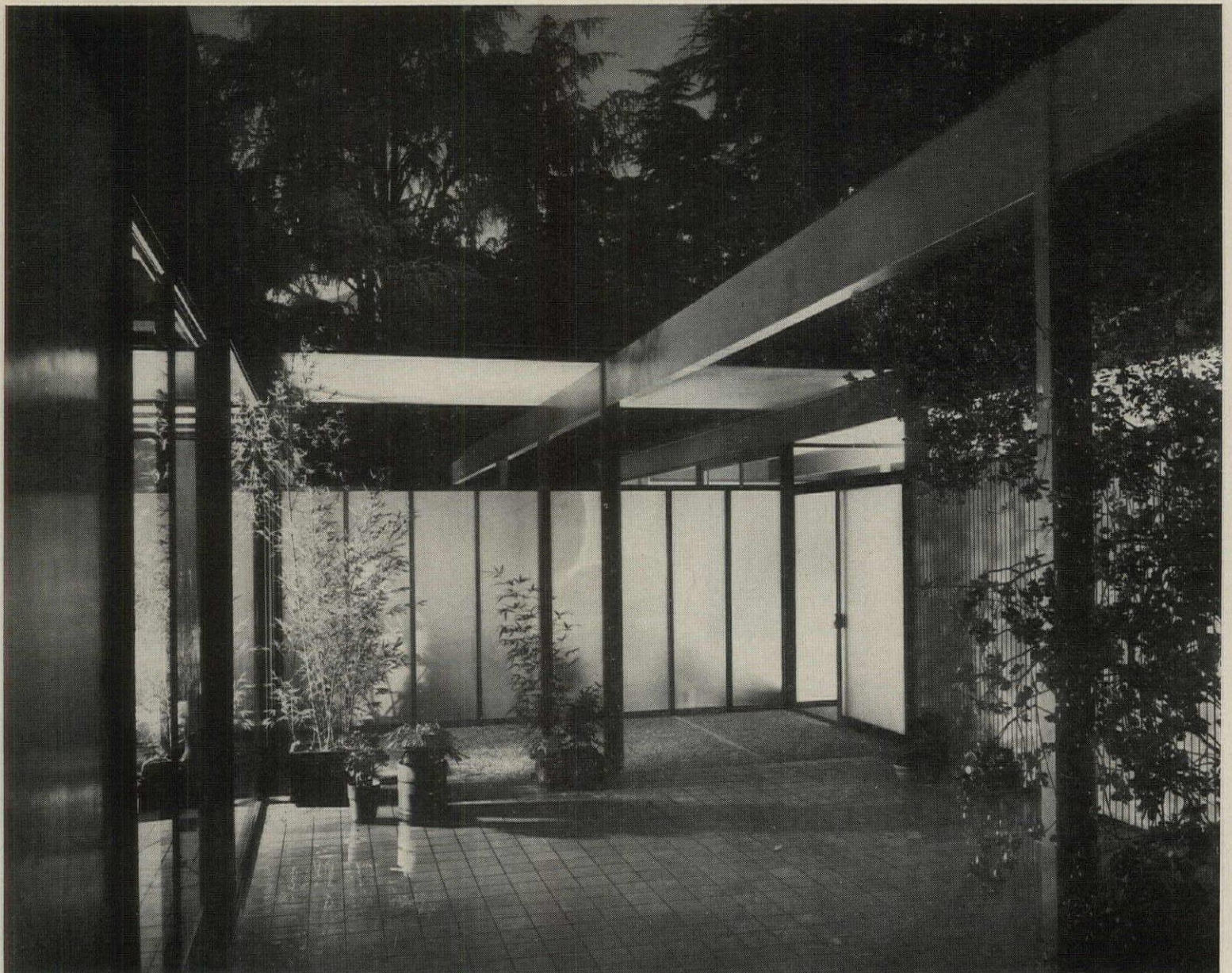

**DINING COURT** is walled on all sides. Carport and outer entrance doors are at right, dining area at left. Translucent glass screen hides master bedroom's own court. Enclosing walls, quarry-tile floor, and overhead beams make dining court almost a complete room.



**VAULTED DINING AREA** is off main entry. Graveled entrance walk continues right into the house. Roof vaults with glass-filled ends open

the area above the solid planes of the side walls, but close it above the open planes of the end walls. Partitions are drywall.

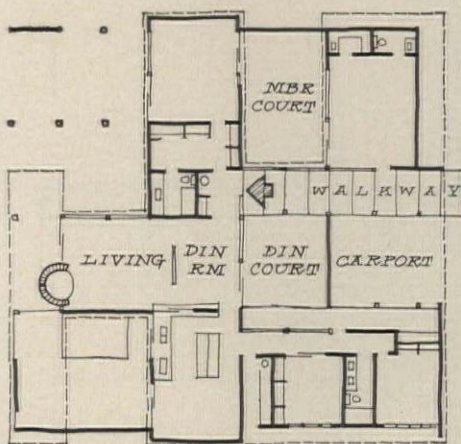

**VIEW FROM ROOF** clearly explains relationship of vaulted dining area to open dining court. Roof plane across court is over entrance walk.

*continued*

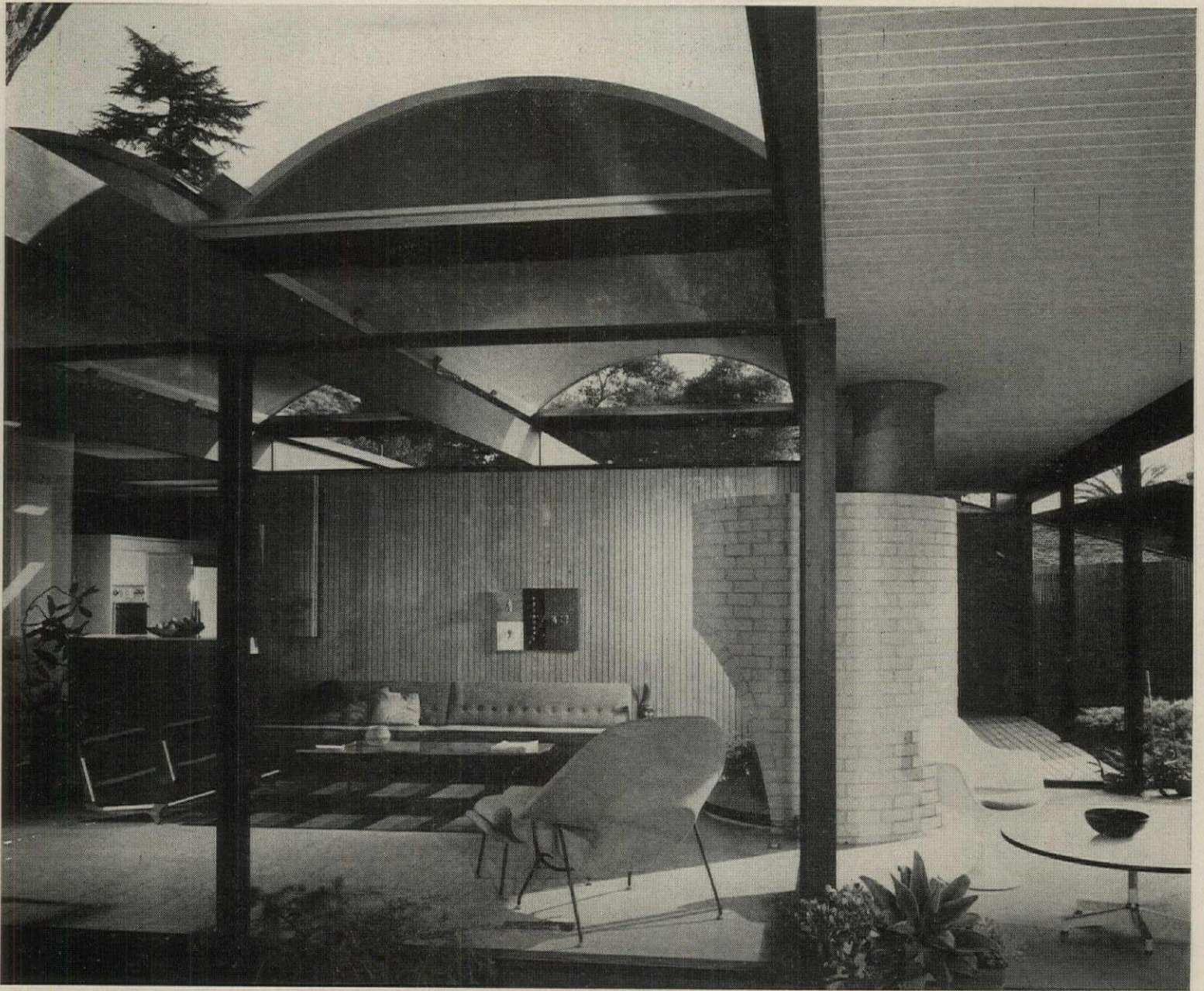

**LIVING AREA**, at opposite end of room from dining area (out of photo, left) shares vaulted ceiling, but here sliding glass opens both side and end walls. Behind solid wall in background is family room's deck. Kitchen is on far side of pass-through at left.

Photos: Julius Shulman



**LONG VIEW** from back of house is across living area (foreground), dining area, and dining court. Far wall hides carport.

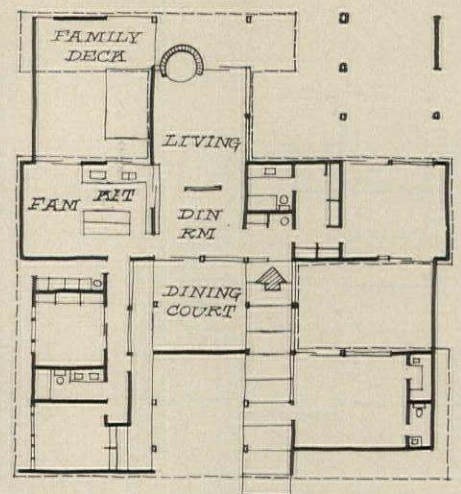



**KITCHEN'S END WALL** is partly open, provides view of giant tree on far side of living area. Part of kitchen is vaulted like living area.

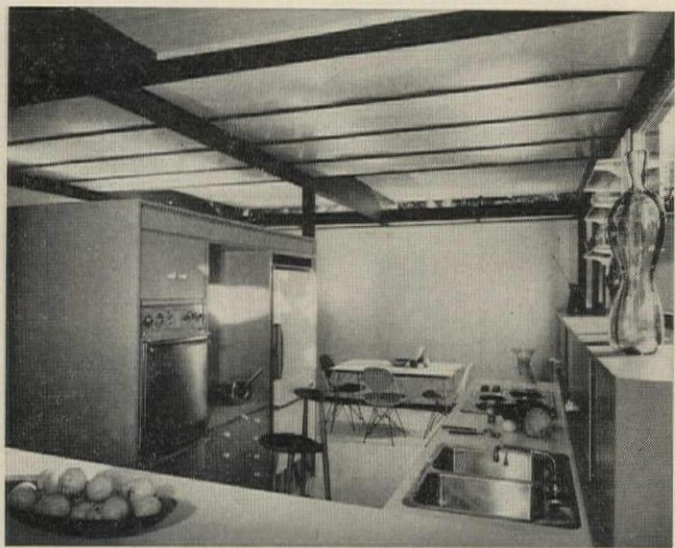

**LUMINOUS CEILING** is over kitchen's work center. Kitchen forms organized work space off family room, in background.

**FAMILY ROOM** is opened by sliding glass wall to its own large, semi-enclosed deck. Wall separating deck from living room can be seen past

kitchen window. Fence enclosing rear lot is in left background. Family room's ceiling is v-grooved plywood. /END

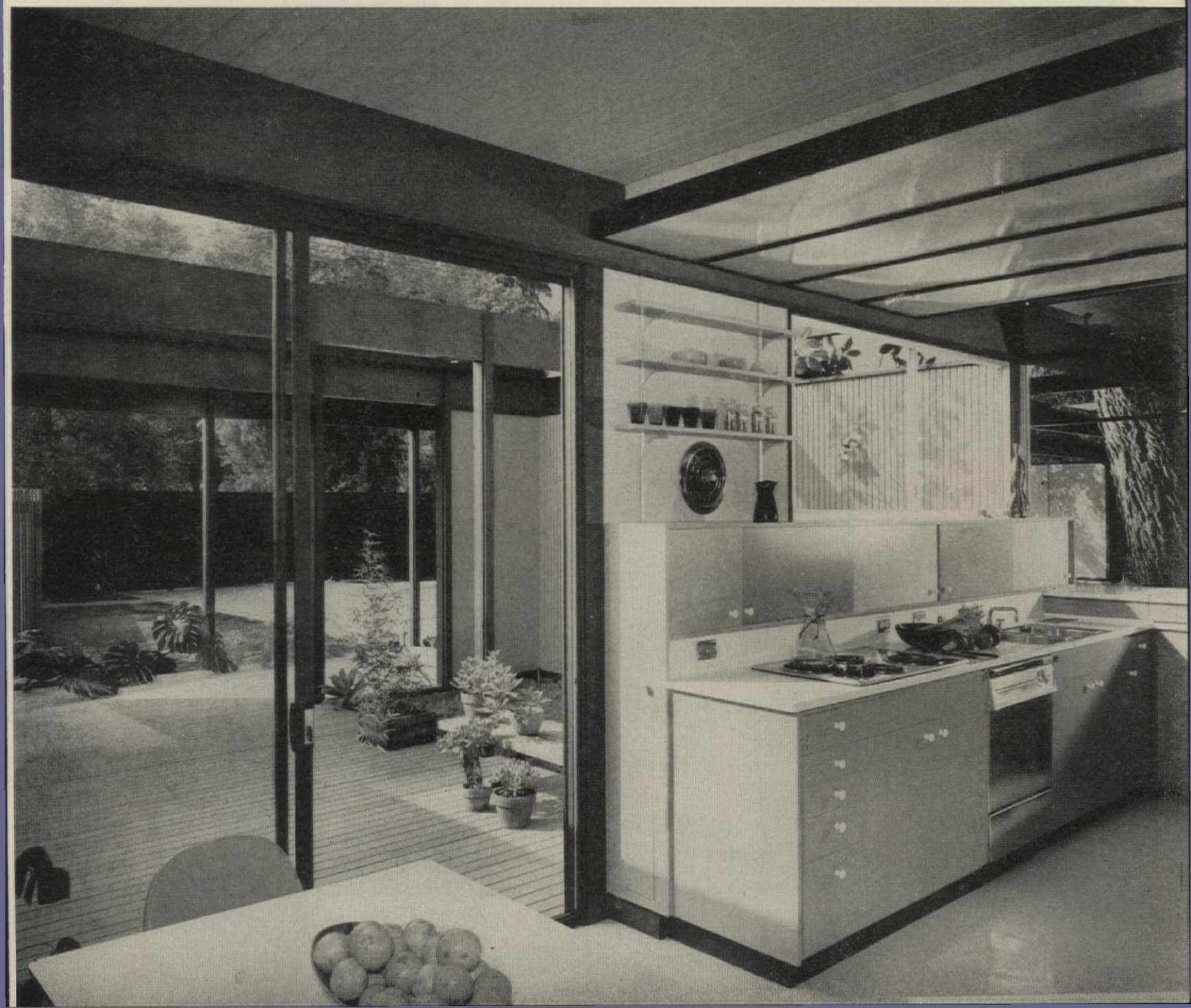



J. Paul Langford

*What makes people buy houses?  
Does high-pressure selling get results?  
How can you help buyers make up their minds?*

*You'll find the answers in this report  
from the nation's biggest new-house realtor:*

# How to sell houses

Realty Salesman Charles McKinnon, demonstrating the kitchen at left, is making a direct point to a pair of homebuyers.

He is also making an indirect point to the entire housing industry. It is this:

*There is no substitute for old-fashioned person-to-person selling by trained, competent, hard-working salesmen.*

That is the great lesson of Walker & Lee, Lakewood, Calif., the nation's biggest new-house realtor (\$50 million in '58 retail sales) and employer of McKinnon and 133 other trained, competent, hard-working salesmen.

## **Walker & Lee sells new houses in 42 subdivisions**

It also has a resale department for older homes (for one of its new best-sellers, see *p 183*). It does the selling job, but it does not perform such auxiliary merchandising jobs as preparing advertising copy, furnishing model houses, and landscaping them. Its commissions range from 1% to 5%—hinge on factors like these: How competitively priced are the houses? How good is the location? Is the builder a good merchandiser? Does he use an ad agency? What are the opportunities for volume sales?

While W&L does not do every merchandising job, it does offer advice on all phases of marketing (see *p 151*)—on land buying, for instance, and on product design, construction financing, picking an ad agency or a professional decorator. But for all its advice, it never loses sight of the need for person-to-person selling.

"Newspaper ads don't sell houses," says General Sales Manager Frank Hart. "A house is sold at the site—by someone to someone. Selling homes is more personal than any other retail selling."

W&L's person-to-person selling is based on four simple rules: 1) always demonstrate; 2) always stress benefits; 3) always ask "qualifying" questions to find out whether a prospect can afford the house and whether he is really interested; 4) always follow up after the prospect's visit.

*To see W&L Salesman McKinnon sell a house, turn the page.*

*W&L Salesman Charles McKinnon demonstrates kitchen countertop in one of Builder George Heltzer's houses in Anaheim, Calif.*

## How a salesman demonstrates to sell a house



**1** This couple is about to meet a competent, hard-working salesman

In this four-page photo sequence, you'll see Salesman Charles McKinnon selling Mr and Mrs Warren Crow (above) a home. Of course, McKinnon doesn't fol-

low all these steps on every sale. But the photos show how he works—how he keeps demonstrating, keeps talking benefits, keeps asking qualifying questions (in italics).



**4** Point out the pleasure of outdoor living

"This yard is big enough for a patio and barbecue pit," says McKinnon, "but not too big to keep up." He asks more questions: *"Do you work near here? Of course, you know FHA requires a \$600-a-month income to qualify for a loan on these homes?"*



**5** Have them step outside—but only briefly

Take a quick tour outdoors if you're fairly sure the prospects are interested. McKinnon talks up exterior materials and construction: "Notice the cedar shake roof . . . the wide overhang." He asks: *"When would you need occupancy of your new home?"*



**8** Let her see what kitchen extras do for her

But don't lead her into the kitchen until you've played up the elegant aspects of the house. Like most women, she probably sees herself first as a hostess, then as a cook. Says McKinnon: "How many of your friends can serve guests a whole broiled turkey?"



**9** Let him see how kitchen gadgets work

Like most men, he probably likes gadgets. So McKinnon invites him to open the dishwasher: "Mr Crow, just see how that tray pulls all the way out for easy loading. According to research reports, this is the finest dishwasher on the market."





**2 Take them in the front door**

Let them see the house for the first time as their friends might see it. McKinnon introduces himself, asks: "Do you live in this area now? Owning or renting?"



**3 Pause at a vantage point so they can take in the living room's size**

But don't stress dimensions and square feet. Instead, try to paint a picture of comfort and elegance. McKinnon says: "This fine big room is planned for real family living.

And can't you see yourselves entertaining your friends here?" He asks: "How many children do you have? How large a house do you have in mind?"



**6 Take time to stress quality**

But avoid technical explanations unless you're asked. Says McKinnon: "Our builder uses the finest materials. For instance, you can be sure of this safety lock."



**7 Tell them how they'll benefit from luxury features**

And let them demonstrate for themselves. Says McKinnon: "This intercom will give you real pleasure and convenience, Mrs. Crow. You'll have music throughout your

home. And from the kitchen, you'll be able to answer the front door and hear your children in their bedrooms. You'll enjoy that, won't you?"



**10 Let them both see themselves living here**

Sharing the closet, for instance, "Closets don't come any bigger than this," says McKinnon, stepping in to make his point. Or washing up side by side at the dual sink: "In this luxury bathroom, you won't have to wait for him to finish shaving, Mrs. Crow."



*continued*

## How a salesman works toward closing a sale



### **11 Show them where they are in relation to community facilities**

Use an aerial photo as McKinnon is doing in the sales office. He points out schools, churches, and shopping areas. "This is an established community with all improve-

ments in and paid for," he says. "So you don't have to worry about big jumps in taxes. *Won't it be wonderful to live in such a well-planned community?*"

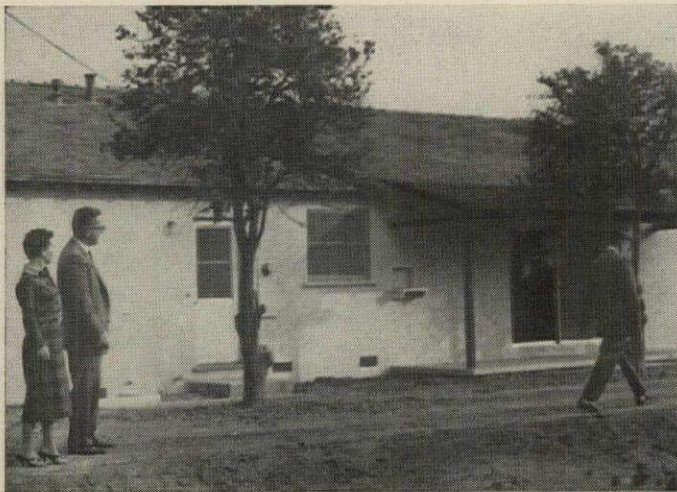

### **14 Don't just talk lot size—pace it off**

Always try to do something to dramatize what you're saying—even when you're telling people the size of a lot. "Your lot has 7,200 sq ft," says McKinnon. "It starts right here"—he walks away from the prospects. "And it goes all the way over to here."



### **15 Don't try to high-pressure them**

Few prospects buy on the first visit (most w&l buyers come back three to seven times). Says McKinnon: "It's been a pleasure talking to you, Mr and Mrs Crow. I know this is a big decision. If you have any questions before you return, please call me."



### **18 Help them to make up their minds on the big question by asking them little questions**

Get them to decide on color combinations, on materials, on kitchen appliances, and on extra features available with the house. Once they make these small decisions, the big decision on whether to buy will be a lot easier for them. McKinnon leads Mr and Mrs

Crow up to a group of color charts, says: "Here's the wide choice of colors and materials you can have in your new home, Mrs Crow. As you see, they have been carefully coordinated by an expert. *What combination would you prefer?*"

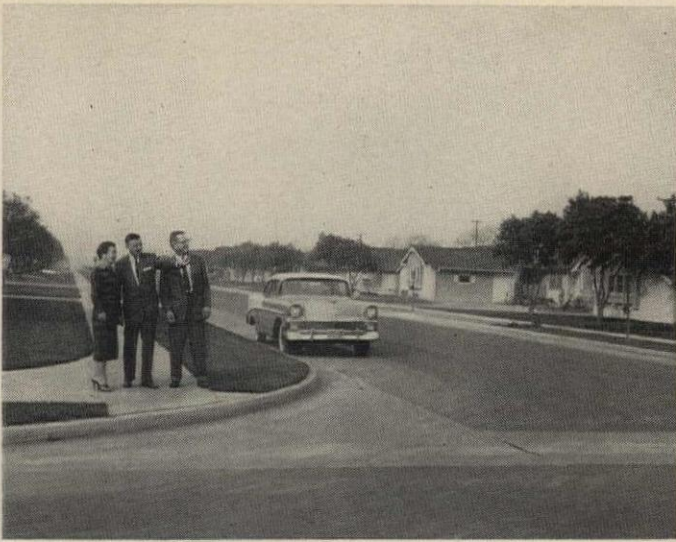

**12 Take them on a quick neighborhood tour**

"These families have just moved into their new homes," says McKinnon. "Notice their neat gardens. See how they've expressed their personalities with individual landscaping. *"You'll like having neighbors who take such pride in their homes, won't you?"*



**13 Step away and let them do the talking**

"From what you've told me, folks, this home has the features you're looking for," says McKinnon. Then he stands back and looks and listens as they size up the house. Inside, he'll stay in the background—simply answer questions and watch reactions.



**16 Follow up to keep them coming back**

On phone, McKinnon says: "Mr Crow, when are you and Mrs Crow coming to see your home?" He keeps file cards on prospects —includes personal characteristics like: "she fears for children's safety;" "he hates mowing lawn;" "she can't stand green."



**17 Overcome their possible objections**

Pointing to the subdivision map, McKinnon says: "On this lot we can give you a home just like the one you saw the other day. And you won't have to worry about your children's safety. This lot is at the end of the street, so there's no through traffic."



**19 They're ready to buy—so stop talking and start writing**

"Our company will arrange your financing for you, Mr Crow," says McKinnon. "Your income qualifies you for a fine loan, so we'll open up an escrow for your protection, secure your loan, and prepare your new home for you to move in"—he hands

Crow a pen. But McKinnon's responsibility doesn't end here. While the house is being finished and the financing arranged, the Crows could change their minds. So McKinnon will keep in touch with them—keep them posted on all developments.

*continued*

## How to attract the right kind of salesmen

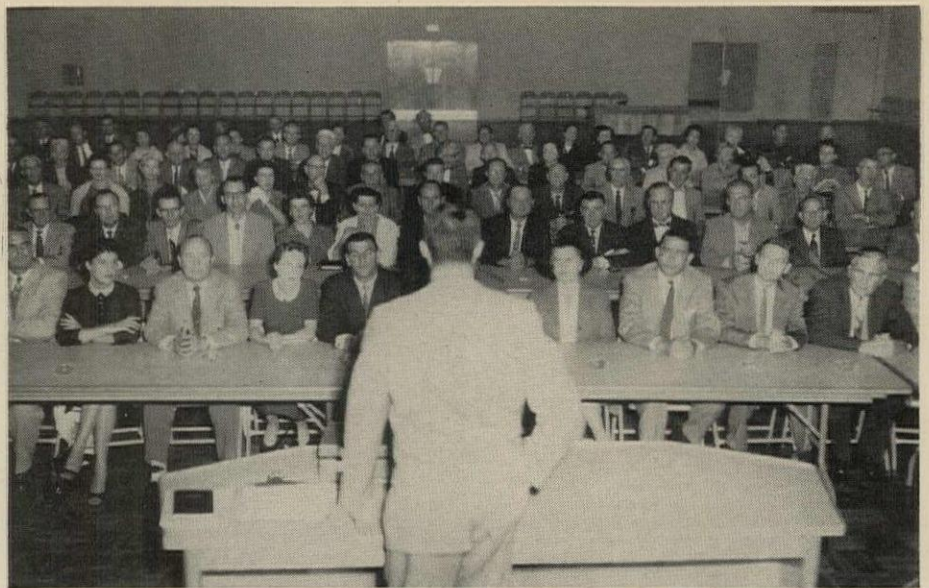

AT WEEKLY SALES MEETING w&L salesmen hear talk by Sales Manager Frank Hart.

What is the right kind of salesman? Study the faces at a w&L sales meeting (above), and you'll see that he or she (there are 25 women on the sales staff) is not any one type.

"Our requirements are really quite simple," says w&L President Robert Walker.

"We like people who are honest, reasonably intelligent, willing to learn, and not afraid of hard work" (w&L salesmen work 55 hours a week, longer in rush periods).

"We like people who've never sold a stick of real estate. Why? Because too many of the old hands in this business are apt to want to do it their way—not ours. More often than not, the so-called old pro is actually just an old hack.

"If an applicant has had selling experience in other lines,

so much the better. But some of our best salesmen never sold before—they are ex-bartenders, ex-school teachers, ex-taxi drivers, or housewives with time on their hands because their children have grown up."

What attracts people to w&L (there is always a waiting list of 35 to 40 applicants)? They know they will be well trained; they know they will be well managed; and—most of all—they know they will be well paid.

Salesmen's commissions range from \$100 to \$500 a house. Their annual earnings are from \$5,000 to \$25,000, their annual sales from 30 to 200 houses.

"If you want a man to be more than just an order taker," says Walker, "You've got to give him a real incentive."

## How to create a selling environment

w&L, which claims credit for introducing such merchandising ideas as closing booths and glassed-in garage sales offices, says you'll create a selling environment if you:

1. *Draw prospects with advertising.* Billboards and directional signs are great crowd pullers ("60% to 70% of our prospects"). And don't overlook classified ads ("fine for cleaning up the last couple of houses in a tract").

2. *Open your subdivision with a smash.* Ideas: serve refreshments; get sales aids from utilities and manufacturers.

3. *Set up a sales office in a model-house garage.* Replace the doors with a glass window wall and sliding doors (see photos 1, p 148, and 15, p 150). Heat it. Finish it ("paneling is good"). Be sure it's well lighted. Don't make it more lavish than the homes you're selling.

4. *Put displays in your office.* Items: plans and renderings, color schemes ("but not too many options"); samples of materials and products; a tract map; an aerial photo (see photo 12, p 151); a sales album with photos, prices, and terms for each model; brochures; simple sales agreement forms.

5. *Have professionals furnish and landscape your models.* Use fast-growing plants to get a lived-in, established look.

6. *Pick a strategic spot for your models* (see drawing).

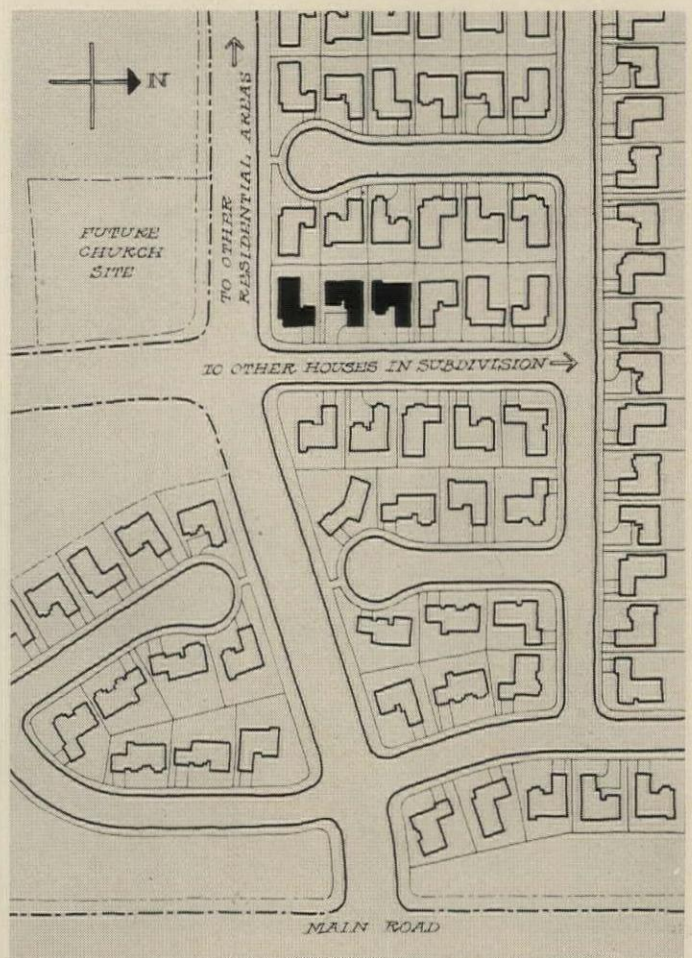

**STRATEGICALLY LOCATED MODELS** are in subdivision sold by Walker & Lee. They are a) easy to reach from main road; b) on street to other houses in subdivision; c) near street to other residential areas (plenty of traffic will pass them); d) near parking area (future church site); e) faced to east (western sun won't burn lawns).

## How to train and manage good salesmen



**PICKING UP POINTERS.** trainee (right) listens in while salesman walks with prospect.

Here's the advice of Frank Hart, w&L general sales manager:

1. *Teach your trainees by example.* w&L often assigns a new man to an experienced salesman, lets him pick up pointers (see photo) by looking and listening.

2. *Use a sales manual.* w&L's 60-page manual—must reading for new men—is packed with facts and advice (sample: "The salesman who isn't afraid to use a broom or water the lawn is also in the mood to make a sale").

3. *Supervise your salesmen.* w&L's supervisors are district sales managers—each responsible for a geographical area where he becomes a specialist in market characteristics. Managers keep close tabs on their salesmen—require reports and pass along tips on selling methods and market conditions.

4. *Hold frequent sales meetings.* w&L salesmen meet weekly—get a chance to swap ideas and hear company and guest speakers on a wide range of subjects (examples: FHA-VA financing, escrow, title ethics, trade-in plans, new products, qualifying the buyer, overcoming objections, closing the sale).

5. *Check your salesmen from the prospect's point of view.* w&L, has "mystery shoppers" pose as prospects, rate salesmen on five counts: general greeting ("Did you feel welcome?"); appearance and neatness; knowledge ("Did you feel he knew what he was talking about?"); enthusiasm; closing ("Did he accept the first 'no' or keep trying?").

Do salesmen resent this rating system? No, says Hart, because those with top ratings win cash prizes.

## How a good realtor serves his builder

Here is a fast rundown on some of the services w&L offers the builder:

1. It helps him acquire raw land and developed lots.
2. It helps him get interim or take-out financing.
3. It helps him decide where and what type of houses to build ("big demand in this area for three bedroom houses in the \$18,000 bracket").
4. It keeps him posted on changes in the market and on what buyers want ("garbage disposers are a must . . . you'll do well with colored bathroom fixtures").
5. It helps him with his merchandising—works with his advertising agency, keeps records on sources of prospects and areas in which to advertise, arranges publicity campaigns, shows him how to plan and lay out his model houses and sales office (see facing page), suggests places to put signs and billboards.

6. It helps him sell second- and third-time buyers by arranging trade-ins through the w&L resale department, which handles sales of older houses.

"Do I take w&L's advice?" says Builder Ken Koll (right). "Of course. I ask them where to buy land, where to spot my model houses, what roof materials will sell. And why not? It's their business to know the answers."



**BUILDER KEN KOLL** (in sport shirt) checks advertising copy with Don McMullen, w&L public relations manager. Says Koll of w&L: "They sold 61 of my houses in 48 days. Why are they good? They're organized. They have good men, and new ideas. Sure, I pay more to sell through a realtor, but my increased volume offsets the cost."

H&amp;H staff

/END



**VACATION HOUSE** above has enviable location on Pacific Coast. Rugged materials fit it to rugged, windswept site. Architect: Walter Church.

# Today's vacation house:

*a new kind of house*

*for a big and growing market*

This year more vacation houses will be built than ever before. Estimated total: 75,000.

This is a sharp increase over previous years: analysis of the housing inventory shows that about 50,000 vacation houses were built each year from 1950 to 1956.

And the market will keep on growing.

It will keep on growing because, when you match rising incomes to longer vacations and more holiday week ends (see H&H, Jan), you get an inevitable change in the way people use leisure time. One of the biggest changes: more people are looking for a vacation house "to get away to."

It will keep on growing because more people are thinking of vacation

houses close to home—not just in special resort areas. More people are building vacation houses in hills or on lakes or beaches only a few miles, or a few hours' drive on the new highways, or a short flight from home.

And it will keep on growing because more people are thinking of vacation houses as a place to "finish off" later for year-round use after retirement.

## **Today's vacation houses must meet special requirements**

They must provide comfortable, casual living without costing a lot of money, and they must give the effect of space without using a lot of it. To do this:

Today's vacation houses should be economical to build. This means their construction needs to be as simple as possible, and the plan needs to be simple and compact.

Today's vacation houses should include the outdoors as part of the design because that is what helps make a vacation house so wonderful. They should

open to the outdoors, because that will make the indoors seem bigger. They should use the outdoors—with decks and terraces—because that will give more actual living space. But they should be protected from the outdoors, because vacation house sites are often vulnerable to heavy snows or floods or hurricanes.

And today's vacation houses can look different. People at play will accept a house that is a little more playful—so vacation houses can have unusual forms and exposed structure.

For a checklist of what makes a good vacation house and a look at six vacation houses that meet these special requirements, turn the page.

# What makes a good vacation house?

Here is a checklist of questions to ask yourself when you are planning to build for the vacation-house market:

## Will your vacation house be economical to build?

- Is the construction simple?
- Are interior finishes simple?
- Can it be built in a short time (two to four weeks)?
- Is the plumbing system as compact as possible?
- Is the structure designed so it can be left exposed and still look good?
- Can any of the newer materials and products be used to cut costs?

*(For example: pre-finished plywood combination siding-sheathing, reinforced plastics, prefabricated fireplaces.)*

## Will your vacation house be comfortable to live in?

- Are the finishes durable to stand up under casual living?
- Is the plan open so the house seems as spacious as possible?
- Are surfaces and textures simple so the house seems uncluttered?
- Is the house open to catch any breezes?
- Is the house screened to keep out insects?
- Is there a heat source for chilly nights or winter use?
- Can the house be closed up and locked—for the week or the season—with ease and speed?

*(Check prefabricated fireplaces, new in-wall heaters—electric, oil, or gas-fired.)*

## Will your vacation house make the best use of its site?

- Does the house open to the outdoors so it will seem bigger?
- Are there decks or terraces for outdoor living and dining?
- Is there some kind of outdoor night lighting?
- Is it oriented to the best view?

## Will your vacation house be shielded from the weather?

- Is there shade from the sun for summer houses?
- Is there sunny shelter from chilly winds for winter houses?
- Is the overhang big enough for protection against glare, rain, snow?
- Is the roof pitched to shed winter snows?
- Will the house be safe under hazardous conditions like hurricanes?
- Will the house be safe in floods or high tides if it's near water?

## Will your vacation house have plenty of well planned storage?

- Are storage shelves open, so mildew and bugs won't collect there?
- Are closets well ventilated, for the same reasons?
- Is there ample storage space for vacation equipment—games, outboard motor, skis, outdoor furniture, etc?
- Is there a big outdoor storage bin or cabinet?
- Is there safe, away-from-the-house storage space for flammables—kerosene, gasoline, paint, etc?
- Is there lock-up storage space for owner's personal gear so he can rent the house?
- Is there enough food storage space—in cabinets, freezer, and refrigerator—so shopping doesn't have to be frequent?

## Will your vacation house have reliable utilities?

- Is water available and potable?   
*(If well is needed, has it adequate flow for house needs?)*
- Is pump sized to house needs and well flow?
- Do you need a water storage tank?
- Is the sewage system at least 75' from the source of fresh water?   
*(Note: check new proprietary one-house systems—Sanitoi, Yoemans, Security, Hayes, Chicago Pump—as well as septic tanks.)*
- Could you add a heating and/or cooling system?
- Is the wiring adequate to take any future appliances or electrical equipment?   
*(If electricity is not available or reliable, check new LP gas-fired appliances.)*
- Are there provisions for fire fighting (extinguishers, outside fire connection to water supply)?
- Is there an incinerator or disposal to get rid of garbage?
- Can water, electricity, and gas be shut off easily when house is closed?

## Will your vacation house have these special selling points?

- Will it be easy to maintain?
- Could it be easily financed?   
*(Most vacation houses must be conventionally financed. FHA and VA will usually insure year-round houses only.)*
- Is it a little more fun to look at and live in?
- Could it, without many changes, be used year-round?
- Could it, without many changes, be used for a retirement house?
- Could it, without any changes, be rented out by the owner?





**BEACH HOUSE** sits on sturdy pile foundation. Roof shingles are glued and nailed to withstand high winds.

Photos: County Photo Service

## Standard techniques cut costs in this beach house

To hold down costs already hiked by the need to ferry men and materials over from the mainland, the builder of this island house used a standard 4' framing module, a simple post-and-beam construction system, rafters spaced 16" oc (and left exposed), 4'x8' plywood for subfloors, exterior walls, and prefinished interior walls—all standard (and economical) methods and materials.

Selling price of this house (one of 50 in a built-for-sale development) was \$12,000; including expensive 70'x70' lot, community assessments for central water supply, private beach, boat basin, tennis courts, play areas.

BUILDER: Maurice Barbash  
LOCATION: Dunewood, Fire Island, N.Y.

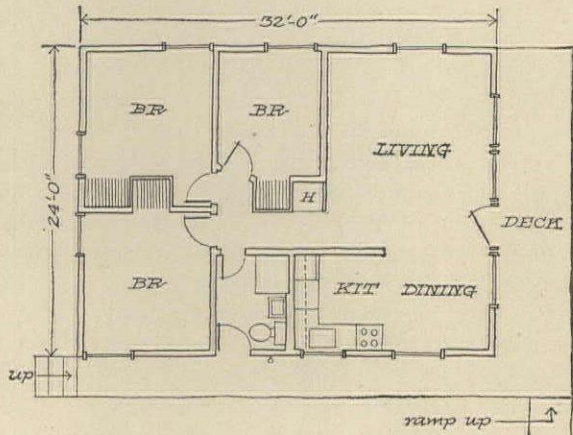

**PLAN** shows back-to-back plumbing. Outside door to bath lets swimmers wash off sand before entering living area.

**LIVING-DINING AREA** has floor-to-ceiling glass wall opening to the deck and the view.

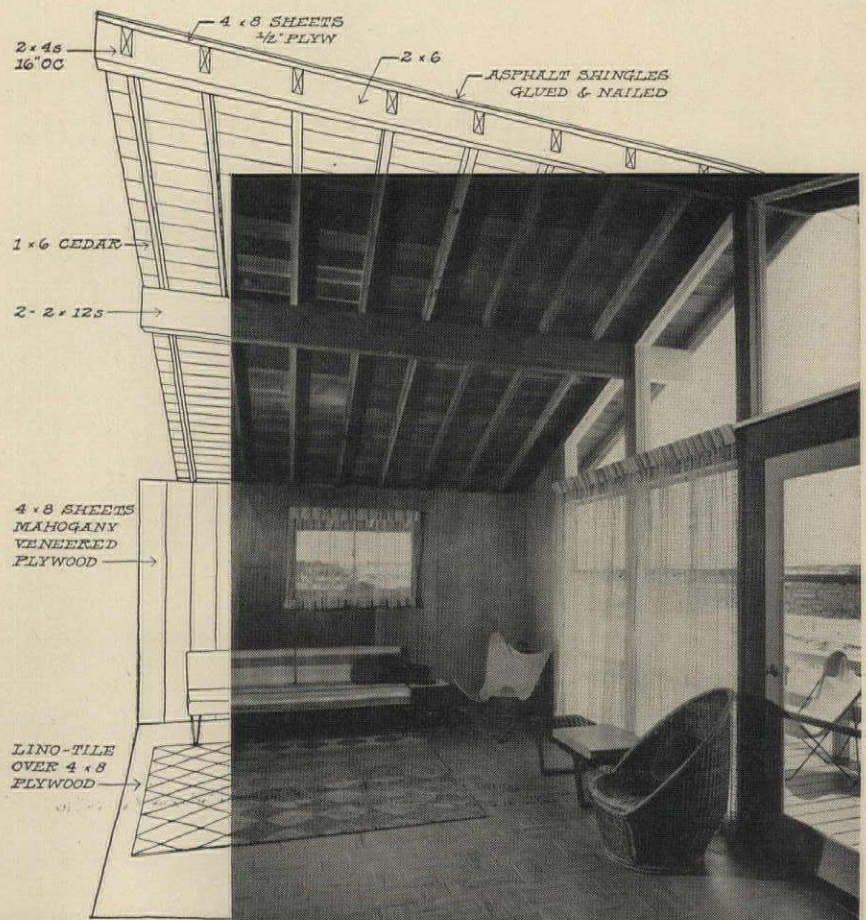



**HOUSE HAS THREE MAJOR UNITS:** the huge platform, the somewhat smaller roof above, and the very small area under the roof.

## The huge deck makes the outdoors a living room

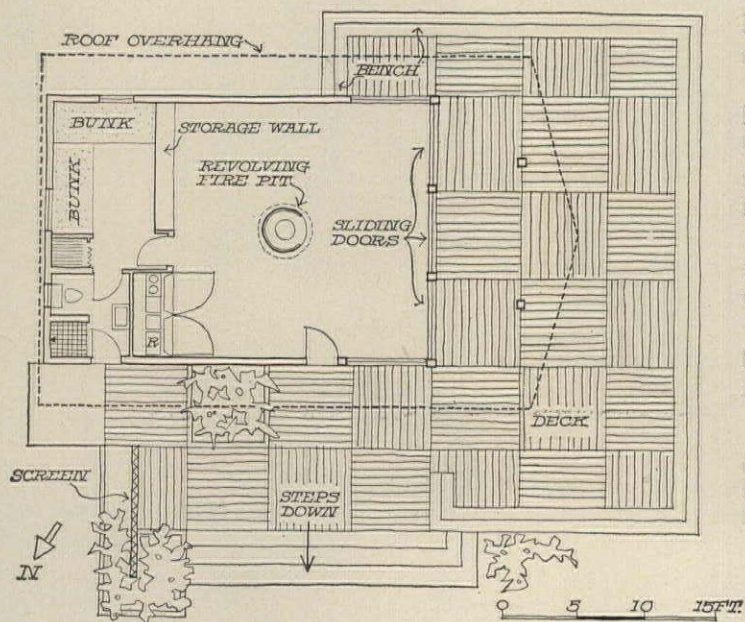

Because this small house borrows space from the outdoors, its living area is more than doubled.

One whole end of the 380 sq ft of indoor living space has sliding glass doors which open to the surrounding 996 sq ft of deck space. The deck wraps around the sides of the house, so the house seems to sit on a platform. Because of the large overhang (3' at the sides, 10' over the deck), the roof "floats" over the living space, gives the house great protection against the Northwest's heavy rains and occasional snows.

This doll-sized vacation house was designed primarily for weekend use. Contract price: \$5,000 including deck and architect's fees.

**COMPACT PLAN** shows how size of enclosed area compares to total floor space. Bath, backed up to kitchen unit for economical plumbing layout, is almost too tightly planned for comfort.

Photos: Charles R. Pearson



**FIR DECK** is partly sheltered by 10' wide overhang. Fireplace revolves to face any direction.

ARCHITECT: *Marshall W. Perrow*  
 LANDSCAPE ARCHITECT: *Lawrence Halprin*  
 LOCATION: *Horsehead Bay, Wash.*

## for this small house



**STORAGE SPACE** is everywhere: back of doors, above dropped ceiling.

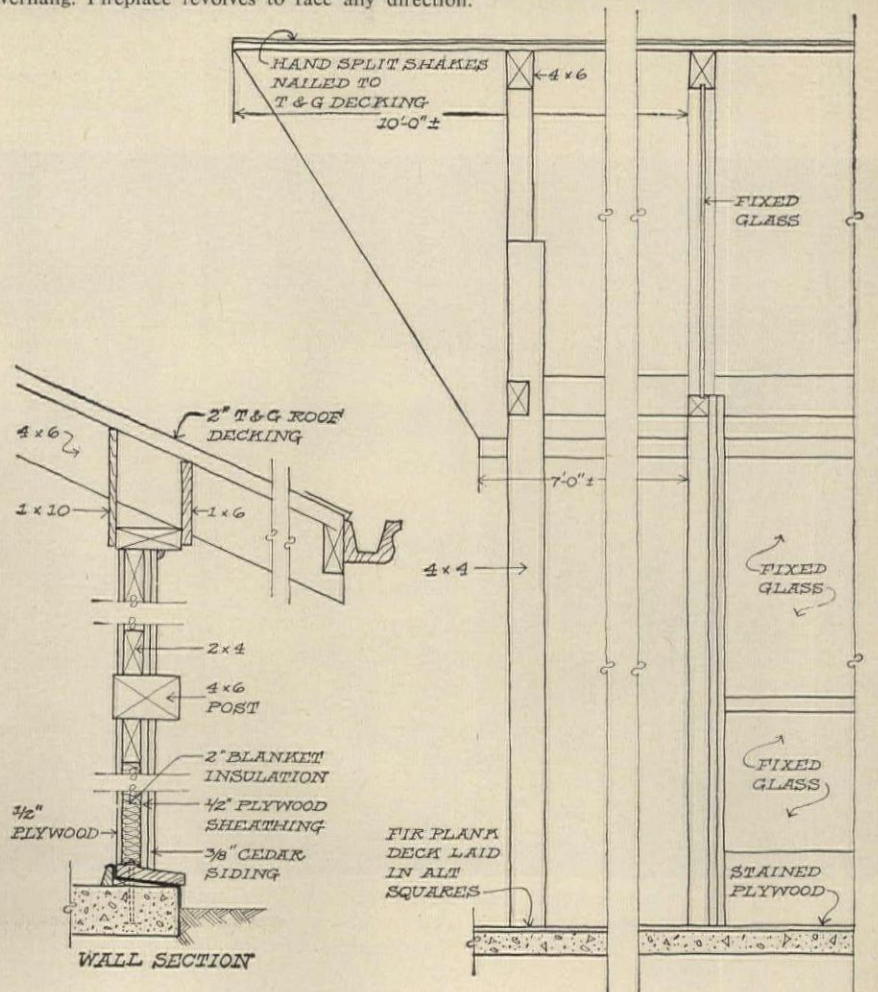

continued



**OPEN DOORS** stack at left, making center of house a breezeway. Sliding glass walls are set back 2½' so they are shaded from sun.

## Sliding walls open this house to good weather

ARCHITECTS: *Blake and Neski*  
 BUILDER: *Clarke Smith*  
 LOCATION: *Water Mill, N.Y.*

Photos: Marc Neuhof



**MAIN LIVING AREA** can be opened wide to breeze and view. Counter, foreground, separates kitchen area from living and dining. Ceiling is 1x6 t&g pine, floor is 1x4 t&g pine, walls are plywood.

When storms sweep in, the wood sliding walls can—in minutes—be pulled across the glass walls to shield them from sand blast or, in severe storms, from flying debris.

When the glare off the sea and beach gets too strong, the wood sliding doors can be pulled across to block it. But since the slats are spaced ½" apart, the doors will still let in the breeze. (The glass walls are set back 2½' from the wood walls, so an overhang is formed to shade the glass from the sun itself.)

And when it is time to close up the house—for the week or for the season—the wooden doors can be pulled across and locked. The house can be opened again in minutes, a point of special importance when vacation houses are used often on weekends.

Other points of special interest in this house:

1) The structural system. Floor and roof planes are hung from three piles on each side of the house, and the exterior walls serve only as an envelope for the interior. (See details, opposite.)

2) Interior finishes (pine on floor and ceiling, plywood on walls) keep maintenance to a minimum.

3) The Franklin stove is a source of quick heat.

4) Extra insulation in bathroom walls cuts noise transmission.

Contract price of the house was \$8,300.



**CLOSED DOORS** add interesting pattern to exterior. Flat roof of house goes well with horizontal planes of beach, sky, and water.

## and close it to storms

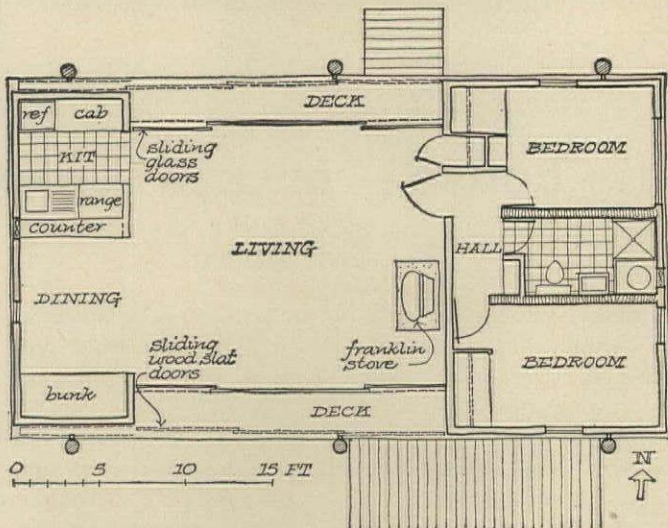

**TWO-PART PLAN** has closed-in bedrooms, open living-dining-kitchen.

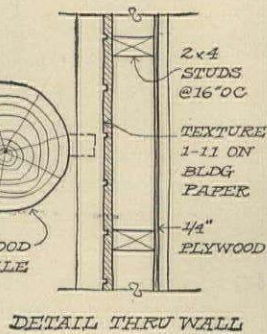
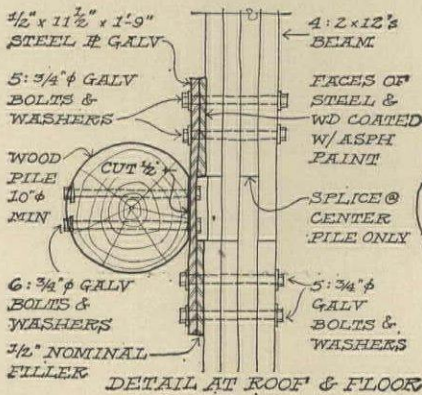
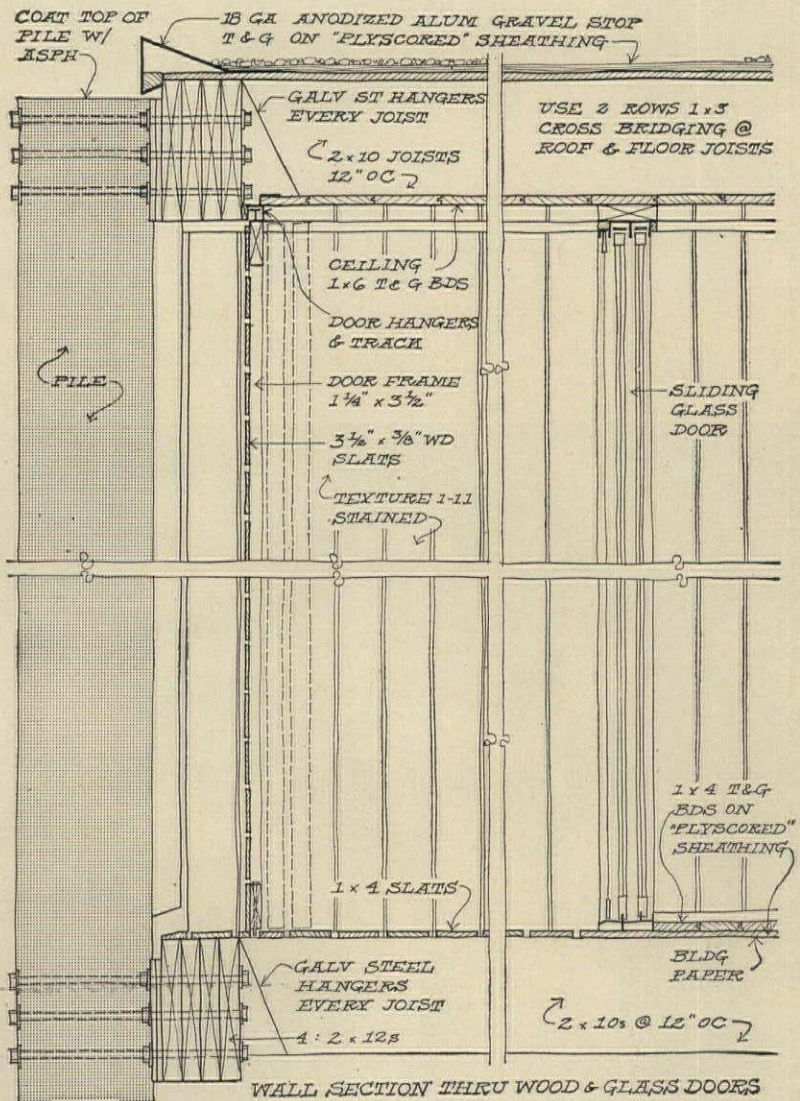

**WALL SECTION THRU WOOD & GLASS DOORS**

continued



**SLOPING LINES** of roof and stone piers suggest surrounding hills. Stone was gathered on the site. Weathered siding is

## Off-beat design — like this house — makes sense

Photos: Hal Berg



It makes sense because it can be used to take advantage of an interesting site, and it can be used to solve the problems of a difficult site—and vacation sites are often both interesting and difficult.

The six-sided living area of this vacation house is open on four sides, closed on only two. So in nice weather, there is a view most of the way around to the surrounding hills. And in dreary weather, the view turns indoors, where the big, round, central fireplace becomes the center of attraction.

The “roundness” of the house, with its sloping roof, matches the shape of the hills it is set among. The simple materials—rough stone, weathered siding, shingled roof—help fit the house to woods and fields, and are set off by careful detailing of the walls and sliding doors.

The house is designed and sited for a future addition off the bedroom-bath wing. Cost was \$13,000, including such special items as a wall-hung refrigerator, a compartmented bath, and year-round heating.

**LIVING AREA** focuses on fireplace. Roof structure is left exposed. All materials are durable and easy to keep up.



in character with site and farmer's nearby barn.

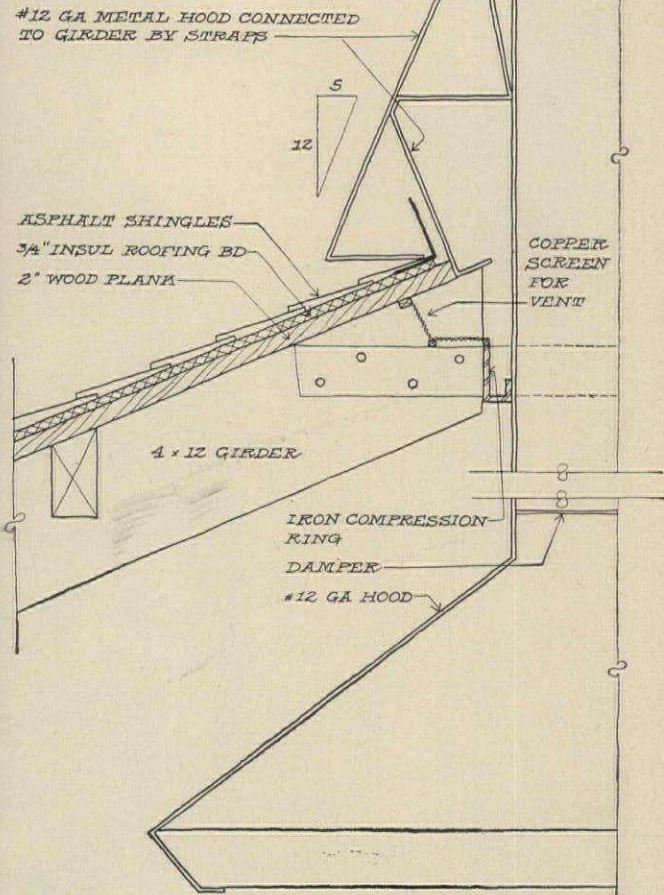

ARCHITECT: William Breger  
 ENGINEERS: McGuinness & Duncan  
 LOCATION: Roxbury N.Y.

## for the vacation market

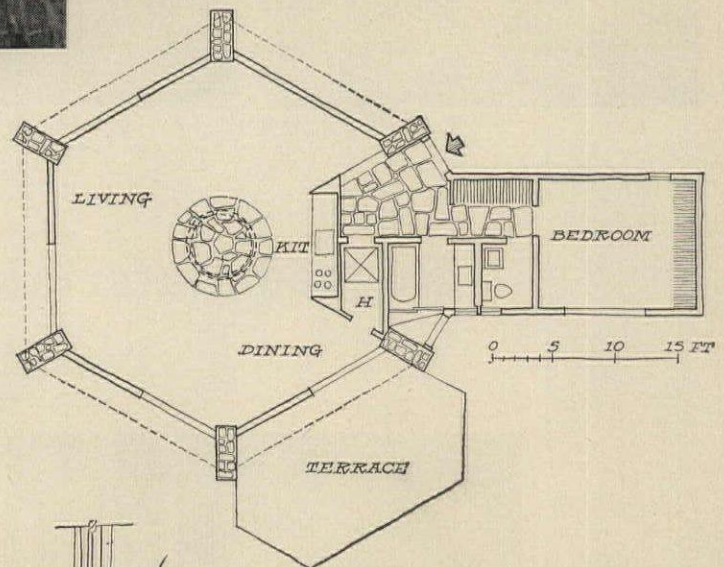

**WELL-PLANNED HOUSE** has compact utilities separating living area from bedroom.

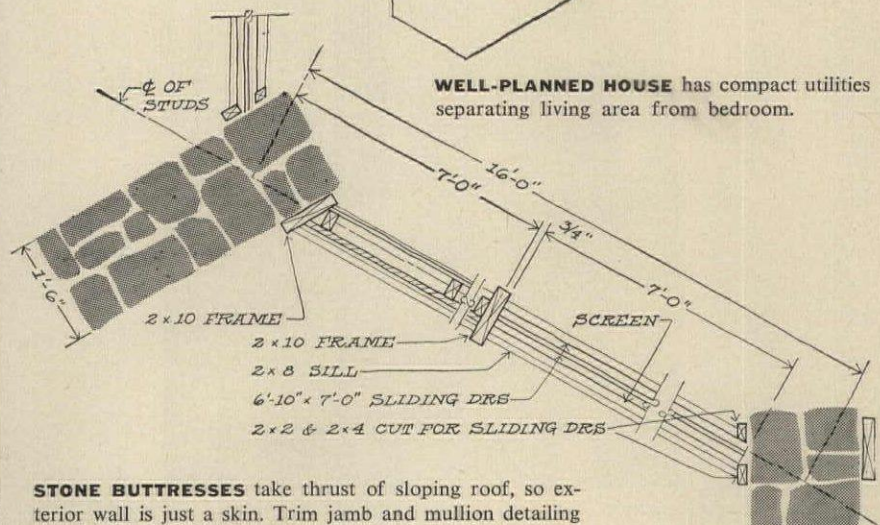

**STONE BUTTRESSES** take thrust of sloping roof, so exterior wall is just a skin. Trim jamb and mullion detailing gives wall its orderly pattern.

continued



**NATIVE STONE** used in fireplace and lower walls anchors house into slope. Roof overhang shades living room windows and part of deck.

## Rugged materials make this house easy to live in

Photos: Charles R. Pearson



**BUNKS** replace beds to save space and dollars; give added sleeping room for children and their guests.

And because the materials used are natural materials—wood and stone—the house blends in well with its rocky wooded site.

Stone, used for the fireplace and around the base of the exterior walls, was gathered on the site. Cedar walls are vertically split on the interior, cross-split on the exterior (and chemically treated for fire resistance). Oak floors and oak kitchen counters have a special clear-plastic finish, so they will keep their natural appearance but resist hard wear.

The living room couches, built-in and long enough to sleep on, are of reversible plastic so they too will be more durable.

Smart construction note: Window and door sections were completely shop-assembled and mounted, with screws, directly over the framing on the job.

The house cost \$18,200, about \$10 a sq ft including a year-round heating system and fully-equipped kitchen.



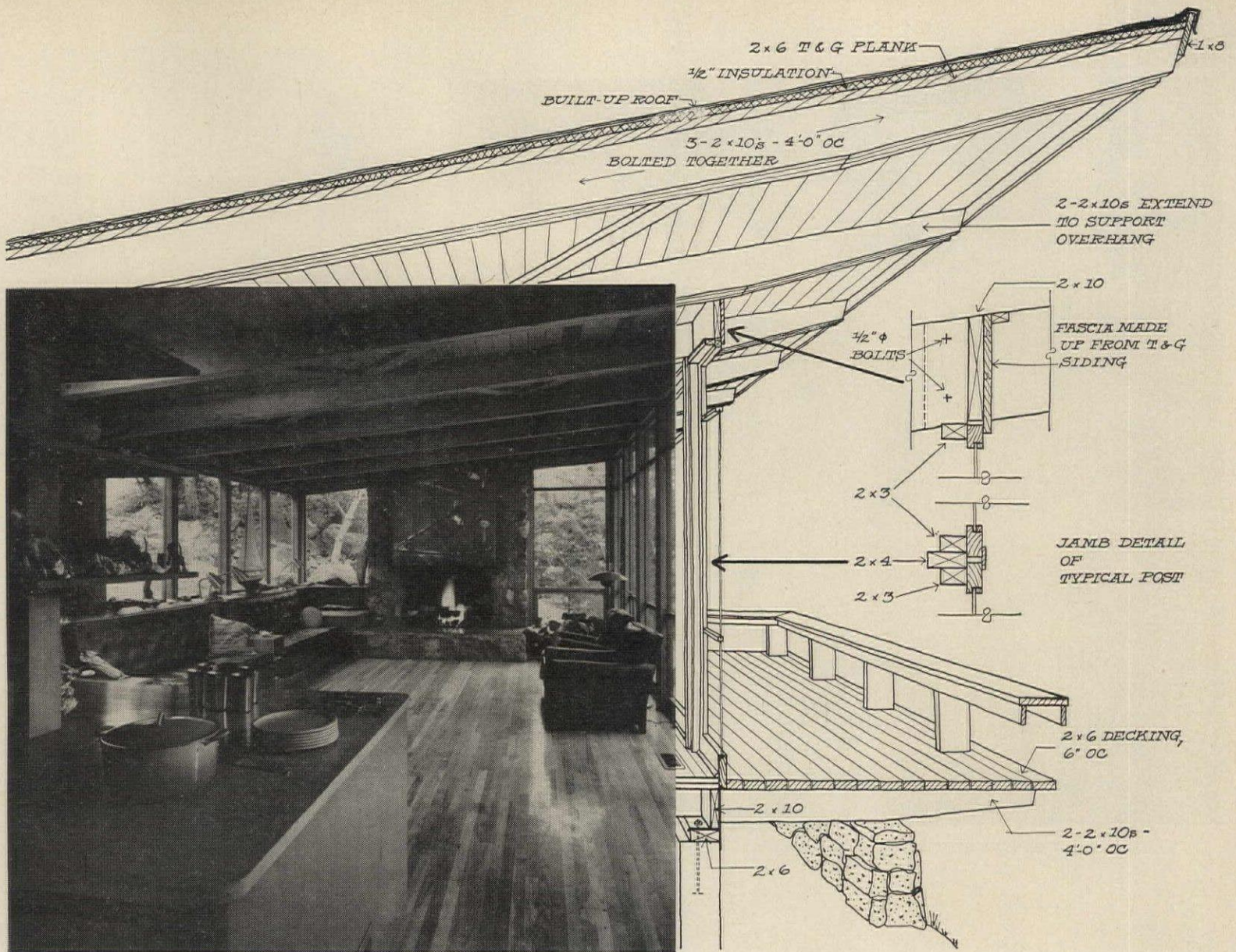

**LIVING AREA** seems extra large because it has big windows on three sides, opens to dining area and kitchen on the fourth.

## and easy to maintain

ARCHITECT: Carl Gould  
LOCATION: Orcas Island, Wash.

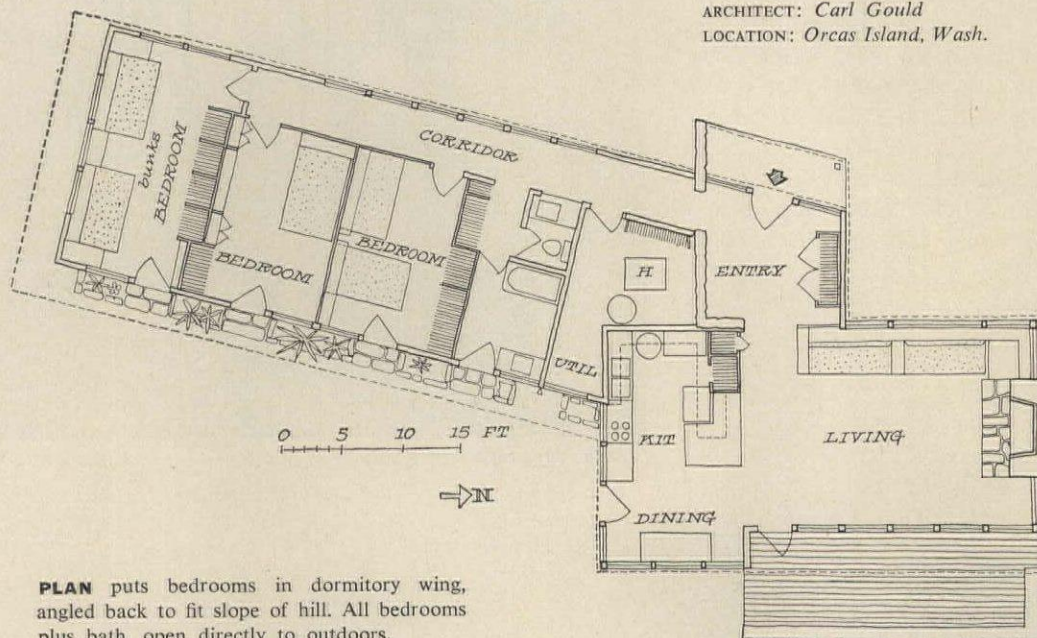

**PLAN** puts bedrooms in dormitory wing, angled back to fit slope of hill. All bedrooms plus bath, open directly to outdoors.

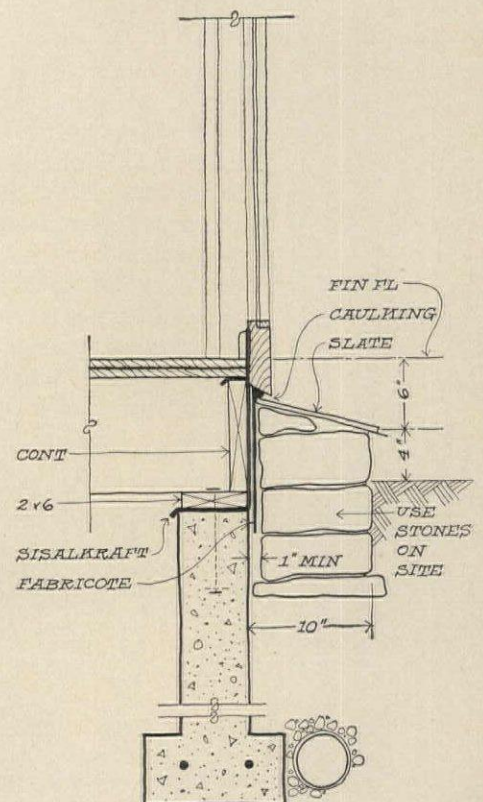

continued

Photos: Randon Picture Service

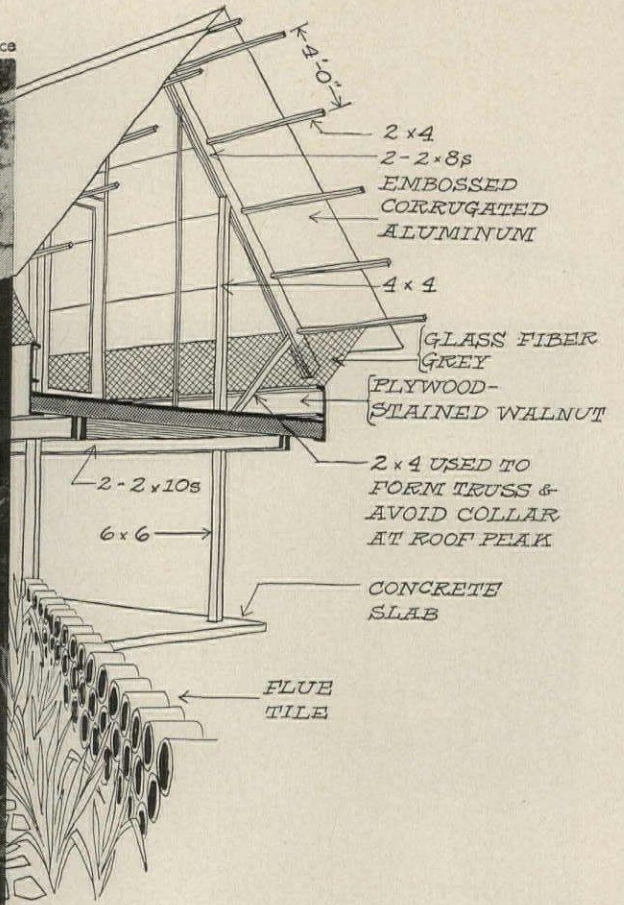

**TROPICAL CHARACTER** of house and yard are well suited to river site and hot humid climate.

## Open walls and a big roof keep this river house cool

In fact, this small vacation house uses every good principle of designing for hot weather (H&H, Feb).

All the walls are open to the breezes, so they are screened to keep out insects. The big overhangs keep the indoors and the exterior walls in shade, and they also keep heavy rains away from the walls. And so the house will be sure to catch every breeze, the living space is only one room deep and is on a platform raised in the air. Space under the house has a concrete-slab floor, so it acts as an extra shaded and sheltered terrace.

The house is designed for summer living only. It was built by two-man crew in 25 days and cost "well under \$3,000." /END

ARCHITECTS: *John and Mary Mykolyk*  
LOCATION: *Tangipahoa River, near Madisonville, La.*



"OPEN TREE-HOUSE" ROOMS are fun to live in, cool, shaded.

**THREE-ZONE PLAN** is compact. Both ends of living-floor open to an unscreened deck. Two strips of skylights help light interiors. Living floor is reached by folding stair.

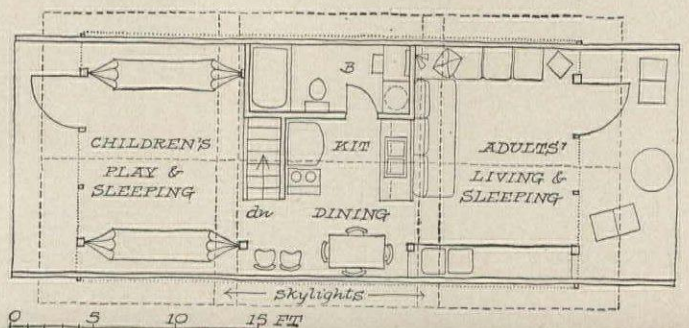

*Last December FHA's industry advisory committee unanimously recommended that FHA instruct all its offices to follow Fort Worth's policy of handling appraisals in a goldfish bowl. Early in January HOUSE & HOME Associate Editor Robert Murray Jr visited Fort Worth, saw its appraisal system at work and met with FHA and HBA officials to bring you the following report . . .*

## Here is how the Fort Worth FHA makes appraisals "in a goldfish bowl"

The secret of the Fort Worth 18-month-old system is simply this: the FHA office there has no secrets.

Every builder is told exactly how FHA judges a house and how it arrives at its appraisal figures.

Every builder can get his land appraised the minute he is ready to start improving it. He can find out how much he will be allowed for land costs, how much for development work, and how much for overhead and profit.

And on every house the builder can look at FHA's all-important Form 2017, the detailed underwriting report on which FHA's commitment is based. If the builder thinks his appraisal was figured wrong, he can protest item by item and FHA will refigure it with him.

### **For years secrecy in FHA appraisals has been a major deterrent to better quality**

A HOUSE & HOME industry round table agreed as long ago as 1954 that "many builders are afraid to question the valuations they get for fear of reprisals" and most builders "have no confidence that an extra expenditure for quality of materials will be reflected in their appraisals."

This is what the Fort Worth system was designed to eliminate. District Director Ed Dee, who initiated the goldfish bowl policy late in 1957, explains his program: "All of us are like players on a football team. We all must know the signals. If we don't, there will be confusion and distrust."

Dee has news for other FHA directors who may fear such a policy causes a lot more work: "Nobody has taken advantage of us since we opened our doors to the builders. My job is actually much easier. And as a measure of our success, our district volume is up over 60%, far above the national average."

Says NAHB's ex-President Dick Hughes, who builds in several southwestern FHA districts: "I think the Fort Worth practice is the finest thing that has happened in any FHA office. If a builder is right, he can prove it now. And the best part of it is the wonderful spirit that has developed among the builders. Nobody is mad any more."

Says HBF Administrator Norman Mason: "Fort Worth Director Ed Dee is doing . . . what every FHA office ought to do."

On the next few pages you will see Form 2017 and learn how the Fort Worth office makes an appraisal, how it determines building and land costs, and how it works closely with the Fort Worth HBA.



**EDWARD J. DEE,**  
district director,  
Fort Worth, FHA.

Bill Wood Photo Co

# This is the basic form used in all FHA appraisals

The sheet shown at left is FHA's Form 2017. The way it is filled out can make or break a builder. But the form never leaves an FHA office, and most builders never see it—much less one filled out for one of their own houses.

The form shown is an actual appraisal report on a proposed new house in Fort Worth. Figures are based on plans submitted last year for a 960 sq ft frame house, since built by Robert Driskell, 1958 president of the Fort Worth HBA. Every factor bearing on Driskell's application for FHA mortgage insurance is covered on this form. The reverse side bears on the buyer's credit rating and includes the credit examiner's recommendations on financing terms.

On the next two pages, H&H shows each part of the form in detail, slightly rearranging lines for easier understanding. (Solid triangles denote key data that are transferred to the reverse side of the form.)

## Form 2017 covers six major appraisal factors

The upper left of the form (lines 6 to 27) is for the cost accountant's take-off of costs for materials and other items which add up to the replacement cost of the house, including overhead and profit. Figures are based on the builder's plans and specification sheets. This part is explained in detail on p 169.

Lines 50 to 52, at the end of the replacement cost data, show the land, marketing, and other costs. These are added to structural cost to give an estimated cost of the proposed house on line 53 (see p 169).

Across the middle of the form (lines 32 to 55) is a report on the neighborhood, the site, and on the prices of comparable houses in the same area. These figures produce an estimated market price for the proposed house (p 170).

Across the bottom (lines 56 to 66) are figures that determine the capitalized value of the house as a possible rental property and (line 67) the office's final estimate of the value of the proposed house. The latter value must be the lower of the replacement cost or market price (p 170).

Down the right-hand column of the form are two ratings of property and location which (along with the rating of the buyer's credit on the reverse side) set the limits of the loan. Property and location ratings are shown on p 170.

Land costs are appraised separately, on a special form the Fort Worth office has prepared. An example is shown on p 171. This example refers to a large development by another builder, rather than to the lot referred to in this 2017 form.

The image shows a completed FHA Form 2017, 'UNDERSTANDING REPORT'. The form is divided into several major sections:

- Administrative Report:** Includes property address (2412 21st St, Fort Worth, TX), owner name (Driskell), and other identifying information.
- Replacement Cost:** A detailed table (lines 6-27) listing various construction items like foundation, framing, roofing, and plumbing, with columns for quantity, unit, and cost. The total replacement cost is listed as \$10,000.
- Neighborhood Report:** (Lines 32-55) Contains data on comparable properties in the area, including their sale prices and characteristics.
- Site Report:** (Lines 56-66) Details the physical characteristics of the property, such as lot size, zoning, and accessibility.
- Final Valuation:** (Lines 67-72) Shows the appraiser's final estimate of the property's value, which is determined to be the lower of the replacement cost or the market price.

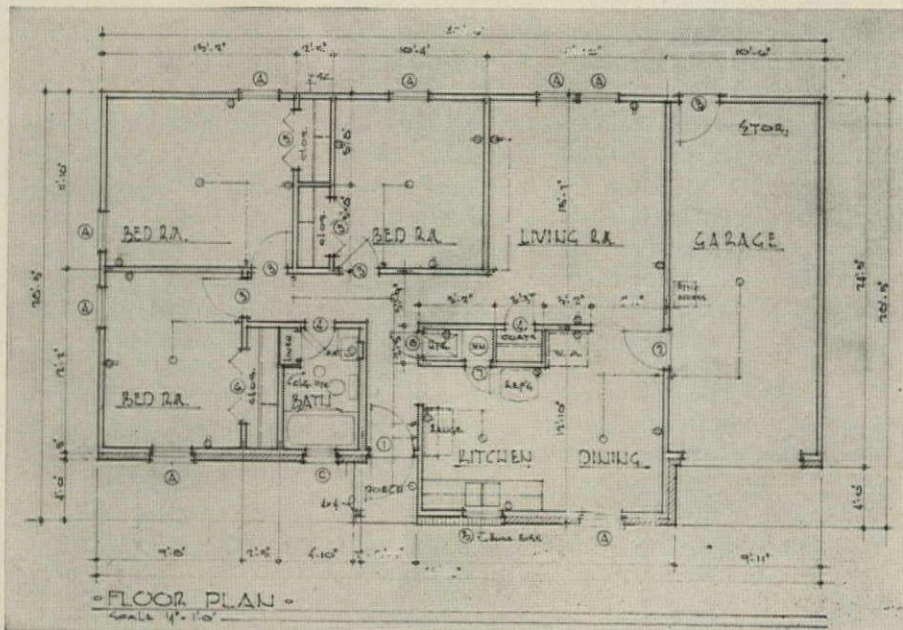

PLAN PHOTO SHOWS BLUEPRINT by Designer Ron Helfenstine for Builder Robert Driskell's 960 sq ft house. FHA appraisers took off their



costs from this plan. At right is photo of the house as later built and financed through FHA.



**NEIGHBORHOOD**

32. GENERAL LOCATION S.E. Ft. Worth - good

33. LAND USES 1-story 1-fam frame hses

34.  ADVERSE CHANGE IN  USE  OCCUPANCY  
 IS TAKING PLACE  IS ANTICIPATED. (SEE REMARKS)

35. BUILT-UP 90% PROSPECT FOR FUTURE DEVELOPMENT UNDER  PRESENT  ANTICIPATED USES IS  LITTLE  GOOD  EXCELLENT.  SEE REMARKS.

36. AGES OF TYPICAL BLDGS. 1 YRS. TO 4 YRS.

37. OWNER-OCC. 90% TENANT-OCC. 10% VAC. 0%

38. ESTD. MKT. PR. TYP. PROPS. \$ 9000 TO \$ 11,500

39. ESTD. MO. RENTAL TYP. PROPS. \$ 80 TO \$ 100

40. DEMAND FOR AMENITY INCOME PROPS. Moderate

41. DEMAND FOR RENTAL INCOME PROPS. Weak

42. EXCEPTIONALLY FAVORABLE OR UNFAVORABLE NEIGHBORHOOD CHARACTERISTICS:  
triple bituminous paving, poorly maintained

43. DEMAND FOR PURCHASE OF COMPETITIVE PROPERTIES IN ECONOMIC B. AREA:  NONE  LITTLE  MODERATE  STRONG

54. MARKET DATA	LOCATION	PRICE	DATE	EQ.	SUP.	INF.
	3621 OAKWOOD	\$10,000	'57	✓		
	3625 "	10,000	'57		✓	
	5223 MEDELLA	10,400	'57		✓	
	5235 "	10,400	'57		✓	

55. ESTIMATED MARKET PRICE OF PROPERTY **\$ 10,000**

56. MONTHLY RENTAL VALUE	\$ 80	59. OWNER-OCC. APPEAL	medium	60. MAINT. AND REPAIR	\$ 81
57. EXCESS MONTHLY EXP.	\$	61. HEATING AND UTIL.		61. HEATING AND UTIL.	\$ 165
58. REM. ECON. LIFE		62. HAZARD INS.		62. HAZARD INS.	\$ 32
59. OWNER-OCC. APPEAL	medium	63. TAXES		63. TAXES	\$ 200
		64. PYMTS. NONPREPAY. SP.		64. PYMTS. NONPREPAY. SP.	\$
		65. TOT. ANNUAL OPER. EXP.		65. TOT. ANNUAL OPER. EXP.	\$ 478

66. MONTHLY RENT VALUE MINUS EXCESS MO. EXP. TIMES  
 RENT MULTIPLE 127 EQUALS ESTIMATE OF CAPITALIZED INCOME IN FEE SIMPLE **\$ 10,160**

67. ASSUMING COMPLETION OF PROPOSED CONSTRUCTION, ALTERATIONS, REPAIRS, REQUIREMENTS AND THAT PROPERTY IS  IS NOT  ENCUMBERED BY SPECIAL ASSESSMENTS.  
 ESTIMATE OF VALUE IN FEE SIMPLE **\$ 10,000**

## This is how FHA analyzes the neighborhood

The market price of the house is as important as replacement cost of the property in FHA's appraisal.

Sometimes one and sometimes the other is lower—and whichever is lower sets the limit on the final appraisal (which appears on line 67 above).

The column at left, above, lists most factors that affect the market value of the proposed house. Appraisers reported: the subject house is in a good general district of new single-family frame houses, most of them owner occupied (lines 32 to 37); neighboring houses are in the \$9,000-11,500 range and rents range from \$80 to \$100; demand for amenity property (ie, non-revenue producing buildings) is moderate and demand for rental units weak; the only unfavorable mark is for poor paving.

Under line 54 FHA takes a sample of sales prices of similar houses in the same area to compare with the subject house.

The four indicated were equal or superior to the house planned, and sold for \$10,000 to \$10,400.

Figures on lines 56 to 65 are used to work out a capitalized value of the subject house on a rental basis. Here it is assumed the house would rent for \$80 a month for 55 years and operating costs would average \$478 a year. These figures indicate a capitalized value of \$10,160. FHA's appraisers went through this routine on rental value simply because the law requires this third check on property value—though the Fort Worth FHA agrees with experts elsewhere who consider this measurement meaningless. Says Dee: "I don't remember a single case in 15 years here where this was a factor in appraising a new house."

Since all three factors of replacement cost, market value, and capitalization were close to \$10,000, that is FHA's final appraisal of the property value entered on line 67.

PHYSICAL SECURITY FEATURES	REJ.	1	2	3	4	5	RATING
VISUAL APPEAL OF PROPERTY		4	8	12	16	20	16
LIVABILITY OF PROPERTY		4	8	12	16	20	16
NATURAL LIGHT AND VENTILATION		2	4	6	8	10	8
STRUCTURAL QUALITY		4	8	12	16	20	16
RESISTANCE TO ELEMENTS AND USE		2	4	6	8	10	8
SUITABILITY OF MECH. EQUIPMENT		4	8	12	16	20	12
RATING OF PHYSICAL SECURITY							76
ADJUSTMENT FOR NONCONFORMITY		16	12	8	4	0	0
RATING OF PROPERTY							76
Rating of Physical Security minus Adjustment for Nonconformity							
SITE DESIRABILITY FEATURES	REJ.	1	2	3	4	5	RATING
PROTECTION AGAINST INHARM. LAND USES		4	8	12	16	20	16
PHYSICAL AND SOCIAL ATTRACTIVENESS		4	8	12	16	20	16
AD. OF CIVIC, SOC. AND COMMER. CENTERS		4	8	12	16	20	12
ADEQUACY OF TRANSPORTATION		4	8	12	16	20	12
SUFFICIENCY OF UTILITIES AND SERV.		2	4	6	8	10	6
LEVEL OF TAXES AND SPECIAL ASSES.		2	4	6	8	10	10
RATING OF SITE DESIRABILITY							72
RELATIVE MARKETABILITY		16	12	8	4	0	
RATING OF LOCATION							72
Rate of Site Desirability minus Adjustment for Relative Marketability							

## This is how FHA rates the property and location

The property rating by the architects (top left) and location rating by the chief valuator (bottom) must each total 50 or more points to give a passing grade to a proposed structure. These two, with a third rating of the buyer's credit (made on the reverse side of Form 2017) are averaged and weighted. Together, they suggest whether the loan can be the maximum under the law.

The FHA architect's rating of the property in the subject case shows it is better than average for houses of this size in visual appeal, livability, light, structural quality and durability, and average for mechanical equipment like plumbing and wiring. The 76 rating is good in Fort Worth, where most ratings fall between 50 and 60, few over the 80 mark.

The location rating of 72 reflects six factors ranging from average (in the third column) to excellent (in the fifth column). Some factors are weighted heavier than others in both property and location ratings.

# This is Fort Worth's own land appraisal form

The Fort Worth FHA office has taken all guesswork out of land appraisals.

It has developed the analysis sheet shown at left. Developers fill this form out themselves, submit it to FHA for appraisal or revision. In the illustrated case, a builder planned to divide a 56½-acre tract into 149 lots averaging 75x145'.

The builder (or developer) submits his figures on the form before or after he makes improvements. In most cases, builders submit the form early so they can find out what FHA will allow them for land and improvements. (They also usually ask the local office to lay out their plats. The office does it willingly, and builders say this saves time and also assures plats will be approved when formally submitted.)

*Here is what happened in the example shown:*

The developer showed a total \$56,500 cost for the land to be used for lots, plus \$111,931 in planned improvement costs, and \$56,750 for interest, overhead, profit, and other expenses. The total of \$225,181 came down to \$1,511.28 per lot or \$19.36 per front foot.

Next, FHA's Chief Appraiser Allen Crump questioned the figures, and suggested the developer recheck them because they did not match FHA's experience in the particular area.

Result: the developer returned later and himself penned in the corrected figures shown in the "cost per front foot" column at right, and FHA then approved them.

		DEVELOPMENT COST DATA				
		Total Cost	Cost Per Acre	Cost Per Lot	Cost Per Front Foot	%
1. Land (Net Acreage)	\$56,500.00	\$1,000.00	\$379.19	\$4.86	<del>2.99</del> 25.1	
2. Excavation & Grading	10,218.00	180.85	68.58	.88	<del>.54</del> 4.5	
3. Paving	40,060.00	709.02	268.86	3.44	<del>2.12</del> 17.8	
4. Curbs	25,355.00	448.76	170.17	2.18	<del>1.34</del> 11.3	
5. Cross-walks						
6. Sewer Main						
7. Gas Main	2,016.00	35.68	13.53	.17	<del>.11</del> .9	
8. Land Planning	3,711.00	65.68	24.90	.32	<del>.20</del> 1.7	
9. Water Main (Including Fire Plugs)	26,571.00	470.28	178.33	2.29	<del>1.40</del> 11.8	
10. Street Lights						
11. Engineering	4,000.00	70.80	26.84	.34	<del>.21</del> 1.8	
12. Miscellaneous Expense						
a. Interest On Borrowed Capital	6,000.00	106.20	40.27	.52	<del>.32</del> 2.7	
b. Overhead and Profit	19,000.00	336.28	127.52	1.63	<del>1.00</del> 8.4	
	28,250.00	500.00	189.60	2.43	<del>1.49</del> 12.5	
c. Other Expense	3,500.00	61.95	23.49	.30	<del>.18</del> 1.5	
<b>TOTAL COST</b>	<b>\$225,181.00</b>	<b>\$3,985.50</b>	<b>\$1,511.28</b>	<b>\$19.36</b>	<b>11.30</b>	<b>100.00</b>

# Here is more news about Fort Worth's FHA

Cooperation between the industry and FHA in Fort Worth extends to all fronts.

Every two weeks a committee of the local HBA meets with the top men of FHA to go over problems of concern to all builders. Three days before the session the builders submit an agenda so FHA officials can be prepared. Meetings are limited to one hour so nobody will waste time or lose interest.

Two subjects were discussed at the last meeting in January—the attitude of FHA in Washington to a low-cost slab which the Fort Worth joint committee has engineered for its difficult local soils (see H&H Apr), and plans to educate local builders about the new Minimum Property Standards. On the latter, it was agreed each committee member would prepare thoroughly on specific sections of the

MPS book. Then at the membership study meetings builders would present the new standards and FHA's men would be ready to answer questions.

Cooperation is made easier by the fact the Fort Worth HBA publishes a weekly newspaper. This brings FHA rulings to all builders as soon as they are made.

Also, each week FHA tells HBA how many applications it had on hand at the start of the week, how many it received during the week, the number of commitments issued, and the number of applications on hand at the end of the week. This is printed the day after it is received and tells builders two important things: 1) how long they can expect it to take for their applications to go through, and 2) the amount of current building activity.

## Here is what leading builders say about the new policy

**C. P. Hadley** (mortgage broker and largest Fort Worth builder): "We don't have any trouble with FHA now. We would like more for land, but they are trying to be fair and play no favorites."

**Ocie Conger** (first chairman of FHA committee): "FHA men are our friends now. The system has ended uncertainty about whether to go ahead with our plans."

**Robert Driskell** (also a city councilman): "Before they showed us the 2017 forms we didn't know our costs so well. Many builders were bleeding to death before they knew their throats were cut."



**JOINT COMMITTEE** of builders and FHA men is made up of (from left, clockwise around table) Builder Todd Statley; Ted Peters, president of the Fort Worth HBA; FHA Director Edward Dee; Robert Driskell, chairman of the builder's FHA committee; Builder

H. D. Buchanan; Builder William Granger; Eugene Mitchell, HBA executive officer; Walter Hoag, FHA chief architect; Allen Crump, chief evaluator; Samuel Nelson, chief of mortgage credit; G.C. Martin, construction cost examiner, and Builder Ocie Conger. /END

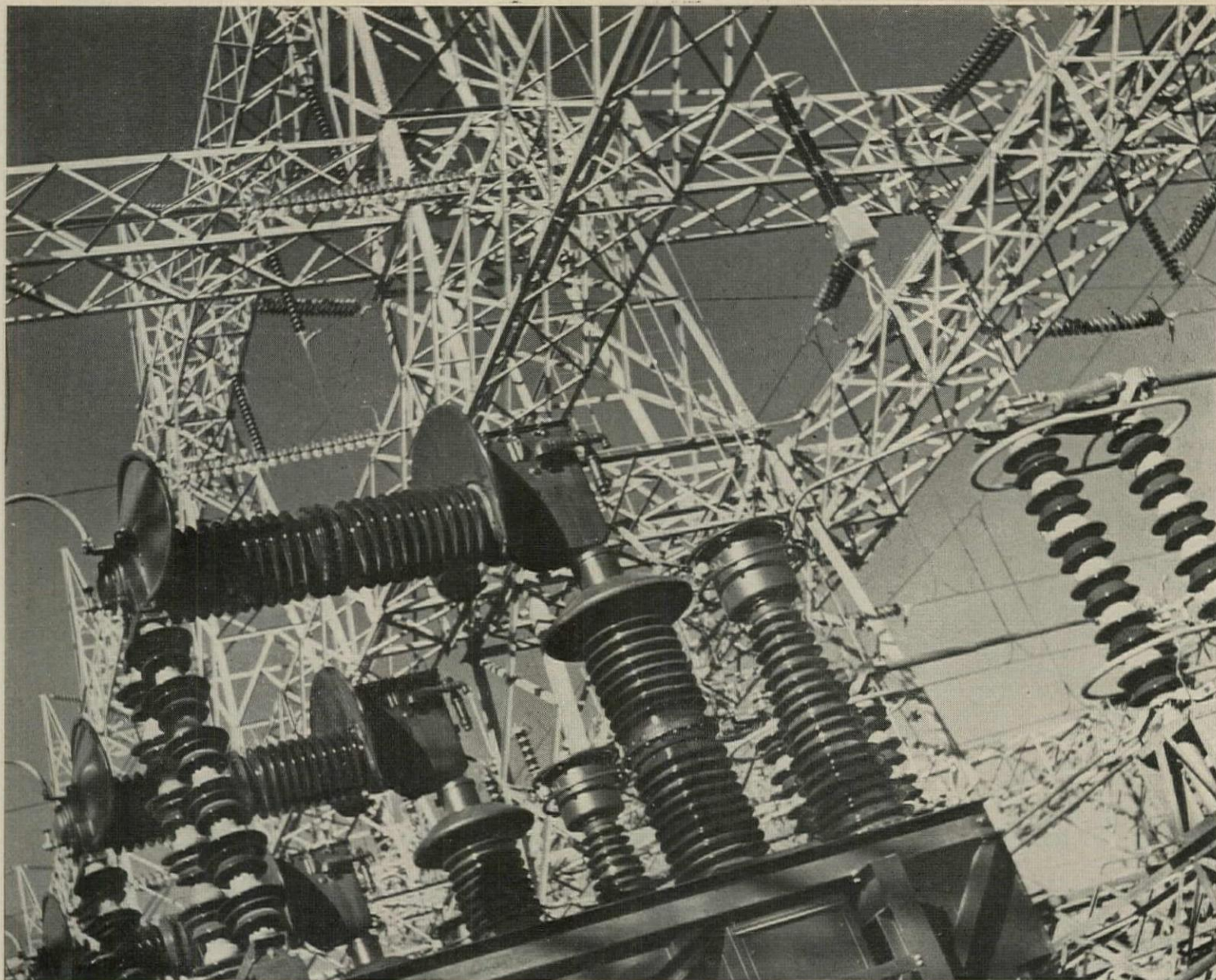

*The number of homes heated electrically has increased 50% every year since 1955. By 1962, the electrical industry predicts, 15% of house starts will have electric heat. What is the basis for this claim? Why, according to its friends, is electric heat becoming more attractive? To find the answer, H&H Associate Editor Richard O'Neill surveyed manufacturers, utilities, and building professionals. His report follows:*

## The Case for Electric Heat

Electric heat is being used in more and more houses today because its once-prohibitive operating costs are now getting lower and lower.

In some areas, not confined to the south, electricity is already highly competitive with other fuels for heating.

And the number of places where electric heating rates are designed to be competitive with gas and oil, is increasing steadily.

When nuclear-generated electricity becomes the com-

mercial standard (possibly in the late 1960's), very low rates for electric heating should be the nation-wide rule, not the exception.

There are two reasons why operating costs for electric heating are getting lower:

1. Many electric utilities are offering special inducement rates and, at the same time, many are also reducing their basic rates.
2. Technological advances—in construction, in insula-



tion and in heating equipment—are reducing the number of kilowatts needed to heat the average house.

How low do electric rates need to be to make electric heating competitive with other fuels? They should be 1¾¢ per kwhr, or lower, most experts say (but some utilities report they are successfully promoting electric heat at rates as high as 2¼¢ per kwhr).

Is the case for electric heating dependent solely on more

competitive operating costs? No, say its partisans, electric heating has many advantages, and how widely it is adopted for domestic use depends largely on the attitude of building professionals. In some areas electric heat, particularly resistance heating, is attracting attention of many builders, but large-scale use is often prevented by appraisers and lenders who penalize it in their valuations. These penalties, electric heating men say, are unjustified in most areas.

## Here are the advantages claimed for electric heat

1. *It saves construction cost.* Ft Wayne Builder Jack Worthman figures electric heat saves him about \$365 a house. It boosts his costs by \$125 for added insulation and \$160 for storm windows. But it cuts his costs by eliminating \$75 for 15 sq ft of floor space for a furnace, \$100 for a chimney, \$30 for a furnace door, \$20 for sound-proofing the furnace, \$100 for slab ducts, \$125 for a buried oil tank. And, he saves up to \$200 by letting his heating and wiring contracts to the same contractor.

2. *It's clean, safe, and silent.* "This is what my buyers want," says Builder Raymond Borovicka, Glen Ellen, Ill. "They don't seem interested in operating costs... Without electric heat, my business—250 houses a year—would fall off."

3. *It permits individual room control.* Every room can have

its own thermostat. Bathrooms can be kept at 80 degrees, bedrooms at 65. This cuts the over-all heating load because heat can be pushed up only where it's needed.

4. *It requires little or no repair and maintenance.* This claim is made for all systems except heat pumps (see p 176).

5. *It reduces cracking and shrinking of woodwork and furniture.* Electric heat permits higher relative humidity (the house must be well insulated) because it needs hardly any air change.

6. *It provides equal comfort at lower temperatures.* You're just as comfortable in still air (electric heat) at 65° and 48% relative humidity as in air that changes at 300 cu ft per minute at 72° and 25% relative humidity.

## Here is WHY utilities are promoting electric heat

1. *They want to balance their year-round load.* Because of air conditioning, more and more utilities—as far north as Chicago—are running into peak loads in the summer. These summer peaks demand extra generating equipment. To make this equipment pay off year-round, utilities must balance summer peaks with heavier winter loads.

2. *They want to balance their daily load.* Electric heat helps spread the load over the day instead of concentrating it in the evening when lights and appliances get heavy use.

3. *They want a better balance between industrial and residential use.* When plants (big electric users) shut down, they create valleys in the utilities' loads. But houses don't shut down.

4. *They want to encourage use of other electrical equipment.* People who heat their houses electrically are more inclined to buy electrical appliances because they already have the necessary wiring.

5. *And, of course, they want the fat revenue brought in by electric heat.* An electric-heat customer is a \$300 customer instead of just an \$80 or \$100 customer. For example: Indiana Michigan Electric Co had 4,000 heating customers last year—just 1½% of its residential total. But this relatively small group of customers helped stabilize the company's earnings while industrial revenue was dropping off. Residential heating alone accounted for 43½% of Indiana Michigan Electric's increased revenue in March '58 over March '57.

## Here is HOW utilities are promoting electric heat

1. *They are lowering rates.* Forty years ago the cost of electricity stood around 12¢ a kwhr, but by the 1930s it had dropped to about 5¢ a kwhr. Now rates run from .4¢ to 2½¢ a kwhr. According to a recent survey by the industry magazine *Electrical World*, 45% of major utilities have heating rates of 1½¢ or less, 23% of 1½¢ to 2¢, 23% of 2¢, and the rest of more than 2¢.

2. *They are offering special night-time rates.* For instance: Western Massachusetts Electric Co has a low rate of 2.1¢ per kwhr, but a special rate of 1.3¢ between 11:30 pm and 7 am. Many homeowners in this area run a boiler with electric heat at night (see p 178), then heat their houses with hot water during the day. Their electric-heat rate averages about 1.4¢ a kwhr.

3. *They are offering special winter rates.* For instance: Salt

River Power, Phoenix, grants a 40% discount on electric heat.

4. *They are using budget billing to take the bite out of big January and February bills.* This spreads payments evenly from September through June.

5. *They are offering special services to builders and contractors.* Whether they promote electric heat or not, most major utilities provide design and layout service for builders who install it.

6. *They are even paying special bonuses to builders.* For example: Commonwealth Edison of Chicago charges \$50 a house for underground wiring in new developments. If a builder puts in one 240-volt appliance, he gets a \$25 allowance. If he puts in two 240-volt appliances, he gets his underground wiring free. And if he puts in electric heat, CE pays him \$100.

## Here are the two main types of electric heat

1. *Resistance heating* puts an electric current through an element—thin wire, metal coils, metal panels; or glass. The current is turned directly into heat by resistance to its flow through the element. For what you need to know about resistance heating, see p 175.

2. *Heat-pump heating*—a relatively new form—uses electricity

indirectly to produce heat. The electric current powers machinery that draws heat from the air. For what you need to know about heat-pump heating, see p 176.

But no matter which basic system a house has, it needs special insulation. That is why electric heating usually makes sense only in new houses—is difficult to install in older houses. For what you need to know about insulation, turn the page.

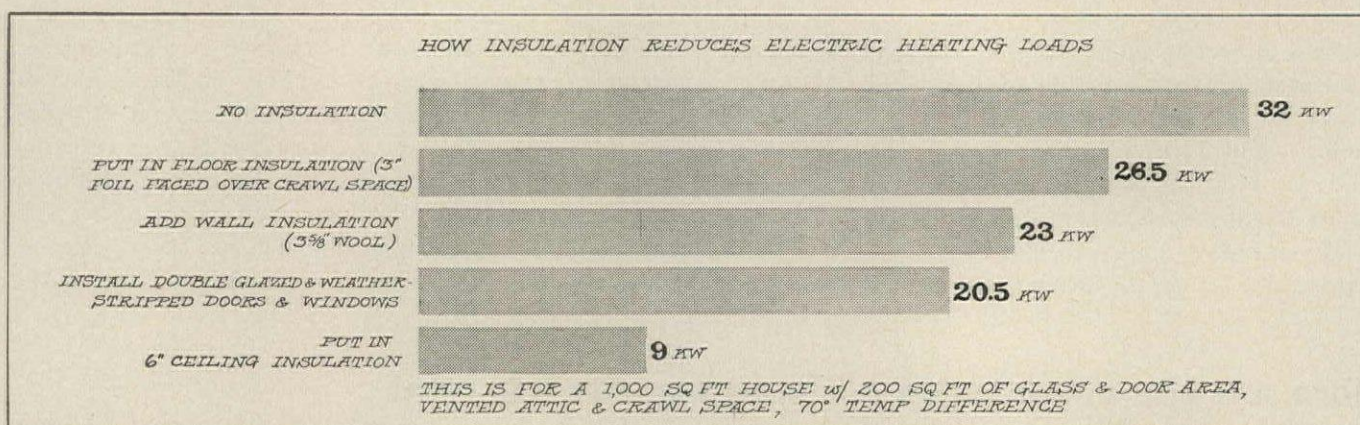

CHART shows how full insulation reduces the kilowatt load of an electrically heated house by almost 72% (from 32 to 9 kw).

## What you need to know about insulating for electric heat

Insulation for an electrically heated house should be twice as heavy as insulation for a house that's heated by oil or gas.

And its cost will probably be two to three times that of an ordinary insulation job. You should include double glazing or storm windows, weather stripping, and vapor barriers on all exterior walls, ceilings, and floors. If the house happens to be air-conditioned, the extra-heavy insulation needed for electric heating will cut cooling costs by about 30%.

How does full insulation affect the kilowatt load needed to heat a house? The bar chart above gives you an idea. For instance: the 6" batt recommended for the ceiling (where heat loss is greatest) trims the kilowatt load by more than one third. (The chart is based on a house with basement or crawl space. For a slab house, 1" to 2" of rigid, waterproof insulation should be used *under* and *facing* the floor edge.)

If you're planning an electric heating system:

### Be sure to figure "u" (heat loss) factors of the house

You can get your figures by checking manufacturers' literature to find the heat loss factor for each material you use. Heat loss factors on which the bar chart is based are: .04 for the floor, .06 for the walls (with insulating board sheathing),

and .04½ for the ceiling. These heat loss factors are based on the maximum insulation required in most US areas.

You should bear in mind that the amount of insulation needed depends somewhat on the type of electric heat (see p 175-177) you use. For example: ceiling-cable heating requires a ceiling with a "u" factor of not more than .04½, but if you use baseboard units or a heat pump, you can get by with a higher "u" factor and still come up with the same operating cost.

### Be sure to provide adequate vapor barriers

With electric heat, there are less air changes and, therefore, higher humidity levels. Unless you have good vapor barriers, humidity will seep through the walls and condense at a dew point in the insulation. Result: lower insulation values. Best practice: install a polyethylene vapor barrier between the studs and the drywall.

The essential importance of insulation for electric heating is recognized by all experts. Many electric utilities encourage better insulation because they don't want high operating costs to bar the use of electric heat. One utility—Duke Power Co, Charlotte, N.C.—penalizes inadequately insulated houses by charging up to 2¢ a kwhr instead of its usual rate of 1½¢.

## What you need to know about figuring operating costs

You can make a *rough* cost estimate for a properly insulated, one-story, 1,200 to 1,400 sq ft house by using this formula:

Annual operating cost = 2 kwhr (2½ in windy areas) x number of degree days in year (see map caption) x rate per kwhr (lowest rate charged by your utility).

This formula applies to all types of electric heat except heat pumps in areas with more than 6,500 degree days.

### Getting a final cost estimate is not so easy

Electric heat is still so new that there are no tested formulas. And the results of theoretical formulas—based on purely physical laws—often turn out to be 30% to 40% higher than actual costs.

But two formulas—one from FHA and the other from the National Electrical Manufacturers Assn—give answers that are fairly accurate (although probably a little high for properly insulated houses).

The FHA formula: 
$$\text{kwhr per year} = \frac{\text{Btu/hr} \times \text{degree days}}{\text{Temperature difference} \times C}$$
 (a constant placed at about 180 in the Midwest)

The NEMA formula: 
$$\text{kwhr per year} = \frac{\text{KW} \times \text{degree days} \times 18.5}{\text{Temperature difference}}$$

*Btu/hr*—a measure of the heat lost or gained through the skin of the house.

*Degree day*—a measure of cold-weather intensity (see map caption).

*Temperature difference*—the difference between room temperature and the average outside temperature on the coldest day of the year.

*C*—the relationship of calculated kwhr to actual kwhr per year.

*KW (installed capacity)*—calculated heating load of the house (derived from NEMA or similar tables).

*18.5*—a constant factor often considered too high (Washington Water Power Co, Spokane, suggests 14.5).

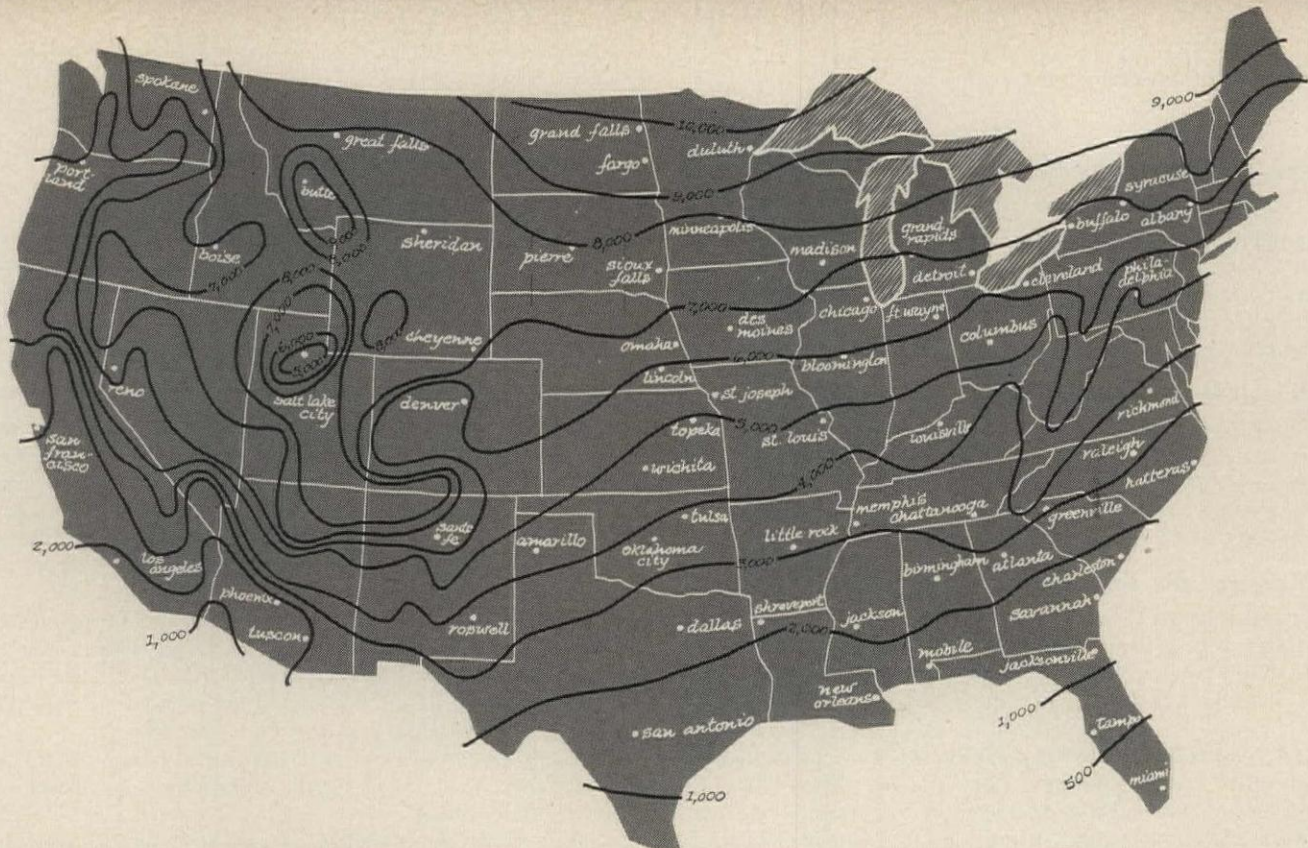

**ANNUAL TOTALS OF DEGREE DAYS** in different areas of US are shown on this map. Number of degree days for each day is figured by subtracting average temperature for the day from 65 F (if average

temperature is 30 F, number of degree days is 35). Daily totals are added to get annual total (Cleveland, for example, has 6,000 degree days a year).

**These publications will help you figure operating costs**

*Guide for Calculation of Electric Space Heating* Cavalier Corp, Chattanooga, Tenn. \$1.

*Electric Heating for Homes Guide* Westinghouse, Emeryville, Calif. \$2.

*Wiredheat Calculator* Wesic Electric Heater Co, 390 First St, San Francisco. \$1.

*Technique for Predicting Heat Pump Power Consumption* Carrier Corp, Syracuse. \$1.

*Electric Heat Cost Estimator* Hunter Div, Robbins & Myers, Memphis. \$1.

*Guide for Calculations of Electric Space Heating* National Electrical Mfrs Assn, 155 E. 44 St, New York City. 50¢.

*Heating, Ventilating, Air Conditioning Guide* ASHAE, 62 Worth St, New York City. \$15.

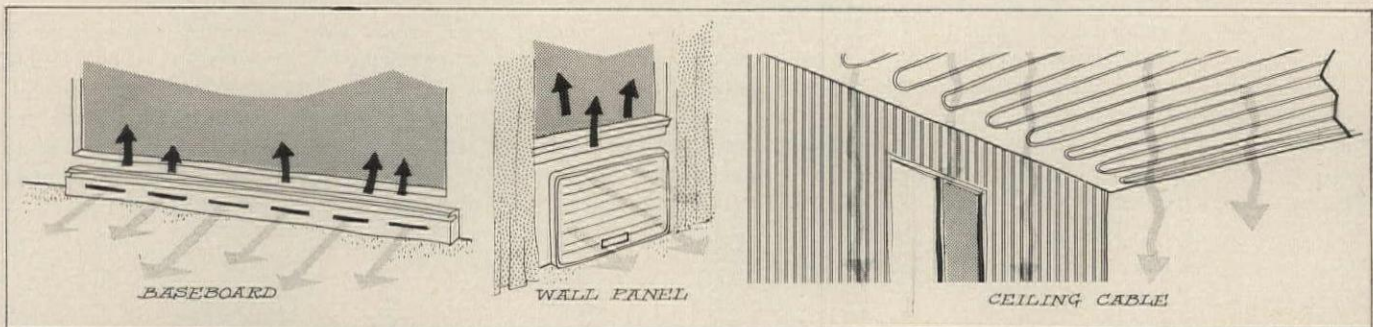

**THREE TYPES OF RESISTANCE HEATING** are baseboard units, wall-panel units, and ceiling (or floor) cables.

## What you need to know about resistance heating systems

There are three basic systems. In order of the number of houses they now heat, they are:

### 1. High- and low-temperature baseboards

High-temperature units have elements like coils on an electric stove behind shields (so there's no danger of being burned). Air enters slots in the bottom of the shield, is then moved by convection (or a small fan) over the elements and out the top of the baseboard.

Low-temperature (up to 125F) units have metal or glass-plate elements exposed to the room, but protected by a grille. These elements have a larger surface area than high-

temperature elements, thus require higher baseboards.

### 2. High- and low-temperature wall panels

These units heat like baseboard units, but they present an almost square surface, instead of a long, low rectangle, to the room.

### 3. Low-temperature ceiling (or floor) cable

Ceiling cables—special alloy wire in Btu-rated lengths with non-heating leads—make the whole ceiling a low-temperature radiator (100F to 115F). They are stapled to ceiling lath in loops at close intervals, and hidden behind drywall or plaster.

*continued*

## Here's how to select a resistance heat system

First figure the heat loss of the house. The publications listed on p 175 will show you how—and how to translate heat loss (Btu's per hour) into how many kilowatts of heating elements you'll need. Then consider three things about the three types of resistance heat.

### 1. Consider the installed cost of each system

Here's how costs per sq ft of living area compare in a house that's properly insulated (see p 174) for electric heat: *baseboards*—from 65¢ for high-temperature units to 75¢ for low-temperature units; *wall-panels* 75¢ to 85¢; *ceiling cable*—50¢ to 55¢.

### 2. Consider the advantages of each system

*Baseboard units* help keep wiring out of the walls, thus reduce high wiring costs. Most baseboards have plenty of room for lighting and appliance circuits. Receptacles, available in most baseboard lines, can be fitted right into the ends of the units.

High-temperature baseboards offer the most efficient electric heat in colder climates. They put the heat where it's needed most—around the perimeter of the house. Low-temperature baseboards offer "softer," less concentrated heat.

*Wall panels* simplify furniture arrangement because they are generally put under windows where furniture is not usually placed.

*Ceiling cable* is hidden, so it puts no limits on furniture arrangement. It beams soft heat into the room over a wide area, so people are usually unaware of the heat source. And it can move, stretch, or bend with any movement of the ceiling or house.

### 3. Consider the special characteristics of each system

*Baseboard units* save labor because they are surface-mounted after the wall is finished. All you do before finishing the wall is to install the 240-volt leads (some low-temperature units take 110).

Baseboard comes in sections that vary in length from 2' to 12' and in height from 6" to 10". It has corner pieces and can be painted.

*Wall panels* are recessed into the wall (and sometimes the ceiling) so that only the front of the units projects into the room. So it is necessary to build in frame boxes, like rough window openings, at the framing stage of construction. This means extra labor and higher installation costs.

You can keep costs down by using wall panels where you want to concentrate heat (ie, in bathrooms) and baseboard units in other rooms.

*Ceiling cable*, though least expensive to install, demands heavier ceiling insulation than wall panels and baseboard units. Otherwise, you'll lose too much heat to the attic, and operating costs will rise.

## New forms of resistance heat are being developed all the time

Here are five new developments that are just coming out of the experimental stage and are not yet on the market:

1. *A decorative metal screen that heats and cools* is being developed by Westinghouse. It heats up when current is run one way through it, cools off when current is run the other way. The screen uses two dissimilar metals (they form a thermocouple) to take advantage of an old principle called the Peltier effect. (If two wires of different metals are connected with two terminals and a current is passed through the wires, one terminal gets hot and the other gets cool; if the current is reversed, the opposite terminals are heated and cooled.) Wall screens like this could provide all the heating and cooling needed in a house.

2. *A plywood heating panel* is being developed by US Plywood. A layer of graphite (like a glue line) is placed between the plys. When current is run through the graphite, resis-

tance to the current heats the plywood surface to about skin temperature (the plywood can also be prefinished). The panels are low-temperature radiators that could heat a whole house.

3. *A paper that can be charged with electricity* is being developed by Chemelex Inc (Niskayuna, N.Y.). Copper foil strips along opposite edges of the paper energize a chemical coating (colloidal silica is one of its ingredients) that then radiates low-temperature heat. The paper can be buried in driveways or slabs or applied to walls and ceilings.

4. *A sandwich wall panel with a built-in heating unit* is being developed by Bettinger Corp (Boston). The heating element is an aluminum screen fused to the inner face of the panel. The core of the panel is a paper honeycomb.

5. *A wall panel with a thin aluminum heating grid* is being developed by Arvin Industries (Columbus, Ohio). It is made of particle board and covered with a vinyl overlay.

## What you need to know about heat pump heating systems

Five years ago there were only six manufacturers of residential heat pumps. Today there are 34.

Thirteen years ago there were only 46 heat pumps in the US. By next year there will be about 75,000—and almost half that number will be installed this year.

*Why such rapid growth in the use of heat pumps?* Largely because of the rapid growth of home air conditioning. In most areas heat pumps—theoretically—combine electric heating and cooling at the most reasonable cost for installation, operation, and maintenance.

## Here's how to pick the right size heat pump for a house

Pick the heat pump on the basis of your cooling—not your heating—requirements.

Why this seeming contradiction? Three reasons:

1. The amount of cooled air a pump turns out is the critical factor because you need more cold air to cool a house than hot air to heat it.

2. If needed, extra resistance heat coils can be added to a heat pump of any size simply by putting them in the air supply ducts.

3. In many areas you need little or no supplementary heat in the pump. Until the outside temperature drops to 30F, the pump heats at more than 200% efficiency—turns out at

least two units of heat for every unit of power it uses. This is because it uses electricity not as a direct source of heat but simply to drive a compressor. It needs no supplementary heat until the outside temperature sinks to about 20F. At this point, its efficiency generally slips to 100%—the same as for resistance heat.

The capacity of a heat pump—like the capacity of an air conditioner—is rated in cooling tons.

With the right amount of insulation (see p 174), a house in the South needs one ton of cooling for every 600 to 800 sq ft of living area; a house in the North needs one ton for every 700 to 900 sq ft. Heat-pump installation costs—includ-

ing ducts, controls, and finish—range from 75¢ to \$2 a sq ft of living area.

Operating costs with a heat pump can be as much as 40% lower than with resistance heat. But in colder climates (areas with more than 6,000 degree days) this cost advantage is canceled out by the need for supplementary resistance heat (under this circumstance, the supplementary units would require as many kilowatts as a straight resistance system). This supplementary resistance heat is not as efficient as baseboard radiation, for example, because its radiant effect is lost in the ductwork. So it's not surprising that there are 3½ times as many heat pumps below the 4,000-degree-day line as above it.

### What is a heat pump, and how does it heat?

An air-to-air heat pump is a device that collects heat from the air at one point and pumps it to another point (there are also water-to-water heat pumps).

An air conditioner is a heat pump. It collects heat indoors and pumps it outdoors—heating the outdoors.

A heat pump used to heat a house is exactly like an air conditioner but it is reversed physically. So it collects heat outdoors and pumps it indoors. (Many people ask: Does this mean that if I turn an air conditioner around in the window, it would heat the room? The answer is yes.)

Why is it possible to collect heat outside in cold weather? Because there is always heat in the outside air except at minus 460F (“absolute zero”). There is no such thing as cold. There is simply less heat in the air on a cold day than on a hot day.

But, as a practical matter, when the outside temperature dips below about 20F, heat pumps of any practical size cannot “find” enough heat in the air to heat a house.

*Here is how a heat pump heats a house:*

An air-to-air heat pump consists of two sets of coils (one inside the house, one outside), connected by tubing and filled with gas, and a compressor to compress the gas.

It operates on these physical principles: 1) when a gas expands, it absorbs heat; 2) when a gas is compressed, it gets hotter; 3) anything that's hotter than its surroundings gives off heat.

Gas in the coil outside the house (the evaporator coil) is expanding. Because it is expanding, it “absorbs” or picks up heat from the outdoor air. The gas flows to the compressor, which compresses it and makes it much hotter. This hot compressed gas is pushed to the coil inside the house (the condenser coil) where it gives off the heat it picked up outside.

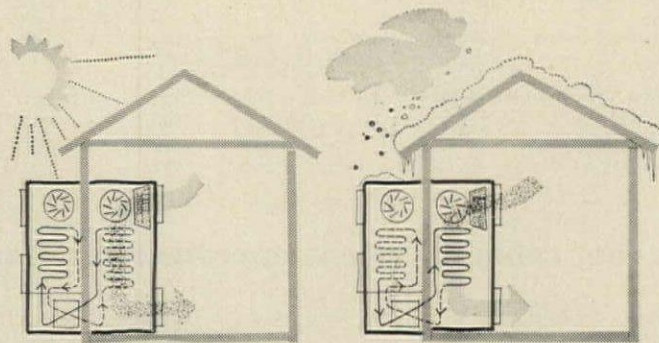

From the condenser coil, the gas flows back to the evaporator coil outside the house. At this stage, the gas is expanding again from its compressed condition at the condenser coil.

## What you need to know about electric heating products

If you're planning on an electric heating system, you'll want to know what products are available for your use.

Starting below and running over to the following page is a fast review of major new products used with electric heating systems. The list is broken down into four categories: 1)

baseboard and wall-panel resistance heating; 2) ceiling-cable resistance heating; 3) heat pumps; 4) central heating units.

If you want more information on any of the products listed, you can get it from the manufacturers by circling the product coupon number on p 268.

### Baseboard and wall-panel resistance heating units

There are two important variables among resistance heating units—their shape and their temperature.

High-temperature units—mostly baseboards—are apt to be long and low. Their heating elements are coils. The longer the unit, the longer the coil and the greater the wattage or heat output. High-temperature units heat by both radiation and convection. They are shielded so that only air—moved through the unit by convection—comes in contact with the coils.

Low-temperature units—mostly wall panels are apt to be rectangular because their elements are flat surfaces—usually glass. Glass panels radiate directly to the room without any shielding. The bigger the panel, the greater the heat it throws out. New baseboard and wall-panel units include:

**Acme Electric.** Baseboard: Units 2' to 6' long, 10"x3". 400 to 1200 w. For full data circle No. 7.

**Ampere Industries.** Baseboard: Radiant glass elements, 1000 w, 4"x8"x2". For full data circle No. 9. Wall panel: Radiant quartz element, can be used on ceiling, 2500 w; 24¾"x12¾"x4". For full data circle No. 48.

**Berko.** Baseboard: 650 w incl. duplex receptacle; 3'x7¼"x2". Also 500 to 3000 w, 2' to 10' "electrofin" units. For full data circle No. 10. Wall panel: From 750 to 3000 w in variety of sizes and shapes; ceiling units are fan-forced. For full data circle No. 49.

**Berns Air King.** Wall panel: Forced air heater, 1200 w, 14"x10"x3¾" or 10"x4"x3¾". For full data circle No. 50.

**Braun.** Wall panel: Fan-type heaters, 1200 to 2000 w, 10¼"x13"x4" and 7¾"x13"x4". For full data circle No. 51.

*continued*

**Cavaller.** Baseboard: 800 w, 4'x6"x2¼", surface temperature held to 125F. For full data circle No. 11. Wall panel: 1250 to 2000 w, 20½"x 15 9/16"x3¾" and 19¾"x11¼"x3¾". For full data circle No. 52.

**Ceilheat.** Baseboard: 500 to 2000 w, 32" to 10' long x 6½"x2½"; receptacles, raceway for wiring. For full data circle No. 12. Wall panel: 1500 to 3000 w, 20½"x16"x5" and 18¾"x10¾" bathroom unit. Other models 750 to 6000 w. For full data circle No. 53.

**Continental Glassheat.** Baseboard: Radiant glass element, 750 w, 4'x 9¾"x2¼-1¾". For full data circle No. 13. Wall panel: Radiant glass element, 625 to 1000 w; surfaced or recessed mounted. For full data circle No. 55.

**Electrilliving.** Baseboard: Radiant quartz elements, 400 w, 4'x3¾"x 2½", very small and inconspicuous. For full data circle No. 14.

**Electrend.** Wall panel: Built-in, forced-air wall stack, openings at floor and ceiling. 1600 to 4000 w. Also 1250 w panels. For full data circle No. 57.

**Electromode.** Baseboard: 600 to 1200 w, 32" and up x8½"x3"; base receptacles. For full data circle No. 15. Wall panels: Aluminum elements, 1320 to 4000 w, 11½"x12¾" and 21"x17". For full data circle No. 58.

**Electro-Products.** Baseboard: 750 to 2750 w; 4', 6', 12'x5¾"x17½"; also 4' to 10'x7¾"x2½". For full data circle No. 16.

**Emerson.** Baseboard: New line of units 750 to 1500 w, 3' to 6'x7"x2". Very clean lines. For full data circle No. 18. Wall panel: Insert heaters, 1500 to 4000 w. For full data circle No. 60.

**General Electric.** Wall panel: Fan-driven insert heaters, 750 to 4000 w, 14"x12" and 22¾"x16¾". For full data circle No. 62.

**Hunter Div, Robbins & Myers.** Baseboard: 1000 to 2000 w, forced air with fan, 33"x13"x3¾", recessed unit. Also 530 to 800 w, 3' to 4'x 6"x2". For full data circle No. 20. Wall panels: 1500 to 4000 w, 17¾"x 8½" and 20¼"x9¾" to 29". For full data circle No. 63.

**Ilg.** Baseboard: 100 to 250 w per ft; 2' to 8'x8¾"x2½". For full data circle No. 21. Wall panel: Forced-air recessed unit, 2000 to 4000 w; 22¾"x16¾"x1½". For full data circle No. 64.

**International Oil Burner.** Baseboard: 750 to 2000 w, 4' to 11'x10"x3¼"; unit has sealed hot water to store heat, provide low-temperature transfer. For full data circle No. 22.

**Markel.** Baseboard: 500 to 3000 w, 2' to 8'x8½"x2¾". Rug can go under unit. For full data circle No. 23. Wall panel: 1000 to 5000 w, radiant and forced-air types; also for ceiling installation. For full data circle No. 65.

**Thermador.** Baseboard: 1000 to 3000 w, 4½' to 10'x7¼"x3¼". Baseboard receptacles. For full data circle No. 28. Wall panel: Units from 1000 to 4500 w; radiant convection or forced air types. Radiant ceiling fan heater is 1250 w. For full data circle No. 70.

**Trade-Wind.** Wall panel: Insert heaters 1000 to 1650 w, 45"x6¾" and 15"x10¼". For full data circle No. 71.

**Vulcan.** Baseboard: 500 to 3500 w, 3'x9¼"x2½". For full data circle No. 29.

**Wesix.** Baseboard: 667 to 1000 w, 2½' to 4'x6¾"x2½"; can take a/c supply section. Also floor inserts, 1250 to 3000 w, 3' to 4½'. For full data circle No. 30. Wall panel: Models range from 1000 to 8000 w; forced-air and radiant-convection types. For full data circle No. 72.

**Westinghouse.** Baseboard: 500 to 1500 w, various lengths, 7"x2½". For full data circle No. 31. Wall panels: 1500 to 3000 w, 20"x10¾"x 3¾" and 20½"x16½"x3¾". Other models from 1000 to 6000 w. For full data circle No. 73.

**Wiegand.** Baseboard: 100 to 1250 w, various lengths, 8¾"x2½". Insert floor units 350 to 750 w, 4"x30". For full data circle No. 32. Wall panels: Forced-air, radiant, and convection types. 500 to 4000 w. Also wall panel at 800 to 18,000 w. For full data circle No. 74.

**Zell-Aire.** Wall panel: Infra-red units 750 to 1500 w. All models recessed or surface-mounted. For full data circle No. 75.

## Ceiling cable for low-temperature resistance heating

Ceiling cable comes in various lengths that are rated in watts and fabricated with non-heating leads. You *cannot* cut up the lengths. There are only minor differences in the cable made

by eight manufacturers. All cable has roughly the same type of metal conductors, the same type of insulation, and the same installation procedures.

## Heat pumps

Unless otherwise noted, all heat pumps are single-package units with four-way valves and automatic defrost cycles. They are also air-to-air, unless otherwise noted, since water is too expensive or undependable to use for heat pumps in many parts of the US.

**Carrier.** New 2-hp compact package unit. Weathermaker can be mounted inside or outside or through the wall. Supplementary heating. For full data circle No. 94.

**Chrysler Airtemp.** 3-hp unit and new 5-hp split unit (condenser is outside). For full data circle No. 95.

**Emerson Electric.** Northwind Reversible 1- and 2-hp package units for through-wall mounting. This is a completely new line and features a decorative grille work on the inside face. For full data circle No. 96.

**Fedders-Quigan.** New 3-hp Adaptomatic package unit can be installed any place in house, outside or through the wall. For full data circle No. 97.

**Frigidaire.** 2- and 5-hp split units. Automatic defrost is optional. For full data circle No. 99.

**General Air Conditioning.** Split and single package units from 2- to 15-hp; supplementary resistance supplied with pumps. For full data circle No. 100.

**General Electric.** 2- to 5-hp Weathertron package units. Supplementary heat in indoor supply duct. Usually installed outside or through the wall. For full data circle No. 101.

## Central heating units

The three products at right use electric resistance coils instead of gas or oil to provide heat in a central furnace or boiler. They make sense in areas where electric rates are very low. A factor to consider: the radiant heat thrown off by these units is used up in the furnace or boiler room—only indirectly heats the rest of the house.

**Gibson.** 1- and 5-hp package unit, through-wall or outside installation. Supplementary heat available, 8 and 16 kw. For full data circle No. 102.

**Lennox Industries.** 3-hp split unit heat pump. Unit is the latest addition to the Landmark line. For full data circle No. 104.

**Mathes.** Package units, 2- to 5-hp; split units 2- to 10-hp. For full data circle No. 105.

**Mueller Climatrol Div of Worthington.** 3- and 4-hp units for through-wall or outside installation. Supplementary heat available. For full data circle No. 106.

**Peerless.** 3- to 5-hp split, or remote, type units. 5 kw supplementary heat in each unit. For full data circle No. 107.

**Revco.** New Reversamatic 2- to 5-hp split units, for outside or through-wall installation. For full data circle No. 109.

**O.A. Sutton.** 2- to 5-hp package units, for outside or through-wall installation. Supplementary heat by others. For full data circle No. 110.

**Typhoon Heat Pump.** 3- to 10-hp air-to-air units plus full lines of water-to-air and water-to-water for installation inside or outside the house. For full data circle No. 111.

**Westinghouse.** 3-, 7½-hp split units. 10 and 12 kw supplementary heat built into 3- and 7½-hp units respectively. For full data circle No. 113.

**York Corp.** 3-hp split unit; 10 kw supplementary heat in unit. For full data circle No. 114.

**Lennox Industries.** New electric furnace in warm-air line; 20-36 kw (68,300 to 123,000 Btuhr). For full data circle No. 127.

**Majestic.** Furnace; 12-24 kw (41,000 to 82,000 Btuhr). 63"x30"x26". For full data circle No. 128.

**Electro-Temp.** Boiler for use where low night rates permit storage of hot water for heating. For full data circle No. 129.

You can get more information on any of the products listed above by circling the product coupon numbers on p 269. /END

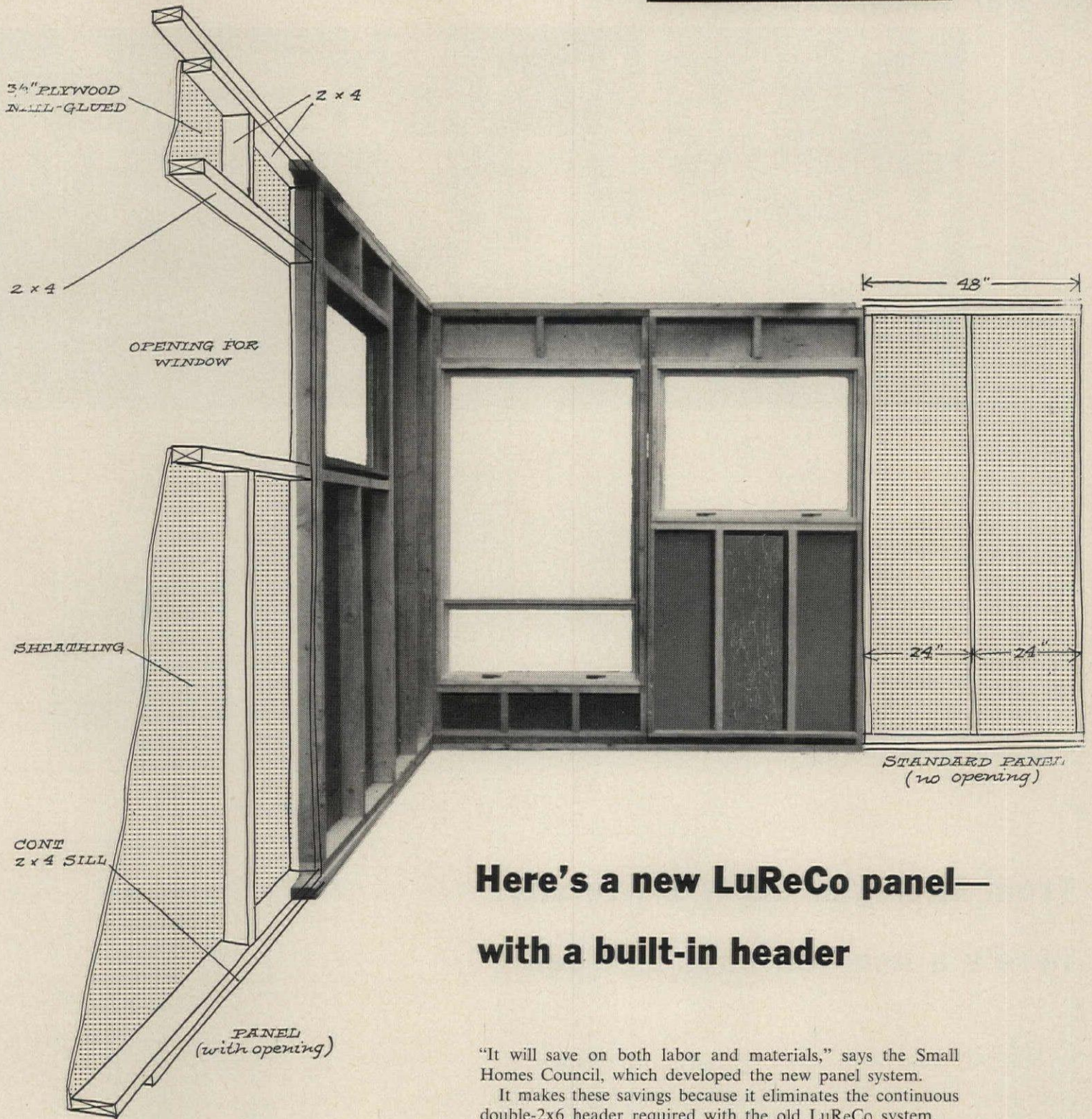

## Here's a new LuReCo panel— with a built-in header

"It will save on both labor and materials," says the Small Homes Council, which developed the new panel system.

It makes these savings because it eliminates the continuous double-2x6 header required with the old LuReCo system.

In the new system (based on the use of roof trusses 24" oc bearing directly over studs), panels with a door or window opening have a 3/8" plywood gusset nail-glued between the top 2x4 of the panel and the 2x4 rough head for the opening (see drawing, above left). This gusset must be at least 12" deep. A 2x4 stiffener is used in the center of this built-up header.

SHC recommends that plenty of casein glue be used at joints between plywood and the 2x4s—enough to give ample "squeeze-out." Nails should be 4d common nails, 4" oc. Plywood should be C-D grade or better, unsanded.

Solid panels require no header, are built with 2x4 studs 24" oc.

Adjacent panels are tied together by a 2x4 top plate laid flat.

To provide a flush nailing surface for the siding over the 3/8" gusset (which is 3/8" below 1" face of the sheathing), 5/8" strips are tacked to the plywood (see detail at left).

SHC reports that, as of February 1, FHA has not had the opportunity to approve this new panel.

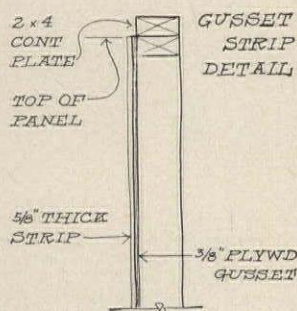

continued

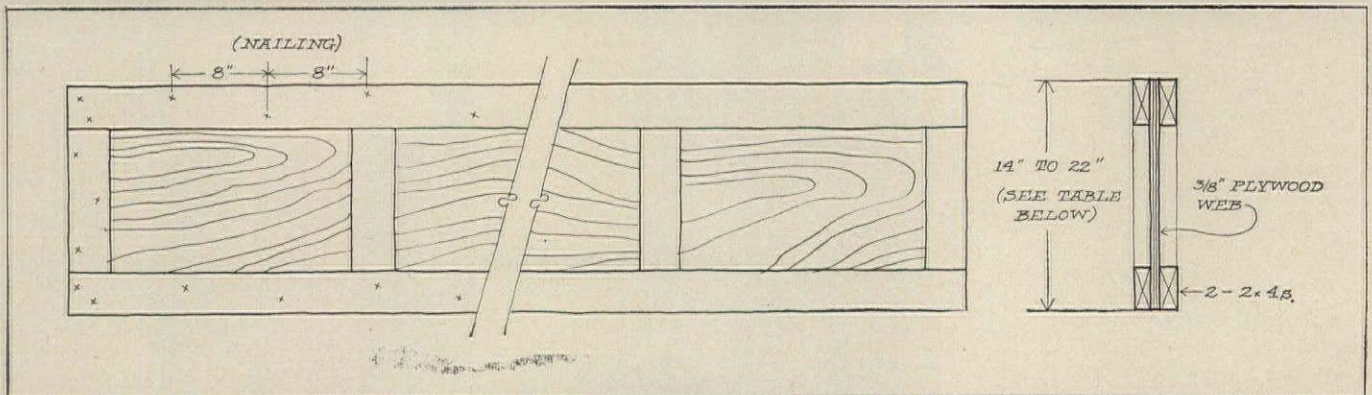
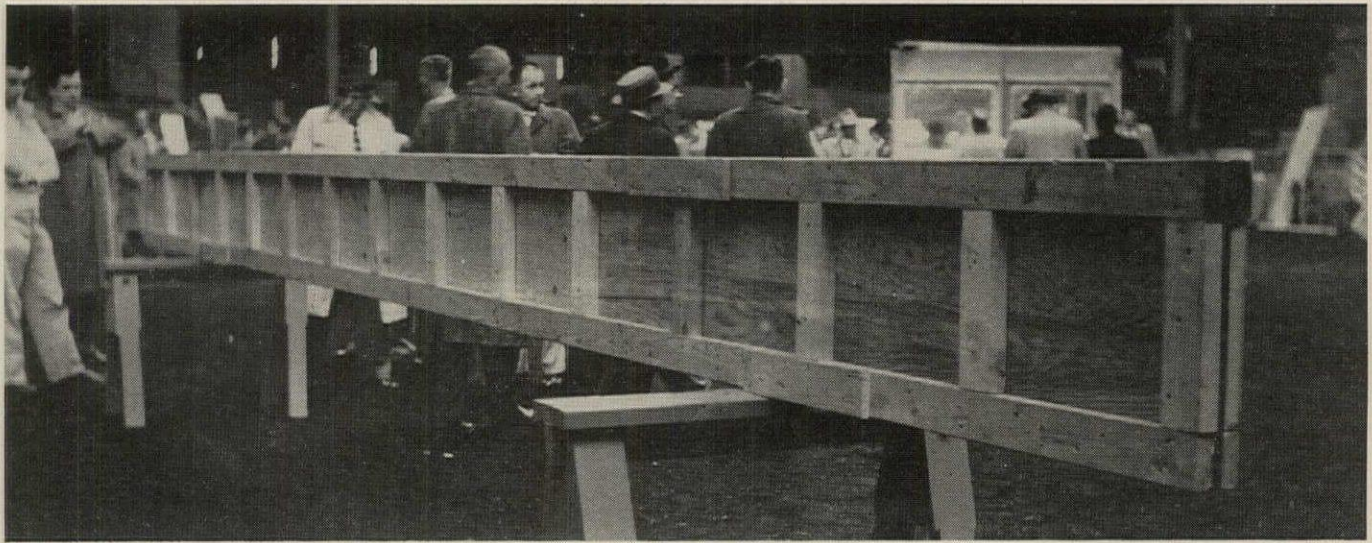

**LIGHT, STRONG BEAM** can be used over long spans in many applications: over garage doors, as central support for floors, as ridge beams.

## From Michigan State University: here's a new low-cost box beam

It is made of 2x4s and 3/8" plywood, nail-glued from one side.

It was designed by Byron Radcliffe of Michigan State, who reports that a prototype beam (similar but smaller than this beam) does the same job as a steel beam weighing three times as much, costing twice as much.

Here are the specifications (see drawing above): The 2x4s must be structural-grade Douglas fir; or hemlock or Southern pine of comparable grade. The plywood must be C-D grade or better, unsanded. The glue recommended is casein or cold-setting phenol resorcinol. Nails must be 16d common, 8" oc.

Joints in web or flanges need special attention. Plywood web joints must fall under a vertical stiffener, but not at a joint in the 2x4 flanges. To splice the flanges, 1x4 (solid) scabs are nail-glued over the joint.

And Radcliffe cautions that while the center web panels can be cut out to let ducts pass through, the panels toward each end cannot be cut without seriously weakening the beam.

A jig table would speed fabrication of the beam, insure accuracy, Radcliffe points out.

More information on this beam is available from the Small Homes Council, University of Illinois, Urbana. Write for *Proceedings of the 14th Annual Short Course*, \$2.50.

**Depth-spacing-span table for beam**

Beam depth (in inches)	Beam spacing (in ft oc)	Span (in ft) with beam simply supported				
		12	16	20	24	28
14	2	384	179	92	54	34
	4	192	90	46	27	
	8	96	45	23		
15	2	215	110	64	40	
	4	107	55	32		
	8	54	28			
16	2	252	129	75	47	
	4	126	65	37	23	
	8	63	32			
17	2	288	150	87		
	4	141	75	43		
	8	72	38	22		
18	2		174	100	64	
	4		87	50	32	
	8		43	25		
19	2		198	115	72	
	4		99	57	36	
	8		50	29		
20	2		224	129	81	
	4		112	65	41	
	8		56	32		
21	2		231	146	91	
	4		115	73	46	
	8		57	36	23	
22	2			162	102	
	4			81	51	
	8			41	26	

\*Limit of deflection: span/360

**STRENGTH CHARACTERISTICS** of beams of various section depths at various spans is shown in table condensed from more detailed table available from Prof Radcliffe, Michigan State Univ, Lansing.



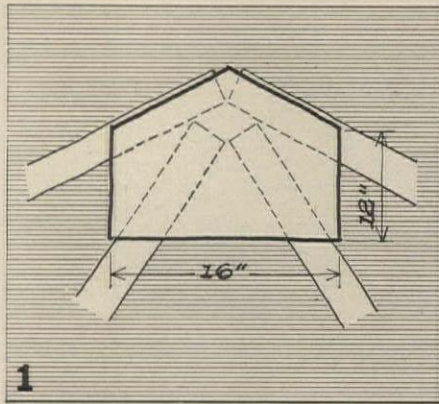

**1**  
**PEAK JOINT GUSSET** of  $\frac{3}{8}$ " plywood is nail-glued to both sides of truss. It replaces the 1x4 scab of solid wood which was formerly recommended by SHC.

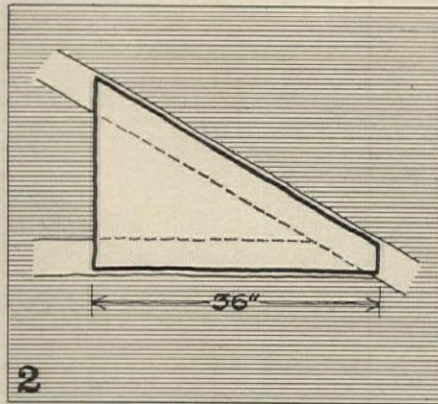

**2**  
**BEVELED BOTTOM CHORD** lowers roof line of house, can simplify trim and finish. Large gusset plates shown are  $\frac{3}{8}$ " plywood both sides.  $\frac{1}{2}$ " plywood gussets are also possible.

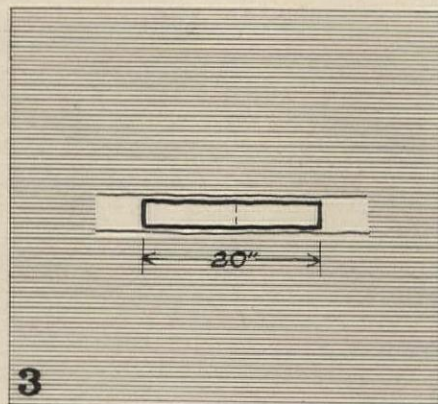

**3**  
**NARROW SPLICE JOINT** of  $\frac{1}{2}$ " plywood nail-glued both sides replaces 1x4 solid wood splice plates. If  $\frac{3}{8}$ " plywood is used, detail 4 (below) must be used.

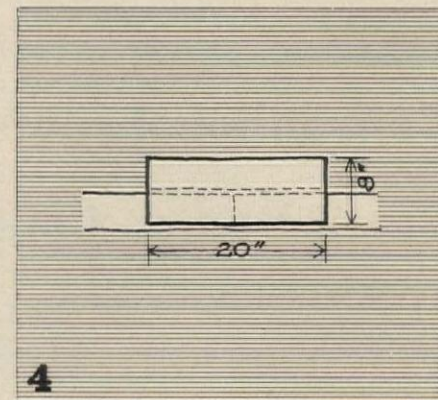
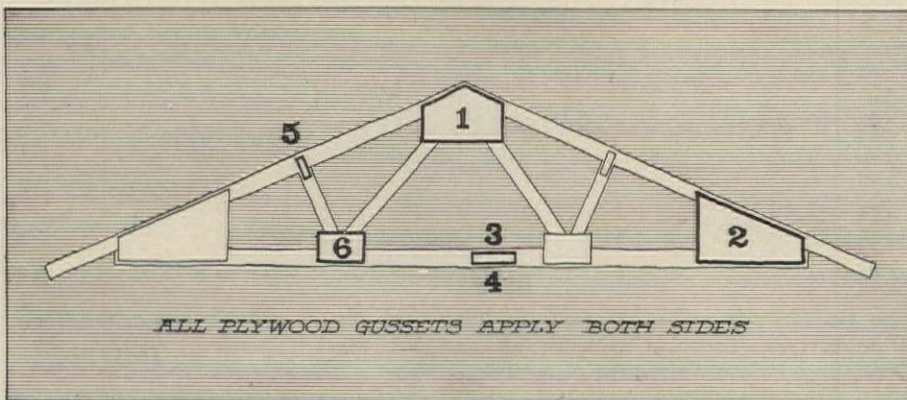

**4**  
**BROAD SPLICE JOINT** is required if  $\frac{3}{8}$ " plywood splice plates are used. Stiffener above the bottom chord is a 2x4 20" long, nail-glued to splice plates.

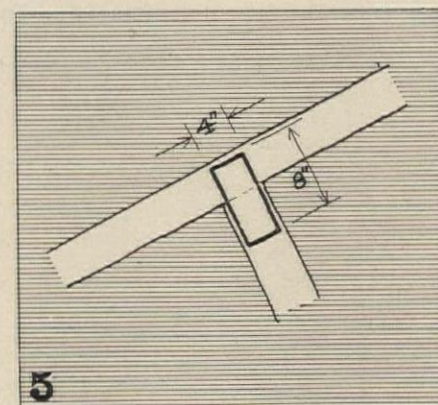

**5**  
**TOP-CHORD SCAB** of  $\frac{3}{8}$ " or  $\frac{1}{2}$ " plywood, nail-glued to both sides of truss replaces 1x4 solid scabs formerly recommended. Solid scab can still be used if preferred.

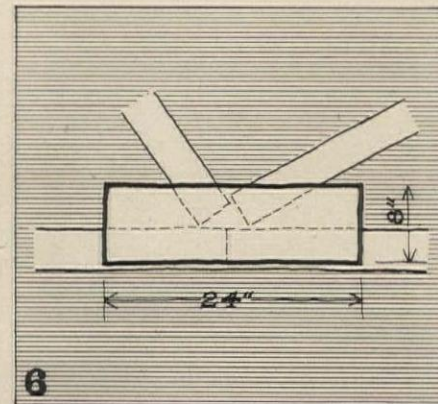

**6**  
**INTEGRAL SPLICE AND SCAB** eliminates separate splice if bottom-chord joint falls at intersection of cross members. Plywood gusset (above) is nail-glued to both sides of truss.

## Here are six new truss details just OK'd by Small Homes Council

All six shown on this page are *optional variations* on the standard Small Homes Councils nail-glued "W" roof truss.

Some—like variation 6—might save you money. Others—like variation 2—may speed construction in the field. And still others—like variation 1—may speed shop production of the truss. SHC suggests that anyone who uses trusses should study each variation, use as many as make sense for his particular operation.

These are SHC's specifications (in brief) for the truss:

**Lumber** must be No. 1 southern yellow pine (1500 psi stress grade) or specially selected western hemlock or construction grade Douglas fir with a 1500 psi stress grade for its entire length. Moisture content: 19% or less.

**Plywood** must be unsanded, with surface grain parallel to the bottom chord of the truss.

**Nails** must be 4d common with plywood gussets, 6d common with solid-wood splice plates. Staples  $1\frac{1}{8}$ " long may be used with the plywood gussets.

**Glue** must be casein. Urea formaldehyde and polyvinyl glues are not recommended.

**Cure** after fabrication must be 16 hours at temperatures between 50F and 70F; or eight hours at 70F or more.

For complete design data and full specifications, write the Small Homes Council.

*continued*

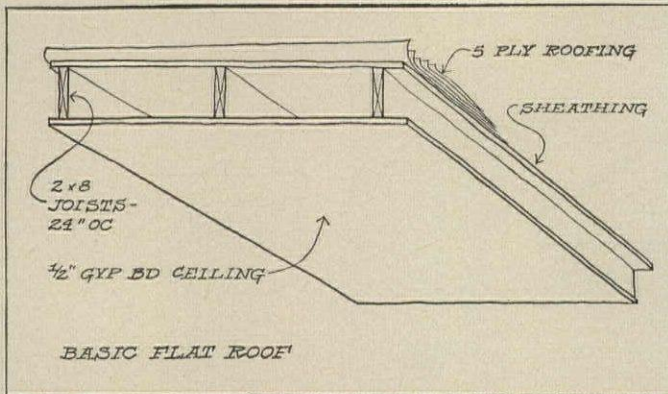

**CONVENTIONAL FLAT ROOF**, with 2x8 joists 24" oc, needs partition in center of house. Basic materials and labor costs for a 4' roof section spanning 24': \$97.

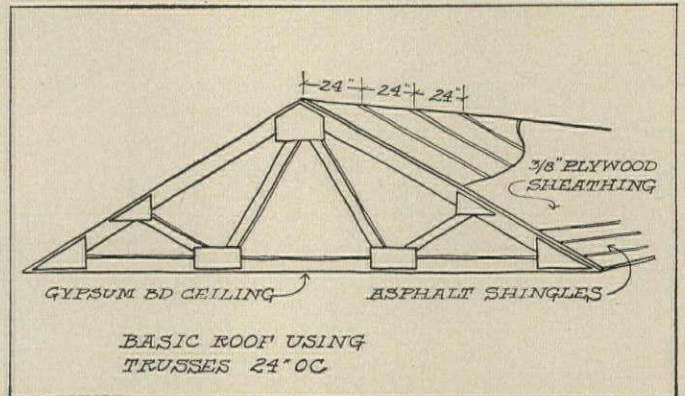

**CONVENTIONAL TRUSS ROOF** is cheaper than flat roof because sheathing can be thinner and asphalt shingles substituted for built-up roof. Materials and labor cost for 4' roof section spanning 24': \$87.

## Conventional roofs are still cheapest, Small Homes Council reports

This report is based on a SHC cost analysis of the two conventional roofs shown above, and the four newer types of roofs shown below.

Material and labor costs for some of the newer roofs are as low as material and labor costs for the conventional roofs. But with the new roofs, there are other cost factors (detailed in the captions) that bring the total installed cost

of the new roofs "above the cost of a conventional truss roof, and probably above the cost of a conventional flat roof," says SHC.

One of the newer roofs (stressed-skin panel) has labor and material costs as low as the cheapest conventional roof and looks like a strong bet to move into the "cheapest" category.

This study was sponsored by LuReCo.

### Here is the cost picture for four newer types of roofs:

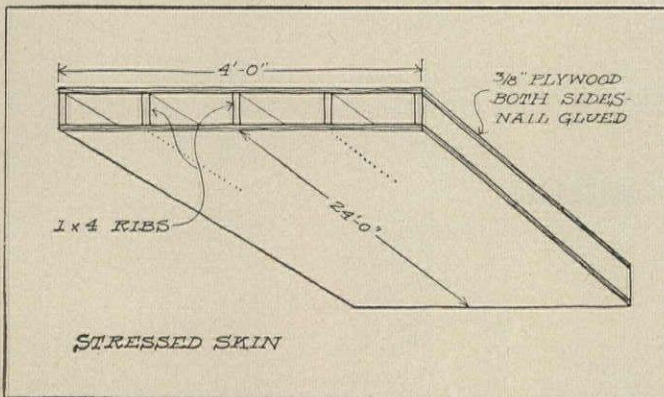

**STRESSED SKIN PANEL** has plywood nail-glued both sides in a press. Labor and material cost (comparable to conventional-roof figures) is \$87, but this must be increased to reflect cost of press.

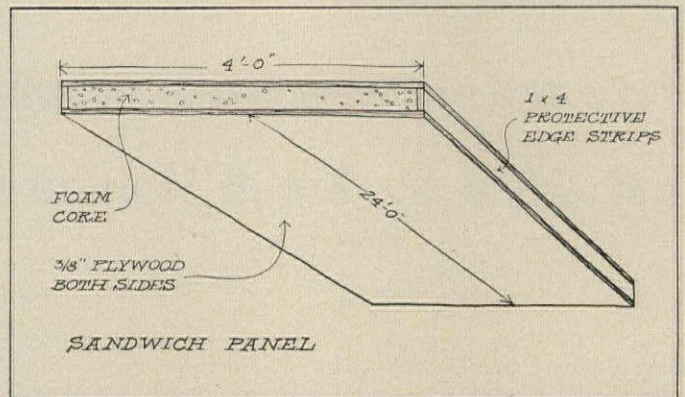

**SANDWICH PANEL** is self-insulating. A heavy press is required to bond foamed styrene core to the faces, and amortized cost of press must be added to labor and material cost of \$113.

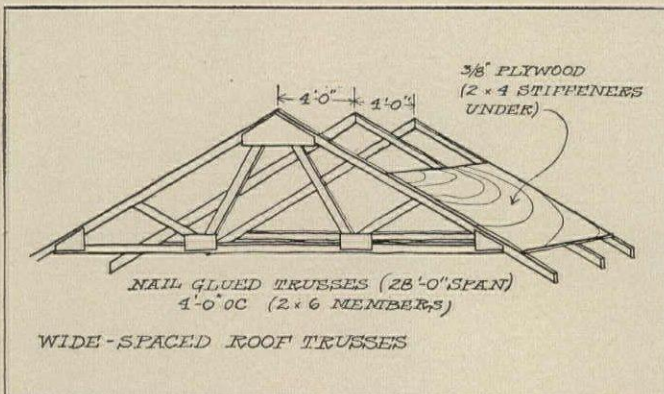

**WIDE-SPACED TRUSSES.** Roof has low material and labor cost (\$98), but presents problems in sheathing and ceiling installation. Both sheathing and gypsum board ceiling in this roof needed 2x4 stiffeners.

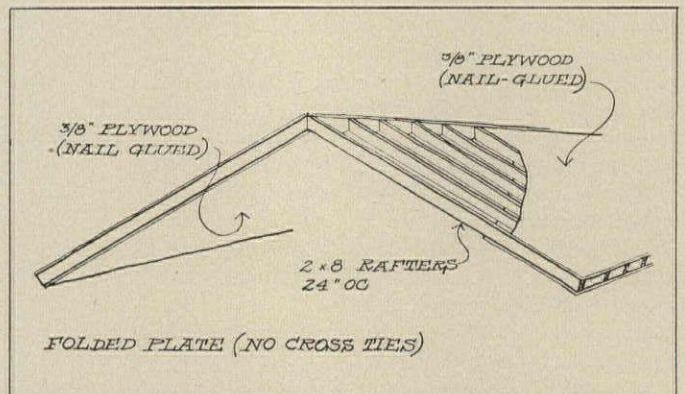

**FOLDED PLATE ROOF** also has a low labor and material cost (\$88), but requires extremely careful nailing, tedious on-site fabrication, carefully trimmed partitions to fit sloping ceiling.

more Technology on p 201



**FROM STREET**, the \$19,300 "Golden Estate" looks impressively large. Roof is built-up with rock topping, has trellised gable-end overhang.

## This house sold out—but buyers wanted more

Photos: Maynard Parker

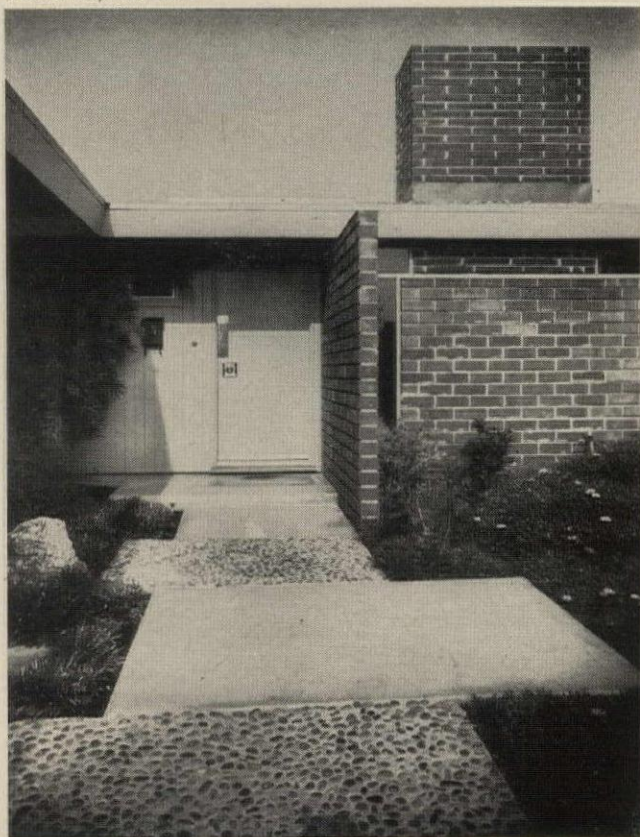

Builder Ross Cortese introduced this model last spring in one section of his big Rossmoor tract. Two months and 82 sales later, he hung up a **SOLD OUT** sign. Reason: the house was so popular he was worried about the problem of look-alike streets.

But buyers kept asking for this model. So he reopened it in a different section of the tract—and posted 30 more sales in 30 days. By February 1 of this year, he had sold a total of 207 of this model. Says Cortese: "We're going right on with this house—indefinitely!"

Cortese calls the house "middle-of-the-road-modern." But anywhere in the country except California (Cortese builds near Long Beach), this house would be labeled "very contemporary." It has trim lines, simple masses, and fits low to the ground. It appeals mostly to people who make over \$9,000 a year, Cortese reports.

While this is Cortese's best-selling model, it accounts for only a third of his sales. It won a NAHB design merit award this year. To see what impresses buyers inside the house—and for a look at the blueprints—*please turn the page.*

**FRONT DOOR** is at end of small entry court. Stepping stones are concrete, some smooth-finished, other set with pebbles.



**LIVING ROOM** (see a in plan for photo angle) is 26' long. Fireplace wall (see detail *p 187*) extends to include a sunken planter.

## Buyers like the big, open living area,



**DINING AREA** (b) off the living room opens the house to its full 24' width. Sliding glass doors, left, lead directly to rear yard.

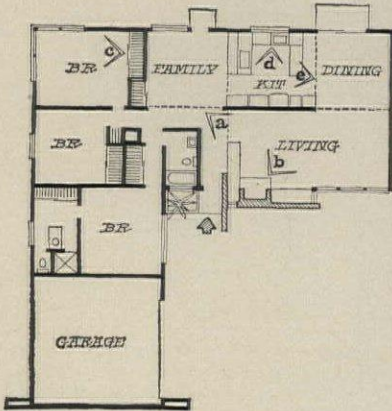

**PLAN** has 1600 sq ft of living area. There is a minimum of hall space, but no room is used as a corridor. Kitchen location rates high with buyers since it serves dining room or family room equally well. (See p 186 for more detailed plan.)



**BEDROOMS** (c) are all good sized. This one is 12' x 16', has raised ceiling, lots of glass.

**BUILDER:** Ross Cortese  
**ARCHITECTS:** Chris Choate and Robert G. Jones  
**LOCATION:** Los Alamitos, Calif.  
**PRICE:** \$19,300

## the big bedrooms, and the luxury kitchen



**KITCHEN** (d, above and e, right) gets even light from luminous ceiling (see detail p 187) set above wood grids. Cabinets are panelled and finished like fine furniture. Counter divides kitchen and family room (see right).



For blueprint turn the page

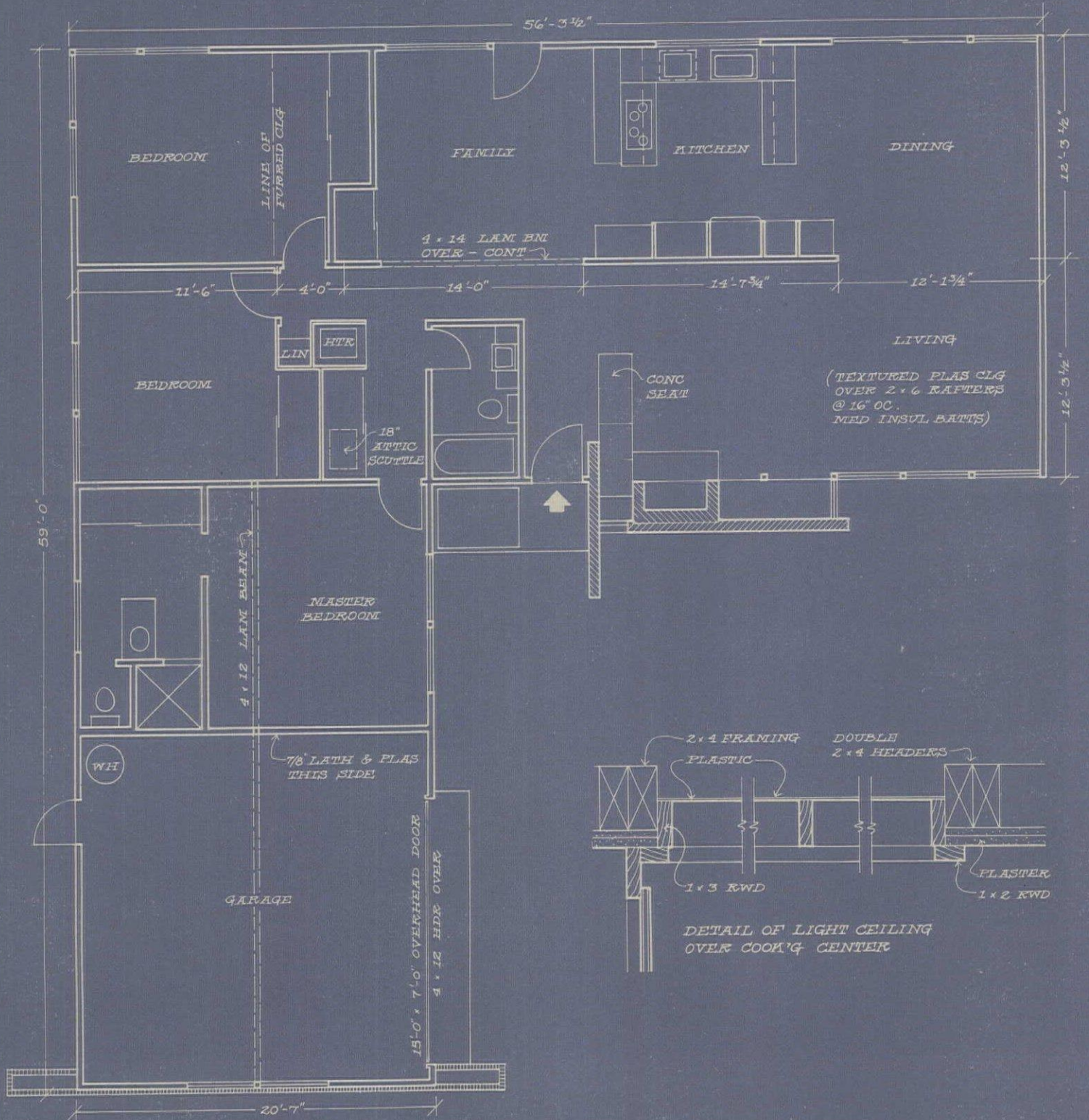
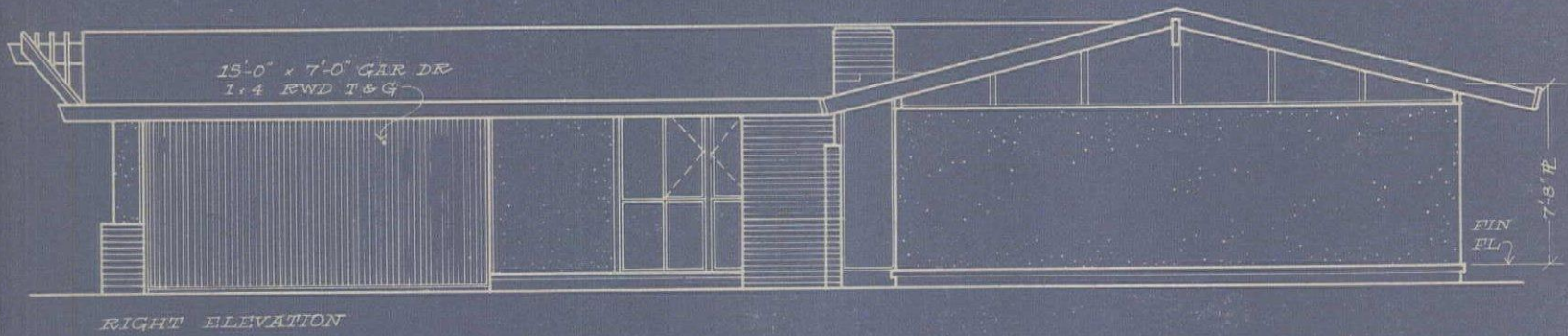
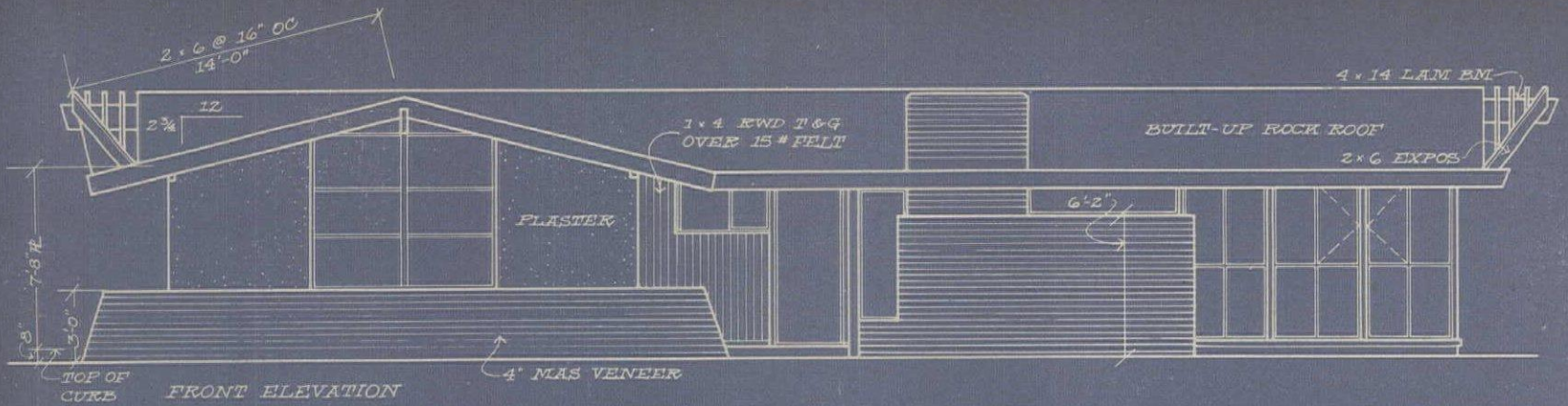

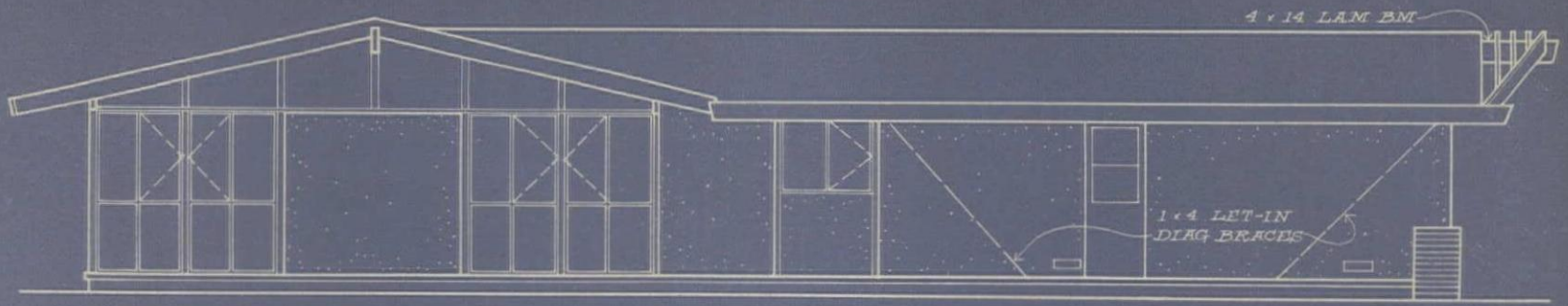

LEFT ELEVATION

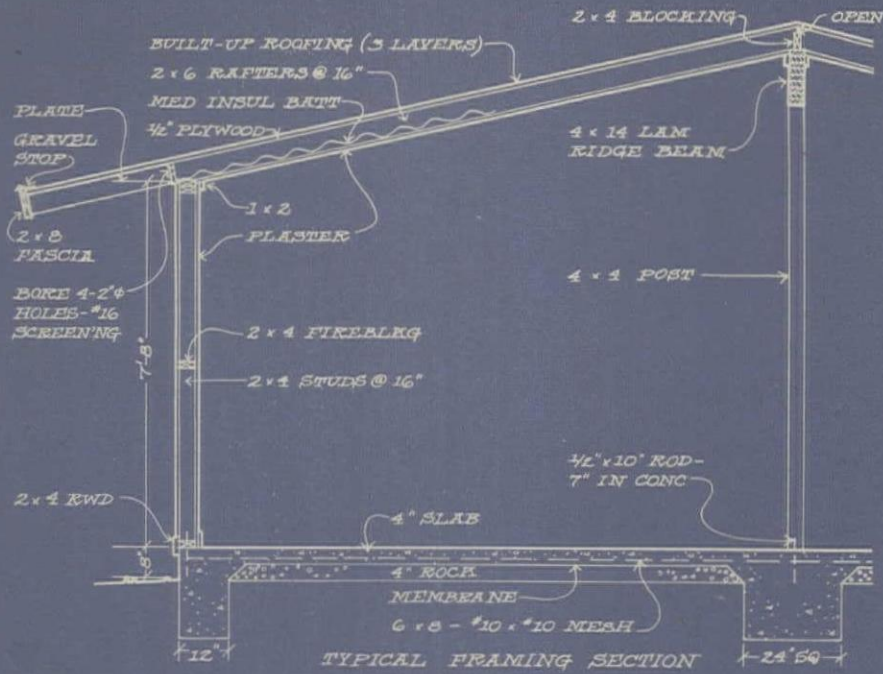

TYPICAL FRAMING SECTION

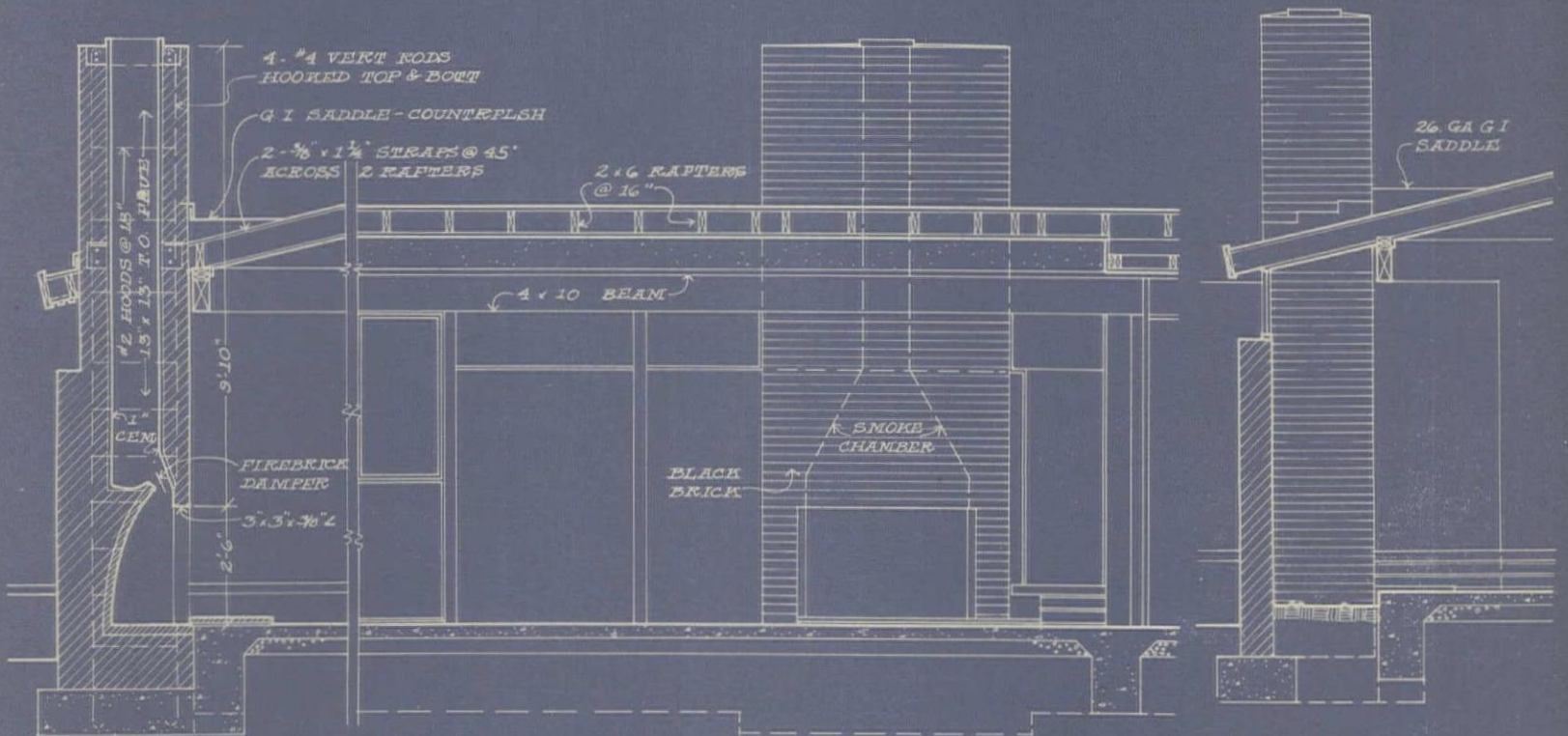

FIREPLACE DETAILS

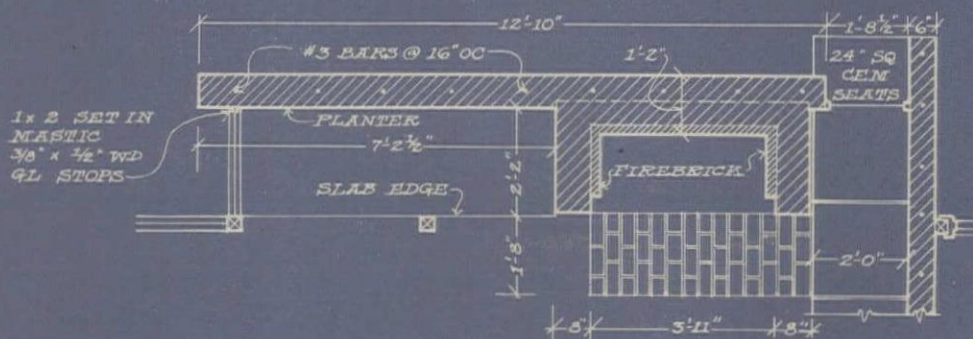

SELECTED DETAILS FROM HOUSE IN LOS ALAMITOS, CALIF  
 CHOATE & JONES : ARCHITECTS  
 ROSS CORTESE : BUILDER

**In Electric heat thermostats . . .**

# **WHITE-RODGERS IS THE LEADER**

More manufacturers of electric heating equipment put their brand names on White-Rodgers thermostats than on all others. Striking design and silent, reliable operation are but two of many good reasons. If you use, install or specify electric heating, get the *complete* story from this new full-color folder.

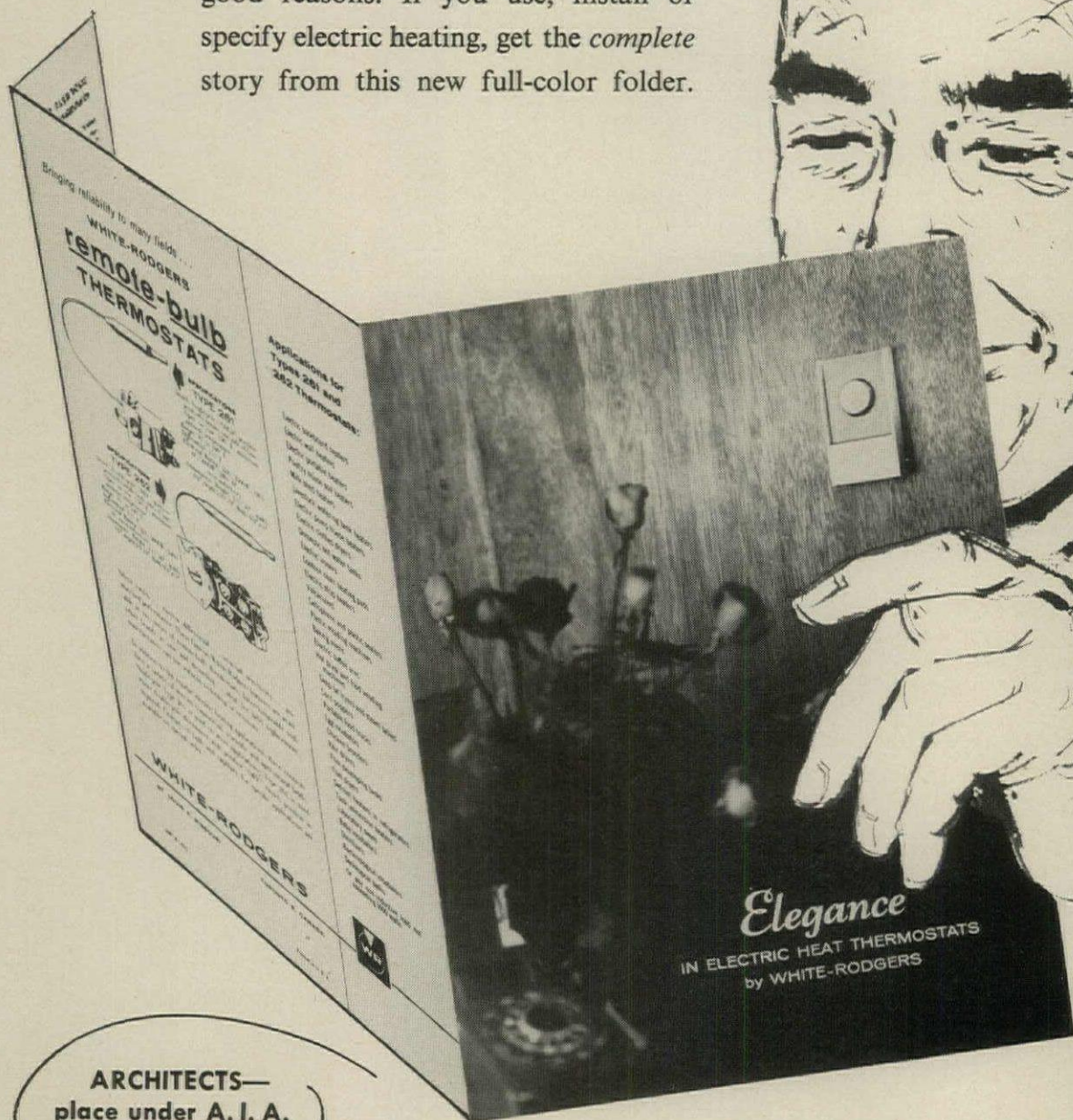

**ARCHITECTS—**  
place under A. I. A.  
File No. 30-E

**WRITE OR PHONE TODAY FOR THIS  
DESCRIPTIVE FOLDER No. R-1625**

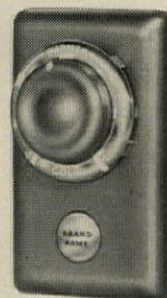

**1A61**

The world's most  
widely used elec-  
tric heat thermostat.



## **WHITE-RODGERS**

ST. LOUIS 6, MISSOURI      TORONTO 8, CANADA

ADDRESS INQUIRIES TO 1219 CASS AVENUE, ST. LOUIS



Be sure to see

# NEW WAYS TO BUILD BETTER

A monthly report on home building ideas, products, and techniques

Starting here

## New products

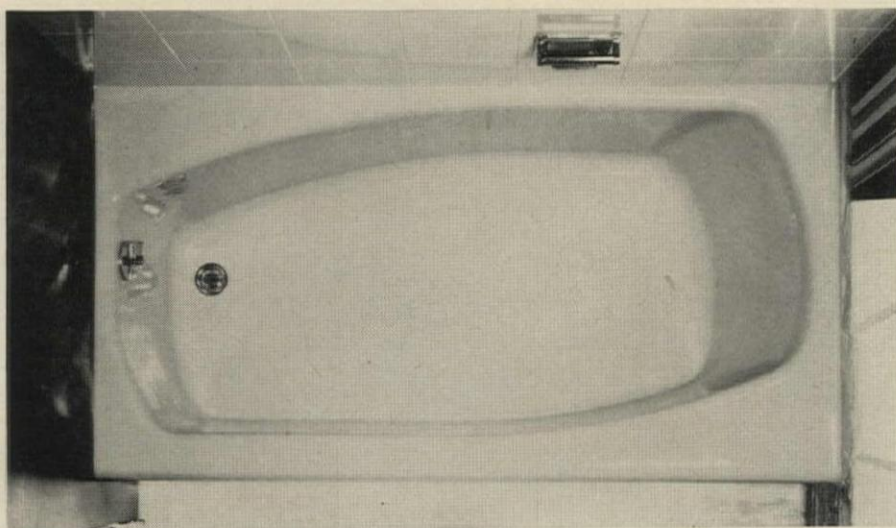

**New Contour tub** replaces 25-year-old Pembroke in A-S line. New tub is 32" deep to fit stud module, has straight apron to simplify tiling. Offset bathing area makes seat and shelf larger and

rim thin and easy to grasp, brings back edge in easy reach for cleaning. Bottom is flat for safety.

American-Standard, New York City.  
For details, check No. 1 on coupon, p 264



**Woodcharm cabinets** are the latest line from Youngstown. Doors and drawer fronts come in two wood, two laminate, and one steel finish, can be adapted to stock steel cases quickly by means of a spring-pin door hinge and a slide-on drawer fixture.

Youngstown Kitchens, Warren, Ohio.  
For details, check No. 2 on coupon, p 264



**Double electric oven** has 18" automatic oven, 16" lower oven, both with rod type bake and broil units. Control buzzes and cuts off heat when roast is done. Three-spit rotisserie and chrome door linings are standard. Modern Maid unit fits stock 24" cabinets.

Tenn. Stove Works, Chattanooga.  
For details, check No. 3 on coupon, p 264

And on the following pages

## Technology

A new and better way to vent your attic  
.. How to lick crawl space problems ...  
page 202

## What the leaders are doing

Plan your sales office to close sales ...  
Make your site sign a directional sign ...  
Get sales help from your suppliers ...  
page 206

## Publications

Two new aids to better color styling ...  
All you need to know about resilient flooring ... Where to use rigid plastic pipe ...  
page 256

## More New products

Sliding glass doors for every house ...  
New stoves, appliances, furnaces ...  
New styles in plastic panels ... Closers for gates, storm doors, sliding doors ...  
page 210

# SOLD!...157

Mr. R. A. Jaeger  
RCA Whirlpool  
12 E. 39th Street  
San Mateo, California

Dear Bob:

Our newest subdivision, WINDSOR PLACE, located at the end of Lewelling Boulevard in San Leandro, California recently set a new record (for this area at least) of 157 homes sold in a three and one half week period from date of opening.

We feel that the beautiful RCA Whirlpool appliances offered in our homes at WINDSOR enabled our sales organization to accomplish this. Home buyers today are looking for quality and a new, fresh look. We believe RCA Whirlpool appliances fill the bill perfectly.

Very truly yours,

Tom & Ed Bevilacqua  
Bevilacqua Homes  
2200 East 14th Street  
San Leandro, California

## You, too, can sell more



# HOMES IN 25 DAYS!

Tom and Ed Bevilacqua use the merchandising power of RCA WHIRLPOOL appliances to set a new sales record!



These two energetic young builders recently completed the most successful subdivision ever developed in the San Leandro, California area. Before building, they decided they not only needed the finest, most modern building materials, techniques and design . . . but that each kitchen had to be outstanding. Each appliance had to have maximum ease and flexibility in installation . . . the most modern automatic features and the quality and beauty women demand. Of all brands considered, they selected RCA WHIRLPOOL. Read at left, in their own words, just *how much* RCA WHIRLPOOL appliances helped them sell an amazing total of 157 homes in just 25 days.

## with Whirlpool kitchens

everything for modern kitchens with one brand name

Only the RCA WHIRLPOOL brand offers you a complete, correlated line of appliances including built-in and free-standing models in *both* gas and electric . . . plus every type of cabinet in wood and steel or all steel. And, most important to you, each appliance is available from one supplier with undivided responsibility . . . a supplier

ready, and more than willing, to give you expert planning assistance plus fast delivery!

Just as important, you'll have appliances with one brand name nationally-known for quality performance . . . wanted for dependable service, and bought with complete confidence . . . RCA WHIRLPOOL.

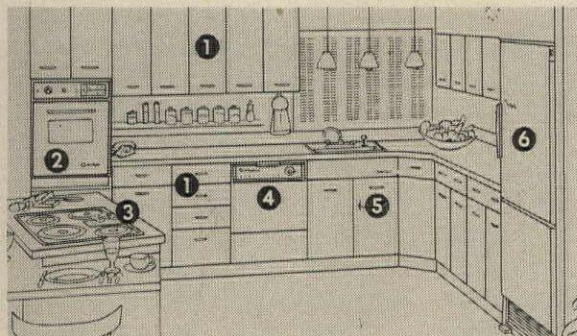

(1) "Select-A-Door"\* wall and base cabinets (2) Built-in gas and electric ovens (3) Built-in gas and electric cooking tops (4) Dishwashers (5) Disposers (6) Gas and electric refrigerator-freezers . . . plus automatic washers, gas and electric dryers, gas and electric washer-dryers, air conditioners, combination range-sink tops.

### Mail coupon for complete information!

Contract Sales Division  
Whirlpool Corporation, St. Joseph, Michigan

Please send me complete information on the new RCA WHIRLPOOL kitchens and appliances.

NAME \_\_\_\_\_ TITLE \_\_\_\_\_

FIRM NAME \_\_\_\_\_

FIRM ADDRESS \_\_\_\_\_

CITY \_\_\_\_\_ ZONE \_\_\_\_\_

STATE \_\_\_\_\_

HH-3

RCA WHIRLPOOL...America's first family of home appliances Products of WHIRLPOOL CORPORATION St. Joseph, Michigan

**For the package deal at a package price...it's RCA WHIRLPOOL**

\*Tmk. Use of trademarks  and RCA authorized by trademark owner Radio Corporation of America

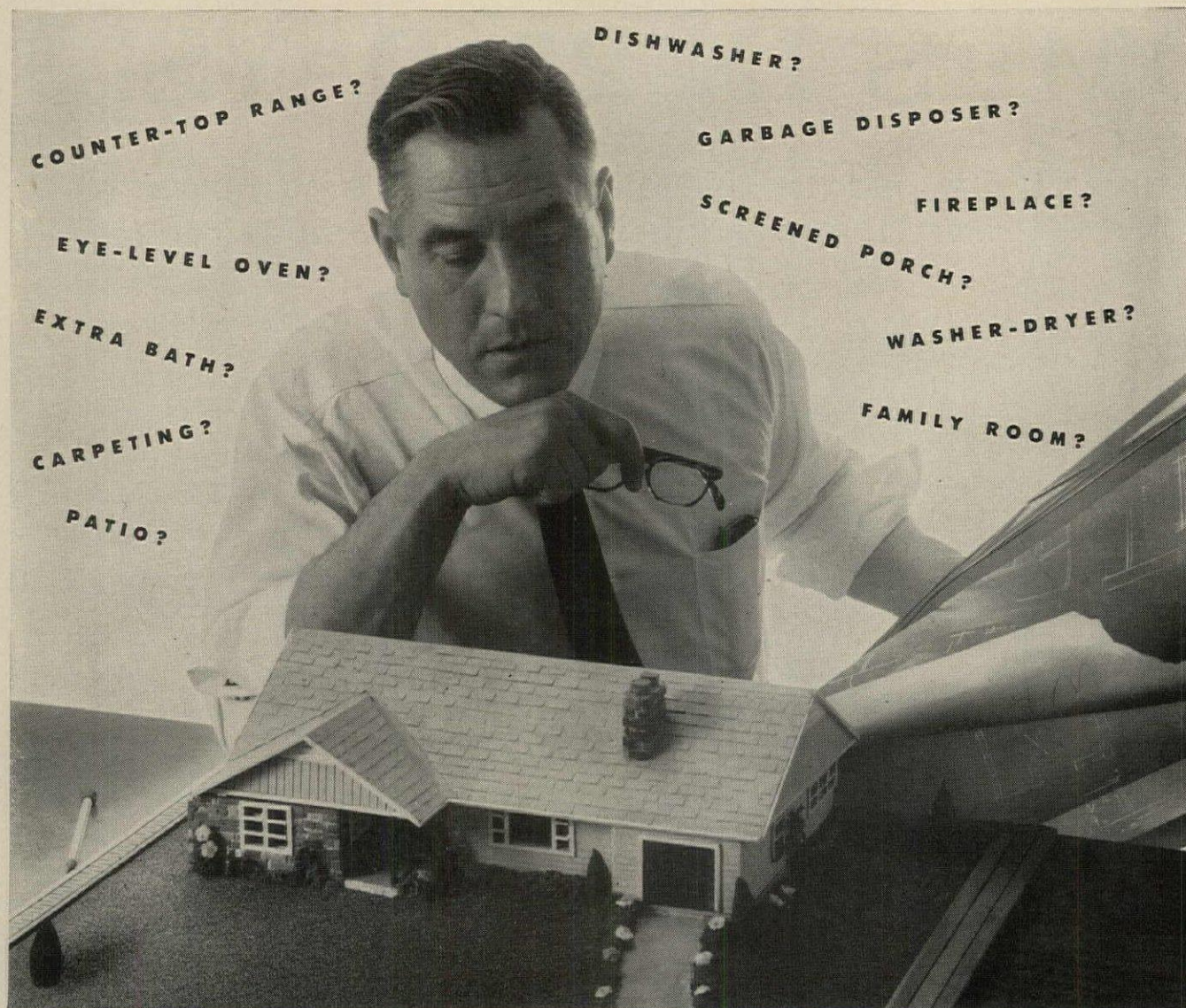

... a Crawford Door gives you the  
**"extra selling edge" you've been looking for**

Time was when building a saleable house was largely a matter of pleasing design, quality construction and convenient location at a reasonable price.

You, the builder, competing for *today's* home buyer's dollar must consider additional features to attract the customer's interest and to provide yourself with that "extra selling edge."

The question is—what can you add that will not raise your selling price too high?

There is *one* answer you may have overlooked... feature a sales appealing, handsome, home-enhancing *quality* garage door. Fact is, you *should* if the garage faces the street.

A strikingly designed, distinctively styled, perhaps even tastefully "customized" Crawford garage door can materially add to the architectural beauty of your home and its customer appeal—with little additional cost.

Point is, a Crawford door, with its luxury-look, individuality and ease of operation, provides the "extra selling edge" you've been looking for. And if you'd like an additional "tie-breaker" you might consider a Delco-matic garage door operator. Ask your Crawford Distributor about it when you call him.

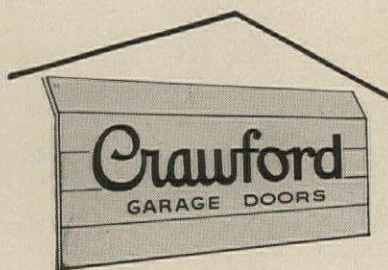

**CRAWFORD DOOR COMPANY**

215-20263 HOOVER ROAD • DETROIT 5, MICHIGAN

# SPOTNAILS MEET F. H. A. STANDARDS

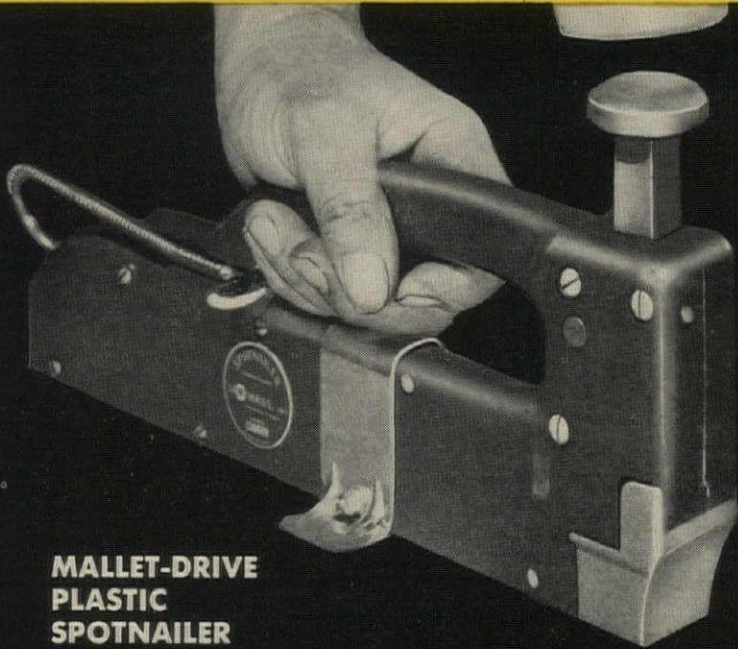

**MALLET-DRIVE  
PLASTIC  
SPOTNAILER**

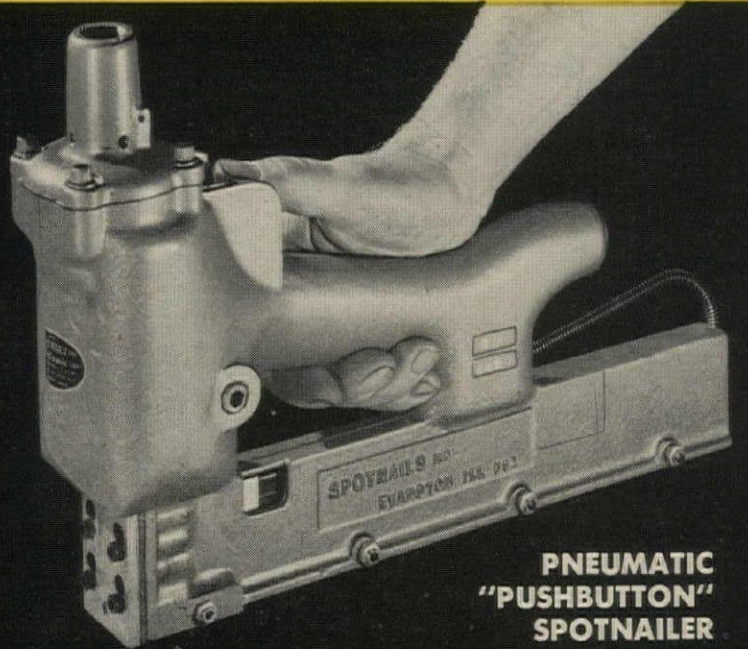

**PNEUMATIC  
"PUSHBUTTON"  
SPOTNAILER**

Here is a new experience! 2 men carry material to point of use. One man "Spotnails" the pieces in place so fast 2 men can't keep up. Spotnailers drive fasteners up to two inches long—3 per second—without operator fatigue. You can set up an on-the-spot production line on every job.

## NOW...

**Increase Production and Reduce Net Costs  
with Heavy Duty Galvanized Spotstaples**

**BOOKLET  
GIVES  
NEW  
F.H.A.  
STANDARDS**



**Write For  
Free Copy** →

**SHEATHING**  
Plywood, fiber-board or gypsum 3 to 5 times faster.

**UNDERLAYMENT**  
(Hardwood or Plywood)  
Over 1 million floors installed without a "back-out" complaint.

**ASPHALT ROOF SHINGLES**  
One hand positions shingles, one hand drives Spotstaples with the touch of a button.

**SUBFLOORS**  
Spotnailed as fast as plywood sheets can be laid across the joists.

**PLYWOOD ROOF SHEATHING**  
2 men carry, one man Spotnails an entire roof in 3 hours.

**GYPSUM LATH (All Types) AND DRYWALL (First Ply Only of 2-Ply System)**

# SPOTNAILS, INC.

EVANSTON, ILLINOIS

# "I've been buying American Welded Wire Fabric for 24 years,"

**says Mr. Marty Sinnema, Cleveland, Ohio, cement contractor**

"I have been in the cement contracting business for over 36 years. Since 1934, when I started my own business, I have always bought American Welded Wire Fabric. With American Welded Wire Fabric, I am sure of the results on every job because I know it's the most reliable concrete reinforcement on the market.

"Many of my original jobs are still as smooth and crack-free as the day I put them in. I have found that installing *quality* reinforced concrete is the secret of keeping these jobs looking like new for so many years. As a result, not only have my customers been well satisfied, but they have recommended my work to their friends and business associates.

*USS and American are registered trademarks*

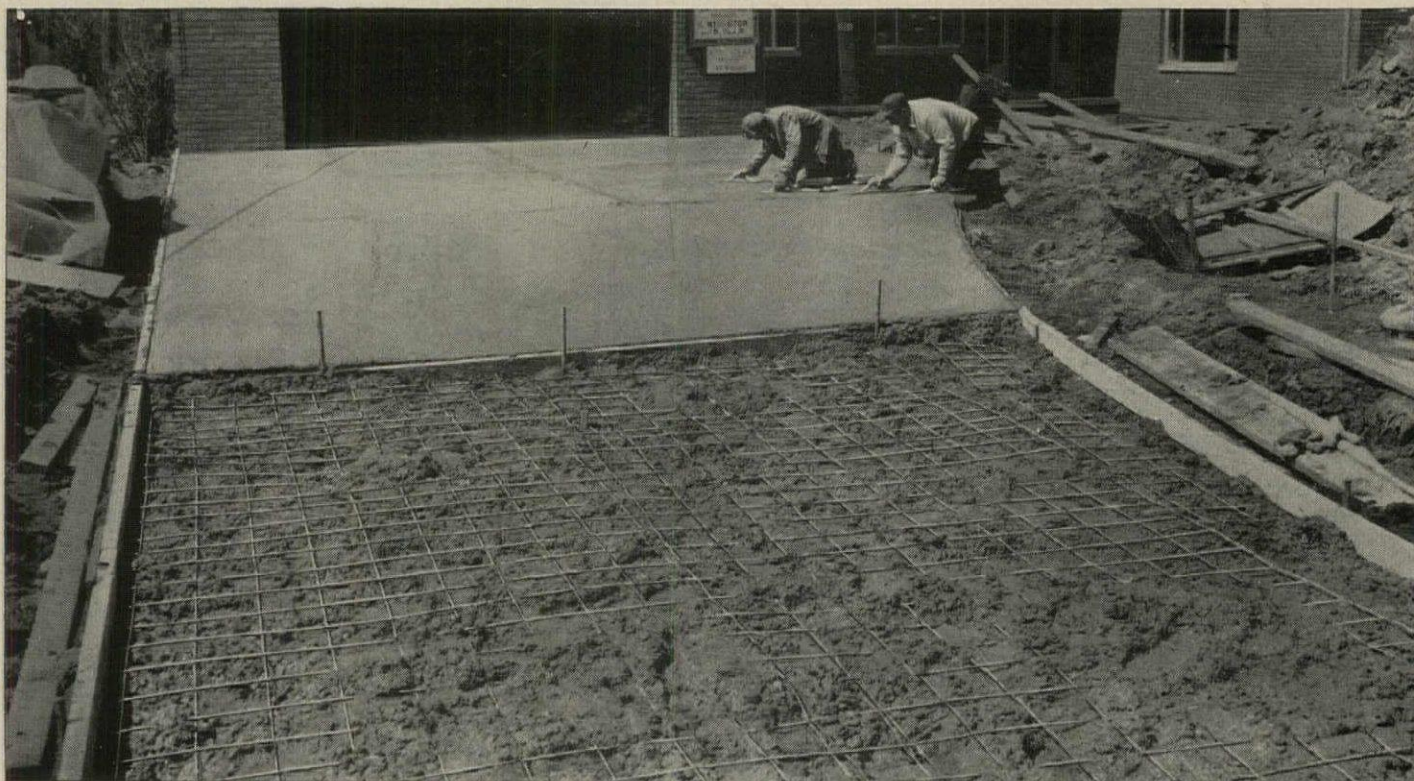



**Take a tip** from Marty Sinnema and insist on American Welded Wire Fabric when you need concrete reinforcement. It costs less to build a concrete slab with American Welded Wire Fabric, for it adds 30% to the strength of slab concrete. All concrete installations need the added strength and crack-resistance formed by the quality reinforcement of American Welded Wire Fabric. And remember, reinforcement cannot be added later. For more details, call our nearest office, or write to American Steel & Wire, 614 Superior Ave., N.W., Cleveland 13, Ohio.

Buyers will ask, *"is it Reinforced"*

**American Steel & Wire  
Division of**



**United States Steel**

Columbia-Geneva Steel Division, San Francisco, Pacific Coast Distributors - Tennessee Coal & Iron Division, Fairfield, Ala., Southern Distributors  
United States Steel Export Company, Distributors Abroad

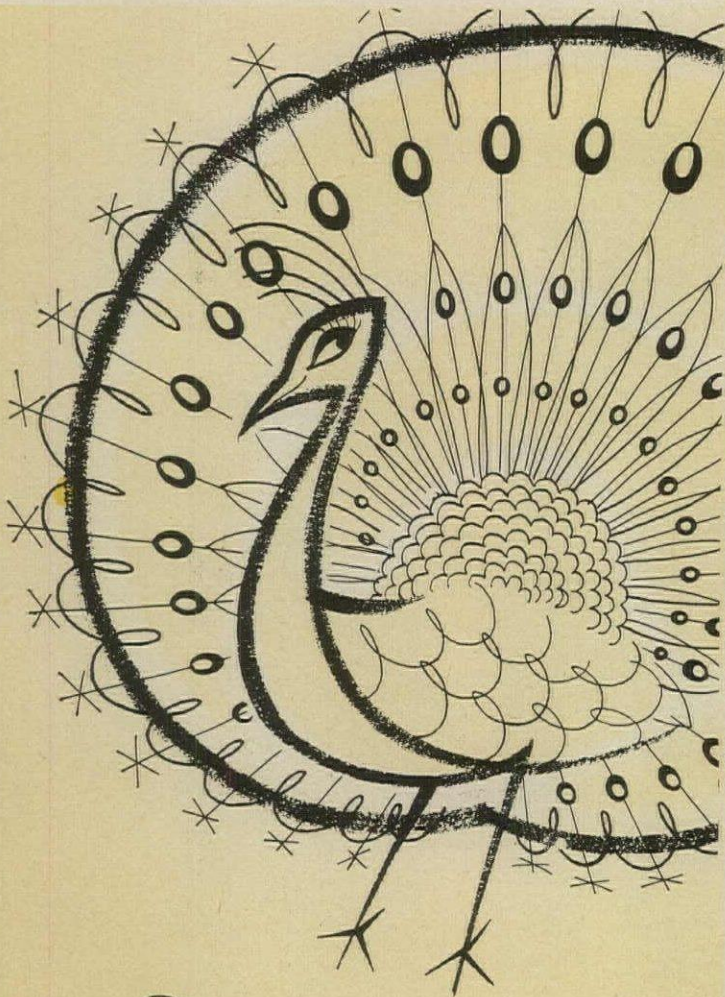

## Distinctive

There's every reason why you'll install NATIONAL LOCKset with confidence. Offering a complete selection of smartly-styled knob and decorative escutcheon designs, NATIONAL LOCKset adds the touch of distinction to your modest and palatial homes alike. What's more, NATIONAL LOCKset is soundly engineered and quality built from knob to knob . . . assuring long-term, troublefree service . . . eliminating costly "call-backs." Ask your building material supplier.

NATIONAL LOCKset®

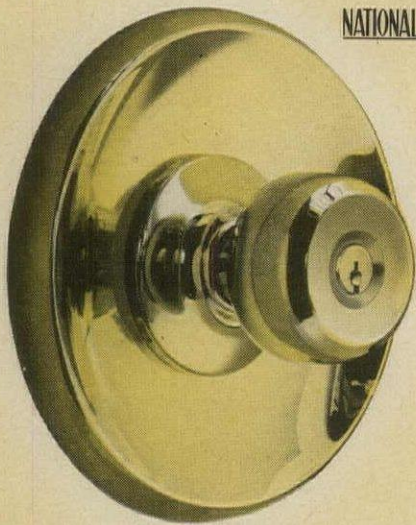

**Medalist** HARDWARE DIVISION  
NATIONAL LOCK COMPANY • Rockford, Illinois

30<sup>th</sup>. Anniversary

1929  
1959

**ELECTROMODE**  
LEADER IN ALL-ELECTRIC HEAT

## FREE SERVICE TO BUILDERS

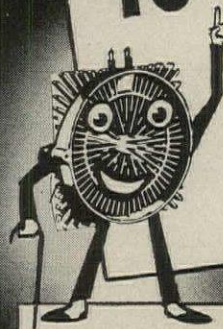

Send us your blue prints. Our engineers will gladly analyze them and suggest the most suitable type of heating equipment and the cost of heating per year.

**Mr. Safety Grid** stands for the safest in Electric Heaters and only Electromode Heaters have this feature. It's the completely sealed-in, cast-aluminum heating element. There are no open wires, no glowing coils. This heating element provides complete protection against fire, shock, burn.

## ELECTROMODE All-Electric HEATERS

### Models and Capacities for EVERY ROOM DESIGN—EVERY STYLE HOUSE

Complete Electromode Line Includes  
Wall and Portable Fan-Circulating Heaters  
Radiant-Convection Panel Heaters  
Baseboard Heaters Radiant Cable Heat

#### BASEBOARD HEATERS

Modern perimeter heating. Spreads a shield of comfortable warmth against cold walls, without drafts. Automatically controlled by thermostat in each room. Matching blank sections, endpieces, corners for carrying out unbroken baseboard effect.

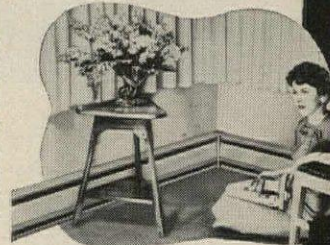

#### WALL-TYPE FAN-CIRCULATING HEATERS BATHROOM—SMALL ROOM—BIG ROOMS



MODEL WJA

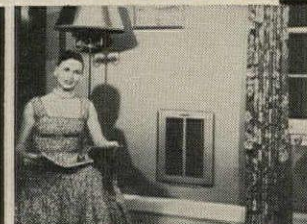

MODEL WA

ELECTROMODE division  
Commercial Controls Corporation

Dept. HH-59

Rochester 3, New York

SEE ELECTROMODE HEATERS IN SWEET'S CATALOG



# DUR-O-WAL<sup>®</sup> SAFEGUARDS THE BEAUTY OF MASONRY CONSTRUCTION

Throughout the United States genuine Dur-O-wal Steel Reinforcing is being used in the mortar bed to provide lasting protection for the classic beauty of masonry construction

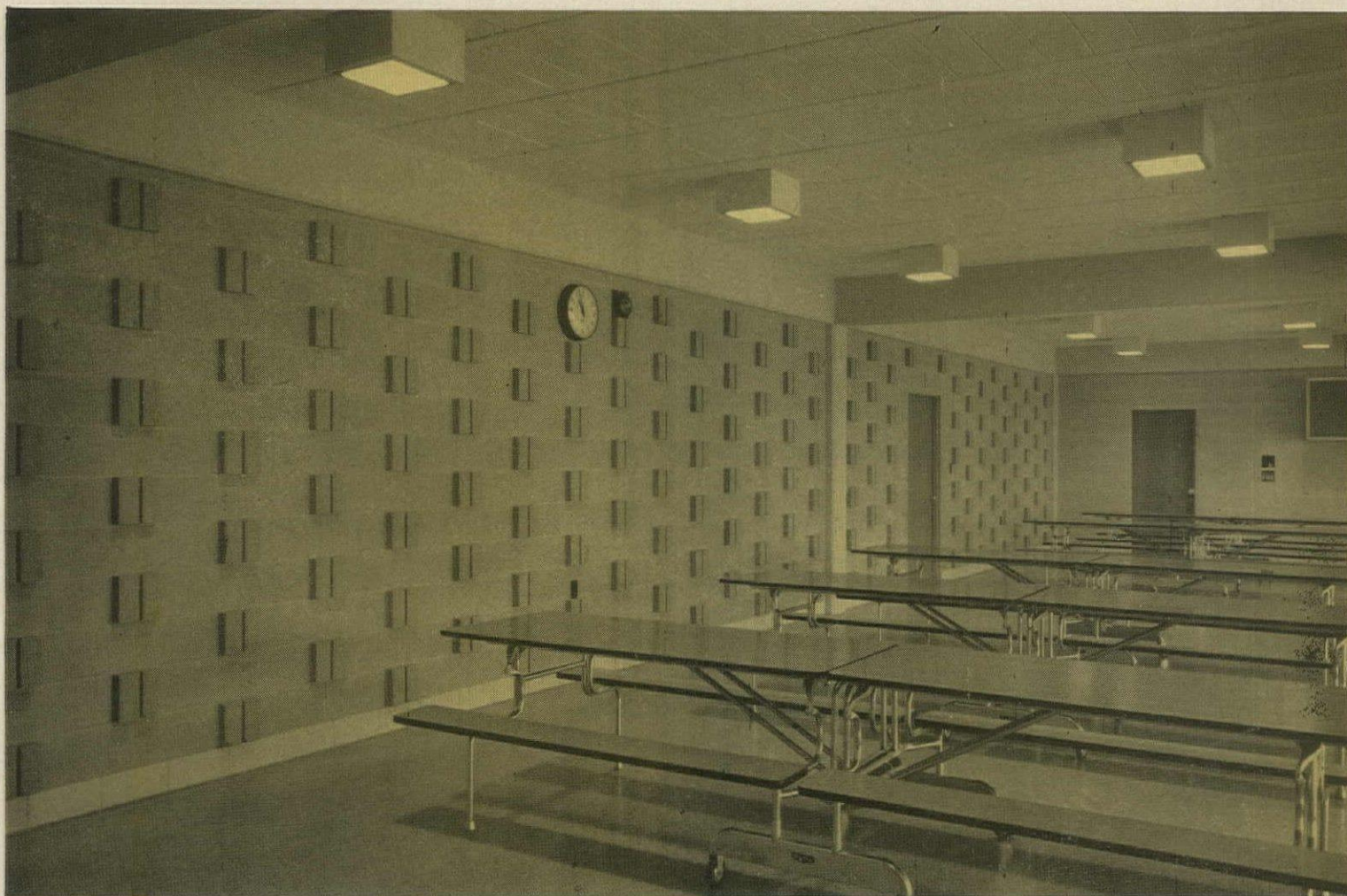

You can provide timeless protection for the flawless beauty of masonry with time-tested Dur-O-wal. This high-tensile steel re-inforcing is trussed and custom fabricated to give masonry walls a backbone of steel.

*Specifications and Research data available on request.*

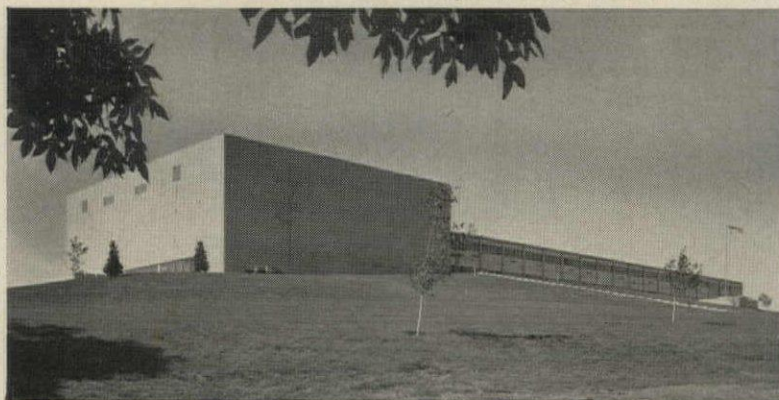

## DUR-O-WAL<sup>®</sup>

Rigid Backbone of Steel For Every Masonry Wall

Dur-O-wal Div., Cedar Rapids Block Co., **CEDAR RAPIDS, IA.** Dur-O-wal Prod., Inc., Box 628, **SYRACUSE, N. Y.** Dur-O-wal Div., Frontier Mfg. Co., Box 49, **PHOENIX, ARIZ.** Dur-O-wal Prod., Inc., 4500 E. Lombard St., **BALTIMORE, MD.** Dur-O-wal of Ill., 119 N. River St., **AURORA, ILL.** Dur-O-wal Prod. of Ala., Inc., Box 5446, **BIRMINGHAM, ALA.** Dur-O-wal of Colorado, 29th and Court St., **PUEBLO, COLORADO** Dur-O-wal Inc., 165 Utah Street, **TOLEDO, OHIO**

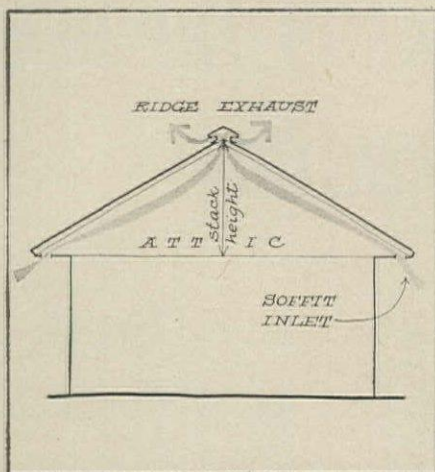

**AIRFLOW DIAGRAM** shows how fresh air enters attic at edge of eaves, exhausts at ridge.

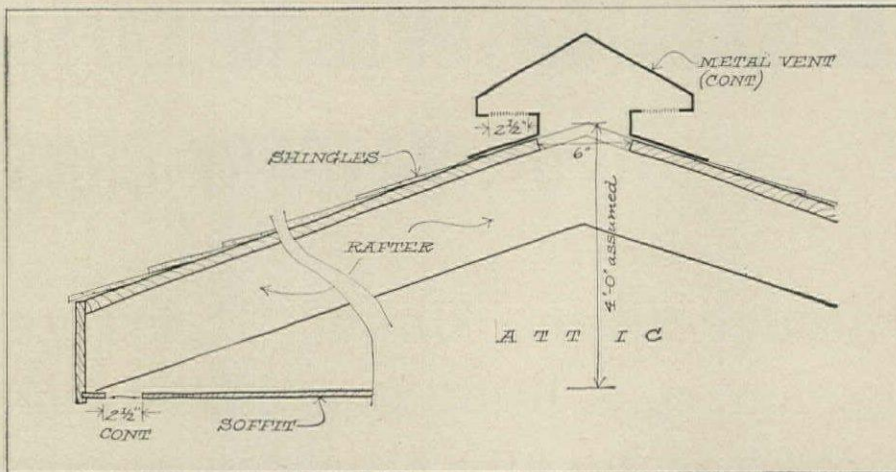

**CROSS SECTION** of attic shows how a ridge vent would be dimensioned for 25' wide house.

Added advantage of the continuous ridge vent is the elimination of the ridge row of shingles.

## Ridge ventilation: a new and better way to vent attics

Why better? Because, with the exhaust at the peak of the roof, you get the maximum "stack height." And (as in a chimney) the greater the stack height, the faster air will be drawn through the attic. In the summer, this faster air movement can cut attic temperature by

15°, making the house easier to cool with or without air-conditioning.

Because of its advantages, the ridge-vent concept is under study by the Small Homes Council of the University of Illinois. Warns SHC: "a vent must be rainproof; it is not a carpenter's job,

but probably a sheetmetal man's." (Two manufacturers are planning to market a vent this year: watch H&H New Products.)

SHC reminds: "This and all other venting systems must be combined with good insulation to do a good job."

### Also from the Small Homes Council:

## How to lick three common crawl space problems

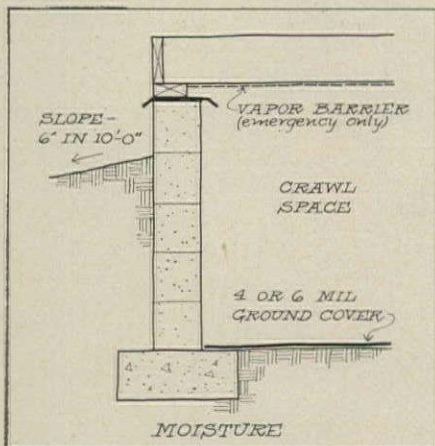

### 1 The problem of moisture

Excess moisture in the crawl space will make the house damp, cause paint to peel, and even start rot in the framing and the sub-floor.

The Small Homes Council suggests these ways to block the three sources of moisture:

*Surface water* should be kept out: 1) by grading away from the house at least 10', with a minimum drop of 6"; 2) by using deep roof overhangs; 3) by running gutter leaders at least 10' from the house.

*Ground moisture* should be drained. If you can't drain it with tile to a sump, you'll have to pump it out to the sump. Only in an emergency is a vapor barrier under the floor joists recommended.

*Capillary moisture* should be blocked with a 4- or 6-mil polyethylene ground cover on the boor of the crawl space.

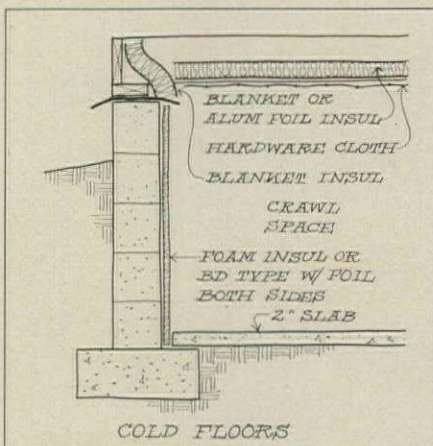

### 2 The problem of cold floors

Floors are cold because the crawl space below is cold. Crawl spaces are cold because they are vented to discharge moisture. Now SHC proposes a closed crawl space (based on good moisture-proofing like that shown at left) that will stay warm.

Shown above is a crawl space that should keep floors at a comfortable 65° with inside temperatures of 70°.

Insulation under the floor can be batt type on hardware cloth, or aluminum foil (recommended by SHC because it is effective against downward heat loss). The sidewall insulation can be cellulose or fiber board type wrapped with aluminum foil, or foamed plastic (which is insulation and vapor barrier in one). If the crawl space is used as a heating plenum, a 2" slab is suggested to ease cleaning, eliminate dust.

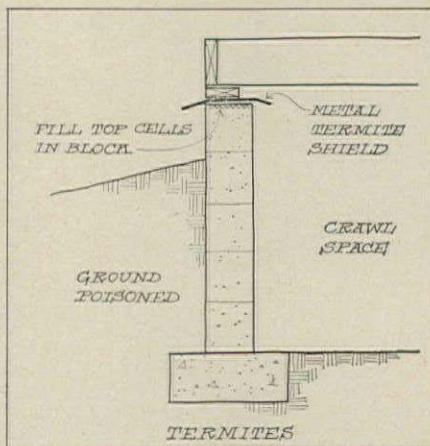

### 3 The problem of termites

"Inspection is the only real way to stop these clever and extremely ambitious insects," says Rudard Jones, head of the SHC. "If you get them into the open where you can see them, you can destroy their mud passages."

The termite shield shown above will do just that—get them out in the open where you can see them. It will not actually stop termites, says SHC.

Ground poisoning helps too, but it must be repeated every few years to be effective, SHC points out.

Especially important, says SHC: the top cells of the blocks in the top course running around the foundation must be entirely closed with mortar. Otherwise, termites can work their way under the shield, and—out of sight—get up into the wood portion of the house. /END



Going up all over the country . . .

# BUILDING PROFITS FOR YOU!

## Certain-teed Insulating Sheathing

Reduced time and material costs through easier application is one of the many reasons why more and more builders are using Certain-teed Insulating Sheathing.

Certain-teed Sheathing made of tough wood fibers, integrally asphalted, provides great structural strength and superior insulation. In addition, it is asphalt coated to assure dependable moisture resistance. Certain-teed Sheathing is another quality building product from Certain-teed Products Corp. . . . a line designed to help you build profitably.



***Certain-teed***<sup>®</sup> . . . *Superior Products through Creative Research*

**CERTAIN-TEED PRODUCTS CORPORATION • Ardmore • Pennsylvania • Plants and offices throughout the United States**

# M-F ANNOUNCES— the Most Important Development in Utility Tractors

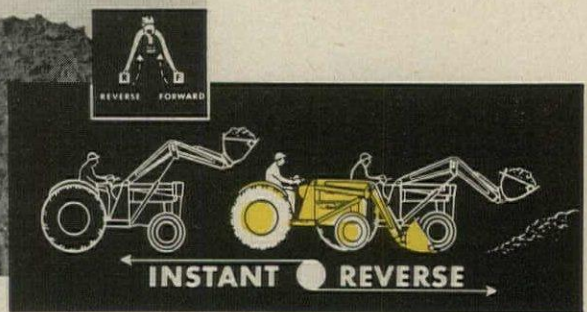

## the New **WORK BULL 204** has Instant Reversing and Torque Converter

Imagine — a powerful utility rig that changes direction instantly with a mere touch of your toe. That's the All New Work Bull 204 from Massey-Ferguson — leaders in light industrial equipment. Never have more new features and advancements been built into a utility tractor. Experience a new ease of operation with the field-proven, three-point pedal control that lets you move forward, reverse, or accelerate the engine. Leaves hands free to operate power-matched

Davis Loader or control tractor. A torque converter maintains the correct power-to-load ratio for maximum power — four equal speeds forward or reverse — individually operated left and right brakes — full-time power steering — a powerful, high-torque 40-hp engine. All of these features and many more put the 204 in a class of its own. If you want the ultimate in utility tractors the All New M-F Work Bull 204 will be your choice.

## the New **POWERFUL Davis 220 Backhoe** with Hydra Slide Positioning

**—GET READY TO FLUSH DIG  
IN LESS THAN FIVE MINUTES**

The All New Davis 220 Backhoe with amazing Hydra-Slide positioning is the most advanced backhoe you can buy. Hydra-Slide makes it possible to position the 220 Backhoe for flush digging in less than 5 minutes. To move the boom merely loosen four set-screws — slide the digging assembly and seat to the desired location — and re-tighten screws. You'll notice that the operator moves across with the boom and also revolves with it — places you over your work and lets you see what you are doing in any position. An increased operating pressure of 2,150 psi with a new high-pressure hydraulic system provides the new Davis 220 with more brawn and stamina than any other backhoe. Has 14,000 pounds of breakaway power.

*Write for name of nearest dealer and see these terrific equipment values soon.*

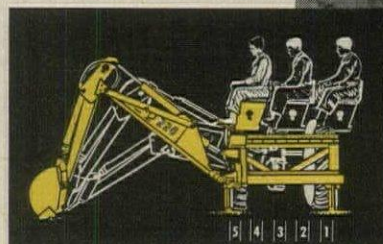

**MASSEY-FERGUSON INDUSTRIAL DIVISION**  
1009 SOUTH WEST STREET • WICHITA 13N, KANSAS

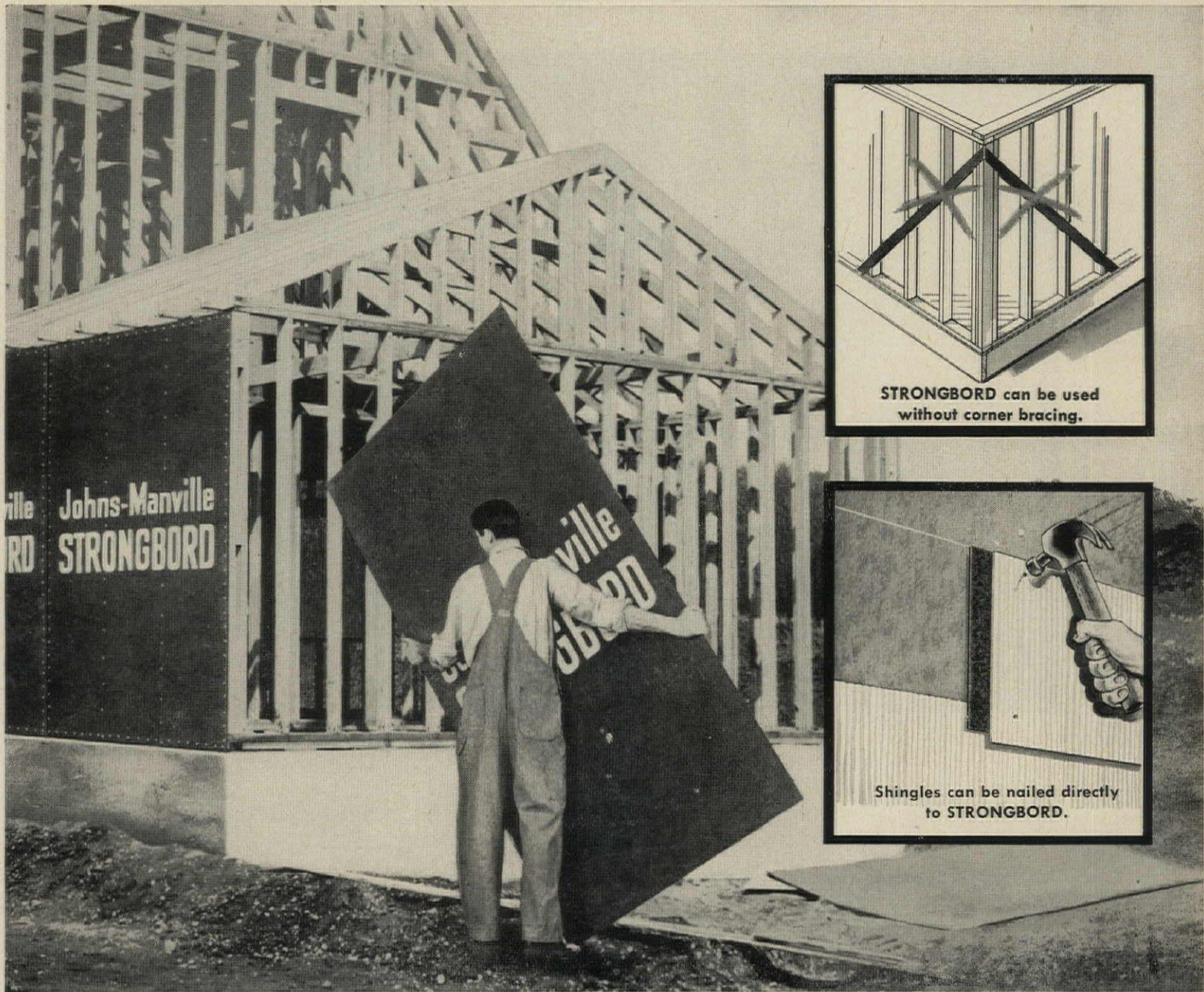

You can cut construction costs and build a better house with . . .

# Johns-Manville STRONGBORD sheathing

One of the greatest contributions to the building industry in recent years has been the development of STRONGBORD sheathing by Johns-Manville. There is no stronger  $\frac{1}{2}$ " insulation board sheathing on the market today!

This rugged insulation board sheathing adds extra bracing strength to the building frame. When applied over studs 16" c. to c., according to J-M specifications, STRONGBORD fully complies with FHA requirements for use without corner bracing. You save on material cost and labor.

Asbestos or wood siding shingles can be nailed directly to STRONGBORD. Its nail-holding ability is exceptionally strong.

Sheets come square-edged in 4' modular widths and in 8' and 9' lengths. Because one man can handle these large sheets — STRONGBORD goes up fast.

Made of selected wood fibers bonded together with special bituminous compounds STRONGBORD has high weather and moisture resistance. It also provides additional insulation against heat and cold, builds

better quality into homes.

For complete data and samples write: Johns-Manville, Box 111, New York 16, New York. In Canada, Port Credit, Ontario.

Ask your J-M representative about the 7-star and Mrs. America promotion to help you sell more homes.

## JOHNS-MANVILLE



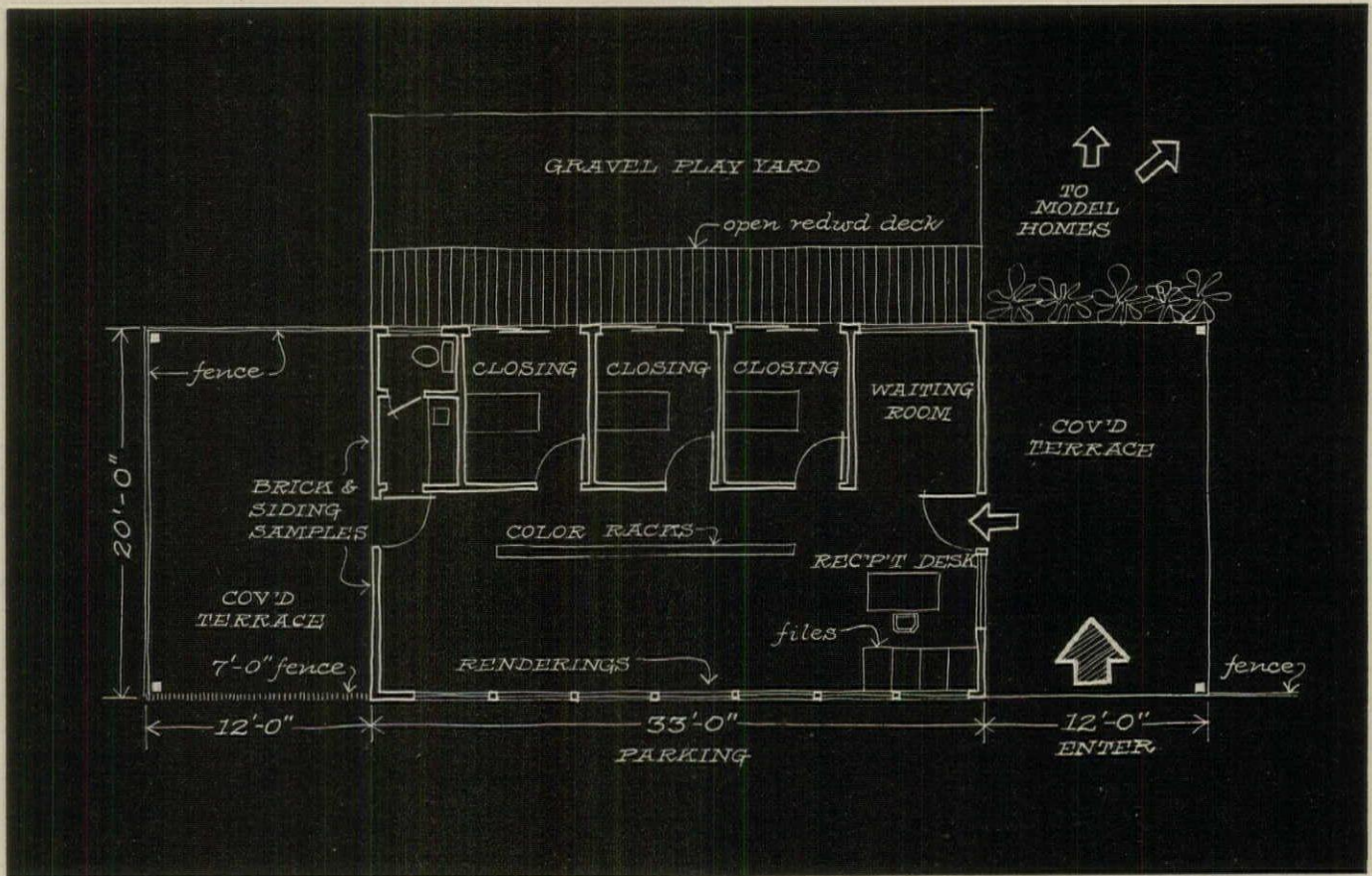

## Planning a sales office? Here's a workable blueprint

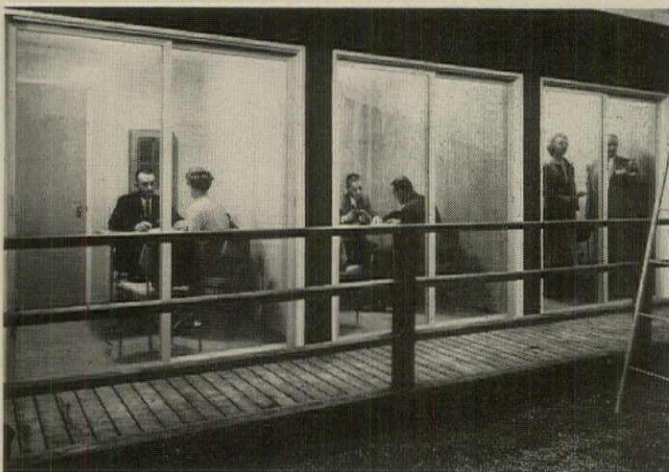

**CLOSING ROOMS** face model houses and fenced play yard (foreground) so parents can watch children, yet not have them underfoot.

This new office works particularly well because it channels visitors past salesmen before they wander out to look at model homes that are scattered along a street.

The only entrance to the subdivision is through a covered terrace at one end of the office. So it's easy to keep track of prospects—and as soon as they arrive, salesmen can "pick them up" and qualify them.

The office was developed by Dick Willard, president of Eastside Homes, sales agent for Seattle Builders Bell & Valdez. Among its other good ideas: 1) private closing rooms where prospects can meet with salesmen and still keep an eye on their children in a fenced play yard; 2) a waiting room for prospects who return to see salesmen; 3) a reception desk; 4) plenty of display space—inside and out.



**COVERED ENTRY TERRACE**, seen from parking area, frames view of model houses.



**OUTSIDE DISPLAYS** are samples of outside materials like siding (above) and brick.



**INSIDE DISPLAYS** include color and materials options, renderings, tract map.

continued on p 209

*the Sterling  
of Sidings*

## **WESTERN CEDAR**

... gives any architectural style the lift to quality. The miracle of Western Cedar blends practical workability with the genuine character that transforms "just another house" into a salable home. This is why Western Cedar is the Sterling of Sidings.

Unduplicated by science or nature, Western Cedar Siding – Bevel or Tee-Gee – has the "grown in" ability to perform better for you. This miracle wood decorates beautifully, saves important application money and gives you the warmth and individuality that creates the desire to buy.

Ask your lumber dealer about Western Cedar... the Sterling of Sidings... he knows.



*Write us today for our interesting  
builder information packet...*

**WESTERN RED CEDAR LUMBER ASSOCIATION**

4403 White-Henry-Stuart Building  
Seattle 1, Washington



**MAKE EXTRA  
MONEY  
WITH EVERY**

# **SQUEEZE**

**Speed your work with the Bostitch T-5 Tacker**

**POWERFUL**—a rugged spring drives the staple securely into the work.

**FAST**—one hand, one squeeze and the staple's *in*. One hand's free to position the work.

**VERSATILE**—choose from three spring tensions. Six types of Bostitch staples for ceiling tile alone . . . 15 types and sizes for *all* tacking jobs.

**CONVENIENT**—for tight places. Works fine where you can't swing a hammer.

**ACCURATE**—drives the staple precisely where you want it—within 1/16th" of an obstruction.

**FLEXIBLE**—does scores of fastening jobs better and faster than conventional methods. Installs ceiling tile, insulation, screening, low-voltage wiring, metal lath, Cornerite, to name only a few.

**SO WELL MADE WE SERVICE IT FREE**

*See and try the Bostitch T-5 Tacker at your Building Supply Dealer's*

Put a T-5 in your tool chest. Reach for it where you now reach for hammer and tacks. The time you save is profit in your pocket.

*Fasten it better and faster with*

**BOSTITCH®**  
STAPLERS AND STAPLES

523 Briggs Drive, East Greenwich, R. I.



**Here's sales help from manufacturers**

**Consumer survey** by Batten, Barton, Durstine & Osborn—New York ad agency with such building-product accounts as American Standard, Armstrong Cork, and Pittsburgh Plate Glass—has turned up interesting facts about what today's home buyers want.

Some items: 1) style, layout, and location are all more important than price; 2) open planning is on the wane; 3) the majority of buyers prefer a separate dining room; 4) women want a separate laundry, not a laundry-equipped kitchen; 5) family rooms—preferably next to the kitchen—are more popular than ever.

Survey covered 2,700 families, revealed many other important trends in buyers' desires. You can get detailed results through BBD&O, 383 Madison Ave, New York 17.

**"House of Ease" program**, a Reynolds Aluminum Co promotion, worked so well in six test cities last year, it is planned for 160 cities this year. Builders' houses qualify if they use 20 to 30 aluminum products. For builders tying in with program, Reynolds provides local advertising and publicity support. Reynolds claims use of aluminum products saves \$3,600 in maintenance and repair bills over the life of a house.

**"Quality Guarantee" program** has been launched by Best Homes, Effingham, Ill., producer of manufactured homes. Aim: to show that manufactured homes contain better materials than other houses. Best is running full-color and black-and-white ads in consumer and trade magazines, offers builders giant blowups for display in model houses.

**Want a good drawing card** at your model houses? If you tie in with Johns-Manville's "7-Star" merchandising program, you can get Mrs America (or Mrs any state) to appear for a nominal fee.

**Transparent wall-switch plate** (for Honeywell's Tap-Lite switch) is useful in model houses. Behind plate, builders can put cards with merchandising messages (below).

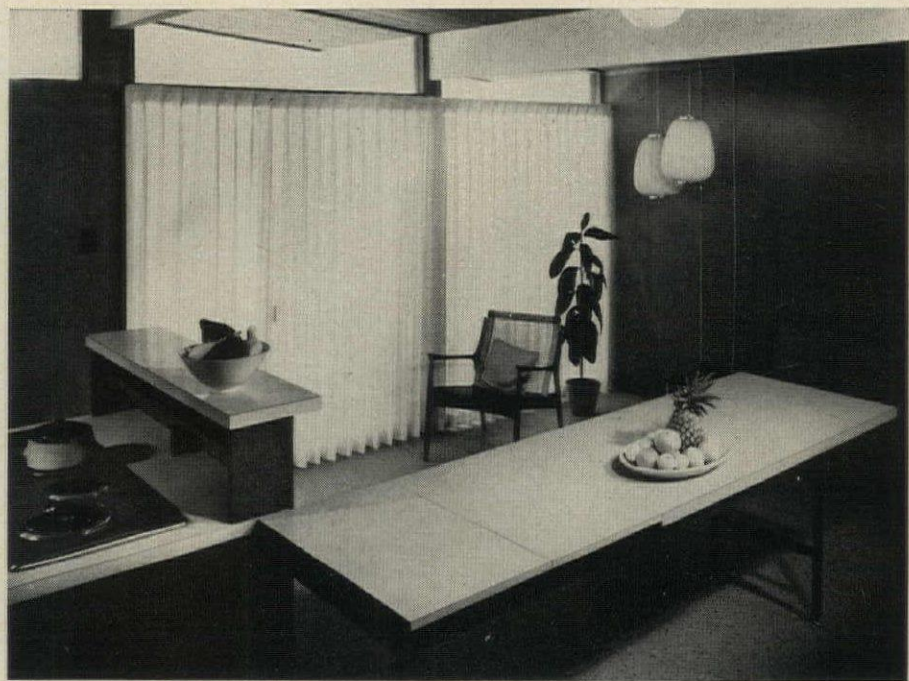
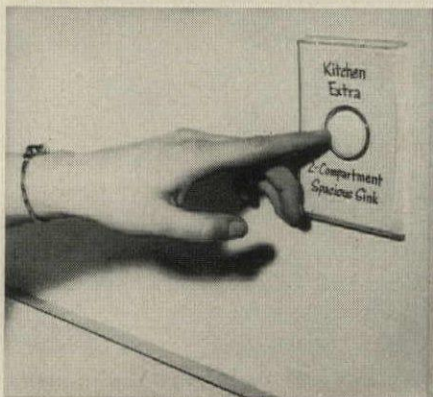

**Kitchen counter pivots into family room**

And then it can be extended (above) to seat eight people. The pivoting counter-table is standard equipment in the kitchen-family rooms of several models built by Eichler Homes, Palo Alto, Calif.

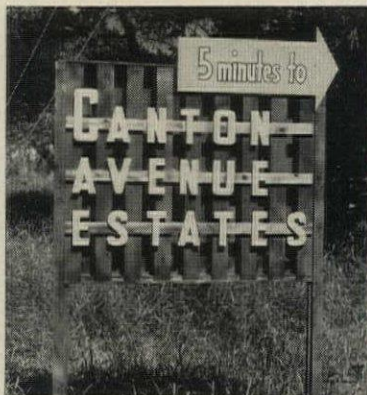

**Tie your directional signs to your site signs**

That's the advice of Bill Underwood, Jackson, Miss.

He uses the same plywood cutout letters, plywood arrows, and redwood background for directional signs and

for signs and fences around his model house, which he calls an "information center". Cutout letters (they cost \$2.50 each) are white; arrows are turquoise (a "feminine color").

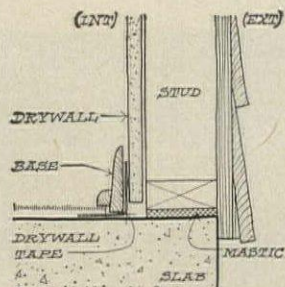

**To keep out cold air** along the floors of slab houses, John Worthman, Fort Wayne, Ind., sets his mud sills in mastic, then tapes the drywall to the slab around the perimeter of the house.

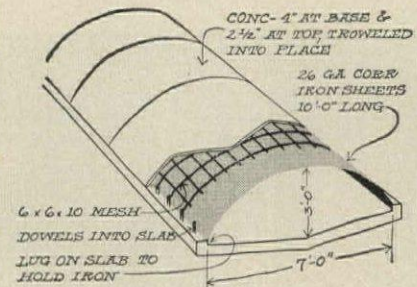

**To cut culvert costs**, Fischer & Frichtel, St Louis, pour very dry cement over slightly flattened corrugated iron instead of using 54" concrete pipe. Saving \$6 a running foot. /END

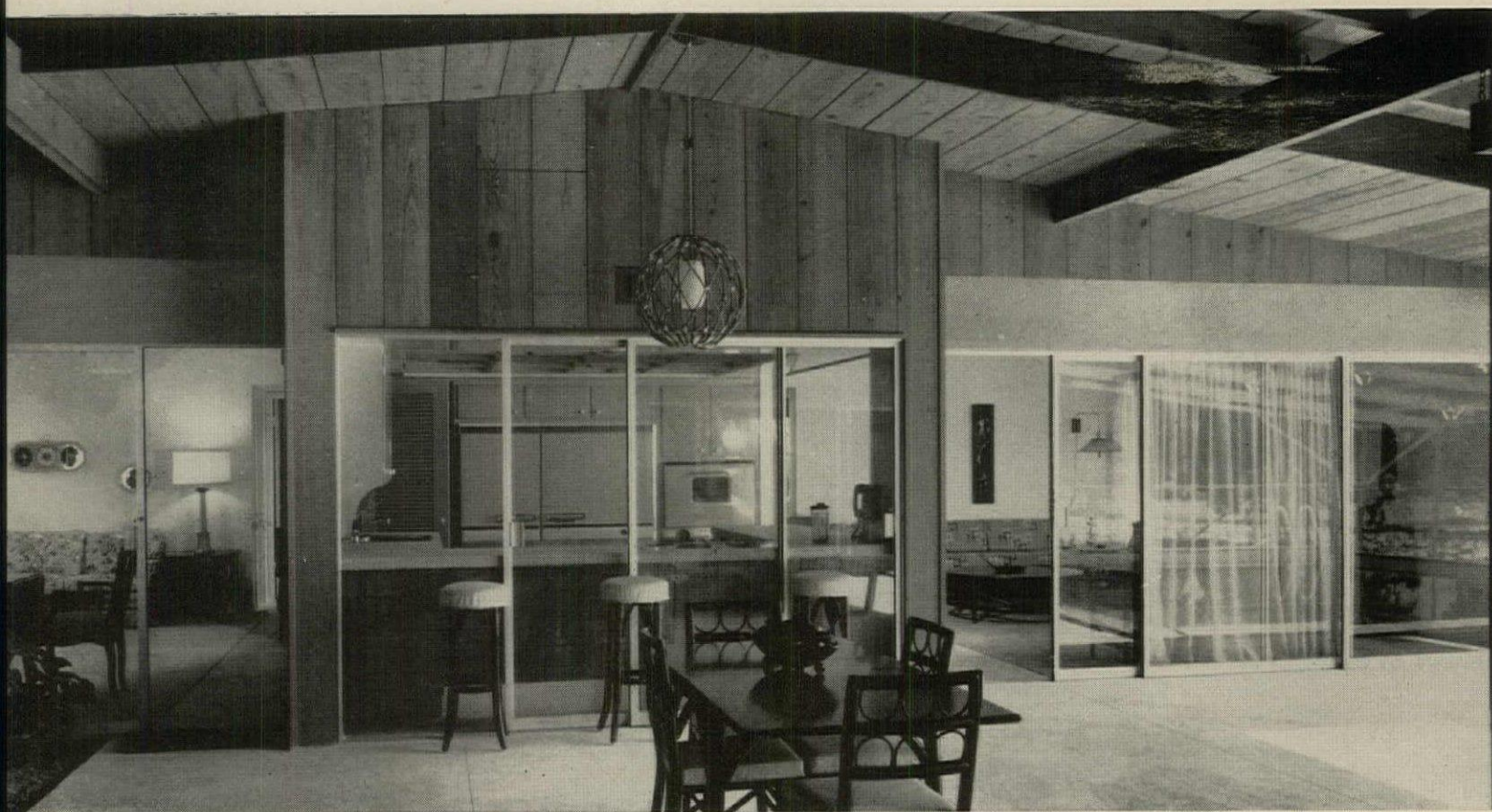

## There's a sliding glass door to fit every house

Wherever you build and whatever your price bracket, the sliding door industry has a door to meet your needs.

When  $\frac{3}{8}$ " crystal insulating glass came on the market in the fall of 1958, it bridged the gap between expensive full 1" insulating doors and light single-glazed units and made possible a door with adequate insulation for moderate temperatures. Doors with this glazing now make up the middle (\$175-\$200) price bracket.

Lightweight single-glazed doors are at the bottom of the price scale (\$75-\$90), serve well in the warm south and southwest and indoors. For the coldest climates only heavy, fully insulated, multiple-weatherstripped, and expensive (\$350-\$385) top-line doors will do.

### Weatherstripping also varies with price.

It is generally woven mohair wool pile, often silicone treated for moisture resistance. Recently vinyl extrusions have been combined with woven pile, particularly at sill and meeting rails. Single strips are adequate where single glazing is adequate, unless wind and wind-driven rain are common. In

the coldest areas triple weatherstripping is not too much. There is also a trend toward outside-mounted sliding panels—the wind will help hold them tight to the weatherstrip.

Various sill designs are offered for various purposes. Slipping sills are the best defense against water. Smooth sills stay cleaner where sand is a problem. Flat sills are best for interior use.

New solutions have been found for screen problems. Top-hung screens, tension screens, side-car screen rollers, and rollers top and bottom are some of the ways being used to stop track jumping, sagging, warping, etc. Other makers mount the screen inside out of the weather, and one uses a fixed screen and two sliding glass panels as an answer.

All but the least expensive doors are now anodized or recodized, some in metallic colors. And to get away from the metallic look, one manufacturer (Sun Valley) has just brought out ten colors in an epoxy finish.

Most of these developments are now being codified and industry standards are being set by the Sliding Glass Door & Window Institute which has established test facilities at Santa Maria, Calif.

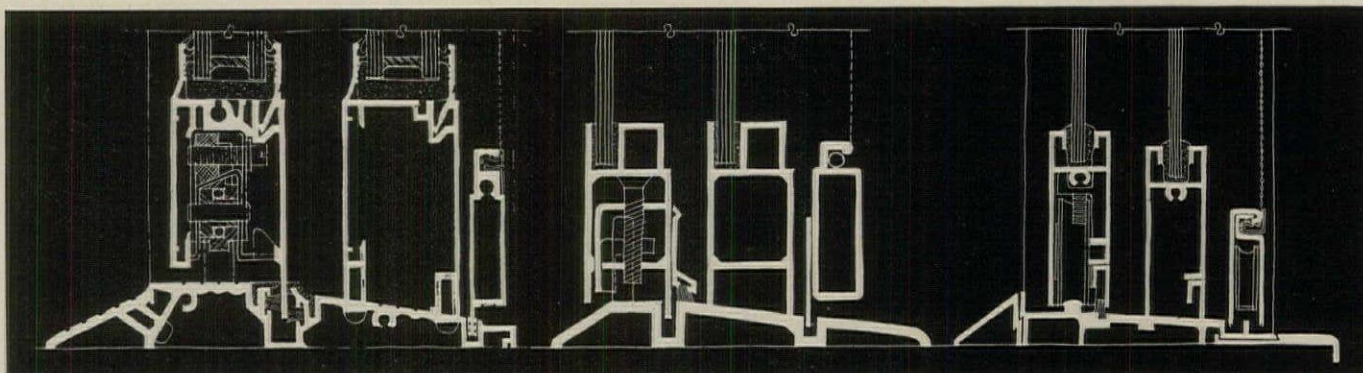

**SILL CROSS SECTIONS** of three lines by a single manufacturer show differences in sliding door grades. From top grade to economy grade,

extrusions get lighter and less complicated, weatherseal is less extensive, less insulating glass and lighter weights of glass are used.

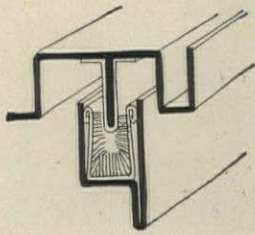

**Fenestra, Detroit.** New steel single-glazed doors and aluminum single- and 1" double-glazed doors. Steel doors are welded cold-rolled steel, primed for finish painting. Track cover is stainless steel. Rollers are grooved steel with rubber-cushioned ball bearings. Glazing bead is snap-on molding. Anodized aluminum doors have tandem bronze rollers with needle bearings. Screens have two single bronze rollers. Glazing bead snaps in place. Head, sill, jambs, and meeting rail of both types are double weatherstripped with mohair wool pile (left). Both have fiberglass screening.

For details, check No. 4 on coupon, p 264

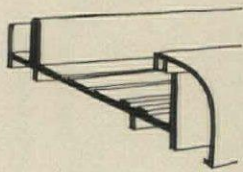

**Acorn Aluminum, Detroit.** New low-priced Showal line keeps most features of Dorwal line but has lighter construction. Dorwal has double wool-pile weatherstrip; Showal has "cam-action" jamb to assure tight seal. Both lines are single glazed in stock, take adapter for double glazing. Both have sloping sills with vinyl seal bead under fixed pane, adjustable nylon ball-bearing rollers, head roller guides, wraparound vinyl glazing bead, automatic latching, snap-on sill trim (left). Natural finish is standard, anodizing is optional.

For details, check No. 5 on coupon, p 264

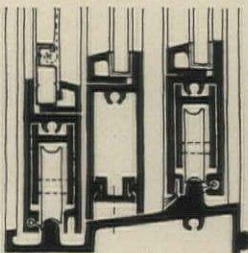

**Binswanger, Houston.** Gulfspray Lone Star doors are made of heavy extrusions take 3/4" single glazing. Sloping sill (left) has double pile weatherstrip on rolling pane, single on screen. At header, double pile weatherstrip fits around the guide flange. Meeting rails have triple weatherseal. Door and screen roll on nylon ball-bearing rollers. All parts have satin anodized finish.

For details, check No. 6 on coupon, p 264

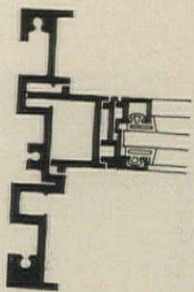

**Samuels Glass, San Antonio.** Toda Vista Mark III is made for single glazing only but is heavily built with reinforced welded corners, has replaceable double pile weatherstrip at head, jambs, and sill. Has double vertical adjustment to compensate for settling, snap-on vinyl glazing bead, nylon ball-bearing rollers. Lock is Adams-Rite 1848 jam-proof deadlock. All parts are anodized.

For details, check No. 7 on coupon, p 264

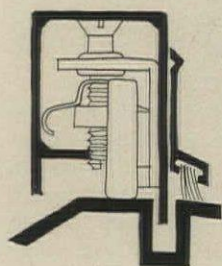

**F. C. Russell Co, Columbiana, Ohio.** Deluxe 1" double-glazed doors have been added to Rusco economy and deluxe single-glazed models. Deluxe units use heavier extrusions, have tandem rollers, adjustable latches, adjustable sill shield (left), top-hung screen, horizontal top guide roller on vent panel. Economy doors have mill finish, deluxe doors are anodized. All rollers are nylon ball-bearing. All weatherstrip is wool pile.

For details, check No. 8 on coupon, p 264

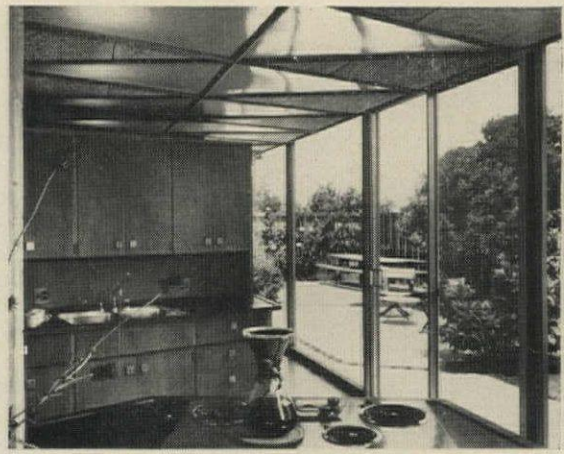

**Trimview Metal, Covina, Calif.** Lightweight, competitively priced Trimline doors for single or 5/8" double glazing are new from Trimview. Trimview line covers all types from 3/16" crystal to 1" insulating glass. Both lines use combination of continuous wool pile on sliding panels, vinyl v-seal on fixed panels. Insulating doors are double weatherstripped at sill, header, and meeting rails. Rollers are nylon ball bearing. A variety of trim fins, headers, and flush or sloping sills are available. Screens have nylon top guides.

For details, check No. 9 on coupon, p 264



**Sun Valley Industries, Sun Valley, Calif.** Ten colors in a new chip-resistant epoxy finish are now available on top-line doors—Imperial for 1" double glazing and Senior for single or 5/8" double glazing. (Junior door for regular single glazing is also in the line.) Imperial doors have extra-heavy extrusions, multiple pile weatherstrip. Senior and Junior have double weatherstrip. Glazing strip is continuous vinyl bead. Imperial has tandem rollers, all have adjustable rollers. Recodized finish is standard, anodizing and epoxy finish are optional.

For details, check No. 10 on coupon, p 264



**Oro Mfg Co, Adrian, Mich.** Sceneramic doors take standard glass sizes from 3/16" crystal to 1" insulating. No fixed panel. By-pass wool-pile weatherstrip at meeting rail and mullion stiles. Vinyl glazing beads. Adjustable nylon ball-bearing rollers. Cylinder lock, deadbolt, threshold trim, and fin trim are optional.

For details, check No. 11 on coupon, p 264

continued on p 212

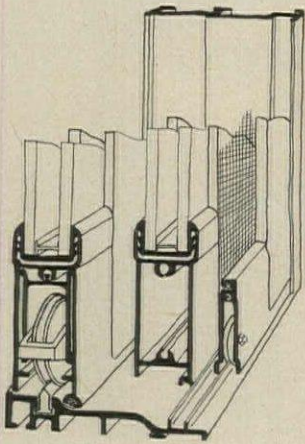

**Capitol Products, Mechanicsburg, Pa.** New Continental door is designed for 1" double glazing, can be adapted to take 1/4" single or 5/8" or 7/8" double glazing. Has heavy-duty hollow extrusions. Silicone-treated wool-pile weatherstrip is used at head and sill of sliding panel, vinyl at meeting rails and sill of fixed panel. Nylon ball-bearing rollers adjust to correct alignment, roll on removable track. Top rails have nylon guide buttons. Vinyl glazing channels are cushioned on rubber. Stock finish is natural satin, anodizing is optional.

For details, check No. 12 on coupon, p 264

**Peterson Window, Ferndale, Mich.** New medium-priced Daisy door locks in three open positions (1 1/8", 2 3/4", 5 3/4") for safe ventilation, has cushioned slider track (left). Weatherstrip at vent head and on screen is mohair pile; at jamb, meeting rail, and sill, it is a vinyl extrusion bearing on a urethane foam insert. Fiber-tired ball-bearing rollers and nylon head guides eliminate metal to metal contact. Moving panel settles on seal in closed position. Sash adapts to all glazing from 3/16" crystal to 1" double glazing.

For details, check No. 13 on coupon, p 264

**Cupples Door & Frame, Dowagiac, Mich.** Cupples door is single-glazed. Head and sill are coped to jambs, fastened with stainless steel screws. Sloping sill has weep holes for drainage; sill track for sliding panel is a stainless-steel rolled moulding. Pile weatherstrip is continuous, is doubled at the meeting rail. Sill weatherseal adjusts with the nylon ball-bearing rollers. Nylon guides align slider at top. External screen hangs from overhead track. All parts except sill are anodized.

For details, check No. 14 on coupon, p 264

**Textron Metals, Girard, Ohio.** New series 1320 door will take up to 1" glazing, sell in the middle bracket. Double wool-pile weatherstrip is standard, triple weatherstrip is available for very cold climates. Tubular panel extrusions, heavy interlocking meeting rails. Double glazing can be sealed double glass or Textron's twin-glazing system. Glazing bead is vinyl spline. Nylon ball-bearing rollers are adjustable. Plastic frame insulation to cut condensation is optional.

For details, check No. 15 on coupon, p 264

**Dina-Pak, Irving, Tex.** Keydor units come in the usual full panel type or horizontal bar type (left) for use with single or double glazing. Sliding panel has double pile weatherstrip at head and jambs, vinyl extrusion weatherseal at sill and meeting rail. Adjustable nylon ball-bearing rollers. Snap-in aluminum glazing bead. Expansion sill trim and jamb fin are integral.

For details, check No. 16 on coupon, p 264

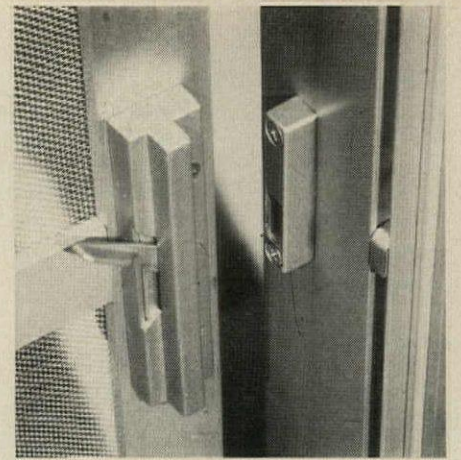

**Pittsburgh Plate Glass, Pittsburgh.** New Pittco doors take either single glass or Twindow. Wool pile weatherstrip makes two-point contact all around panel. Interlocking meeting rails are gasketed for three-point weatherseal. Nylon ball-bearing sheaves roll on stainless-steel-capped track. Outside rolling screen has thumb-operated latch (above). All aluminum parts are anodized.

For details, check No. 17 on coupon, p 264

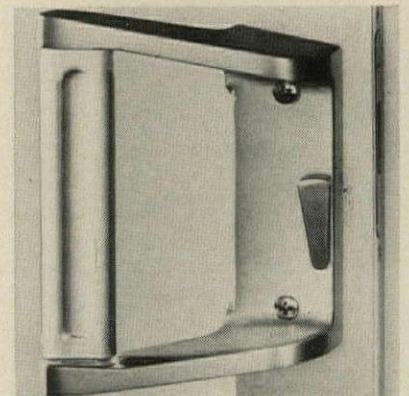

**Ador Sales, Fullerton, Calif.** All Ador lines now use the new jam-proof Adams-Rite lock shown above. The lines: Thermo Door, designed just for 1" insulating glass, with plastic inserts separating inner and outer metal surfaces, double-contact silicone-treated pile weatherstrip all around inside and out. Ador, for 1/4" plate or 1" insulating glass, in a wide range of combinations, has positive four-way weatherstrip. Zdor, for the lower price market, is for single glass only, is lighter, has single weatherstrip all around. Thermo Door and Ador have brass sheaves with stainless-steel bearings rolling on stainless steel inset track. Zdor has nylon ball-bearing rollers. All doors are anodized, top two are also lacquered.

For details, check No. 18 on coupon, p 264

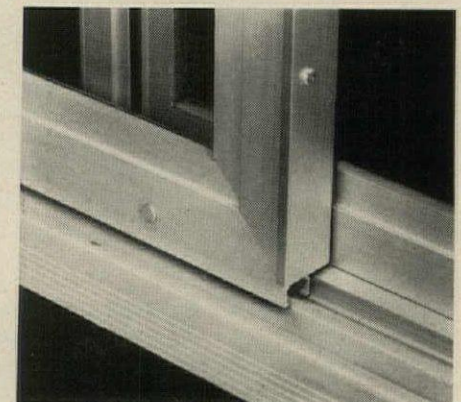

**T. V. Walker, Burbank, Calif.** New Cavalier door for 5/8" double glazing fills gap between top-line Continental and economy Cadet. Weatherstrip is continuous wool pile. Cavalier and Cadet use similar H-channel extrusions, step sill, outside mounted sliding panel, nylon ball-bearing rollers. Continental uses heavier double U-box channels, sloping sill, inside-mounted slider, adjustable tandem rollers. All use continuous vinyl glazing bead, all have anodized finish.

For details, check No. 19 on coupon, p 264

**BUILT-IN  
SALES  
APPEAL**



Here is the newest built-in appliance that adds real value to a kitchen and gives the housewife the convenience she has wished for. The Canoelectric does away with the chore of hand opening more than 1000 cans a year. The Canoelectric by Trade-Wind is the first and only fully automatic built-in electric can opener with a single push button control—

- 1 It pierces the lid of any can**
- 2 Cuts it out smoothly**
- 3 Lifts off the lid**
- 4 Retracts the cutter**
- 5 Delivers the opened can**

Canoelectric is beautifully styled and simple to install. The small exposed face of non-chip white polyethylene measures 5" x 11¼" and extends from the wall only 1¾". The Canoelectric is built to Trade-Wind quality standards. It is UL approved and fully guaranteed. Ask your dealer for the full story on Canoelectric, including its surprising low price.



**SIMPLE  
TO INSTALL**

Only a  
screwdriver  
needed

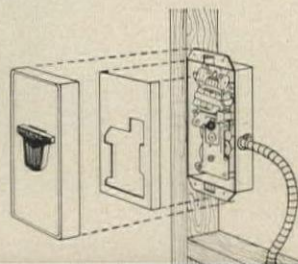

*Trade-Wind Motorfans, Inc.*

DIVISION OF ROBBINS AND MYERS, INC.

7755 PARAMOUNT PLACE, DEPT. 00, PICO RIVERA, CALIF.

MARCH 1959



## 100% Fireproof CLAY FLUE LINING

Clay Flue Lining gives you the best protection against dangerous chimney and flue fires

**Safe With Any Fuel.** No other flue lining is so safe . . . so widely accepted. It's the only flue lining adaptable to all fuels—coal, oil, gas, and wood. With Clay Flue Lining, you can convert safely to any new heating system, no matter what fuel it burns. Multiple purpose flues of Clay Flue Lining are safe for fireplaces, grills, incinerators—all the extra features that make your home more valuable, more livable.

**Features You Can Trust.** Clay Flue Lining is 100% fireproof . . . won't melt

under heat. Since it's chemically-inert, it's completely unaffected by chemicals and gases . . . does not rust, rot, or corrode. Select Clay Flue Lining with confidence . . . it never wears out!



Write for free fireplace folder and data-filled booklet on safe chimney construction.



You Can Trust This Mark of Quality

Alliance Clay Product Co. . . . . Mifflinville, Pa.  
American Vitriified Products Co. . . . . Cleveland 14, Ohio  
Dee Clay Products Co. . . . . Bloomingdale, Ind.  
The Evans Brick Co. . . . . Uhrichsville, Ohio  
The Kopp Clay Co. . . . . Malvern, Ohio  
Larson Clay Pipe Co. . . . . Detroit 34, Mich.

Malvern Flue Lining, Inc. . . . . Malvern, Ohio  
Mill Hall Clay Products, Inc. . . . . Mill Hall, Pa.  
Natco Corp. . . . . New York 17, N.Y.  
Peerless Clay Corp. . . . . Toronto, Ohio  
Straitsville Brick Co. . . . . New Straitsville, Ohio  
Worthington Ceramics . . . . . Worthington, Pa.

Grand Ledge Clay Products Co. . . . . Grand Ledge, Mich.  
Western Clay Products, Ltd. . . . . Regina, Saskatchewan, Canada

Plants and branches strategically located to serve the nation.

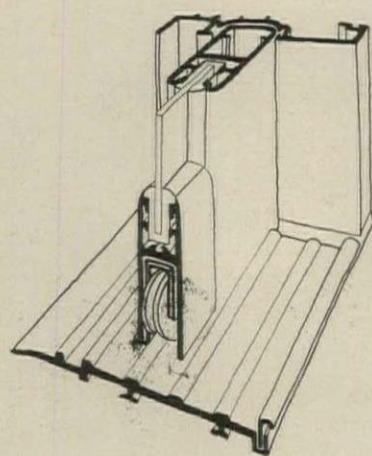

**Shower Door Co of America, Atlanta.** New amber champagne color has been added to satin and black anodized finishes. Heavy extruded frames have cast corners, deep sections to take 7/32" heavy sheet or 1/4" plate glass. Double mohair wool pile is used at jambs and meeting rail; sill weather-seal adjusts with rollers. Flush threshold drains at ends. Combination moulding cap and condensation jamb is adjustable. In fixed-slider series, slider is interior panel; exterior screen is in tension to prevent sagging, track jumping.

For details, check No. 20 on coupon, p 264

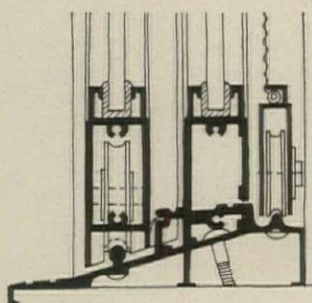

**Arcadia Metal, Fullerton, Calif.** New series 102-104 doors for single and 5/8" double glazing (left). Weatherstrip combines silicone-treated pile and pliable neoprene. Glazing bead is neoprene. Step-type sill drains to outside. Sliding panel is outside fixed panel, rolls on nylon ball-bearing sheaves on a nylon coated track. Screens are inside fixed panel, have adjustable rollers top and bottom. Rotary non-jamming latch. All parts are anodized.

For details, check No. 21 on coupon, p 264

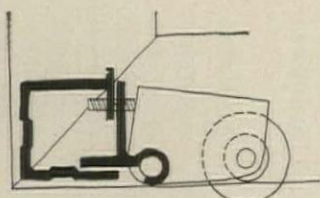

**Smithcary, Magnolia, Ark.** This line now includes standard and custom single-glazed doors. Tubular extrusions have mitered corners. Nylon ball-bearing rollers adjust (left) to align panels and frame. Sliding panel is outside fixed panel. Silicone-treated pile weatherstrip is continuous, refrigerator-style. Standard door has 3 5/8" frame, mill finish; custom model has 4 5/8" frame, anodized finish.

For details, check No. 22 on coupon, p 264

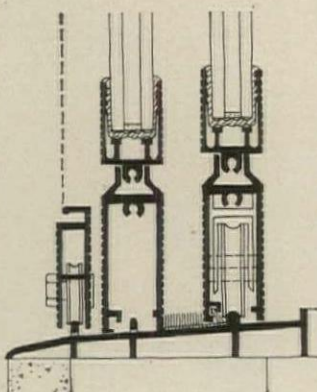

**North Hollywood Glass & Paint.**

Newest door in Hollyview line is model 300 for 5/8" double glazing. Unit has double pile weatherstrip at head and sill, compressible vinyl at jamb and meeting rail. Sloping sill has weep holes. Rollers are steel ball-bearing. Screen has adjustable bottom roller, spring-loaded top roller. Grooved textured surfaces are recodized.

For details, check No. 23 on coupon, p 264

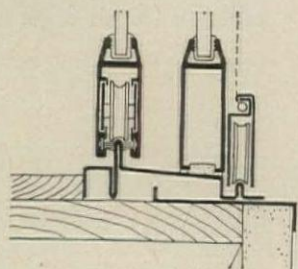

**Steelbilt, Gardena, Calif.** New Steelbilt Combo series uses steel frames, aluminum sash, stainless-steel covered sill (left). Steel frame goes together with screw-held steel gussets, can be painted before doors are in place. Sash is also screw-and-gusset fastened, takes 1/4" plate glass. Adjustable ball-bearing rollers may be nylon or stainless steel. Double wool-pile weatherstrip is used at head, jamb, sill, and meeting rail. Glazing bead is vinyl. Solid stainless threshold is optional.

For details, check No. 24 on coupon, p 264

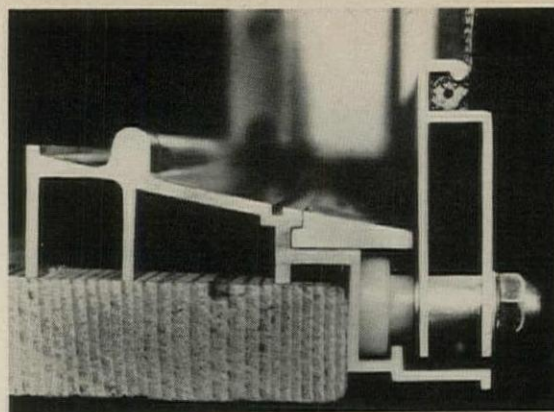

**Heller Co, Houston.** El Patio is a new budget-priced single-glazed door claimed to be completely weathersealed. It has by-pass style double silicone-treated wool-pile weatherstrip at head, jamb, and meeting rail. Sill is sloped 12 1/2° and has no obstruction between weatherstrip and exterior (above). Outside-mounted screen has unique side-car wheel locked in covered track. Adjustable nylon ball-bearing rollers. Clean mill finish is standard, anodizing optional.

For details, check No. 25 on coupon, p 264

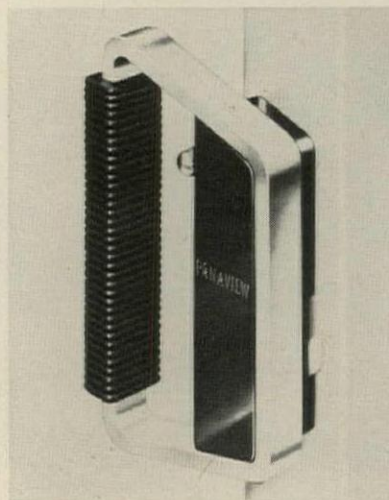

**Glide Windows, North Hollywood, Calif.** Mark III and IV are newest Panaview doors, have choice of color in raffia covered pulls (above). Panaview doors have double-pile weatherstrip all around, with extra pile above and below interlocking stiles. In top and bottom rails, weatherstrip runs full width. Adjustable nylon ball-bearing rollers. Sloping sill has condensation gutter. Screen rolls on bottom track, has top spring-loaded guide roller.

For details, check No. 26 on coupon, p 264

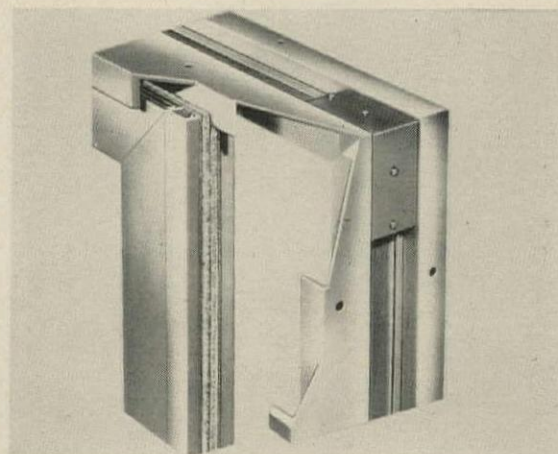

**Miller Sliding Glass Door, Burbank, Calif.** New 1000 series for 5/8" or 1" double glazing joins lightweight 250 series for 1/4" glazing, and steel sliders to fill out Miller line. Weatherstrip is woven wool pile in channel to give double by-pass seal (above). Flashing for sloping sill is optional. 1000 series has brass ball-bearing rollers; 250 series rollers are nylon. Both have anodized finish.

For details, check No. 27 on coupon, p 264

Water-tight . . . the fish said "Yes"—Capri Sliding Glass Doors are Water-tight!

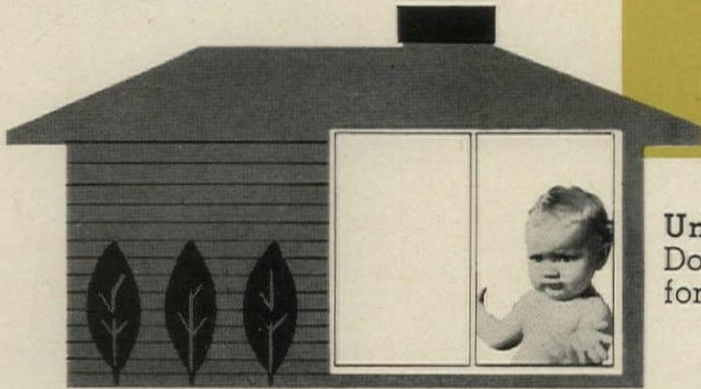

Unhanded . . . the baby said that Capri Doors may be Right or Left Sliding . . . before, during or anytime after installation!

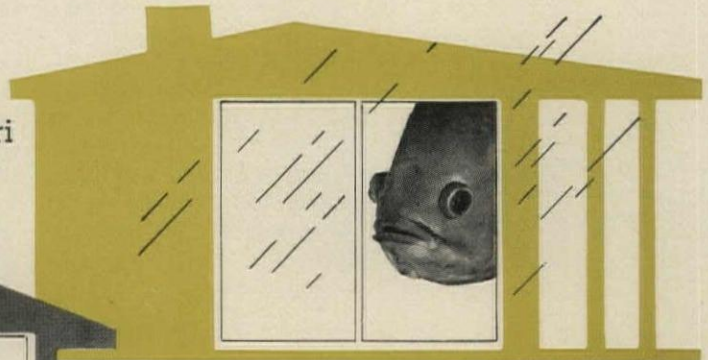

Low Priced . . . A Scotty always stands for economy but Capri adds quality too!



Hardware . . . a beautiful girl for our beautiful "Crown" handle, the most luxurious sliding glass door hardware in the nation!

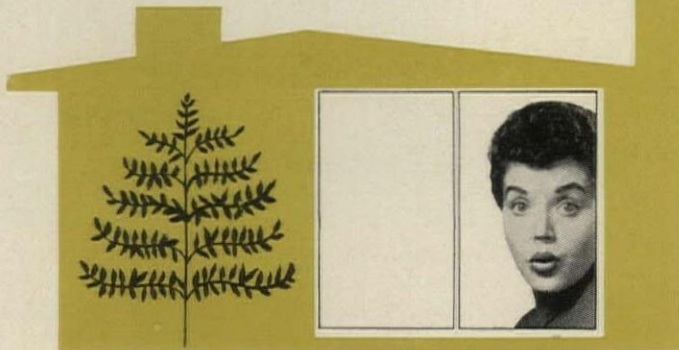

Low Cost Dual Glazing . . . the polar bear symbolizes the all-weather insulating qualities of our "CAVALIER" for 5/8" dual glazing—and of our deluxe Capri "CONTINENTAL" for 1" dual glazing!

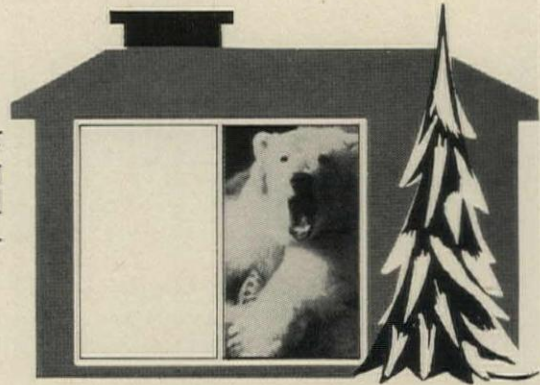

Five  
Important  
Reasons to  
Buy - Sell -  
Specify  
Install

Capri

ALL ALUMINUM  
SLIDING GLASS DOORS

Write for additional information and specifications  
on Capri Sliding Glass Doors



MEMBER: Sliding Glass Door and Window Institute

IN CANADA: Pilkington Glass Ltd., 165 Bloor St. East, Toronto, Ont.

**T. V. WALKER & SON, INC.** 217 N. Lake St. - Burbank, Calif.

Please send information on: Capri CADET  Capri CAVALIER   
Capri CONTINENTAL  Complete line

Dept. HH-39.

NAME \_\_\_\_\_

COMPANY \_\_\_\_\_

ADDRESS \_\_\_\_\_

CITY \_\_\_\_\_ ZONE \_\_\_\_\_ STATE \_\_\_\_\_

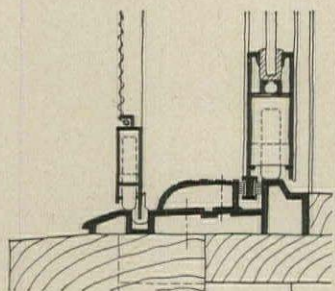

**Michael Flynn Mfg, Philadelphia.**

Lupton sliding doors are designed for single glazing, have channel frames with 3/32" walls. Weatherstrip is double woven pile backed with aluminum. Glazing bead is vinyl. Adjustable rollers are phenolic-laminate ball-bearing sheaves; nylon guide blocks are at head and sill of slider and screen. Doors are cleaned, etched, and lacquered before shipping.

For details, check No. 28 on coupon, p 264

**Trim-Glide, Farmingdale, N.Y.**

Trim-Glide doors now take 5/8" and 1" insulating glass. Doors have continuous double pile weatherstrip at all points including interlocking stile of multi-panel doors (left). Glazing bead is vinyl. Rollers are ball bearing. Doors have clean mill finish.

For details, check No. 29 on coupon, p 264

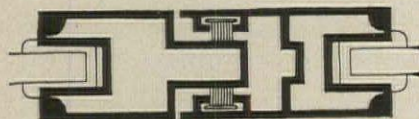

**Marshall Aluminum, Los Angeles.**

Marshall doors are made from heavy-duty extrusions with solid aluminum corner blocks. Sloping threshold has a special alloy track that holds the wool pile weatherseal. Same silicone treated pile is used at head, jambs, and meeting rail. Glazing bead is spring clamped. Rollers are linen-reinforced Micarta ball-bearing type. Outer pull is full length. All aluminum parts are anodized.

For details, check No. 30 on coupon, p 264

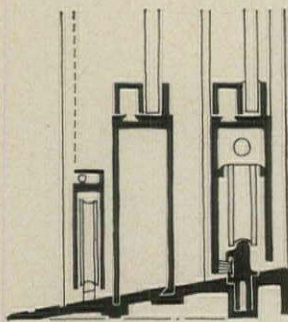

**Bur-Val Mfg, Burbank, Calif.**

Bella's Champ is newest Bur-Val economy single-glazed door. Weatherstrip is single pile at jamb and meeting rail, double pile at head and sill. Sloping hardened sill also has mohair pile insert. Vinyl glazing beads, ball-bearing rollers, anodized finish.

For details, check No. 31 on coupon, p 264

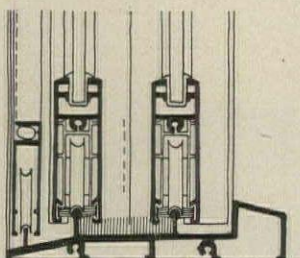

**Bailey-Kelleher, Detroit.**

Nu-Vu fashion-dor takes single or 5/8" double glazing. Slider has double wool-pile weatherstrip at head, jamb, and meeting rail, continuous weatherstrip between sliding and fixed panes. Nylon ball-bearing rollers, vinyl glazing bead, sloping sill. Sliding panel is mounted on the outside, screen inside (left).

For details, check No. 32 on coupon, p 264

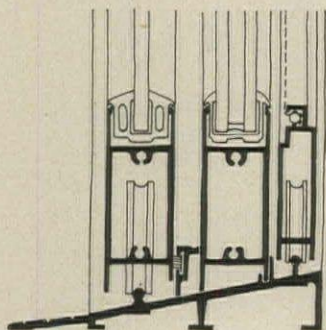

**Kota Products, Rocky Point, N.Y.**

Kotarama doors are single glazed, frames have integral nailing fin. Wool pile forms continuous weatherstrip when slider is closed. Fixed pane has rubber cork seal. Adjustable door rollers are Micarta roller-bearing type; screen rollers are nylon. Sloping sill has weep holes. Sliding panel is outside fixed panel, screen outside slider.

For details, check No. 33 on coupon, p 264

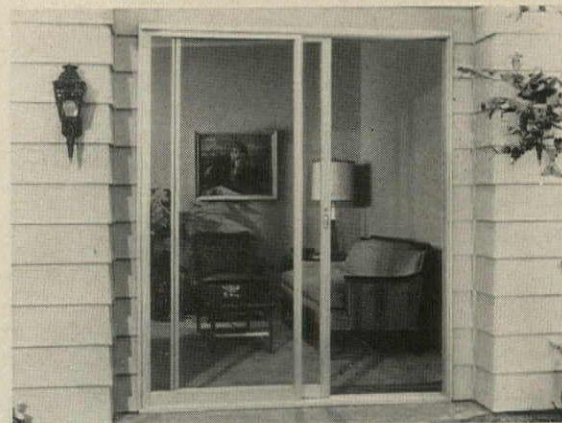
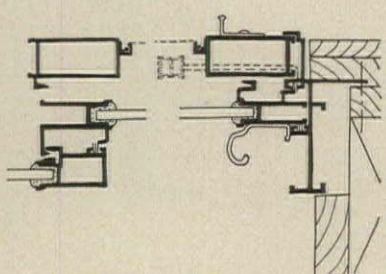

**General Bronze, Garden City, N.Y.**

Two new doors have just been added to the line. Coronet 711 is an economy-priced fin-trim model for single glazing, has one fixed panel. Slider is double weatherstripped; slider and screen have vinyl sweep at meeting rail for full protection when door is part way open. Adjustable nylon rollers. Sliding panel is mounted outside. Regency 770 is designed to take 1" insulating glass centered over adjustable nylon rollers. Combined pull and thumb-operated night latch are on slider stile. Sill is nearly flat, drains through end openings in track. Regency doors are anodized, Coronet doors have mill finish.

For details, check No. 34 on coupon, p 264

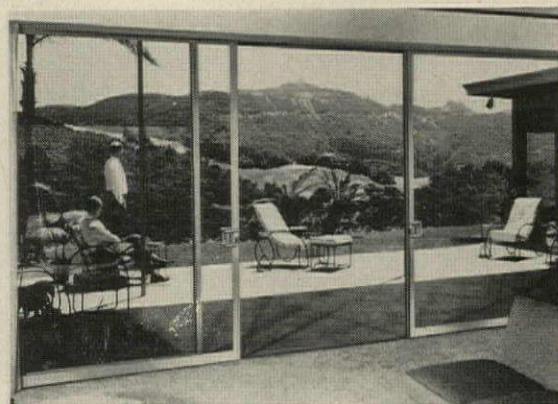

**Slide-View Door & Window, El Monte, Calif.**

Model TC-AL Thermoslide is new door designed to take 5/8" insulating glass, has many features of custom-made models AL-1A and T-AL: continuous pile weatherstrip, up-action safety lock, adjustable nylon sheaves. Comes in two or three panel units.

For details, check No. 35 on coupon, p 264

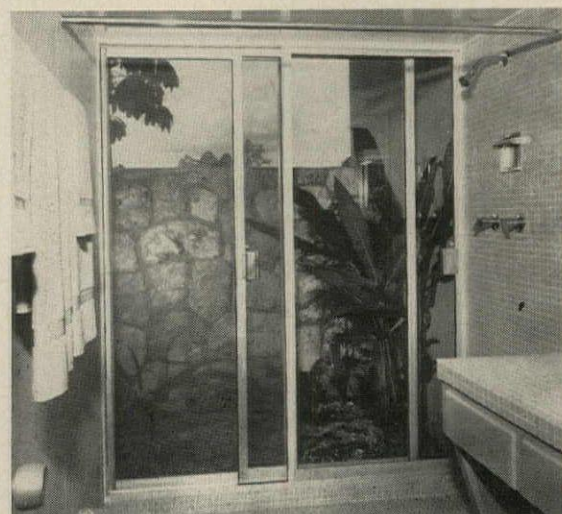

**Daryl Products, Miami.**

Patio-rama doors for 5/8" double glazing or single glazing now supplement Patio Magic doors for 1" or 5/8" double glazing or single glazing. Sills on both slope to 7/8" riser for water seal. Flat sills are available for interior use. Patio Magic has double, Patio-rama single wool-pile weatherstrip. Both use vinyl glazing channels. Adjustable nylon rollers have sealed ball bearings. Finish is etched and anodized.

For details, check No. 36 on coupon, p 264

continued on p 221



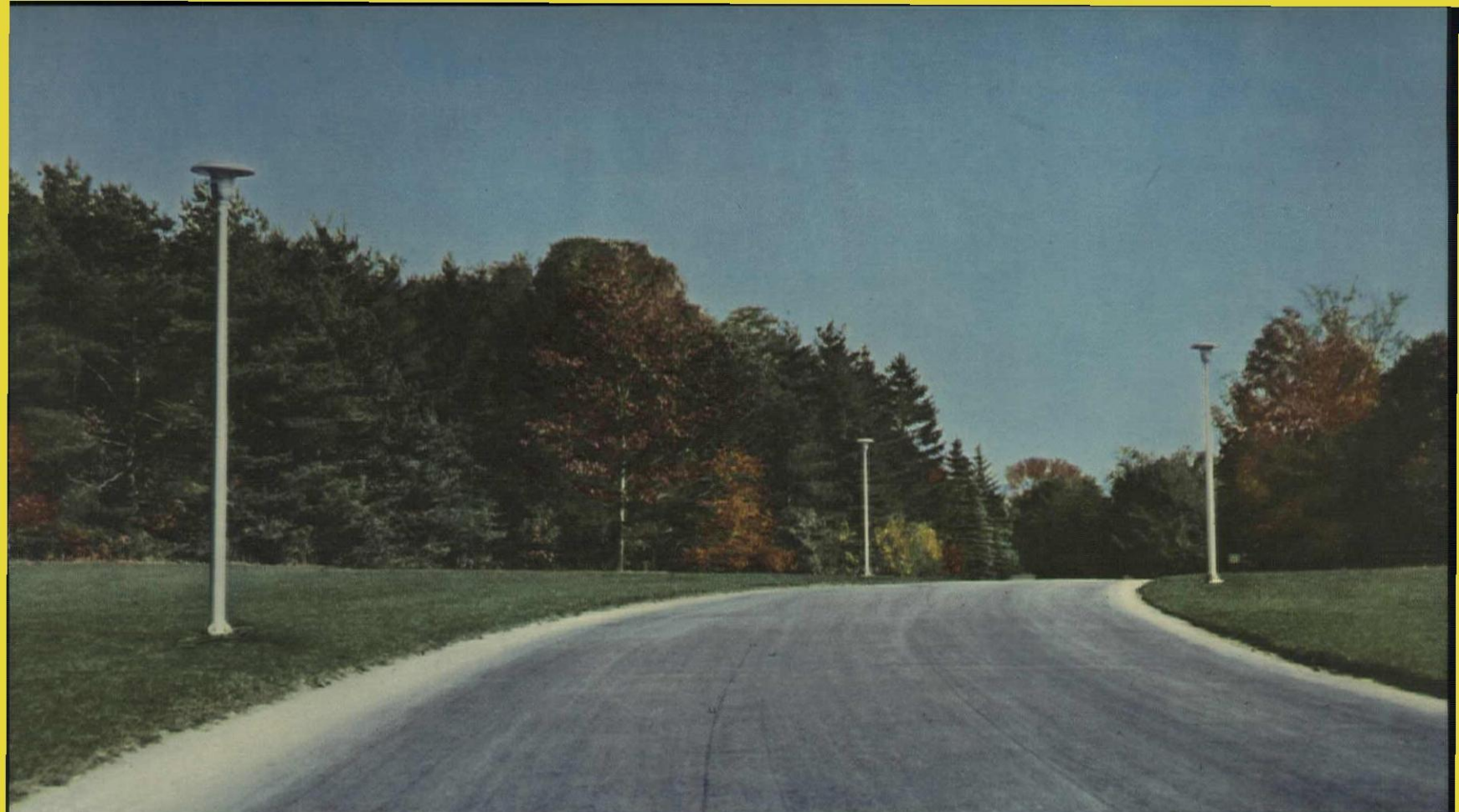

THE PTL is excellent for estate type subdivisions, drive-ways, parks, hotel grounds, and recreation areas. The design lends the elegance of low, even lighting and the

safety of good light with a minimum of glare. Subdividers and landscape architects will find the PTL well suited to their esthetic needs without sacrificing light efficiency.

## New L-M Post Top Light Combines Appearance with High Efficiency

The new L-M PTL (Post Top Luminaire) combines decorative appearance with a highly efficient optical system. It is specially suitable for lighting drive-ways, residential and institutional grounds, schools, stores, subdivisions, parks, swimming pools, railway platforms, bus stations, and other places where the designer wants both good appearance and efficient light utilization.

### Rigidly Built

The PTL combines a rigid spun-aluminum reflector, an efficient Holophane® refractor, and a sturdy aluminum mounting base. Reflector swings open on hinge for easy cleaning, and for replacement of lamps and ballasts.

Reflector and base in natural brushed aluminum, or choice of pastel colors. Available with small cadmium-sulphide

photo control, which automatically turns light on at dusk and off at dawn.

### Choice of Five IES Patterns

For use with incandescent lamps up to 10,000 lumens, or 620 watts multiple; or with ballast in fixture for mercury vapor lamps up to 250 watts. Choice of five IES light patterns; types I, II, III, II 4-way, and V.

Two styles, for mounting on 3-inch or 7-inch poles. Tapered aluminum poles are available, to provide from 11- to 25-foot mounting heights.

### Attractive Low Prices

Prices of the PTL luminaire start at \$44; aluminum poles \$46 and up. Mail the coupon below for free data sheets and details. Or contact any of the L-M offices listed on the other side.

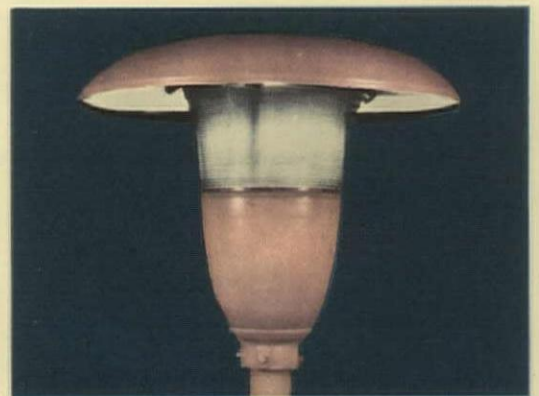

THE NEW L-M PTL provides elegance of appearance and efficiently controlled light distribution. Available in brushed aluminum, or pastel colors, for 3- or 7-inch poles. For incandescent lamps, or with ballast for mercury vapor lamps. The PTL is also available with small photo control. Prices start at \$44.



**LINE MATERIAL® Industries**  
MCGRAW-EDISON COMPANY



See  
Other  
Side



## Outdoor Lighting

LINE MATERIAL INDUSTRIES,  
Milwaukee 1, Wisconsin

Please send me Bulletin 58203  
on the PTL

Also bulletins on other types of  
outdoor lighting

HH39

Name \_\_\_\_\_  
Firm \_\_\_\_\_  
Address \_\_\_\_\_  
City \_\_\_\_\_ State \_\_\_\_\_

385

Please check:  Architect  
 Builder  Consulting Engineer  
 Utility Company  
 Other \_\_\_\_\_

# NEW L-M POST TOP LUMINAIRE



THE PTL is excellent for drive-ins, restaurants, hotels, motels, store fronts, shopping centers, water-front areas, railway stations, and many other applications.

Either incandescent or mercury lamps may be used. When the PTL is used for mercury vapor, the ballast is mounted in the fixture where it is easily accessible.



FOR INSTITUTIONAL OR RESIDENTIAL ground lighting, the PTL offers fine appearance, with efficiency. It spreads a soft, uniform light over a large area, with minimum glare.



NEW SCHOOL—NEW LIGHTING! L-M Post Top Luminaires add beauty to the facade, and provide excellent decorative and safety lighting for the area around the building.



**...AND NOW.** Conversion of this old light standard with a new PTL is more in keeping with the modern appearance of the building of the Bank of Naperville, Ill. The PTL will modernize most existing upright standards by direct replacement at a cost comparable to the replacement of two old-fashioned ornamental glass globe and canopy combinations.

For detailed specifications, mail the coupon on other side—or phone or write any of these



## SALES OFFICES

Albany 4, N.Y.	966 Broadway	Madison, Wis.	405 Tompkins Drive
Albuquerque, N.M.	1312 Mesilla, N.E.	Melrose Park, Ill.	4700 Lake St.
Allentown, Pa.	2405 Fairview St.	Memphis 7, Tenn.	1169 Morehead St.
Anchorage, Alas. (Spenard)	4502 Lois Dr.	Miami 38, Florida	7240 N. E. 4th Ct.
Arlington 6, Va.	204 Shirlington Trust Bldg.	Milwaukee 1, Wis.	700 W. Michigan St.
Ashland, Ky.	1215 Ashland Ave.	Minneapolis 20, Minn.	500 W. 79th St.
Atlanta 6, Ga.	1261 Chattahoochee Ave., N.W.	Moorhead, Minn.	918 So. First St.
Austin, Texas	604 West Ave.	Murrysville, Pa.	P.O. Box 297
Birmingham, Ala.	1700 Vanderbilt Rd.	Nashville 4, Tenn.	1503 Laurel St.
Boise, Idaho	614 1/2 State St.	Newington, Conn.	54 Pane Rd.
Buffalo 2, N.Y.	443 Delaware Ave.	New Orleans 22, La.	2860 Arts St.
Butte, Mont.	743 Wyoming St.	New York 6, N.Y.	74 Trinity Pl.
Canton, Ohio	814 So. Woodside	No. Kansas City, Mo.	10th & Erie Sts.
Charlotte, N. C.	3205 Monroe Rd.	Oklahoma City 5, Okla.	317 N. E. Hill St.
Cincinnati 43, Ohio	7822 Mapleleaf Dr.	Omaha 3, Neb.	3415 Cumming St.
Cleveland 14, Ohio	850 Euclid Ave.	Philadelphia 2, Pa.	Broad & S. Penn Sq.
Columbia, S.C.	2129 Devine St.	Phoenix, Ariz.	625 W. Madison St.
Columbus 15, Ohio	5 E. Long St.	Pine Bluff, Ark.	1904 W. 31st St.
Dallas 2, Texas	1909 Hi-Line Drive	Portland 9, Ore.	1333 N. W. 12th Ave.
Davenport, Iowa	9 Shady Lane	Raleigh, N.C.	216 Russ St.
Denver 2, Colo.	5105 E. 39th Ave.	Revere, Mass.	570 Revere Beach Parkway
Des Moines, Iowa	201 Continental Bldg.	Richmond 20, Va.	4111 W. Clay St.
Detroit 2, Mich.	611 Stephenson Bldg.	Roanoke, Va.	915 S. Jefferson St.
Duluth 4, Minn.	3331 E. Superior St.	Sacramento 18, Calif.	1123 Teneighth Way
East Stroudsburg, Pa.	North Burson St.	St. Louis 1, Mo.	706 Chestnut St.
Excelsior, Minn.	249A, Vine Hill, Rte. 4	Salt Lake City 10, Utah	980 S. 6th West St.
Fort Wayne, Ind.	2904 Inwood Dr.	San Antonio, Texas	1512 Majestic Bldg.
Glen Burnie, Md.		Seattle 99, Wash.	1220 W. Nickerson St.
Grand Rapids 5, Mich.	1837 Providence, N.E.	Sioux City, Iowa	3606 Court St.
Green Bay, Wis.	1119 Spence St.	So. San Francisco, Calif.	360 Shaw Road
Harrisburg, Pa.	2700 Paxton St.	Spokane 24, Wash.	E. 3303 Ferry St.
Houston, Texas	5715 Navigation Blvd.	Springfield, Ill.	Illinois Bldg.
Indianapolis 4, Ind.	155 E. Market St.	Springfield, Mo.	961 S. Weller
Jackson 6, Mich.	1514 Daniel Road	Syracuse 2, N. Y.	221 Erie Blvd. W.
Jackson, Miss.	654 S. Roach St.	Tampa 2, Florida	306 No. Newport Ave.
Jacksonville, Fla.	1641 Landon Ave.	Topeka, Kan.	1428 Belle Ave.
Knoxville, Tenn.	4206 Terrace View Dr.	Union, N. J.	lorio Industrial Park
Lafayette, La.	1216 Mudd Ave.	Wichita, Kan.	1400 N. Charles
Los Angeles 22, Calif.	7105 S. Paramount Blvd.	Zanesville, Ohio	Pershing Road

In Canada: Canadian Line Materials, Ltd., Toronto 13, Ontario

# BARRETT

## STORM KING<sup>†</sup> SELF-SEALING SHINGLES

...give your prospects a rugged roof—and a name they trust

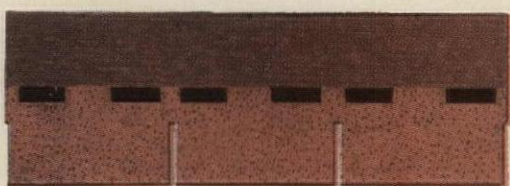

**1** POWERFUL BANDS OF ADHESIVE provide greater gripping area—for stronger bonding between shingles. You can show prospects the bands that will make their new roof wind-proof.

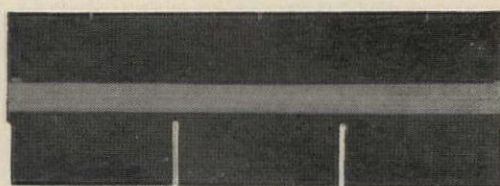

**2** NO EXTRA APPLIED COST! "Storm King" Shingles are packed and applied in the standard way. They do not take extra time to apply as do many other self-sealing shingles.



**3** DEFIES HURRICANE WINDS Why risk blown-off shingles on houses built but not yet sold. "Storm King" Shingles end your storm worries.



**4** BACKED BY THE BARRETT NAME, the greatest in roofing with a century-old reputation for delivering quality. Put Barrett on your list of famous brand names used in the homes you build.

A self-sealing shingle with real stay-power! For samples or further information write or wire us direct.

<sup>†</sup>Trade Mark of Allied Chemical Corp.

**BARRETT DIVISION**

40 Rector St., New York 6, N. Y.



# UTAH BUILDER CUTS PLUMBING COSTS 16% WITH COPPER

CANNON-PAPANIKOLAS CONSTRUCTION COMPANY, Salt Lake City, Utah, knew copper tube plumbing never rusts, resists corrosion. So they turned to their plumbing contractor, Roy Gandre Plumbing Company – told them to put copper hot and cold water lines in one house, rustable pipe in its identical neighbor – *and to keep detailed track of the costs of both installations.*

Results PROVE that copper – the top quality plumbing material – can be used in any house. Here's the record:

**"A" HOUSE** – installation completed Spring of 1958. Total cost of copper, including materials and labor was \$115.58. Total cost for galvanized, rustable lines was \$115.45. Note that this was the first time the plumbing contractor had worked with copper tube plumbing lines.



Larger of these two houses is first home equipped with copper tube plumbing in Cannon-Papanikolas development. Copper cost 13¢ more. Smaller home saved 16% using copper plumbing.

**"B" HOUSE** – a smaller residence in the same development. Total cost of copper \$52.00. Total cost of identical system using rustable pipe was \$62.00. **TOTAL SAVINGS 16% on job cost.**

Savings like these come naturally with copper on the job. Copper tube plumbing fits into construction easily without furring out or other costly extra carpentry. Long lengths of tube can be easily handled by one worker; sections are joined by strong, leak-proof and easily-made solder joints. And the smooth, clean, won't-rust interior of copper tube means greater flow of water.



Result of this striking side-by-side comparison test is that Cannon-Papanikolas is using copper in all future homes they plan. You too can take advantage of copper for its greater – and more sellable – value in the homes you build.



But to be sure of getting the best in copper tube, insist on tube made by Chase. It's clearly marked "Made in U.S.A." – and carries the Chase® trademark on every length – *your double assurance of quality.*

**Chase**   
**BRASS & COPPER CO.**  
 WATERBURY 20, CONN.  
 Subsidiary of  
**Kennecott Copper Corporation**

*The Nation's Headquarters for Aluminum, Brass, Copper and Stainless Steel*

Atlanta Baltimore Boston Charlotte Chicago Cincinnati Cleveland Dallas Denver Detroit Grand Rapids Houston Indianapolis Kansas City, Mo. Los Angeles Milwaukee Minneapolis Newark New Orleans New York (Maspeth, L.I.) Philadelphia Pittsburgh Providence Rochester St. Louis San Francisco Seattle Waterbury

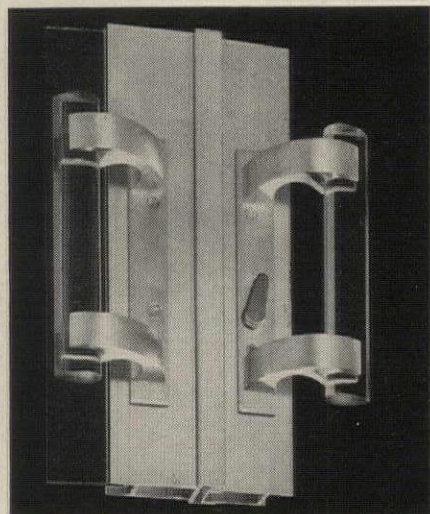

**H&D Inc, Everett, Wash.** Corona doors have several new features: new nail-on surround and angle-frame bracket, new solid lucite pulls (above), new fixed screen. Fixed screen is possible since all glass panels roll, one for ventilation, others for passage. Double mohair-pile weatherstripped jamb has 1 1/8" recess for sash stile. Header and meeting rails also have double weatherstrip. Sill weatherseal is attached to adjustable roller housings. Snap-on aluminum glazing bead. All parts are anodized.

For details, check No. 37 on coupon, p 264

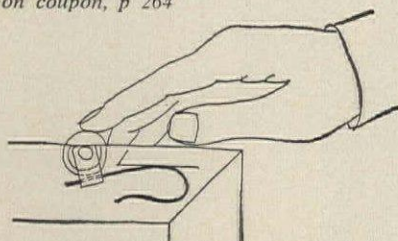

**Nudor, North Hollywood, Calif.** d'Cor, Nudor, and Hi-Lo doors now cover full price range (see sill and sash details on p 210). Top line d'Cor has heaviest extrusions, multiple pile weatherstrip at all points—even on the screen, snap-in glazing, flush trackless threshold, tandem rollers. Hi-Lo for single and 5/8" double glazing has light extrusions, single weatherstrip, single rollers, spring-loaded screen guide roller (above). Middle-range Nudor has many top-line features in medium-weight extrusions, will take full 1" insulating glass.

For details, check No. 38 on coupon, p 264

**Wooden sliders are coming back, too**



**Andersen Corp, Bayport, Minn.** New Patio Wall combines door-size sliding windows and hinged doors. Sliders take single or double glazing, ride on metal glides on plastic track.

For details, check No. 39 on coupon, p 264

**Outdoor Inc, Hales Corners, Wis.** Wood-framed sliding panels come in combinations to 16' wide, are designed to take 1" double glazing. Sheaves roll on extruded aluminum track on oak sill.

For details, check No. 40 on coupon, p 264

more New Products on p 222

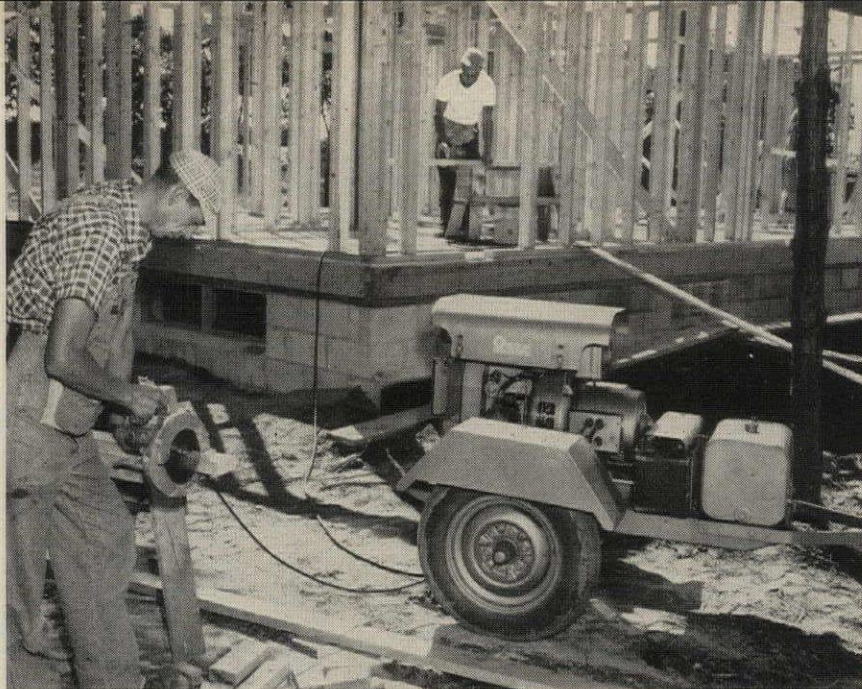

**New Onan Diesel Electric Plant Cuts Power Costs in Half!**

**3,000-watt, A.C. output powers tools and lights for big crew**

Lower fuel costs, less maintenance, and longer life of the new Onan Model 3DSL cut your costs per kilowatt to about half that of small gasoline-powered plants. Light in weight for a Diesel plant, the 3DSL on high speed trailer can be taken anywhere behind truck or car and is easily moved around on the job site.

This new small Diesel is powered by an Onan, single-cylinder, air-cooled full Diesel engine. Onan all-weather insulated generator is directly connected to the engine assuring permanent alignment and smoother operation. Vacu-Flo cooling permits a fully enclosed installation where desirable. Wide choice of voltages. Standard equipment includes weather hood, mounted muffler, oil filter, highly efficient dry type air filter, four plug-ins, fuel tank package and geared crank. Trailer is optional.



**Easy electric starting**—Flick a switch on the 3DSL and you've got power. Glow plug, intake air heater and automatic decompression assure quick starts even in cold weather. 12-volt battery charging output keeps starting battery fully charged at all times.

**New special contractors' model of the Onan 205AJ-1P; convenient separate gas tank . . . 2,500-watt A.C. output**

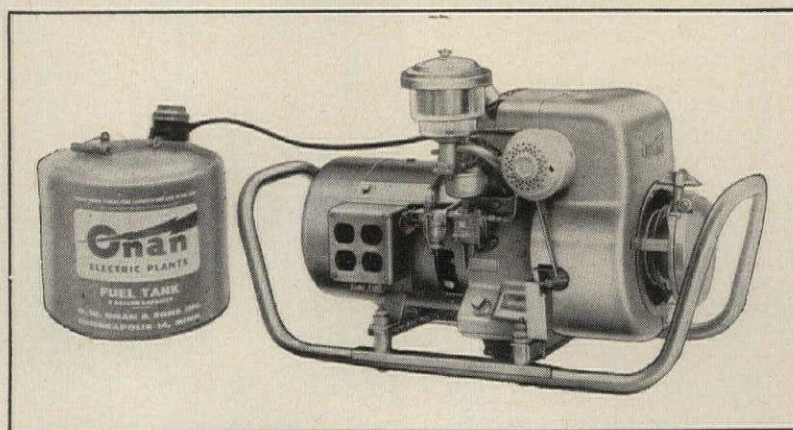

Our most popular size plant for building contractors. Big enough to keep several men busy with electric saws, drills, lights and other equipment . . . but light in weight. Choice of voltages. Powered by a rugged, 4-cycle

Onan gasoline engine. Four plug-ins. Equipped with aluminum carrying frame, oil bath air cleaner, recoil starter, separate 5-gallon fuel tank with quick-detachable fuel line. Two-wheel dolly available.

Check your phone book for name of your Onan distributor or write for folder on contractor models—500 to 10,000 watts.

**D. W. ONAN & SONS INC.** 

2915 UNIVERSITY AVE. S.E. • MINNEAPOLIS 14, MINNESOTA

# BEFORE YOU INSTALL ANY FLOORING

Read this about HARRIS BondWood®

## THESE FEATURES SAVE YOU MONEY!

**SOLID HARDWOOD FOR ADHESIVE INSTALLATION**—goes down and stays down in exclusive Harris Adhesive Mark 10 over concrete or wood.

**GREATER STABILITY**—Bond Wood changes grain direction every 4¾" resulting in a minimum of contraction and expansion.

**TIGHTER FIT**—Exclusive adhesive and unique construction prevents shifting—makes Bond Wood the most stable parquet ever designed.

**ELIMINATION OF SQUEAKS**—Bond Wood is solid hardwood, without tongue and groove—no hollow noise, no squeaking.



## THESE FEATURES MAKE YOU MONEY!

You'll find that Bond Wood's many advantages are immediately apparent to Home Buyers. Here's a parquet that lets you offer . . .

**UNLIMITED PATTERNS**—Bond Wood can be installed in a variety of patterns—plain, with divider strips, with insets, etc. Available in Oak, Walnut, Maple, Beech, Cherry and other domestic and imported hardwoods.

**NO DIRT-CATCHING CRACKS**—Bond Wood units are unbeveled, square-edged, with flush joints—no gaps, no cracks to catch dirt.

**THICKER, LONGER WEARING SURFACE**—Bond Wood's wearing surface is 81.8% thicker than laminated block. Gives years of extra life.

*Bond Wood units are 5/16" x 19" x 19", composed of 16 squares, 4¾" x 4¾", consisting of several small slats and held together with paper which is removed during installation.*



Send for free brochure today.  
See our catalog in Sweets.



## HARRIS BondWood®

QUALITY FLOORING SINCE 1898

HARRIS MANUFACTURING CO., DEPT. HH-39, JOHNSON CITY, TENN.

## New products

starts on p 210



**Universal built-ins** include 14 gas surface units, five oven-broiler units, in three price lines. All feature smokeproof broiling, balanced-heat ovens, controlled-heat top burners. Deluxe lines have time and temperature controls, signal lights, powered rotisseries, etc. Available in yellow, pink, turquoise, copper, and chrome.

Cribben & Sexton, Chicago.

For details, check No. 41 on coupon p 264

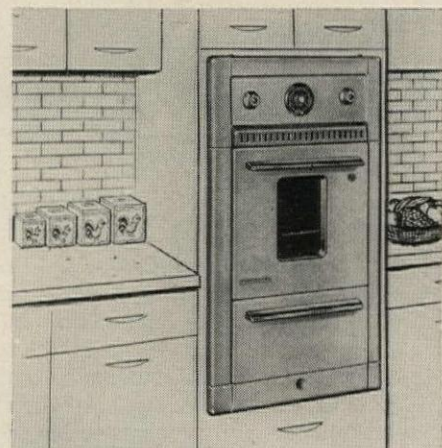

**Economy built-in ovens** in either gas or electric models are in the new Suburbanette line. Gas models have a large lower broiler; electric models come with or without broiler. All offer choice of stainless steel or eight colors to match stock Suburban countertop units.

Samuel Stamping, Chattanooga, Tenn.

For details, check No. 42 on coupon, p 264

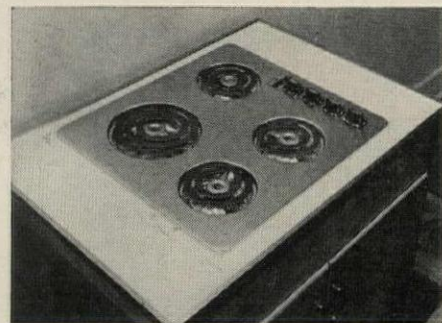

**Frigidaire 24" cooktop** is designed for drop-in installation, goes in place in 5½ minutes after opening is cut and wiring installed. Unit is only 3¾" deep, leaves plenty of space for drawers. Top has one 8", three 6" self-cleaning tube units. Controls at side are easy to see but out of reach of children.

Frigidaire, Dayton.

For details, check No. 43 on coupon, p 264

continued on p 226

# BRIXMENT MORTAR

## *Is Sound — Stays Sound*

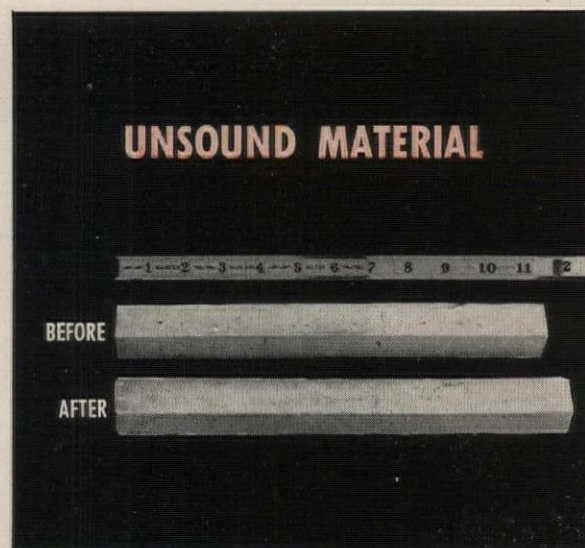
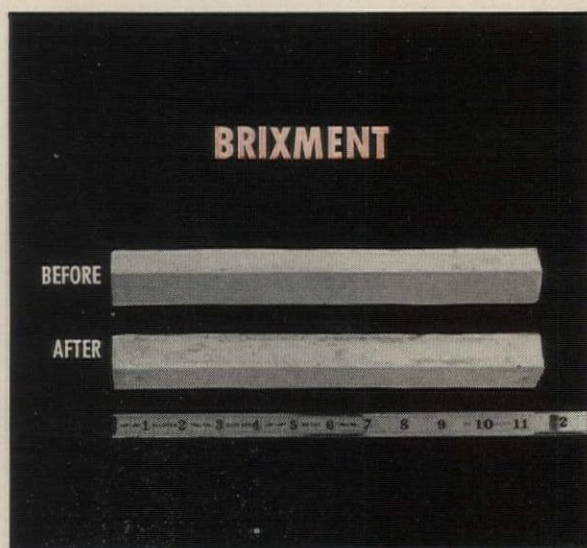

*In these autoclave tests, neat cement bars were exposed to 295 lbs. steam pressure, 420°F., for 3 hours. Left: The two bars are both Brixment. Note that it is sound—it has not*

*expanded. Right: The two bars were made of one part portland cement and one part of a lime which does not meet the autoclave test. Note the expansion—proof of unsoundness.*

### AND SOUND MORTAR IS ESSENTIAL FOR STRONG, DURABLE MASONRY

Some mortars may contain constituents which can cause them to expand or “grow” after long exposure to weather. Such mortar is called “unsound”.

The quality of soundness is easily proved by the autoclave test—an accelerated test under great heat and pressure in a steam chest.

Brixment makes sound mortar. It easily meets the autoclave test require-

ments included in Federal and ASTM Specifications for masonry cement.

Soundness is only one of many advantages which have helped make Brixment the most widely-used masonry cement on the market. It will be worth your while to hear *all* the advantages of Brixment the next time a Brixment salesman calls on you. Or write direct for full details. Address: Louisville Cement Company, Louisville 2, Kentucky.

**LOUISVILLE CEMENT COMPANY, LOUISVILLE 2, KENTUCKY**

*Cement Manufacturers Since 1830*

*So beautiful...and yet so practical...*

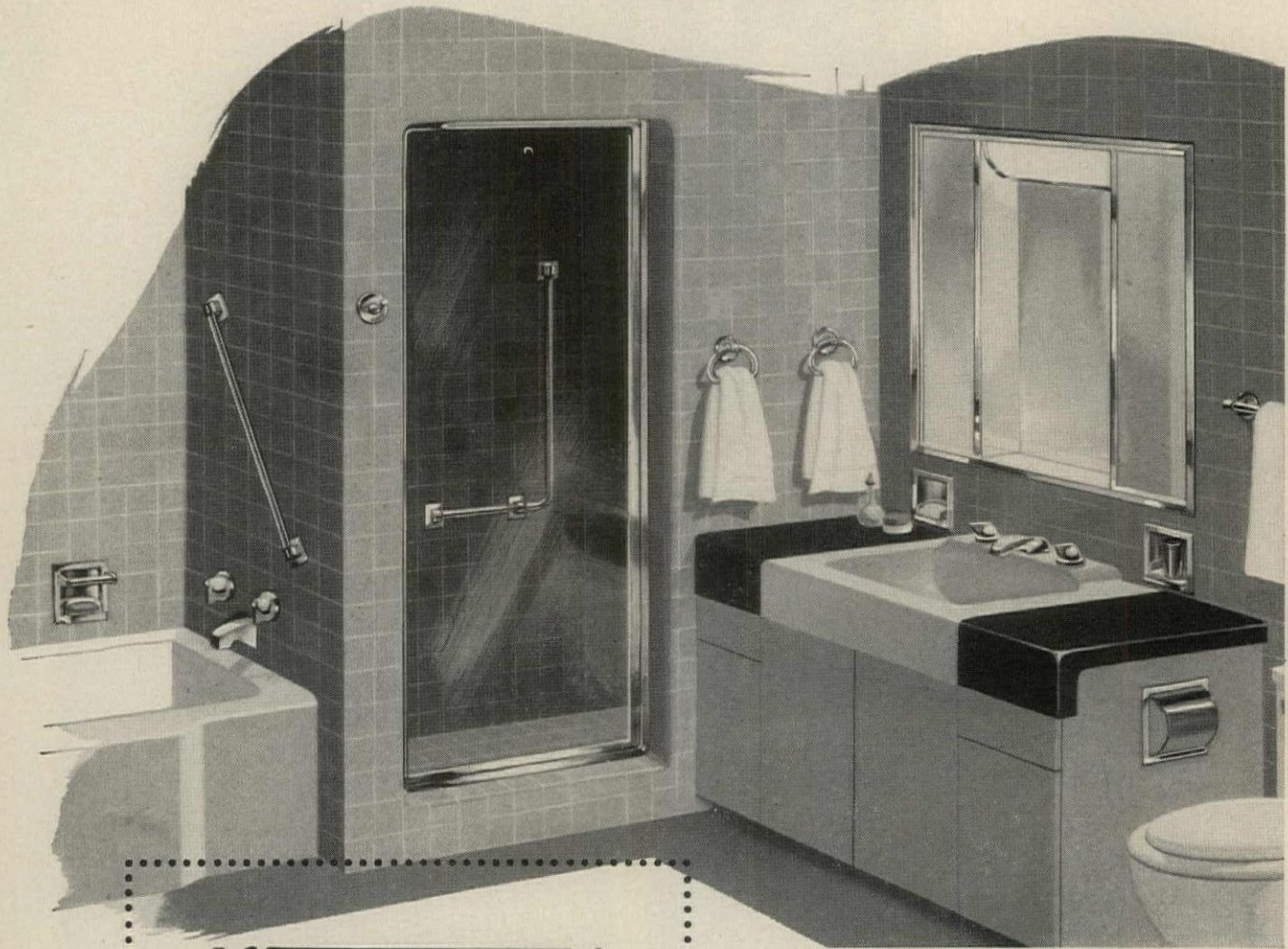

**HALL-MACK®**  
bathroom accessories  
in sparkling *chrome*

Life can be beautifully practical for those who have Hall-Mack bathroom accessories in their homes . . . because these choice fixtures have an inherent quality that equals their attractive appearance. Sparkling with real originality and blending smoothly with any decor, these deep-quality, chrome-plated accessories are styled in various price ranges to meet your taste and needs. For solid convenience and the extra glamour that creates satisfied customers . . . always specify and install Hall-Mack . . . the world's finest accessories.

Electric Warm-Dri Rack keeps towels dry and warm.

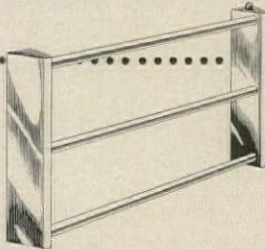

Attractive Extendo-Bar adds utility . . . retractable extensions pull out instantly for extra drying space.

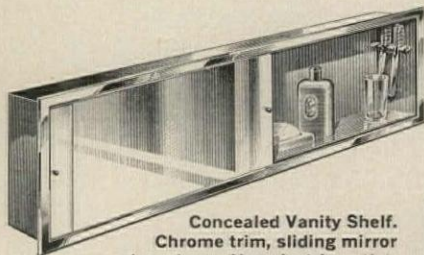

Concealed Vanity Shelf. Chrome trim, sliding mirror glass doors. Has electric outlet, tooth brush holder — lots of space for bottles, medicines, etc.

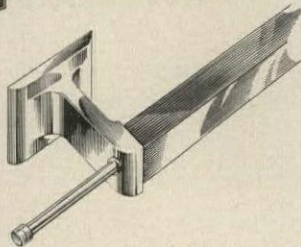

Sold by leading plumbing, tile, and hardware dealers everywhere.

**HALL-MACK COMPANY** Division of **TEXTRON INC.**  
1380 W. Washington Blvd., Los Angeles 7, California

Please send your FREE color booklet of new bathroom ideas

NAME \_\_\_\_\_

ADDRESS \_\_\_\_\_

CITY \_\_\_\_\_ ZONE \_\_\_\_\_ STATE \_\_\_\_\_

HH-29





## 95 SERIES

The hood with everything • Smart, slim-trim lines plus sparkling gold mylar instrument panel • Exclusive powerful 10 inch radial impeller—a must for efficient kitchen ventilation • Takes no cabinet space • Pre-wired • Easy to remove and clean filter • Tough epoxy finish.

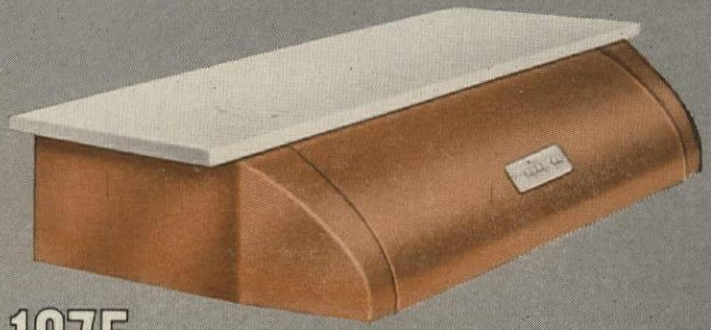

## 1075 SERIES

Adjusts from 30" to 42" to fit any standard or odd sized cabinet • Exclusive powerful 10" radial impeller for most efficient kitchen ventilation • Push button controls • Easy to clean filter • Built-in light.

# BUY FASCO HOODS FOR

- ▶ Fresh, modern styling
- ▶ Outstanding, exclusive features
- ▶ Easy, economical installations

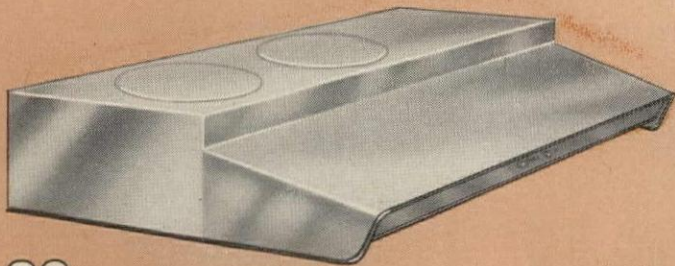

## 93 SERIES

Slim-trim, modern design • Can be used in kitchens that have in-the-wall ventilators. Gold mylar instrument panel • Pre-wired control switches • Built-in light • Durable epoxy finish.

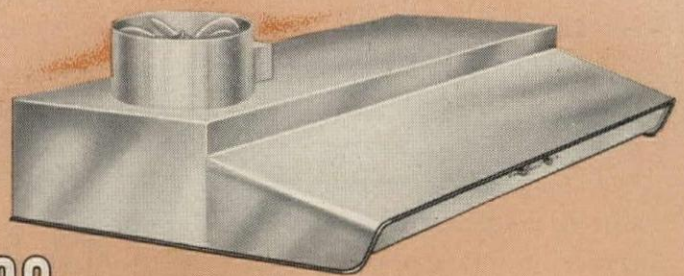

## 92 SERIES

Smart, slim-trim design at a budget price • Built-in light • Built-in filter • Low cost installation • Built-in ventilator • Vinyl safety trim • Up front controls.

### FASCO INDUSTRIES, INC.

North Union at Augusta  
Rochester 2, New York

Please send me full color, full line catalog.

Name \_\_\_\_\_ Company \_\_\_\_\_  
Street \_\_\_\_\_  
City \_\_\_\_\_ Zone \_\_\_\_\_ State \_\_\_\_\_



# PAYLOADER®

*handles materials 50% faster*



... Put a man on a rubber-tired "PAYLOADER" and there's no limit to the jobs he can handle ... no limit to the all-around utility use of this tractor-shovel on building job sites.

Owners report that a "PAYLOADER" moves 50% faster than track-type machines ... does more by traveling and working over sidewalks, curbs and roads without damage ... solves many problems in material handling because only "PAYLOADER", in the tractor-shovel field, has such a wide choice of attachments, quickly interchangeable with the bucket — such as the fork lift

(shown), hydraulic backhoe, black-top spreader, patented Drott "4-in-1" bucket, vibratory compactor, side boom.

If you want to reduce your equipment investment and operating costs, it will pay you to check the performance and usefulness of "PAYLOADER" tractor-shovels. There is a size and type to fit every need — up to 9,000 lb. carry capacity. Write for more information and name of the nearby "PAYLOADER" Distributor.

## HOUGH®

THE FRANK G. HOUGH CO.  
LIBERTYVILLE, ILLINOIS  
SUBSIDIARY — INTERNATIONAL HARVESTER COMPANY

**PURCHASE AND  
LEASE PLANS**  
**HOUGH**

Hough Distributors have the most complete set of financing plans ever offered — TIME PAYMENT, LEASING PLANS, with or without OPTION TO PURCHASE — to help you obtain "PAYLOADER" equipment.

Name \_\_\_\_\_  
 Title \_\_\_\_\_  
 Company \_\_\_\_\_  
 Street \_\_\_\_\_  
 City \_\_\_\_\_  
 State \_\_\_\_\_  
 3-B-6 \_\_\_\_\_ HH

## New products

starts on p 210



**Kirk gas refrigerator** is latest unit approved by AGA. First model in the line is this 10.2 cu ft box with 34-lb freezer. Five-year warranty. Kirk is planning smaller units and a gas-operated freezer. They also make kerosene-operated units.

Kirk Industries, Norwalk, Conn.

For details, check No. 44 on coupon, p 264

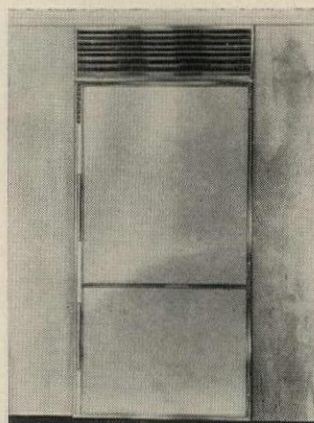

**Sub-Zero refrigerator** is over-and-under type with 11.7 cu ft of refrigerated storage, 6.5 cu ft of freezing space. Front panels can be wood, plastic laminates, wallpaper, or cloth to fit any decor. Line includes ten models with up to 16.9 cu ft of refrigeration, 14 cu ft of freezing. All are built-in type.

Sub-Zero, Madison, Wis.

For details, check No. 45 on coupon, p 264



**New Westinghouse units** have unique light-weight construction: walls are sandwich panels of aluminum and foamed styrene. This 13 cu ft model also has a new cold injector system and a new silent compressor. It comes in pink, aqua, white, yellow, copper, and chrome. Also new: 5 cu ft Lo-Boy model to fit under counter.

Westinghouse, Mansfield, Ohio.

For details, check No. 46 on coupon, p 264

continued on p 228

HOUSE & HOME

THE NATURAL BEAUTY OF California redwood is often specified by architects for its unique quality of complementing the texture of other materials . . . providing a rich contrast with the austerity of tile, brick and glass.

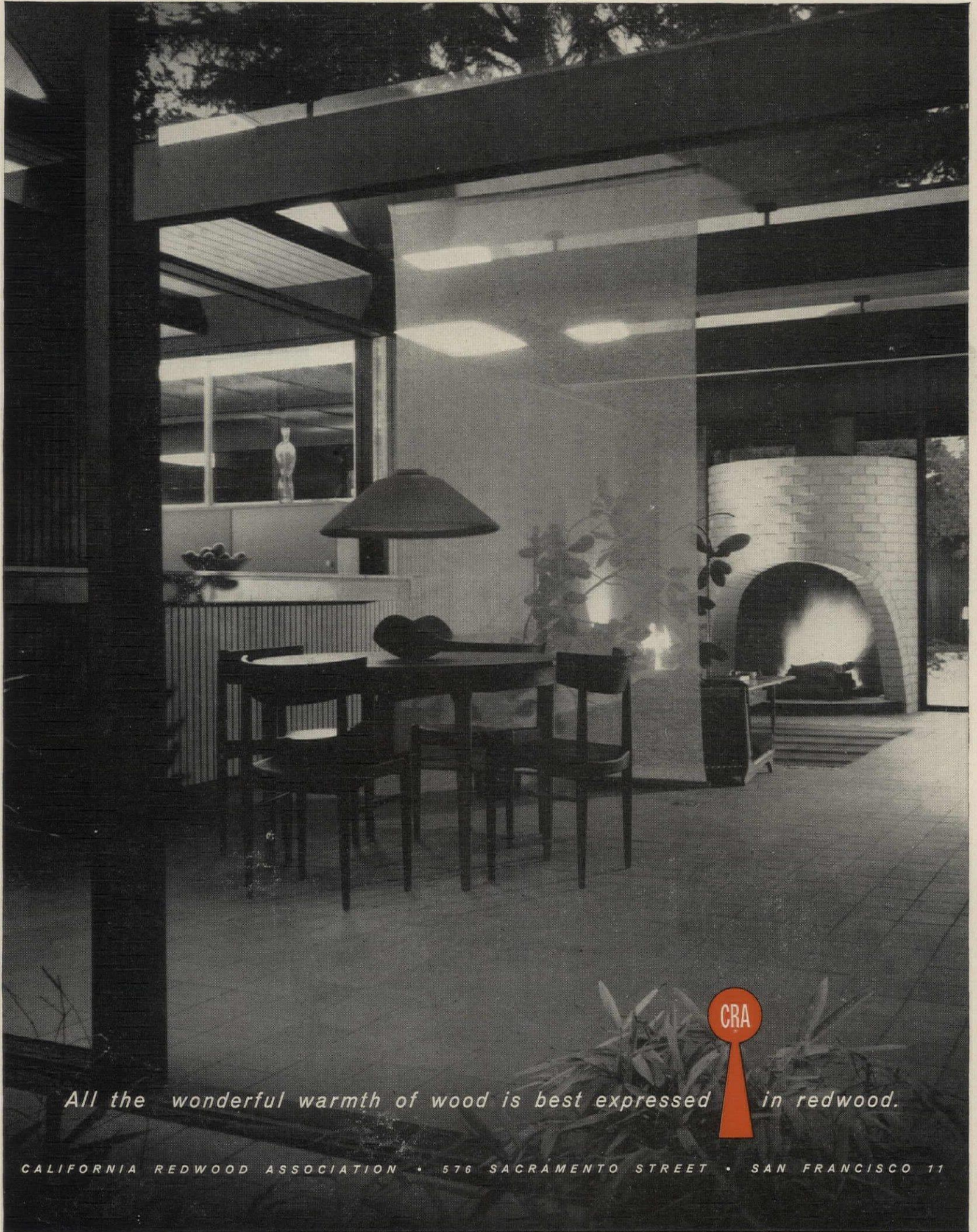

*All the wonderful warmth of wood is best expressed in redwood.*



CALIFORNIA REDWOOD ASSOCIATION • 576 SACRAMENTO STREET • SAN FRANCISCO 11

# Ventrola

the **QUALITY** line

Presents a **COMPLETE** line of **WALL** and **CEILING** **VENTILATORS** featuring

**MODEL 920**



... An Amazing **MULTI-POSITION VENTILATOR** with the **AUTOMATIC Weatherlok SHUTTER**

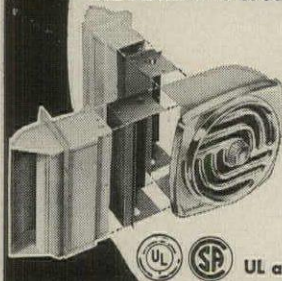

Solves any installation problem that arises.

Now it is possible to correctly locate a fan for maximum efficiency.

Easily Installs in Walls, Ceilings, Soffits or Cabinets.

UL and CSA approved

**PLUS RANGE HOODS** in 3 Push-button Controlled Series



COMPLETELY ADAPTABLE FOR ANY KITCHEN INSTALLATION

The 1500 Series

Features the "New Look" in contemporary design, engineered to Ventrola's famous standards of beauty, performance and dependability.



Factory installed fan housing. Unit completely pre-wired ... ready to install. Includes CONCEALED LIGHT FIXTURE, PUSH-BUTTON CONTROLS, FILTER and REDUCER WITH POSITIVE BACK-DRAFT SHUTTERS.

**1600 Series**  
Twin blower range hood ventilator

**1400 Series**  
Solid top hoods

"AS REFRESHING AS THE GREAT OUTDOORS"

products of  
**VENTROLA MANUFACTURING COMPANY**  
OWOSSO, MICHIGAN



Write for **COMPLETE** Information

See our **BRAND NEW Bathroom Combination HEATER, LIGHT & VENTILATING FAN**—and a completely **NEW BUDGET LINE** of Ventilating Fans ... the "VENAIRE" Builders' Models in addition to Ventrola Ventilators and Range Hoods.

## New products

starts on p 210

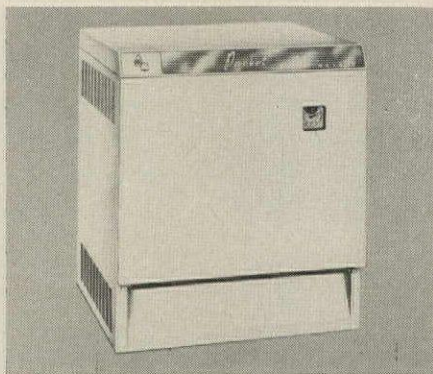

**Counter-height heater** supplies hydronic heating and household hot water in a unit that fits a space 26"x31", 37" high. Packet II has an SBI rating of 74,000 Btuh when oil fired; 60,000 to 69,000 Btuh when gas fired. Tankless water heater will put out 3½ gpm. Unit is packaged assembled.

National-US Radiator, Johnstown, Pa.  
For details, check No. 47 on coupon, p 264

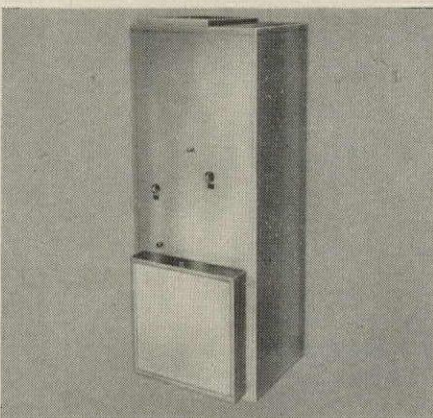

**Compact air-handling** for heating, cooling, and ventilating in patio apartments and motels is provided by Hastings Hide-a-way models. Units to fit 4 sq ft space handle 500 to 1100 cfm, include heating-cooling coil, blower, motor, filter, insulation, and cabinet. Price is competitive with simplest systems.

Hastings Air Control, Omaha.  
For details, check No. 48 on coupon, p 264

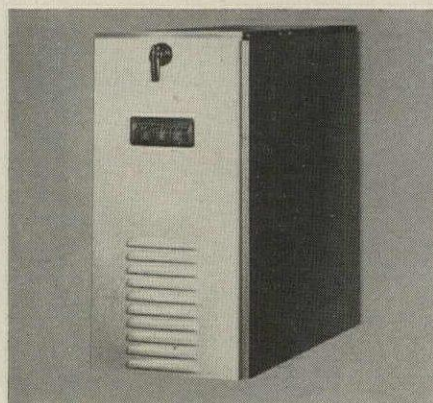

**Builder-market boiler** with a 95,000 Btuh input, 76,000 Btuh output, can meet needs of 80% of new houses. Hydrotherm claims. New cast-iron M-95 model is gas-fired, is rated at 380 sq ft of installed radiation by IBR standards, will raise 90 gal of water 60F per hour.

Hydrotherm, Inc, Northvale, N.J.  
For details, check No. 49 on coupon, p 264

Unique roof of Wolmanized® lumber protects this modern store



For lasting protection against termites and decay, Wolmanized® lumber was used in the roof and throughout McNerny's handsome new store on the Royal Hawaiian grounds at Waikiki. A total of seventy-seven thousand board feet of Wolmanized pressure-treated lumber was used for the store.

The unusual roof was constructed of Wolmanized Douglas Fir, 2-inch tongue-in-groove sheathing. Copper roofing was then applied to conform to the interesting ribbed design.

To acquaint you with the many advantages of decay and termite protected Wolmanized lumber, and how you can use it in light, heavy, and residential construction, send for the 16-page booklet that's free for the asking. Or, if you are in the tropics, ask for our new "tropical" brochure. Mail the coupon today.

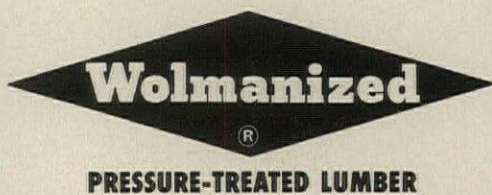

Wolman Preservative Department,  
Koppers Company, Inc.  
753 Koppers Bldg., Pittsburgh 19, Pa.



Please send me the 16-page brochure on the use of Wolmanized pressure-treated lumber.

Name \_\_\_\_\_ Title \_\_\_\_\_  
Firm \_\_\_\_\_  
Address \_\_\_\_\_  
City, Zone, State \_\_\_\_\_



**Wolmanized®**  
PRESSURE-TREATED LUMBER

continued on p 231

**ZEGERS  
BALANCED TAKE-OUT  
WINDOW EQUIPMENT**

**new**

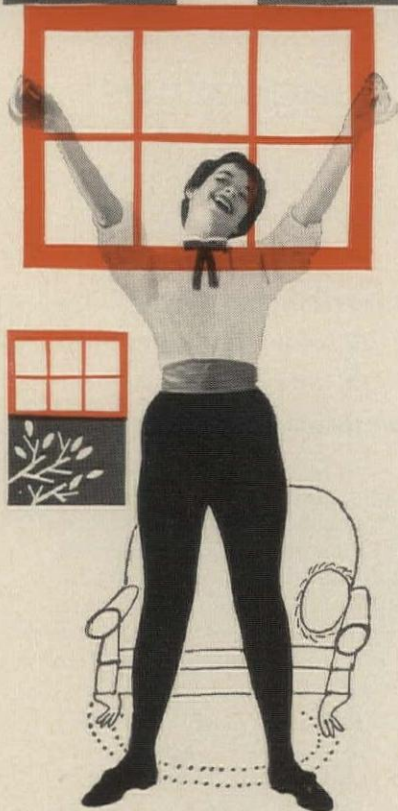

**new!**

**ZEGERS TAKE-OUT... "A TOUCH AND IT'S OUT"** Just a slight pressure on the interior left side and either sash is very easily removed or replaced.



**new!**

**ZEGERS EXCLUSIVE "DUAL" BALANCING** Balances on both sides of each sash prevent tilting; "Dual" balancing provides the most efficient weatherstripping and easiest window operation.

**new**



**new!**

**ZEGERS TAKE-OUT HAS EFFICIENT DURA-SEAL WEATHERSTRIPPING** The "match test" proves it! Nationally known and proven Zegers Dura-Seal weatherstripping makes Take-Out a stand-out. No cold or dirt can enter!

**\* Only Zegers Take-Out has these important features:  
"Dual" balancing plus Dura-Seal weatherstripping!**

Now you can offer your customers the best removable window on the market . . . equipped with Zegers Take-Out. It's the easiest to move—and remove. Because of its superior weatherstripping and proper balancing it now makes the take-out type window a *practical* window.

Despite all its luxury features, Zegers Take-Out equipment is low in price. It can be installed with stock frames and sash; no extra millwork parts are necessary to trim out the window.

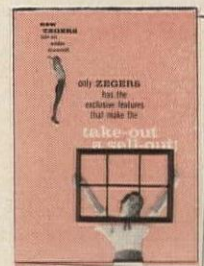

**SEND FOR NEW BOOKLET** that tells all about the Take-Out! To receive this fact-filled, illustrated booklet

Write to  
**ZEGERS, INCORPORATED**  
8090 South Chicago Ave.  
Chicago 17, Illinois

**ZEGERS**

**TAKE-OUT**



# Golden Folio

of outstanding homes built with  
new-type LIVING CONCRETE

appears April and May in top "home" magazines!

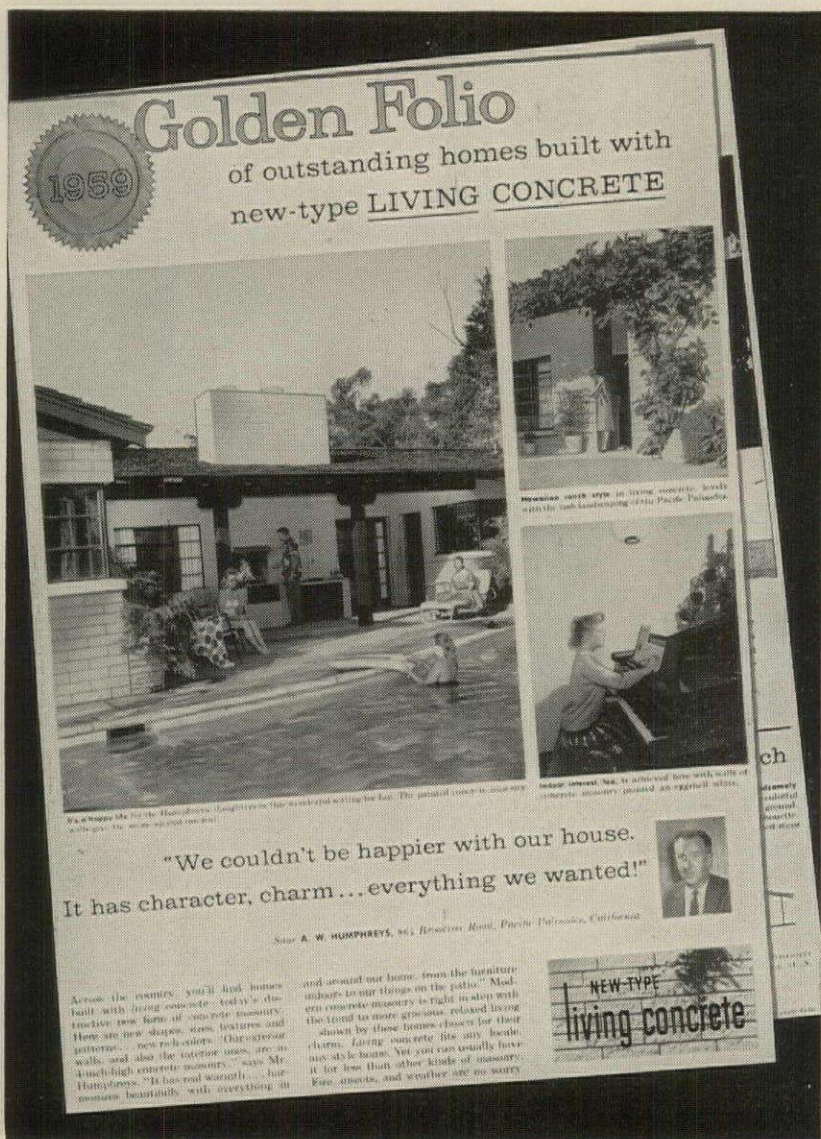

Newest advertisement by PCA —  
3 pages in full color—featuring beautiful homes of today's newest forms of concrete masonry!

Again, important promotion effort is being put behind the newer forms of concrete masonry. Another impressive advertisement in this continuing campaign dramatizes the story for millions of Americans... creates still greater acceptance for this building material so suited to modern moods and needs.

Spring breaks out in April and May, and so does this colorful 3-page folio—in Better Homes & Gardens, House Beautiful, House & Garden, and in Living for Young Homemakers.

Beautiful homes built with one of the countless new forms of concrete masonry are depicted. Each home dramatically illustrates how new sizes, textures and colors combine to create charm, character and livability. Here's striking evidence of how today's concrete masonry suits any style home, any locale.

All this is keyed to a descriptive and promotable idea... *new-type Living Concrete!* Architects, builders, financial people, as well as home buyers, are giving modern concrete masonry a fast-growing role in today's construction market.

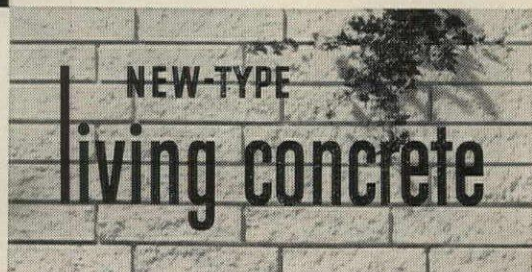

PORTLAND CEMENT ASSOCIATION

A national organization to improve and extend the uses of concrete

## New products

starts on p 210

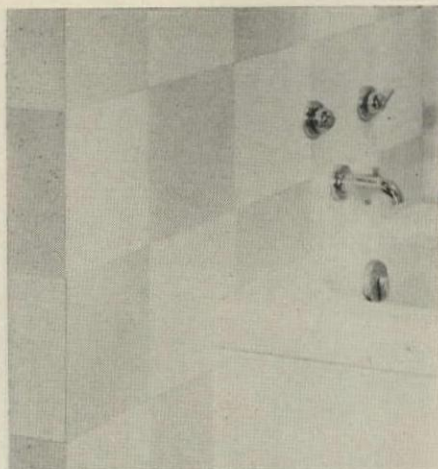

**Formica for bathrooms** is now made up in 10"x10" tile. The new tile can be installed on drywall, plywood, or aged plaster with Formica contact cement, is slightly flexible to allow easy installation. The tile is packed 50 to a box, six boxes to a carton, will cost from \$1.30 to \$1.50 per sq ft installed.

Formica Corp, Cincinnati.

For details, check No. 50 on coupon, p 264



**Square cast-iron tub** is new in Richmond's line. Pompeii tub is 48"x44"x16", is designed to give a large seat at the rear corner, full bathing space, and wide seat rim at the front. Available in white and six colors.

Richmond Plumbing, Metuchen, N.J.

For details, check No. 51 on coupon, p 264



**New translucent plastics** have been added to Kemlite's fiberglass reinforced sheets. Called Patnel, the new panels are light-weight, weather-resistant polyester with a wide variety of imbedments. Crests, monograms, or other custom designs can be imbedded on special order.

Kemlite Corp, Joliet, Ill.

For details, check No. 52 on coupon, p 264

continued on p 232

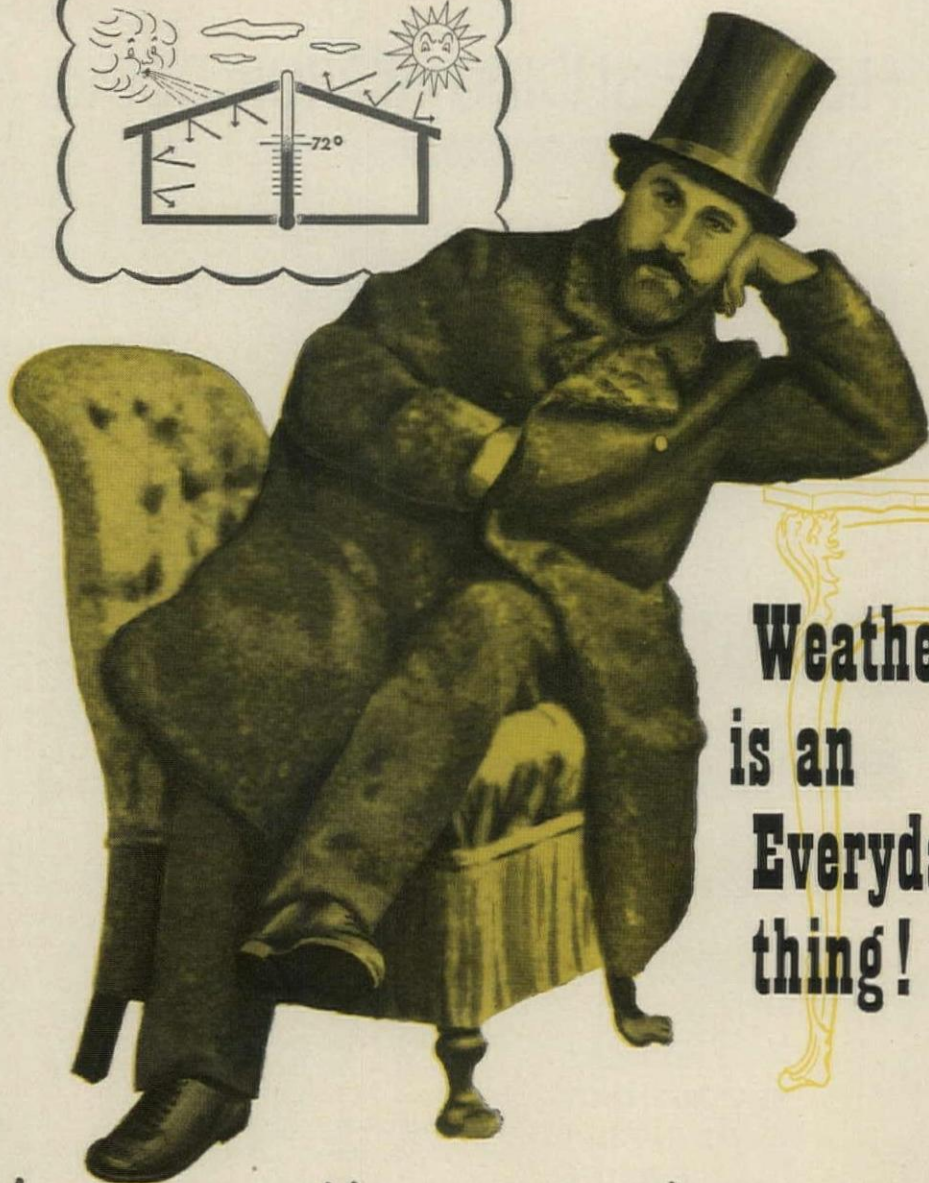
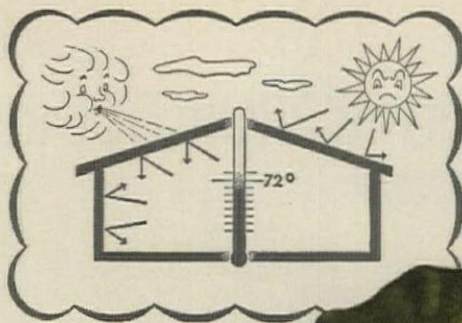

**Weather  
is an  
Everyday  
thing!**

Live comfortably — safeguard against  
heat or cold with **\*REFLECT-O-RAY**

Winter or summer — Uncle Fud had little household comfort to choose from in his day. But my — *how times have changed!* For instance, today you simply install insulation faced with REFLECT-O-RAY and automatically indoor living becomes more pleasant. Yes, weather is an everyday thing with REFLECT-O-RAY. Its millions of tiny, polished

aluminum flakes efficiently help keep heat where you want it, *in or out* and at lower cost to you! Remember, too, REFLECT-O-RAY is a natural *breather* that prevents damaging condensation build-up. So, don't settle for any "ho-hum" methods for safeguarding against heat or cold — Play it safe and invest in insulation faced with REFLECT-O-RAY.

\*REFLECTIVE "BREATHER" SHEET FACING

FOR INSULATION BLANKETS AND BATTS UTILIZING  
ON THESE AND OTHER FAMOUS BRAND INSULATIONS:



REFLECT-O-RAY is an Aluminum Pigmented product of  
**THE APPLETON COATED PAPER COMPANY**  
APPLETON, WISCONSIN

# FLEETLITE SLIDING MIRROR DOORS



*Add the Touch  
that Closes Sales!*

**QUALITY  
FEATURES THAT  
DISTINGUISH  
FLEETLITE  
SLIDING MIRROR  
DOORS**

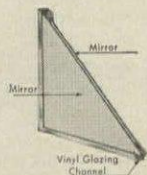

*Exclusive design permits double mirror glazing or a combination of mirrors and decorative material.*



*Offset adjustment bolts make door alignment easy. No notching or cutouts necessary.*



**FLEET OF AMERICA, INC., DEPT. HH-39  
2015 WALDEN AVE., BUFFALO 25, N. Y.**

Watch your prospects when they see the exciting new Fleetlite Sliding Mirror Door in your model home. Floor to ceiling sparkling mirrors reflect the loveliness of the room decor... double the beauty and color... add spaciousness and charm that will captivate the home buyer. Watch the woman in particular and you'll see the sales appeal of this new decorating idea.

Fleetlite Sliding Mirror Doors have that important difference which motivates sales. With crystal clear mirrors and a hardboard backing, they turn a drab closet area into the beauty spot of any room. With mirrors back-to-back, they form distinctive room dividers or provide full length dressing mirrors between the master bedroom and adjoining bath. This double mirror glazing is a Fleetlite exclusive made possible by offset adjustment bolts in a unique frame design.

By-pass, single and double wall pocket doors are available in heights of 6'8" and 8'0". Widths for two panel by-pass and double pocket doors range from 3'0" to 12'0"; single pocket doors from 2'6" to 6'0". Ribbon slim aluminum frames may be clear or gold anodized.

Write for literature.

## New products

starts on p 210

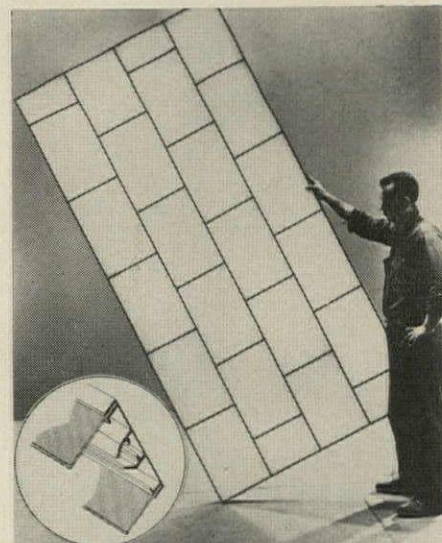

**Translucent sandwich panels** are made of reinforced polyester skins bonded to extruded aluminum frames and grids. Sanpan units transmit diffused light, weigh only 1½-lb per sq ft, are claimed to insulate better than glass block or double glazing. Standard panels are 4' wide, 1½" or 3" thick, 8', 10', 12', or 20' long. May be free-standing or interlocking.

Panel Structures, East Orange, N.J.

For details, check No. 53 on coupon, p 264

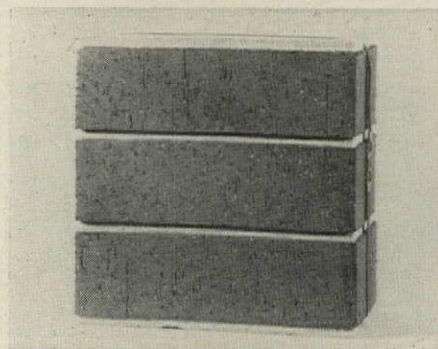

**Wire-cut velour brick** is a new texture, midway between smooth and matte finish, offered by Tebco. The new brick comes in two grays and three blends—tangerine, cinnamon tan, Burma gold—and in standard, Roman, or Norman size.

Evans Brick Co, Uhrichsville, Ohio

For details, check No. 54 on coupon, p 264

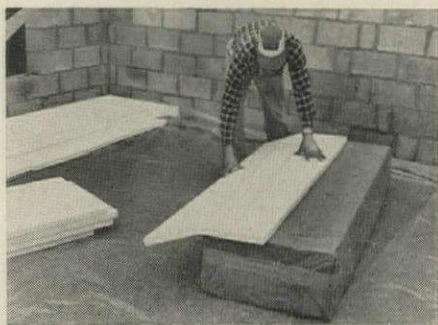

**Scored Armalite** is now available from Armstrong Cork. Foamed styrene insulation comes in 2'x6' sheets, 1", 1½", and 2" thick, scored lengthwise to make one 4", one 8", and two 6" strips. Styrene beads may be plain or self-extinguishing. Weight is .10 lb per bd ft, K factor is .25 at 75F. Armalite will support 720 psf with only 5% compression.

Armstrong Cork, Lancaster, Pa.

For details, check No. 55 on coupon, p 264

continued on p 234

HOUSE & HOME



Quality-Packed  
**NEW**

# THUNDERBIRD





by Inland Homes





Designed to sell for  
**\$8150** plus lot

The new Thunderbird opens up a whale of a big market for you — families that are hungry for a roomy, quality house with a small price tag.

*Look at these quality features of the Thunderbird.*

-  **12 Colonial, Contemporary, French Provincial and Ranch designs.** All architect-designed.
-  **Over 1000 sq. ft.** with big living room, extra large kitchen, dining space, and 3 bedrooms.
-  **2" x 4" construction** throughout.
-  **Cedar shakes are factory applied** and double coursed. Horizontal siding also available, or sheathing only for brick.
-  **Double wall construction** with impregnated insulated sheathing.

Mr. Builder —  
We cordially invite you  
to use a Thunderbird Model  
Home in your subdivision  
at no cost to you during  
the 1959 building season.  
Write, wire or phone  
for complete information!  
Inland Homes Corporation

-  **Prehung flush doors** throughout.
-  **Wood kitchen cabinets.**
-  **Complies with FHA'S new MPS.**

**Get started TODAY.** For details on the Thunderbird and Model Home Plan, visit, write, or phone P. R. Thompson, Vice Pres., Sales—phone PRespect 3-7550, Piqua, Ohio.

## INLAND HOMES



INLAND HOMES CORPORATION • Plants in Piqua, Ohio and Hanover, Pa.

Manufacturer of America's Finest Homes

## New products

starts on p 210

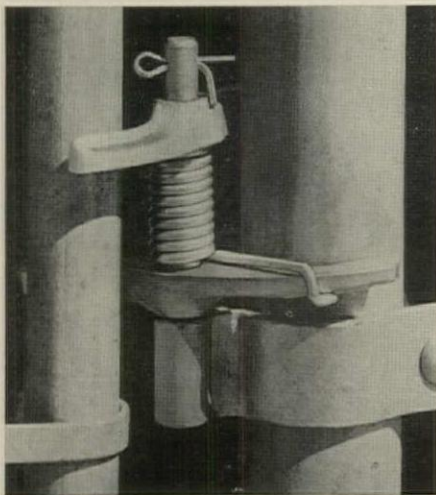

**Automatic gate closer** for suburban backyards fits any chain-link fence. Gate is held in rigid yoke; spring-loaded arms close it in either direction. Unit is rust-proof, can be installed in a minute with a wrench and hammer. Three sizes fit all metal gates.

Delbar Co, Boulder, Colo.

For details, check No. 56 on coupon, p 264

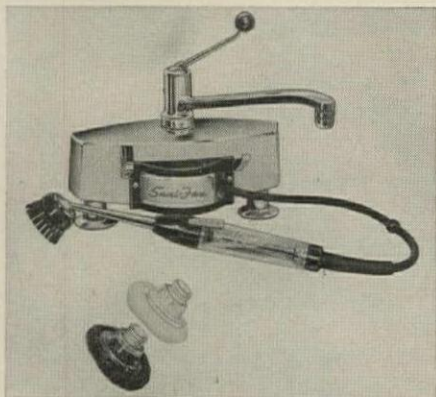

**Sani-Fax faucet dishwasher** like this is installed in South Bend NAHB research house. Single lever controls flow and temperature of water; pulling hose out of reel switches the flow from faucet to nylon brush head. Detergent is held in brush handle, can be added to the wash water at the touch of a lever.

Ruud Mfg Co, Pittsburgh.

For details, check No. 57 on coupon, p 264

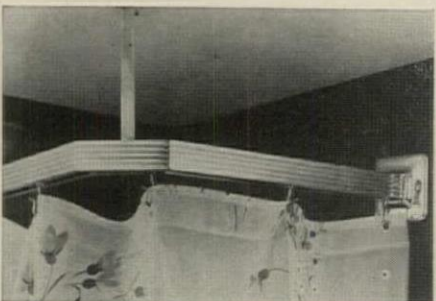

**Shower rod for corner tubs** is made by Magnalium. Heavy-gauge aluminum Shower Bar is ceiling supported, designed to fit any size or shape tub. Bar forms track for nylon slides of aluminum curtain hooks. Standard sizes are 5' and 5½' left or right hand or 4' square tubs.

Magnalium Products, Miami.

For details, check No. 58 on coupon, p 264

continued on p 238

# HERE ARE YOUR REVCO DISTRIBUTORS

Architects and builders have found the colorful new slide film, "How to Plan a Trend-Setting Kitchen," full of stimulating ideas for new kitchens. New ideas in layout, color, appliances and integration of the kitchen with the rest of the home are described and shown in sparkling detail. Call your closest distributor for a private showing.

### ALABAMA

**Birmingham**—FA 2-2561  
Long-Lewis Hardware Co.  
Major Appliance Division  
804 Fourth Avenue, N.

### ARIZONA

**Phoenix**—Alpine 8-8476  
Black and Ryan  
630 W. Washington St.

### ARKANSAS

**Little Rock**—Franklin 5-7349  
Royal Distributing Company  
1800 East 26th Street

### CALIFORNIA

**Covina**—Edgewood 9-6233  
Graham Wholesale Sup. Inc.  
834 Graham Way  
**Fresno**—Clinton 5-8336  
D & R Distributors  
1504 N. Maple  
**Modesto**—Lambert 3-0763  
Lavenson & Savasta Inc.  
1154 Scenic Drive  
**Oakland**—Kellogg 3-7544  
California Built-In Supply Co.  
2015 East 12th Street  
**Sacramento**, Gladstone 1-7273  
Appliance Distributing Co.  
7500 14th Avenue  
**San Diego**—Atwater 2-6800  
Strong Enterprises  
4309 Ohio Street  
**Santa Ana**—Kimberly 7-4401  
Orange County Builders  
Appliance Supply  
310 East 5th Street  
**Santa Barbara**  
Woodland 5-3018  
H. T. Waller, Inc.  
120 Santa Barbara Street

### COLORADO

**Denver**—Amherst 6-0221  
Nelson Williams Distr. Co.  
22 Wazee Market

### CONNECTICUT

**Lower Fairfield County**—  
Goldman-Feder Inc.  
300 Northern Blvd.  
Great Neck, L. I., N. Y.  
Hunter 2-3500

**Bridgeport**—Edison 6-3881  
B. M. Tower Company  
15 Dewey Street  
**New Haven**—Main 4-3079  
B. M. Tower Company

### DISTRICT OF COLUMBIA

**Washington**, Lawrence 6-5573  
Douglas Distributing Corp.  
3521 V Street, N.E.

### DELAWARE

**S. S. Fretz Jr. Inc.**  
870 North 28th Street  
Philadelphia, Pa.  
Stevenson 7-3400

### FLORIDA

**Miami**—Newton 5-2411  
Kuppers, Inc.  
7285 N. W. 36th Avenue  
**Saint Petersburg**—79-6281  
E. B. Smith, Inc.  
2700 22nd Street, N.

### GEORGIA

**Atlanta**—Trinity 6-1508  
Dixie Appliance Distributors  
708 Spring Street, N.W.

### IDAHO

**Jensen-Byrd Company**  
310-324 W. Riverside  
**Spokane, Washington**—  
Madison 4-1321  
General Appliance Corp.  
341 Rio Grande Street  
**Salt Lake City, Utah**—  
DA 8-8851

### ILLINOIS

**Chicago**—Whitehall 3-1200  
Remco, Inc.  
545 North LaSalle St.  
**Rock Island**—8-4585  
B & M Electrical Dist. Co.  
2927 Fifth Avenue

### INDIANA

**Evansville**—Harrison 4-3503  
Harrell Building Supplies, Inc.  
507-511 Oak Street  
**Fort Wayne**—Eastbrook 4147  
IMO Distributors, Inc.  
201 S. Calhoun Street

### INDIANA (Contd.)

**Indianapolis**—Walnut 6-5359  
Mutterspaugh Napanee  
Kitchens  
3750 N. College Avenue

**Indianapolis**—Melrose 7-1728  
Major Cabinet Co.  
311 E. Washington Street

**Muncie**—Atlas 4-7241  
Pippen's Napanee Kitchens  
507 N. Dill Street

**South Bend**—Atlantic 9-0395  
Cloud Brothers  
110 E. Western Avenue

**Terre Haute**—Crawford 1385  
Walker Elec. Supply Co., Inc.  
124-130 S. Third Street

### IOWA

**Des Moines**—Cherry 4-6267  
H. E. Sorenson Company  
100 S. W. First Street

**Sanborn**—55-J  
Porth-Early Company

### KANSAS

**Wichita**—Amherst 2-0530  
Kitchen & Furniture Lane, Inc.  
1634 East Central

### KENTUCKY

**Covington**—Axtel 1-3400  
B.A.M. Distributing Co., Inc.  
32 East 2nd Street

**Louisville**—Juniper 4-7232  
The Otis Hidden Company  
527-535 W. Main Street

### LOUISIANA

**Monroe**—Fairfax 2-3126  
The Southern Hdwe. Co., Ltd.  
108-110 Walnut Street

**New Orleans**—Amherst 15781  
Modern Appliance &  
Supply Co., Inc.  
555 North Scott

**Shreveport**—3-4111  
Adams-Hammett Lumber  
Co., Inc.  
3040 Mansfield Road

### MAINE

**Portland**—Spruce 4-0326  
The Boyd Corporation  
84 West Cove Street

### MARYLAND

**Baltimore**—Tuxedo 9-1201  
Douglas Distributing Corp.  
114 West 20th Street

### MASSACHUSETTS

**Somerville**—  
Monument 6-9680  
Gray Sales Company  
17 Ivaloo Street

**Springfield**—Republic 3-5105  
The Burden-Bryant Co.  
126 Liberty Street

### MICHIGAN

**Grand Rapids**—  
Glendale 9-0241  
Dyger Distributing Co.  
Ionia at Fulton

**Saginaw**—Pleasant 2-4182  
J. Geo. Fischer & Sons, Inc.  
2115 Rust Avenue

### MINNESOTA

**Duluth**—Randolph 2-7435  
Baxter Company  
1610 W. Michigan St.

**Minneapolis**—Federal 6-9621  
Century-Elcon, Inc.  
300 Washington Ave., N.

### MISSISSIPPI

**Shobe, Inc.**  
1195 Union Avenue  
Memphis, Tennessee—  
Broadway 2-3411

### MISSOURI

**Kansas City**, Westport 1-1190  
Reliance Appliance Distribs.  
3770-84 Broadway  
**St. Louis**—Sterling 1-9628  
Crest Corporation  
6417 Manchester

### MONTANA

**Billings**—7-7281  
American Appliance Co.  
2505 Montana Avenue

### NEBRASKA

**Omaha**—Webster 7676  
Graybar Electric Co.  
3626 Martha Street

### NEVADA

**Reno**—2-4028  
Heating & Air Conditioning  
Supply Co.  
555 East 4th Street

### NEW JERSEY

**Newark**—Bigelow 8-1127  
Reliable Electrical Supply Co.  
305-307 Springfield Avenue

### NEW YORK

**Albany**—62-1145  
Kitchen Distributors, Inc.  
153 Bradford Street

**New York City**  
Great Neck, L. I.—  
Hunter 2-3500  
Goldman-Feder, Inc.  
300 Northern Blvd.

**Rochester**—Butler 8-5810  
Redeker Brothers  
2154 Main Street, E.

**Syracuse**—GR 5-1654  
Modern Kitchens of  
Syracuse, Inc.  
1530 S. Salina Street

**Tonawanda**—Jackson 9000  
Weinheimer Supply Corp.  
1888 Niagara Falls Blvd.

**NORTH CAROLINA**  
**Charlotte**—Franklin 6-2761  
Twin States Distributing Co.  
1200 S. Graham Street

**NORTH DAKOTA**  
**Fargo**—2-3283  
Fargo Glass & Paint Co.  
648 N. P. Avenue

### OHIO

**Akron**—Blackstone 3-2141  
Sacks Electrical Supply Co.  
711 Johnston Street

**Canton**—Glendale 4-3033  
The Furbay Elec. Supply Co.  
115 Schroyer Avenue, S.W.

**Cincinnati**—Axtel 1-3400  
B.A.M. Distributing Co. Inc.  
32 East 2nd Street

**Covington, Kentucky**  
**Cleveland**—Tower 1-3200  
Midland Electric Company  
2125 Superior Avenue

**Columbus**—Capital 8-4351  
Luethi and Welch, Inc.  
73 East Naghten Street

**Dayton**—Baldwin 8-9114  
M. J. Gibbons Supply Co.  
601 E. Monument Avenue

**Toledo**—Cherry 3-5266  
McGranahan Distributing Co.  
1920 North 13th Street

### OKLAHOMA

**Oklahoma City**, Forest 5-3465  
Oklahoma Electrical Sup. Co.  
427 N. W. 4th Street

### OREGON

**Portland**—CA 2-9411  
Eoff Electric Company  
509 N. W. 10th Street

### PENNSYLVANIA

**Geneseo**—2301  
Chapman-Burrows, Inc.

**Phila.**—Stevenson 7-3400  
S. S. Fretz, Jr., Inc.  
870 North 28th Street

**Pittsburgh**—Museum 3-3315  
Elias Distributors, Inc.  
5000 Baum Boulevard

**Pottsville**—Market 2-0490  
Biehl's, Inc.  
500 S. Centre Street

### RHODE ISLAND

**Gray Sales Company**  
17 Ivaloo Street  
Somerville, Mass.—  
Monument 6-9680

### SOUTH CAROLINA

**Twin States Distributing Co.**  
1200 S. Graham Street  
Charlotte, N. C.—  
Franklin 6-2761

### SOUTH DAKOTA

**Rapid City**—Fillmore 2-4846  
Building Material Distributors  
820 Rapid Street

### SIoux FALLS

—2-5332  
Porth-Early Company  
8th and Reid Streets

### TENNESSEE

**Chattanooga**, Amhurst 5-1671  
Jones-Sylar Supply Company  
Manufacturers Road

**Kingsport**—Circle 6-8171  
Greene Hardware &  
Supply Co.  
703 E. Market St.

**Memphis**—Broadway 2-3411  
Shobe, Inc.  
1195 Union Avenue

**Nashville**—Alpine 4-0541  
Hermitage Elec. Supply Co.  
1402 Church Street

### TEXAS

**Dallas**—Fleetwood 7-1885  
Lone Star Wholesalers, Inc.  
8000 Ambassador Row

**Houston**—Jackson 8-4168  
Dickey Distributing Company  
2719 Westheimer Road

**Lubbock**—Porter 5-8581  
Anderson-Young Electric Co.  
2002 Clovis Road

**San Antonio**—CA 3-2991  
Electrical Distributing Co.  
102 W. Josephine St.

**Wichita Falls**—723-4133  
Paulk's  
1111 Lamar

### UTAH

**Salt Lake City**—DA 8-8851  
General Appliance Corp.  
341 Rio Grande Street

### VERMONT

**Burden-Bryant Co.**  
126 Liberty Street  
Springfield, Mass.  
Republic 3-5105

### VIRGINIA

**Bristol**—North 9-2106  
Pete Moore Appliance Center  
1109 W. State Street

**Norfolk**—Madison 7-8501  
Custom Kitchen Distributors  
1080 West 37th Street

**Roanoke**—Diamond 3-9378  
Roanoke Wholesalers Inc.  
202 Bullitt Avenue, S.E.

### WASHINGTON

**Seattle**—Main 4-3644  
Modern Heating Supply Co.  
300 Pacific Coast Terminals

**Spokane**—Madison 4-1321  
Jensen-Byrd Company  
310-324 W. Riverside

### WEST VIRGINIA

**Huntington**—Hamilton 9-1395  
Cabinet Supplier, Inc.  
1449 Washington Avenue

### WISCONSIN

**Madison**—Alpine 5-0005  
Graybar Electric Company  
103 North Park St.

**Milwaukee**—Locust 2-9000  
Kitchenline Distributors, Inc.  
1718 North 1st Street

### WYOMING

**American Appliance Co.**  
2505 Montana Avenue  
Billings, Montana—7-7281  
Nelson Williams Distr. Co.  
22 Wazee Market  
Denver, Colorado  
Amherst 6-0221

### HAWAII

**Honolulu**—6-7781  
Hawaii Hotel & Restaurant  
Supply  
693 Ala Moana

### CANADA

**All Canada Except B. C.**  
Gilson Mfg. Co. Ltd.  
Guelph, Ontario  
Phone: Taylor 2-1110  
**British Columbia**  
Vancouver—Emerald 7327  
Associated Distributors Ltd.  
637 Kingsway

THIS IS ONE OF A SERIES OF REVCO BILT-IN ADS to appear in Better Homes & Gardens Kitchen Ideas and Home Building Ideas Annuals; House Beautiful; House & Garden; House & Home; Architectural Record; House Beautiful Building Manual; House & Garden Book of Building; Kitchen Business; and Builders' Kitchen Guide.



Kitchen by Design Dimensions, Inc.

## REVCO Bilt-In Refrigeration gives your kitchen a forever new look!



The newest idea in kitchens, a Revco Undercounter Refrigerator or Freezer—just where you want it. Wonderful in the kitchen, den, recreation room or bar.

Revco, first to introduce built-in refrigeration, has set a lasting trend. Because of their classic design, outstanding performance and enduring beauty, Revco Bilt-Ins have earned a place among the finer possessions in beautiful homes.

Revco owners never have to worry about annual model changes which make their kitchens obsolete.

There is no substitute for the charm and elegance that Revco Bilt-Ins impart to your new or remodeled kitchen. When you begin your kitchen planning, consider built-in refrigeration first.

Revco units are available in the incomparable *Gourmet* Refrigerator, the Custom Ice-maker and Custom Freezer. The unique modular design makes it possible to build in refrigerators and freezers anywhere, even under counters, in any combination, for the utmost in convenience and efficiency. Only Revco offers choice of finish: stainless steel, copper-glo, matching wood and 25 decorator colors.

Ask your qualified Trend Setting Kitchens Planning Center dealer to help plan a *forever new* kitchen just for you.

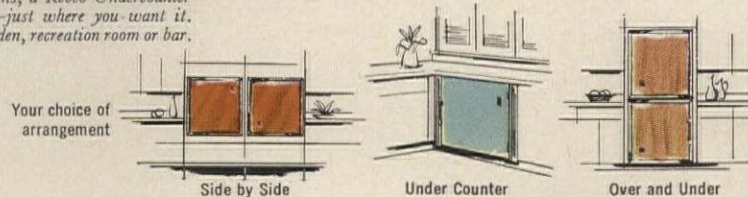

# REVCO

Setting trends in refrigeration since 1938

### Send for "HOW TO PLAN A TREND SETTING KITCHEN"

An outstanding collection of forever new kitchens, with exciting ideas for colors and arrangements.

Revco, Inc.  
Deerfield, Michigan      Dept. HH-39

Enclosed please find 25¢ to cover mailing and handling of "How to Plan a Trend Setting Kitchen."

I am interested in  new or  remodeled kitchens.

Name \_\_\_\_\_

Address \_\_\_\_\_

City \_\_\_\_\_ Zone \_\_\_\_\_ State \_\_\_\_\_



FOR MODERN LIVING... **Rangaire** KITCHEN RANGE HOODS

FOR MORE BREATHTAKING BEAUTY TODAY...

Regardless the kitchen decor you're planning, a fashion-styled Rangaire adds the final perfect touch. Choose from a selection of finishes that will delight . . . along with custom sizes for the most unique installation.

FOR THE SAME FRESH LOOK TOMORROW...

Through the years, Rangaire keeps kitchens fresh . . . cool . . . clean. Steam and greasy vapors are whisked away like magic; no worry about the fade and unsightly stain that the years bring ordinary kitchens. Rangaire is ageless . . . keeps kitchens new forever!



Rangaire range hoods are available color-matched to all major appliances.



Kitchen Range Hoods  
Home Radio Intercoms  
Air Conditioning Systems

**FREE!** Write for color brochure.  
Dept. K, Roberts Mfg. Co., Cleburne, Texas

YOU CAN LIVE BETTER...**ELECTRICALLY.**  
THIS HOME IS EQUIPPED WITH **QO**  
—THE FINEST CIRCUIT BREAKER EVER BUILT!

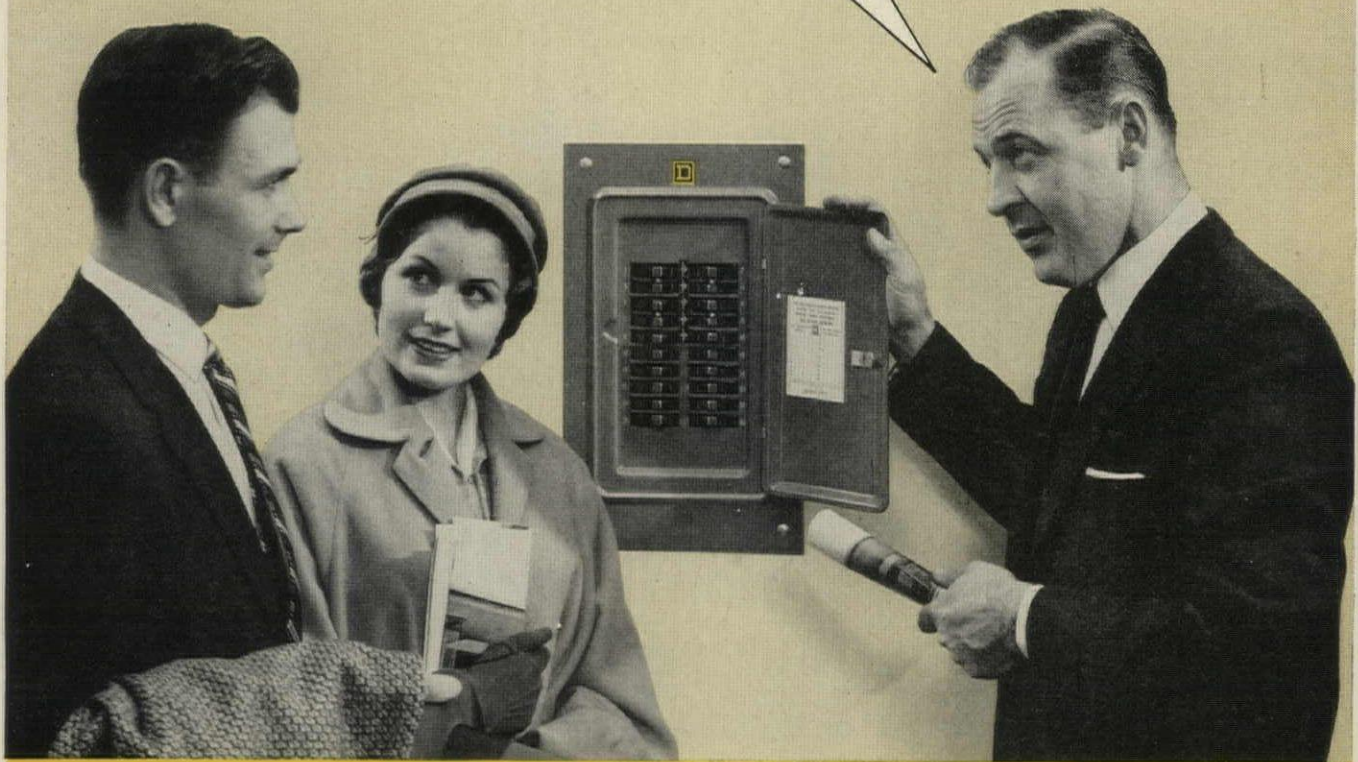

## It's very easy to prove that Circuit Breakers help sell homes!

• Today's home buyers are "housepower"-conscious. The "LIVE BETTER ELECTRICALLY" and "MEDALLION HOMES" programs have focused attention on the home's electrical system. Electrical equipment and appliances now are being provided and promoted as an integral part of the home. It takes adequate wiring to provide for these "built-in" electrical features and others that will be used later on.

When you install **QO** "qwik-open" circuit breakers in your homes, you have a potent selling feature. You're providing far more than just adequate wiring. You're providing convenience. There are no fuses to replace. Even a child can restore service, quickly and safely. You're provid-

ing modern protection against overloads and "shorts." And—you're providing for extra circuits as they're needed in the future.

You put a proven selling feature to work for you when you install **QO** — finest breaker ever built!

### THIS MAY BE FOR YOU

Square D has a "packaged" plan that helps sell homes. If you're interested, clip this panel, attach it to your letterhead and mail it to S. C. Hunt, Square D Company, 6060 Rivard Street, Detroit 11, Michigan.



**SQUARE D COMPANY**

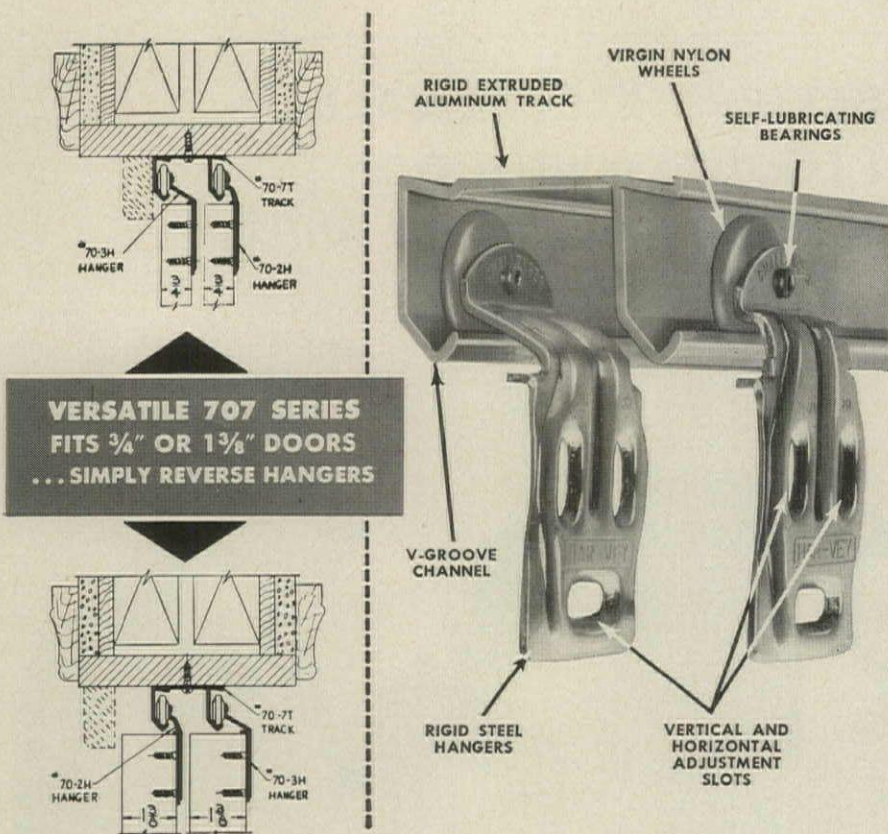

**VERSATILE 707 SERIES  
FITS 3/4" OR 1 3/8" DOORS  
... SIMPLY REVERSE HANGERS**

## NOW! NEW Har-Vey Handi-Pak includes Door Bumper

Versatile 707 Series fits 3/4" or 1 3/8" Sliding Doors

### DOOR BUMPER INCLUDED IN EVERY HANDI-PAK

Har-Veys Handi-Pak is the **most complete set available** and accommodates both 3/4" and 1 3/8" doors . . . there's only one set to handle. Complete easy to use Handi-Paks include extruded Aluminum Track, Hangers with self-lubricating Nylon Wheels, adjustable Nylon Door Guides, Cup Pulls and **DOOR BUMPERS**. Remember . . . compare before you buy. Look for the Har-Vey name stamped on metal parts . . . your assurance of superior quality.

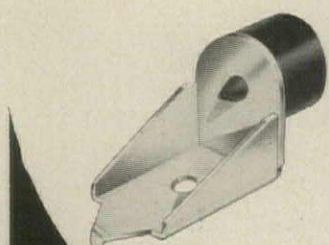

**Guaranteed** TO BE THE SMOOTHEST,  
QUIETEST SLIDING DOOR HARDWARE AVAILABLE

Write for **NEW AIA BULLETIN**



©1959 By  
**AMERICAN SCREEN PRODUCTS COMPANY**  
GENERAL OFFICES: 61 EAST NORTH AVENUE • NORTHLAKE, ILLINOIS



**New polyethylene tape** is pressure sensitive for sealing seams or patches in vapor barriers or tacking down any plastic, paper, or metal film. The tape will not shrink, dry out, crack, or get brittle, the manufacturers claim. The handy dispenser shown holds 100' of 2" tape.

Gering Products, Kenilworth, N.J.

For details, check No. 59 on coupon, p 264



**Hydraulic closer** for storm and screen doors closes the door evenly and smoothly over the full swing, increases power only in last inch of travel to assure firm latching. New unit is fully hydraulic, completely sealed, will operate under extremes of temperature. Life tests of one million closures without breakdown have been made. Unit carries a 15-year guarantee for home use.

Illinois Lock Co, Chicago.

For details, check No. 60 on coupon, p 264

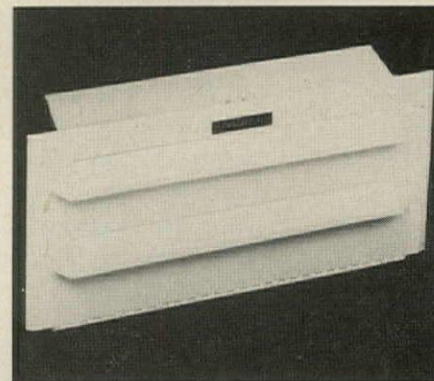

**Foil and paper dispensers** from Swanson now come in three types: the original three-roll type and new two-roll (above) and single-roll models. The double unit dispenses foil and wax paper, the single unit is for paper toweling.

Swanson Mfg Co, Owosso, Mich.

For details, check No. 61 on coupon, p 264

continued on p 242

HOUSE & HOME



# BES-STONE

## - the Split Block with Character!



BES-STONE gives a small home that expensive big residence appearance, without stretching the home-builder's budget.

BES-STONE Split Block actually has the appeal and durability of fine quarried stone. It also has another distinct advantage — ECONOMY. With BES-STONE, you get a wider range of beautiful colors, textures and patterns to meet new ideas or cost problems. It offers economy and versatility in construction, freedom from costly upkeep and a distinctive charm that lasts for years.

BES-STONE Split Block gives you beauty plus permanence. It meets all code requirements . . . is adaptable to all types of architecture . . . challenges the creative ability of both architect and builder. Ask your nearby Vibrapac block plant for new Bulletin No. 121 showing BES-STONE applications in natural colors, or write:

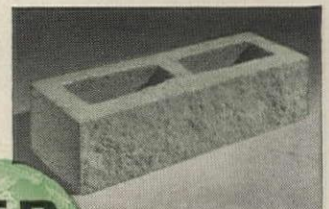

**BESSER Company**

Dept. 175, Alpena, Mich., U. S. A.

FIRST IN CONCRETE BLOCK MACHINES



BES-STONE is available in a variety of sizes and colors, for either veneer or solid masonry construction.

A7-135

# WESTERN RED CEDAR

*... native to better neighborhoods*

You can tell a really good district at a glance—and so can your customers! Fads and fancy stuff are at a minimum. The designs and materials are chosen for their enduring qualities of natural good looks and honest function. Triple-thick roofs of rugged cedar shingles... richly-textured walls of cedar shingles or shakes... are marks of the better neighborhood. For the house of cedar is the house of quality. And quality today—*more than any other single feature*—is apparent in the homes that sell.

## RED CEDAR SHINGLE BUREAU

5510 White Building, Seattle 1, Washington  
550 Burrard Street, Vancouver 1, B. C.

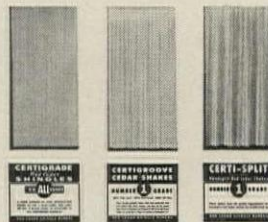

*For full application details on cedar shingles and shakes, see the current Sweet's Catalog...or send coupon...*

: NAME \_\_\_\_\_ :  
 : FIRM \_\_\_\_\_ :  
 : ADDRESS \_\_\_\_\_ :  
 : CITY \_\_\_\_\_ ZONE \_\_\_\_\_ STATE \_\_\_\_\_ :





**Gasoline, Diesel, or LP Gas**—New Multi-Range 6-cylinder engines for the International 460 Utility—gasoline, Diesel, LP Gas—deliver 61 hp at the fly-wheel, 48 at the drawbar.

**New International® 460 Utility tractor**

# ...SMOOTH 6-CYLINDER POWER

**with brawn to match!**

Add new Multi-Range 6-cylinder power to International's traditional built-in brawn . . . you literally step into a *new world of utility tractor performance!*

Here's sensationally SMOOTH power, virtually vibration-free, to lessen operator fatigue and thus step up daily output. It's *economical* power, because new Multi-Range design delivers remarkable fuel economy at every load range. It's *flexible* power, with instant governor response to load demand at any engine speed from 900 to 1,800 rpm. And it's power, *balanced* with built-in brawn, that delivers over 48 drawbar horsepower for the widest range of heavy-duty utility tractor work.

**Ask your IH dealer to demonstrate** the new 460 Utility . . . or others in the complete International line, 12.8 to 72.5 bare engine hp. For free catalog, or name of your nearest IH dealer, write International Harvester Company, Dept. PW-12, P. O. Box 7333, Chicago 80, Illinois.



See Your  
**INTERNATIONAL  
HARVESTER Dealer**

International Harvester Company products pay for themselves in use—Farm Tractors and Equipment . . . Twine . . . Commercial Wheel Tractors . . . Motor Trucks . . . Construction Equipment—General Office, Chicago 1, Illinois



**Built-in brawn** means tractor strength and stamina to handle big buckets on heavy-duty International Pippin or International Wagner backhoes—sizes for trenching to grade 10, 12½, or 13¼ feet deep.



**New Fast Reverser Unit** speeds up shuttle-type operations. In each of five gears, the reverse speed is 22 per cent faster than the forward speed in that gear.

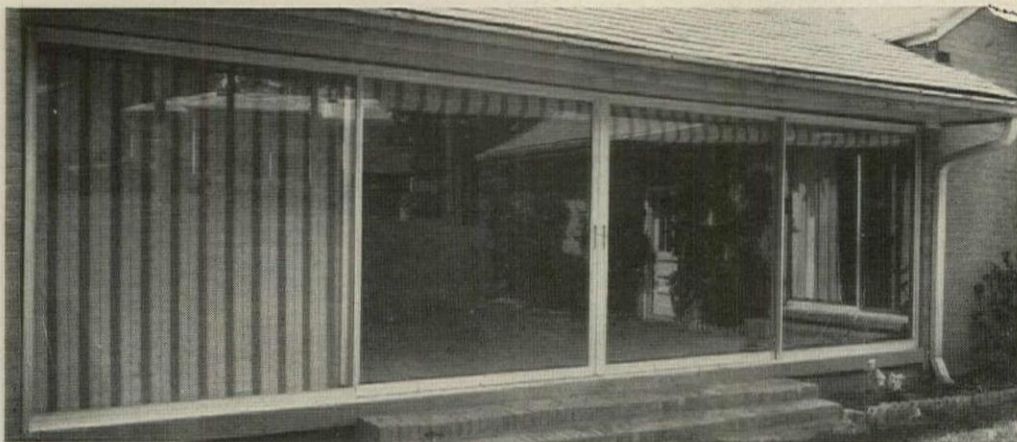

**Vue-Lume<sup>®</sup>**

**ROLLING GLASS DOORS...**

... the ONE line for all Requirements  
and All Budgets

**Fixed-Slider  
Single Glaze  
"BON AIR" series**

For single glazing. Any combination of fixed and rolling panels to fill any opening.

**Multi-Slider  
Single Glaze  
"De VILLE" series**

All panels roll. For single glazing. Any desired combination of tracks and panels allow complete versatility.

**Dual Glaze  
Multi-Slider  
"DEL RIO" series**

For dual glazing with 1" insulating glass, and adaptable also for 3/8" insulating glass. Multi-slider. Any desired combination of panels and tracks to fill any opening.

**and the NEW  
"THERMALUME"  
series...**

Available now is the NEW Vue-Lume "ThermaLume" which glazes with your choice of glass—3/16", 7/32", 1/4" or 5/8" dual glazing. Glazing interchangeable at any time.

**ALL Vue-Lume models finished in exclusive deep "Brite Alumilite."  
All models available in award-winning amber "Champagne" color finish.**

SHOWER DOOR COMPANY OF AMERICA, INC.  
Dept. HH 359  
One Permalume Place, N.W. Atlanta 18, Georgia

Name \_\_\_\_\_  
Address \_\_\_\_\_  
Company \_\_\_\_\_  
City \_\_\_\_\_ State \_\_\_\_\_



For full information, literature, and name of your local distributor, clip this coupon and mail

**New products**

starts on p 210

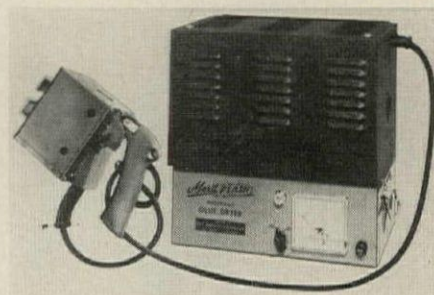

**Flash glue dryer** can cut need for jigs and clamps. Off-on switch gives equivalent of 3,000 Btu instantly, cures joints to 1/2" thick in seconds. Unit weights 35 lb, needs no special skill to operate; plugs into any 110-120-v outlet. Use will not mar finished surfaces.

Merit Short Wave Diathermy Co, Los Angeles.

For details, check No. 62 on coupon, p 264

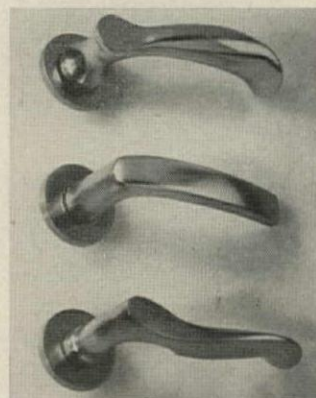

**German locks and trim** are now being brought into this country by Imported Hardware. The lever handles and trim are made by Wehag; mortise locksets by Zeiss Ikon are specially made as thin as 5/8" for narrow doors. Importer claims lever handle and mortise lock give easier operation and longer life than tubular locks at only a slight increase in cost.

Imported Hardware, Bloomfield Hills, Mich.

For details, check No. 63 on coupon, p 264



**Entrance handle lockset** by Kwikset is budget-priced, can be installed quickly with tools for Kwikset 400 line locksets. Made in cast brass, bronze, or aluminum, it may be keyed with any Kwikset entry lock and can have an interior knob in any 400 line style. Also available with 5" backset or dead latch.

Kwikset, Anaheim, Calif.

For details, check No. 64 on coupon, p 264

continued on p 244

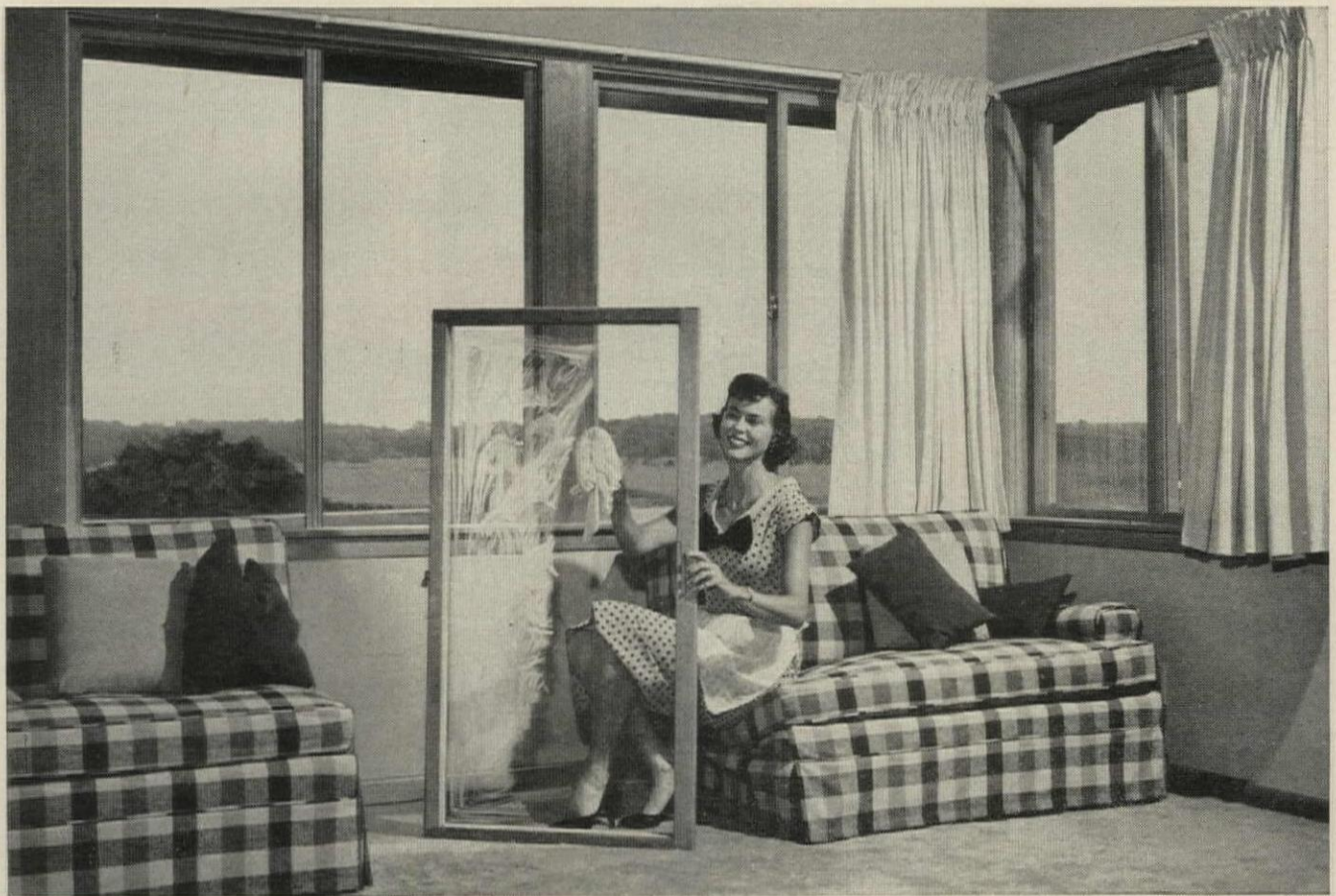

# Removability...

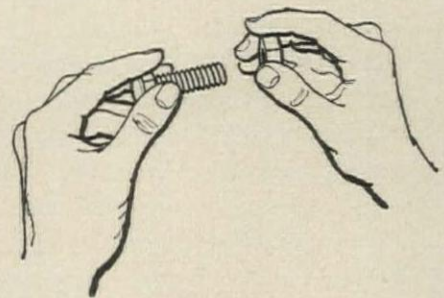

## **makes the difference**

**IN BUYER APPEAL**—because home buyers know how much easier it is to clean, paint or reglaze removable windows. Homes with R. O. W. windows are worth more, always.

**IN INSTALLATION TIME**—because with sash removed and stored safely, one man can install all but the largest R. O. W. units, alone. You'll save up to 50% in painting time, too, by painting sash on bench or easel.

**IN WEATHER PROTECTION**—because the same springs which permit instant R. O. W. sash removal also insure a snug all-season fit, free from rattles or sticking. It's easy to demonstrate the *extra* features.

*See your local lumber dealer or write—*

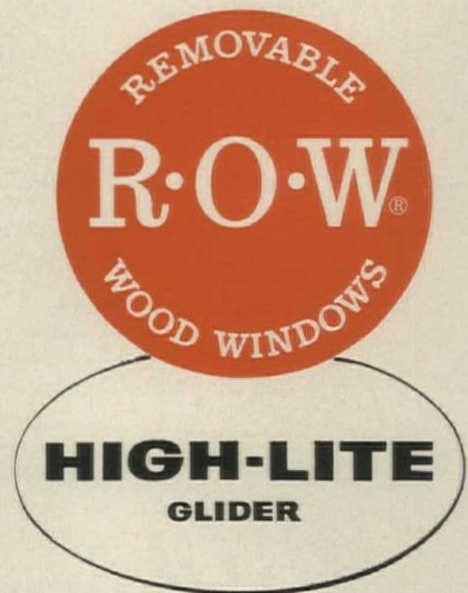

R·O·W is the registered trade-mark of the R·O·W Sales Company

**R·O·W SALES COMPANY • 1300-3 ACADEMY AVENUE • FERNDALE 20, MICHIGAN**

*Easier and  
Faster*  
to INSTALL

THE NEW

**McQuay**

STAINLESS STEEL FLUE

**PACKAGE CHIMNEY**



The new McQuay Package Chimney is the finest. It tests better because it is built better—by McQuay, with more than a third of a century of heating experience—and is easier and faster to install. Compare McQuay quality, compare erection time and costs, compare McQuay advantages. Then you'll see why the new McQuay Package Chimney excels in every way. See your jobber or write McQuay, Inc., 1629 Broadway Street N.E., Minneapolis 13, Minnesota.

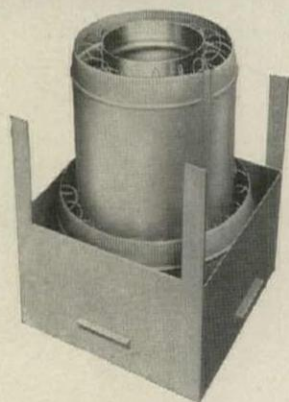

Starter Box and Starter Section in one unit for fast erection. Interliner and stainless steel flue supported by exclusive McQuay stainless steel and aluminized steel tension spring spacers. Permits quick drafts and even temperature top to bottom for peak efficiency under steady or intermittent firing.

*Check these features against those of any other chimney!*

- Stainless steel flue • Handles all fuels • Light weight • Strong and durable • Long life • Baked on finish • Quick installation
- Low installation costs • Competitively priced
- Safe — U.L. approved

**McQuay**  
It leans Quality

**McQuay** INC.

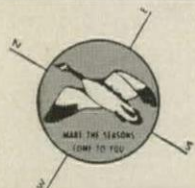

AIR CONDITIONING • HEATING • REFRIGERATION

**New products**

starts on p 210

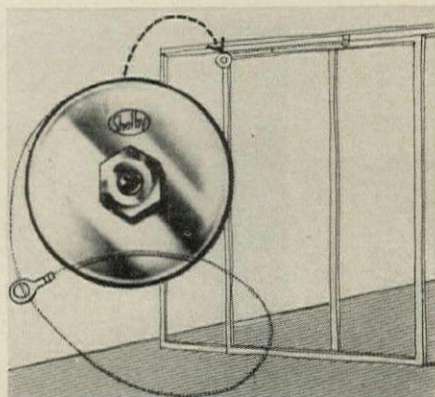

**Sliding glass door closer** to cut heating and cooling costs is available from Shelby Spring Hinge. Unit is spring powered, works on 5' stainless steel cable. Reel 3 3/8" in diameter, 13/16" thick, fastens to stile with one screw; hexagon nut adjusts tension. Finish is US15 dull nickel. List price: \$6.60.

Shelby Spring Hinge, Shelby, Ohio.

For details, check No. 65 on coupon, p 264

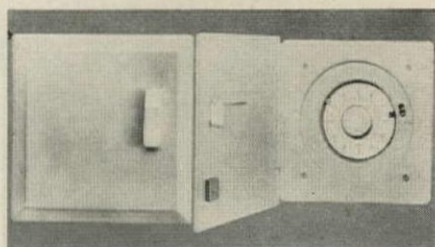

**Lamp-Lyter switch** gives automatic or manual control of up to 1650 watts of lighting for 15 minutes to 23 hours. Will turn on yard or house lights, air conditioners, radios, appliances, etc, daily at pre-set time. Junction box, 5"x5"x2 13/16"; cover plate, 6 1/2"x6 1/2", is held shut by magnet.

International Register, Chicago.

For details, check No. 66 on coupon, p 264

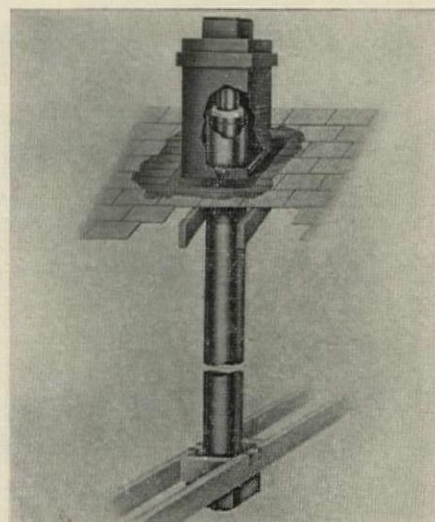

**All-steel, all-fuel chimney** can be installed in 30 minutes with just a hammer. Flue is lined with stainless steel, has an aluminized steel intermediate casing, galvanized outer casing. Chimney weighs 10 lb per ft, can be fired to 1700F, withstand 200 mph winds. Roof housings also act as attic vents.

Huncilman & Son, New Albany, Ind.

For details, check No. 67 on coupon, p 264

continued on p 248

HOUSE & HOME



12" x 24" panels with flange joint stapling edge makes application easy and rapid.

RELY ON

**Simpson**

**Forestone.**

ACOUSTICAL  
CEILING  
MATERIAL



## TODAY QUIET HOMES SELL BETTER...

Your customers want more *livability* and *luxury* in their homes . . . you can offer it to them with beautiful Forestone\* sound conditioning . . . at little or no extra cost!

Your own crew can install Forestone easily. Plan now to build this *visible* sales-plus into your next home. But be sure you get genuine fissured Forestone—not a look-like printed imitation.

Your customers know that Forestone adds lasting beauty to ceilings . . . absorbs up to 70% of all noise striking it . . . can be repainted repeatedly without appreciable loss of sound absorption or fissured texture . . . and is protected against termites, dry rot and mildew by special Biotox processing.

Investigate Forestone now. Ask your local Lumber Dealer, your Simpson Certified Acoustical Contractor, or write Simpson, 1008L White Bldg., Seattle, Washington.

See Simpson's full line of 'home building materials at the NAHB National Housing Center in Washington, D. C.

AI-820

\*REG. U. S. PAT. OFF. U. S. PAT. NO. 2,791,289

Rely on Simpson for the finest in Douglas Fir, Western Hemlock, Redwood Lumber; Acoustical, Insulating and Hardboard products; Plywoods and Doors.

# Sales-minded Builders are cashing-in on Orangeburg's biggest ad campaign right now!



**FIRST OF A SERIES** This colorful, full page ad appears in April 13th LIFE with an estimated audience of 32 million.

Once again, Orangeburg pulls out all stops to help you sell homes. During 1959, Orangeburg's quality story will be told again and again to more home buyers than ever before. With more ads! Bigger ads! All to help you make sales easier, to be sure of more satisfied customers. Why not join the sales-minded builders who now use *genuine* Orangeburg: *Root-Proof* Pipe and Fittings for house sewer lines, downspout run-offs...*Perforated* Pipe for foundation drains, septic tank filter beds, sub-surface drainage. "Look for the *Silver Band*\*" and make sure you get the *genuine* Orangeburg Brand. Write Dept. HH-39 for free catalog describing Orangeburg Pipe's many uses and time-saving advantages.



\* THE NAME ORANGEBURG AND THE SILVER BAND ARE REGISTERED TRADE-MARKS OF THE ORANGEBURG MANUFACTURING CO.

ORANGEBURG MANUFACTURING CO.  
Orangeburg, N. Y. Newark, Calif.  
A Division of The Flintkote Company, Manufacturers  
of America's Broadest Line of Building Products

***genuine* ORANGEBURG<sup>®</sup>**  
**Root-Proof Pipe and Fittings**



We back our dealers with a

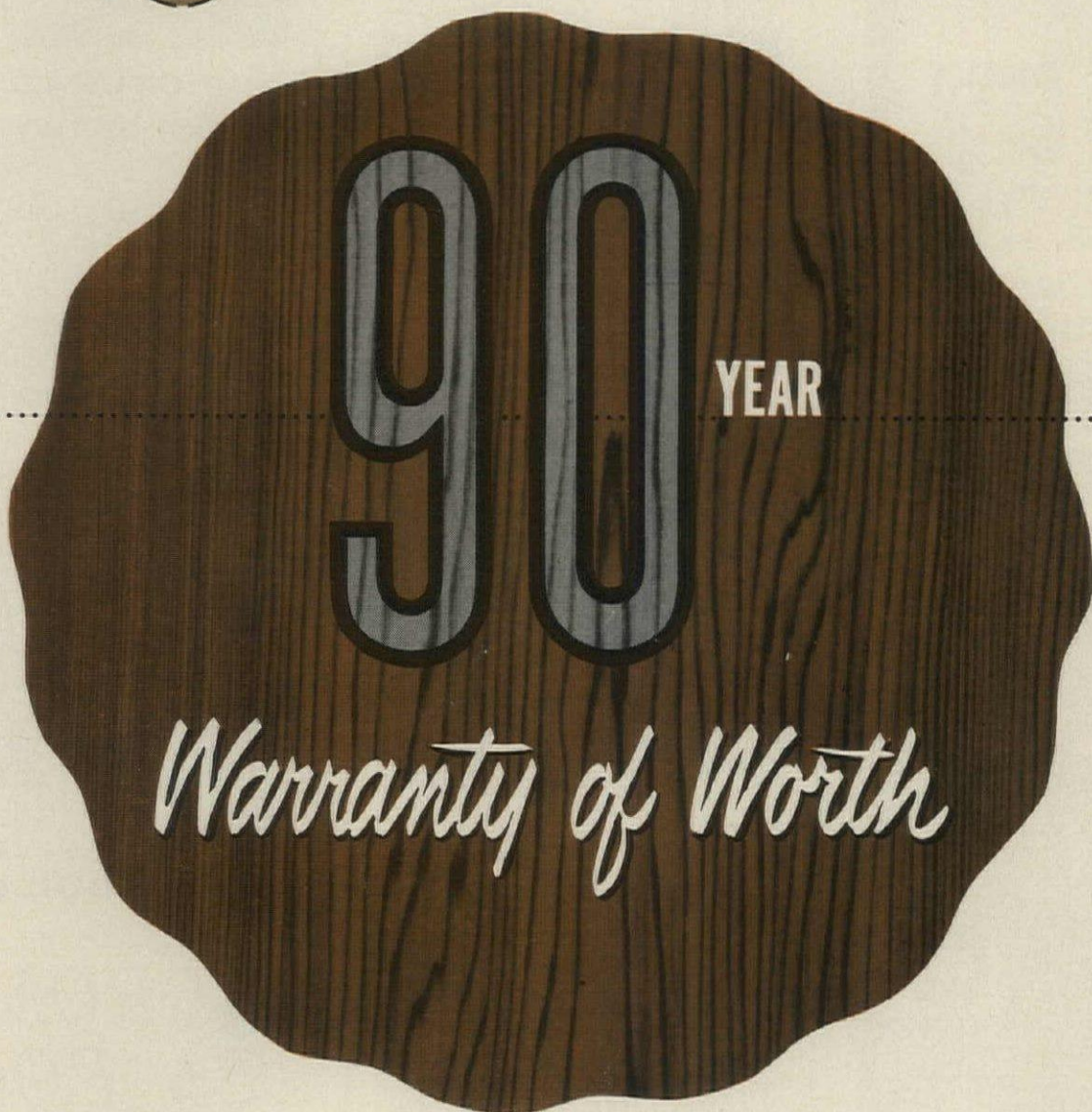

behind

**PALCO**®

**Architectural Quality REDWOOD**

Every piece of PALCO Architectural REDWOOD bears the 90 year mark of highest merit – the unqualified *Warranty of Worth* to all who sell, buy, and apply the finest in flawless perfection. *For the foremost in quality...*

*Better Buy PALCO – there's no better buy than the best.* 901



**THE PACIFIC LUMBER COMPANY**

*Since 1869 • Mills at Scotia, California*

100 BUSH ST., SAN FRANCISCO 4 • 35 E. WACKER DRIVE, CHICAGO 1  
2185 HUNTINGTON DRIVE, SAN MARINO 9, CALIF.

MEMBER OF CALIFORNIA REDWOOD ASSOCIATION



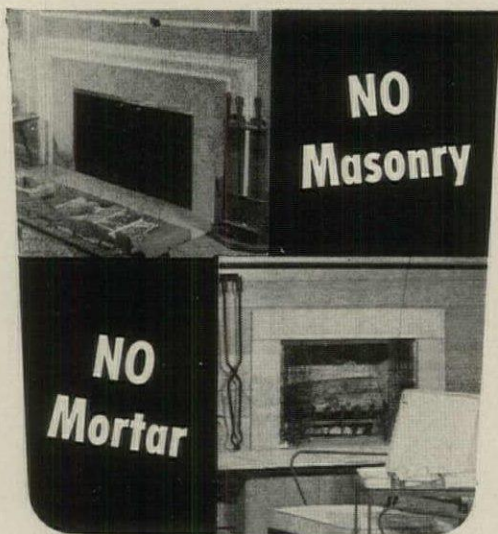

**NO  
Masonry**

**NO  
Mortar**

in these *charming*  
Wood-Burning  
**Majestic**  
**THULMAN**  
**Fireplaces**



The multi-wall construction of this prefabricated fireplace (with chimney) allows it to be set right against wood or other combustible material with complete, permanent safety. Made entirely of corrosion-resistant alloys and stainless steel. Easy to install, it cuts the builder's cost, yet meets the demands of fireplace-minded buyers. Choice of mantel styles and surrounds.

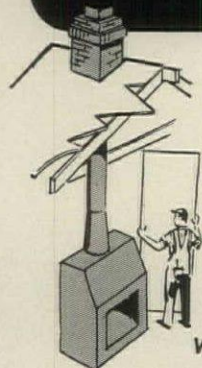

**Also available:** Cost-saving Majestic-Thulman Class A all-fuel chimney for regular heating needs, as well as UL-listed Gas Vent Class B chimney for venting appliances. Attractive chimney top housings.

Write for details

The **Majestic** Co., Inc.  
416-B Erie Street, Huntington, Indiana

**New products**

starts on p 210

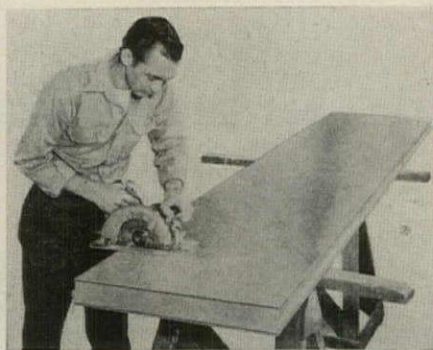

**Sandwich patio-roof panel** is designed to meet northern snow-load needs while being light, easy to install, comparable in cost to sheet-metal awnings. Fiberboard underskin is bonded to a strutted core of kiln-dried fir. Patterned aluminum outer-skin is bonded to fiberboard. Panels are 2' wide and 6', 8', 10', and 12' long, are rigid enough not to need joists or other intermediate support.

Hess Mfg Co, Quincy, Pa.

For details, check No. 68 on coupon, p 264

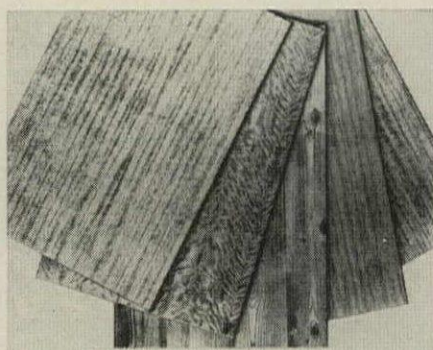

**Patterned wallboard** in five wood grains is new from Bestwall. Gypsum boards are reinforced with fiberglass, are faced with photo reproductions of mahogany, aspen, and pine grains, are finished with a durable transparent coating. Edges are beveled (knotty pine is square), need no finishing. Sheets are 4'x8'.

Bestwall Gypsum, Ardmore, Pa.

For details, check No. 69 on coupon, p 264

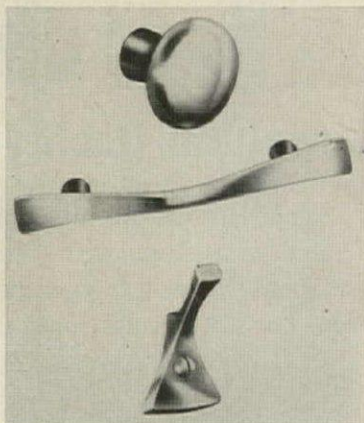

**New cabinet hardware** from Medalist Division of National Lock includes new knobs, pulls, and utility hook. New hardware is finished in bright chrome, bright brass, old copper, dull bronze. Knob and pull posts are black. Pull is 3" between posts, knobs are 3/4" or 1" in diameter. Hardware is packed in unit lots for on-the-job convenience. /END

National Lock Co, Rockford, Ill.

For details, check No. 70 on coupon, p 264

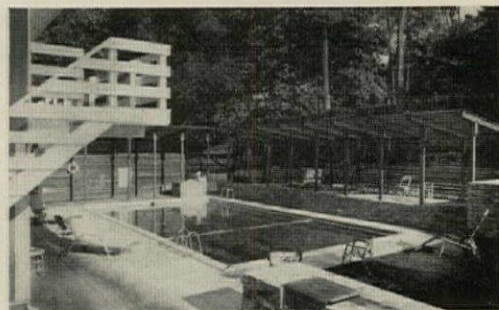

**PICTURES OF**



**PROFIT-MAKERS**

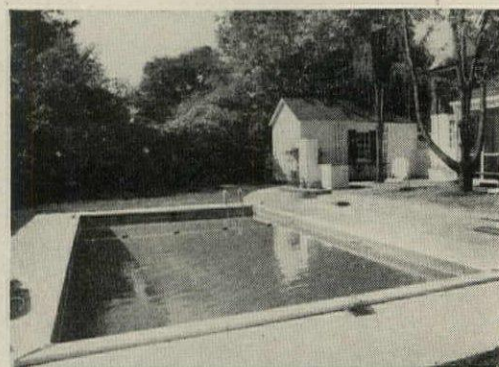

**FOR BUILDERS!**



*transform today's homes into  
smart Packaged Estates!*

Merchant builders who are aware of the increasing popularity of residential swimming pools are invited to investigate the *Romar Builder-Dealer Franchise* . . . available to a limited number of firms in the building industry. We also give special attention to inquiries from architects, lending institutions and realtors. Ask about our special pool packages for model homes.



120 W. MELVINA ST., MILWAUKEE 12, WIS.

Member, National Association of  
Home Builders • Charter Member, National  
Swimming Pool Institute

RSP-659



This powerful ad will reach

14,963,000

POTENTIAL  
HOMEBUYERS



building public preference for the **Hotpoint** Kitchens you put in your homes

you'll love the way your kitchen looks...  
you'll love the way your kitchen works!

**HOTPOINT**  
Quality Appliances  
for kitchen and laundry

What a joy it is to please your good taste and your good judgment at the same time! Hotpoint lets you do just that. Never were home appliances so beautiful to look at—so automatically convenient to use—so thrifty to own—as are the Hotpoint 1959 models in your choice of four lovely Colorones or classic white. Whether you're planning a complete all-electric kitchen and laundry, or simply replacing a single appliance, visit your Hotpoint dealer and see what he has in store for you!

All of the Hotpoint appliances shown below can be bought and delivered as a complete "package." Your Hotpoint dealer's price lists for the 1959 line are available upon request.

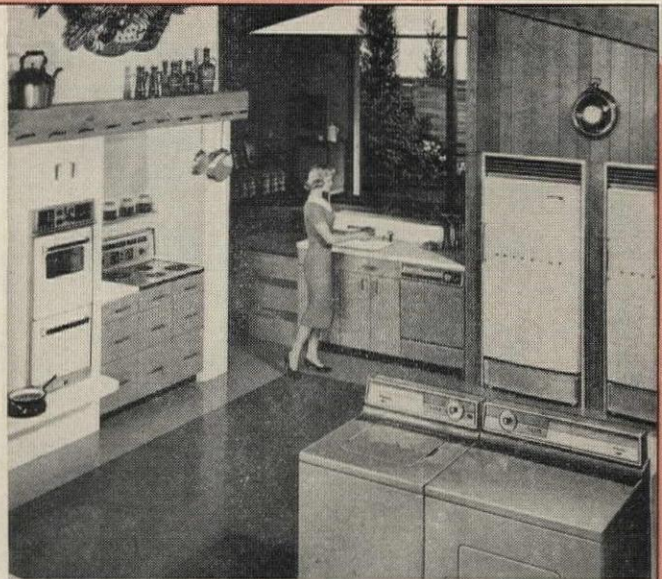

**Wetproofers**... Being Cheeky...  
**Electric Ranges**...  
**Home Freezers**...  
**Dishwashers**...  
**6-Cycle Washers**...  
**Wetproofers**... Being Cheeky...  
**Electric Ranges**...  
**Home Freezers**...  
**Dishwashers**...  
**6-Cycle Washers**...

**Hotpoint**  
Look for that Hotpoint Difference

Put the sales power of Hotpoint's established public preference to work for you

See Hotpoint's dramatic 4-color spread in



APRIL 6      MAY 16      MAY

**Hotpoint**  
LOOK FOR THAT DIFFERENCE! (your customers do!)

A Division of General Electric Company, Chicago 44, Illinois  
ELECTRIC RANGES • REFRIGERATORS • AUTOMATIC WASHERS • CLOTHES DRYERS • CUSTOMLINE  
DISHWASHERS • DISPOSALS® • WATER HEATERS • FOOD FREEZERS • AIR CONDITIONERS



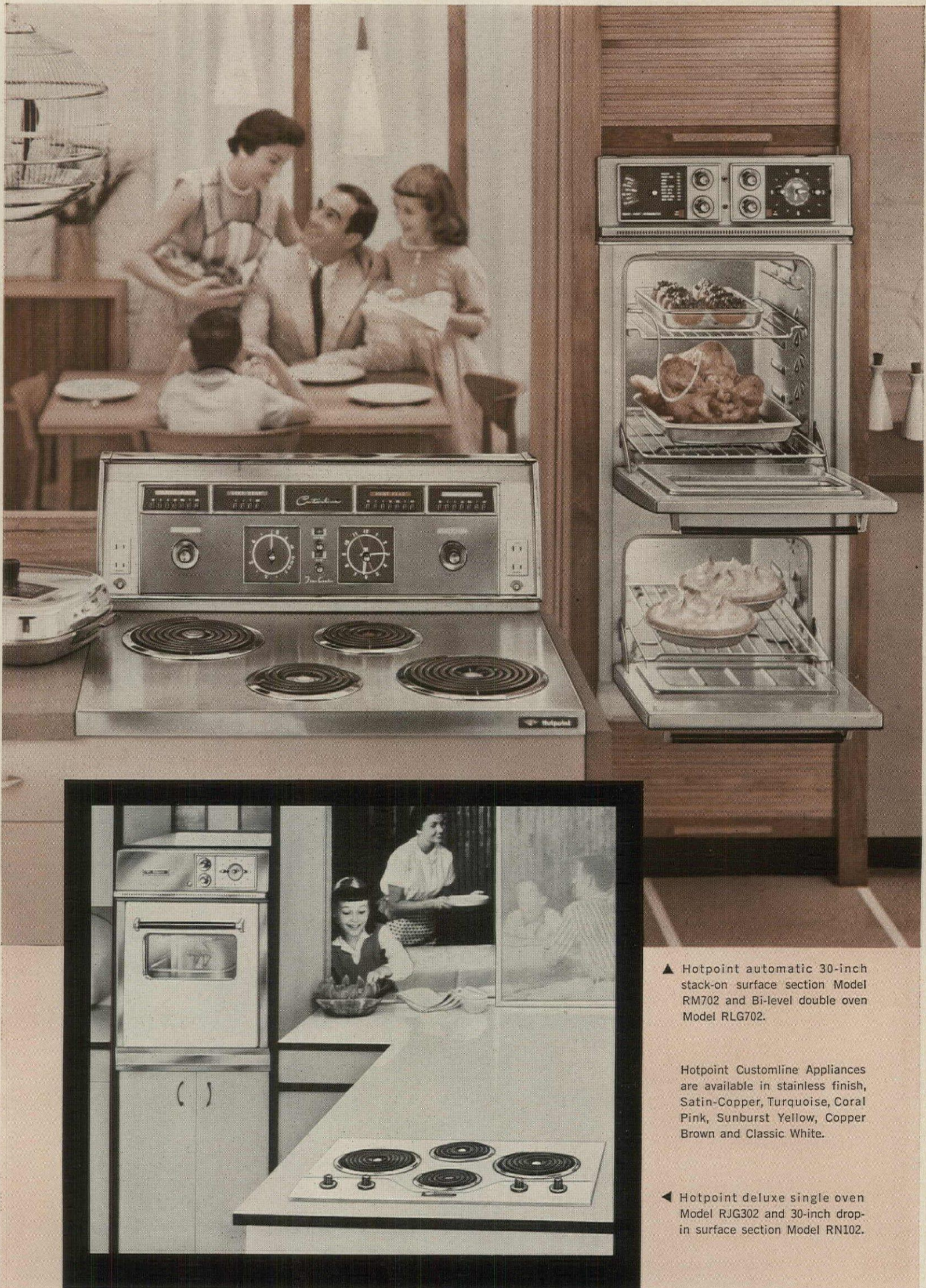

▲ Hotpoint automatic 30-inch stack-on surface section Model RM702 and Bi-level double oven Model RLG702.

Hotpoint Customline Appliances are available in stainless finish, Satin-Copper, Turquoise, Coral Pink, Sunburst Yellow, Copper Brown and Classic White.

◀ Hotpoint deluxe single oven Model RJG302 and 30-inch drop-in surface section Model RN102.

when you build in

**HOTPOINT**

you build in

**PUBLIC**

**PREFERENCE**

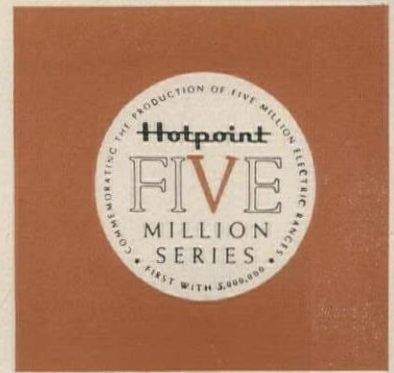

Only Hotpoint offers builders such dramatic proof of public preference, for only Hotpoint has made over 5 million electric ranges.

Hotpoint built-in ranges offer the same product leadership—in quality, in features and in styling—that has made this unprecedented sales record possible.

And, Hotpoint keeps building public preference for built-in ranges with powerful, full-color ads in *LIFE* and other leading magazines. It's advertising directed to *your* prospects to help sell Hotpoint-equipped homes.

With Hotpoint built-in ranges, you also enjoy many other important advantages. Hotpoint offers a complete built-in line, with ovens and surface cooking sections to fit every kitchen plan and budget. Hotpoint built-ins are designed to save space and installation costs, too. And, Hotpoint's new interchangeable oven door panels give your customers complete decorating freedom—colors can be changed easily in minutes.

Remember, home buyers look for quality, and Hotpoint built-ins reflect quality throughout the home. Put the sales power of Hotpoint's public preference in your homes now!

when you build in Hotpoint, you build in Public Preference



**Hotpoint**

A Division of General Electric Company, Chicago 44, Illinois

ELECTRIC RANGES · REFRIGERATORS · AUTOMATIC WASHERS · CLOTHES DRYERS · CUSTOMLINE  
DISHWASHERS · DISPOSALLS® · WATER HEATERS · FOOD FREEZERS · AIR CONDITIONERS

All America Acclaims This  
Gleaming Beautiful Jewel

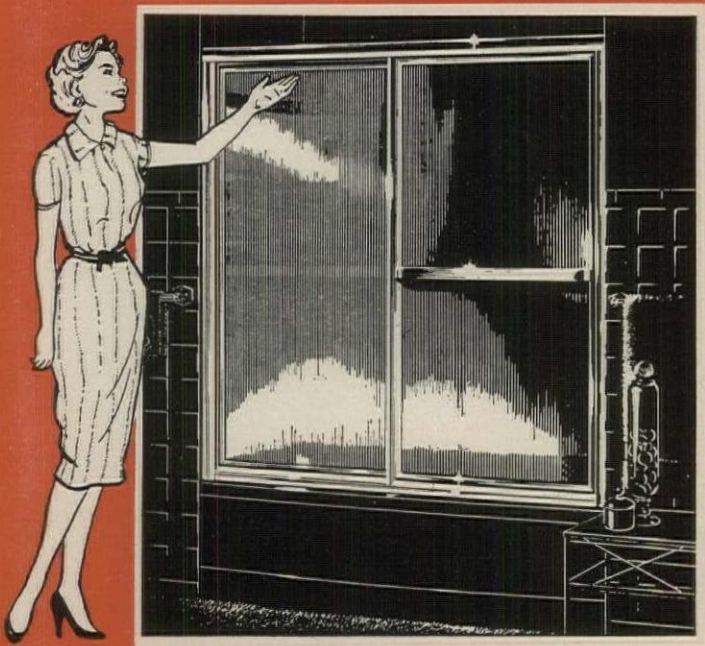

THE NATIONALLY ADVERTISED

# Showerte<sup>®</sup> El Dorado TUB ENCLOSURE

With Features That Have Made This A Bathroom  
Favorite in the Finest Homes

Offer the ultimate in bathroom beauty AND at a price that "sells" outstanding value. For those who prefer simplicity in glass design there's the ever popular HAMMERED FROSTED or PLURALITE GLASS. For a touch of individuality in elegant bathroom decor, the El Dorado presents the utmost in luxury aluminum extrusions, mirror-polished in smooth concave modern design. There's a unit to fill every requirement, no matter what your customer's choice.



Model Shown for 4', 4½' or 5'  
Recessed Tub  
Suggested Retail **\$109<sup>95</sup>**

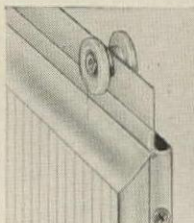

Four Rollers on Each Panel for Quieter, Smoother Operation

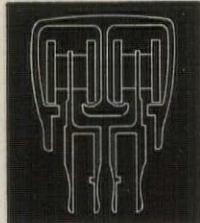

Double Suspension Doors For Super-Easy Glide

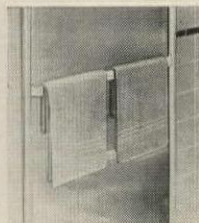

Two Wrap-Around Towel Bars for Convenience and Safety

NOW... THE EL DORADO SERIES  
AVAILABLE IN CUSTOM MADE UNITS



OR WRITE FOR COPY



WRITE FOR NAME OF NEAREST DISTRIBUTOR



**THEODORE EFRON Manufacturing Co.**  
7525 S. Greenwood Ave., Chicago 19, Illinois



## Pocket the cost of concrete encasement!

Strong, corrosion-resistant Transite<sup>®</sup> offers many ways to save when you install modern slab-in-grade perimeter heating and air-conditioning systems. Costly concrete encasement is unnecessary. Time and concrete are saved as your men position Transite Air Duct directly on the prepared bottom. No need for special supports—and because Transite won't float—no need for anchoring. All your men do is position duct and pour concrete.

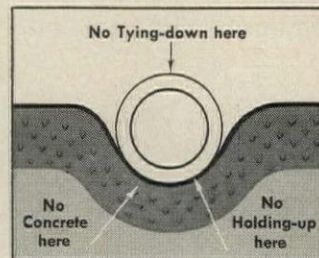

Transite installs still faster because fittings can be made quickly, easily, right on the job—or ordered factory-made to your requirements. Made of asbestos-cement, Transite won't flake or flap down to impede air flow... will never rot or give off odor.

Let us send you a free copy of Transite Air Duct booklet, TR-144A. Address Johns-Manville, Box 14, New York 16, N. Y. In Canada, 565 Lakeshore Road East, Port Credit, Ont.



## Johns-Manville TRANSITE AIR DUCT

FOR \$10,000 HOMES



\$14,000 HOMES



\$18,000 HOMES



AND HOMES OVER \$20,000



# Suburban BUILT-IN RANGES

GAS OR ELECTRIC—BEST VALUE AT EVERY PRICE LEVEL

Regardless of the price homes you build, you can include the sales power of Suburban and offer prospects all 36 of the features most women want in a built-in range. Here's real quality at a price you can't beat! Plus—models available in both gas and electric to fit same size cabinet opening—interchangeable. Get your value-packed price from your local distributor. Send coupon today!

**Free Color Literature!**

Samuel Stamping and Enameling Company  
Dept. HH-39 — Chattanooga, Tennessee

Send me complete information on Suburban Built-in Ranges  Gas  Electric

Name \_\_\_\_\_

Address \_\_\_\_\_

City \_\_\_\_\_ State \_\_\_\_\_





ADD *Vina-Lux*<sup>®</sup>

## SALES POWER TO YOUR HOMES!

Colorful, smartly-styled floors of Vina-Lux are potent sales helps to the merchant home builder. And, after the house is sold, this low-cost vinyl-asbestos tile makes day-to-day living easy and pleasant.

Investigate Vina-Lux — ask your flooring

contractor to show you samples of this outstanding residential flooring. Available in 42 colors, 5 sizes and 3 thicknesses.

*Write for full information on Azrock's Model Home Program: Display floors, "hidden value" signs, identification cards, advertising and publicity.*

**Vina-Lux is a nationally-advertised product.**



**AZROCK FLOOR PRODUCTS DIVISION**  
 UVALDE ROCK ASPHALT CO. • 551A FROST BANK BLDG. • SAN ANTONIO, TEXAS



MAKERS OF VINA-LUX • AZROCK • AZPHLEX • DURACO



Did you  
say it only  
takes about  
**1 HOUR...**

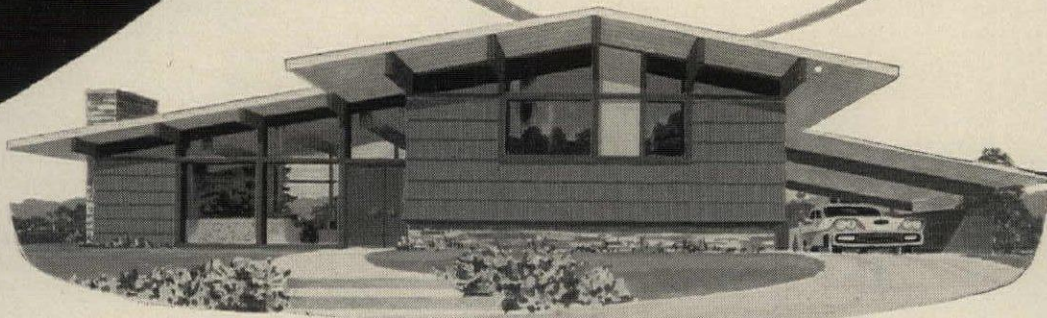

*to apply a whole square of*  
**Shakertown® GLUMAC UNITS®**

That's right! Every Glumac Unit is equal in size to 18 individual shakes and undercoursing shingles . . . and only 22 Glumac Units cover 100 square feet! No wonder Shakertown Glumac Units go up faster, have a lower applied cost! And Shakertown Jiffy Corners . . . striated and painted to match the pre-stained Glumac . . . provide quick, neat corners. Matching colored nails in every carton eliminate touching-up. Send the coupon below for complete information.



**Shakertown®**  
CORPORATION



SHAKERTOWN  
CORPORATION  
Department HH-39  
20310 Kinsman Road • Cleveland 22, Ohio  
Please send me the Shakertown Color Ideabook.

NAME \_\_\_\_\_

COMPANY \_\_\_\_\_

STREET \_\_\_\_\_

CITY \_\_\_\_\_ ZONE \_\_\_\_\_ STATE \_\_\_\_\_

8280-ST

**Shakertown** Regular, DeLuxe & DeLuxe Jumbo GLUMAC UNITS • SIDEWALL SHAKES • STAIN • JIFFY CORNERS

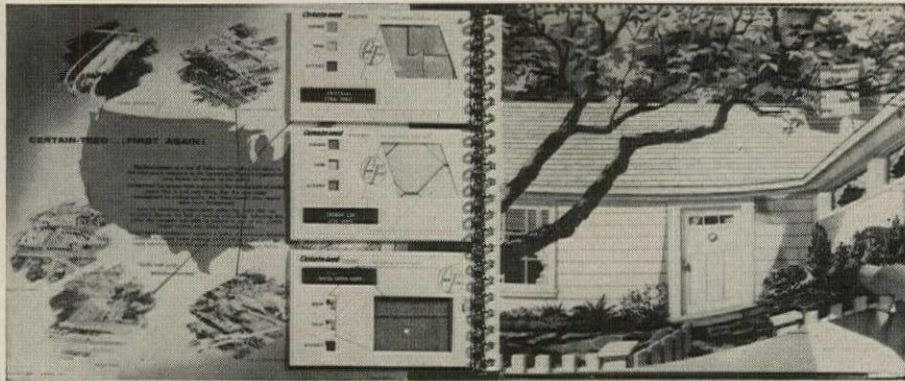

### New color service for builders

Here's one answer to your problems with look-alike houses.

Certain-teed Products Corp is now offering builders of 50 or more houses the services of Beatrice West, nationally known color consultant, to plan combinations of roof, siding, trim, and accent colors for each house in the builder's development.

The offer is tied into Certain-teed's new Color-Tuned roofing system, a series of ten key roof colors chosen by Miss West to harmonize with almost any trim or siding. These colors and possible trim or siding combinations are shown in the company's new Home Harmonizer, the hardbacked full-color brochure shown above and at the right. With this the builder can show a customer how a suggested color combination will look.

Miss West's personal color-styling of

each house in a development is free to you if you build in quantity and use Certain-teed roofing products. To get it you take your elevations, plot plan, and materials source list to your Certain-teed dealer who will send them on to Miss West.

Certain-teed Prod, Ardmore, Pa.

For copy, check No. 71 on coupon, p 264



### Goodrich flooring publications

B. F. Goodrich has just made available a complete portfolio for specifying resilient tile flooring. The central publication is an Architect's Manual containing a floor selection chart which tells installed costs, federal specs, wearing qualities, characteristics, properties, etc. The manual also reviews subfloor conditions, installation and maintenance data, recommended adhesives, static loads, acoustical properties, and light reflectance. Filling out the portfolio are a general catalog, a brochure on vinyl asbestos tile, and a folder on molded rubber stair treads. Available to architects, chief draftsmen, designers, spec writers, and engineers.

B. F. Goodrich, Watertown, Mass.

For copy, check No. 73 on coupon, p 264

### Detail sheets for curtain walls

A 40-page set of specification sheets for Calcore porcelain panels has just been made available by Caloric Appliance. The sheets show 17 core materials which can be used with porcelain-enamel surfacing. Typical cores: aluminum and paper honeycombs, foamed glass, asbestos cement, fiberglass, wood and mineral fiber products.

Caloric, Topton, Pa.

For copy, check No. 74 on coupon, p 264

### Quick aid to calculation

General Industrial Co is offering engineers and other building executives a free circular pocket slide rule. Easy-to-read instructions come with each calculator.

General Industrial Co, Chicago.

For copy, check No. 75 on coupon, p 264

### Where to use rigid plastic pipe

Carlton's new 6-page bulletin shows uses for HTHT Kralastic pipe which is claimed to take pressure 100 psi higher than other rigid plastic pipes at temperatures to 180F. Contents include: complete specs, application data, installation details, support spacings, physical properties, chemical resistance.

Carlton Products, Aurora, Ohio.

For copy, check No. 76 on coupon, p 264

### New job shack booklet

DPPA's new *Ideas for Temporary Construction Facilities* gives plans for using plywood in construction signs, tool boxes, mortar boards, lumber shelters, portable toilets, portable and demountable construction offices, saw and storage sheds, portable barricades. 13 pages.

Douglas Fir Plywood Assn, Tacoma.

For copy, check No. 77 on coupon, p 264

### How to install remote controls

Remcon has a new 22-page installation guide for their entire line of remote-control wiring devices. The booklet is fully illustrated, is pocket sized so it can be carried to the job.

Remcon, Lynbrook, N. Y.

For details, check No. 78 on coupon, p 264

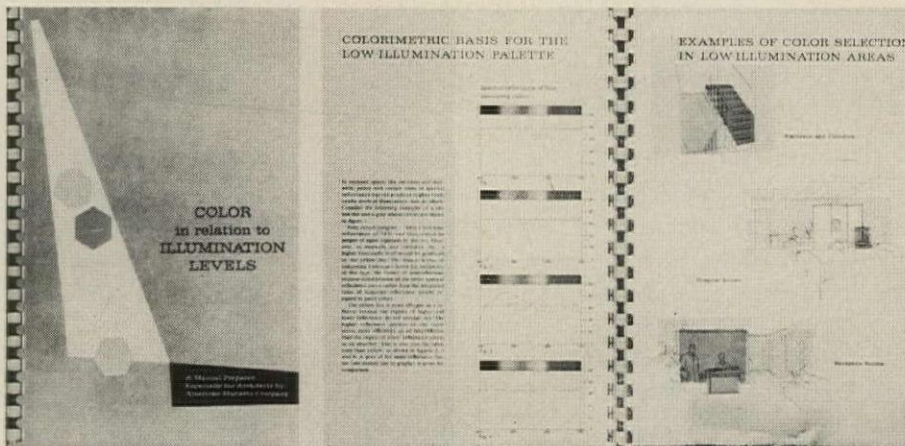

### New color guide for architects

How to use color with either high or low illumination levels is outlined in the 16-page, plastic-bound book shown above which is now being supplied to architects by the American Marietta Co, a major paint manufacturer.

The book was prepared by Walter C. Granville, president of the Inter-Society Color Council. Among the topics discussed: the colorimeter basis for a low-illumination palette; typical color selections for low and normal light levels;

illustrations of how paint color changes with illumination; notes on how to pick colors for walls opposite windows, walls at right angles to windows, window walls, and ceiling-lighted walls. Palettes for low levels and for normal and high levels are displayed in the manual and chips of the same colors which can be matched on the job are held in pockets in the back of the book.

American-Marietta Co, Chicago.

For copy, check No. 72 on coupon, p 264



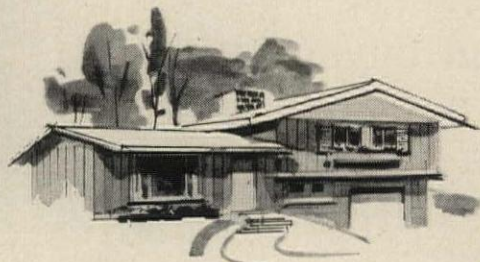

*In any home, anywhere*

# built of **WOOD** means built to **SELL**

Actually, built of wood means built to give your prospects more value for their money . . . today's best building buy. For the inherent economy of wood construction enables you to offer well-planned homes with more space, more features, more comfort, more beauty per dollar.

These are the extras that sell homes. And your prospects will respond to the qualities of wood that give them these extras. Whatever size, price or kind of houses you build . . . wherever the locale or site . . . you will sell more houses and make *more dollars per house* when you build with wood!

For new information on better homes of wood, write to:  
**NATIONAL LUMBER MANUFACTURERS ASSOCIATION**  
 Wood Information Center, 1319 18th St., N.W., Washington 6, D.C.

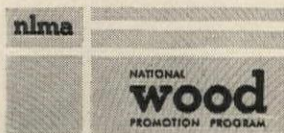

*Live, Work, Build Better with Wood*

starts on p 256

# Homes with an "XTRA"



"Our customers want and buy the 'extra' quality features like

**X-PANDA  
SHELVES**

that make a house a home..."

*says M. C. Cole*



M. C. COLE, PRESIDENT  
M. C. Cole Co., Garland, Texas

M. C. Cole has a well-earned reputation for building quality homes. Here's what he thinks of X-Panda Shelves: "We have found that X-Panda Shelves can be installed in about 5 minutes. In the past we have had trouble with wooden shelves splintering, warping and knot holes showing through the painted finish. We have no problems with the beautiful linen-finished X-Panda Shelves. We plan to feature X-Panda Shelves in 250 homes in 1959 . . . an "extra" value to purchasers of Cole Homes."

You, too, can give your homes that custom-look with . . .

**X-PANDA  
SHELVES**

**CHECK THESE FEATURES:**

- Telescoping shelf, pole and accessories in a package
- Install in 5 minutes, nothing to cut, fit or paint
- Save 80% on total labor, 10% to 20% on total installed costs
- Closet can be painted before installing
- Shelves and accessories for every need—clothes closets, linen closets, wall shelves, etc.
- Choice of linen or greytone finishes

**WRITE FOR FREE BOOKLET TODAY**

HC Sales Co. A-100  
3300 N.E. Adams Street, Peoria, Ill.  
Please rush me literature on X-Panda Shelves.

Name \_\_\_\_\_  
Address \_\_\_\_\_  
City \_\_\_\_\_  
State \_\_\_\_\_

\* Trade Mark of Home Comfort Mfg. Co.

**Who builds unit air conditioners?**

A directory of all the central unit systems being made by 30 major air conditioner makers is now ready for distribution by the ARI. The directory contains certified ratings of all equipment which meets the new standards established by the association and which carries the ARI seal. Not included: room units, heat pumps, large commercial systems.

Air-Conditioning & Refrigeration Institute, Washington, D.C.  
For copy, check No. 79 on coupon, p 264

**Two booklets from Owens-Corning**

Full descriptions and specifications of Fiberglas one-piece pipe insulation are given in a new 8-page booklet. Hot and cold water and low-pressure steam lines are covered.

For copy, check No. 80 on coupon, p 264

How to use Fiberglas concrete-curing blankets is dealt with in a new 4-page brochure. Insulation needs for various structures to temperatures as low as -127F are given.

Owens-Corning, Toledo.  
For copy, check No. 81 on coupon, p 264

**How to use an all-fuel chimney**

Metalbestos has a 12-page booklet which sets forth full details of their steel and asbestos stack-on chimney. The booklet shows how and where to use it, what stresses it can stand, what its capacities are, what sizes and accessories are available, and how it goes together.

William Wallace Co, Belmont, Calif.  
For copy, check No. 82 on coupon, p 264

**How to use magnetic drill stands**

Thor has a new bulletin to show how magnetic drill stands can be used for precision drilling in units up to 2" wherever a ferrous base is available.

Thor Power Tool Co, Aurora, Ill.  
For copy, check No. 83 on coupon, p 264

**New uses for hardboard**

Weyerhaeuser's new 4-page, 4-color booklet shows various structural and decorative uses for the Silvatek hardboard line. Specs are given for standard, tempered, and perforated Weytex, Weybase underlayment, and Weylite low-density board.

Weyerhaeuser Timber Co, Tacoma.  
For copy, check No. 84 on coupon, p 264

**Construction data handbook**

A. C. Horn Companies have just issued the 1959 edition of their 160-page *Horn Construction Data Handbook*. This pocket-sized book—which is free to architects, builders, contractors, and engineers—contains over 40 pages of estimating tables, as well as measurement tables, and construction details with special attention to painting and concrete work. Also included are full details on Horn's line of protective, preservative, and decorative line of wood, metal, and concrete coatings.

Sun Chemical, New York City.  
For copy, check No. 85 on coupon, p 264

continued on p 264

*the Quality window to spark home sales*



You may order Mt. Shasta windows in single, twin, or triple units.

*Investigate the All-New*  
**Mt. Shasta  
 Suburban Unit**

All Mt. Shasta Suburban Units are manufactured from only high-altitude, first-quality Ponderosa Pine...chemically treated for added durability and longer life. Mt. Shasta Suburban Units may be finished to match any decor.

*Distributed through millwork jobbers.*

INTERNATIONAL PAPER COMPANY  
**Long-Bell**

DIVISION

Kansas City, Mo. • Longview, Wash.

*Also Manufacturers of Horizontal Sliding Units • Long-Bell  
 Four-Way • Lock-Joint Window Units • Met-L-Glide  
 Window Units • Utility Units*

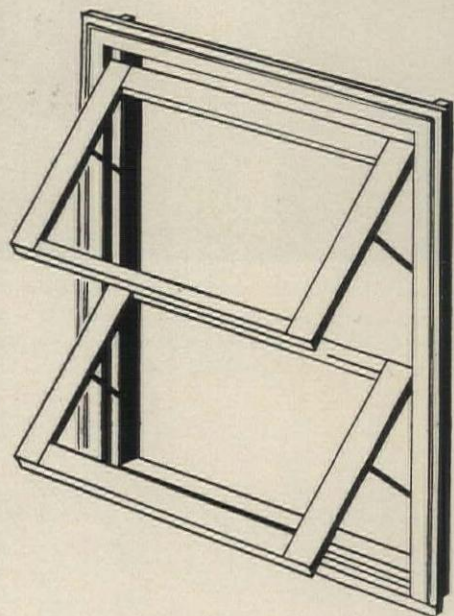

- Popular Awning-Type features made to Double Hung Modular Layout and sizes.
- Available in:  
 2-light  
 4-horizontal light  
 12-light, Or Any Other
- Light Arrangement You Might Require.
- Completely Weather-stripped
- Furnished with Locking Handles
- Vertical Sliding Inside Screens Available.

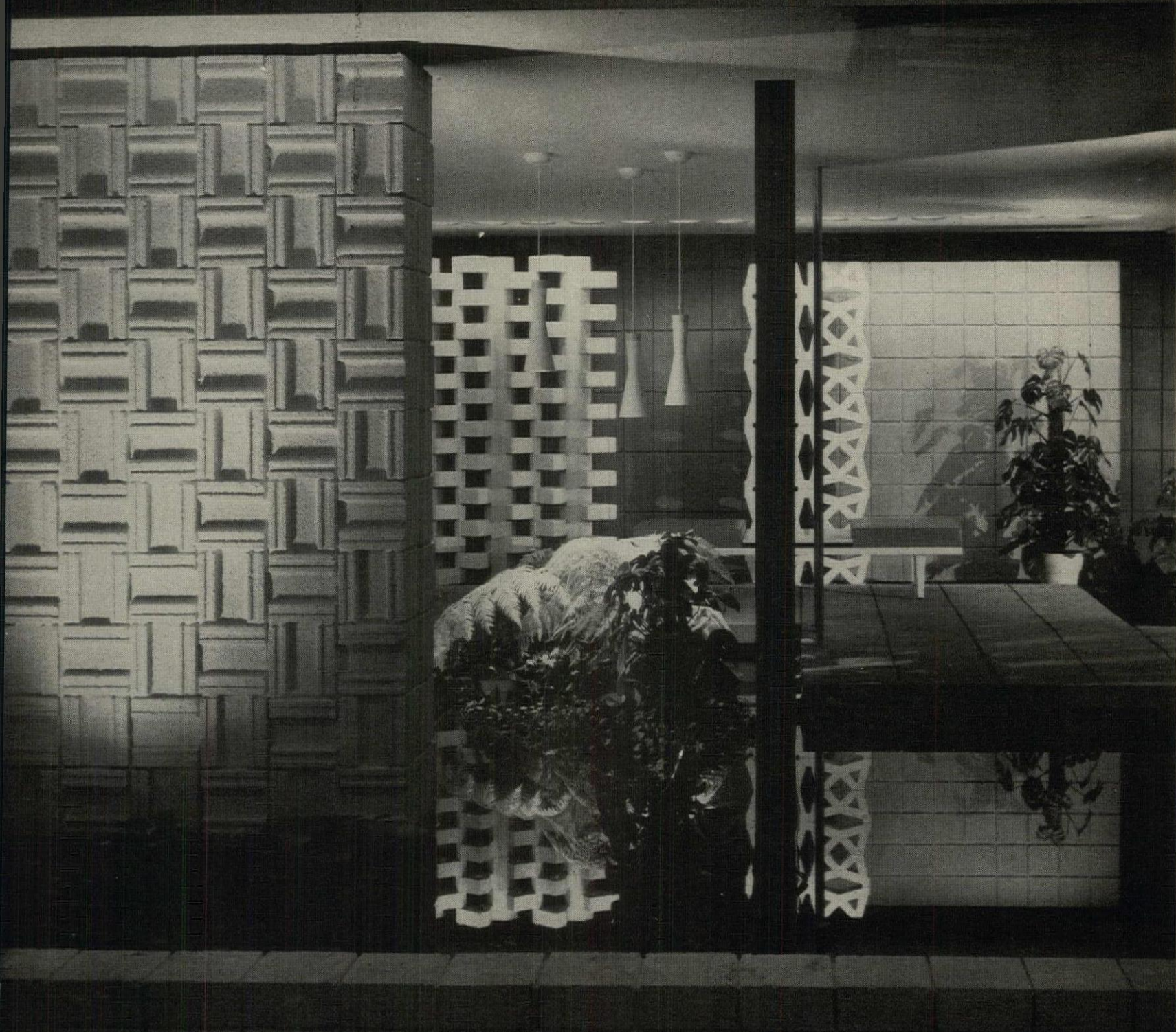

The fabulous Pavilion—a collection of the most imaginative uses of sculptured block ever seen anywhere. Coordinating architects and Pavilion design—Robert A. Little & George F. Dalton & Associates, Cleveland. Pictured left foreground is a wall of sculptured block by Alfred B. Parker, Miami. The screen to the left by Victor Lundy of Sarasota. The lace-like right screen by Kaz Nomura of Jones & Emmons, Los Angeles.

*The wonderful new world of Block!*

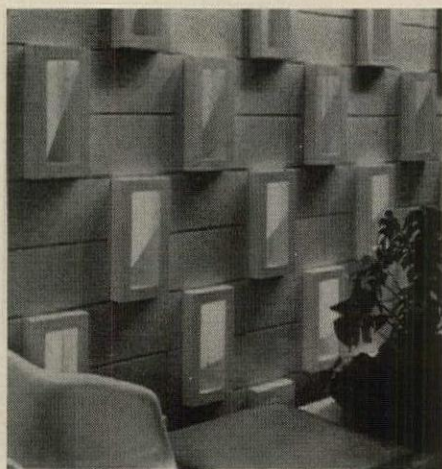

### Leading architects fashion bright new faces of Concrete Masonry

FROM the talent and imagination of nine leading American architects come concrete masonry walls with new expression, new dimension, new versatility! Specially commissioned, these architects created tomorrow's walls of fashion from block units available from the industry today. Smart walls which adorned a graceful Pavilion, seen and admired by thousands. Your local NCMA member will have complete details on the Pavilion soon. Or write us direct for more on the wonderful new world of block.

National Concrete Masonry Association • 38 South Dearborn • Chicago 3



Standard units interjected with vertically placed hollow core units by Marcel Breuer & Associates, New York.

A NEW ALUMINUM SLIDING GLASS DOOR  
by PETERSON, a great name in aluminum windows

# It's a DAISY!

The Daisy door by Peterson is available just about any way you want it. In widths from 6 to 20 ft., in heights of either 6 ft. 10 in. or 8 ft., and can be glazed with a wide variety of glass from 1/8 in. sheet to 1 in. sealed units. And whichever way you want it, you can be sure that your Daisy doors will give your new homes a touch of real, long-lasting luxury.

**with POSITIVE WEATHER PROTECTION**

The Daisy door's weather-tight construction keeps out driving rain and blizzards. And for extra protection there's a 100% bug-proof barrier around the screen. Closing and opening with remarkable ease and quietness, the Daisy locks solidly in "closed" and three "open" positions. That's Prowler-Proof Ventilation! Send coupon below for complete details.

**DAISY DOORS**  
A PRODUCT OF  
**Peterson Window Corp.**

720 2D LIVERNOIS      FERNDALE 20, MICHIGAN

Name \_\_\_\_\_  
Address \_\_\_\_\_ City \_\_\_\_\_ State \_\_\_\_\_

Makers of PENGUIN • SAPPHIRE • PARAGON Windows



New 1959  
Economy **Horizon**  
By  
**WADSWORTH HOMES, INC.**



**Now...capture the Under \$10,000 Market**  
with the All New 1959 Wadsworth Horizon House—*Packed with Profit!*

**CHECK THESE OUTSTANDING SELLING FEATURES:**

- ✓ Selling price, including your lot, under \$10,000
- ✓ All elevations available with or without carport
- ✓ Designed for quick, low-cost field erection
- ✓ Complete package quickly delivered to you
- ✓ Meets all new FHA requirements
- ✓ Choice of 3 handsome exterior designs
- ✓ 26 x 36 feet of efficient design

**FIND OUT HOW WE CAN HELP YOU WITH  
A COMPLETE FINANCING PROGRAM**

**WADSWORTH HOMES, INC.**  
2949 Chrysler Road  
Kansas City 15, Kansas

**SERVING**



SEND TODAY FOR COMPLETE INFORMATION

**WADSWORTH HOMES INC.** Dept. C  
2949 Chrysler Road, Kansas City 15, Kansas

Please send complete information on the  
new 1959 Economy Horizon.

Name \_\_\_\_\_  
Company \_\_\_\_\_  
Street Address \_\_\_\_\_  
City \_\_\_\_\_ Zone \_\_\_\_\_ State \_\_\_\_\_

# YORK COMFORT CENTER Helps Delaware Builder Sell Over 278 New Homes



Irving I. Medgebow,  
Secretary

"The success we achieved merchandising York's new comfort center for our Green Acres development was little short of spectacular," say Leon Weiner and Irving Medgebow of Franklin Builders, 1400 Silverside Road, Wilmington, Del. "In fact, we're so enthused about the whole thing, we're using York to help sell all the houses in our new Wycliffe development, too!"



Leon N. Weiner,  
President

**YORK year 'round Heating and Cooling  
PLUS Electronic Filtering proves to be  
a real crowd pleaser!**

In our Green Acres development, we advertised, merchandised and promoted York Year 'Round Heating and Cooling to the hilt. The result: prospective customers flocked to see our models, inquiries climbed, sales increased beyond anything we had expected.

The idea of having winter heating, summer cooling and dehumidifying, plus electronic air filtering all in one, compact beautifully styled unit has evoked tremendous enthusiasm from our home buyers and prospective home buyers.

## YORK LIFT-FOR-LIFE MERCHANDISING PAYS OFF BIG IN EXTRA TRAFFIC... MORE SALES AND PROFITS!

York provides builders with everything they need to win success in the big, booming market for new homes this year. Builders who feature York in their model homes will be named in hard-hitting, 2 color advertising in the June issue of House Beautiful. And York has developed a complete Builder Kit to tie in with

this big program. This new *and different* kit makes it possible for every York builder to give each of his models the York "Red Carpet" treatment by dressing them up with outdoor signs, indoor posters, a York "Kiddie Pen" and other assorted sales clinchers! See your York distributor for details.

**Your Future and Fortune Now Lies with YORK**



Green Acres,  
Wilmington, Delaware



## COMPLETE LINE OF YORK AIR CONDITIONING AND HEATING EQUIPMENT NOW AVAILABLE TO BUILDERS!

Whether you're building a dozen houses or a thousand, whether they're large or small, north or south of the Mason Dixon, there's a York product that will help you sell more, make more. For York makes all sorts of air conditioning and heating equipment for homes, in almost every price range. There are the famous York combination units that provide year

'round heating and cooling...York "Remote" Air Conditioners that have the cooling unit located outside the house...York "Packaged" Air Conditioners that fit into waste space in the attic, carport or crawl space...plus a complete line of gas or oil-fired furnaces that provide for easy installation of add-on air conditioning at a later date!

# YORK

YORK CORP. SUBSIDIARY OF BORG-WARNER CORP.



**BORG-WARNER  
ENGINEERING & RESEARCH  
MAKE IT BETTER**

Air Conditioning, Heating, Refrigeration and Ice Equipment • Products for Home, Commercial and Industrial Installations

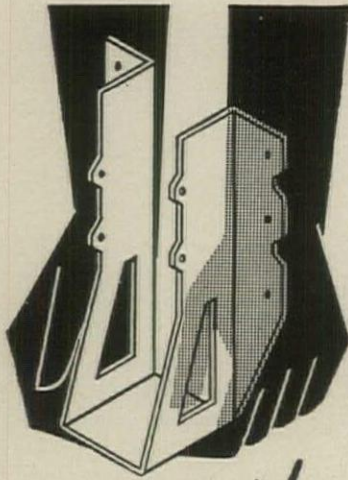

# NEW TECO U GRIP

... the engineered  
joist hanger that  
**COSTS LESS** to use

- Fast and easy to install
- Saves ledger stripping, notching, shimming
- Weigh less — thus cost less to ship
- Cost less than conventional type hangers
- Easy to stock

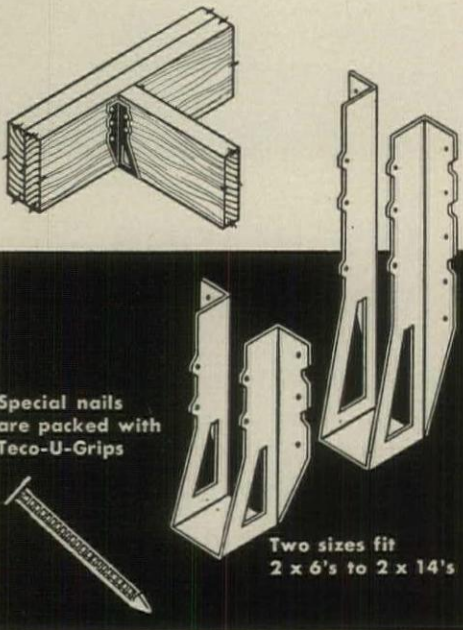

Special nails are packed with Teco-U-Grips

Two sizes fit  
2 x 6's to 2 x 14's

**TIMBER ENGINEERING COMPANY**  
1319 18th Street, N.W., Washington 6, D. C.

Please send design data on Teco-U-Grips.

Name.....

Firm.....

Street.....

City.....State.....

HH-591

**Technical data on aluminum**

Kaiser has a new 24-page booklet specifying the company's complete line of aluminum mill products: sheet, plate, foil, rod, bar, wire, extrusions, tubing, forgings, billet, and pig. Also described: roofing, siding, ShadeScreen, pipe, building wire, etc. Tables compare heat-treatable and non-heat-treatable alloys in composition, application, availability, physical properties.

Kaiser Aluminum, Chicago.  
For copy, check No. 86 on coupon below

**Two new folders from Flintkote**

Bulletin AF-1 covers ten products used to install wall, floor, and ceiling materials and to patch concrete.

For copy, check No. 87 on coupon below

Bulletin AF-6 describes both spread and dab methods of applying Atlas acoustical tile and wallboard cement.

Flintkote Co., New York City.  
For copy, check No. 88 on coupon below

**Want more information?**

The numbers below are keyed to the items described on the New Products and Publications pages. Check the ones that interest you and mail the coupon to:

**House & Home**

Room 1021A, 9 Rockefeller Plaza, New York 20, N.Y.

**NEW PRODUCTS**

1.  American-Standard Contour tub
2.  Youngstown Woodcharm cabinets
3.  Modern Maid oven
4.  Fenestra sliding glass doors
5.  Acorn Aluminum sliding glass doors
6.  Binswanger sliding glass doors
7.  Samuels sliding glass doors
8.  Rusco sliding glass doors
9.  Trimview sliding glass doors
10.  Sun Valley sliding glass doors
11.  Oro sliding glass doors
12.  Capitol sliding glass doors
13.  Peterson sliding glass doors
14.  Cupples sliding glass doors
15.  Textron sliding glass doors
16.  Dina-Pak sliding glass doors
17.  Pitteco sliding glass doors
18.  Ador sliding glass doors
19.  T.V. Walker sliding glass doors
20.  Shodoco sliding glass doors
21.  Arcadia sliding glass doors
22.  Smithcary sliding glass doors
23.  Hollyview sliding glass doors
24.  Steelbilt sliding glass doors
25.  Heller sliding glass doors
26.  Panaview sliding glass doors
27.  Miller sliding glass doors
28.  Lupton sliding glass doors
29.  Trim-Glide sliding glass doors
30.  Marshall sliding glass doors
31.  Bur-Val sliding glass doors
32.  Nu-Vu sliding glass doors
33.  Kota sliding glass doors
34.  General Bronze sliding glass doors
35.  Slide-View sliding glass doors
36.  Daryl sliding glass doors
37.  H&D sliding glass doors
38.  Nudor sliding glass doors
39.  Andersen Patio Wall
40.  Outdoor sliding glass doors
41.  Universal built-ins
42.  Suburbanette ovens
43.  Frigidalre cooktop
44.  Kirk gas refrigerator
45.  Sub-Zero refrigerator
46.  Westinghouse refrigerator

47.  Packet hot-water boiler
48.  Hastings air circulator
49.  Hydrotherm boiler
50.  Formica bathroom tile
51.  Richmond square tub
52.  Kemlite Patnel panels
53.  Sanpak sandwich panels
54.  Tebeo velour brick
55.  Armstrong scored Armalite
56.  Delbar gate closer
57.  Sani-Fax dishwasher
58.  Magnum shower rod
59.  Gerpak polyethylene tape
60.  Illinois hydraulic door closer
61.  Swanson paper dispenser
62.  Merit glue dryer
63.  Imported German hardware
64.  Kwikset entrance lockset
65.  Shelby glass-door closer
66.  Lamp-Lyter switch
67.  Huncilman chimney
68.  Hess patio roof panel
69.  Bestwall paneling
70.  National cabinet hardware

**PUBLICATIONS**

71.  Certain-teed color service
72.  American-Marietta color guide
73.  Goodrich flooring portfolio
74.  Caloric curtain and wall details
75.  General Industrial slide rule
76.  Carlon rigid plastic pipe guide
77.  DFPA job shack booklet
78.  Remcon installation manual
79.  ARI directory
80.  Fiberglas pipe insulation bulletin
81.  Fiberglas concrete blanket bulletin
82.  Metalbestos chimney guide
83.  Thor drill stand report
84.  Silvatek hardboard literature
85.  Horn Construction Data Book
86.  Kaiser's aluminum mill products booklet
87.  Flintkote bulletin AF-1
88.  Flintkote bulletin AF-6

NAME \_\_\_\_\_

OCCUPATION \_\_\_\_\_ TITLE \_\_\_\_\_

FIRM \_\_\_\_\_

STREET \_\_\_\_\_

CITY \_\_\_\_\_ STATE \_\_\_\_\_

**IMPORTANT:**

House & Home's servicing of this coupon expires June, 1959. In addressing direct inquiries please mention **House & Home** and the issue in which you saw the product or publication.

I wish to enter a subscription to **House & Home** for 1 year, \$6  2 years, \$8   
US and possessions and Canada only

New  Renewal \_\_\_\_\_  
Signature \_\_\_\_\_



meet the "MASTER BUILDER"



**Berger's  
'59 model  
convertible  
transit-level**

**\$229<sup>50</sup>**  
Includes Tripod  
and Case  
Without Tripod  
\$197<sup>50</sup>  
F. O. B. Factory

We call this new convertible the "MASTER BUILDER" because it is designed for the builder who wants big instrument performance—at a moderate price. Added brawn, without excess weight, combines with rotating center (as in engineers' levels) to assure accuracy for any construction challenge.

Its 3-ft. short focus enables you to work in cramped quarters. Its 22-power telescope will sharply define individual graduations on a rod at greater distances. It gives you unrivaled performance even in poor light. Horizontal circle and vertical arc with double verniers read to 5 min.

Whether you're leveling a foundation, setting forms or plumbing a column, you'll find the "MASTER BUILDER" a profitable time saver. Write for details.  
C. L. BERGER & SONS, INC., 37H Williams St., Boston 19, Mass.

THE BEST IN-SIGHT IS **BERGER**  
Engineering & Surveying Instruments... Since 1871



**10-Man Hours to Set-Up Foundation  
with SYMONS LO-WALL FORMS**

At its new housing development, Contractors and Builders, Inc. uses Symons Lo-Wall Forms and three specialized crews to keep job moving. One three-man crew erects, two or three men pour and two men strip. It takes 10 man-hours for form erection, 1½ man-hours for pouring, and only three man-hours to strip and move the forms. Foundations vary from 33 x 49 feet to 29 x 57 feet.

**Symons CLAMP AND MFG. CO.**

4277 Diversey Avenue, Dept. A-9, Chicago 39, Illinois

- Send literature; not interested in buying now.
- Send literature, prices and have salesman call.

Name \_\_\_\_\_  
Firm Name \_\_\_\_\_  
Address \_\_\_\_\_  
City \_\_\_\_\_ Zone \_\_\_\_\_ State \_\_\_\_\_

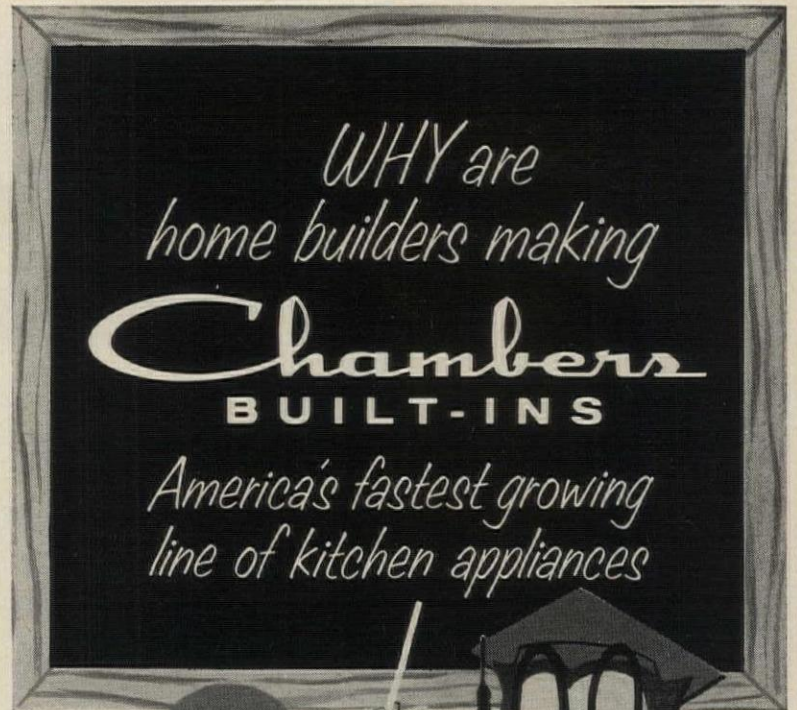

Yes . . . more and more of America's finest builders are swinging to Chambers Built-ins! . . . and here's why:

- **Chambers Built-Ins are Sold Primarily to Builders . . .** not through appliance stores!
- **It's a Perfectly Balanced Line** of gas and electric ranges and ovens, truly built-in refrigerator-freezers, dishwasher-dryers, ventilating hoods and disposers.
- **It's Quality-Styled** in pure plated Antique Copper, Silver Satin Chrome and gleaming Copperlux.
- **It's Realistically Priced** for every home—from budget to deluxe.
- **A Nation-Wide Distributor Organization** assures fast attention . . . whatever your problem.
- **Powerful National and Local Advertising** carries the exciting Chambers Built-in story to millions of homemakers—who know that Chambers is quality.
- **Solves Your Service Headaches**—with one call to order—one call to service all Chambers appliances! Write or wire for complete specifications and name of nearest Chambers distributor.

Chambers SINCE 1910 . . . the most honored name in America's finest kitchens

**CHAMBERS BUILT-INS, INC.**  
2012 North Harlem Ave., Chicago 35, Illinois

# SURE STEPS TO SALES



## 1. Your prospects see "the things to look for"...

In *Better Homes and Gardens*, *House Beautiful* and the special home building magazines, your prospects are seeing this message over and over:

"Look for the things that only Crane can offer—among them a 28% preference over all other brands!"

## 2. they find them, in

# YOUR MODEL HOME

They look at the bathroom, and there is the name—CRANE. It's what they're looking for. They *know* Crane plumbing is preferred. They *know* it's tops in quality. Clearly, here is a quality builder . . . here is a quality home.

That's the kind of thing that steps up sales!

Especially when you *promote* it, when you capitalize on this known preference for Crane! And now your Crane Representative makes that mighty easy to do. He has a *complete promotion kit* ready and waiting for you: yard signs, window streamers, product cards, handouts—everything you want for model home display.

Now, when it's so very simple, so sure-fire—*now* is the time to step up your promotion . . .

*step up your sales with*

Here it is,  
YOUR COMPLETE  
PROMOTION KIT—  
everything you need  
to step up your  
sales. Remember,  
it's yours for the  
asking—compliments  
of Crane.



# CRANE®

*the preferred plumbing*

CRANE CO., 836 South Michigan Avenue, Chicago 5, Ill. • Valves • Fittings • Pipe • Plumbing • Heating • Air Conditioning

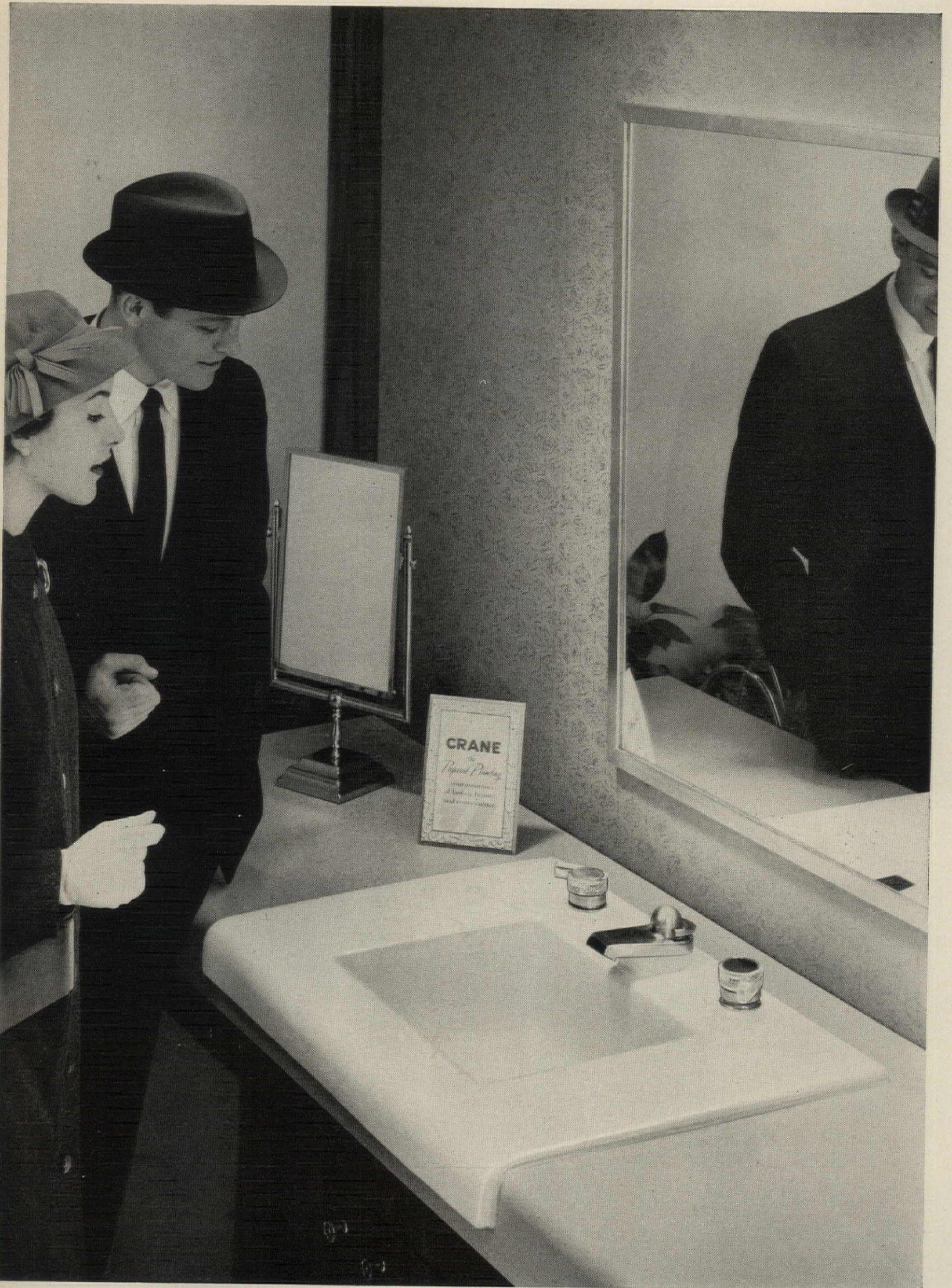

**CRANE**  
*The Rapid Painter*  
MADE IN U.S.A.  
OF LAMINATED GLASS  
AND CHROME PLATING

# Woven Pile Weatherstripping

## PROTECTION—SILENT, SMOOTH, SURE

For doors or windows that move, nothing else offers the perfect seal and smooth operation you get with Schlegel Woven Pile Weatherstripping.

The natural resilience of pile permits *easy motion* under all temperature conditions. Schlegel's exclusive silicone treatment adds moisture resistance.

The seal is *quiet*—never any metallic scrape or plastic squeak.

The *protection is permanent*. Openings sealed with Schlegel

weatherstripping 20 years ago still work perfectly.

The best windows and doors are engineered for weather protection and smooth operation with Schlegel Woven Pile.

### FREE

A new booklet lists (by types) doors and windows made better by the use of Schlegel Woven Pile—and tells who make them. We'll be glad to send you a copy.

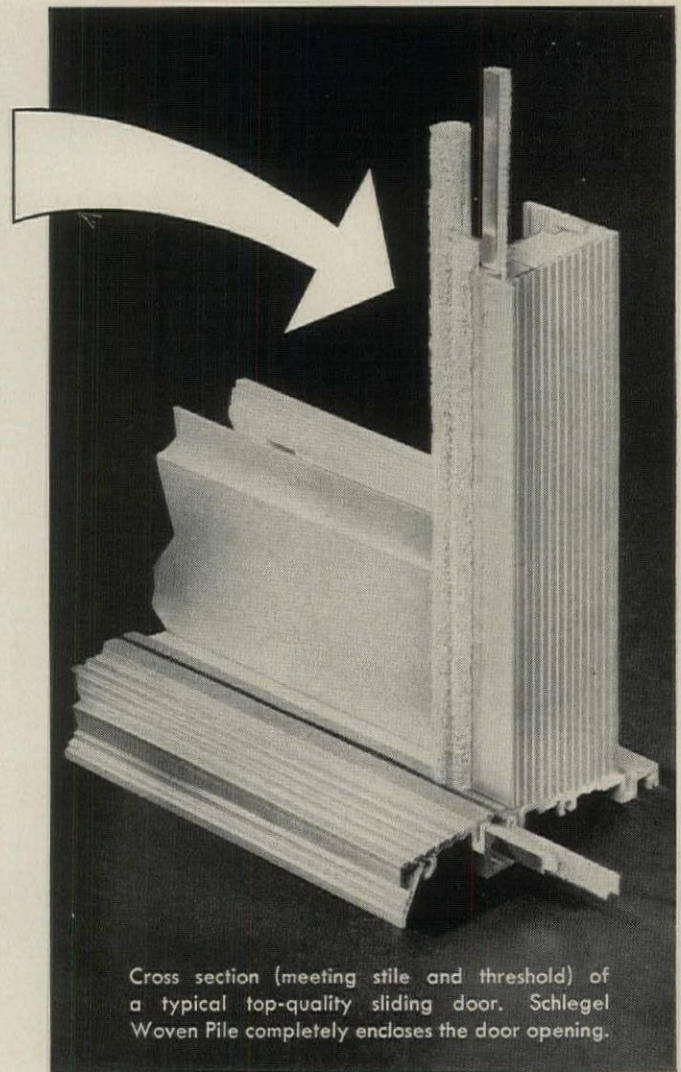

Cross section (meeting stile and threshold) of a typical top-quality sliding door. Schlegel Woven Pile completely encloses the door opening.

# Schlegel

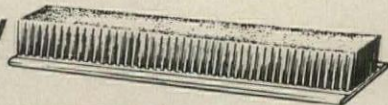

**WOVEN PILE WEATHERSTRIPPING**  
**SCHLEGEL MANUFACTURING COMPANY**  
 Rochester 1, N.Y.—In Canada: Oakville, Ontario

## Use this special coupon to get more information about electric heating

The numbers below are keyed to the electric heating products listed in the electric heating article on pp 172-178. Circle the ones that interest you and mail the coupon to:

**House & Home, Room 1021A, 9 Rockefeller Plaza, New York 20, N.Y.**

<b>Baseboards</b>	E7	E8	E9	E10	E11	E12	E13	E14	E15	E16	E17	E18	E19	E20	E21
	E22	E23	E24	E25	E26	E27	E28	E29	E30	E31	E32	E33	E34	E35	E36
<b>Wall and ceiling panels</b>	E47	E48	E49	E50	E51	E52	E53	E54	E55	E56	E57	E58	E59	E60	E61
	E62	E63	E64	E65	E66	E67	E68	E69	E70	E71	E72	E73	E74	E75	E76
	E77	E78	E79	E80	E81										
<b>Heat pumps</b>	E92	E93	E94	E95	E96	E97	E98	E99	E100	E101	E102	E103	E104	E105	E106
	E107	E108	E109	E110	E111	E112	E113	E114	E115	E116	E117	E118	E119	E120	E121
	E122	E123	E124	E125	E126										
<b>Central heating</b>	E127	E128	E129												

NAME \_\_\_\_\_

OCCUPATION \_\_\_\_\_ TITLE \_\_\_\_\_ FIRM \_\_\_\_\_

STREET \_\_\_\_\_ CITY \_\_\_\_\_ STATE \_\_\_\_\_

**IMPORTANT:** HOUSE & HOME's servicing of this coupon ends June 1959. (H&H's regular new products coupon is on p 264.)

## ADVERTISERS INDEX:

This advertisers index published by HOUSE & HOME is an editorial service to its readers. HOUSE & HOME does not assume responsibility to advertisers for errors or omissions in preparation of these listings.

Page:	
5	Admiral Corp.
40, 41	Ador Sales, Inc.
219	Allied Chemical & Dye Corp. ( <i>The Barrett Div.</i> )
44, 45, 113-116	Aluminum Company of America
77, 78	American Biltrite Rubber Co. ( <i>Amtico Flooring Div.</i> )
97	American Brass Co.
100	American Gas Association
58, 60	American-Marietta Co.
46	American Motor Corp. ( <i>Kelvinator Div.</i> )
238	American Screen Prod. Co.
50	American-Standard Corp. ( <i>Air Conditioning Div.</i> )
17, 18	American-Standard Corp. ( <i>Plumbing &amp; Heating Div.</i> )
194, 195	American Steel & Wire Div. ( <i>U. S. Steel Corp.</i> )
106	American Telephone & Telegraph Co.
68	American Window Glass Co., The
92, 93	Andersen Corp.
231	Appleton Coated Paper Co., The
254	Azrock Products Division ( <i>Uvalde Rock Asphalt Co.</i> )
98	Barclay Mfg. Co., Inc.
219	Barrett Division, The ( <i>Allied Chemical &amp; Dye Corp.</i> )
4	Bell & Gossett Co.
265	Berger & Sons, Inc., C. L.
110	Berko Electric Mfg. Corp.
239	Besser Co.
31	Bestwall Gypsum Co.
208	Bostitch, Inc.
119	Bruce Co., E. L.
70, 71	Bryant Electric Co.
269	Bryant Mfg. Co.
227	California Redwood Assn.
283	Caloric Appliance Corp.
109	CARADCO, Inc.
220	Chase Brass & Copper Co.
203	Certain-Teed Prod. Corp.
265	Chambers Built-Ins, Inc.
213	Clay Flue Lining Institute
196	Commercial Controls Corp. ( <i>Electromode Div.</i> )
266, 267	Crane Co.
192	Crawford Door Co.
48, 49	Curtis Companies Service Bureau
99	Curon Div. ( <i>Curtiss-Wright Corp.</i> )
270	Daryl Prod. Corp.
96	De Vac, Inc.
7-15	Douglas Fir Plywood Assn.
201	Dur-O-Wal
108	Edwards Engineering Co.
252	Efron Manufacturing Co., Theodore
196	Electromode Div. ( <i>Commercial Controls Corp.</i> )
55, 56	Evans Brick Co.
225	Fasco Industries, Inc.
66, 67	Fedders-Quigan Corp.
232	Fleet of America, Inc.
84, 85	Flintkote Co., The
28, 29	Ford Motor Co.
76	Frantz Mfg. Co.
57, 80-82	General Electric Co.
249-251	General Electric Co. ( <i>Hotpoint Div.</i> )
32	General Electric Co. ( <i>Textolite Div.</i> )
224	Hall Mack Co.
222	Harris Manufacturing Company
72	Hobart Manufacturing Co., The
258	Home Comfort Mfg. Co.
249-251	Hotpoint Co. ( <i>Division of General Electric Co.</i> )
226	Hough Co., The Frank G.
34	Hunter Div. ( <i>Robbins &amp; Myers, Inc.</i> )
233	Inland Homes Corp.
241	International Harvester Co.
24, 205, 252	Johns-Manville Corp.
46	Kelvinator Division ( <i>American Motor Corp.</i> )
38	Kentile, Inc.
52, 53	Keystone Steel & Wire Company

# NO JOB HOLD-UP with **BRYANT**

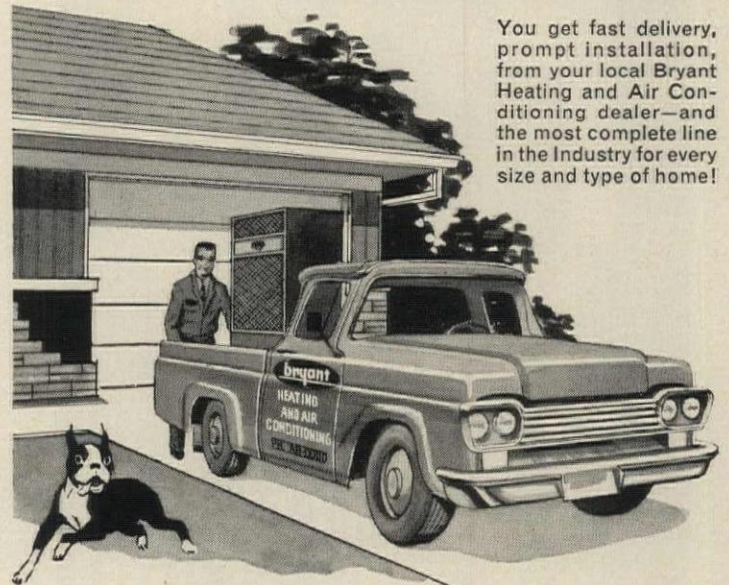

You get fast delivery, prompt installation, from your local Bryant Heating and Air Conditioning dealer—and the most complete line in the industry for every size and type of home!

## Only BRYANT offers ALL from ONE SOURCE:

**FURNACES** for all types of fuel . . . compact, economical, beautifully designed and finished.

**BOILERS** for hot water, steam or radiant heat in wide range of capacities for residential use.

**AIR CONDITIONERS** of all types . . . gas or electric, self-contained, remote, combined heating and cooling.

**WATER HEATERS** completely sealed-in-glass, all joints deep-welded with liquid glass fused at high temperature.

**EXPERT SERVICE**—and a complete stock of parts for all Bryant equipment.

. . . AND BRYANT COMPLETELY SATISFIES HOME OWNERS! Your local Bryant dealer, with solid support from his nearby distributor, takes full responsibility. He installs and adjusts the world's finest heating, air conditioning and water-heating equipment for peak efficiency—then gives prompt, expert service. There are never any complaints to the builder when you use Bryant!



*Years Ahead  
in Year 'Round  
COMFORT!*

**BRYANT MANUFACTURING COMPANY, Indianapolis, Ind.**  
In Canada: Bryant Manufacturing Ltd., Toronto

**"O.K. SO DARYL'S COME OUT  
WITH A NEW SLIDING GLASS  
DOOR. SO WHAT?"**



SO JUST THIS, MR. TUFFSELL THE NEW

# Patio-rama

TRADE MARK

**ALUMINUM SLIDING GLASS DOOR  
IS THE ONE UNIT DESIGNED  
AND PRICED FOR THE MASS  
BUILDER AND . . .**



**"O.K. CUT THE SALES  
TALK. SHOW ME! I WANT  
FACTS!"**

**YOU WANT FACTS? FINE!  
JUST MAIL COUPON.**

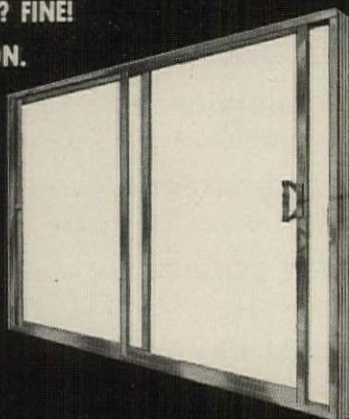

BY THE  
MANUFACTURERS  
OF  
**Patio Magic**

**ALUMINUM SLIDING  
GLASS DOORS**

**DARYL  
PRODUCTS  
CORP.**

7240 N.E. 4th AVE.  
MIAMI, FLORIDA

O.K. You've got me interested. HH

Daryl Products Corp.  
7240 N. E. 4th Avenue Miami, Florida

Please forward full information and free  
Sales Packet on Patio-rama.

Name .....

Company .....

Address .....

City ..... State .....

<b>Page:</b>	
228	Koppers Company, Inc. ( <i>Wood Preserving Co.</i> )
3	Kwikset Sales & Service Co.
88, 89	Lennox Industries Inc
62, 63	Libbey-Owens-Ford Glass Company
217, 218	Line Material Industries ( <i>Division of McGraw Edison Co.</i> )
223	Louisville Cement Co.
248	Majestic Co., Inc., The
204	Massey-Ferguson, Inc. ( <i>Industrial Div.</i> )
217, 218	McGraw Edison Co. ( <i>Line Material Industries</i> )
244	McQuay, Inc.
259	National Concrete Masonry Assn.
79	National Gypsum Co., The
284	National Homes Corp.
196	National Lock Co.
257	National Lumber Mfrs. Assn.
19	National Oak Flooring Manufacturers Assn.
Cover II, I, 1A	Nutone, Inc.
33	Olin Mathieson Chemical Corp. ( <i>Metals Div.</i> )
221	Onan & Sons, Inc., D. W.
246	Orangeburg Manufacturing Co., Inc.
247	Pacific Lumber Co., The
261	Peterson Window Corp.
104, 105	Pittsburgh Plate Glass Co.
230	Portland Cement Association
30	Ready Hung Door Corp.
240	Red Cedar Shingle Bureau
2, 74, 75	Republic Steel Corp.
234, 235	Revco, Inc.
120	Richmond Plumbing Fixture Division ( <i>Rheem Mfg. Co.</i> )
34	Robbins & Myers, Inc. ( <i>Hunter Div.</i> )
236	Roberts Manufacturing Co.
101	Rolscreen Co.
248	Romar Filter Corp.
26	Roper Corp., George D.
243	R. O. W. Sales Co.
90	Rowe Manufacturing Co.
25	Ruberoid Co., The
253	Samuel Stamping & Enameling Co.
102	Schlage Lock Co.
268	Schlegel Mfg. Co.
255	Shakertown Corp.
242	Shower Door Co. of America
27	Shelby Spring Hinge Co., The
197-200, 245	Simpson Logging Co.
16	Soss Manufacturing Co.
193	Spotnails, Inc.
237	Square D Company
6	Stanley Works, ( <i>The Hardware Div.</i> )
265	Symons Clamp & Mfg. Co.
264	Timber Engineering Co.
213	Trade-Wind Motorfans, Inc.
194, 195	United States Steel Corp. ( <i>American Steel &amp; Wire Div.</i> )
94	Universal-Rundle Corp.
254	Uvalde Rock Asphalt Co. ( <i>Azrock Products Div.</i> )
228	Ventrola Mfg. Co.
261	Wadsworth Homes
215	Walker & Son, Inc., T. V.
35	Weiser Co.
36, 37	Western Pine Assn.
207	Western Red Cedar Lumber Assn.
20, 21	Westinghouse Electric Corp.
112	Weyerhaeuser Sales Co.
190, 191	Whirlpool Corp.
188	White-Rodgers Co.
1B	Wood Mosaic Co.
228	Wood Preserving Division ( <i>Koppers Co., Inc.</i> )
262, 263	York Corp.
229	Zegers, Inc.