

House & Home

THE MARKETING AND MANAGEMENT PUBLICATION OF THE HOUSING INDUSTRY

JANUARY 1969

**Subsidized rental housing: a fair profit for builders?
Special preview: 24 pages of new products for 1969**

**A
POTPOURRI
OF BRIGHT IDEAS
IN FLOORS BY
AZROCK**

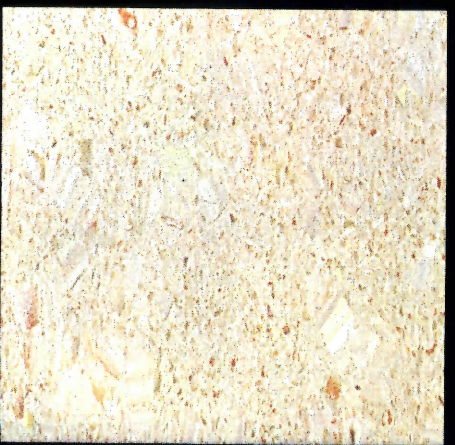
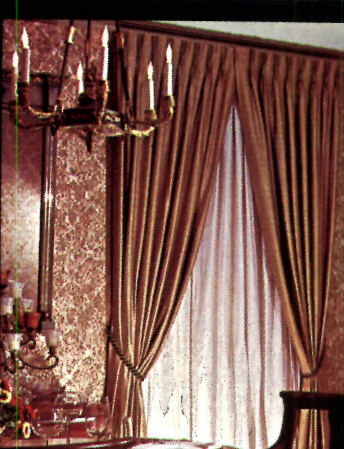
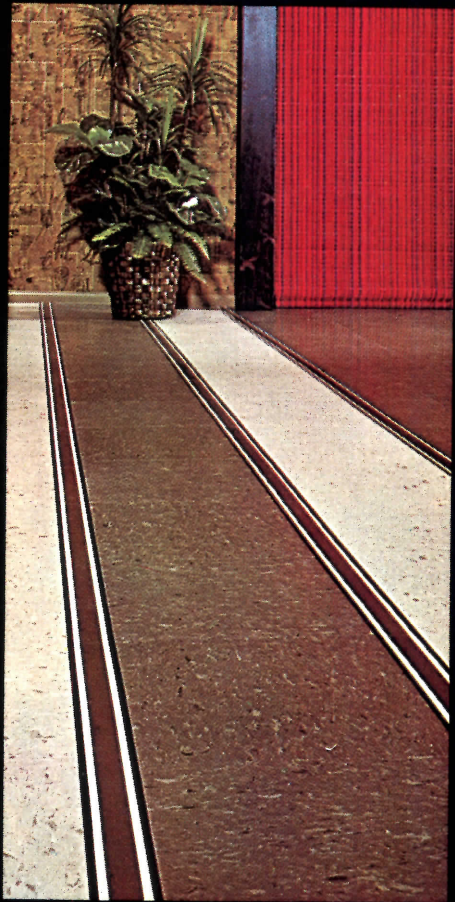

Azrock proclaims the end of the "dull floor" era in homes and apartments! Now you can "turn on" your prospective buyers with the up-to-the-minute excitement of Azrock vinyl asbestos tile floors... with unlimited custom designs straight from the carton... and do it within the strictest budget. Whether you're selling elegance... casual charm... or just plain fun... Azrock's more than 120 colors and styles give you more to sell. Specify Azrock floors of vinyl asbestos tile... and enjoy the profitable difference.

original floor stylings by **AZROCK**[®]

Nationally advertised in the special editions of Better Homes and Gardens, House Beautiful, House and Garden, and others. For free samples, write Azrock Floor Products, 551B Frost Building, San Antonio, Texas 78205. Circle 50 on Reader Service card.

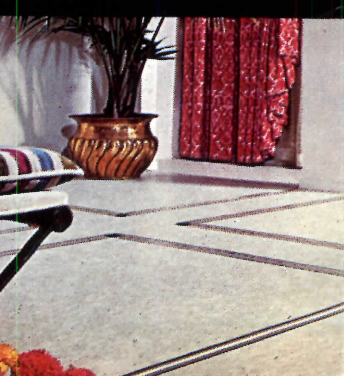

EDITOR

Richard W. O'Neill

MANAGING EDITOR

John F. Goldsmith

SENIOR EDITORSJames P. Gallagher
Maxwell C. Huntoon Jr.
Edwin W. Rochon
H. Clarke Wells**ASSOCIATE EDITOR**

Frank Lalli

ASSISTANT EDITORSDavid A. Martin
Jenepher Walker**ART DEPARTMENT**Howard R. Berry, director
Annette Mansella, assistant
Jan V. White, consultant**EDITORIAL ASSISTANTS**Patricia Betz
Grace Kelly
Elizabeth K. McPherson
Barbara H. Palumbo**EDITORIAL CONSULTANT**

Carl Norcross

CONSULTING ECONOMIST

George A. Christie

McGRAW-HILL WORLD NEWSArthur Moore, director; Jules Abend,
domestic news editor. Domestic News Bureaus—
Atlanta: Frances Ridgway, chief; Robert Coram.
Chicago: Robert Lee, chief;
Jim Rubenstein, news editor.
Cleveland: Arthur Zimmerman, Chief. Dallas:
Marvin Reid, chief; Mary Lorraine Smith.
Detroit: James Wargo, chief;
Marianne Friedland.
Los Angeles: Michael Murphy, chief;
Barbara Lamb. Pittsburgh: Lou Gomolak, chief.
San Francisco: Margaret Drossel,
chief; Jenness Keene.
Seattle: Ray Bloomberg, chief. Washington:
Charles Gardner, chief; Rex Rhein.**PUBLISHER**

James E. Boddorf

CIRCULATION MANAGER

Henry G. Hardwick

ADVERTISING SALES MANAGER

Richard H. Freeman

**McGRAW-HILL**

HOUSE & HOME Jan. 1969, Vol. 35, No. 1. Published monthly by McGraw-Hill Inc. Founder: James H. McGraw (1860-1948). Subscription rates for individuals: U.S. and possessions and Canada, \$6 per year; single copy, if available, \$1; Latin America & Philippines, \$20; elsewhere, \$25. The Publisher reserves the right to accept or reject any subscription. Executive, Editorial, Circulation and Advertising offices: McGraw-Hill Building, 330 West 42 Street, New York, N.Y. 10036. Telephone: 971-3333. Second class postage paid at Washington, D.C. and at additional mailing offices. Published at 1500 Eckington Place, N.E., Washington, D.C. 20002. Title © in U.S. Patent Office. Copyright © 1969 by McGraw-Hill Inc. All rights reserved. The contents of this publication may not be reproduced either in whole or in part without consent of copyright owner. **Officers of McGraw-Hill Publications:** Joseph H. Allen, president; J. Elton Tuohig, executive vice president; Robert F. Marshall, senior vice president-operations; vice presidents: John R. Callahan, editorial; Paul F. Cowie, circulation; John R. Emery, administration; John M. Holden, marketing; David G. Jensen, manufacturing; Jerome D. Luntz, planning and development; Robert M. Wilhelmy, controller. **Corporation Officers:** Shelton Fisher, president & chief executive officer; John L. McGraw, chairman; Daniel F. Crowley, Donald C. McGraw Jr., Bayard E. Sawyer, senior vice presidents; R. E. Slaughter, executive vice president; John J. Cooke, vice president & secretary; Gordon W. McKinley, vice president & treasurer. Member: Audit Bureau of Circulations and American Business Press. This issue of House & Home is published in national and separate editions noted or allowed for as follows: Western W1-W6B; Eastern E1-E2B; Midwest M1-M4B; North Central N1-N2B; Southern S1-S4, SW1-SW4. Postmaster: Please send form 3579 to Fulfillment Manager, House & Home, P.O. Box 430, Hightstown, N.J. 08520.

JANUARY 1969

House & Home

A McGRAW-HILL PUBLICATION

VOL. 35 NO. 1

JANUARY 1969

EDITORIAL

How realistic are the nation's low-income housing goals? 67
Not very. And all the talk of producing 26 million units in the next ten years simply raises false hopes and fuels distrust of government leaders

FEATURES

What to expect in new products for 1969 68
Here is HOUSE & HOME's annual preview of materials and equipment that can make your houses and apartments distinctive in today's competitive market

Is there a fair profit in subsidized rental housing? 84
Up to six months ago the answer was yes. But now that Congress has changed some of the rules, builders may have to change their approach to this market

Housing's top performers of 1968 90
Once more HOUSE & HOME singles out 12 representative leaders who have made outstanding contributions of lasting value to the homebuilding industry

A steel prefabber finds opportunities in low-rise apartments 92
After two decades of trial and error, U.S. Steel Homes gets results by coupling its versatile new wall system with its low-key marketing strategy

1969 forecast: It could be homebuilding's best since 1950 96
Ten leading housing economists predict from 1.6 to 1.75 million starts but hedge their optimism by citing the effects of five big economic ifs

NEWS

Violence in Strongsville: Bomb rips a Bob Schmitt house 12
No one was injured, but the Ohio builder now fears for his personal safety; Schmitt, a nonunion employer, has been picketed by unions for 14 months

Wall Street chases big builders to cash in on housing's boom 4
Investment houses now plan to underwrite 15 builders who will go public, provide front money for dozens of others and even form homebuilder consortiums

The Nixon housing team: George Romney and Dan Moynihan 20
Michigan governor is the President-elect's choice as Secretary of Housing; Moynihan, the outspoken Democrat who tells it like it is, to be top advisor

DEPARTMENTS

Housing-stock prices	8	Technology	106
Mortgage-market quotations	26	New literature	135
Letters	44	Reader service card	119
Leaders	34	Advertising index	140

Cover 221d3 apartment project in Waterbury, Conn. Builder and owner: John Errichetti Associates. Architect: Joseph Stein. Photo: Ben Schnall.
For story, see page 84.

NEXT MONTH

Why—and how—a trend-setting building company revamped its house designs and land planning to capitalize on its changing market . . . Polyurethane: the plastic that's starting to make it big in housing . . . Marketing and management tips from a multi-state apartment builder . . . The best of two worlds: three houses that combine the qualities of contemporary and traditional design

3



Wall Street to the big homebuilders-- Let's team up for a ride on the boom

The ticker-tape jockeys know a sure thing when they see it.

There is a housing boom on the way. So Wall Street is rushing to get its money into the big homebuilding companies.

This will be the year of the homebuilder, as surely as 1968 was the year of the mobile-home maker.

And the results will be similar.

In 1968 the Street propelled some mobile-home makers to industry dominance. And in 1969 the investment community will accelerate the growth—and competitive advantages—of the biggest homebuilders.

Housing is already booming on Wall Street:

- The Larwin Group Companies of California, the industry's largest independent, will decide within six weeks whether to file with the Securities and Exchange Commission for going public or whether to merge into a giant corporation.

- Fifteen other homebuilders will go public this year. Among the first to go: Centex Corp. of Texas and New Jersey builder Robert Schmertz.

- Homebuilder stocks will get hotter. Says Gary Gastineau, an assistant vice president of Laird Inc., a Wall Street investment house: "They will hit 40 times earnings—right across the board."

- An example of the heat: Pittsburgh's Ryan Homes upped its opening price from 22½ to 26 just days before its public offering. The first trade last month was at 36, or 33 times current earnings.

- Underwriters are so eager to bring out new housing issues that they are even searching out little builders with less than \$10 million in annual sales. Bob Schmertz's Leisure Technology Corp., which goes public this month, had fiscal '68 revenues of \$9.5 million.

- One Wall Street investment house—Donaldson, Lufkin & Jenrette—has founded a company to joint venture with dozens of small homebuilders.

- And at least one other house, Laird, wants to form its own giant—a consortium of building companies.

Despite this ferment, several builders resist Wall Street's overtures. About 35, according to one estimate, plan instead to merge into big corporations. The next such merger: Tacoma's United Homes Corp. (Herman Sarkowsky, president) into International Telephone & Telegraph Corp., which absorbed Levitt & Sons last year.

Good for how long? Housing stocks will go higher before they go lower; but there is a reckoning ahead.

By the end of 1969, stock analysts say, earnings of some weak new issues and other marginal companies will inevitably flatten,

precipitating a shakeout. But leaders such as Kaufman & Broad should continue to fly at 30 times earnings or more.

The warnings are not scaring off investors. Wall Street is instead stepping up efforts to buy in.

And Wall Street is offering something all homebuilders want—enough money to capitalize fully on tomorrow's boom. Here are three ways The Street plans to pump its money into homebuilding:

1. *Underwriting new issues.* With the public willing to pay \$30 for a share earning \$1, even a modest offering of 500,000 shares would bring in \$15 million. Out of that, the underwriter would take an 8% commission, plus \$200,000 or so, leaving the homebuilding company and its principals to split \$13.6 million.

Comparatively few of the nation's 40,000 homebuilders are big enough to go public. Some industry sources estimate that less than 200 builders have sustained annual sales of \$10 million or more. But the underwriters are certainly interested in those 200—and more—and they list only five basic requirements:

- The company should be large enough (\$500,000 profit on sales of \$15 million) to offer at least 500,000 shares.

- The company should have a record of steady growth. A good performance in tight-credit 1967 is particularly impressive.

- The company should have a five-year growth plan. Says consultant Stanley Edge: "Wall Street wants to know who is going to sell what."

- The company should build in more than one section of the country.

- The company should expect the underwriter's scrutiny for six months before shares are offered.

2. *Offering front money.* Less than a year after Donaldson, Lufkin & Jenrette founded it, Builders Resources Corp. has committed enough front money to a dozen builders to permit construction of 3,000 houses by 1971.

The company, which expects to be working with 50 builders in four years, offers 80% of the front money (up to \$500,000) in return for 50% of the project's profit. The BRC staff is also available for management and financial advice.

Leonard Harlan of DLJ says: "Maybe someday BRC and its builders will want to become one big publicly held company."

3. *Offering creative capital.* This highly sophisticated approach has succeeded in other industries, but no one has applied it to homebuilding. Now its chief proponent, Laird, would like to try.

Laird would recruit a top housing executive of the stature of, say, K&B's President



HOUSING'S MANDEL BERMAN . . .

"All sorts of visions are going around in our heads."



. . . LARRY WEINBERG

"We are seriously studying whether to go public or merge."



. . . STAN EDGE

"All my consulting service clients talk of going public."



. . . HERMAN SARKOWSKY

"Who told you I was planning to merge with ITT?"

Eugene Rosenfeld. It would put him in charge of a newly acquired, family-held building company. Backed by Laird's money, management skills and recruiting experience, the executive would buy and staff as many small related companies as he could find. In two years or less, as sales hit \$15 million, the consortium would be sold to the public.

Says Laird's 37-year-old president, Sidney Staunton, telling of such ventures in other industries: "Our return exceeds 10 times our investments."

Builder response. Most builders' first reaction to Wall Street attention is confusion. Says DLJ's Harlan, only half in jest: "Builders don't know from borscht about how Wall Street operates."

But the builders are catching on. Here's how six of the largest are responding to the call.

The Larwin Group. President Lawrence Weinberg is still undecided. But through a series of dramatic moves, he has cleared the way for a decision this month.

First, Weinberg hired Levitt & Sons' Senior Vice President Richard Weiss, 44, a brother-in-law (*see story, p. 8*). Weiss, now second in command of Larwin's building operation, may steer the company to Chicago, his Levitt stamping ground (NEWS, Dec. '67).

Second, the company began a massive audit—a sign that outsiders are studying its books. The audit produced these highly attractive preliminary figures: 1967 sales of \$32.5 million and profit of \$3.2 million, or 9.8% after taxes; 1968 sales of \$50 million and profit of \$4.7 million, or 9.4% after taxes; estimated 1969 sales of \$76.4 million and profit of \$7.3 million, or 9.6% after taxes.

Although Weinberg may yet merge, some stock analysts believe the stock market will prove too hot to pass up. One analyst, assuming continued Wall Street interest in builders, offered this stock-price estimate based on an offering of 2.5 million shares out of total capitalization of 8 million shares.

Larwin shares, earning 90 cents each, could be offered at \$25 and would open at \$35. That would raise \$62.5 million for Larwin and its principals with \$58.7 million remaining after underwriting fees equivalent to \$1.50 a share. By 1970, assuming solid growth, Larwin shares could climb to \$55, or 40 times \$1.37 per share

earnings. And by early 1971, shares could hit \$82, still at 40 times earnings per share.

Even to Weinberg, who at 42 is reportedly worth \$50 million, such figures are surely appealing. But in fact, his decision may have little to do with money.

Men who know him well say he is torn between his pride and his sense of practicality. He wants recognition as the industry leader, and that is within his grasp if Larwin goes public. But he values the privacy he and his company can maintain by merging or even by remaining independent.

Says Weinberg: "Public disclosure would help Larwin's competitors. But personally, I believe I could adjust to operating in the spotlight of attention. I have no phobias about secrecy."

United Homes Corp. President Herman Sarkowsky has decided to merge into ITT.

Sarkowsky, who builds in Washington State and Oregon, could easily have gone public on his record. He has five years of solid growth, and sales for fiscal 1969 are estimated at \$25 million, up from \$14 million in two years.

The reasons for his merger decision are unclear. But in a conversation—before he was asked about ITT—Sarkowsky conceded that he could finance his company "the way it should be" by going public.

Yet, almost plaintively, he described himself as a free-wheeling entrepreneur:

"I would hate to see that part of my life end."

Suburbia Homes. Harold Tancredi, who heads a \$15 million homebuilding company in Los Angeles, will wait another year before filing to go public.

Tancredi reached that decision on advice from a Wall Street investment house.

"We are borderline now," says Vice President Ralph Jensen, "but we plan to hit sales of \$20 million on 600 houses this year—and then go public."

If sales lag, the company has an alternative plan to reach the \$20 million mark by purchasing a small builder.

Jensen says that unless Suburbia raises about \$5 million its growth rate will slow down. He adds: "We are all set. We have a growth record, seasoned management and enough land to diversify to San Francisco and elsewhere. All we really need is a public relations man to enhance our public image."

Bert L. Smokler & Co. The Detroit company is an obvious candidate to become publicly held in the next six months.

Senior Vice President Mandell L. Berman says merely: "We are not prepared to discuss our plans."

The company reached sales of \$30 million last year despite Detroit's three-month craft strike. That was a \$5 million increase from 1967.

Smokler is geographically diversified. Last year it built government-assisted housing in Topeka and Omaha. And it opened a Washington branch that is expected to produce \$5 million of this year's estimated sales of \$40 million.

Perl-Mack Co. President Samuel Primack sees no advantages in selling shares to the public—"I'm not hungry."

Yet Primack would like more long-term money at stable rates to expand his \$22 million Denver company. He adds:

"In a publicly held company I would have to change my auditing system. And my role here would change. I am not even interested in building outside Denver.

"The trick now is to produce real profits, not paper profits."

Multicon Corp. Vice President John Kessler does not think public investors would appreciate his \$38 million company.

In seven years, the Columbus-based company has built 7,000 garden apartment units in 20 cities. But it maintains its projects and writes down the depreciation against earnings. So it has deliberately never shown a profit (H&H, Feb. '67).

Says Kessler: "We have the money and the talent to dominate the garden apartment market. We can grow 20% a year now."

(In a related development, a competitor—Kansas Quality Construction—has announced plans to merge into the publicly held Titan Group. The price: \$7.7 million in convertible subordinated debentures.)

The consequences. The 50 big homebuilders favored will have all the competitive advantages that money can buy for them.

No one believes that as a consequence the nation's other 40,000 builders will disappear. Yet more big builders will buy more little builders; more little builders will gravitate to custom construction and other specialties; more will team with peers to buy and develop large tracts and, increasingly, the mass-market for houses under \$25,000 will become the domain of the mass builder.

—FRANK LALLI

NEWS continued on p. 8

G-P Paneling.

Over 130 exciting panels! All with easy care finishes. Good looking? You bet! In fact, G-P paneling is your *best bet* for easy care, leisure-living homes.



G-P 1/4" Gypsum Sound Deadening Board.

An exciting sales feature. Lets some people sleep while others swing! 1/4" Gypsum Sound Deadening Board is incombustible, too. And it's priced below most combustible sound control products!



G-P Vinyl Shield® Tortoise Shell.

Has the look and feel of finest foil wallpaper. At a fraction of the cost! Great for backing up wet bars, sinks—anywhere there's water. Four exciting patterns.

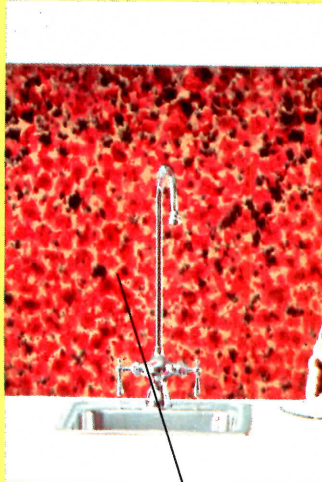

G-P Hardwood Plywood.

Combinations to meet virtually any woodworking requirement! Just about any face and core you want—including hardwood with a flakeboard core.



inside!

This is the good life! The leisurely, carefree life. And Georgia-Pacific responds to the tempo of the times with all the products builders need to make homes care-free. Inside, it's walls that never need painting, wall systems that deaden sound, and highest quality materials for beauty that lasts!

G-P Siding.
 All kinds of siding—the smoothest, roughest, and everything in between! Including hardboard lap siding with a painting guarantee. How's that for low maintenance? Widest selection of styles, sizes, and textures.

G-P Overlaid Plywood.

Medium density softwood plywood is overlaid with resin-impregnated cellulose fibers . . . a specially engineered paint surface. Use it for "inside-outside" kitchens, cabinets, doors.

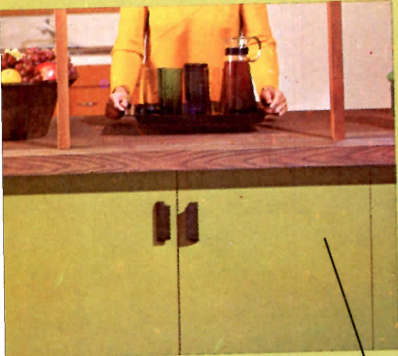

G-P Lumber Decking.

Decks sell homes. And G-P lumber decking gives your homes even more sales appeal. Choose from Western and Southern softwood species. For decks that look better, last longer, always use G-P lumber!



G-P Crescent Sawn™.

Gets the most out of redwood's natural beauty and durability. Leave it unfinished, and let it weather (gracefully). Or paint, bleach, or stain it. Rough surface holds penetrating finishes longer.

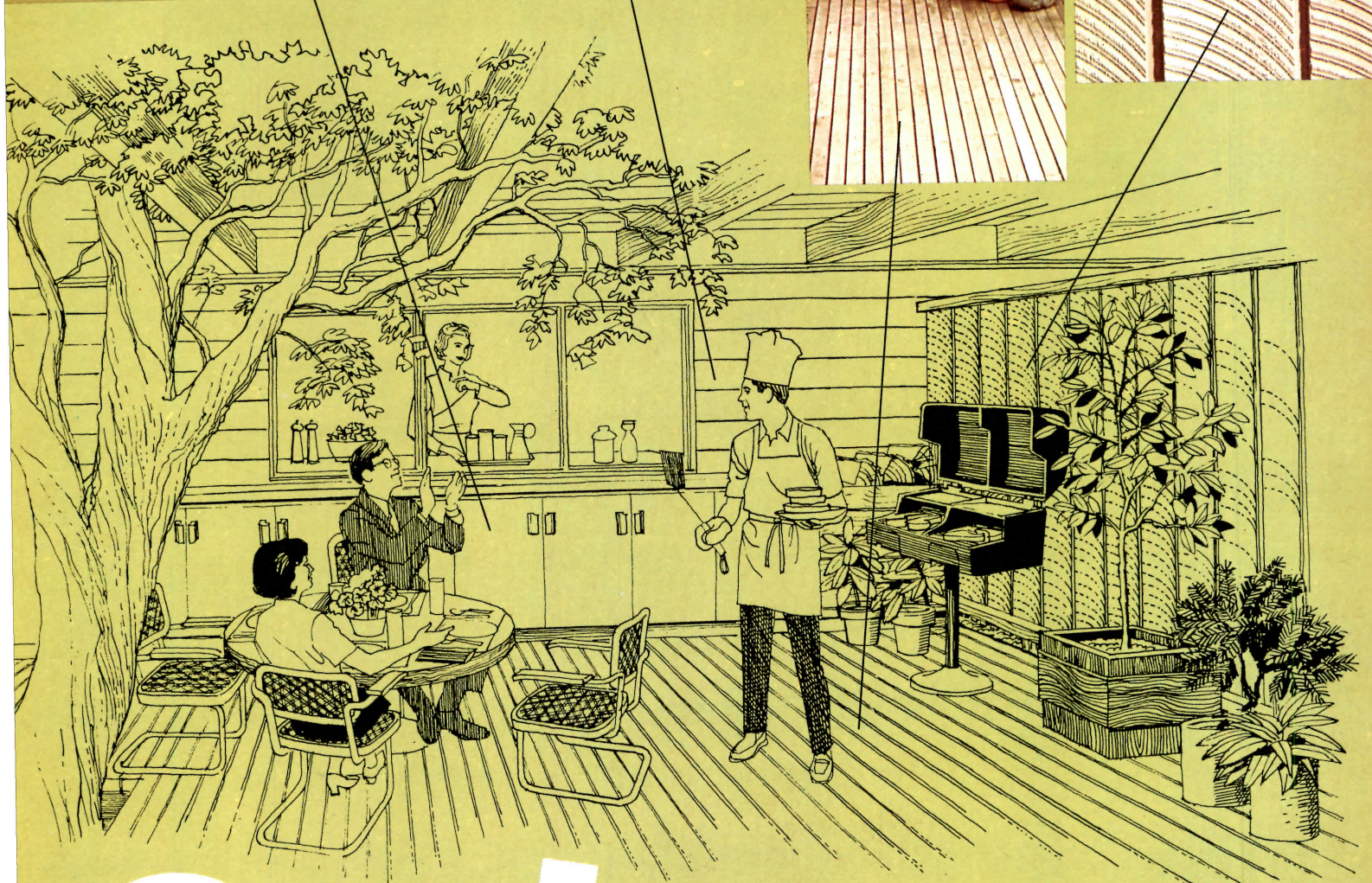
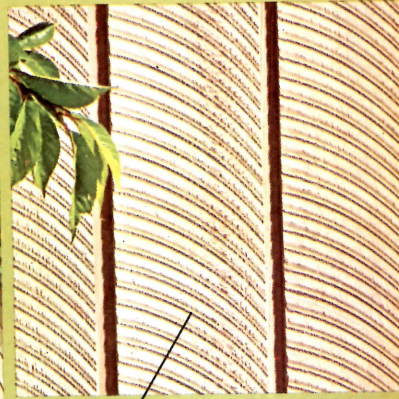

Outside!

Whatever happened to the old backyard barbecue? Grass and grill just aren't good enough any more. Now, people want decking, kitchens that serve outside as well as in, and they want privacy. G-P leisure-living products let you fill their desires. Profitably.



GEORGIA-PACIFIC
 THE GROWTH COMPANY
 PORTLAND, OREGON 97204

Levitt & Sons has a reply for its Wall Street critics

Wall Street thinks William J. Levitt made a multi-million dollar mistake by selling out to International Telephone & Telegraph Corp. last year for a mere \$92 million.

The investment analysts make this case: Today, only 10 months later, Levitt shares would be worth at least \$200 million on the open market had he not sold out.

Each share would be selling for \$100, or three times as high as last year. So by selling only 40% of the 2.4 million shares he did control, Bill Levitt would be able to more than match ITT's purchase price.

The other penalties. More important than money, the merger has cost Levitt management talent and priceless prestige.

Raiders from fast-growing building companies have lured away a dozen Levitt men with stock options that ITT could not match. The latest to go: Senior Vice President Dick Weiss (see story p. 4). Says an analyst: "A big builder who can't make his top men millionaires can't keep them."

And ITT may have lessened Levitt's image as the industry's leader by closing the company away in its corporate labyrinth.

The Levitt retort. But President Richard Wasserman of Levitt has these answers for the critics:

First, ITT provides tremendous financial resources and technological skill that Levitt could never get on its own. "It's a good merger. We have what it takes to become a worldwide building company."

Second, Wasserman concedes that Levitt



WASSERMAN **YOUNG**
Bigger than the next two big companies

lost "three or four" men it wanted to keep. "But we are coming up with a new salary package that will permit us to keep 99% of the men we want from now on." (Indeed, Levitt's former marketing expert, Dr. Norman Young, who was sought by many companies, is staying at ITT to direct a new Florida land-sales operation.)

Wasserman adds: "We could raid too. But we haven't found it necessary."

And of housing's new millionaire executives Wasserman observes:

"What happens after the guy becomes a millionaire? Does he work as hard as he did—or does he relax a little?"

And third, Wasserman is certain that Levitt & Sons' industry leadership is not slipping.

"We're still bigger than the next two guys put together [thus indicating fiscal 1969 sales of about \$160 million]."

He adds plaintively: "I have begged ITT to allow us to tell our story. Our success last year would put the industry on its ear. And in five or even 10 years we will still be way ahead of the pack."

"We are thinking of getting our second sophisticated computer. How many other homebuilders are even thinking of getting their first?"

Levitt's record. Although Wasserman did not mention it, Bill Levitt is partly responsible for the current boom in homebuilding stocks.

Starting in 1965, Levitt held a series of lunches for investment analysts to introduce Wall Street to his company, and by implication, to all well-managed homebuilders. He whetted their appetites, but only some recommended his stock. Then last year ITT confirmed his—and homebuilding's—respectability.

Many analysts began searching for a Levitt successor. And while thumping other builders' drums, they helped start today's stock boom—the same boom that Levitt is now criticized for missing.

CORRECTION

Shares of First Mortgage Investors were quoted by HOUSE & HOME in November at 24, with a change of "minus 7½" for the month. In fact, the price represented a gain of 7½. The investment trust has just reported record third-quarter earnings.

Housing stocks spurt again; look at those mobile homes

HOUSE & HOME's index of 25 building issues leaped to 375.28, from 339.66, or 10.5% for the month ended Dec. 9. The mobile homes division moved to 775.79, up 15.6%. Here's how the index looks:

HOUSE & HOME VALUE INDEX
OF 25 BUILDING STOCKS COMPOSITE

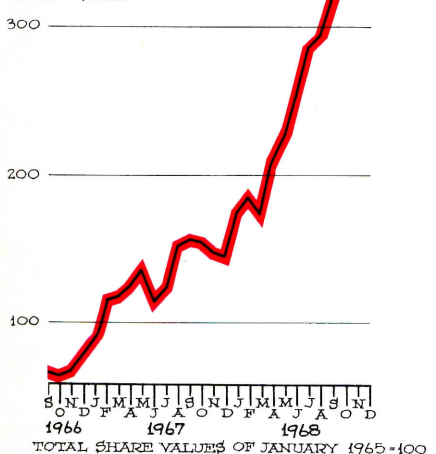

How the top five did in each category:

	Dec. '67	Nov. '68	Dec. '68
Builders	204.82	441.89	520.20
Land develop.	250.91	507.14	595.96
Mortgage cos.	214.39	489.40	480.36
Mobile homes	152.83	670.86	775.79
S&Ls	77.87	168.81	175.91

HOUSING'S STOCK PRICES

COMPANY	Dec. 9 Bid/Close	Chng. Prev. Month	COMPANY	Dec. 9 Bid/Close	Chng. Prev. Month	COMPANY	Dec. 9 Bid/Close	Chng. Prev. Month
BUILDING			Colwell	32	- 3	Forest City Entr.^b	28½	+ 4¼
Bramalea Cons. (Can.)	12	- 2½	Cont. Mtg. Investors^c	30	- 2½	Investors Funding^{a, b}	37½	+ 13%
Capital Bldg. (Can.)	6½	+ ½	Cont. Mtg. Insurance	34	+ 3	Rouse Co.	58½	+ 8½
Christiana Oil ^b	11½	+ 2½	FNMA	146	- 13	Tishman Realty^c	83¼	- 1½
Cons. Bldg. (Can.)	4.65	+ 20¢	First Mtg. Inv.	25¼	+ 2	MOBILE HOMES & PREFAB		
Dev. Corp. Amer.	8¾	+ ¾	Kissell Mtg.^b	15½	+ 1½	Con. Chem. Co.^b	27¾	+ ½
Edwards Indus.	21	+ 1½	Lomas & Net. Fin.	15	+ 1½	Champion Homes^b	47½	+ 12½
First Hartford Rlty.	16½	+ 5½	MGIC Invest. Corp.^e	49½	- 1½	Commodore Corp.^a	62	
First Nat. Rlty. ^b	13½	+ 6½	Mortg. Assoc.	23	+ 9¼	DMH (Detroit)^b	40%	+ 2%
Frouge	4¾	- ¾	Palomar Mtg.	10¾	+ 1½	Fleetwood^b	43¾	+ 7¼
General Bldrs. ^b	11½	- ¾	Southeast Mtg. Inv.	5¼	- ¼	Guerdon^b	47¾	+ 4%
Kaufman & Bd. ^b	74	+ 13½	United Imp. & Inv.^b	14%	- 2½	Monarch Ind.^a	21½	
Key Co.	21½	+ 1¼	LAND DEVELOPMENT			Redman Indus.^b	99¼	+ 14¼
(Kavanagh-Smith)			All-State Properties	2¼	+ ¼	Rex-Noreco^y	24¾	+ 8¼
National Environment (Sprout Homes)	27	+ 8	American Land	1½	+ ¾	Skyline^b	89	+ 11½
Nationwide Homes	9¼	+ 1¼	AMREP^b	41	+ 13½	Town & Country Mobile^b	44½	+ 8¼
Presidential Realty ^b	25¾	+ 2¼	Arvida	18¾	+ 1¼	Zimmer Homes^b	56½	+ 5%
Revenue Prop. (Can.)	19%	+ ¼	Atlantic Imp.	16½	- 1½	Natl. Homes A.^e	32¾	+ 8%
Ryan Homes ^a	39		Canaverl Int.^b	9½	- ½	Scholz Homes	38	+ 9½
U.S. Home & Dev.	22	+ 2½	Crawford	3½	- 1¾	Swift Industries	11	+ 1¼
Jim Walter ^e	124¾	+ 20¼	Deltona Corp.^b	52¾	+ 12½			
Del E. Webb ^e	14¾	+ 1¼	Disc Inc.	6%	+ ¾			
Western Orbis ^b	10¾	+ 1¾	Fla. Palm-Aire	19½	+ 5			
(Lou Lesser Ent.)			Garden Land	9¾	+ 1¼			
S&Ls			Gen. Devel.^e	31¾	+ 4½			
American Fin.	33	- 1	Gulf American^b	23¾	+ 3½			
Calif. Fin. ^e	11¾	- ½	Ho. y Corp.^b	6%	- ½			
Empire Fin. ^b	29½	- ½	Horizon Land	32	+ 6¼			
Equitable S&L	33¼	+ 1¼	Laguna Niguel	12	+ 3½			
Far West Fin. ^e	25½	+ 1½	Major Realty	13¼	+ 2½			
Fin. Fed. ^e	33¾	- ½	McCulloch Oil^b	40	+ 5½			
First Char. Fin. ^e	36½	+ 2	Scientific Resources	26¾	+ 4%			
First Lincoln Fin.	14½		(Sunasco)					
First Surety	10½	+ ¼	So. Rlty & Util.^b	13%	+ 1¼			
First West Fin.	7¼	+ 2½	DIVERSIFIED COMPANIES					
Gibraltar Fin. ^e	31¼	+ 1½	City Invest.^e	75¼	- 17¼			
Great West Fin. ^e	26½	+ 2	Cousins Props.	63	+ 4½			
Hawthorne Fin.	16	- 1½						
Huntington Savings (First Fin. of West)	18¾	+ 5						
Imperial Corp. ^e	15½	- ½						
Lytton Fin. ^e	10%	+ ½						
Midwestern Fin. ^b	9	+ ¾						
Trans-Cst. Inv.	6¼	+ 1¼						
Trans World Fin. ^e	19¼	- ½						
Union Fin.	19¼							
United Fin. Cal ^e	22½	+ ½						
Wesco Fin. ^e	33%	- 7%						
MORTGAGE BANKING								
Advance	23½	+ ½						
Associated Mtg.	21	- 3						
Charter Corp. of Fla.	57	+ 15						

SHORT-TERM BUSINESS LOAN RATES

Average % per year	7 other North-eastern	8 North Central cities	7 South-eastern cities	8 South-western cities	4 West Coast cities
LOAN SIZE (000)	N.Y. City				
\$1-9	7.30	7.49	7.35	7.09	7.20
10-99	7.14	7.48	7.34	6.96	7.08
100-499	6.87	7.28	7.21	6.78	6.91
500-999	6.69	7.14	7.08	6.61	6.78
1,000 up	6.60	6.83	6.78	6.54	6.74

August rates in Federal Res. Bulletin, Oct. 68.

NEWS continued on p. 12



We've got some new bright ideas

...209, to be exact. All for you in '6

More than 200 new, glamorous and exciting fixtures, all featuring exclusive Lightcraft of California styling, production techniques and quality . . . priced to match every budget . . . very modest or expansive . . . and all available in a full range of the latest, most popular decorator styles, finishes, wood-grains and colors. Chandeliers, swags, brackets, bathroom and outdoor fixtures . . . all new . . . all in production!

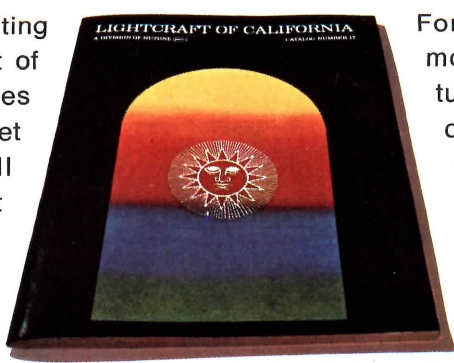

For a closer look at the complete line of more than 800 glamorous Lightcraft fixtures, write for our beautiful, all new full color catalog. (For a preview sampling of our new line, visit us at booth 2330 at the NAHB Show). Send today for your FREE COPY. Lightcraft of California, Department HH-1-L, Madison and Red Bank Roads, Cincinnati, Ohio 45227. NuTone division **SCOVILL**

LIGHTCRAFT OF CALIFORNIA

The ordinary driveway is out.

The Approach does what no ordinary old driveway ever did for you.

Helps you attract customers.

Helps you sell them.

First because it's beautiful.

Second because it makes sense.

The right Approach provides ample off-street parking for visitors and for the extra cars in a family.

The ordinary driveway chokes on one extra car.

The right Approach ties in with a weather-protected entry for guests and for unloading packages from the car.

The ordinary driveway doesn't tie in with weather protection.

The right Approach can also provide privacy with privacy screens, decorative planting areas... all the little touches that add good looking, good living to your homes.

The ordinary driveway? It just lies there.

Put Approaches in your models and in your package, priced at a profit.

They're already making a lot of builders more money.

Our book, "Grounds For Good Living", will give you plenty of ideas and show you how it's done.

Introducing The Approach.



The old back yard is dead.

The plain, old back yard never sold house one.

The Setting sets up sales.

Also extra profits.

Rule number I for a Setting is . . .

“Thou Shalt Not Build A Teeny Patio”

Build it big enough so that when your customers entertain their friends and neighbors, they can move around without stumbling over each other.

Minimum is 400 square feet.

Rule number II is, “Thou Shalt Offer Enough Options To Give Customers What They Want”.

Does a family like to play games?

Offer a multi-game court.

Like to relax? Water falling into a pond is cool and restful.

Like to swim? The new concrete pools cost less than you think.

Like to garden? The right setting creates dramatic, easy-to-maintain planting areas.

Great ideas for all these things—and more—are offered in our book, “Grounds For Good Living”.

Put Settings in your models. Price them into your package at a profit.

That way they not only help you sell, they make more money for you.

Introducing The Setting.



New book, “Grounds For Good Living”, contains more than 100 beautiful, useful Approach and Setting Ideas, illustrated in rich color. Includes 23 plans, valuable planning and how to do it information. Regularly \$1.25, **FREE to builders.** Order today; limited number of copies available.

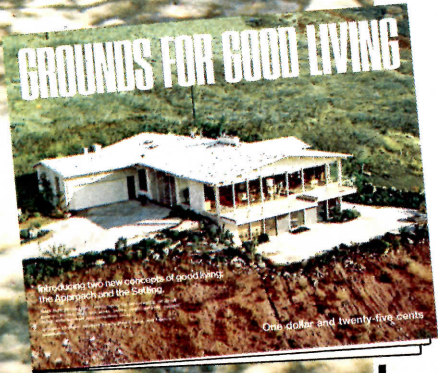

FREE TO BUILDERS ONLY WITH THIS COUPON!
\$1.25 BOOK, “GROUNDS FOR GOOD LIVING”

Portland Cement Association
 Dept. A1-94, Old Orchard Road, Skokie, Ill. 60076
 Please send my \$1.25 copy of “Grounds For Good Living” free.

Name _____
 Title _____
 Firm Name _____
 Address _____
 City _____ State _____ Zip _____



PCA is an organization of cement manufacturers to improve and extend the uses of portland cement and concrete.

Strongsville, Chapter 2: Bomb rips a Bob Schmitt house

The dynamite blast destroyed the interior of an unoccupied house in builder Robert Schmitt's Strongsville, Ohio, subdivision.

No one was injured.

For a year the Cleveland suburb has teetered on outright violence as building trade unions attempted to organize Schmitt and residents fought to recall Mayor William Behr, a union favorite (NEWS, Dec. '68).*

"We had everything but violence," says City Council President Dale Finley. "Now we have that too. I fear that this bombing will not be the last of it."

The bombing. After dark on November 25, an intruder pried open the front door of the house, placed several sticks of dynamite in the second floor hall and lit a fuse.

The dynamite exploded at 8:40 p.m., minutes after a night watchman had checked the vacant house.

The blast caused \$25,000 worth of interior damage. But it did not mar the structure or exterior. Says Schmitt:

"A conventionally built house would have been in a heap. We glue all skins—the walls, subflooring and ceilings—to their framing members, thus creating an extra-strong monolithic box."

Police work. State, county and local lawmen are investigating whether building trade craftsmen, who have been picketing Schmitt's nonunion operation for 14 months, are involved. But the lawmen have apparently run into a stone wall. The local policeman in charge, Capt. Edward Szoke, has been on vacation, on and off, since the bombing probe began.

Cleveland agents of the Federal Bureau of Investigation filed a preliminary report with the Justice Department in Washington, D.C. Justice must decide now whether the FBI has jurisdiction to step in. (For example, if the dynamite used was transported across state lines, the FBI could take over the inquiry.)

Cleveland, a strong union area, has a history of bombings, but a dearth of convictions.

Builder reaction. Nathaniel Rogg, NAHB's executive director, has urged the Justice Department to accept the case "for the good of Bob Schmitt and for all home-builders."

And the Builders Assn. of Greater Cleveland has offered a \$1,000 reward for information leading to the bomber's conviction. The local group released a blunt statement saying in part:

"Planned, malicious destruction of this nature is . . . an affront to the entire industry. It will not be tolerated."

Who did it? Schmitt says he does not know who may have planted the dynamite. But he adds:

"I don't bow to these tactics. They can blow the whole thing up, and I still will not run away."

Schmitt fears that someone may next try to "get me". He says, "I am being very

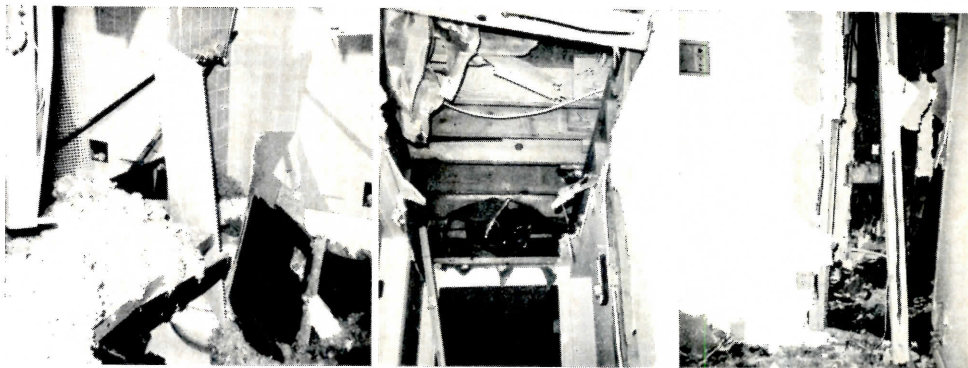

BOMB BLAST at a Bob Schmitt house dislodged bathroom light fixtures and insulation, ripped away hall ceiling and smashed an interior wall. The house was sold, but the buyers had not yet moved in.

careful about where I go, especially at night."

Says Carpenters District Vice President Robert Lavery, who has filed a series of fruitless law suits to stop Schmitt's project:

"My union had nothing to do with the bombing. I will take any lie detector test, even truth serum, to clear my name and the name of my union.

"I have suspicions that they did it."

He did not identify "they."

Despite his willingness to talk, by mid-December local police had not questioned Lavery.

Lavery and his family, who live in Strongsville, received numerous threats throughout 1968.

Mayor Behr, who had strong union support during the recall campaign, has requested tighter police surveillance of his home. Before the bombing, someone sprayed his house with paint and fled unnoticed.

The mayor says: "The obvious suspect in the Schmitt bombing is the union. But if it were union men, why wouldn't they have tried to hurt Schmitt directly by bombing his office or his on-site building factory? Schmitt didn't own the bombed house. He had already sold it."

In fact, Schmitt still owned the house; the title had not been transferred. The builder's crews are rebuilding the interior at no cost to the buyer.

Sales continue. At first, Schmitt believed the bombing would scare all his customers away from his \$30 million planned unit development. But buyers are still coming. Schmitt says, "Some of them are indignant about what has happened."

Also, the 100 families already living in Schmitt's project are standing by him. "None of us is moving away," says Mrs. Dorothy Sivewright. "We are more determined to stay than ever before."

Other builder violence. The Schmitt bombing is reminiscent of the five-month burst of violence that rocked Ryan Homes in Pittsburgh eight years ago.

As in Schmitt's case, violence erupted while Edward Ryan and his two brothers were being picketed by union craftsmen who wanted to organize the company.

One Ryan home was bombed; another was burned to the ground; paint bombs disfigured kitchens in 55 houses during a 20-

day period and several subcontractors working in Ryan houses were beaten by outsiders.

Jim Ryan, who now runs his own company, was pushed and punched to the ground by strangers. And brother Bill, then company president, was dragged from a car in daylight and beaten until he could not stand.

Under a technicality of labor law, the Ryan brothers won a court ruling that prevented further union picketing. Shortly afterward, the violence stopped.

Ryan Homes, now publicly held, is still a nonunion company. —F.L.

Trade group, suppliers fined in plumbing price-fix case

Federal Judge Louis Rosenberg of Pittsburgh has ordered a series of fines and jail terms for companies and executives allegedly involved in a \$1 billion price-fix conspiracy.

The judge fined these trade associations and suppliers \$50,000 each: the Plumbing Fixtures Manufacturers Assn.; Wallace-Murray Corp.; Rheem Manufacturing Corp. and Universal-Rundle Corp. He fined the Briggs Manufacturing Co. \$10,000.

He also ordered jail terms and fines for five present and former executives of Wallace-Murray, Borg-Warner, Universal-Rundle, the Crane Co. and Rheem.

All defendants pleaded no contest, accepting penalties without admitting guilt.

The trial of six other corporate and individual defendants has been postponed until after January 1. Those defendants, who all pleaded not guilty, include American-Standard Inc.; Borg-Warner; the Kohler Co. and its vice president, Norman Held; Joseph J. Decker of American-Standard and Daniel Quinn, a retired American-Standard vice president. Their lawyers said they needed more time to prepare their case in the light of Judge Rosenberg's decision to accept the no-contest plea from the other defendants.

All defendants were indicted by a federal grand jury in October, 1966, on charges of conspiracy to fix the price of enameled cast-iron plumbing fixtures, mainly bathtubs, from 1962 to 1966.

NEWS continued on p. 18

* Behr was recalled Nov. 5. He left office Dec. 20 when his suit failed to invalidate the vote.

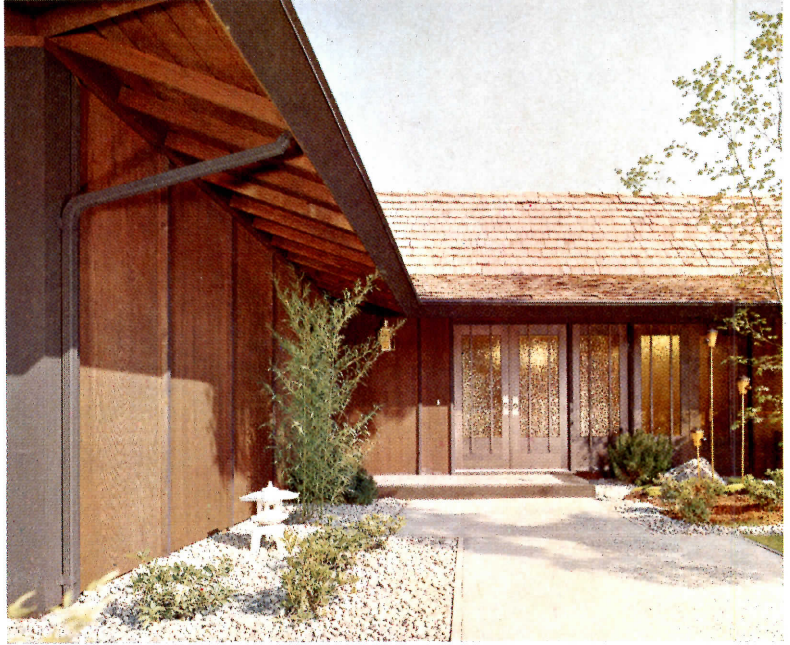

THE MANY FACES OF PALCO REDWOOD PLYWOOD

Combine the Beauty of Redwood with the Advantages of Plywood

And help you build in the sales appeal of quality—outside, inside, or both.

Available with faces that are clear—knot free—and without conspicuous patches.

Redwood has long been known for its superior ability to hold finishes. Now, we've added saw-texturing to further increase this ability. Result: PALCO redwood plywood holds finishes up to twice as long as other smooth surfaces. Or, may be used in its natural color; or leave it unfinished—it will weather beautifully.

Available in 3/8" & 5/8" thicknesses—8', 9' & 10' lengths, and in a variety of patterns.

Choose from the many faces of PALCO redwood plywood for the beauty and quality of redwood plus the economies of panel construction.

Write us for color brochure that describes application and various finishing recommendations.



PALCO

Architectural Quality Redwood

THE PACIFIC LUMBER COMPANY

1111 Columbus Avenue, San Francisco 94133 • 35 E. Wacker Drive, Chicago 60601
2540 Huntington Drive, San Marino, California 91108

*This announcement is neither an offer to sell nor a solicitation of an offer to buy these securities.
The offer is made only by the Prospectus.*

A NEW ISSUE

November 26, 1968

General Mortgage Investments

1,000,000 SHARES OF BENEFICIAL INTEREST

(Par Value \$1 Per Share)

Price \$15.00 per share

Copies of the Prospectus may be obtained from such of the undersigned (who are among the underwriters named in the Prospectus) as may legally offer these securities under applicable state securities laws.

This announcement is neither an offer to sell nor solicitation of an offer to buy these securities. No offering is made except by a Prospectus filed with the Department of Law of the State of New York and the Bureau of Securities, Department of Law and Public Safety of the State of New Jersey. Neither the Attorney General of the State of New York nor the Bureau of Securities of the State of New Jersey has passed on, or endorsed the merits of this offering.

Hayden, Miller & Co.

Stein Bros. & Boyce, Inc.

Drexel-Harriman-Ripley
Incorporated

Stone & Webster Securities Corporation

Bache & Co.
Incorporated

Bear, Stearns & Co.

Alex. Brown & Sons

Burnham and Company

Clark, Dodge & Co.
Incorporated

Dominick & Dominick,
Incorporated

R. W. Pressprich & Co.
Incorporated

New York Securities Co.

Arthurs, Lestrangle & Co.

Baker, Watts & Co.

Ball, Burge & Kraus

Bateman Eichler, Hill Richards
Incorporated

D. H. Blair & Company

Boettcher and Company

J. C. Bradford & Co.
Incorporated

Dain, Kalman & Quail
Incorporated

A. G. Edwards & Sons, Inc.

Eppler, Guerin & Turner, Inc.

First of Michigan Corporation

Robert Garrett & Sons, Inc.

Halle & Stieglitz

H. Hentz & Co.

J. J. B. Hilliard, W. L. Lyons & Co.

Hirsch & Co.
Incorporated

Howard, Weil, Labouisse, Friedrichs and Company

Johnston, Lemon & Co.

Kohlmeyer & Co.

Legg & Co.

Loewi & Co.
Incorporated

McCormick & Co., Inc.

McDonald & Company

The Milwaukee Company

Mitchum, Jones & Templeton
Incorporated

The Ohio Company

Piper, Jaffray & Hopwood

Prescott, Merrill, Turben & Co.

Putnam, Coffin & Burr-Doolittle, Inc.
Affiliate of Advest Co.

Rauscher Pierce & Co., Inc.

Watling, Lerchen & Co.

Saunders, Stiver & Co.

Abbott, Proctor & Paine

Birr, Wilson & Co., Inc.

George D. B. Bonbright & Co.

The First Columbus Corporation

First Nebraska Securities Corp.

Joseph, Mellen & Miller, Inc.

Laird, Bissell & Meeds, Inc.

Manley, Bennett, McDonald & Co.

Murch & Co., Inc.

Powell, Kistler & Co.

Rotan, Mosle-Dallas Union, Inc.

Wagenseller & Durst, Inc.

Winslow, Cohu & Stetson
Incorporated

Almstedt Brothers

Julien Collins & Company

Mackall & Coe A. E. Masten & Co.

Moore, Leonard & Lynch
Incorporated

Newburger & Co. Roberts, Scott & Co., Inc.

J. N. Russell & Co., Inc.

Stern, Frank, Meyer & Fox
Incorporated

Stifel, Nicolaus & Company
Incorporated

Suplee, Mosley, Close & Kerner
Incorporated

Vercoe & Co.



Builder: Cooper Construction Co., Minneapolis, Minn.

Windows for showplaces

Windows with a "showplace" look come from Marvin. Marvin is different. We do things that other manufacturers *won't* do to make beautiful wood windows easier to get, easier to install, and easier to use in beautiful, out-of-the-ordinary ways. For instance, we offer the most styles, sizes, and options of any manufacturer, and deliver them set up to local jobbers *within 10 days of order*. Call or write us and we'll tell you some other things you need to know about windows for showplaces.

FREE! Send for our colorful new literature and learn the Marvin secrets that help you use wood windows in beautiful ways — that sell showplaces.

Wonderful Windows of Wood by MARVIN
 MARVIN WINDOWS CONDENSED CATALOG
 MARVIN WINDOWS
 "BUILT FOR NORTHERN WINTERS AND SOUTHERN CHARM"

MARVIN WINDOWS • WARROAD, MINN. 56763 • (218) 386-1430



Sell the fashionable homemaker

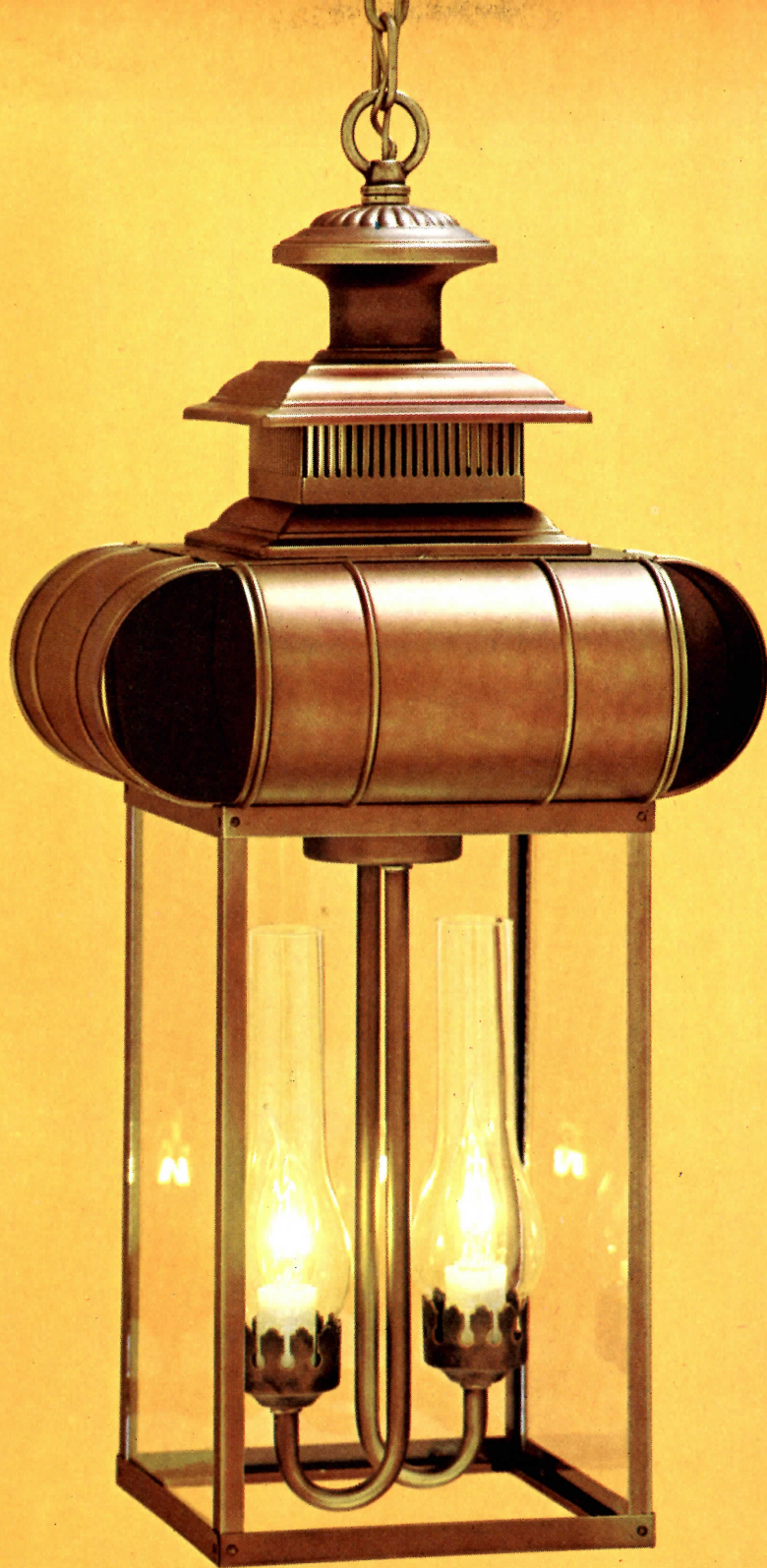

with the authentic look of Moe Light.

You can't fool her. She knows when styling is authentic. And she'll decide whether to take a second look at your model homes. So give her something special to remember: a rugged English coach lantern in solid brass with twin, glass chimneys.

For more ideas, send for your free copy of the 124-page Moe Light style book. Write: Residential Lighting Division, Thomas Industries Inc., 207 East Broadway, Louisville, Kentucky 40202. See the entire line of Thomas products at the Thomas Industries National Lighting Center in Chicago, or at your local lighting center displaying the Thomas lantern sign.



THOMAS
INDUSTRIES

Legal rent strikes help Washington force code crackdown on landlords

The nation's capital has begun a building code crackdown that is shattering the traditional landlord-tenant relationship.

The landlords and operators of Washington's myriad substandard apartments and houses are caught in a three-way squeeze.

- The city has stopped automatically renewing operator licenses. Landlords must first prove that their dwellings are free of code violations. So far two landlords, Dino Formant and his wife, have been convicted of criminal charges of operating dwellings without a license.

- The District Court of Appeals has ruled apartment leases invalid if the landlord knew code violations existed when the tenant signed the lease. Result: The landlord can not evict for nonpayment of rent.

- And armed with favorable decisions, tenants have organized at least seven rent strikes. Already one landlord, Robert O. Farmer of Arlington, Va., claims that a rent strike forced him into bankruptcy.

Many of the dwellings are not slums. They are often less than 25 years old and border on middle-class standards.

Landmark decision. The city's landlords vow to fight the Appeals Court's decision to the U.S. Supreme Court, if necessary. Meantime, they seem to face a long, hard winter.

In the first practical test of the appellate decision last month, the city's landlord and tenant court prevented a tenant's eviction for nonpayment of rent.

One of the city's largest owners of low-income property, Diamond Housing Corp., would ordinarily have had no trouble evicting a young welfare mother of three who was in arrears. But the woman, represented by an anti-poverty agency lawyer, introduced evidence that code violations existed when she signed the lease.

The court refused to order eviction, thus leaving the landlord unable to collect rent on an invalid lease. The tribunal rejected



THIS RENT-STUCK APARTMENT in the nation's capital was constructed less than 20 years ago.

the landlord's counterclaim that the woman's presence in the house without a legal lease amounted to trespassing.

Landlord's response. The landlords are not taking all this without a fight.

Some represented by veteran lawyer Herman Miller have renewed their common complaint that the tenants abuse the apartments, making it impossible to keep them free of building-code violations.

Others have also raised the specter of property desertion. There is some evidence that this has begun. Landlord Farmer, who filed for bankruptcy, says his banks refused to foreclose on his dwellings.

Some landlords suspect that city officials, particularly License Director Julian Dugas, enacted the new license-renewal policy to force them to sell out to politically influential nonprofit housing groups at a loss.

On the other hand, spokesmen for some tenant groups are skeptical that Dugas will continue vigorous enforcement of the license policy.

—THOMAS LIPPMAN
Washington

A lender can be held liable for faulty house

California's Supreme Court has extended the range of liability for unsound houses from the builder to the lending institution that financed the construction.

The state's highest court has just upheld a suit by 43 homeowners against Great Western S&L of Los Angeles (NEWS, Dec. '67).

In 1959, Great Western lent \$3 million for a 250-house tract built by the Conejo Valley Development Co. (Keith Brown and the late Harris Goldberg) in Ventura County. Some of the \$15,000 slab houses, built on expansive soil, developed such defects as cracked foundations.

The court did not rule that Great Western was responsible for financing defective houses. The ruling merely settled the legal question of whether homeowners can sue a lender in such a liability case. A trial jury

It is unlikely that the case, which lacks a clear constitutional question, will result in an appeal.

will determine whether Great Western is in fact responsible for any structural defects.

Irving Shimer, attorney for Great Western in Los Angeles, could not be reached immediately for comment.

Some savings and loan executives have contended that a liability ruling against the lender would increase new-house costs by 5%. They reason that lenders will raise fees after hiring new site-inspection teams to insure sound construction.

In the arguments before the Supreme Court last spring, Great Western was supported by the California Bankers Assn., the California S&L League and the California Home Builders Assn.

NEWS continued on p. 20



For help to build it better... call Westinghouse

ATLANTIC REGION

Philadelphia 215-878-1477
Baltimore 301-828-4215
Washington 202-628-1313

NORTHEAST REGION

New York 212-692-7767
Boston 617-542-2318
Buffalo 716-854-4259

SOUTHEAST REGION

Atlanta 404-351-1280
Charlotte 704-377-3471
Chattanooga 615-267-2270
New Orleans 504-486-5328
Miami 305-634-3289

CENTRAL REGION

Pittsburgh 412-255-4544
Cincinnati 513-475-7240
Cleveland 216-241-2168
Detroit 313-872-7010

MIDWEST REGION

Chicago 312-461-7115
Indianapolis 317-632-3287
Minneapolis 612-927-2240

SOUTHWEST REGION

Dallas 214-631-2204
Houston 713-224-1319
Memphis 901-526-2210

PACIFIC COAST REGION

San Francisco 415-392-5218
Los Angeles 213-482-1265
Phoenix 602-258-7211
Seattle 206-623-3322



Stylish, versatile switches and receptacles



Slim-wall frost-free refrigerators



Hi/Re/Li® heat pumps, total comfort systems



Built-in dishwashers with filter-clean washing



Micarta counter tops for lasting beauty



Spacesaving stacked washer and dryer



Standard cabinets with custom features



Ranges, platforms, ovens; self-cleaning, too



Individual room heating and cooling

There's a better way to build...with Westinghouse

Fact: Westinghouse makes more products and systems for construction, offers more services, than any other company in the world.

Everything electrical, of course. Also everything to heat, cool, clean and move air.

All major appliances. Cabinets,

Micarta counter tops and wall surfaces for work-free interiors.

Plus vertical and horizontal transportation. And electrical distribution equipment and lighting.

Westinghouse also provides computerized electrical and mechanical systems studies.

If you want this kind of help, call your local Westinghouse construction representative. His phone number's on the opposite page.

J-94305

You can be sure... if it's Westinghouse



Circle 58 on Reader Service card

Romney's team: Romney for businesslike management at HUD...

George Wilcken Romney is a man of high administrative talent and wide zeal.

He will need both qualities to get his Department of Housing and Urban Development moving.

President-elect Nixon wanted an administrator in HUD—"a big department that spends a lot of money." Michigan's Gov. Romney fills the bill.

Twice the 61-year-old businessman turned public servant has proved that he is a superb manager. He rescued American Motors from the "gas-guzzling dinosaurs" of the Big Three. And he wrested control of his home state from the Democrats and put some backbone in its flaccid economy. He won re-election twice, by increasing margins.

The challenge. One housing observer said: "He has run a state for six years. He ought to be able to run a department."

Easier said than done. At age 2, HUD is a nightmare of unrealized potential and untried programs. It is already slipping behind its recently announced goal of producing 26 million units within 10 years.

Initially, at least, Romney's job will be to hammer the best of the old and new programs into a set of working tools.

"We have good programs," says Graham Northrup, legislative director for the Mortgage Bankers Assn. "Now we need someone who can make them work."

In his new task, which will require close White House coordination, Romney stands to have decided advantages over predecessor Robert Weaver.

In addition to his long management experience, Romney will have the ear of his President. It is expected that the President will always listen carefully to the former Presidential aspirant who has enjoyed prestige among Republican party leaders and in the nation as a whole.



HUD'S ROMNEY
With Nixon adviser Herb Klein

Builders' approval. The homebuilding industry had clamored for a man with building experience. Romney lacks that, unless one counts his stint many years ago as a carpenter's helper.

But housing sources, immediately after his appointment, stressed Romney's "missionary zeal" and concern for urban problems.

Said Democrat Eli Broad: "Romney, the executive, will make a fine secretary. As a businessman, he will understand what motivates a builder to get the job done—things like profit, for example."

Eugene Gullledge, NAHB's incoming president adds: "Gov. Romney is a take-charge man."

Romney's background and statements indicate where he stands on three questions:

1. **Big business.** He's for it. He had rapport with Michigan's business establishment—which stood by him during his six years as Governor. So he is likely to turn to business to get things done. And he will probably assure business has a profit incentive.

Romney may be less inclined to be Big Labor's friend. During his Presidential campaign last year, he was very nearly antagonistic. He called for federal laws to curb

collective bargaining, the process that made labor big.

2. **Community programs.** Romney and the new administration will probably continue the trend, begun by HUD, to shy from the community participation that has produced debate but no housing.

Yet President-elect Nixon has asked Romney to mobilize voluntary agencies for work in the cities. These would range from non-profit corporations down to housewife groups that would offer family counseling to the poor.

3. **Civil rights.** Romney is an enigma. He is a strong spokesman for civil rights with a spotty record of accomplishment.

For example, he urged passage of an open housing law in Michigan in 1967 but then left the state during the critical days before the vote. The law was defeated by a scant 56 votes.

He later returned and shepherded the bill to passage.

Romney has other strikes against him. He is a Mormon, a religion that historically has provided secondary roles for its Negro members. And as the second HUD Secretary he replaces the nation's only Negro cabinet member (even though Weaver was not widely popular among today's new black leaders).

Romney faced the racial issue in his Presidential campaign—directly—by going into Negro areas to exchange ideas. Although his self-improvement sermons were often rebuffed, he kept going back.

The integrated National Assn. Against Discrimination in Housing welcomed Romney, and its words struck this hopeful note:

"We hope and trust that the Governor's efforts for equal rights in housing will be greatly expanded in Washington."

—ANDY MANDALA
Washington

...and Moynihan with bright new ideas for President's ear

Daniel Patrick Moynihan, the outspoken liberal who became anathema to professional liberals after his bleak report on the Negro family in 1965, heads a new supra-cabinet agency called the Council on Urban Affairs.

"The White House agitator and the spark-plug of ideas," *The New York Times* called him. "He demolishes liberal and conservative stand-patters with cheerful impartiality."

The President-elect himself made it clear that he and his new brain-truster did not agree on everything. And Moynihan at 41, a gray-haired Democrat of considerable Irish wit, was quick to agree to disagree: "Presidents don't need advisers who agree with them on everything."

Voice in White House. The President's appointment of Moynihan proves that he wants to listen. And that is supremely important for housing, for Moynihan gives homebuilding and urban affairs a strong and original voice inside the White House. This

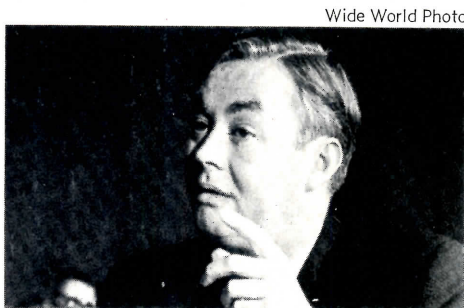

URBAN COUNCIL'S MOYNIHAN
"Presidents don't need advisers who agree"

is not to suggest that Housing Secretary George Romney will not enjoy full access (see story above). He will. But the big decisions on housing—and everything else—will be made at the White House.

Top priority. The appointment of the council signals the tremendous importance the Nixon administration accords the crisis of the cities. The new domestic agency

ranks on a par with the prestigious National Security Council, which sets defense policy.

Moynihan's council will consolidate urban programs that now overlap several agencies. And it will serve as an incubator for new approaches to the whole urban crisis and its ancillary problems of housing, race and crime.

Personnel. The council will include the Secretaries of Housing and Transportation, along with the highly influential Nixon confidant Robert H. Finch, the new Secretary of Health, Education and Welfare. The Secretaries of Labor, Commerce and Agriculture will sit in on occasional sessions.

Another White House appointee will also be involved in this attack on urban problems. Martin Anderson, 42, the Columbia professor and author of "*The Federal Bulldozer*," the stinging attack on the old urban-renewal program, has been named a special assistant to the President to develop programs and policies.

—A.M.

NEWS continued on p. 22

What if you could have an oven that cleans itself faster, better, more economically? Westinghouse.



But don't take our word for it: Compare.

The self-cleaning feature of this new Westinghouse 25-inch built-in electric oven is reason enough to install it in your kitchens.

But we didn't stop there. Far from it.

We also included an automatic timing center, an automatic Roast Guard, a look-in oven window and reversible oven racks for any-rack baking.

And you can make things even more exciting with these appealing options: No Turn Speed-Broil® unit, flavor-seal broiling that broils both sides at once to seal in juices and flavor; and an automatic rotisserie for more versatile cooking.

Exceptionally good-looking, too, in avocado, coppertone, goldtone or white. Ask for models OK25DH and OK25GH...available April 1969.

If you're offering a quality house or apartment, feature a quality oven.

You can be sure...if it's Westinghouse.

To help you build it better...sales-clinching appliances 

Douglas Commission: Put housing on the front burner

After almost two years of hearings and study, the National Commission on Urban Problems has filed a 1,500-page report to Congress which indicates only too plainly that the sound and fury about low-income housing in recent years has been just that—sound and fury, but very little housing.

Created by the Housing Act of 1965, and chaired by former Illinois Senator Paul Douglas, the Commission* got under way in February 1967, held hearings and looked at slum conditions in two dozen cities across the U.S. Says the report's introduction, "The civil disorders of the hot summer of 1967 followed us and preceded us. We saw the ugly burned out streets that were still smoldering in some cities and we sensed the tension in communities that would erupt not too long after our being there."

The Commission heard literally hundreds of witnesses and read dozens of monographs on every facet of zoning, codes, taxation, and development standards, plus the effects of those things on the quality of life and environment in low-income areas.

The report's introduction is effectively summarized in its table of contents; in effect, a summary of a summary.

Major points in that table are:

- Our big cities are hard-up, costs of local government are skyrocketing, and political representation for the poor in slums is almost non-existent.

- Coping with metropolitan area problems is incredibly complex because of the proliferation of local governments, all with differing viewpoints, within those areas.

- Poor nonwhites who have big families and are renters are most likely to live in substandard housing. But they are not alone. A third of our affluent nation—white and black—cannot afford adequate, non-subsidized housing today.

- Accomplishments in subsidized housing have been extremely inadequate. In 30 years of public housing, the nation built fewer units than Congress, back in 1949, said were needed in the immediate next six years.

- Zoning was intended to control land development, but fiscal considerations often distort it, leading to economic and racial exclusion.

- Building code jurisdictions are thousands of little kingdoms, each having its own way: what goes in one town, won't go in another—for no good reason.

- We must develop a new system for codes and standards to free the building industry, manufacturers, planners and the public from a maze of restrictions.

- No broad attack on housing problems can ignore the sticky, myth-ridden issue of restrictive practices. Needed: more labor efficiency coupled with job security.

- To do something about the urban crisis, as political commitment grows, we can start getting the rules changed: revenue sharing, property tax modernization, federal income tax revision. Tax incentives are not an efficient means to solve slum problems.

National Publishing Co.



URBAN COMMISSION'S DOUGLAS

A question of commitment

- The states are close enough to the people and yet enough removed from petty local interests to become major constructive forces in dealing with urban problems.

- The solutions we call for are a tall order, but they are in proportion to the enormity of our urban problems.

At the heart of the Commission's almost-150 recommendations is the realization that a) improving the environment will cost a lot of money; b) as a nation we can easily afford it, it's only a matter of priorities, and c) rearranging those priorities is simply a matter of political commitment.

To quote again from the introduction: "Within a matter of hours after the publication of this report, the Commission's members—businessmen, builders, architects, lawyers, educators, and public officials—are likely to stand accused of asking for a program that costs more money. If so, we plead guilty. But the 'defense' has one question to put to the 'prosecution.' Can we afford not to undertake these programs?"

"What will be the consequences if we permit present trends and policies to continue? One indirect answer is to count the costs we are paying now for the present state of affairs. A riot, for instance, may be accepted as a symptom of a problem, whether it occurs in a ghetto or around the administrative buildings of a university. In the two weeks following the death of the Rev. Martin Luther King, the nation sustained many millions of dollars worth of insured property damage alone, not including the lost taxes on the burned and looted property. Nor does this include the loss of future sales because of fearful shoppers, of lost tourist revenue, of increased crime and arson, of higher costs of policy and fire protection, of jobs lost, and most importantly, of lives lost.

"A riot is only the top of the mercury, as it climbs past the fever line. The disease may be systemic, or it may be only a one-day inflammation. No one, however, is betting on the latter.

"The very idea of measuring the economic benefit of some programs against others, in the intangible area of 'human

investment', tends to stump those who try it. What does it cost and what are the benefits if society provides a college education for the brightest high school graduates? Taking one program at a time, if opportunities are opened up, convincing studies can show the economic payoff of a good education, on-the-job training, or vocational rehabilitation in terms of lifetime income, and the taxes paid over the working life of adults who have or who lack various types of education.

"What cannot be costed out are the myriad returns in dollars and cents as well as intangibles to a city that is relatively free of slums, that does not wall up its minority citizens in a ghetto, that has the economic health to be able to respond to the needs of its residents. We have to approach it from the other side, and count the cost of present inaction. The President's Crime Commission studies indicated that in one year, 1965, \$300 million worth of property was destroyed by arson and vandalism; that 'index crimes' (robbery, burglary, larceny, and auto theft) were double that figure, and that the cost of public law enforcement (including punishment) added \$4.2 billion.

"A growing chorus of responsible, informed voices urges a change in policy. The programs this Commission advocates are not all-inclusive but are necessary companions to others, forming part of a web of actions to speed change in our urban areas.

"However, the simple truth is that the Congress, the Administration, state and local governments, and the general public have not yet had a sufficiently combined commitment to improve our cities. HUD appropriations for housing and community development in 1969 will not reach \$3 billion, but money for defense and space will top \$79 billion. Congress has no trouble authorizing \$2 billion for an airplane that cannot land on any public airfield in the U.S., but recently the House chopped off 30 percent of HUD's meager programs, killed rent-supplement appropriations for the year, and came within 20 votes of wiping out the Model Cities program. The House Appropriation Committee this year cut the money allocated for Model Cities and funds to provide essential social services in public housing. The point is that we now have the legislation and the programs to do the job. It is now a question of commitment."

* Commission members: David L. Baker, County Manager, Orange County, Calif.; Hugo Black Jr., Attorney, Miami; Lewis Davis, Architect, New York City; John DeGrove, Professor of Political Science, Florida Atlantic University; Anthony Downs, Consultant, Chicago; Ezra Ehrenkrantz, Architect, San Francisco; Alex Feinberg, Developer, New Jersey; Jeh Vincent Johnson, Architect, New York; John Lyons, General President, International Association of Bridge, Structural and Ornamental Iron Workers; Richard W. O'Neill, Editor, HOUSE & HOME; Richard Ravitch, Vice President, HRH Construction Corp., New York; Carl Sanders, former Governor of Georgia; Chloethiel W. Smith, Architect, Washington, D.C.; Tom J. Vandergriff, Mayor of Arlington, Texas; Coleman Woodbury, Professor of Urban & Regional Planning, University of Wisconsin; Howard E. Shuman, Executive Director of the Commission.

NEWS continued on p. 24



A project cabinet that doesn't look like a project cabinet.

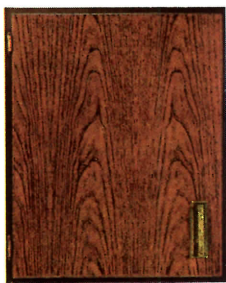

With the introduction of Town House by I-XL, you no longer have to be satisfied with slap-dash project cabinets. Town House adds the quality touch to kitchens that says only the nicest things about your construction. Women love the luxurious appearance of the rich, walnut wood grain in durable, easy-to-care-for Micarta.[®] And, they appreciate the outstanding I-XL features that are so unusual in low-cost cabinets—designed especially for project homes and apartments.

Only Town House offers you these custom advantages in project cabinets: Cabinet doors and drawer faces are high pressure laminate—finished on both sides • Self-closing door hinges that allow for simple door alignment adjustment. (A quarter-turn of two screws does it.) • Nylon glides for easy drawer operation • 24" deep base cabinets • Wide selection of sizes • Wall cabinets, up to 42" wide, with adjustable shelves • A complete selection of vanity cabinets for bathroom or dressing room.

You can be sure . . . if it's Westinghouse.



Town House

I-XL FURNITURE COMPANY

A division of Westinghouse

To help you build it better...kitchens women love



Circle 61 on Reader Service card

It's turmoil-as-usual for the West's savings and loans

The West's savings-and-loan industry is having an Excedrin headache.

Plagued for years by a hot money syndrome, by wheelers and dealers who have placed large and sound institutions on the ailing list and by sundry other maladies of the thrift business, the industry had nevertheless thought of late that its difficulties were easing.

But the last few months have brought the western S&Ls a renewal of the financial turbulence that periodically rocks this area.

- The troubled Lytton Financial Corp. reported third-quarter operating losses amounting to \$859,000, against a net gain of \$24,000 in the like 1967 period.

- Financial Federation, while improving a bit, still reported a net loss of \$1,223,441, or 45 cents a share, for the nine months ended Sept. 30, 1968.

- A mysterious New York shipping magnate, Daniel K. Ludwig, has begun to buy up California S&Ls on a wholesale basis, much as Howard Hughes bought Las Vegas hotels.

- The savings-and-loan doctor, Charles A. Wellman, has resorted to a merger to try to turn three sickly associations into one healthy giant.

- First National City Bank of New York is reported ready to move in on the savings and loans in California via cash purchase or stock acquisition.

- In Nevada, the Federal Savings and Loan Insurance Corp. has filed suit in Federal Court against former officers and directors of First Western Financial Corp., and the litigation is likely to go on for years.

These lingering financial migraines have sent much of the West's thrift industry racing for the medicine chest.

Trouble ahead in Nevada. Of deep concern to the industry is the Nevada situation, where the FSLIC instituted its \$30-million suit against First Western's former officers and directors.

The state's savings-and-loan industry, largely because of broker funds, has had its problems. Even today, with the insurance corporation providing liquidity to S&Ls in Nevada, large amounts of repossessed real estate plague the associations.

The Home Loan Bank Board's data show that savings and loans in Nevada hold \$613 million in assets while at the same time holding foreclosed real estate and other bad loans totaling \$178 million.

The First Western litigation names 27 defendants. The FSLIC charges that they conspired to inflate the price of the holding company's stock artificially and to enrich themselves unjustly by more than \$15 million—at the association's expense.

The troubles came to light in December 1966, when new management took over First Western S&L. In May 1967, the association sued six former officers and directors in state court.

That suit has now been merged into the FSLIC action, which cites First Western's former president, Robert C. Fielding, as well as Nevada's former lieutenant governor, Clifford Jones. It also names Mayor

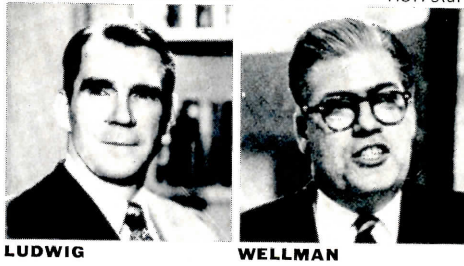

William L. Taylor of North Las Vegas, two Nevada County commissioners and the city manager of Boulder City, Nevada.

Merging out of trouble. The California picture is different. Wellman, who has already saved five problem S&Ls from near disaster, is attempting to merge Lytton, which he heads, with Equitable S&L of Long Beach and Mission S&L of Santa Ana. The combine would result in one strong thrift institution, and Wellman has devised a complicated stock plan to effect the deal. When completed, the new institution would have assets in excess of \$1 billion.

New York's City Bank is reportedly negotiating with Chairman S. Mark Taper to buy First Charter Financial Corp., the largest public S&L holding company. The negotiations have not been confirmed.

Shipping tycoon Ludwig, meanwhile, has been moving quietly into the savings and loan business on a grand scale. He has bought no fewer than five California associations.

Ludwig's interest in the business has not been explained.

Whether leaders can merge the industry out of its problems is conjectural, but that seems to be the intent. And, if that fails, there is always inflation. It has persisted in the past to the point where even the bad loans began to look good.

Biggest mortgage banker may get bigger—with Kissell Co.

The rush into consolidation continues in the mortgage business.

The Lomas & Nettleton Financial Corp., the Dallas holding company that became the world's largest mortgage banker with its purchase of the T.J. Bettes Cos. last summer, (NEWS, Aug.), is talking merger with the Kissell Co. of Springfield, Ohio.

Kissell is the eighth ranking mortgage banker, servicing \$790 million. It earned \$337,352 on income of \$4.6 million in the first nine months, off from \$581,133 on \$4.5 million in the same 1967 period.

The L&N financial operation includes the \$1.5 billion in the Bettes portfolios and another \$800 million serviced by an older mortgage subsidiary, the Lomas & Nettleton Co. of New Haven, Conn. The Bettes companies, operating from Houston, Tex., and Los Angeles, have been renamed Lomas & Nettleton West.

In another move toward consolidation, Detroit's Citizens Mortgage Corp., now the nation's 13th largest servicer on volume of \$725 million, has sold out for stock. The buyer is U.S. Industries, the New York City conglomerate.

HOMEBUILDERS' MORTGAGE MARKET QUOTATIONS

Reported to HOUSE & HOME in week ending Dec. 13.

FNMA Auction Prices Dec. 16 6 3/4 %	City	FHA Sec. 203b—Discount paid by builder Min.-Down* 30-year immed. w		FHA 207 Apts., Discount 6 3/4 %	Conventional Loan Rates			Construction Loan Rates
		Private mkt. 6 3/4 %	Trend		Comm. banks, Ins. Cos. 7 5/8 %	Savings banks, S&Ls 8 1/8 %	Savings banks, S&Ls Over 8 1/8 %	
90-day commitment Average 94.08 Accepted bid range 93.75-94.21	Atlanta	6-7	Up 2 1/4	a	7 1/2-7 3/4	7 1/2-7 3/4	7 3/4-8	7 1/2+2
	Boston	1	Up 1	a	7-7 1/2	7	*	7+1-1 1/2
	Chicago	6	Up 1	4	6 3/4-7	6 3/4-7	6 3/4-7+1 1/2-2 1/2	7 3/4-8
	Cleveland	5-6	Up 1	a	6 3/4-7	6 3/4	7-7 1/4+2	7 1/2+1
	Dallas	5-6	Up 1 1/2	6	7 1/2	7 1/2+1	7 3/4+2	8+1
180-day commitment 93.96 Accepted bid range 93.83-94.15	Denver	4-5	Up 1/2	a	7 1/2-7 3/4	7-7 3/4	7 1/2	7 1/2+1-2
	Detroit	4-5	Up 3/4	a	6 3/4-7	7	7+1-2	7 1/2-1-2
	Honolulu	6-7	Up 1 1/2	a	7 1/2-7 3/4	7 1/2-7 3/4	8+3-5	7 1/2-8 1/4+1-3
	Houston	4-7	Up 1	a	7 1/2	7 1/2	7 1/2-7 3/4	7 1/2+1 1/2
	Los Angeles	5-5 1/2	Up 1 1/4	a	7 1/2-7 3/4	7 1/2-7 3/4+1-1 1/2	7 1/2-7.9+1 1/2-3	7 1/2-7 3/4+1 1/2-3
12-18 month commitment 95.06 Accepted bid range 94.67-95.34	Miami	6	Up 1/2	a	7 3/4	7-7 1/4	7 1/4-7 1/2	7-7 1/4+1-1 1/2
	Minn.-St. Paul	4-5	Up 3/4	a	7-7 1/4	7 1/4	7 1/2	7 1/2+1
	Newark	3-5	Steady	b	7 1/2	7 1/2+1	b	7 1/2-7 3/4+1-2
	New York	b	—	a	7-7 1/4	7-7 1/4	7 1/4	7 1/4-7 3/4+1-1 1/2
	Okla. City	3-4 1/2	Steady	a	b	6 3/4+1	7+1 1/2-3	7 1/2-7 3/4+1-2
	Philadelphia	5	Up 1 1/2	a	7	7	7	7+2
	San Francisco	4-6	Up 1 1/2	a	6 3/4-7	7 1/2-7 3/4	7 1/2-8	7 1/2+1 1/2-2
	St. Louis	5-6	Up 1	a	7-7 1/4	7 1/4-7 1/2	7 1/2-7 3/4	7 1/2-7 3/4+1-2
	Seattle	5-5 1/2	Up 1/2	a	7 1/4-7 1/2	7 1/2-7 3/4	7 3/4+	7 1/2-7 3/4+1 1/2-2
	Wash., D. C.	5 1/2-6 1/2	Up 1	5-6	7 1/2-7 3/4	7 1/4	b	7 1/2+1-2

* Immediate covers loans for delivery up to three months, future covers loans for delivery in three to twelve months.
 • Quotations refer to prices in metropolitan areas, discounts may run slightly higher in surrounding towns or rural zones.
 • Quotations refer to houses of typical average local quality.
 * 3% down on first \$15,000; 10% of next \$5,000; 20% of balance.
 Footnotes: a—no activity, b—limited activity, c—Net yield to investor of 6% mortgage plus extra fees, w—for comparable VA loans also.
 Sources: Atlanta, Robert Tharpe, pres., Tharpe & Brooks Inc.; Boston, Robert Morgan, pres., Boston 5th Savings Bank; Chicago, Robert H. Pease, pres., Draper & Kramer Inc., and Robert H. Wilson, pres., Percy Wilson Mortgage & Finance Corp.; Cleveland, David E. O'Neill, vice pres., Jay F. Zook, Inc.; Dallas, M. J. Greene, pres., Southern Trust & Mortgage Co.; Denver, Clair A. Bacon, sr. vice

pres., First National Bank; Detroit, Sherwin Vine, vice pres., Citizens Mortgage Co.; Honolulu, H. Howard Stephenson, vice pres. Bank of Hawaii; Houston, Everett Mattson, sr. vice pres., Lomas & Nettleton West; Los Angeles, Christian M. Gebhardt, vice pres., Colwell Co.; Miami, Lon Worth Crow Jr., pres., Lon Worth Crow Co.; Minneapolis-St. Paul, Walter C. Nelson, pres., Eberhardt Co.; Newark, William W. Curran, vice pres., Franklin Capital Corp.; New York, Sigfred L. Solem, sr. vice pres., Dime Savings Bank; Oklahoma City, B. B. Bass, pres., American Mortgage & Investment Co.; Philadelphia, Robert S. Irving, vice pres., First Pennsylvania Banking & Trust Co., and Robert Kardon, pres., Kardon Investment Co.; St. Louis, Charles A. Keller, vice pres., Mercantile Mortgage Co.; San Francisco, John Jensen Sr., vice pres., Bankers Mortgage Co. of California; Seattle, Kirby D. Walker, vice pres., Continental, Inc.; Washington, James C. Latta, sr. vice pres., Associated Mortgage Cos. Inc. NEWS continued on p. 28

The kind of story this new kind of Westinghouse air conditioner is where the sound went. Outside.



But don't take our word for it: Compare.

The new Westinghouse "Continental SS" air conditioning system features a unique configuration that puts the machinery and sound outside and all the comfort and beauty inside. You can install it quickly and economically thru-the-wall or in a window.

What's more, the inside panel has a new low silhouette—only 10 inches high—and the attractive sliding doors can be drawn completely across the face to hide the controls.

As for performance, "Continental SS" models are available in 11,000 and 15,000 BTU capacity for multi-room performance.

Another tremendous advantage. When installed in the window, the inside panel assembly and duct-work can be removed so windows can be closed in winter.

Let a silent partner help you clinch the sale. The Westinghouse "Continental SS."

You can be sure . . . if it's Westinghouse.

To help you build it better . . . sales-clinching appliances



Sales/Marketing Managers

Levitt and Sons, Incorporated, continuing its dynamic expansion programs, has several outstanding top-level openings for Sales and Marketing Managers. We are seeking experienced, hard-driving individuals familiar with all phases of shelter marketing.

Salary commensurate with experience and ability. Send resume in strict confidence to:

EMPLOYMENT MANAGER

Levitt and Sons
INCORPORATED

LAKE SUCCESS, L. I., NEW YORK

Circle 63 on Reader Service card

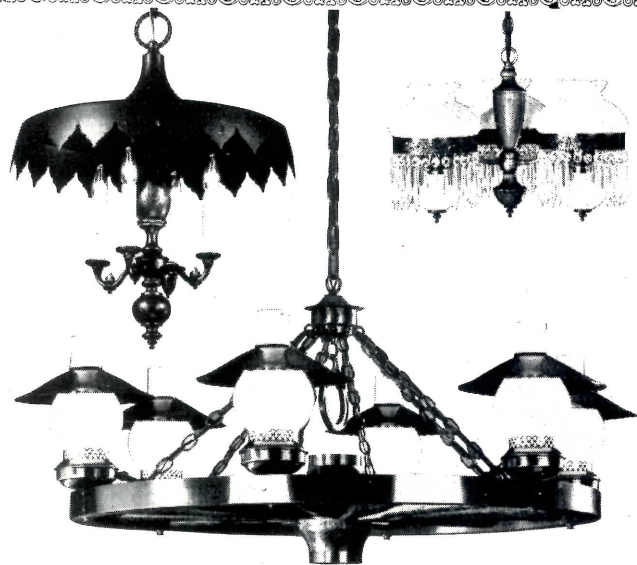

Incomparable American Heritage Designs

Becker Manufacturing, a leader in decorous theme accents in lighting... nautical, frontier, early American, Gay 90's, New Orleans and Spanish styles. It's at Becker where quality and design meet.



Write for our full color catalog
Becker Manufacturing Co., Inc.
P.O. Box 2277,
City of Industry, California 91746

Circle 64 on Reader Service card

NEWS

continued from p. 26

The builder who looked at his life with a shudder...and dropped out

Jim Kean

San Francisco homebuilder **Donald McCoy**—in all seriousness—is leading the same nouveau-hippie life that actor **Peter Sellers** played for laughs in the new movie "I Love You, Alice B. Toklas."

In the film, Sellers, playing a Los Angeles attorney, dropped into hippiedom after munching some marijuana-spiked brownies. The real McCoy traded in his briefcase full of headaches after a few puffs and a flying trip (no airplane).

What kind of a guy would forsake homebuilding—and give away a hard-earned \$250,000 in just eight months?

Apparently, a guy not unlike other builders.

Says a friend, Marin County developer **Alvin Corkland**:

"I can understand why he did it. I have felt that way myself on occasion. He was watching his life go by, and decided it just wasn't worth it."

Before growing his hair long and sprouting beads, the 37-year-old McCoy looked like any other money-maker. A reporter who saw him often at Marin County planning commission hearings says:

"He was the picture of success with his grey flannel suit, wing-tipped cordovans, crew cut and attaché case. He inherited money; but instead of becoming a playboy, he went to work developing his holdings."

In a 10-year career, he had built luxury houses and houseboats and speculated in real estate. And he had doubled his \$250,000 inheritance. But for McCoy, it was less than a labor of love:

"I had become a slave to my business affairs, running around in circles and getting nowhere. I realized that if you are unhappy, you are a failure—no matter how much money you make."

McCoy's marriage broke up last year. And with the help of his friends, he lit up a new phase of his life. Despite the expense, he moved his new family (14 adults, some married, and 11

Warner Brothers



... AND FILMDOM'S SELLERS

Playing it for laughs

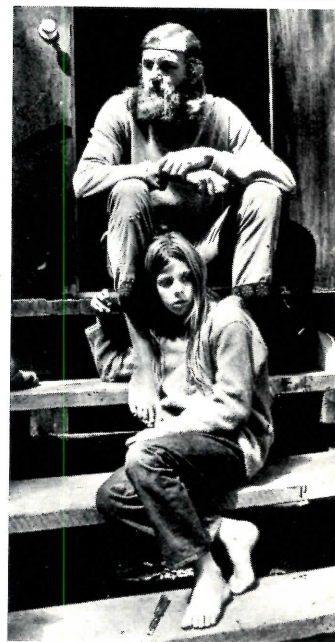

REAL LIFE's MCCOY . . .

With daughter, playing it for real

children, including his own three girls) to a leased ranch north of San Francisco. Said McCoy:

"This isn't a free-love atmosphere. We hope this will be a Utopian community. We call it cosmic Christianity."

(Local reporter **Mary Leydecker**, who visited the ranch to interview McCoy, found him dressed in a shirt that covered him from his navel on up. He later put on trousers for a photograph.)

In the last few months, McCoy's new life has complicated somewhat. His former father-in-law, **Arthur Lang** of Mill Valley, sued and won a ruling that named him conservator of McCoy's dwindling fortune. Since McCoy had said that he wanted to give away all his money, Lang contended that he was incapable of handling money. Lang's lawyer added:

"McCoy has three children. Someone has to take care of them."

McCoy retorted: "God will provide."

What's more, inside sources say McCoy's Utopian commune became a "bad scene" and disbanded. The McCoy children rejoined their mother.

It is unclear whether any of this is giving McCoy second thoughts. When last seen he was heading westward into the horizon—toward India—in search of a guru.

(P.S.—In the film, Sellers returns to his law practice, only to drop out again.)

—TY MARSHALL
McGraw-Hill News, San Francisco

NEWS continued on p. 30

HOUSE & HOME

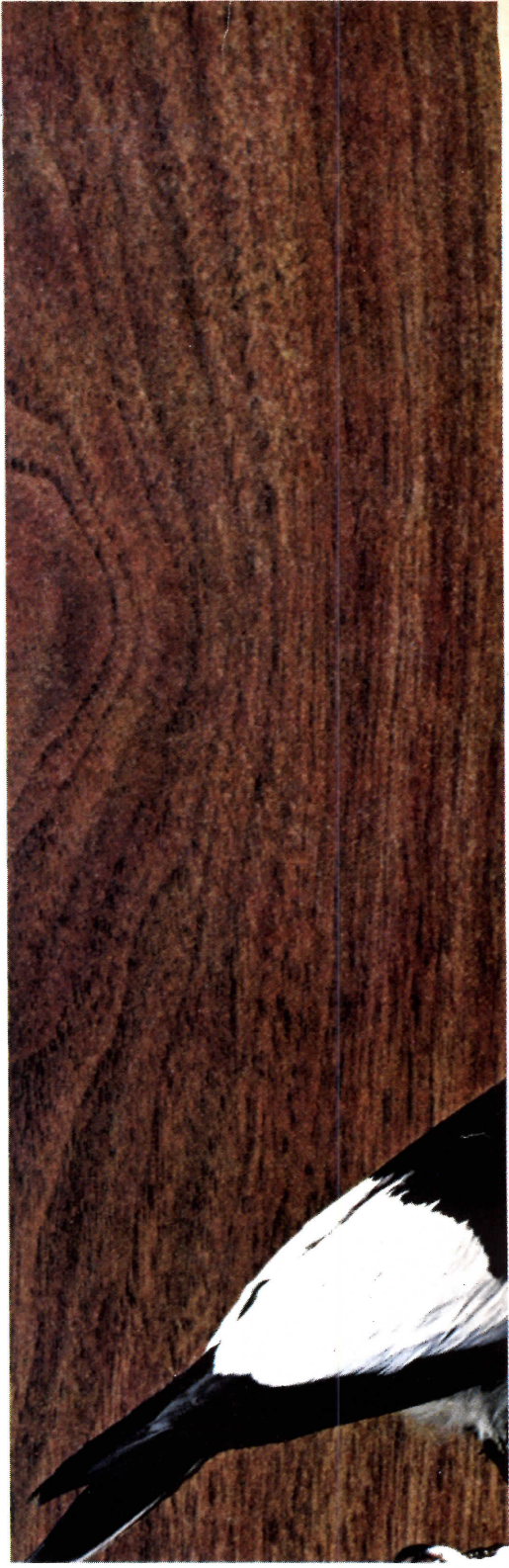

Micarta® "Velvet" finish is so natural, only a woodpecker knows for sure

Is it wood or isn't it? It looks and feels like it. It resembles the rubbed finish of a fine veneer. It's really a breakthrough in high-pressure laminate surfacing. Amazingly authentic reproductions available now in Barnwood, Rosewood and 15 other wood patterns. Also new: Micarta Sunstone and Valencia Marble, strikingly beautiful on kitchen surfaces and vanities

and in bathrooms. And more, new Micarta leather patterns in white, black, brown and avocado. *Unquestionably elegant* on furniture, counters and in gamerooms. Micarta is *in*—48-hour delivery on distributor patterns. Contact Westinghouse Micarta, Hampton, S.C. 29924—or your U.S. Plywood branch. You can be sure... if it's Westinghouse.

J-06748

To help you build it better... beautiful rugged surfaces



Circle 65 on Reader Service card

**MAIL EARLY
IN THE DAY!**

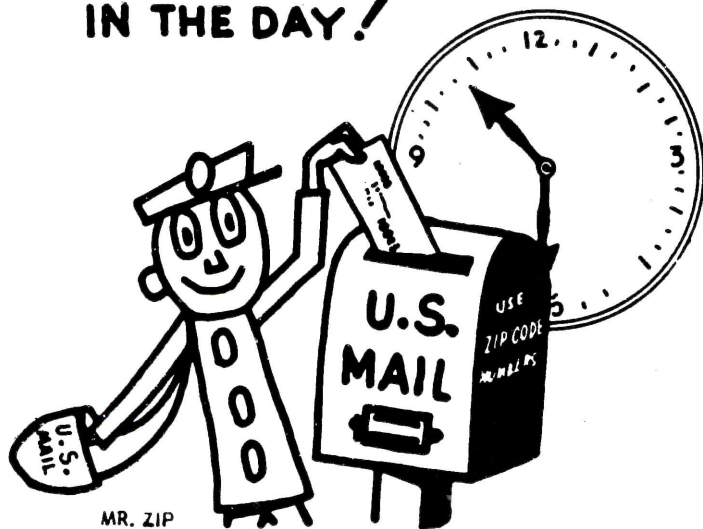

MR. ZIP
**ZIP CODE NUMBERS
BELONG
IN ALL ADDRESSES**



YOUR POSTMASTER

Announcing—

**New Blu-Ray 1042
table-top whiteprinter...
offers dependable
high speed production
at a budget price!**



Speeds to 22 feet/minute.

Model 1042 is the big producer in our line of low-cost, compact whiteprinters. It challenges the output of big costly printers.

So check these 6 features — if they meet your production needs — you can save a lot of money:

1. Makes up to 400 "D" size prints per hour. Takes prints to 42" wide.
2. 4 ultra-fast fluorescent lamps — easy and inexpensive to replace.
3. Diazo materials cost only 1¢ per sq. ft.
4. Always ready to go — no waiting for warm-up.
5. Synchronized printer and developer.
6. Dependability backed by BLU-RAY's exclusive 1-year warranty.

The new 1042 has already proved its worth, which isn't surprising when you consider BLU-RAY has led in compact whiteprinter sales for 13 years!

Send for free brochure and a demonstration by one of our 600 dealers coast to coast.

BLU-RAY
INCORPORATED

4024 Westbrook Road
Essex, Conn. 06426
Phone (203) 767-0141

NEWS

continued from p. 28

**Marv Kratter quits Realty Equities
—one of the last of big syndicators**

Wide World Photos

The Brooklyn grocer's son who put together a land-and-buildings empire that in 1960 stretched from Toronto to San Francisco has just resigned as chairman and president of National Equities Corp. of New York City.

Howard S. Levin, 44, steps in as president. He is president of the Levin-Townsend Computer Corp., which bought National Equities last fall. **Clarence H. (Ted) Adams**, 60, formerly executive vice president of National Equities, becomes chairman.

Marvin Kratter formed National Equities in 1965 by splitting his old Kratter Corp., which had enjoyed dizzying success before its stock crashed amid the realty syndication scandals of 1961-1962. Kratter took several assets and organized National Equities as a divers-



REALTY EQUITIES' KRATTER

End of an empire

fied realty company. The remainder of the Kratter Corp., under new management became Countrywide Realty.

California S&Ls get new publicist

Dorothea Hegwer, the blonde and blue-eyed public relations girl who served as a gentle buffer between financial reporters and executives who ran California's big savings-and-loan associations, has retired to clip coupons and watch the sunset.

Mrs. Hegwer was director of public relations for the California S&L League, the trade organization that represents most of the state's 269 associations. She edited the *California S&L Journal* and wrote the first comprehensive history of California's \$28-billion S&L business, which appeared in the *Journal* in 1965.

The public relations post goes to **Paul de Ceglie**, 28, an associate editor of the *Savings Bank Journal*, published in New York City by the National Association of



PUBLICIST DE CEGLIE

Westward bound

Savings Banks. He has been a reporter in New York City for the *Journal of Commerce* and in New York and Washington for the *American Banker*.

Joseph Brunetti dead; a builder in New Jersey

Joseph J. Brunetti, who as a Brooklyn youth founded a construction company on \$200 and went on to build thousands of houses and apartments in three states, died of a heart attack Dec. 9 at his winter home in Fort Lauderdale, Fla.

Joseph J. Brunetti Construction Inc. of New Milford, N.J., built the 1,750-unit Brookchester Apartments in that city and the 1,188-unit Richfield Village in nearby Clifton. The company also operated in Connecticut and Ohio.

Brunetti retired several years ago to his horse-breeding farm, Red Oak, at Ocala, Fla.

DIED: Irvin A. Blietz, a founder of NAHB and a past president of the HBA of Chicagoland, who during a 48-year career built 2,000 top-quality houses and apartments in Chicago's northern suburbs, at

72 at his home in nearby Winnetka. **Manuel F. Jacinto**, who built hundreds of homes in Sacramento and surrounding cities before retiring to breed horses, at 68 in Sacramento.

ASSOCIATIONS: John Cotton of San Diego, Calif., former treasurer, succeeds **Lyn E. Davis** of Dallas as president of the National Assn. of Real Estate Boards. **Robert E. Boley** steps from a staff position to the presidency of the Urban Land Institute, succeeding **Max S. Wehrly**, who retires. **Clarence A. Thompson**, president of the Thompson Lumber Co. in Champaign, Ill., takes over from **D.C. Dawkins Jr.** of Jacksonville, Fla., as president of the National Lumber & Building Material Dealers Assn.

LEADERS start on p. 34

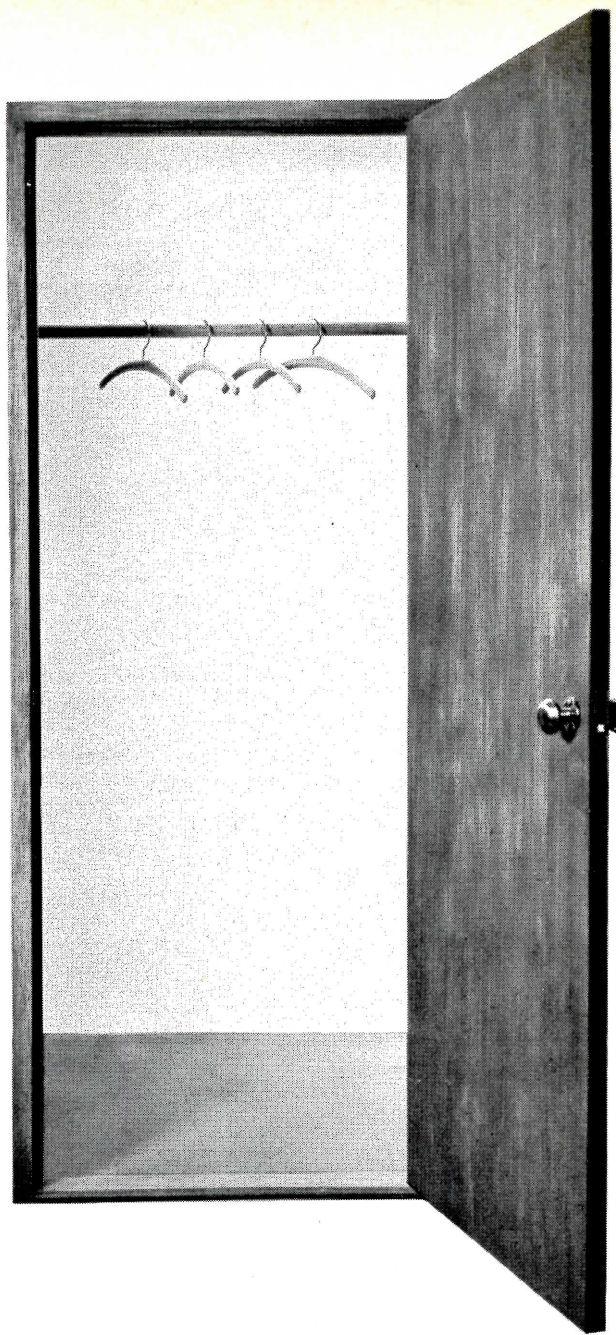

In this 24" x 48" closet you can put four coats, six suits, a couple of suitcases, five pairs of shoes, three or four hats, some blankets, and a Westinghouse 2-ton air conditioning system.

Install a Westinghouse 2-ton or 1½-ton air conditioning system in a clothes closet and it stays just that. A clothes closet.

You won't find more compact apartment-sized units than that.

For example, you can fit the 2-ton job horizontally above a closet door—out of sight. Or vertically snug, if you wish. The condensing unit can be installed through the wall, free-standing on the roof, or at ground level.

And with pre-charged, quick-connect couplings, the units are both reliable and easy to connect.

Can anything so compact give maximum performance?

Westinghouse air conditioning systems are the quietest and most efficient of all. A 3-speed fan designed for the lowest noise level is one reason. Another is our exclusive high reliability compressor.

This too: Optional electric heating unit that provides the broadest range of selection.

For full information on these year 'round systems AH-006 and AH-008, write to Westinghouse Air Conditioning, Staunton, Virginia 24401.

You can be sure...if it's Westinghouse.

To help you build it better...total comfort systems



Circle 67 on Reader Service card

Circle 68 on Reader Service card ➤

**Our Prefinished Woodrock
is like having
weather insurance**



You'll never be penalized by poor painting weather. Prefinished Woodrock can go up any time of the year.

Woodrock comes to you prefinished with a factory-controlled finish in five beautiful colonial colors and white. The smooth finish is so durable we guarantee it against blistering, peeling and blushing.

And Woodrock is the only siding that can be top-nailed.

Prefinished Woodrock is available in 12" wide clapboard and panels. And because the clapboard can be top-nailed, hammer marks won't show, nailheads can't rust. The resulting benefit... fewer call-backs for you.

We can even promise you this: when you use prefinished Woodrock® you get a quality, longer lasting factory-applied finish at a cost comparable to siding that requires job site painting.

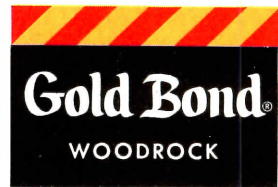

The name Gold Bond® identifies fine building products from the National Gypsum Company. For more information on prefinished Woodrock, write Dept. HH-19W, Buffalo, New York 14225.

Building hidden values is a National responsibility

Gypsum Company



Homes, Builders and the National Gypsum Company Gold Bond has ideas, products and systems for better living environments at low cost. They help you build houses, apartments and buildings of all types which are more attractive, safer and quieter. See prefinished Woodrock and all Gold Bond products at Booth 3500, NAHB Show, Houston, January 13-18, 1969.

Fieldstone gray

Yarmouth yellow

Mt. Vernon white

Village green

Sudbury red

Federal gold

WHAT THE LEADERS ARE BUILDING

Photos: Julius Shulman

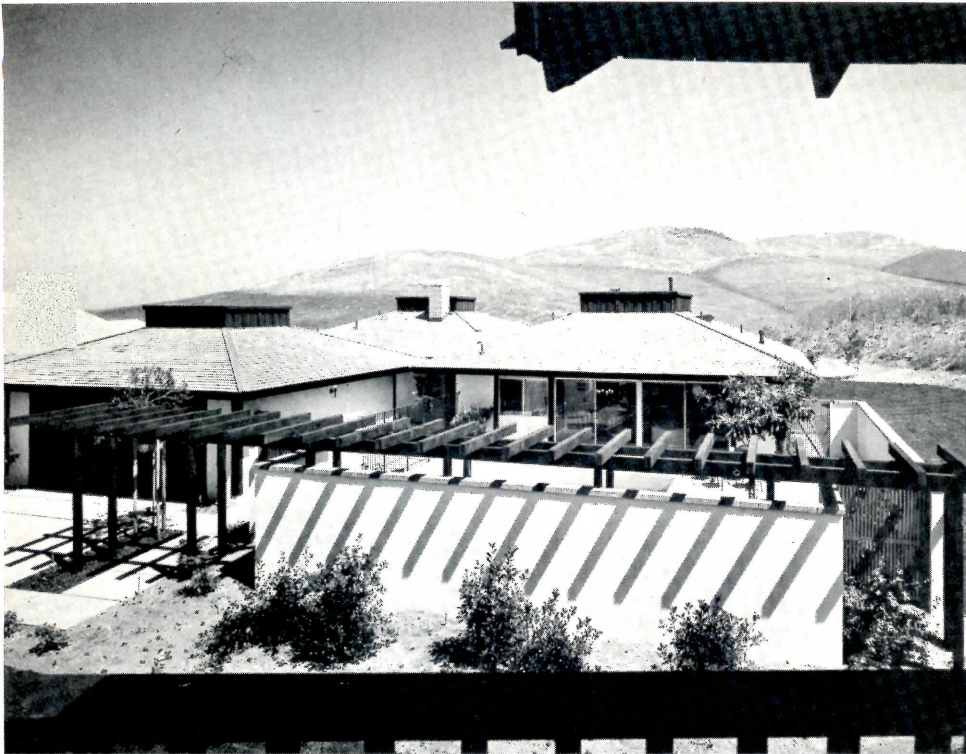

WINDOWED KITCHEN overlooks pool court. Just beyond the eating counter at left, sliding doors open onto the patio (plan, below).

A walled court for a pie-shaped lot

Most cul-de-sac plans include a few lots that are roughly pie-shaped and thus have very small—and usually useless—front yards. This one-story house shows how to turn such a yard into usable—and private—outdoor living space.

The house is sited close to the street, and one corner of the front yard is completely walled in as a family-living patio with a pool. The 1,820-sq.-ft. plan was designed to work with this siting: the kitchen, directly off the central entrance, looks out into the pool area, and the family room and eating area have sliding doors that open onto the patio. Between the kitchen and family room is the laundry, convenient for handling bathing suits and towels. And directly

behind the family room is the children's bath with its own side door for easy access.

The formal areas and the bedrooms are on the opposite side of the house from the noisy family courtyard. The dead-end living room and setback dining area have glass walls that look into the rear yard and sliding doors that open onto a terrace. The two small bedrooms also have a view of the rear yard, as does the master bedroom which also has a private court off the master bath.

Designed by architect Richard Leitch & Assoc., the house is being built by Middlebrook Anderson at Irvine, Calif. It is part of a 44-house section that has been open only nine months. Of the 40 sales to date, six have been of this \$35,600 model.

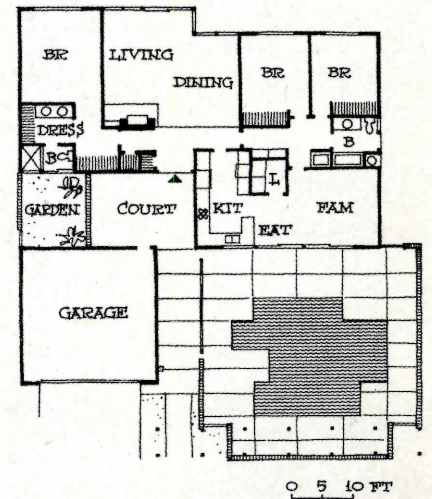

WALLED-IN COURT provides private outdoor living space directly off the street. Garage, just across entrance walk, is handy for storage.

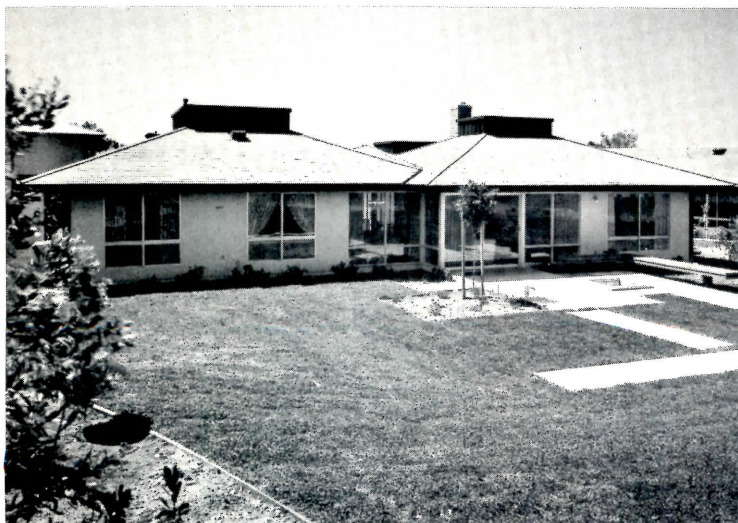

REAR TERRACE, unfenced in the model, is directly off the central living room. Children's rooms are at left, master bedroom at right.



ENTRANCE WALK leads past corner of garage, left, to gates that open into the walled court, right. Central entrance court is just beyond.

It's all Williams but the wallpaper



Just select the color. Williams does the rest with matched sets of vanities and upper cabinets, styled the way a woman wants them. Designer approved in seven planned-to-please-her shades and rich wood finishes — coordinating tops and bowls.

And Williams flatters her with the warm light of incandescent bulbs. With big, big mirrors. Delights her with durable finishes that resist her family. Provides more space for their belongings.

Does she like to plan? We've a range of sizes to fit any space and lots of optionals to make her planning practical. Don't forget our popularly priced medicine cabinets — to use alone or with vanities. And that takes care of everything except the wallpaper.



The Cordoba in Spanish oak finish



The Mount Vernon in white and gold

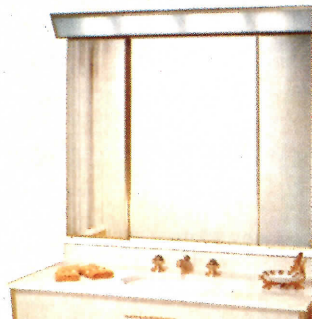

The Constellation with stainless or gold trim

WILLIAMS PRODUCTS, INC. HH
 1536 Grant Street
 Elkhart, Indiana 46514

Send me your free full-color catalog.

Firm Name _____
 Address _____
 City _____
 State and Zip _____
 Attention of _____
 Type of firm _____

Sold through selected distributors. Help yourself while you're pleasing her. Write for our complete line catalog.

WILLIAM
 PRODUCTS, INC.

Satin/Glide



We are indeed proud to be one of the thirty-six kitchen cabinet manufacturers whose cabinets have been certified as meeting the Standards of the National Kitchen Cabinet Association. Together these manufacturers produce well in excess of one hundred million dollars worth of kitchen cabinets a year at the wholesale level.

The NKCA worked three years to develop the Standards—a quality yardstick in terms of *performance*. Construction and finish should resist both use and abuse to a reasonable degree; doors and drawers should operate freely; shelves should be able to carry substantial loads. These and many other points are covered in the NKCA's "Recommended Minimum Construction and Performance Standards for Kitchen Cabinets." Manufacturers

who have been licensed to use the certification seal shown above are subject to production-line inspection at any time.

Everybody benefits. By adherence to the NKCA Standards and use of the certification seal, the manufacturer widens recognition of the merits of his cabinets not only with consumers, builders and dealers—but with developers, realtors and architects, and agencies on local and national levels concerned with housing and housing components.

The Federal Housing Authority has told all FHA insuring office directors and regional administrators that it recognizes the NKCA Standards as meeting the FHA's minimum requirements, and will accept the NKCA certified cabinet seal as evidence of compliance with the NKCA Standards.



H. J. SCHEIRICH CO. LOUISVILLE, KENTUCKY

**"In conventional building,
a lack of effective sales
aids had us locked to a
limited number of pre-sales . . ."**
say Robert and Reinhard Friedrich

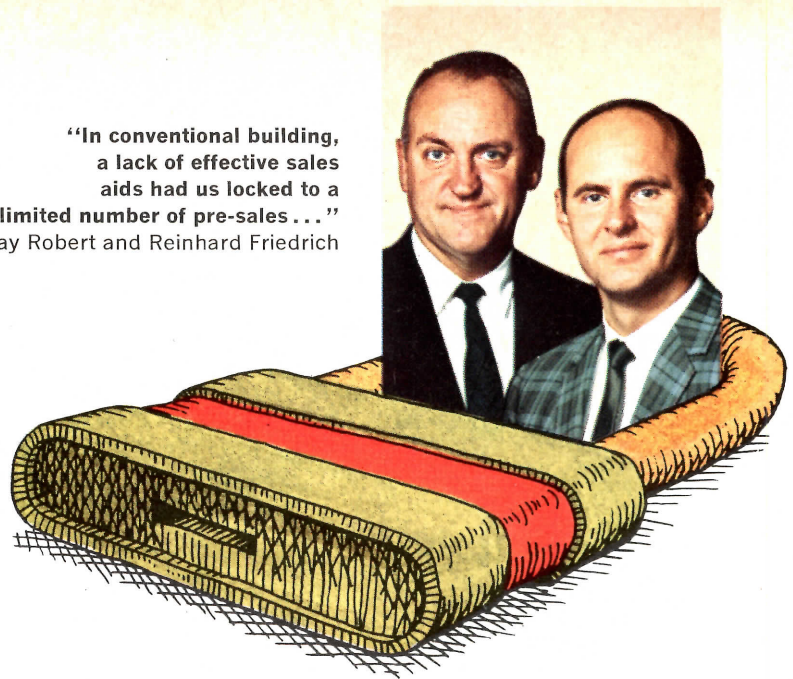

"Now, using Kingsberry's professional sales aids, our pre-sales are up 50%!"

The Kingsberry package paid off with profit-making pre-sales for these two veteran builders.

Now—in an industry known for fluctuating costs—the Friedrichs make on-target projections. Thanks to Kingsberry's established material prices.

You can beef up your building program too. You can do it with advantages we've *proved* in 55,000 homes: 50% reduction of on-site labor . . . over 130 designs produced by years of research and backed by beautiful

architect's renderings . . . generous cooperative advertising allowance with professional materials furnished for your local promotions.

You get all this *plus* your knowledgeable Kingsberry Representative. He'll work with you, elbow to elbow, on everything from initial construction to promotion.

Unlock the limits of your profit picture by mailing the coupon today.

Kingsberry's "Marseille," as built by Friedrich and Sons, Inc., Ames, Iowa.



COPYRIGHT © BOISE CASCADE CORPORATION, 1969

**KINGSBERRY
HOMES**

DIVISION OF BOISE CASCADE

Kingsberry Homes/5096 Peachtree Road
Chamblee, Georgia 30341/ (404) 457-430

Director—Marketing / Kingsberry Homes / Department HH-1
5096 Peachtree Road / Chamblee, Georgia 30341 / (404) 457-4301.

Please send more information on the Kingsberry program.

Have your representative call on me.

I have built _____ homes and/or _____ apartments during the past 12 months.

Name _____

Firm _____

Address _____ Phone _____

City _____ State _____ Zip _____

Kingsberry serves leading builders in 33 Midwestern, mid-Atlantic and Southeastern states.

Jamestown Village, Cleveland, Ohio
Architect: Andonian and Ruzsa
Builder: Skyline Builders



The shangle

One picture is worth a thousand words. Beauty, grace, charm, durability. You could go on and on without ever touching upon enough words to fully describe the new Hallmark shingle. It's indescribable.

In the first place, it really isn't a shingle. It's thicker, heavier and more deeply sculptured than any shingle you've ever seen.

And, although many builders insist that it looks like a fine hand-split wood shake, it isn't. It's fire safe and won't rot, warp, shrink or split. It's truly a new concept in roofing. It combines the deep sculptured beauty of a shake and the long life of a high quality asphalt shingle. That's why many people call it "The shangle."

We'd like to show you, with pictures, what words can't, how Hallmark's deep sculptured beauty in bronzed brown, pewter grey and golden tan, can add extra curb appeal to homes and garden apartments with mansard type roofs. Certain-teed Products Corporation, BA2, Ardmore, Pa. 19003.



Easy.

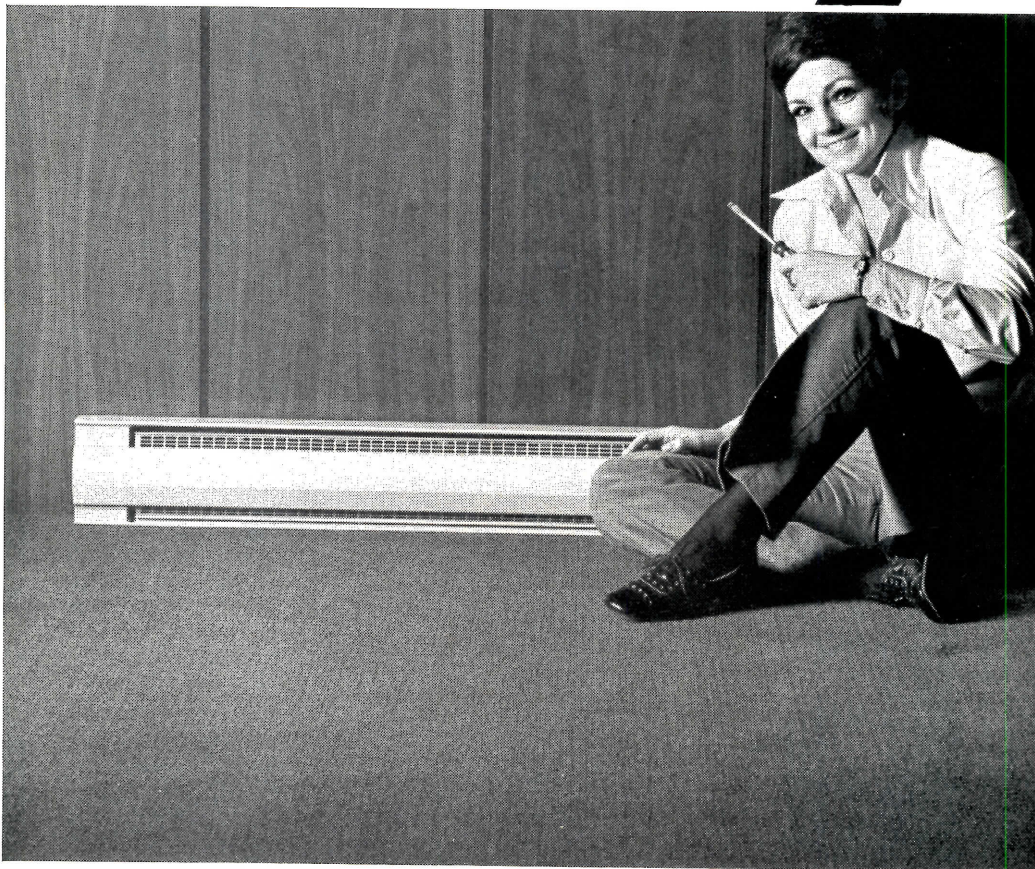

Simple — fast installation! Just one of the many features that make Chromalox® electric baseboard heaters your number one choice. A wide selection of standard sizes that can combine to fit any wall dimension; screw slots for mounting without disassembly; integral junction boxes and end caps for wiring through either end.

Add to this trim styling, excellent performance and solid construction featuring Chromalox Fintube® heating elements. That's why Chromalox Baseboard Heaters rank so high in popularity.

Want to learn more? This is easy, too. Just contact your local Chromalox distributor or write direct for Bulletin R16100.

WR-120



Chromalox® Electric Heat
EDWIN L. WIEGAND COMPANY
SUBSIDIARY OF EMERSON ELECTRIC CO.
7770 THOMAS BLVD., PITTSBURGH, PA. 15208



Do you have any plans for the show? Bring them to the Tappan exhibit.

You've got big plans for this year, either in your head or on paper. And an important part of every home plan is the kitchen.

So talk to Tappan. Our business is everything in the kitchen. Not just a few pieces. The whole shmear.

This includes every kind of range — built-in, drop-in, slide-in. Every kind of cooking energy — electric,

gas, electronic. And the cabinets, dishwashers, refrigerators, disposers and hoods to complete the job.

Out of all this, Tappan can assemble a quality kitchen "package" just for you. Exactly suited to your plans and prices.

Stop at Booth 2532: you'll see why Tappan is the "Talk of the Kitchen". And be our guest in the

International Club Lounge Jan. 13 and the Grecian Room at The Shamrock-Hilton, 6-9 p.m. January 14-15. Together, we'll pour over some plans. Tappan, 250 Wayne Street, Mansfield, Ohio 44902.

TAPPAN

Convenience by the Kitchenful

Our faucets are a great "for sale" sign.



They can actually help you sell a house. Because Delta faucets in a new house say something about the quality of your construction. Something good. That you've gone first class all the way.

You know which two rooms the housewife is interested in. So install Delta faucets. She can plainly see how good they look. And soon she'll know how well they work. Because

we're telling her about it in women's magazines. Telling her that with only one moving part, Delta single handle ball faucets hold up. For years.

When it's time to put up a for sale sign, put in Delta faucets. They're a for sale sign . . . of quality.



DELTA FAUCET

Div. of Masco Corp., Greensburg, Ind. 47240

A work of art made to be handled.



Schlage Lock Display #3302 at NAHB. Photograph by Ernest Braun

**This could
open up your
most profitable
new ideas for
1969**

Right now, we wouldn't dare to show you more of our NAHB display. It is too different, too unique, too unusual.

You must see it.

And hear about *all* the ideas, plans and material which Schlage Lock has *developed to help you in selling the homes and apartments you build*. Sell them faster and more profitably.

This display is not just to sell fine Schlage Locks. It is to present you with the ways and means to sell *complete* fine homes and apartments. So visit our display or contact your Schlage representative for details.

SCHLAGE
LOCK COMPANY®
SAN FRANCISCO • VANCOUVER B.C.

IRST on the market . . . and still the BEST!

**"HI-RED"[®]
PLASTIC
SCREW ANCHORS**



**27 SIZES
FOR NO. 4
SCREWS
THRU
1/2"
LAG**

**EASY
TO
USE**

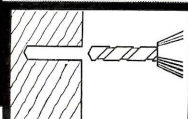

DRILL HOLE



INSERT "HI-RED"

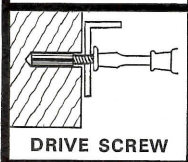

DRIVE SCREW

**Collarless
Anchors
for Flush
Mountings
... Terrific
Holding Power
in Any Solid
Material.**

These "all-purpose," low-cost anchors permanently hold screws in any material you can drill—hold up to 2 tons. Take small holes. Use indoors or outdoors. Try 'em!

MILLIONS IN USE!

**BUY 'EM IN
HANDY KITS . . .
OR CARTONS.**

**Kits include an-
chors, screws,
masonry drill.**

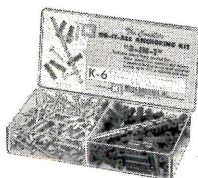

**WRITE FOR
FREE SAMPLES**

Hi[®] HOLUB INDUSTRIES, Inc.
421 ELM ST. • SYCAMORE, ILL. 60178

What tenants want

H&H: Enjoyed your November article, "What grabs the typical apartment tenant?" In my adult education classes in apartment house management, I take a survey at the beginning of each semester to determine what the students think are the five most important items to a prospective tenant.

The number who take part in the survey continues to grow, but the results remain the same: 1) location, 2) price, 3) apartment interior, 4) exterior appearance, 5) general condition and appearance.

Something interesting in the Los Angeles area is what's happening to swimming pools. We used to add \$5 to \$10 per month for units in apartment projects with pools. Now pools have become so commonplace in southern California that buildings without them have become very desirable, and renting for about the same price. Poor placement of pools increases the noise factor, and peace and quiet seems to be getting more popular.

DON ROYALE
William Walters Co.
Los Angeles

Equity financing

H&H: I understand that copies of your very fine December article covering equity participations ["Piece-of-the-action fever sweeps mortgage financing"] are available. If so, we would appreciate having one.

We have been actively involved in this type of financing in Canada over the past two years and, more recently, have been negotiating a couple [of such loans] in the United States, where we do a life insurance and mortgage business.

L. G. ROBERTSON
Assoc. supt. of mortgage investments
The Canada Life Assurance Co.
Toronto

Annual H&H indexes

Copies of House & Home's editorial indexes for 1965, 1966 and 1967 are still available. Each is an eight-page, cross-referenced listing of subjects covered that year by this magazine. To get copies (there's no charge) write to: Reader Service Dept., House & Home, 330 West 42nd St., New York, N.Y. 10036.

Mobile homes

H&H: Your October editorial on mobile homes ranks as one of the most delightfully stimulating pieces of writing I have seen all year.

We need people like you to take fresh and frank looks at our total business, but unfortunately most other people in our industry are too close to it to see it objectively.

If we are going to be the second largest industry in the nation, we'd better start thinking and acting like it. Editorials such as yours are probably the best medicine we could get in this regard.

ERNEST A. CUNO
Builders Association of Northern Nevada
Reno

H&H: In your editorial [on mobile homes], you seem to have chosen some words that do not truly reflect the situation.

In your "basic reasons" [why mobile-home

prices and new-house prices are not comparable], you fail to mention that unlike conventional houses, mobile homes come completely furnished. Shouldn't this be considered in your "price comparison"?

Contrary to your second point, our "chattels" cannot be dragged away or stolen. If you had done any research or were at all familiar with today's mobile homes (which apparently you are not), you would know that only licensed transportation companies, which have applied for road permits, can move them.

Your third point proves that you are completely out of touch with our industry. There are many mobile homes that are sold at a profit by the owners. These homes are in parks that have waiting lists of several years.

So the cost comparison you have put together is illusory. And when you add all the factors, the total cost would not allow any mobile-home owner to own a \$25,000 house.

Why then, you ask, do people buy mobile homes? Perhaps the main reason is that the conventional housing industry has abandoned the low-income housing market. Millions of Americans cannot afford conventional housing and thus turn to mobile homes to satisfy their shelter needs.

We do not claim to be the panacea for low-income housing; however, we know we can help ease the housing crisis.

DOUGLAS M. FENTON
Marketing Services
Divco-Wayne Industries Inc.
New York City

H&H: Your thinking was clear, and your statements were well presented.

CLARENCE A. THOMPSON
President
Thompson Lumber Co.
Champaign, Ill.

H&H: I think this is the first time I have ever seen a leading building authority put into print the truth about mobile homes.

I have a book on building which is on the verge of publication, and I would like very much to re-print this article in the book. If you have no objections, would you please give me written permission.

D. R. HODGINS
Homestead Corp.
Warren, Mich.

Permission granted.—ED

Vandals and thieves

H&H: Vandalism and theft are expensive and frustrating problems for most builders. We have recently solved these problems by having our field supervisor purchase a home in our subdivision and actually live there. Since most subdivision operations are planned for two to five years, the cost of moving the field supervisor around like this is not excessive.

By getting acquainted with the new homeowners who are his neighbors, our supervisor is able to enlist their cooperation in preventing vandalism by their children and in notifying him of any theft taking place in the area.

He is directly responsible for protecting all property and is expected to make a nightly inspection of the area under construction and to lock houses after each day's construction.

JIM RUSSELL
President
Jim Russell Construction Corp.
New Orleans



something's
always
cooking
in a
Roper kitchen



A Roper Kitchen is quite naturally the heart of the home . . . where the action always is.

For 1969, Roper is the action line . . . first in features, first in fashion

. . . finest in performance and dependability.

Cook-up real sales action in the heart of your homes with Roper '69!

choice of gas or electric:

SELF-CLEANING OVEN RANGES

eye-level and console

COUNTER BUILT-IN RANGES

COOK TOPS AND WALL OVENS

plus: DISHWASHERS (undercounter and portable)

DISPOSERS • HOODS • SINKS • GAS GRILLS

GEO. D. ROPER SALES CORP. / KANKAKEE, ILLINOIS 60901

**Moen comes up
with a gem.**

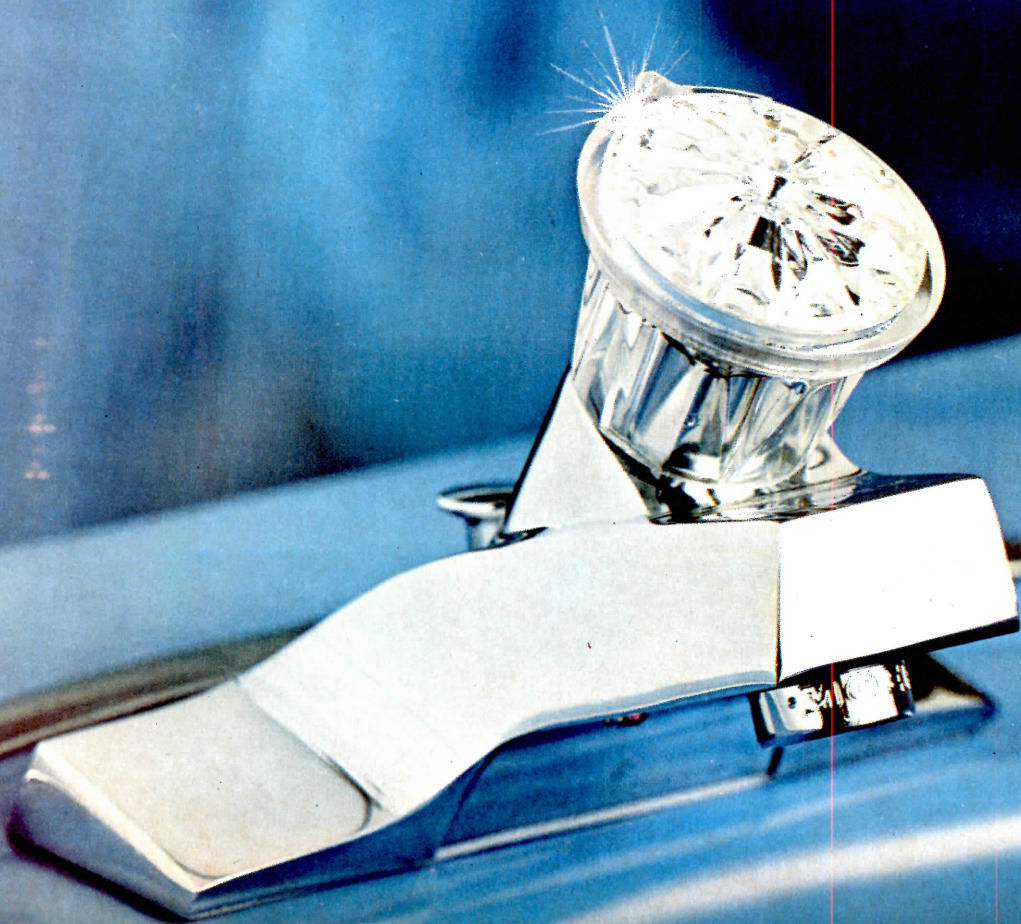

The new handle that turns people on, with style.



It's dedicated to the proposition that faucets should do more than turn on the water—they should help sell the home.

That's where the new Moen handle sparkles. It's bold enough to attract attention. And gem-like to pick up every color in the bathroom.

Beneath the handle, Moen faucets are all convenience. With single-handle ease of

operation. And the one-of-a-kind Moenique™ accessory center, plus single-dial shower controls and lavatory faucets.

If you think this is squeezing a lot of sales appeal into one home—you're right.

MOEN the faucet that
turns people on.



Moen, Elyria, Ohio 44035
® a division of Standard Screw Co., 216/323-5481,

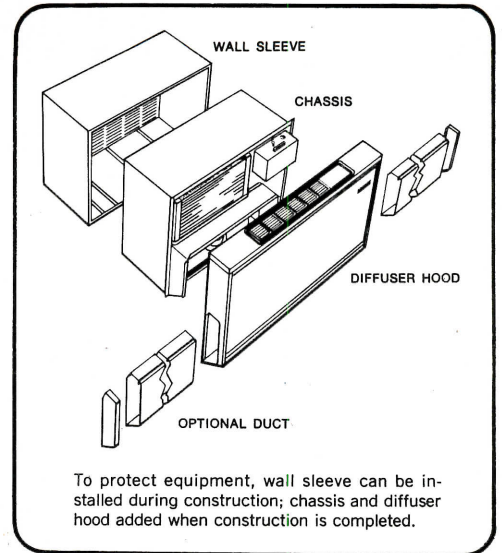
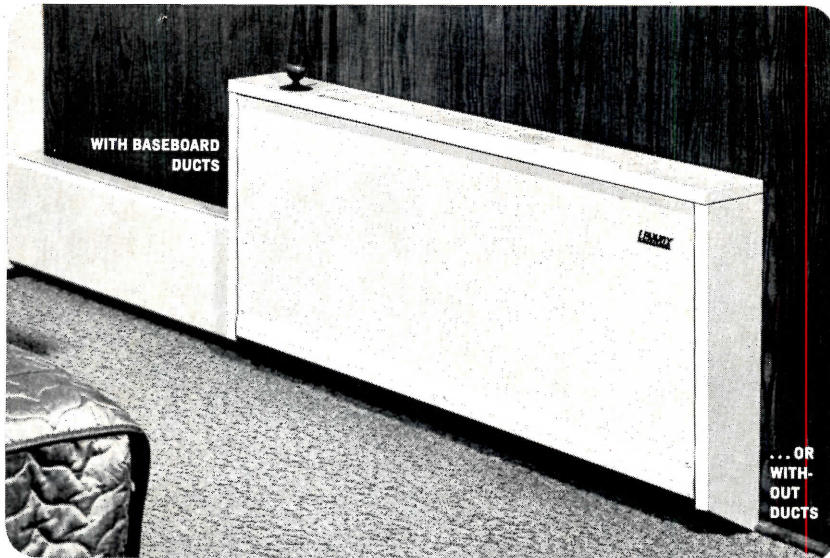

the comfort cell

new cooling/heating unit for apartments,
motels, offices, nursing homes



COMPARE PACKAGING!

This single, compact, package-terminal unit handles air conditioning, heating and ventilation. Cabinet contains all controls.

COMPARE BASEBOARD DUCTS!

Optional air duct sections connect to either or both sides of unit, deliver air along entire wall . . . or into adjoining room.

COMPARE APPEARANCE!

Sleek, modern, uncluttered Comfort Cell is attractively designed. Front assembly primer finish can be painted to match decor—and to change with it.

COMPARE INITIAL COST!

This new package-terminal unit costs much less than equal capacity central or multi-package systems.

COMPARE INSTALLATION COST!

Shipped prewired and precharged, Comfort Cell requires minimal on-site labor. With wall sleeve flashed in, two men can install in just 15 minutes.

COMPARE OPERATING ECONOMY!

"Owners" can choose lowest-cost heat source—electricity, hot water or steam.

COMPARE QUIETNESS!

High-efficiency acoustical insulation keeps sound level below comparably-rated units.

COMPARE SPACE SAVINGS!

Compact Comfort Cell never steals closet or equipment room space. Only 51 inches wide, extends just six inches into room.

COMPARE COOLING EFFICIENCY!

Comfort Cell delivers more air volume per ton of cooling than any comparably-rated unit. Cooling: 9,000-15,000 Btuh. Electric heating: 8,500-17,000 Btuh. Optional: 11,000-23,000 Btuh, hot water; 20,000-24,000 Btuh, steam.

For complete and immediate details, write Lennox Industries Inc., 442 S. 12th Avenue, Marshalltown, Iowa 50158.

LENNOX
AIR CONDITIONING • HEATING

What's new in floors...

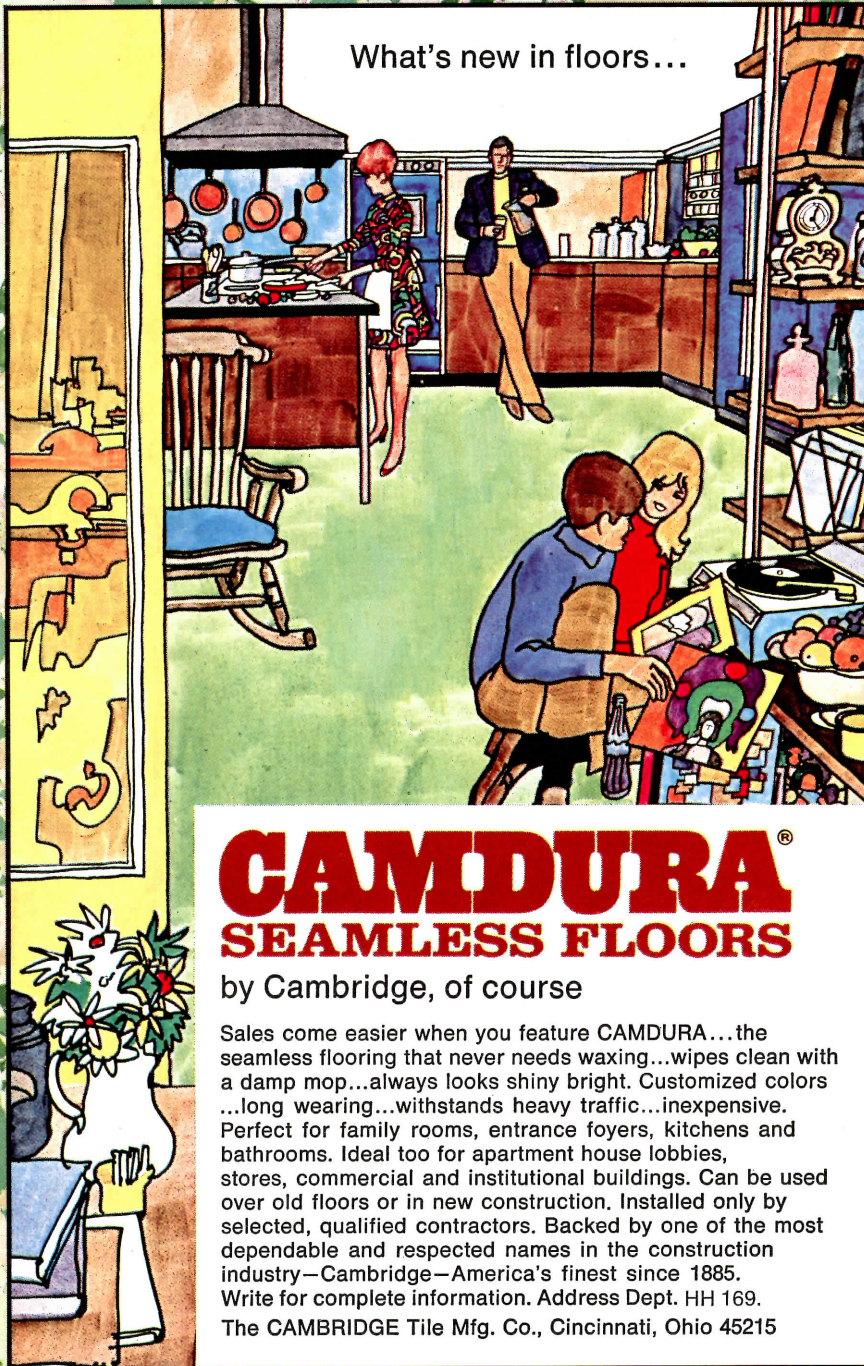

CAMDURA[®] **SEAMLESS FLOORS**

by Cambridge, of course

Sales come easier when you feature CAMDURA...the seamless flooring that never needs waxing...wipes clean with a damp mop...always looks shiny bright. Customized colors...long wearing...withstands heavy traffic...inexpensive. Perfect for family rooms, entrance foyers, kitchens and bathrooms. Ideal too for apartment house lobbies, stores, commercial and institutional buildings. Can be used over old floors or in new construction. Installed only by selected, qualified contractors. Backed by one of the most dependable and respected names in the construction industry—Cambridge—America's finest since 1885. Write for complete information. Address Dept. HH 169. The CAMBRIDGE Tile Mfg. Co., Cincinnati, Ohio 45215

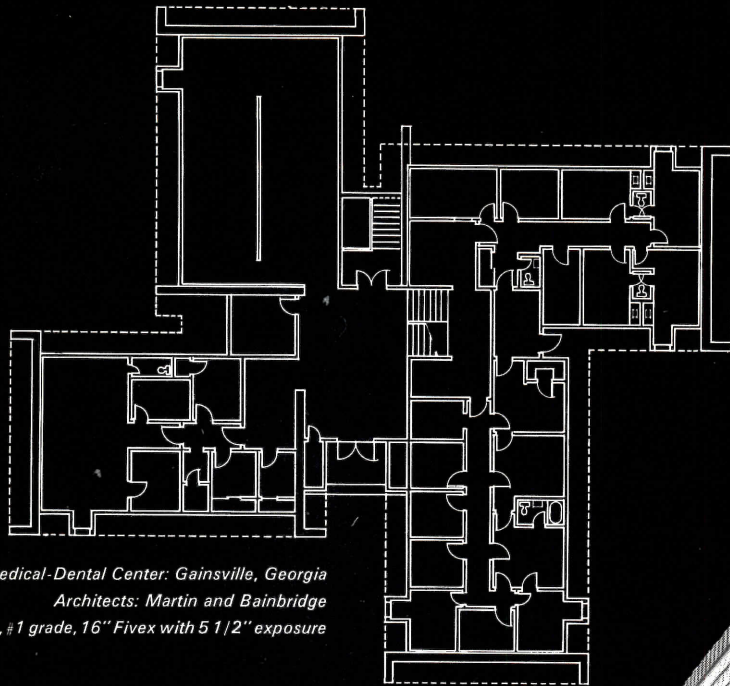

Medical-Dental Center: Gainesville, Georgia
 Architects: Martin and Bainbridge
 Certigrade shingles, #1 grade, 16" Fivex with 5 1/2" exposure

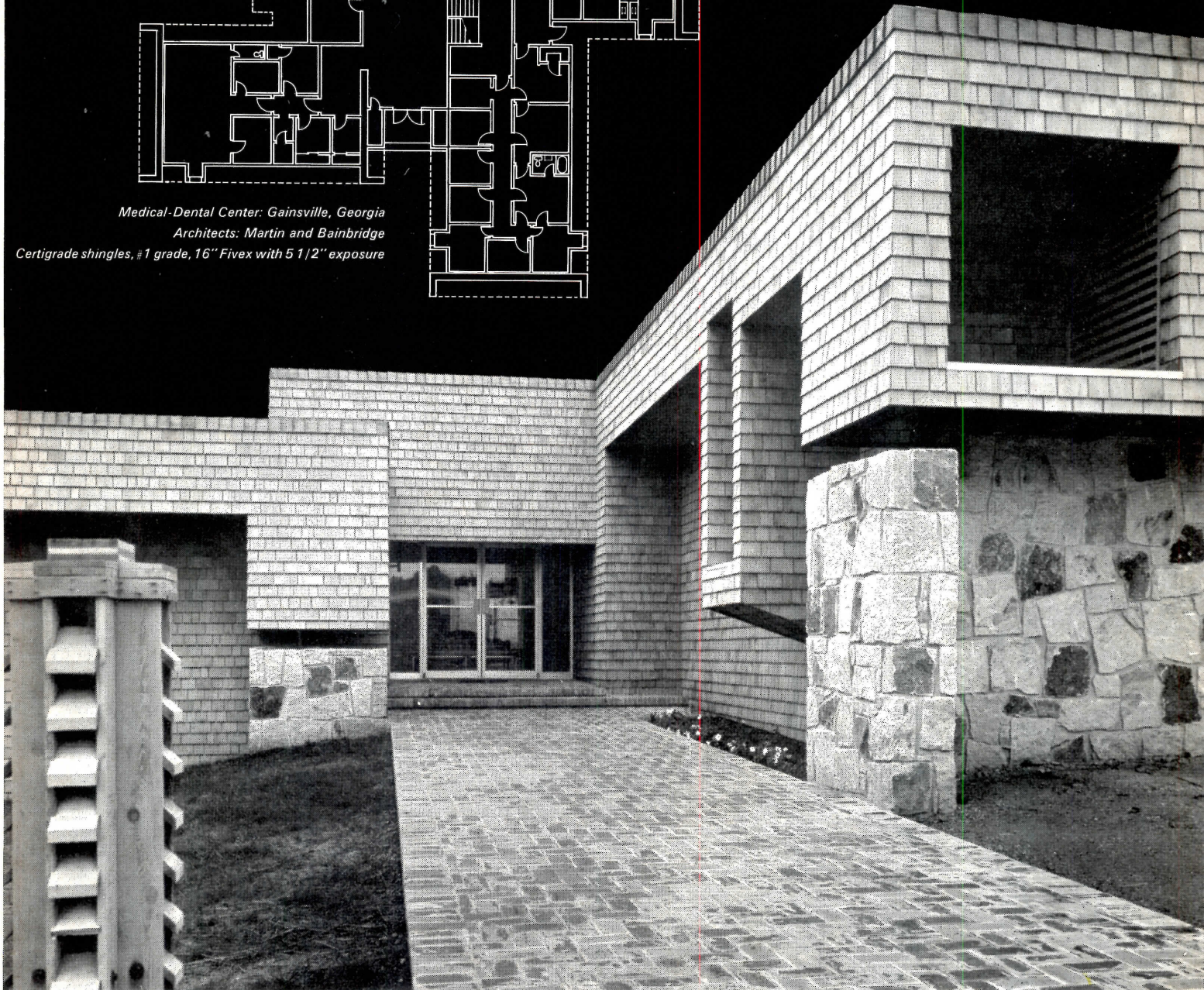

Red cedar shingles: beautiful prescription for a medical center.

Here's an instance where red cedar shingles were just what the doctor ordered.

For this new Georgia medical-dental building, Martin and Bainbridge, architects, created a design that dramatically combined recessed space and optically *linking planes* to achieve a sculptured feeling of exceptional strength, unity and beauty.

But to transform his design concept into

actuality, architect Frederick Bainbridge needed a flexible exterior-interior material capable of carrying the theme through onto interior walls, yet rugged enough to match the building's rough stone lower walls and supports. He selected red cedar shingles.

Why? Because only red cedar offers such a complete range of honest architectural benefits: pleasing natural color, subtle

textural patterns, uniformity, wind resistance, maintenance-free performance.

Reason enough to consider red cedar for your next job? For details on Certigrade shingles (or Certi-Split shakes), see our Sweet's Catalog

listing 21d/Re, write or call:

5510 White Building, Seattle, Washington 98101 (In Canada, 1477 West Pender Street, Vancouver 5, B.C.)



Red Cedar Shingle & Handsplit Shake Bureau

One of a series presented by members of the Forest Products Promotion Council.

T Panel le B th

Newest selling idea in baths
... exclusive from Formica!



A totally new look is now possible with FORMICA® brand Panel System 202. Smooth surface has no grout lines to get dirty, nothing to chip, crack or crumble.

New wall system package... panels, trim moldings and adhesive... goes anywhere moisture is a problem; baths, shower stalls, laundry rooms and kitchens. It's superior to tile in many ways; has no grout to clean, nothing to

crack or replace. No back-and-forth service calls to worry about. Available in 18 fashionable designs, woodgrains and marble patterns. Contact your Formica representative or write Dept. HH-19.

Center core of foam conforms to slight irregularities in subwall for firm, smooth installation.

Backing sheet insures permanent bonding to subwall.



Two-piece trim molding of heavy gauge extruded aluminum surfaced with matching FORMICA® laminate.

Panel face is durable FORMICA® brand laminated plastic. Maintenance-free: won't discolor; wipes clean with damp cloth.



Remodeling? FORMICA® Panel System 202 goes over almost any surface as is (even ceramic tile).

There are other brands of laminated plastic but only one

Leadership by design



Formica Corporation • Cincinnati, Ohio 45232 • subsidiary of



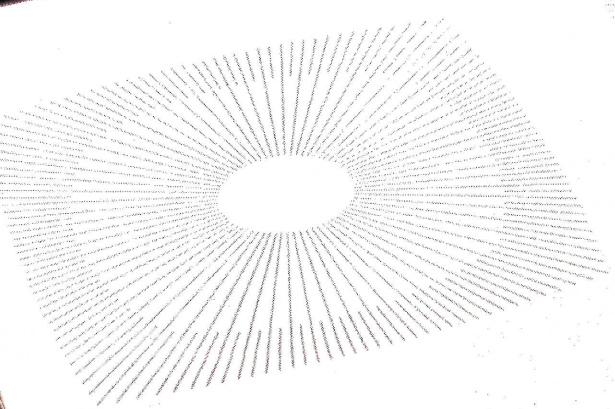
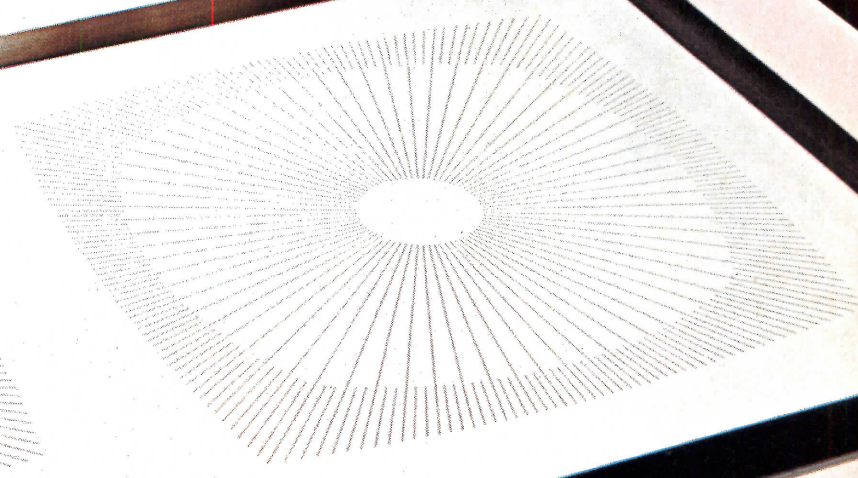
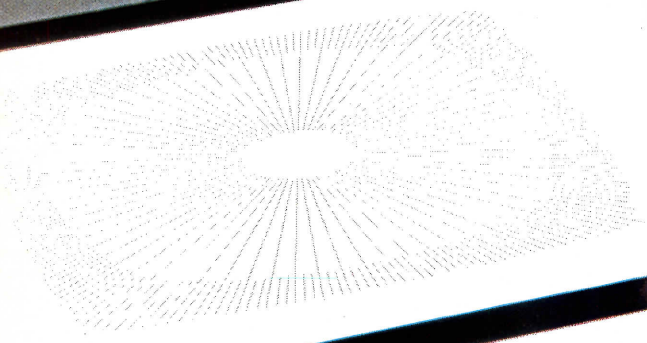
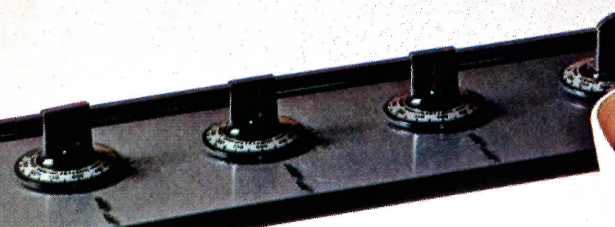

Corning started a counter revolution with Counterspace Cooking.

Way back in '66 Corning planted the seeds of its counter revolution with The Counter That Cooks. A smooth, easy-to-clean Pyroceram® cooking surface without coils, burners, or grease traps.

This was the beginning of Counterspace Cooking.

Today, thousands of installations later, we know we're a solid hit with the ladies. But we're not sitting back on our laurels. Instead, we've cooked up an entirely new idea in Counterspace Cooking.

See for yourself at the NAHB Show. Just follow the crowds to Booth #16-21.

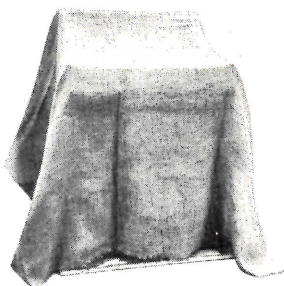

We have something new to show you.

CORNING

Announcing Airtemp's new line of in-wall room air conditioners

- Built to fit new or replacement installations.
- Designed to complement any room decor.
- Chrysler engineered for extra years of reliable service.

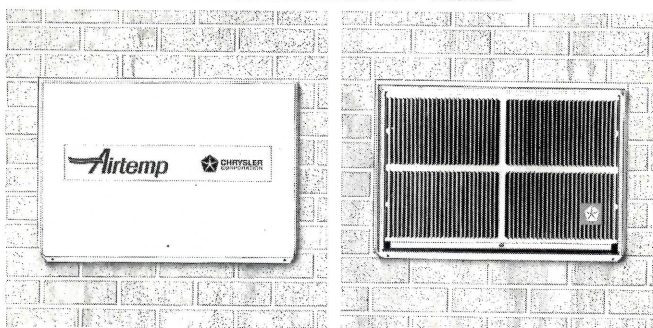
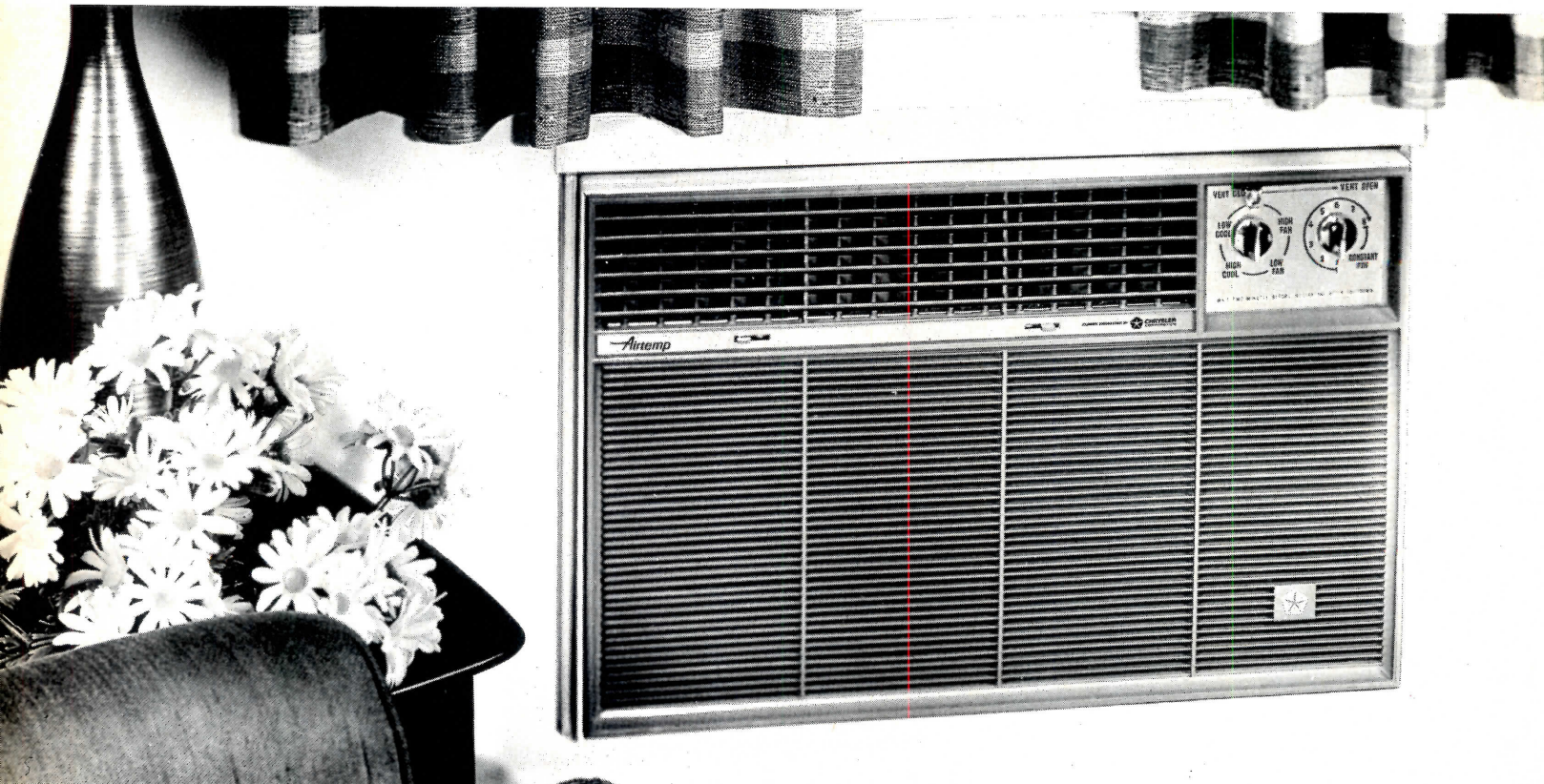

OUTSIDE VIEW. Sleeve without unit (left) and with unit (right). Eleven models. Only 23 $\frac{3}{4}$ " wide and 15 $\frac{1}{2}$ " high. Depth, 16" and 19". 6,000 through 13,500 BTU's. Fixed or telescopic sleeve. Telescopic sleeve expands to 10", contracts to 5 $\frac{1}{2}$ ". Mounts flush to inside or outside wall.

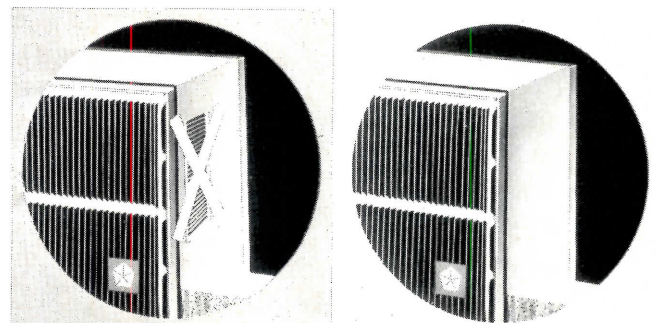

NO SIDE LOUVER. Combining condenser air inlet and outlet through rear-face area has permitted us to eliminate side cabinet air outlet louvers. Airtemp's development of twin-flow heat and moisture rejection maintains maximum efficiency even under varying operating conditions.

■ Chrysler Airtemp's new line of in-wall air conditioners are designed for hotels, motels, apartment and office buildings. For new installation, they're sized to block, brick and most other construction standards. For replacement, they'll fit virtually any sleeve.

The line has unitized construction for strength and vibration-free performance. Thorough protection against rust and corrosion, preventing outside streaking. Thermal insulation to absorb sound and prevent

external sweating. Get all the facts. Write Chrysler Airtemp, Builder Division, 1600 Webster Street, Dayton, Ohio 45404.

Airtemp



CHRYSLER CORPORATION

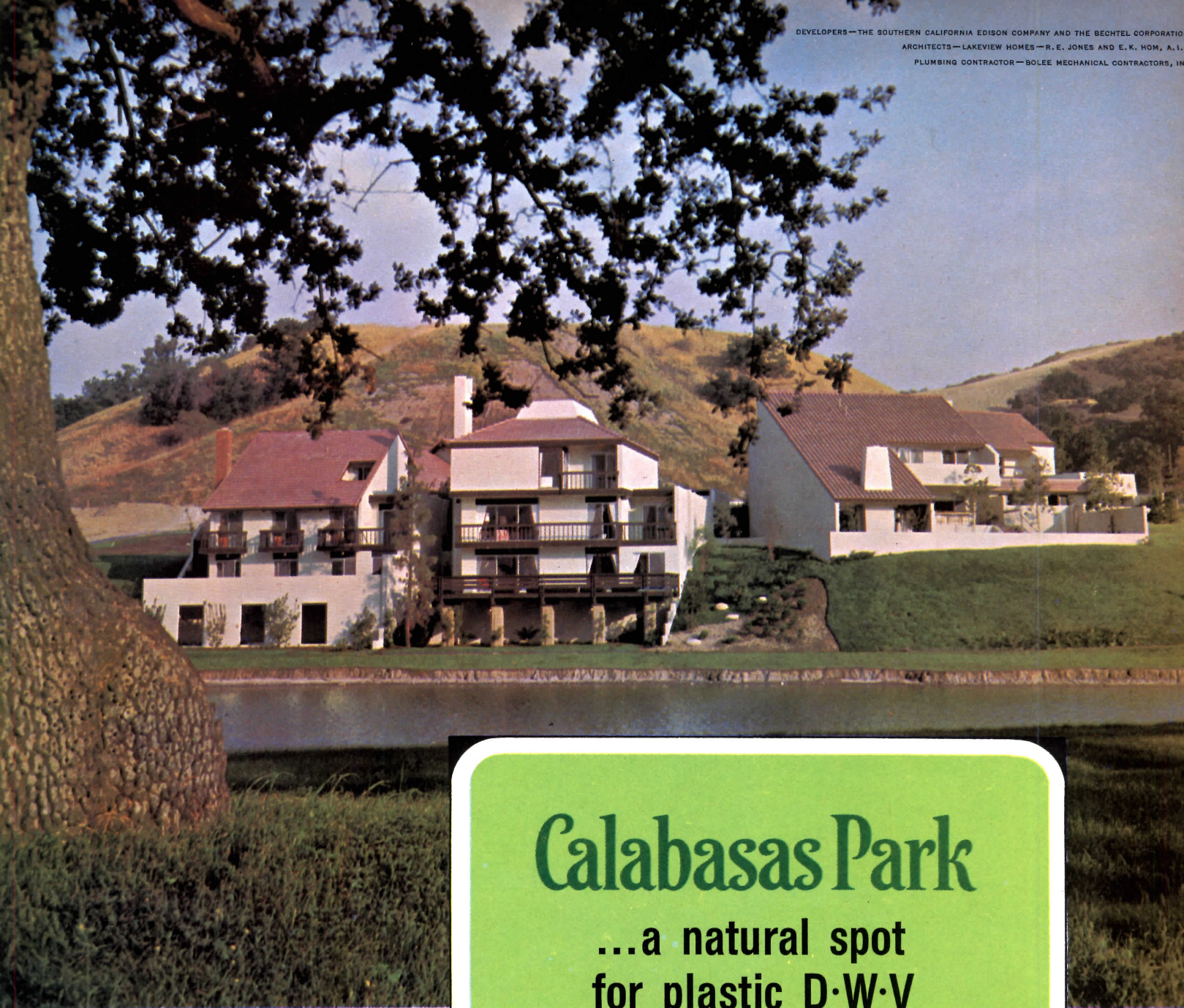

Calabasas Park

...a natural spot
for plastic D·W·V

Calabasas Park sprawls over the rolling foothills of the Santa Monica Mountains — one of the most luxurious developments in Southern California. The first units—Lakeview and Estate Homes — carry an average \$80,000 price tag, with some homes ranging up to \$100,000 or more. Future owners of the 4,000 dwellings planned for Calabasas Park will enjoy their own lake, golf course, tennis club, and many other appurtenances of affluent living.

Cost was no object in selecting the finest materials and appointments for Calabasas Park homes. If gold-plated drain/waste/vent systems were the best, the developers would undoubtedly have chosen gold-plate. The fact is, they chose plastic DWV with GSR fittings. This choice of the best DWV material simplified the complex plumbing installations. Each of the homes has three to five bathrooms and built-in laundry facilities, requiring at least three times the pipe and fittings used in ordinary houses. The DWV sub-assemblies were completely pre-fabricated before installation.

Incidentally, the builders saved \$100 per house by specifying plastic DWV and GSR fittings. This may seem insignificant in an \$80,000 house; yet this "trifle" will amount to nearly half a million dollars saved by the time Calabasas Park is completed.

Whether you build luxury homes or low-cost housing, you too can save money on the best drain/waste/vent system — plastic pipe with GSR fittings. Write for the new booklet describing the many applications of plastic pipe in homebuilding. R. & G. SLOANE MFG. DIV., THE SUSQUEHANNA CORP., 7606 N. Clybourn Ave., Sun Valley, Calif. 91352.



PLASTIC PIPE FITTINGS



See us at booth number 3447 NAHB Show

You are cordially invited to enter the 1969 Homes for Better Living awards program for architects, builders and homeowners

Sponsored by The American Institute of Architects in cooperation with HOUSE & HOME and *American Home*. All the award winners will be published in HOUSE & HOME. A selection of the winning entries will be published by *American Home*. All the winning entries will be displayed at the AIA convention in Chicago, Ill., and at the Octagon in Washington, D.C.

Houses and apartments must be designed by a registered architect and built and completed since January 1, 1966 in any of the 50 states. Outstanding architects, housing industry leaders, and the editors of HOUSE & HOME and *American Home* will judge the entries. Awards will be made on the basis of outstanding contributions to better living through residential design, site planning, and construction. Winners will be displayed at the AIA convention June 22-26, 1969. Awards will be made in three categories: CUSTOM HOUSES designed specifically for an individual owner, in three classes according to size: a) Under 1,600 sq. ft. of living space, b) 1,600 sq. ft. to 2,800 sq. ft., c) over 2,800 sq. ft. MERCHANT-BUILT HOUSES designed for a merchant builder and sold

speculatively, in three classes according to sales price including land: d) under \$25,000, e) \$25,000 to \$40,000, f) over \$40,000. GARDEN APARTMENTS AND TOWNHOUSES built for rent or sale. Apartments shall not be over three stories in height from grade, must comprise four or more living units, and may be single buildings or one of a group: g) single apartment buildings, h) multi-building apartment groups, i) townhouses. Pertinent information shall be submitted on the registration blank below (or a facsimile) by March 2, 1969, accompanied by a payment of \$10 for each house or apartment entered. Any number may be entered. A separate registration blank must be submitted for each. Upon receipt of registration blank and fee, each entrant will be sent for each house or apartment entered an 8½" x 11" binder and full instructions for preparation. It must be completed and postmarked no later than April 6, 1969. It is important that the appropriate category be designated on your original registration slip so that you receive the correct color binder for your entry.

This registration slip and entry fee must be submitted by March 2, 1969. Make checks payable to: Homes for Better Living and mail to Homes for Better Living Awards, HOUSE & HOME, McGraw-Hill Publications, 330 West 42nd Street, New York, New York 10036.

Enclosed is check money order in the amount of \$10 covering the entry below.

category: CUSTOM-BUILT HOUSE MERCHANT-BUILT HOUSE GARDEN APARTMENT/TOWNHOUSE

location _____

architect _____ address _____

builder _____ address _____

owner _____ address _____

submitted by _____ address _____

Labor Shortage Threatens Builders

**Crane-erected
National Homes
Will Solve
Manpower
Problems**

**Top home manufacturer
to demonstrate
advanced home
building technology at
NAHB
Exposition
in Houston
January 13-17**

You'd expect National Homes Corporation to provide a workable solution like this to the builder's most critical problem—the manpower shortage. National Homes is the industry's leader in advanced home building technology.

To make a good thing even better, we've installed cranes on our delivery tractors. You have no scheduling problems. No expensive delays. The moment the tractor arrives, you're ready for a profitable day's work.

You'll turn your houses faster with fewer workers . . . with lower costs for construction money . . . with top quality guaranteed by manufacturing methods that set the pace for the entire industry.

For 1969, National Homes offers as an option the industry's only complete selection of crane-erected homes, open or closed frame . . . from our collection of distinguished homes.

It's a big step forward in National Homes' TOTAL SERVICE to help builders make money.

Put our advanced home building technology to work for you today. Send us the coupon below. Let's talk.

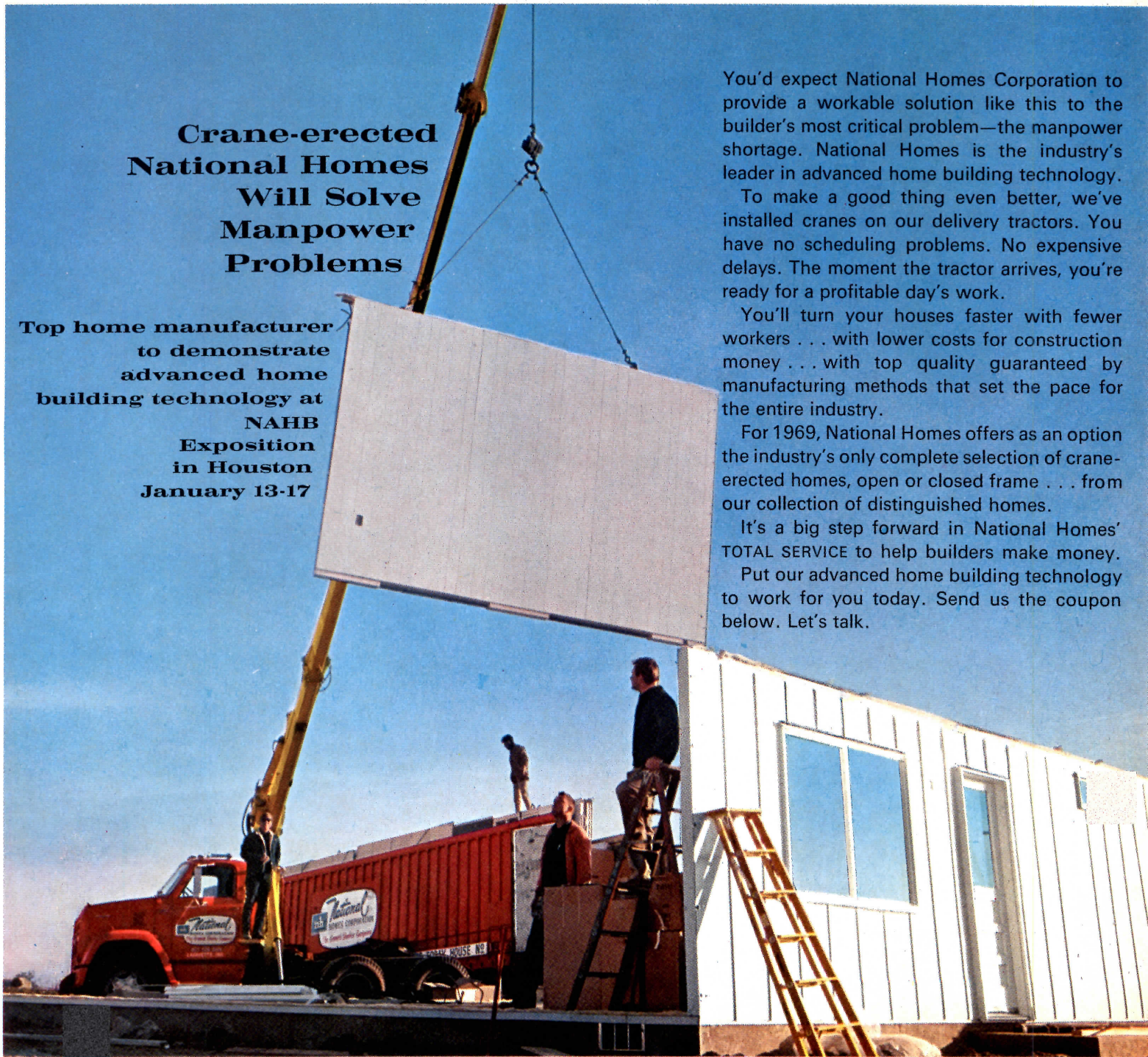

**HOMES CORPORATION
THE GROWTH SHELTER COMPANY**
Plants: Lafayette, Ind.; Horseheads, N.Y.;
Tyler, Tex.; BEST, Effingham, Ill.; LESCO,
Martinsville, Va.; KNOX, Thomson, Ga.



**Fill out coupon
and let's talk**

**See Our Crane
Erection Methods
Demonstrated at
the Astrohall
Get details at
BOOTH
3609-3611**

Jim Price, Board Chairman
National Homes Corporation Lafayette, Indiana
Okay, Jim, I'm interested. I have _____ developed lots.
I need construction permanent financing.

NAME _____
COMPANY _____
ADDRESS _____
CITY _____ STATE _____ ZIP _____

Leigh products

help you cut costs all through the house ...
then help you sell it!

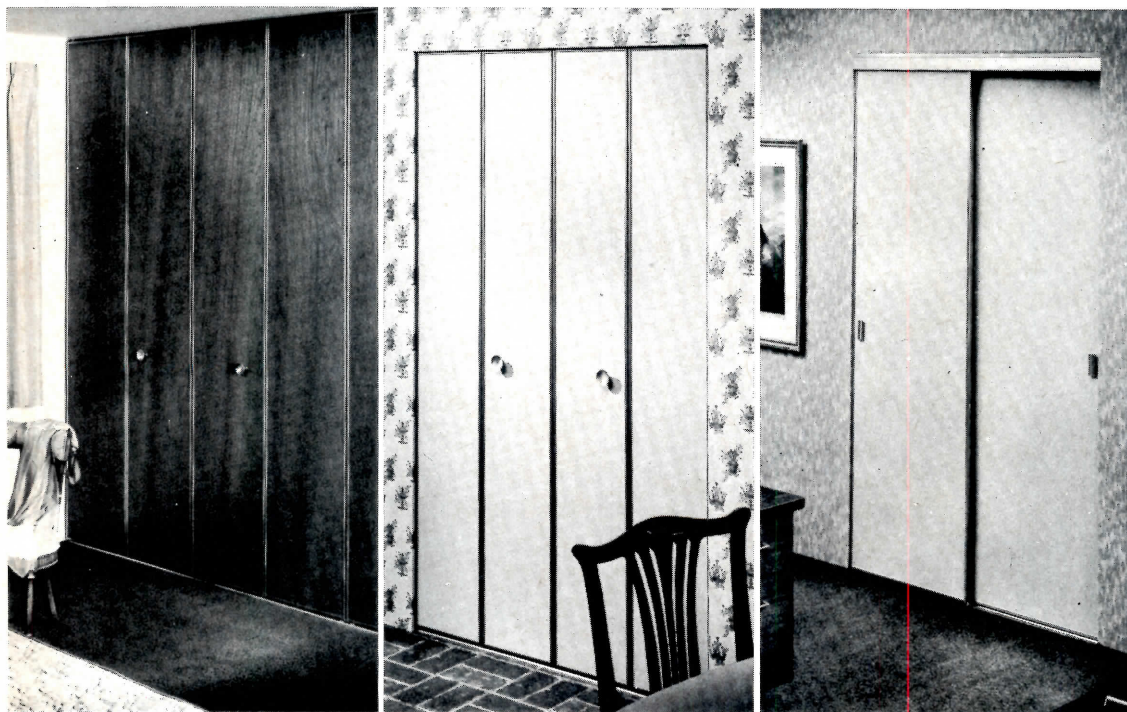

New closet doors combine the beauty of wood with the warp-proof rigidity of a steel frame.

The beauty of natural wood—plus the strength of steel framing—this is the exciting construction in new Leigh wood panel doors—bi-fold and by-passing models as shown at left. The look is luxurious! The touch is warm. The doors have all the appeal of natural wood with the added advantage of a warp-proof steel frame. A gear lever on the by-passing doors simplifies raising, lowering, levelling the doors—without tools. Bi-fold doors feature the famous balanced suspension used on Leigh steel doors. The new wood-panel doors are offered in 6'8" or 8'0" heights. Panels of Philippine mahogany finished in warm walnut or frosty platinum. Or panels in primed white hard-board for final painting or papering. Be sure to see these attractive, labor saving—money saving doors. Call your supplier today.

Circle 15 on Reader Service card

New Leigh power roof ventilator

cools attic fast, keeps it cool. The new Leigh power roof ventilator is controlled by a thermostat—turns on when attic temperature reaches 100°F., shuts off at 85°F. The big 10" diameter, nine-bladed fan, powerful electric motor, and thermostat are built into a power pack unit that slips into famous, patented, Leigh roof vent—in aluminum or galvanized steel. Low silhouette on roof—only 6" high. Efficient, quiet.

Circle 16 on Reader Service card

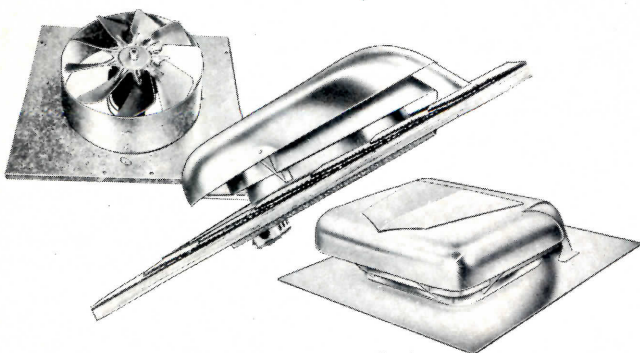

Leigh makes more than 160 products for the building industry



LEIGH PRODUCTS, INC.

2569 LEE STREET, COOPERSVILLE, MICHIGAN 49404

East Coast Warehouse: Leigh Corp., Edison, New Jersey. **West Coast Warehouse:** Leigh Industries, Inc., City of Commerce (Los Angeles), California. Leigh products made in Canada and available in Canada.

Visit the Leigh booth, No. 2439-2443
NAHB Convention, Houston, Texas, January 13-17.



New ideas sell homes.

The newest ideas come from Kemper.

If you're looking for that extra something to give your homes and apartments more customer appeal . . . talk to your nearby Kemper Distributor. This year Kemper is offering more design and more convenience features than ever before.

design. In addition to the exciting new Tiara Kitchen in shaded maple (pictured above) you may choose English Oak, Traditional Fruitwood or

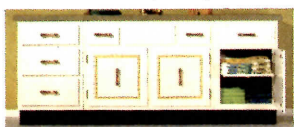

Colony Line Cherry. A complete selection of decorator styled bathroom vanities is also available.

features. How's this for a starter? Built-in cutlery drawers, self-centering lazy susans, roll-out shelves, roomy broom closets, the latest hardware ideas, self-closing hinges, do-it-yourself door front decorating options and the exclusive Kemper "mini-pantry."

construction. Here's where you, as a builder, will recognize Kemper quality. Everything about Kemper, including mor-

tise and tenon joints, glue blocking, baked on finishes and full frame construction, will tell your customers something about the value you are offering. This is only part of the Kemper story. See your nearby Kemper Distributor for all the facts and a first hand look at America's most competitively priced kitchen cabinet value. Kemper Brothers, Inc., Richmond, Indiana 47374.



Kemper

"Artistic Brass has worked into our picture very successfully"

ALFRED H. MAYER

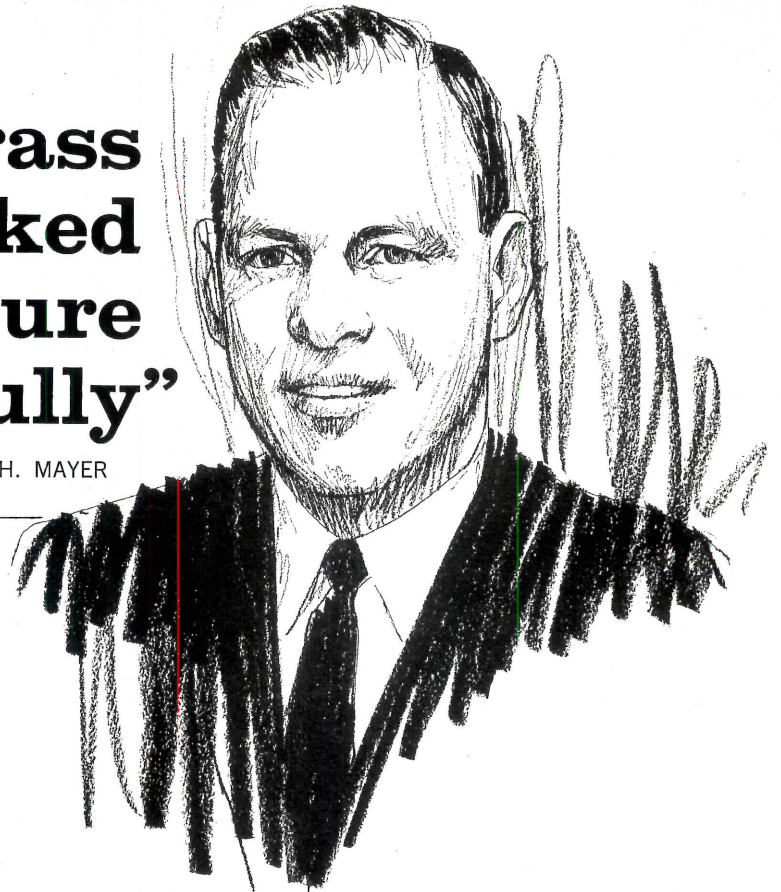

ALFRED H. MAYER CO.
3220 PARKER ROAD
FLORISSANT, MO. 63033
TEMPLE 7-0707

March 15, 1968

Mr. Tom Simons
3148 E. 11th Street
Los Angeles, California 90023

Dear Tom,

As you know, we of the A. H. Mayer Company have used Artistic Brass fixtures for approximately three years in some three different projects.

On the outset of this venture, we used the 800L in Polished Brass and Polished Chrome, and then to the 80 and 81L, both in Polished Brass and Polished Chrome.

Now, to our pleasure, the advent of the package program has answered many problems in the design and construction of at least one bath in each house. We have gone entirely to the 5-C package in Polished Brass for several reasons.

1. It's design is very elegant for the money spent.
(Our cost is less than \$80.00)
2. It is packaged in one carton, making stocking and installation very simple.
3. We very often upgrade other baths in the same house, at an option, because of the one bath in brass.

Our houses range in price from \$24,950.00 to approximately \$34,500.00 with our volume being at the low end.

Our locations for the most part, are away from, but again very close to incorporated areas, giving access to shopping centers, schools, churches and etc.

All in all, Artistic Brass has worked into our picture very successfully in the past three years and will continue to work in the future.

Sincerely,

ALFRED H. MAYER COMPANY

Alfred H. Mayer
Alfred H. Mayer
President

AHM:mm

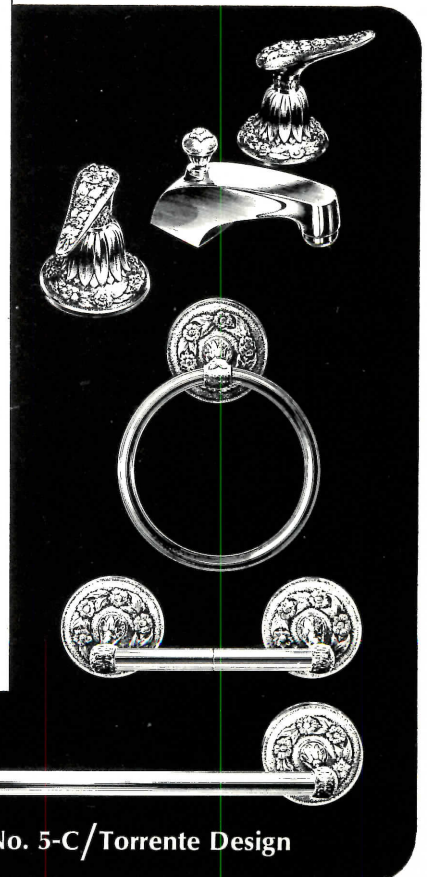

ARTISTIC BRASS, INC.

3136 East 11th Street, Los Angeles, California 90023

Builder Package No. 5-C/Torrente Design

Pre-decorate with new **DECOBEAMS** T.M.



REINFORCED PLASTICS DIVISION
REICHOLD CHEMICALS, INC.
20545 CENTER RIDGE ROAD
CLEVELAND, OHIO 44116

Interior designed by Arthur Elrod, AID, for John Strauss Showrooms

An inexpensive way to make your homes sell faster

Build the rustic charm and sales appeal of exposed beams into your homes for a fraction of the installed cost of wood. DECOBEAMS are lifelike reproductions of rustic beams authentic in every detail down to deep graining, knotholes, and ax marks. Rugged Urethane foam composition works easily — cut it, saw it, drill it — yet it weighs approximately 10 lbs. for a 20 foot beam compared to hundreds of pounds for wood. That means that you can complete a room in as little as an hour or two. And DECOBEAMS are termite-proof, rot and fungus resistant. Once they're up, they never need attention again. ■ Available in convenient lengths to fit your requirements. Sizes: 4" x 6" and 2¾" x 4½". ■ Three lifetime finishes: Madera, dark; Heritage, medium; and Natural that can be stained any color. ■ *Made by the manufacturers of Alsynite®/Structoglas®*

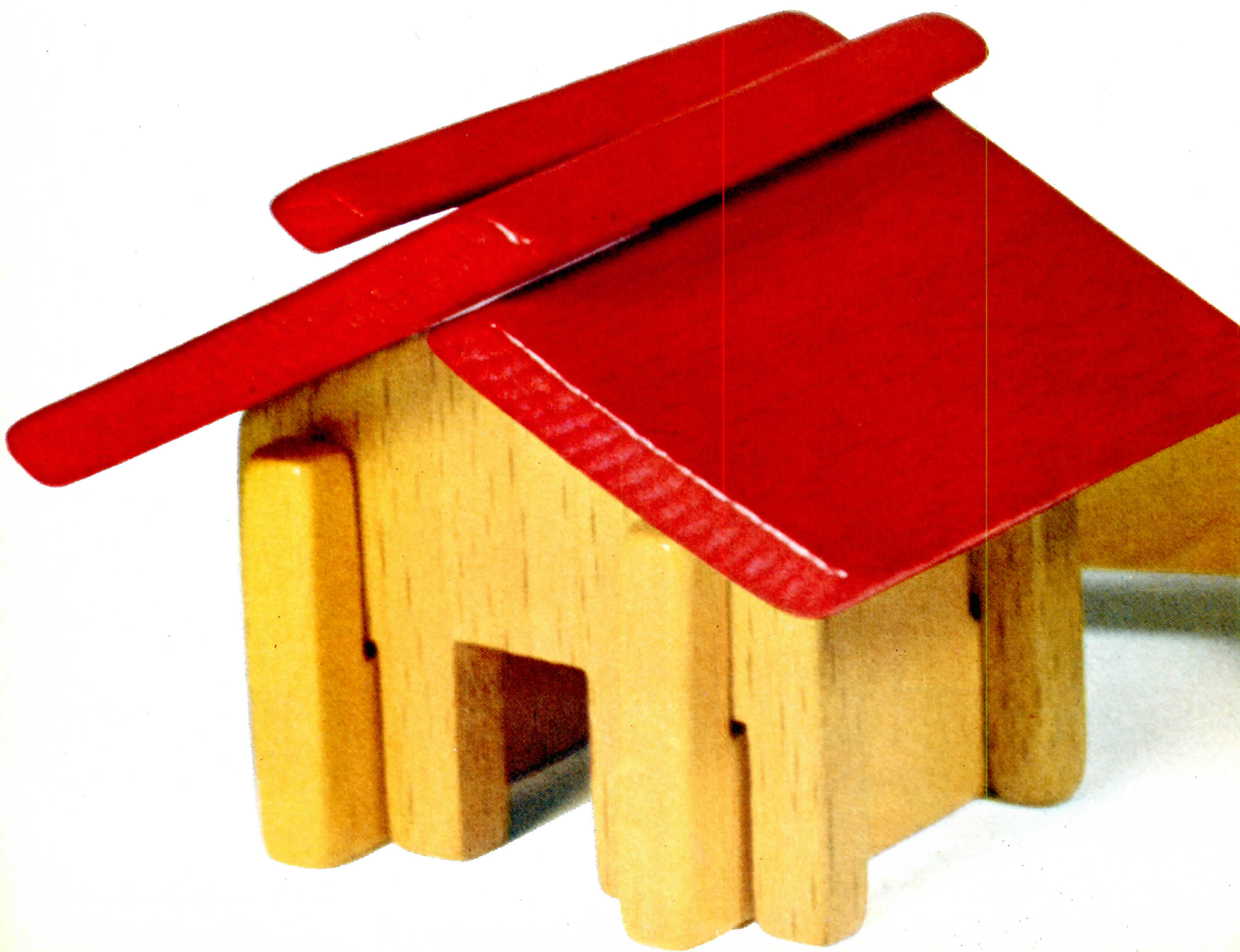

Answers to Question.

Take our plywood, and particleboard. You can make lots of basic things out of them, like sub-flooring and ping-pong tables.

Take our new Boise Cascade Sidings. Tough. Practical. Money-saving. Even beautiful.

Take our ceiling systems and laminated beams. They make for some distinctive finishing touches.

Take our Rough-Sawn Philippine Mahogany. We've come up with an impressive variety of patterns on nice, big 4' x 10' panels.

But, forget about wooden animals. They don't come in a much larger scale.

BOISE CASCADE BUILDING PRODUCTS

Boise, Idaho



Lumber, Plywood, Laminated Beams, Ceiling Systems, Hardboard Sidings, Rough-Sawn Sidings, Interior Paneling, Insulation Board Products, Insulating Wool, Particleboard.





Mr. and Mrs. T. J. Ryan, Residence, Columbus, Ohio
 Architect: McGee and Albert, AIA
 Builder: Rankin & Thoman



If you're looking for quality get Malta's price first

Compare Malta Wood Windows with any name brand you've used. Feature for feature, Malta equals or exceeds any window on the market. Then check the competitive price. You'll know why we're celebrating a 270% growth in ten short years.

Check the quality, the service behind our product and the favorable central location that eliminates long distance shipping when you're in a jam. Get to know our growing family of qualified distributors and dealers. Find out what Malta can do for you.

Malta offers a complete line: double hung, casement, awning and hopper type vents, glide and a variety of picture window units; patio doors with velvet smooth action. Malta's popular insulating glass seals out noise and climate conditions. Vinyl boot glazing typifies the quality Malta incorporates in these windows.

Write for free catalog. Malta Manufacturing Company, 261 Johnstown Road, Gahanna (Columbus) Ohio 43020.

Malta

Celebrating ten years of consistent growth

M208

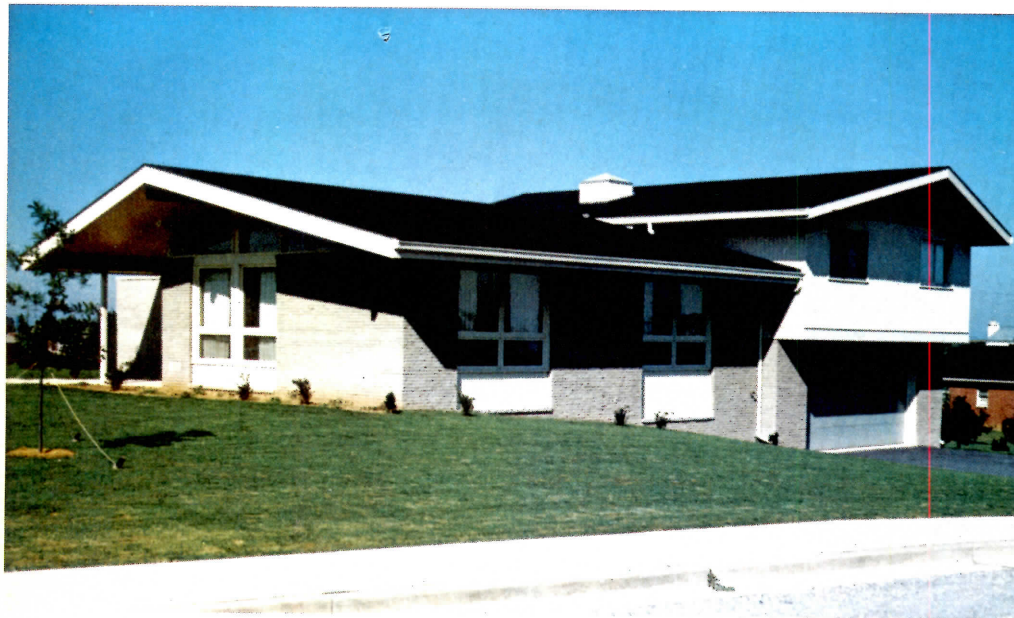

Washington Square Apartments, Columbus, Ohio • a CONVEST community • Architects: Liebersbach Swiatek & Grutsch, Columbus, O.

EDITORIAL

*Rhetoric or reality?***All right, you guys, 26 million new and rehabbed dwelling units in the next ten years. Right? Wrong, just think a bit**

Would our nation pay the price? Estimates of the cost of those 26 million units, in current and inflated dollars up to 1980, and including all the ancillary facilities that go with new housing, like streets, schools, water, etc., run as high as \$1 trillion—one thousand billions of dollars. It is extremely questionable, on the face of it, that this nation would deliberately volunteer such an economic commitment to housing in the next decade. That sort of commitment would be roughly akin to the national effort we put into arms and ammunition in World War II. However, what makes that commitment so interesting at this point is the Housing Act of 1968. Section 1602 of the act says:

"Not later than January 15, 1969, the President shall make a report to the Congress setting forth a plan, to be carried out over a period of ten years (June 30, 1968, to June 30, 1978), for the elimination of all substandard housing and the realization of the goal (26 million housing units) referred to in section 1601. Such plan shall . . .

". . . indicate the number of new or rehabilitated housing units which it is anticipated will have to be provided, with or without government assistance, during each fiscal year of the ten-year period, in order to achieve the objectives of the plan, showing the number of such units which it is anticipated will have to be provided under each of the various federal programs designed to assist in the provision of housing. . ."

Section 1602 goes on to require that the President show the yearly cost of the plan for each fiscal year in the decade, what legislative and administrative changes will be necessary, and where the mortgage money will come from. Then in 1970, says Section 1603, the President will have to compare housing progress in 1969 with the plan set forth this month and explain why we fell short of '69's goal (as we did) and what we can do to make the plan work.

Title XVI of the Housing Act of 1968 (which contains sections 1601, 2 and 3) is a good title particularly because it may teach the Congress and the Administration some of the myriad complexities in producing improved realty. If they learn their lesson well, we should be able to get more results from new housing programs.

Title XVI is also a good title because it may prove the folly of promising too much to people who need so much. No one has condemned this folly more logically than Anthony

Downs, of the Real Estate Research Corp. of Chicago, who wrote last year for The Brookings Institute:

"A fair appraisal must take into account the dilemma faced by responsible politicians in our democracy. In order to overcome widespread Congressional and public resistance to new expenditures, the administration is tempted to exaggerate the potential effectiveness of anything it proposes. It therefore makes rhetorical promises that each new program will provide a 'total solution' to the problems concerned. The anti-poverty program will 'end' poverty; the Model Cities program will 'completely renovate' slum areas; and HUD's housing programs will 'wipe out' substandard housing—all in the very near future.

"These rhetorical claims are patently false to anyone who knows much about each of the problems concerned. Moreover, they have a devastating long-run impact upon the citizenry's confidence in government programs—and even authority in general. For such claims at first tend to generate great expectations among the relatively-poorly-informed persons suffering from the ills concerned. *But repeated disillusionment eventually induces a deep cynicism towards all government programs* [our italics]. By now this cynicism has become almost universal. Even though most federal programs actually produce many benefits, they inevitably fall far short of carrying out the promises made in order to get them passed.

"In setting a goal of 26 million new or rehabilitated units in the 1970s, including six million publicly assisted units, Congress and HUD have once more engaged in this gambit. They have substituted rhetoric for reality, thereby almost guaranteeing the 'failure' of their own programs—not to make substantial achievements, but to reach the over-optimistic goals they have set. I sympathize with their desire to spur the nation to higher housing production by setting idealized targets beyond our present capacity. Moreover, I believe that a great many of the policies that society would have to adopt to reach those targets are probably well worth doing sooner or later. And the sooner we adopt many of them, the quicker we can actually achieve the national housing goal of 'a decent home and a suitable living environment for every American family.'

"Nevertheless, I believe our housing targets should be both more realistic and more flexible."

We couldn't agree more.

—RICHARD W. O'NEILL



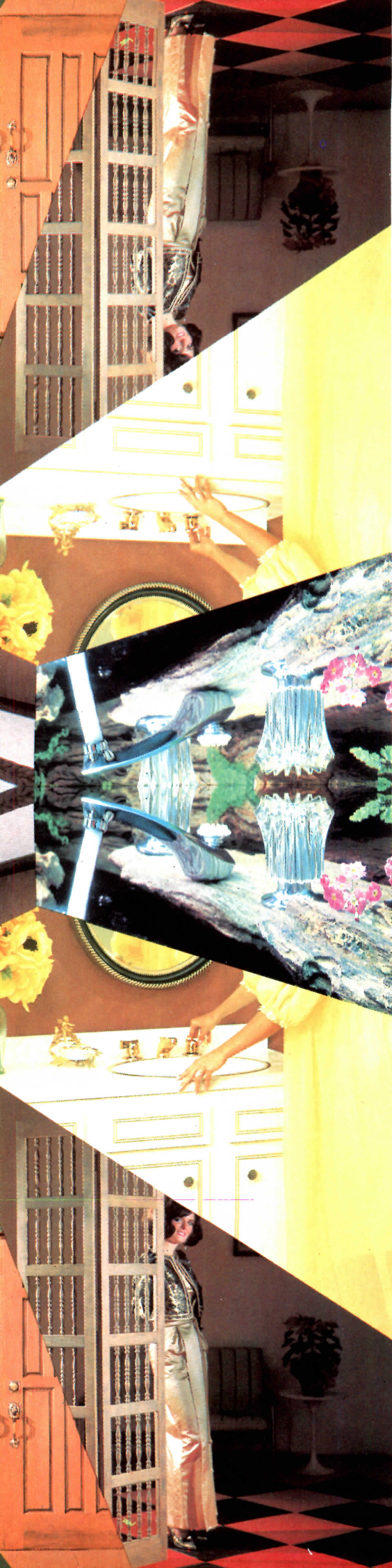

A Kaleidoscope of New products for 1969

New materials and equipment are the basic ammunition of marketing. They can provide the extra appeal that lifts your house or apartment out of the "4 bdrms, 2½ bths, fam rm, mod kit" category and gives it a competitive edge.

If your buyers or renters are mostly desperate transferees who must have a place to live by next Monday, you don't have to provide much more than cubage. But if — as is more likely — they are families who have time to be choosy, know what they want and can pay for it, you'll have to do better.

So this kaleidoscope of new products is actually a panorama of sales-building ideas. To create it, HOUSE & HOME asked 2,300 manufacturers for their latest product innovations. The best of an excellent lot is shown on the following pages.

Here is what you will see: doors and windows (*p. 70*), interior finishing materials (*p. 72*), bathroom equipment (*p. 74*), exterior materials (*p. 76 and 108*), lighting fixtures (*p. 77*), flooring (*p. 78 and 128*), kitchen appliances and cabinets (*p. 80 and 126*), heating and air-conditioning units (*p. 110*), construction tools (*p. 114*), outdoor equipment (*p. 122*), water-treatment equipment (*p. 124*), structural materials (*p. 124*), plumbing and piping (*p. 130*) and electrical equipment (*p. 132*).



1



4

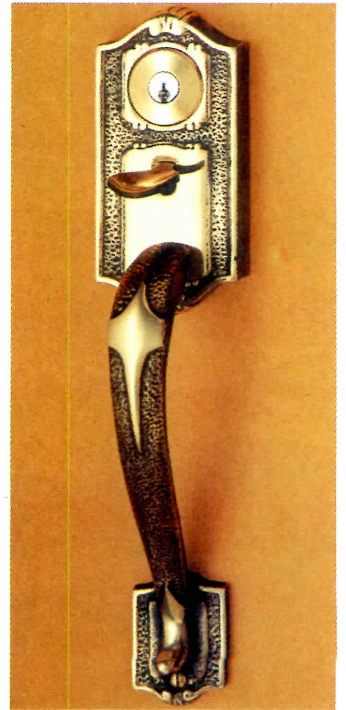

5



6

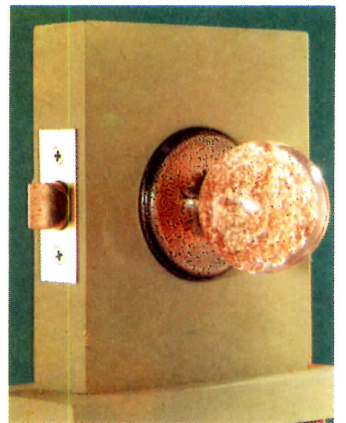

7



2



3

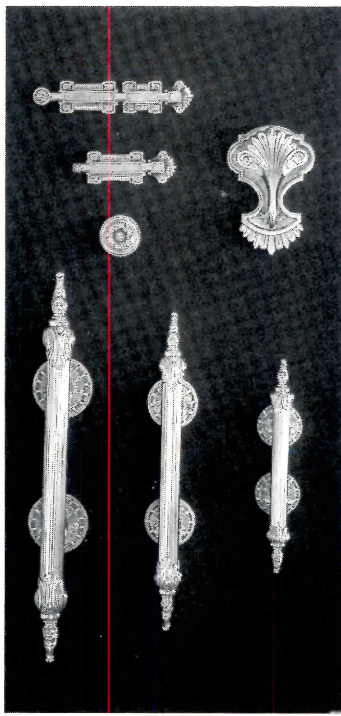

8



9

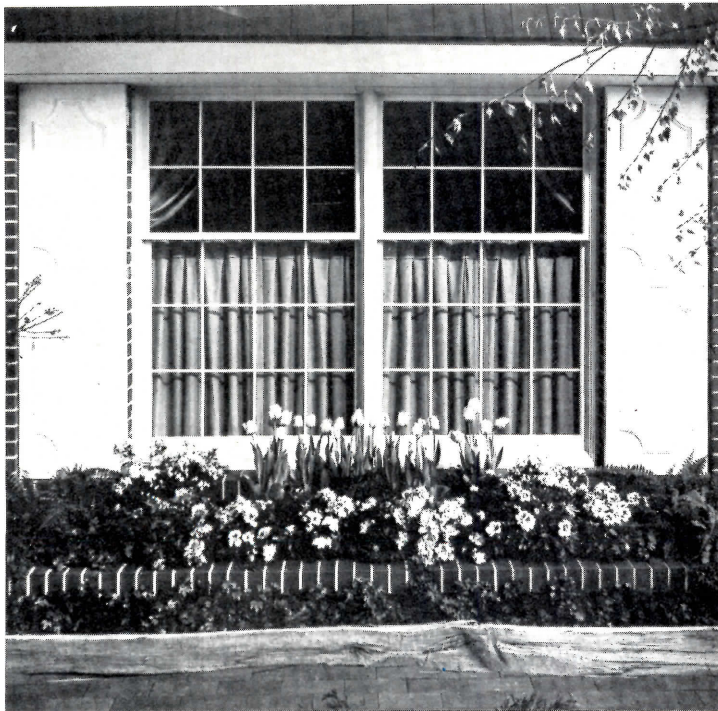

10



11



12 JANUARY 1969

NEW PRODUCTS

doors & windows

1 Carved doors, solid fir or hemlock, have nine panels and a floral design. One of three new doors that will be added to the existing line. Primarily for exterior use, they can also be used indoors, singly or in pairs. Two sizes: 2' 8" x 6' 8" and 3' x 6' 8". Simpson Timber, Seattle, Wash. Circle 200 on Reader Service card

2 Louvered bifolds are 6' 7" high, come in 2' 6", 2' 8" and 3' widths for two-door units, 3', 4', 5' and 6' widths for four-door units. Preset for standard openings, they have adjustable and reversible factory-installed fascia strips and hardware. Jessup Door, Dowagiac, Mich. Circle 201 on Reader Service card

3 Spindle bifold comes in two styles: all spindles as shown or with two bottom panels of raised solid wood. Made of 1 1/8" vertical grain hemlock, they may be painted or stained or backed with fabric, wallpaper or plastic panels. Three widths are available: 1', 1' 3" and 1' 6" (three, four and five spindles wide). All are 6' 8 1/2" high. E. A. Nord, Everett, Wash. Circle 202 on Reader Service card

4 Pre-hung doors have a polyurethane core for insulation, non-warp steel faces and vinyl-clad tops and edges. Magnetic vinyl gaskets create a tight seal and quiet closing. Doorways, in singles or doubles, are available in 30 styles. Berry Doors, Birmingham, Mich. Circle 203 on Reader Service card

5 Entry handle, colonial in design, is available in hand-rubbed brass as shown or in antique bronze or silver with companion inside lever handle. Weslock, Los Angeles. Circle 204 on Reader Service card

6 Warp-free shutter is lightweight and damage-resistant. Moulded of plastic, it has no seams or removable louvers, can be painted but it is not necessary because the fade-resistant colors—black, dark green and white—are integral in the plastic. Shutter snaps onto clips fastened to siding or to mortar joints. H C Products, Princeville, Ind. Circle 205 on Reader Service card

7 Decorative knob looks like glass but is less fragile. It comes in clear or white gold, olive or clear crystal, and can be combined with a metal rosette in any of the manufacturer's finishes. Weiser, South Gate, Calif. Circle 206 on Reader Service card

8 Brass hardware, hand-crafted in Spain, is part of a 170-item line for use on the front door and throughout the house and complements the manufacturer's line of bathroom accessories and fittings. Finishes: polished brass, antique brass, nickel or 24-kt. gold. Artistic Brass, Los Angeles, Calif. Circle 207 on Reader Service card

9 Extra-wide door for interior—as shown—or exterior use, is 3' 6" wide. Steel-clad with a foam core, it cannot warp, twist, shrink or swell. Shipped pre-hung in a frame complete with magnetic weatherstripping and an adjustable sill/threshold. Height: 6' 8". Pease, Hamilton, Ohio. Circle 208 on Reader Service card

10 Vinyl-clad sash surrounds low-maintenance wood window now offered for double-hung installations in addition to the manufacturer's line of casement and gliding windows. Available in 42 sizes to be used singly, in multiples, in picture-window combinations, in bay or bow frames. Andersen, Bayport, Minn. Circle 209 on Reader Service card

11 Steel bifolds are finished in driftwood white baked enamel. The sculptured panel door at the far left is the newest addition to a line of ten styles, all of which come with special hardware and nylon bearings for durability and quiet operation. Available in many widths and heights. Ternes Steel, Roseville, Mich. Circle 210 on Reader Service card

12 Patio door unit is shipped pre-hung, includes warp-free door and matching single, double, or multiple 34"-wide ventilating sidelights. Sidelights include lever-operated hardware and full-length screen panels with gold frames. Fully insulated, the doors are 1 3/4" thick, sealed for sound and fire rated. Pease, Hamilton, Ohio. Circle 211 on Reader Service card



1



4



2

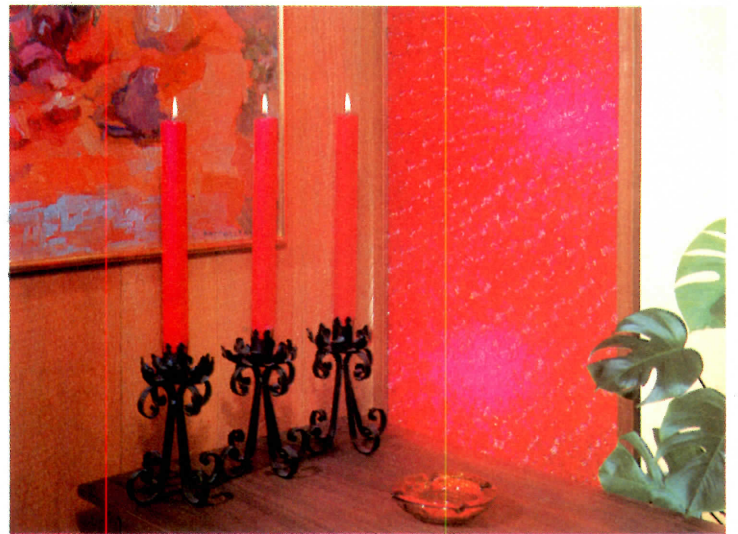

5

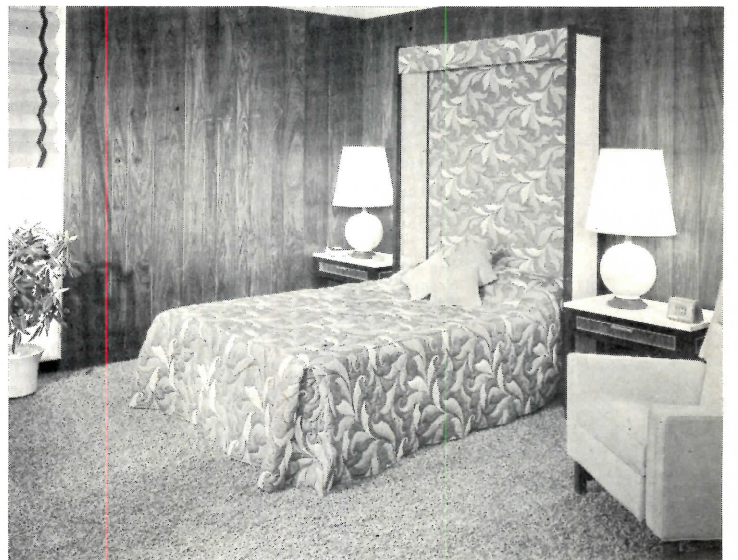

6



3



7



8



9



10

NEW PRODUCTS

interiors

1 Vinyl tackboard, in square- or bevel-edged panels of 4' x 8', 9' or 10', can be glued to plaster, wallboard or plywood. Laminated vinyl facing will hold tacks and pins, and holes won't show when pins are removed. Eight colors are available: beige, moss green, fern haze, pebble, Spanish gold, smoke white, driftwood and marigold (above). Kaiser Gypsum, Oakland, Calif.

Circle 212 on Reader Service card

2 Prefinished panels, 4' x 8', have one-piece core. Nine finishes of hardwood veneer are available (eight are shown): Canadian birch, English oak, Norwegian oak, Spanish pecan, Turkish pecan, Danish walnut, French elm, Irish elm and Italian cherry. States Veneer, Eugene, Ore.

Circle 213 on Reader Service card

3 Solid redwood is finger-jointed of short pieces in planks up to any length desired. Normally used for fascias, it is shown here as interior paneling, in a sawn texture and with only a clear sealer. Panels can be edge-glued up to 4' in width. Thicknesses are nominal 1" and 2". California Redwood Assn., San Francisco.

Circle 214 on Reader Service card

4 T&G planking, in 1" x 6" size, comes in 7', 8' and 10' lengths or up to 16' for special orders, can be used as indoor paneling or outdoor siding. Deep grooves are finished in black for accent. Paneling surfaces are knotty cedar (as shown), wormy or knotty hemlock and have a clear finish or dark, light or Mediterranean stains with a rough or smooth texture. Weyerhaeuser, Tacoma, Wash.

Circle 215 on Reader Service card

5 Plastic panels can be mounted in cabinets, shutters or room dividers or placed against door or window glass for back-lighting. Pattern is embossed on both sides and is available in orange, violet and blue, as well as the red shown here. Rugged enough to withstand heavy impact, panels may be cut or sawn to any size, although they come in four standard sizes: 12" x 96", 24" x 48", 16" x 72" and 30" x 30". K-Lux, St. Louis.

Circle 216 on Reader Service card

6 Low-sheen paneling has the appearance of an oil finish. Rosewood color shown is one of four Weldwood colors now available in special finish, usually only available on custom orders. Other colors are walnut and teak. U.S. Plywood, New York City.

Circle 217 on Reader Service card

7 Translucent panels of polystyrene are embossed in four patterns. The bulls-eye motif shown here in amber also comes in olive green and smoke green. There are three standard sizes: 2' x 6', 2' x 4' and 4' x 8', but panels may be cut to fit any frame. Masonite, Chicago.

Circle 218 on Reader Service card

8 Vinyl wallpaper is prepared for rapid installation. Once cut to length, the roll is soaked for a minute or two in the portable water tray right at the base of the wall, then pulled up the wall and wet-sponged into place. Because it remains slippery for 20 minutes, it can be slid to match pattern. Paper carries a three-year guarantee. Imperial Wallpaper, Cleveland, Ohio.

Circle 219 on Reader Service card

9 Hardboard panels have baked plastic surface for durability and low maintenance. Beside the teak shown here, there are seven other wood species and two colors—sage green and white. Sizes: 4' x 7', 8' or 9', all 1/4" thick. Also available: the company's own adhesive for installing the panels and matched mouldings. Abitibi, Birmingham, Mich.

Circle 220 on Reader Service card

10 Three products—for walls and ceilings—are shown in one installation. **Ceiling tiles** have a swirl pattern embossed in a plastic finish on a textured white surface, are oil and grease resistant and fire retardant. Tiles, 1/2" thick and 12" x 12", are stapled or nailed to wooden strips over framing or plaster or nailed directly to wallboard. **Urethane beams** are difficult to distinguish from wood, come in 10', 12', 14' and 16' lengths. **Hardboard paneling** with wood-grain design reproduced from walnut also is available in other patterns, such as pecan, oak and cherry. Celotex, Tampa, Fla.

Circle 221 on Reader Service card



1

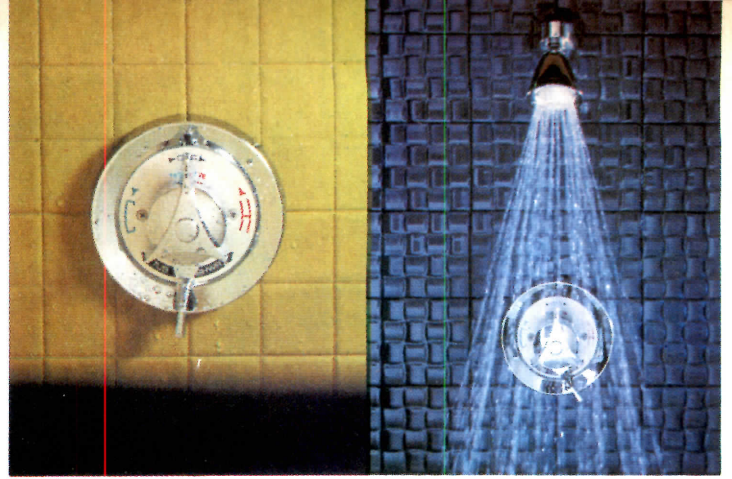

3

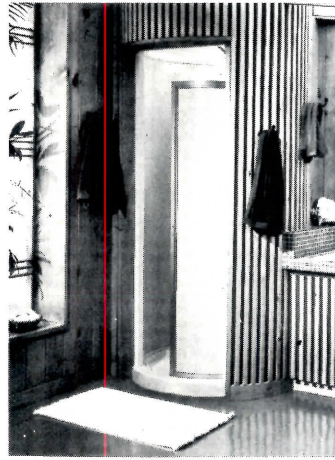

4

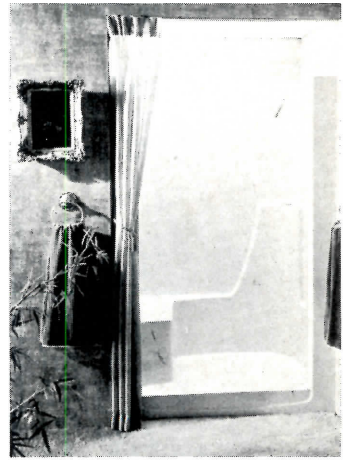

5

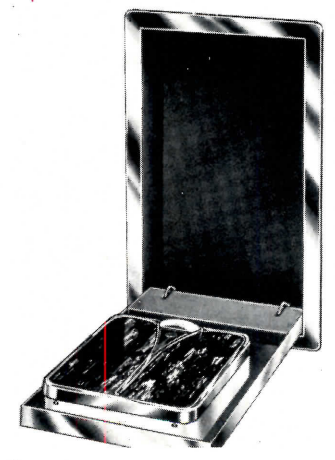

6



7



2



8



9



10

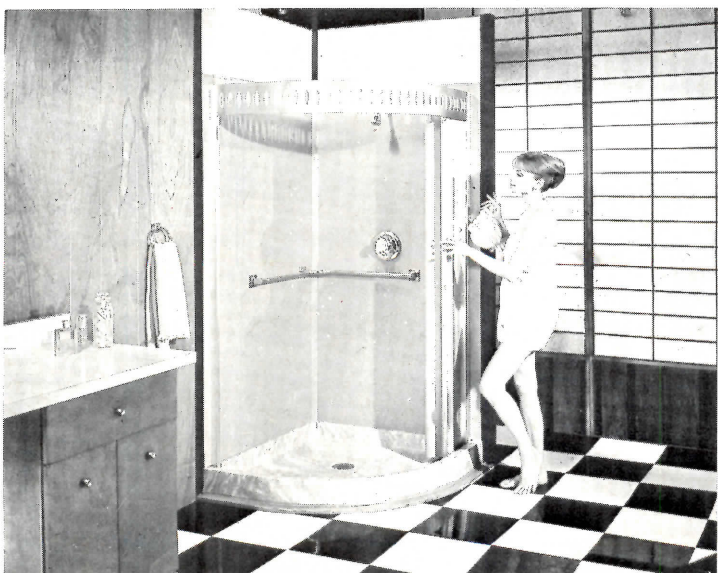

11

NEW PRODUCTS

bathrooms

1 Compartmented vanity has doors of molded plastic parts. A full line of sizes, in white and gold as shown, will be on the national market in early '69. Kitchen Compact, Jeffersonville, Ind.
Circle 222 on Reader Service card

2 Flexible showerhead can be used as a wall shower at varying heights or held in the hand. Twenty models are made in solid brass or chrome-plated nickel. The teak and chrome bath seat folds against the wall when not in use, measures 18½" x 13½" when open. Frame has concealed wall mountings. Alsos Products, Somerset, Mich.
Circle 223 on Reader Service card

3 Non-scald valve for shower and tub is pressure actuated, varies only two degrees despite sharp changes in hot or cold water supplies. Temperature setting, volume control and tub diverter are all in one unit. Valve and companion showerhead are bronze and stainless steel. Syntrol Valve, Boston.
Circle 224 on Reader Service card

4 Shower stall is a sleek cylinder of fiber glass, has a full 36-in. inside diameter, yet takes up little more than 9 sq. ft. of floor space. Overall height is 81½". Curved fiber glass door slides inside the cylinder. Shipped knocked down, the three parts can be assembled in 20 min. Molded-in, non-chip colors are blue gray, yellow, sea green, white and coral. Swan, St. Louis.
Circle 225 on Reader Service card

5 One-piece shower has no seams or joints. The 48" size shown has a pillar moulded into the Fiberglas that contains a convenience seat, shelf and soap holder. Owens-Corning Fiberglas, Toledo, Ohio.
Circle 226 on Reader Service card

6 Flip-down scale recesses into the wall. Only 12¾" wide, it fits between studs. Height is 19½", depth 4". A spring aids easy opening and closing. Scale rests parallel to the floor when in use, will hold up to 250 lbs. G. M. Ketcham,

Glendale, N.Y.
Circle 227 on Reader Service card

7 Carved mouldings decorate front of this vanity. Made of heavyweight polyester, the mouldings come in 1½" and 2¾" widths and lengths of 24" and 36". Center plaques are 7" x 7" squares as shown or 7" x 15" rectangles. Mouldings can be worked like wood: sawed, nailed, glued, drilled, stained, painted or antiqued. Filon, Hawthorne, Calif.
Circle 228 on Reader Service card

8 Prefabbed sauna can be assembled from complete package in less than an hour. The largest of five models, this one measures 6' 3½" x 12', is 6' 8¾" high. Benches are 19¾" and 35½" wide. Interior is redwood, exterior is mahogany. Complete with heater, controls, light. Viking, San Jose, Calif.
Circle 229 on Reader Service card

9 High-style fittings feature Lucite handles, tapered to hand contour. Widespread set allows installation flexibility, from 8" to 15" between. Extra long curved spout permits use with any size basin. Metal surfaces are triple chromed. Line includes tub and shower sets, kitchen and lavatory fittings. Price-Pfister Brass, Pacoima, Calif.
Circle 230 on Reader Service card

10 Pedestal lavatory of vitreous china is available in same ten colors as manufacturer's companion fixtures: sea green, avocado green (shown), lilac, yellow, blue, pink, beige, white, off-white and black. Basin has a concealed overflow and anti-splash rim, two soap depressions. Dimensions: 27" x 22". Case, Robinson, Ill.
Circle 231 on Reader Service card

11 Corner shower comes in a package that includes a folding shower enclosure, fiber glass non-warp walls with grip-tight snap-in corner mouldings and a rounded shower floor. Enclosure moves on a hidden track, will fold to either side. Showerfold, Chicago.
Circle 232 on Reader Service card

NEW PRODUCTS

exteriors

1 Roof tiles are made of galvanized steel coated with 1) a bituminous emulsion, 2) ceramic crushed stone and 3) a fungus- and weather-resistant sealer. The 180-lb. tiles are easily workable, non-combustible, require no maintenance. Automated Building Components, Miami, Fla.
Circle 233 on Reader Service card

2 Vinyl products include: **siding**, available in vertical V-grooved 10' lengths and horizontal clapboards in white, gray or green with optional polystyrene insulation; **gutters and downspouts** with thin walls, larger inside diameter; flexible **roof edging** with lip to throw off water; **soffit panels** that are V-grooved, available with or without perforations, and **shutters** in green, white or black with matching screws. Bird & Son, East Walpole, Mass.
Circle 234 on Reader Service card

3 Shingle panel of cedar is 8' long, can be applied in minutes with matching nails. Only 11 three-ply panels needed to cover 100 sq. ft. Available in 12 colors and nine wood-grain finishes. Shaktertown, Cleveland.
Circle 235 on Reader Service card

4 Colored shingles — tan, brown, gray and olive—have sealing tabs that fuse under normal roof temperatures and prevent damage by high winds and heavy rains, are fire-resistant. Philip Carey, Cincinnati.
Circle 236 on Reader Service card

5 Asphalt shingles look like random wood shakes, have deep shadowlines, are fire resistant and self-sealing. Three colors: cedar, wood and slate. Celotex, Tampa, Fla.
Circle 237 on Reader Service card

6 Redwood plywood comes in rough-sawn or brushed texture, with or without some sapwood, plain or in various grooved patterns. Panels are $\frac{3}{8}$ " and $\frac{5}{8}$ " thick, 48" or 48 $\frac{3}{8}$ " wide and 8', 9' and 10' long. California Redwood Assn., San Francisco.
Circle 238 on Reader Service card

7 Vinyl siding does not dent, is easily applied, requires no maintenance, comes in white, gray or green in horizontal clapboards or in vertical board-and-battens. Mastic, South Bend, Ind.
Circle 239 on Reader Service card

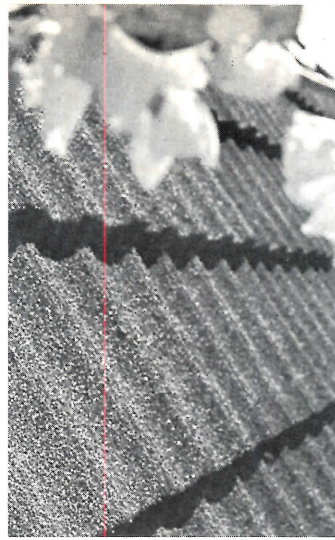

1



2



3



6



4



5

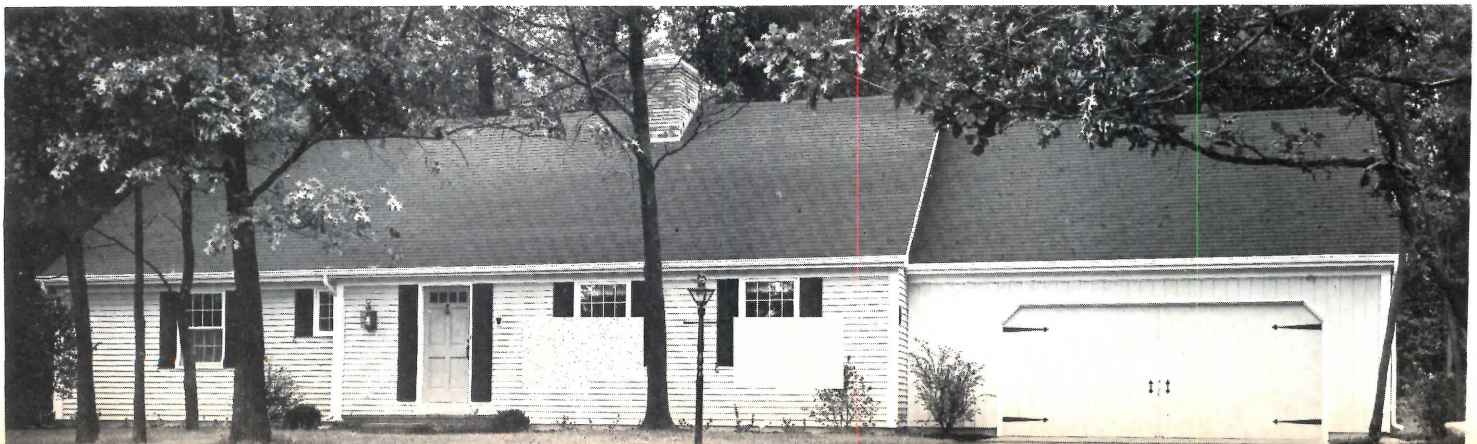

7

NEW PRODUCTS

lighting



1

1 Vanity lights, here framing a mirror, come in varying lengths, can be mounted horizontally or vertically or used individually. They are of blown crystal with a sparkling inner frosting of glass beads. Progress Lighting, Philadelphia.

Circle 240 on Reader Service card

2 Ten-light chandelier of hand-hammered wrought iron has short thick candles, shown here with seeded amber glass chimneys. Also available are one- and two-light companion wall brackets and a six-light chandelier. Lightolier, Jersey City, N.J.

Circle 241 on Reader Service card

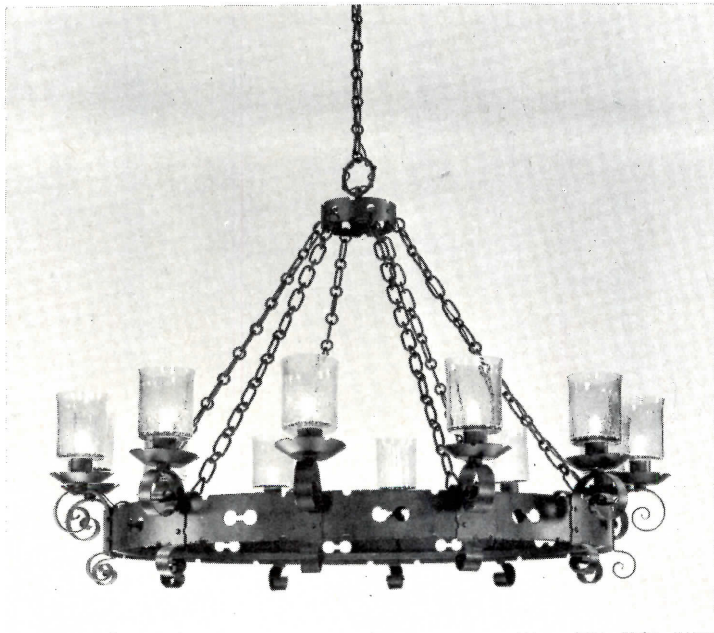

2

3 Laminated standard for outdoor lights—at 10', 12', 15' or 20' heights—has a tapered pedestal of Douglas fir in a variety of stains. Wood is pressure treated with preservatives to reduce decay and termite damage, is guaranteed for 20 years. Weyerhaeuser, Tacoma, Wash.

Circle 242 on Reader Service card

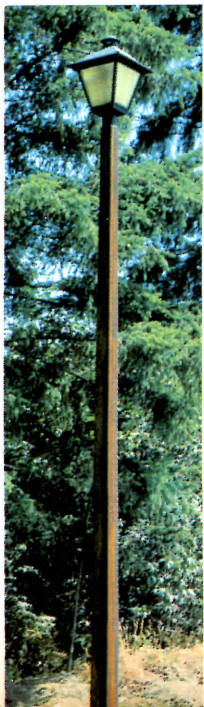

3

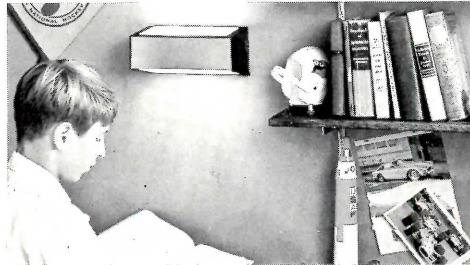

4

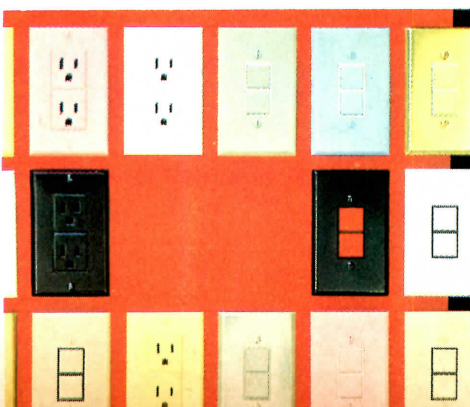

5

4 Wall bracket of cast aluminum with a clear or black finish provides illumination up and down for study areas or halls, lobbies or stairways. Offered for a single 100W lamp, or two 60W lamps. Optional features: pull switch, emergency light and grounded convenience outlet. Emerson, St. Louis.

Circle 243 on Reader Service card

5 Decorator switches, switchplates and grounding receptacles come in nine colors: pink, blue, yellow, brown, beige, gray, ivory, white and black. Switches and plates can be matched or contrasted, carry 25-year guarantee. Leviton, Brooklyn, N.Y.

Circle 244 on Reader Service card

6 Double pendants have antique gold castings, etched crystal cylinders, come with six feet of chain, a two-loop canopy, matching hooks, and may be connected to wall or ceiling outlets. Lightcraft, Los Angeles.

Circle 245 on Reader Service card



6



1



2



5



3

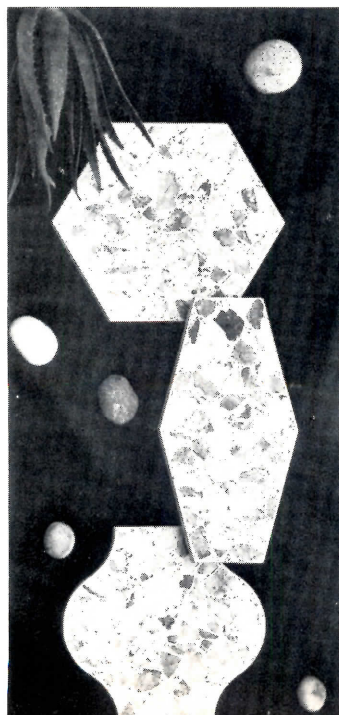

4



6



7



8



9



10

NEW PRODUCTS

flooring

1 Sheet vinyl, designed with an embossed marble veining that hides subfloor irregularities, can be installed directly over old resilient floors with manufacturer's own installation system and non-mix cement. This low-budget flooring comes in six colors: orange, gold, tan, green, white and beige. Armstrong, Lancaster, Pa. *Circle 246 on Reader Service card*

2 Seamless flooring is poured from a can and rolled on, will not mar or need waxing, requires little maintenance, can be used in high-traffic areas. A wide range of colors is available. Torginol of America, Montebello, Calif. *Circle 247 on Reader Service card*

3 Olefin carpet, used here on a terrace, now comes in a mosaic pattern as well as solid colors and floral prints, installs easily with tape or adhesive. Polypropylene fiber is colorfast, won't rot, isn't affected by mildew. Several widths and colors are available. Ozite, Chicago. *Circle 248 on Reader Service card*

4 Terrazzo tiles, pressure-moulded from natural stone aggregates and lightweight matrix combinations, are cut, precision-ground and polished in a wide choice of colors and shapes. Beveled edges permit faster, neater grouting. Standard tiles are $\frac{5}{8}$ " thick, 12" x 12" in size. Regal Products, Anaheim, Calif. *Circle 249 on Reader Service card*

5 Moppable carpet of tightly woven nylon is shown in an apartment kitchen installation. Resistant to most stains, acids, alkalis, solvents, won't mildew or support insects, available in a variety of colors. Hardwick & Magee, Philadelphia. *Circle 250 on Reader Service card*

6 Pegged planks are hardwood veneer protected by a heavy film of clear vinyl for durability and backed with aluminum foil, a vinyl sheet and asbestos fiber for a permanent, moisture-free bond

on- or above-grade on any kind of subfloor. Random planks in 4", 6" and 8" widths, all in 48" lengths, come pegged or unpegged, in walnut, cherry, mahogany, oak and teak. Also offered: 9" x 9" tiles and 4" x 13" pickets for parquet floors. Parkwood Laminates, Wakefield, Mass.

Circle 251 on Reader Service card

7 Vinyl-asbestos tile looks like large pieces of thinly veined marble laid in a matrix of smaller chips. Tiles are $\frac{1}{8}$ " thick, 12" x 12", come in four color combinations: olive/white, black/brown, beige/brown and dark brown. Surface is greaseproof, alkali-, stain- and fire-resistant. Also available: matching cove base. Azrock, San Antonio.

Circle 252 on Reader Service card

8 Cushioned vinyl has the look of Moorish tiles set in pecan, mahogany or teak borders, comes in opal white, tourmaline green, deep red and malachite blue. Surface is soilproof, resistant to scuffs and dents. Asbestos backing permits installation anywhere. Available in 6' widths. Congoleum Industries, Kearny, N.J.

Circle 253 on Reader Service card

9 Ceramic tiles are individual pieces—6" circles, sunflower petals and diamond-shaped background inserts—that can be all one color or a variety of complementary or contrasting colors and combinations. Tiles are glazed with a matte, glossy or satin finish. Designed and manufactured in California, they are distributed nationally. Country Floors, New York City. *Circle 254 on Reader Service card*

10 Outdoor carpet—called Wearathon—is ideal for high-moisture areas like the laundry because it won't mildew or absorb water, has a high wet strength and is also resistant to most solvents as well as acids and bleaches. A special formula produces colors that are bright but fade proof. Armstrong, Lancaster, Pa. *Circle 255 on Reader Service card*



1



2



6 a



6



3



4



5



5 a

kitchens



6b

1 Laminated cabinets look like wood but are $\frac{3}{4}$ " particle board faced with pressure-moulded plastic laminate that resists alcohol, chemicals, fruit stains, scratches and burns. Doors and drawer fronts also have warp-free laminated backs. Drawers have beveled edges for fingertip opening, glide on nylon rollers. All standard sizes available. United Cabinet, Jasper, Ind. *Circle 256 on Reader Service card*

2 Shaded maple is a new finish for these cabinets with sculptured door and drawer fronts with a hand-crafted look. Features: pre-finished toe boards, finished end panels, compartmented cutlery drawer, adjustable wall cabinet shelves, three-point drawer suspension and two hardware choices. A full range of sizes and all manufacturer's accessories available. Kemper Brothers, Richmond, Ind. *Circle 257 on Reader Service card*

3 Old-fashioned range is a replica of an 1890 cast-iron range reproduced in black porcelain enamel with cast-iron base, legs and trim. Both electric and gas models have up-to-date conveniences such as rotisserie, oven and surface lights, lift-up top for cleaning, and blower vent. Controls, concealed by "fire box" doors, include automatic clock, timer, oven pre-heat signal light, timed appliance outlet. Width: 38". U.S. Stove, South Pittsburg, Tenn. *Circle 258 on Reader Service card*

4 Electric grill needs no hood, captures smoke in surface vent and exhausts it outdoors. Char-broiled flavor comes from permanent grill rock below 2800-watt heating element, where drips vaporize and prevent flame-ups. Grill converts to non-stick griddle (included) or rotisserie (optional), has a cutting board cover, is also combined with range units. Finish: chrome or black. Jenn-Air, Indianapolis. *Circle 259 on Reader Service card*

Companion appliances include: **5 Built-in ovens** that feature automatic gas ovens with a choice of temperatures for cooking and keeping warm, and a lower infra-red radiant char-broiler with a rotisserie. Both have easy-cleaning features such as lift-off doors and rounded corners. **5a Undercounter dishwasher** with stainless steel tank, washing arms, basket rails and inner door, all guaranteed for 20 years against corrosion. Both appliances come in gold as shown, avocado, copper, white and chrome. Dishwasher also comes in yellow, turquoise, cinnamon, stainless steel and several

wood-grain veneers. Waste King Universal, Los Angeles. *Circle 260 for oven, 261 for dishwasher on Reader Service card*

Top-of-the-line models include: **6 Portable dishwasher** is front-loading, can be converted to built-in. Dish racks can be adjusted for loading flexibility. Unit includes built-in soft food disposer and cherry cutting board top. **6a Side-by-side refrigerator** (23.5 cu. ft.) has dispensers that deliver ice cubes or chilled water from 260-cube automatic ice-maker and 48-oz. cold water reservoir. Frost-free freezer will hold 295 lbs. Model is 33 $\frac{3}{4}$ " wide, rolls on wheels. **6b Electronic range** has an upper oven that bakes, broils and roasts, plus a rotisserie, and a lower microwave oven that cooks foods in a fraction of normal time. Upper oven has removable panels for cleaning in lower self-cleaning oven. All three appliances are available in avocado as shown or gold, copper or white, bear maker's new top-of-the-line designation "Americana." General Electric Louisville, Ky. *Circle 262 for dishwasher, 263 for refrigerator, 264 for range on Reader Service card*

7 Built-in dishwasher, one of four models, features 17-place-setting capacity, heavy duty $\frac{1}{2}$ -hp motor, multi-level washing action, random loading racks, soft food disposer. An indicator shows when dishes are clean and drying. Hot-point, LaGrange, Ill. *Circle 265 on Reader Service card*

8 Compact washer/dryer combines an automatic washer and a shoulder-high dryer in a single cabinet, is only 24" wide, 27 $\frac{1}{8}$ " deep and 65 $\frac{3}{4}$ " high. Space-saving combination is ideal for retirement housing, apartments and low-cost homes. Eye-level controls for both units are on the dryer cabinet. Lid of washer is held in open position by magnet on the sloping base of the dryer. Frigidaire, Dayton, Ohio. *Circle 266 on Reader Service card*

9 Gas range has a self-cleaning oven with a heat exchanger that reduces exhaust air by hundreds of degrees, a cleaning cycle only 90 minutes long, plus heavy duty insulation. Oven also has a full-width waist-high ceramic radiant broiler for char-broiling. Upper shelf contains oven and broiler controls and signal lights, is an electrically heated warming shelf with a convenience outlet. Model, 30" wide, comes in avocado, gold, copper and white. Tappan, Mansfield, Ohio. *Circle 267 on Reader Service card*

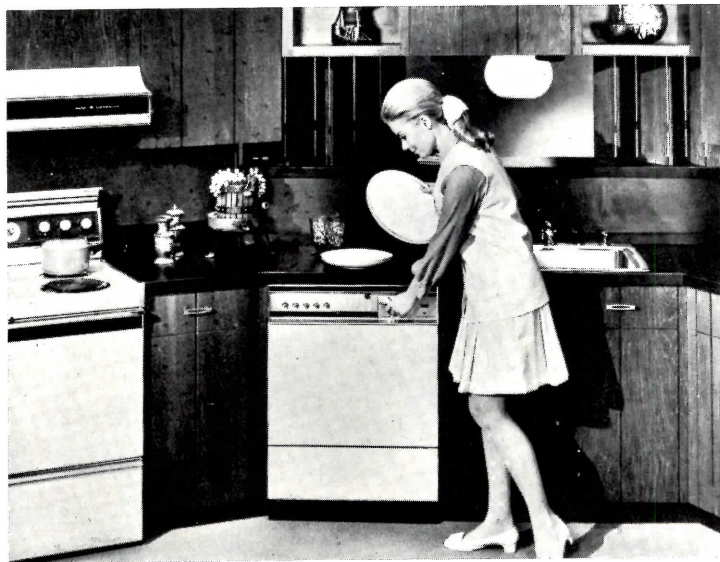

7



8



9

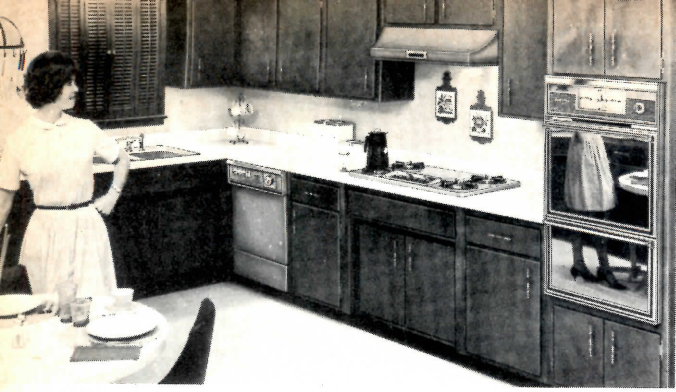

1

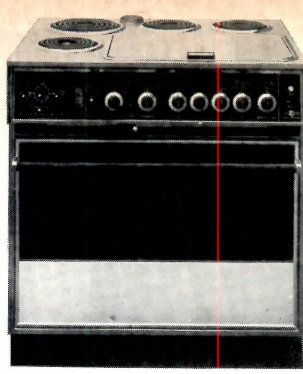

2

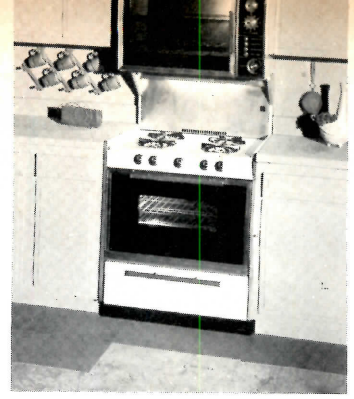

3

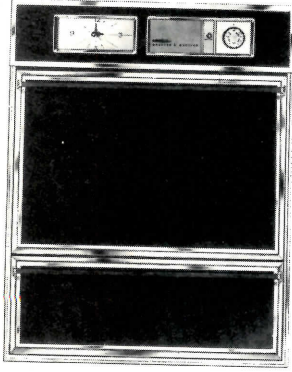

4

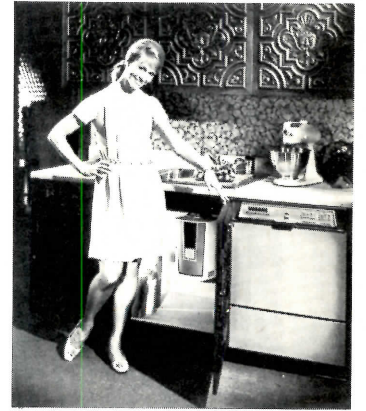
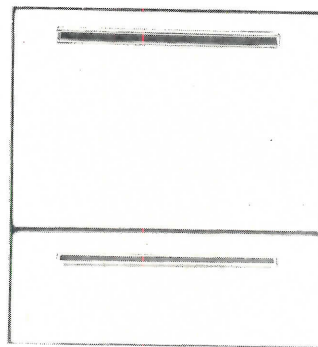
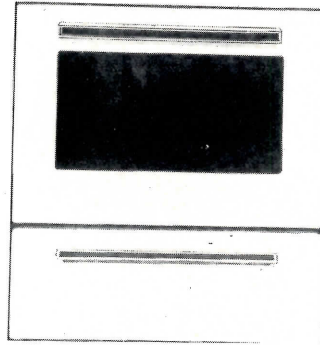

5



6



7



8

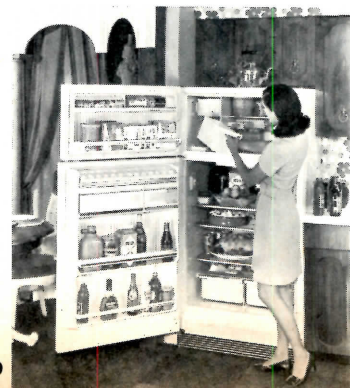

9



10



11

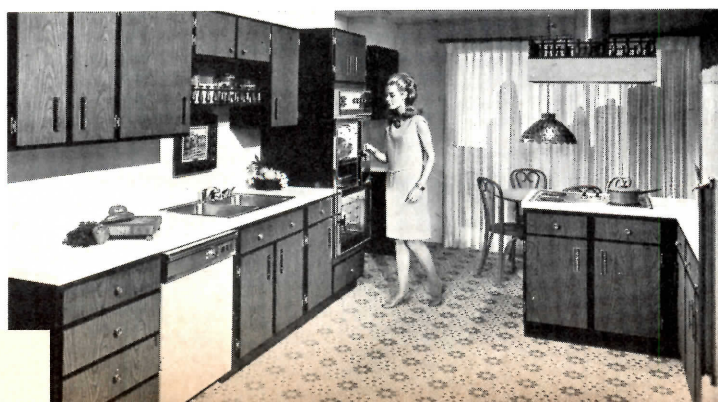

NEW PRODUCTS

kitchens

1 Mirror-door oven is one of four new appliances built into this model kitchen. Others are undercounter dishwasher (left in photo) and the built-in cook-top and range hood (center). Ovens have ceramic broilers and controls for keeping cooked foods warm. Roper, Kankakee, Ill.
Circle 268 on Reader Service card

2 Drop-in range, 30" wide, has self-cleaning oven, solid or black glass doors as shown. Unit may be ordered in two combinations of burners and/or griddle, does not require outside venting during self-cleaning if used with a range ventilating hood with timer. Thermador, Los Angeles.
Circle 269 on Reader Service card

3 Eye-level range is 36" wide, has black glass doors that are opaque when ovens are dark, become transparent when oven lights are on. Part of a complete line of free-standing, slip-in and eye-level ranges that come in gold, copper, avocado and white, some with chrome tops. Brown Stove Works, Cleveland, Tenn.
Circle 270 on Reader Service card

4 Built-in ranges allow buyers to select doors from many combinations or solid or partial black glass and ten colors as well as brushed chrome and stainless steel. A contoured vinyl panel contains hidden lighting and compact controls. Gaffers & Sattler, Los Angeles.
Circle 271 on Reader Service card

5 Clean-up center includes disposer and dishwasher. Disposer has magnetic cover, is designed to work quietly, has a reversing switch to clear jams. Dishwasher has seven pushbutton cycles, including a plate-warming feature. KitchenAid, Troy, Ohio.
Circle 272 on Reader Service card

6 Giant refrigerator has 14-cu.-ft. refrigerator above, 5.1-cu.-ft. freezer below with an automatic icemaker. Fourteen models range from 6.6 cu. ft. to 32.7 cu. ft., fit spaces 15", 30", 36", 42" and 48" wide. Removable decorator door panels can be faced with any material up to 1/4" thick. Sub-Zero Freezer, Madison, Wis.
Circle 273 on Reader Service card

7 Stainless disposer carries a parts warranty for the life of the unit against corrosion of vulnerable parts as well as a one-year repair warranty on manufacturing defects. Unit is sound-conditioned. General Electric, Louisville, Ky.
Circle 274 on Reader Service card

8 Range hood comes in five colors besides the copper shown. Hoods and hood-fans are 30", 36", 42" or 48" in width for wall mounting or twin-faced for pass-throughs. Some have built-in, sound-deadened fans, others have roof-mounted heavy-duty fans. NuTone, Cincinnati.
Circle 275 on Reader Service card

9 Add-on icemaker may be installed after installation in the freezer section of a new line of refrigerators. Icemaker freezes, releases and stores up to 120 cubes of ice daily. Cube-level control adjusts icemaking amount or turns off mechanism. Refrigerator shown has reversible doors for left- or right-hand swing. Frigidaire, Dayton, Ohio.
Circle 276 on Reader Service card

10 Double-decker range is 36" wide, has six gas burners and two ovens. The lower oven has a waist-high, infra-red broiler, is also self-cleaning. Features burner with thermostatic control and automatic timing for cooking and keeping warm. Caloric, Topton, Pa.
Circle 277 on Reader Service card

11 Gas dryer is electronically controlled for all fabrics. It has six degrees of dryness, variable temperature control, ultra-violet lamp, and end-of-cycle signal. Matching washers have four speeds, ten rinses, six water temperatures and constant balance suspension for off-balance loads. Hamilton, Two Rivers, Wis.
Circle 278 on Reader Service card

12 Contemporary cabinets have Micarta surfaces in an oiled-walnut finish. Doors are adjustable and removable and have self-closing hinges and rubber bumpers. Panel-on-frame construction is electronically glued. All cabinet ends are finished. I-XL, Goshen, Ind.
Circle 279 on Reader Service card

Is there a fair profit to be made in subsidized rental housing?

Up to six months ago the answer was a definite yes.

A growing number of builders had found that the below-market-interest-rate (BMIR) portion of FHA 221d3 could be, by and large, a very reasonable money-maker. As a result, after having been on the books since 1961, d3 BMIR was finally enjoying a modest boomlet.

But last summer, Congress, in the process of passing the 1968 housing bill, announced its intention to phase out d3 BMIR. The reasons were both financial (the program made rather big holes in the budget) and political (Congress wanted more attention given to lower-income families than d3 BMIR could give).

But the unfortunate result for the housing industry is the loss of the only government subsidy program that is producing an appreciable number of low-rental apartments.

The 1968 housing bill created a new program—FHA Section 236—which is intended to replace d3 BMIR. It is very similar to the older program, and the government hopes that builders will be able to shift over with little loss of momentum. Further, FHA Commissioner Philip Brownstein has said FHA intends to make 236 a program that builders really can work with.

Section 236 is so new that no case studies on it are yet available. But a number of d3 BMIR builders—the group that will almost certainly be the first to try 236—have some serious reservations about the ultimate profitability of the new program. Their opinions, plus their experiences under d3 BMIR, are the basis of the assessment that begins below.

And the projects shown at right and on pages 87 and 89 are examples of the quality of design and planning possible under d3 BMIR, and, hopefully, under 236.

The best measure of a government housing program's profitability is its popularity among builders. Using this yardstick, a look at Section 221d3 BMIR is very enlightening.

From 1961, the year of its birth, through 1966, d3 BMIR produced a grand total of 48,000 unit approvals worth just over \$600 million. The average over the last three years of that period was roughly 13,000 units a year.

Then in 1967 the program took off. FHA's figures haven't yet been broken down to a yearly basis, but in the year and a half that ended in July 1968 more than 50,000 units worth over \$700 million were approved. And FHA officials agree that had Congress made enough funds available, that figure could easily have more than doubled.

It's easy to point to contributing reasons

for this boom. Certainly tight money was one; in the face of soaring interest rates, d3 BMIR's direct FNMA (now GNMA) loans at the subsidized rate of 3% looked beautiful. And during 1967 the Administration went out of its way to encourage the entire 221d3 program: Funding was increased, and FHA managed to cut its processing time from an almost unworkable 18 months to a more nearly reasonable eight to ten months.

Undoubtedly these factors helped persuade many builders who had never considered d3 BMIR to give it a late whirl. But they don't explain why a few large, sophisticated builders went into d3 BMIR when it first began and are still in it today. And they don't explain why just about every builder now using the program is vociferously unhappy about losing it.

continued



IN CONNECTICUT, A 180-UNIT BMIR

Built and owned by John Errichetti Assoc. of Waterbury, this project offers an interesting lesson in the economies of land planning. It is situated on a hilltop, and only about half of its 25 acres are buildable. So John Errichetti, president of the company, asked his local FHA office to approve an unusual design—back-to-back townhouse units.

"It took a certain amount of hassling," says Errichetti, "but fortunately we have a very good and very cooperative FHA office, and they approved it. The result is that our buildings are much more compact, and we have lots of open land despite the limitations of the site."

The project also shows why d3 BMIR, with its tight cost constrictions, is no place for an amateur. Test borings failed to reveal a very bad rock condition, and an unexpected \$100,000 or so had to go into blasting.

"If we hadn't had a very efficient little organization," says Errichetti, "we'd have been in serious trouble. The sad part is that the extra money could have gone into more landscaping and recreation areas."

Architect for the project was Joseph Stein.

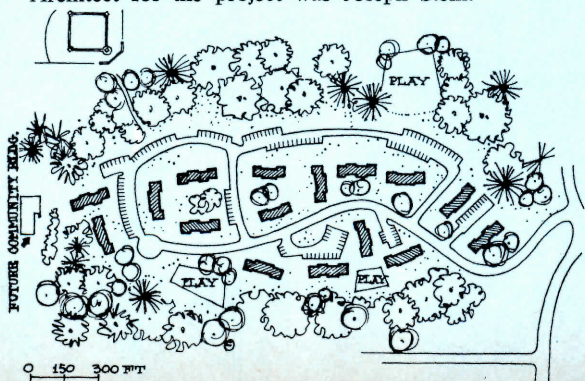

JANUARY 1969

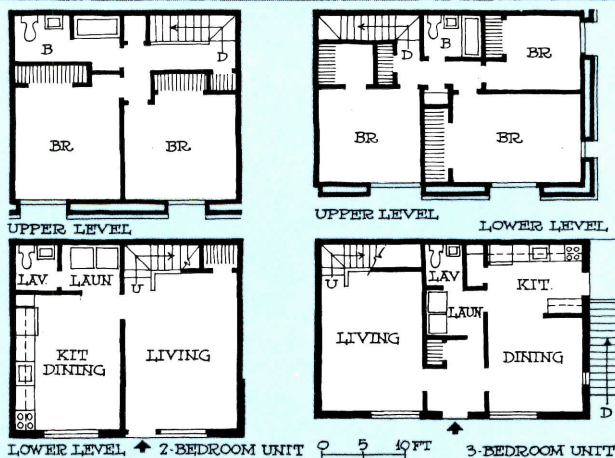

The primary reason for the d3 BMIR boom is that for the right builder under the right circumstances, it can make a very reasonable profit. And the success of the new 236 program will depend almost entirely on whether it can do the same.

On the surface d3 BMIR seems so hedged with limitations that making money under it would be all but impossible. This may, in fact, be one of the reasons why so relatively few builders became interested in the program during its early years.

For example, the builder is allowed a 10% profit on his construction costs; this is decidedly on the low end of the reasonable scale. As the owner (and most builders do hold their projects) he can take out just 6% of his equity; very few investors would be interested in such a low return. And he is allowed about 4½% of the gross rental as a management fee; this would be close to the line for moderate- and higher-income projects, and most d3 BMIR builders agree that it simply doesn't cover the higher costs of running low-income projects.

To understand BMIR's profitability, you have to take it as a whole

And when you do take it as a whole, you'll see that its money-making potential comes from the combination of three separate factors:

1. *Depreciation can be used as a tax shelter.* As with a conventional project, the depreciation can either be straight line (if the owner plans to hold the project for a long time) or double declining (if he plans to sell within ten years or so).

This tax shelter is the *sine qua non* of the program. It explains why almost all d3 BMIR units are owned by their builders and why builders who haven't enough cash flow to make a depreciation write-off necessary seldom if ever build under the program.

Of course, tax shelter alone isn't enough to explain the d3 BMIR boom; any conventional project would offer the same advantage. But conventional projects can't offer the next two advantages.

2. *Financing under d3 BMIR is very favorable.* The builder gets a 10% fee on the construction cost of the project; as the owner, he gets a 90% mortgage. This means that, on the average, he will wind up with no more than about 2½% of the value of the project invested as cash. And if he was able to buy his land on favorable terms, he will in all probability be able to mortgage out.

3. *The market for d3 BMIR seems almost unlimited.* The reason, of course, is that the below-market interest drops rents by a very significant amount. For example, an apartment that would rent for \$155 were it financed at market interest rates

could rent for about \$115 at 3% interest. Indeed, in many areas d3 BMIR is the only way a family making, say, \$7,000 a year can get decent housing. So it's not surprising that most projects have sizable waiting lists.

This strong market adds a small but significant long-term advantage for the d3 BMIR owner. His operating profit and management fees are based on 93% occupancy; if occupancy runs close to 100%, his fees are proportionately higher. True, the extra income can't go into his pocket; instead, it goes into a fund that theoretically can't be touched for 20 years, when the project becomes re-financable. But in fact, if FHA approves, the fund can be used to improve the project at any time. And if the builder were to sell the project without refinancing, the new owner would, in effect, buy the fund.

Put this all together, and you get an apartment project that offers tax shelter, can be mortgaged out and is practically assured of continuous 100% occupancy. It's not surprising that 221d3 BMIR enjoyed a popularity boom.

This is not to say, however, that everything has been peaches and cream for the d3 BMIR builder. For example, the very fact that he is dealing with FHA means inevitable red tape and delays. Even though processing time, as noted earlier, has been considerably shortened, it's still possible for a builder to get his approval and then find that building costs have risen so much during processing time that he has to re-apply for a cost increase. Just how much of a problem this red tape turns out to be depends pretty much on the efficiency and cooperation of the local FHA office, plus the builder's own expertise in dealing with the agency.

But the biggest problem faced by the d3 BMIR builder/owner lies in managing his project. He is bound to have a high proportion of tenants with young children, and young children tend to be extremely destructive. Further, there's general agreement among d3 owners that the lower the income average, the less responsibility tenants feel for curbing their children and otherwise helping to maintain the project.

An example of the problem at its worst is offered by Gersten Construction Co. of Los Angeles, which has built more than 2,500 d3 BMIR units and owns and operates more than 1,200 of them.

"The young children destroy grass and shrubs, and they ruin swimming pools and elevators if we put them in," says Albert Gersten, the company's president. "We've found that our maintenance costs are so high that they eat up all our 6% return. We've never had any cash flow from our d3s."

continued

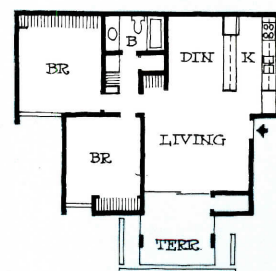

2-BEDROOM UNIT

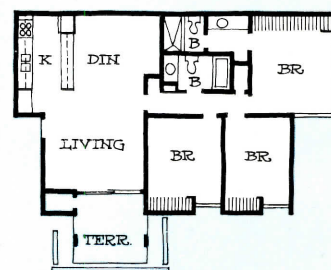

3-BEDROOM UNIT

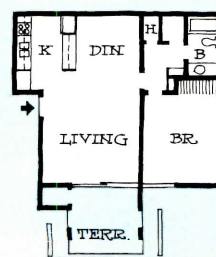

1-BEDROOM UNIT 0 5 10 FT



IN CALIFORNIA, A 528-UNIT BMIR

The first half of this 22-acre project in Long Beach was completed last year, and the second half is just getting underway. HUD officials were so impressed that they gave it a 1968 award for design excellence.

The project was built and is owned by Gersten Construction Co. of Los Angeles, a company whose 33 experience includes the construction of more than 2,500 units, and it was designed by Stephen G. Oppenheim & Assoc. One of its most interesting features is a semi-subterranean garage, made necessary by county insistence that a 1½-to-1 parking ratio be maintained. The level of the first story is raised (*photo, above*) above a shallow excavation, and the resultant space takes care of the great majority of the project's cars.

The land plan below shows a good combination of density and openness, with most buildings arranged in groups of three to form courts like the one at right.

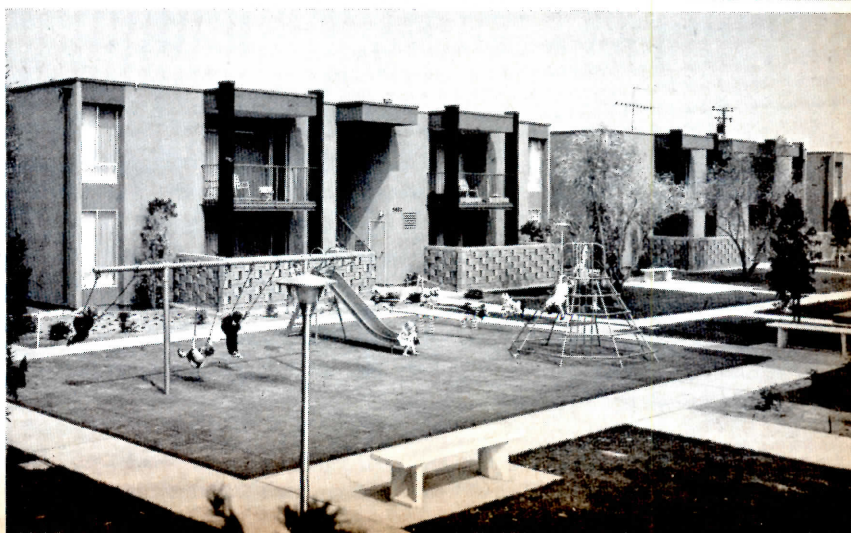
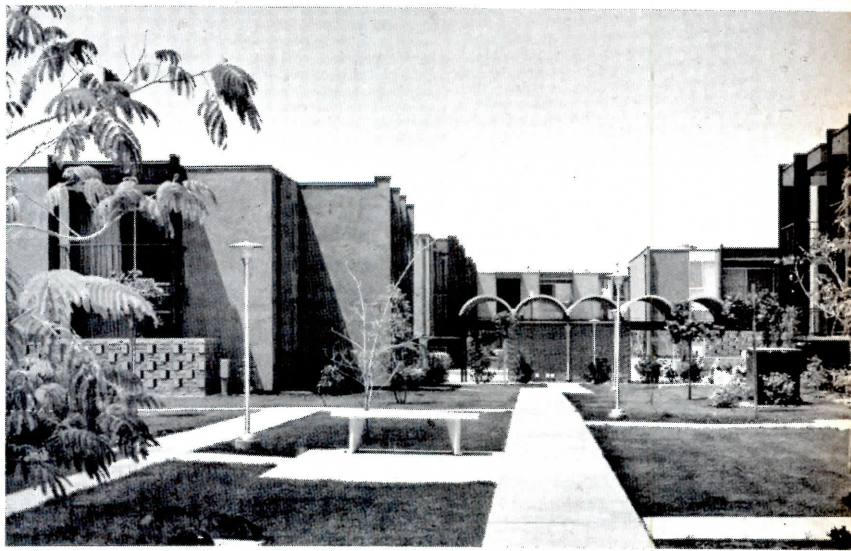
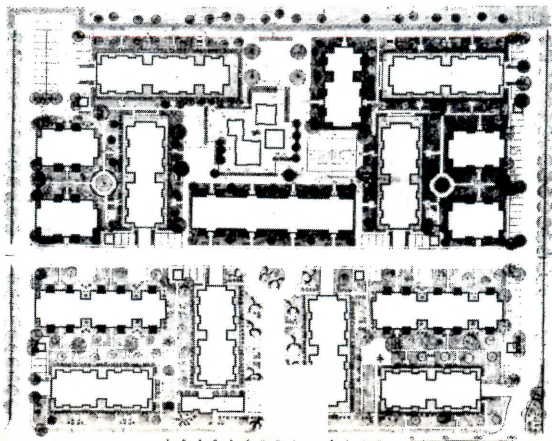

There's some indication that the size of the project has a bearing on the difficulty of managing it. Gersten's projects tend to be large—400 units or more. By contrast, John Errichetti, president of John Errichetti Assoc. of Waterbury, Conn., has found that his 180-unit d3 BMIR project (*see cover and p. 85*) has had very few management problems.

"We've been open for less than a year," says Errichetti, "so we can't say for sure that we won't have kids tearing things up. But we have a very good project manager who has fostered a strong community feeling, and so far there has been no serious damage at all."

The big question: Will new Section 236 be as profitable as old d3 BMIR?

At this point any answer must be largely conjecture. No 236 projects have yet been started from scratch. (The first ones completed will be conversions from d3 BMIR; such conversions can be made any time before final commitment.)

But a comparison of the two programs shows why most ex-d3 builders have serious doubts about the ultimate profitability of 236 as it's presently written.

Operationally, there's little difference between the programs: Says an FHA official: "Section 236 will process the same as d3 right down the line." And such things as allowable construction profits, operating profits and mortgage amounts will remain the same.

Hopefully, cost standards will also remain the same. FHA says it plans no cuts. And says builder John Errichetti: "The standards must stay the same. We can't build apartments any cheaper without building slums."

Some of the changes will be for the better. For example:

Under 236 a project can be built in any area. Under d3 BMIR the area had to be certified by HUD as having a workable program.

Under 236 a builder can refinance and sell his project at any time; under d3 he had to wait 20 years before refinancing. This will make it possible for a builder to realize any appreciation of his project much earlier.

Theoretically at least, the biggest change for the better in 236 is the manner of funding. The builder will no longer get a permanent mortgage direct from the government. He will take out a private mortgage at the FHA maximum of 6¾%, and a government subsidy will pay the difference between that figure and an interest rate as low as 1%.

The result is a much lighter immediate impact on the federal budget. And this, it is hoped, will help persuade Congress to

provide funds for many more units.

Unfortunately, the biggest change of all in 236—lower ceilings on tenants' incomes—may be the one that puts builders off the program.

Maximum income under 236 is pegged at 135% of the Public Housing Authority maximum for the area—which works out to roughly 80% of the upper limits allowed under d3. In addition, 20% of the tenants can have incomes of up to 90% of d3 limits; the idea is that a few higher-income families will help stabilize the project.

Philosophically, no one can quarrel with the aim of these lower ceilings: to make better apartments available to lower-income families. But practically, in the opinion of many builders currently in d3 BMIR, the projects themselves may prove unworkable as the program is presently drawn.

The problem these builders foresee is one of management. It's an unfortunate but inescapable fact that as income levels drop, destructiveness, vandalism and over-all irresponsibility in a rental project rise. Repairing and policing take money. And while 236 gives this fact token recognition by raising the allowable management fee from about 4½-5% to about 6%, few builders with experience in d3 BMIR think this increase will even come close to filling the need.

"In effect," says Albert Gersten, "236 is going to be glorified public housing. In California it's going to provide rental housing for families who earn from \$5,500 down. And to run a project like that, we need to provide social counseling and better security. I'd say that the management fee should be raised by at least 4%, not 2%. And I think you'd find that most of this would be recovered in the form of decreased maintenance and repair costs."

John Errichetti agrees that management will be the big problem in 236 and that the increased management fee will not be enough to solve it. He feels that an amendment in the income formula might be one way to make things workable.

"I think it's a fundamental sociological error to limit the proportion of higher-income families to 20%," says Errichetti. "At that rate the higher-income people won't want to come in at all. If the ratio were raised to, say, 50%, they would come. And they're the ones who lend stability to a project—who make it manageable."

Errichetti concludes thus: "If 236 projects are manageable, don't worry—there will be plenty of builders to build plenty of units."

And adds Gersten: "If 236 is profitable, lots of builders will want to work with it. If it isn't profitable enough, no sensible builder will work with it. It's that simple."

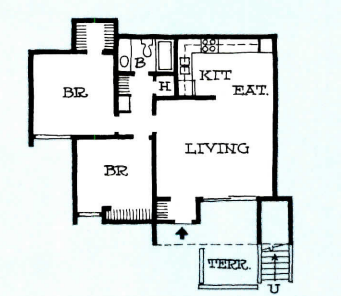

2-BEDROOM UNIT

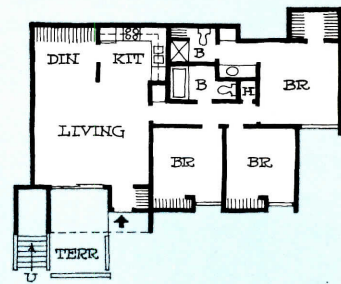

3-BEDROOM UNIT

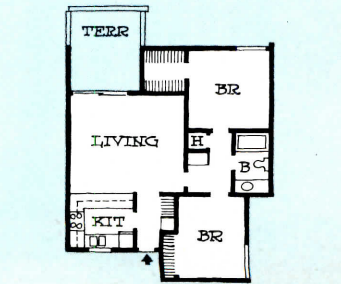

2-BEDROOM UNIT

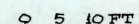



IN CALIFORNIA, A 456-UNIT TURNKEY

Like the project on page 87, it was built by Gersten Construction Co. from designs by Stephen G. Oppenheim & Assoc. But unlike the other, this is one of two projects which Gersten built under 221d3 for a non-profit sponsor—the AFL-CIO Building Trades (the second was for the Volunteers of America). And while, as the photos and plans show, the project is outwardly a success, president Albert Gersten has promised himself never to do another under this portion of 221d3. His reason reinforces the thesis that without a fair profit, builders won't stay with a government subsidy program.

"We're allowed just 6½% for both profit and overhead," says Gersten. "It's ridiculous. If the government really wants more non-profit-sponsored projects, they should give us the same sort of program as HAA turnkey."

Despite the difficulties, Gersten is committed to the principle of non-profit sponsors. He is currently building two 221d3 rent-supplement projects, one for a Mexican-American group and one for a Negro church group.

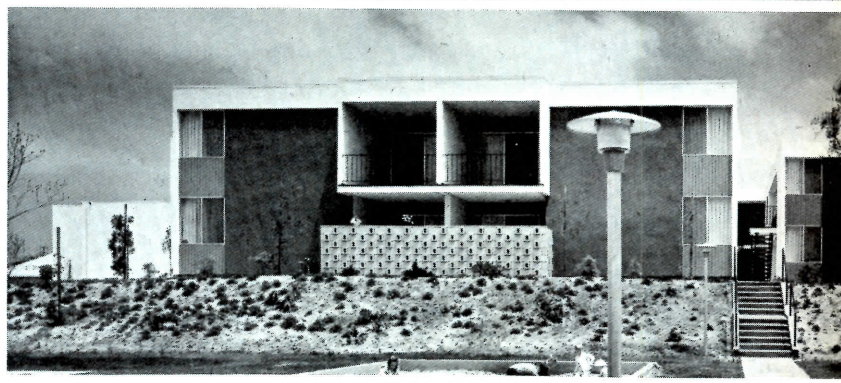
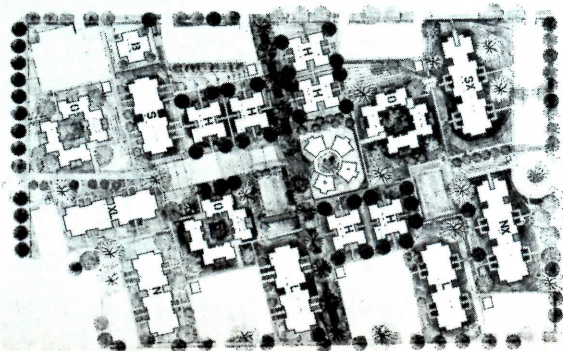

Top performers of 1968

A dramatic 1968 recovery lifted homebuilding to the brink of an exciting new era of expansion. Amid this progress the 12 leaders shown at right made outstanding contributions of lasting value to the nation's second largest industry. HOUSE & HOME honors the president of NAHB for legislative achievement, cites two mortgage experts for financing reforms and names a building company executive for advances in marketing methods. The recovery brought a rush into housing stocks, and one award recognizes a company that came to typify for Wall Street the stability of the industry. The year was also notable for technological advances, and three awards salute a systems engineer, a federal official and a mobile-homes executive for new construction techniques. Two other awards commend a local HBA leader and a professor of architecture for code reforms; another names a developer who won a significant zoning victory; and a final citation pays tribute to a reporter who helped police the industry.

Lloyd E. Clarke

This youngest of all presidents of the National Association of Home Builders spearheaded one of housing's most rewarding legislative efforts. Clarke, 39, rallied the industry to win passage of the 1968 Housing Act's Title xvi, setting housing goals and requiring Presidential reports on their achievement; he also led the drive for FHA Secs. 235 and 236 to shelter low-income families. President Johnson praised Clarke and predecessor Leon Weiner for "positive steps to bring the force of a great industry to bear on the housing needs of the nation."

Kincaid



Raymond H. Lapin

He took the presidency of Fanny May with a promise: "I did not come to Washington to retain the status quo in the mortgage market." True to his word, he wrought changes of lasting value for homebuilding and financing: a mortgage auction to facilitate the flow of money into mortgaging; private status for FNMA—freeing the agency to borrow more easily to finance homebuilding—and arrangements for a mortgage bond to tap new sources of money. In 18 months Lapin has accomplished reforms that will benefit the housing industry for decades.

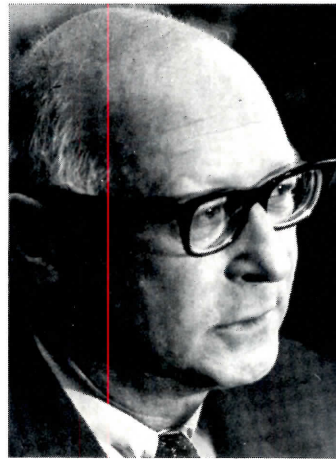

Oliver H. Jones

The executive vice president of the Mortgage Bankers Assn. is now recognized as the architect of Fanny May's new loan auction. As a consultant, he wrote the auction scenario and did much of the educational work to assure it a smooth reception. But that was only one Jones proposal. His writings and speeches provide a textbook of mortgage reform. The new FNMA mortgage bond, for example, stirs wide current interest. Yet Jones not only helped to plan it last year, but also proposed it—in a book written with Leo Grebler of UCLA—in 1961.



Michael L. Tenzer

This building company executive showed the industry how to lure young couples into houses from apartments. As marketing director of California's Larwin Co., Tenzer opened two subdivisions oriented to buyers under 30. He offered houses starting at \$19,900, stressed the ease of expanding them ("houses to grow into, not out of"), used vibrant colors in his sales models and even piped in mod music ("the young sound"). Six months later he was still selling houses at a rate of two a day, and builders from afar were arriving to study his success formula.

Louis Jacobs Jr.





James W. Walter

His Jim Walter Corp. has given the shelter industry new stature on Wall Street. As a rush into housing stocks raised questions of old weakness, this conglomerate showed the new strength of building companies. Its 70% increase in sales (to \$309 million) and 60% rise in per-share income (to \$4.02) testified to solid growth behind the stock, which sold at 28 times earnings late in 1968. And the acquisition of half a dozen new companies of widely varying character was evidence of the parent's orderly and diversified expansion since its founding in 1946.



Fay

Sepp Firnkas

The Firnkas system for joining precast-concrete panels has produced 2,000 units of 221d3 housing for just over \$10 a sq. ft. Architect Carl Koch has been using the system in Boston, and architect Harry Weese is applying it in Washington. While other structural engineers approach low-income housing with radical technology that progresses no further than small-scale demonstrations at federal expense, Firnkas quietly applies common-sense technology. His system is flexible, requiring no special tooling by panel manufacturers and no special skills.

Charles A. Dieman

Since joining HUD less than two years ago, the assistant commissioner for technical standards has cut repeatedly through governmental red tape that had restricted 221d3 housing. Even when project proposals have involved innovations in construction technology, Dieman has processed them in as little as four weeks. Besides speeding paperwork, he has encouraged local FHA men not only to accept promising new housing ideas but to promote them actively among tradesmen and code officials, and he has gone out into the field himself to help pave the way.



David S. Wolff

Mobile-home makers say the answer to low-income housing demand is the factory-assembled modular living unit. No manufacturer has done more to achieve that answer than the Magnolia Homes division of Guerdon Industries. Vice President Dave Wolff has solicited new designs from homebuilders and architects and has created profitable working ties between conventional-housing people and mobile-home experts. His efforts have developed a variety of mass-housing approaches and shown that mobile-home technology need not bar good design.

Roy Bailey



HGH staff

Leo D. Mullin

Kansas City's new plumbing code provides for builders almost everywhere an example of how to open the crafts to all qualified applicants and end restraints on modern materials. Executive Officer Mullin and his 800-member builders' association led the drive that brought the city council's original approval of the code. Mullin and HBA President Carson Cowherd then campaigned with architects, engineers and contractors to save the code at the polls. They won by 10,000 votes in a referendum on a labor union petition to rescind the new code.



Walter H. Lewis

This professor of architecture organized a code officials' training school with no less ambitious a goal than to open all homebuilding to new materials and techniques. Recognizing that code men had long presented an image of obstruction, Lewis founded the Building Officials Institute at the University of Illinois. The institute's first five-week course, aimed at encouraging receptivity to change, was the most successful ever conducted in its field. It drew 177 officials from 35 states, and that was only a start. Some 300 arrived for a second course this month.

Gerald C. Finn

This developer won from the Pennsylvania Supreme Court the clearcut ruling that municipalities have the power to zone for planned unit developments under state zoning laws. Because so many states have the same basic laws, the decision could give much of the nation a legal precedent to abandon the lot-by-lot zoning that has straitjacketed the American subdivision. Finn fought for three years to open the resort town of New Hope to his development. The court negated virtually every argument against zoning for anything but community welfare.



Kenneth G. Slocum

This reporter focused national attention on a major land scandal with his publication of a secret Florida Land Sales Board report accusing the giant Gulf American Corp. of immoral sales practices. His exposé, in *The Wall Street Journal*, was a link in a chain of events that brought a plea of guilty to charges of violating land-sales laws, a 30-day sales suspension and resignation of the company's chief executive. The cleanup helped restore confidence in Florida's \$200-million-a-year land-sales business, and Slocum was nominated for a Pulitzer Prize.





QUESTION:
What's so different
about this trio of
apartment projects?

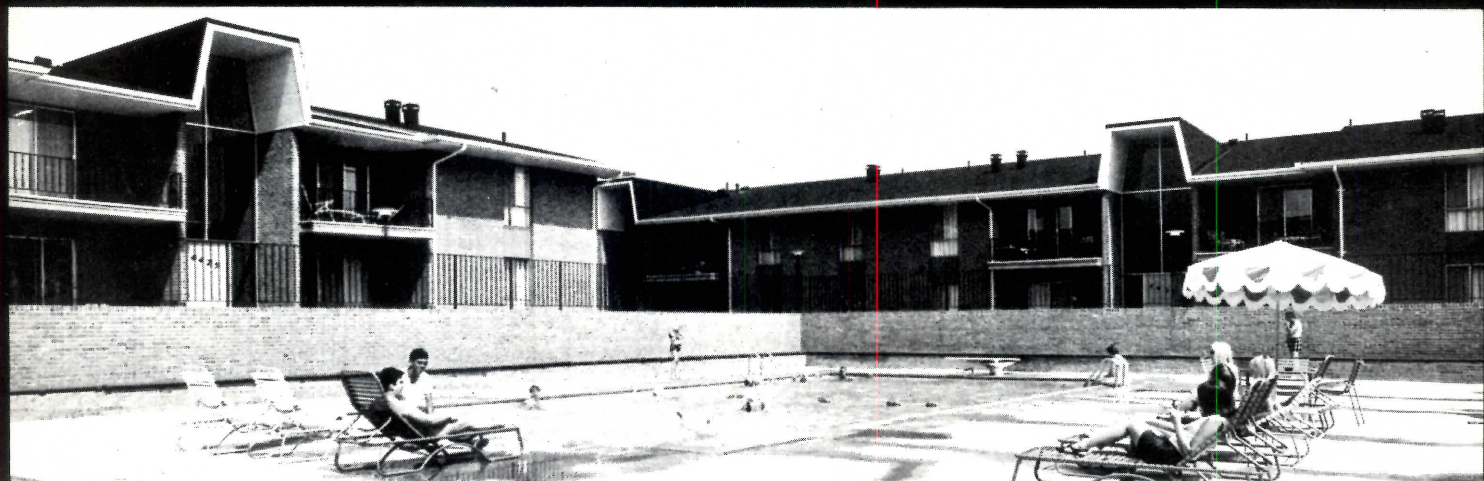

ANSWER:
All three projects*
are bringing
steel into the
low-rise market

They don't look like steel apartments, and that's exactly how their builders want it. True, the studs in their walls and partitions are made of steel, and so are the exterior doors and many of the finishing materials. But the component manufacturer, U.S. Steel Homes, has learned through two decades of trial and error that steel can make inroads in housing only where it 1) has consumer acceptance, 2) makes sense and 3) is competitive.

More than any other housing market, low-rise apartments offer steel makers an opportunity to meet all three of these criteria.

Until five years ago, U.S. Steel Homes concentrated on marketing single-family packaged houses based on a structural-

panel system that uses lightweight steel channels instead of wood studs for both exterior and interior walls. The company's apartment volume was virtually zero. But since then U.S. Steel Homes has been adapting steel to multifamily design, and today at least 35% of its production goes to some 70 apartment builders.

Steel is particularly well suited to apartments for at least two reasons:

First, the minimal maintenance required by steel doors and such pre-painted exterior components as soffits and fascias appeals to apartment investors because of their concern over upkeep and repair costs.

Second, apartment builders are already familiar with components like steel stairways and steel decking for lightweight-con-

* From top to bottom: 221d3 apartments built by Clifford Knopf Jr. in Louisville; 80-unit project in Titusville, Pa., by Harris Homes; 120-unit project in Dayton, Ohio, by Deema Development Co. All were prefabricated by U.S. Steel Homes.

Photos: Courtesy of U.S. Steel Homes



STEEL-HOUSE SYSTEM produced by U.S. Steel Homes uses wood framing wherever angle cuts are required, as in gable-end panels (*above*) and trusses. Interior wall panels—gypsumboard or wood paneling laminated to steel studs—are aligned by wood-block spline (*right*) and fastened at top and bottom with clips.

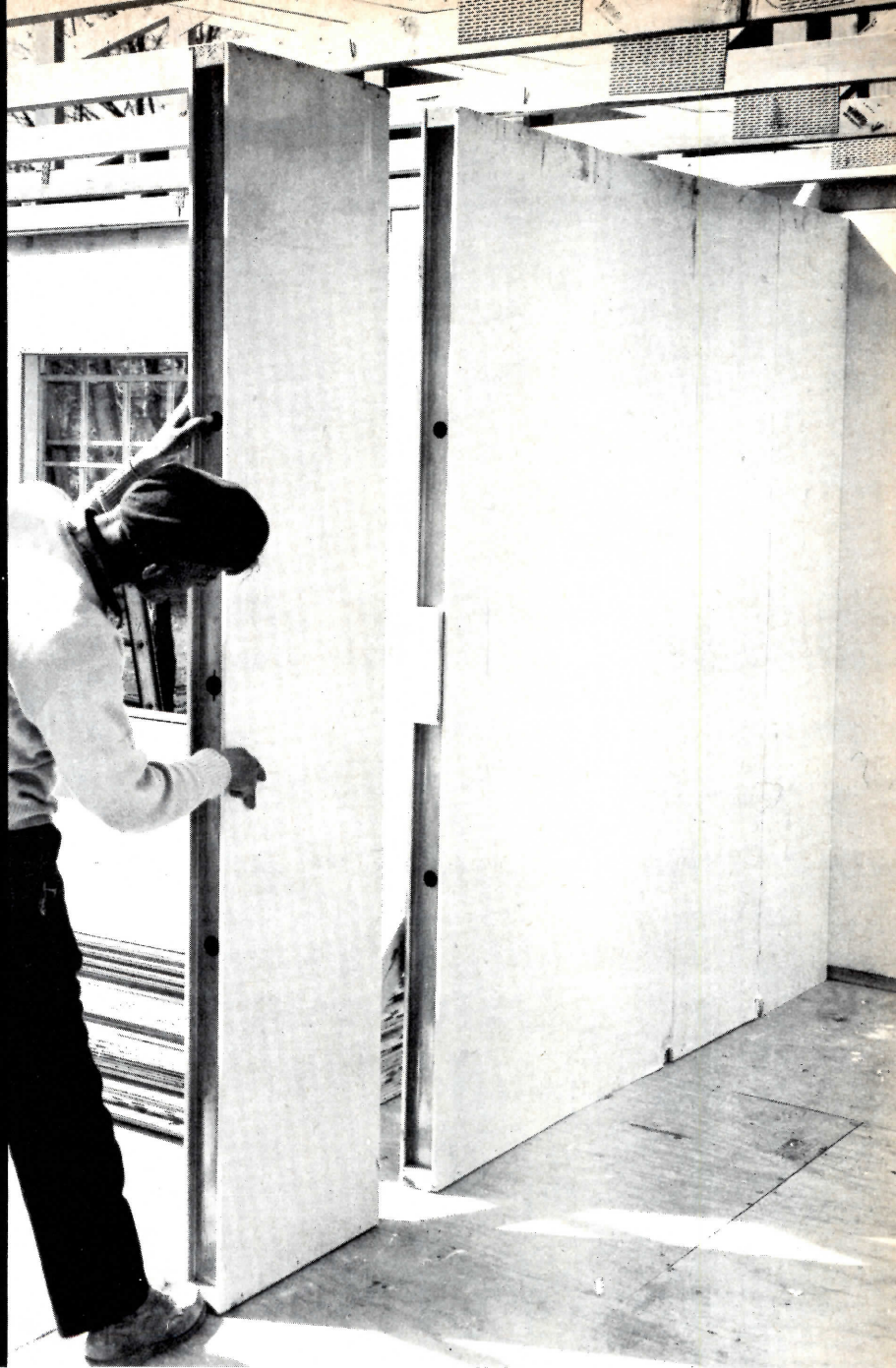

crete floors, so the idea of adding steel studs and steel doors is not as radical as in single-family housing.

But the main reason for U.S. Steel Homes' growing share of the apartment market is that it now offers a versatile wall system instead of a stock package. Its basic steel-stud wall panel, 4' wide, is made with several combinations of facing materials to meet a wide variety of aesthetic needs and performance criteria.

For example, the exterior panel is offered with 1) steel cladding on one side and vinyl or high-porosity gypsumboard on the other, 2) cedar siding on one side and lauan paneling on the other, 3) $\frac{1}{2}$ " fiberboard on one side and $\frac{1}{2}$ " high-porosity or regular-face, foil-back gypsumboard on the other or 4)

$\frac{1}{2}$ " fire-code gypsumboard on the inside, $\frac{1}{2}$ " fiberboard on the outside and mineral wool between for a one-hour fire rating.

The interior panel comes with either lauan, gypsumboard or $\frac{1}{2}$ " fire-code gypsumboard on both sides.

Both interior and exterior panels are available in 10' as well as standard 8' heights and with or without thermal insulation and sound-deadening material.

The system is used not only for apartments and houses but also for vacation houses, relocatable classrooms, motels and dormitories. It even includes a high-rise curtain-wall panel that is fastened from inside by screwing through a steel-channel flange.

Besides being adaptable in its engineer-

ing, U.S. Steel Homes is adaptable in its use of materials. Steel is used only where it is economical and practical. It is also combined with or displaced by competitive materials wherever necessary to save money or to avoid sales resistance. Examples:

U.S. Steel Homes sells only aluminum and wood windows. It stocks cast-iron as well as steel bathtubs, also uses fiberglass tubs for its vacation cottages. Wherever studs must be cut at angles, wood is substituted for steel since the relatively low volume of such components does not justify special steel designs. Wherever interior loadbearing walls are required, they are made with wood studs because the standard steel stud for interior walls is nonloadbearing.

This combination of materials results in a
continued

Steel-framed wall panel starts with machine-made studs

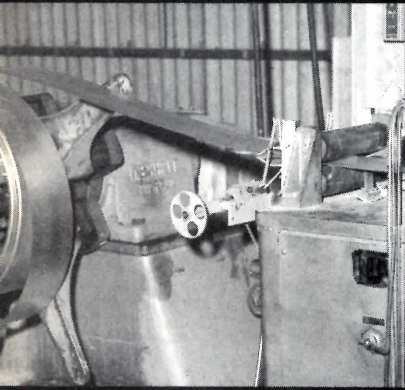

Steel coil feeds into . . .

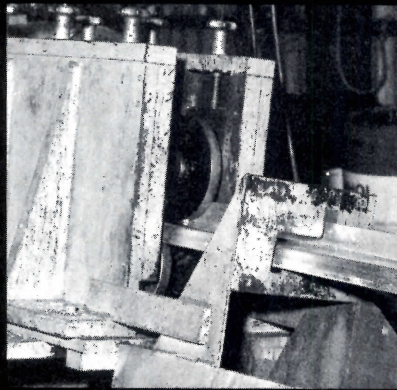

channel-shaping machine . . .

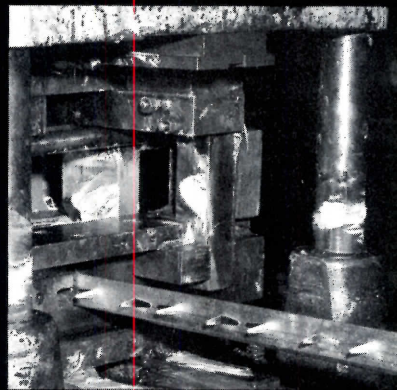

which punches out barbs . . .

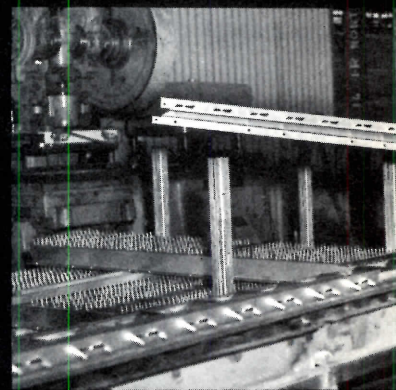

and cuts *finished studs* to length

Steel studs and drywall are laminated with adhesive

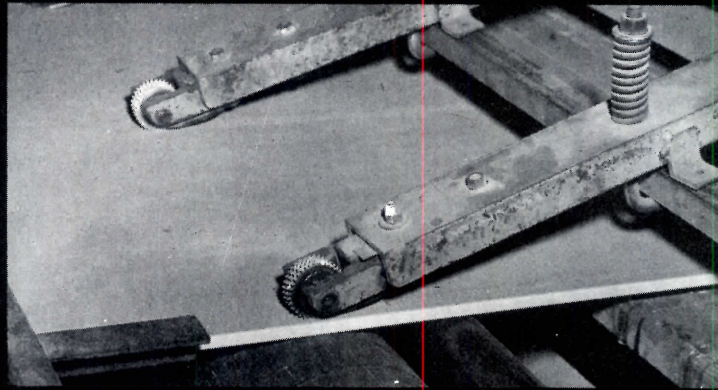

Gypsumboard surface is perforated before . . .

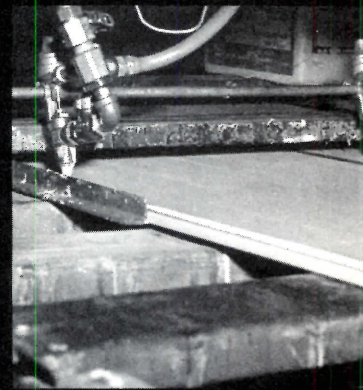

adhesive bead is applied . . .

fairly orthodox construction system with some long-term benefits. One of the most notable is the elimination of nail pops because gypsumboard and other interior wall facings are laminated to the steel channels with heat-cured adhesive. Exterior sheathing or siding is clinched onto the exterior studs by means of integral barbs punched out of the steel. Except for an occasional use of sheet steel to beef up door or window headers, all other structural members in roofs, floors and ceilings are wood.

At the job site exterior panels are attached to specially milled wood plates by nailing through extensions of steel studs. With *slab construction*, interior panels are fastened at the bottom by nailing metal clips to the slab and then nailing through the clips into the bottom wood members of

the panels; they are fastened to the ceiling joists by toe-nailing through the top wood members of the panels. With wood subflooring, panels are fastened by toe-nailing through the top and bottom wood members.

Wiring is fished through predrilled holes in the steel channels, but most other operations—e.g., hanging cabinets and taping and finishing drywall joints—are carried out conventionally. Standard components include a steel soffit-fascia-gutter system and steel exterior doors. Options are steel siding, stainless-steel kitchen sinks, steel bathtubs, steel closet shelving and steel bifold closet doors.

While the apartment boom is giving steel manufacturers the best marketing opportunity they have ever had among homebuild-

ers, another factor—drastically rising lumber prices—is giving them a new competitive edge.

Lumber and plywood are now at their highest price levels since 1959, after rising 50% and more within the past 12 months. A Pennsylvania prefabricator who paid less than \$100 per thousand board feet for studs and joists up to a year ago now pays \$140 to \$150 for spruce and \$165 to \$175 for fir. An Indianapolis lumberyard reports a price rise from \$88 to \$128 for spruce. Government indexes for fir show a rise from 104.4 in January '67 to 136.1 in July '68. Window- and door-frame stock has risen 80% in many areas, causing a comparable rise in door and window prices. Lumber shortages and long waits for deliveries are spreading, prices are expected to continue rising, and

The



...and the



Wise new idea for your bathrooms... the first surface-mounted ceiling heater-light combination. Eliminates costly recessing in concrete ceilings... gives you both instant radiant heat and a modern drop lens light fixture in a single economical installation. Circulating fan deflects heat down from ceiling. For remodelling, replaces any old ceiling light fixture with both heat and light. Model CR1-L.

Air King's ingenious new 2-speed fan: Quiet as a cat, yet delivers a powerful 110 CFM on high speed. Ideal for high rise construction—ventilates even the largest bathrooms, yet maintains lowest noise level. Complete with push-button control switch and wall plate. Model BF-100. Also available in single speed 90 CFM Model BF-80.

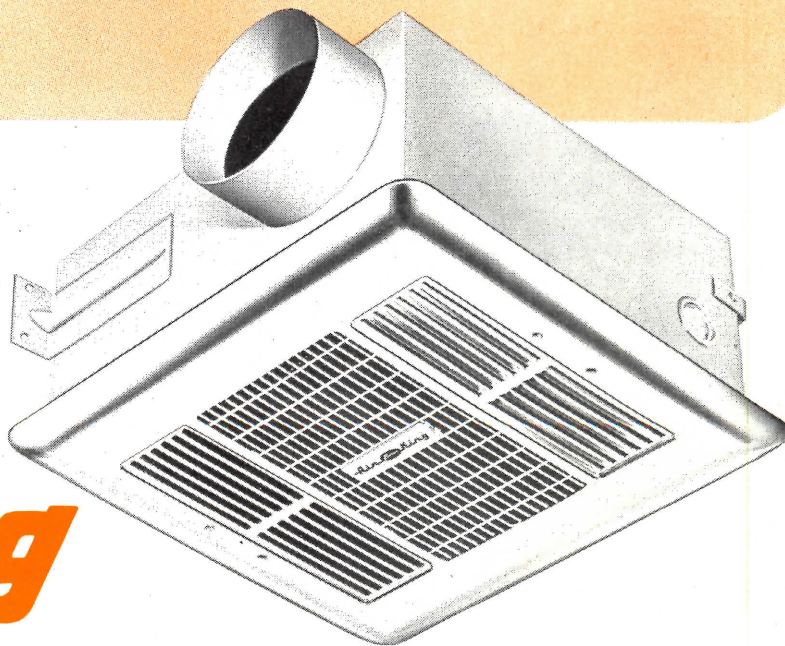

Air King

Better Built-Ins For Apartment Bathrooms

write for complete information:

BERNS AIR KING CORPORATION • 3050 N. Rockwell St. • Chicago, Illinois 60618

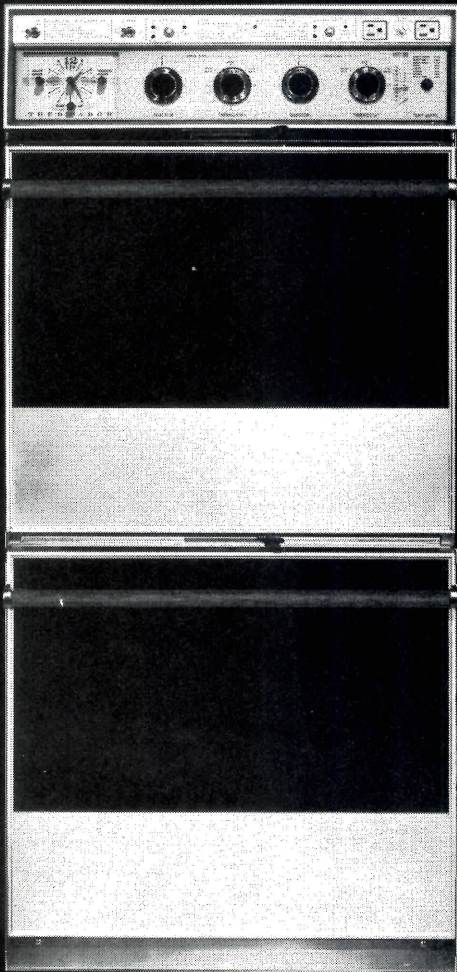

THERMADOR ELECTRIC SELF-CLEANING OVENS REALLY ARE DIFFERENT

It's this difference that sells the kitchen.

Thermador Self-Cleaning Ovens are the only ones with their own built-in exhaust system. Fresh air is circulated around the oven frame, mixed with the hot air from the cleaning process and exhausted to the outside at relatively low temperatures. No smoke, fumes or odors can escape into the kitchen.

This exclusive self-ventilating system operates automatically during the self-cleaning process and during prolonged broiling and baking. Operates manually for regular broiling or baking.

And to provide double assurance of a smoke-free kitchen, Thermador Self-Cleaning Ovens have a self-sealing, gasketless door (an award winning feature). This means no leakage and no fragile gasket to be cleaned around and replaced regularly.

Thermador makes the difference. If you sell Thermador, they'll know you sell Quality.

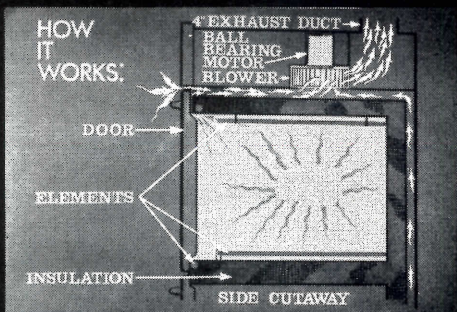

THERMADOR

5119 District Blvd., Los Angeles, California 90022,
Dept. HH-1A

America's Finest Bilt-In Appliances
Come from Thermador
Often Copied . . . Never Equalled

Division of Norris Industries

sell more homes with a genuine...

Genie[®]

AUTOMATIC GARAGE DOOR OPENER SYSTEM by ALLIANCE



- Pre-sold nationally advertised and widely known
- Proved performance and reputation in garage door opener field
- Quality product by quality manufacturer
- Easy installation
- Dependable — to assure satisfaction
- Reliable — to prevent call backs

Genie is an easily demonstrated, desirable convenience that helps builders sell homes. Your prospects can operate it themselves and immediately recognize its many benefits without leaving the comfort and safety of their car. Whatever the weather, a touch of a button opens the door... turns on the light... closes the door... locks up tight.

It has been proved that it is easier to sell your home when you... "LET GENIE DO IT!"

**FOR THE COMPLETE GENIE STORY
VISIT OUR BOOTH #1016 AT THE
NAHB SHOW JANUARY 13-17**



**offer your
new home
prospects
the convenience
of year-round
all-weather
protection**



the ALLIANCE Manufacturing Co., Inc. ALLIANCE, OHIO 44601

(Subsidiary of Consolidated Electronics Industries Corp.)

Maker of the famous Antenna-Rotator — Alliance Tenna-Rotor[®] "TV's Better Color Getter!"

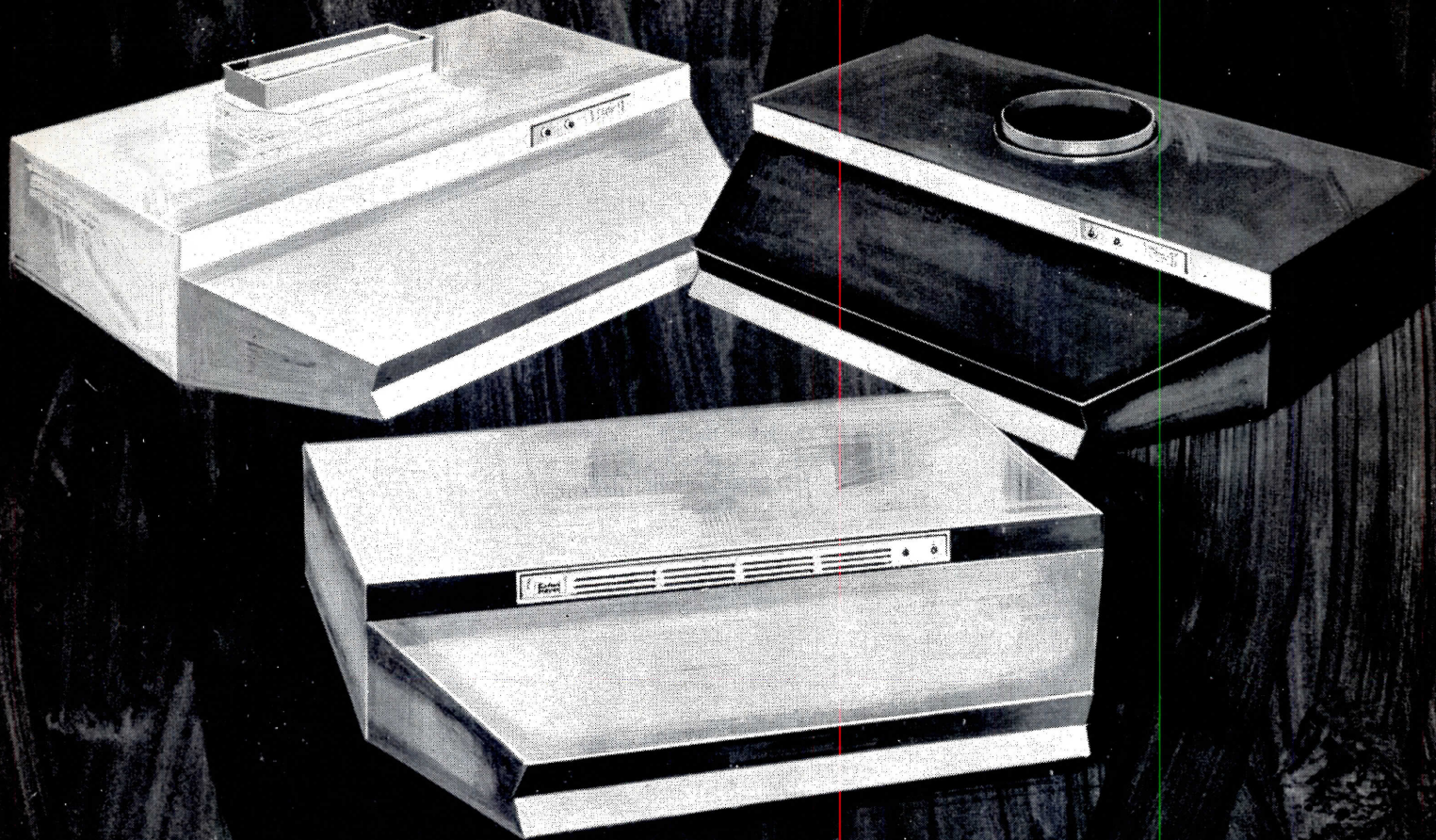

BROAN-NEW! Two-speed, quality-built hoods for the budget-conscious — the Colony House line

Choose a Colony House Hood with rectangular duct, at 140 CFM (damper included) lists from \$33.50...the round duct model at 160 CFM lists from \$30.50...or the duct-free which lists from \$37.50

All three come in Coppertone, Avocado, Stainless Steel and White, and are

available in either 30" or 36" widths.

Broan quality features include two-speed control, a lifetime washable grease filter (and in the duct-free, an additional activated charcoal filter), 100 watt light. In short, more hood for your money.

Send for Colony House Hoods literature.

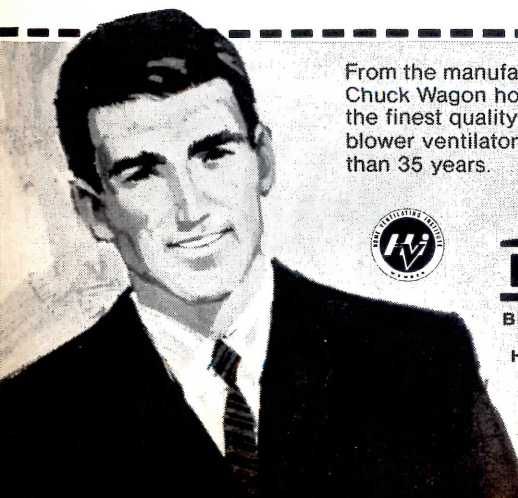

From the manufacturers of custom-made Chuck Wagon hoods, Lo Sone fans, and the finest quality hood line led by dual blower ventilators... for more than 35 years.



BROAN
BROAN MANUFACTURING
CO., INC.
HARTFORD, WISCONSIN
53027

BROAN MANUFACTURING CO. INC., Hartford, Wisconsin
Rush your Colony House Hood literature.

NAME _____

FIRM _____

ADDRESS _____

CITY _____

STATE _____

ZIP _____

I am a:

Contractor

Builder

Dealer

Architect

Distributor

Quiet and compact!

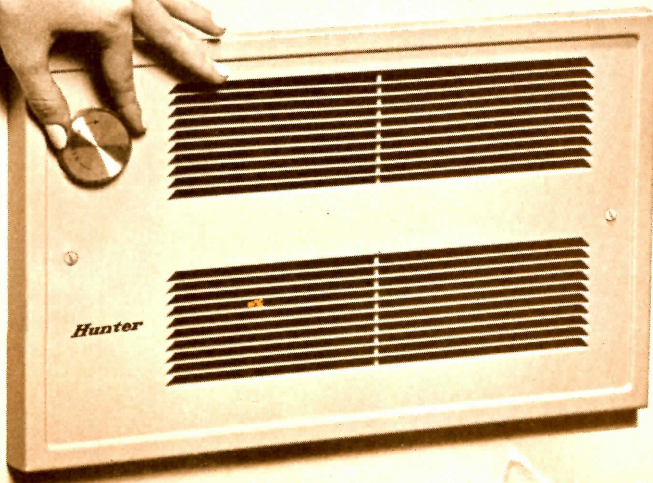

Hunter Hide-Away[®] gives more heat more quietly than any other small fan-forced electric heater

- MOTOR MATCHED to wattage to give right air movement automatically
- 1500, 2000 or 2500 watt models—all the same heater size
- VERSATILE positioning at any height on wall
- ATTRACTIVE design, beige finish (chromed for bathroom, 1250 watts)
- THERMOSTAT built in or wall mounted
- IDEAL for homes, apartments, motels, offices

Hunter Electric Heat *It's Matchless!*
Hunter makes a complete line of electric heaters of all types.

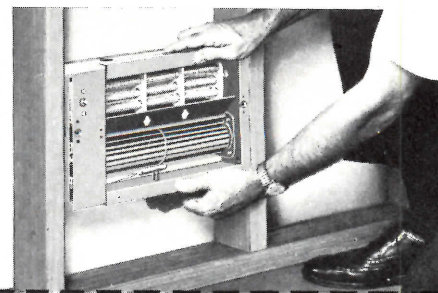

MAIL TODAY FOR DATA

Hunter Division, Robbins & Myers, Inc.
2804 Frisco Ave., Memphis, Tenn. 38114

Please send full information on Hunter
Electric Heat.

Name _____

Company _____

Street _____

City _____ State _____ ZIP _____

CASINGS DRYWALL STUD

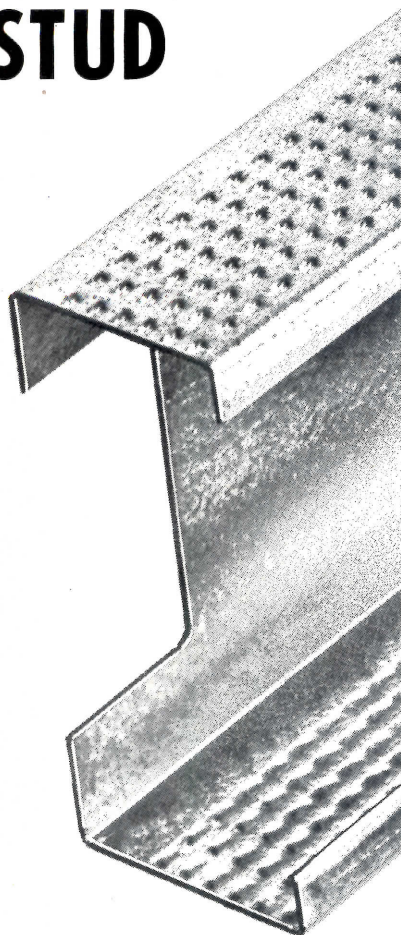

TRY IT!

We would like to do business with YOU! Please write for sample and latest catalog. They will be sent to you by return mail.



WEST MIDDLESEX, PA., 16159
West Coast Address:
P.O. Box 236, No. Hollywood, Calif. 91603
Phone: (213) 877-8262

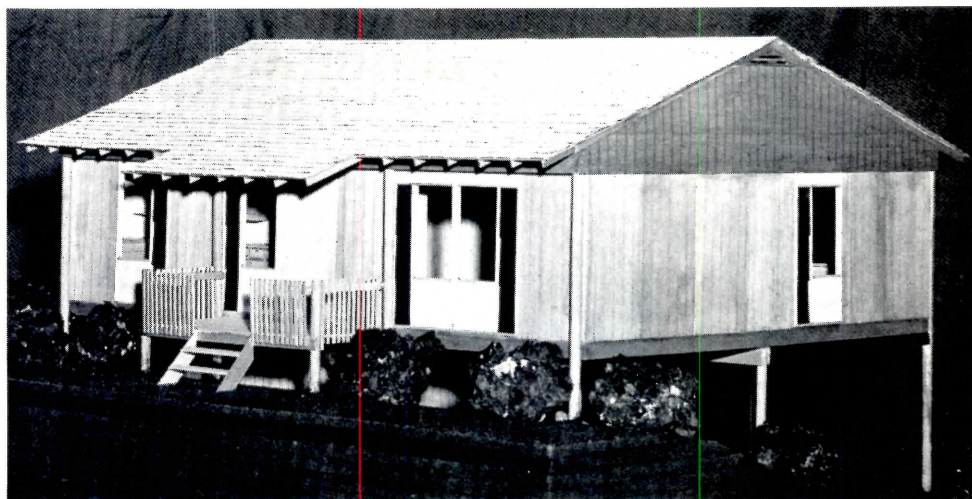

SCALE MODEL demonstrates how pressure-treated poles serve as both foundation and structural frame on a sloping site. Open space under house provides both carport and storage area.

Here's a new approach to housing the rural poor

Wood specialists of the U.S. Forest Service designed the bare-bones house shown above plus two others for rural families with \$3,000-a-year incomes. Like many low-income-housing schemes, none of the designs has been built yet.

With no more than scale models, Forest Service engineers claim the houses can be built for \$6 a sq. ft. plus land, financing, outside utilities, kitchen appliances and builder's profit. They also intend that the floor plans should house up to 12 persons, largely through an abundance of built-in sleeping space.

Builders may have some reservations about the design of the houses, but they should find many of the construction ideas worth considering. Each of the houses contains an assortment of cost-cutters borrowed from a variety of sources, including the mobile-home industry, and adapted to rural housing needs. Examples:

Pole foundations and structural frames. They lower the cost of building foundations on rocky or mountainous land and, on steep slopes, provide free space for a carport under the house. Furthermore, they lower

framing costs and increase plan freedom by eliminating loadbearing walls.

Lightweight stressed-skin panels. Interior partitions are made of 2x2 framing and glued-on 1/4" plywood; they are anchored to floor and ceiling with metal angles. The partitions are designed for on-site prefabrication with hand tools.

Fixed-glass windows. These are prefabricated as part of the nonloadbearing wall system and are coupled with opaque sliding panels for ventilation (*photo, below*).

Plastic walls and countertops. The same pour-on plastic used for bathroom and laundry-room floors is applied to bathroom walls in place of ceramic tile. Vinyl sheet flooring is used on counters as a substitute for laminated plastic.

Wood raceways for wiring. Horizontal wires are concealed in baseboards, vertical wires are behind door trim.

One-layer flooring. Tongue-and-groove 1x4s are nailed directly to floor joists.

For free plans and specifications, write to Southeastern Forest Experiment Station, Forestry Sciences Laboratory, Carlton St., Athens, Ga. 30601.

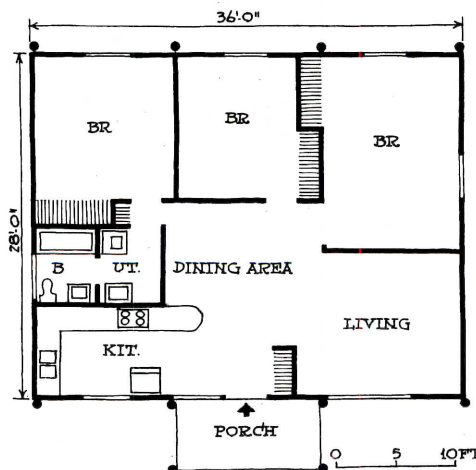

COMPACT PLAN, strong on dining and sleeping space, is meant to house families of up to 12.

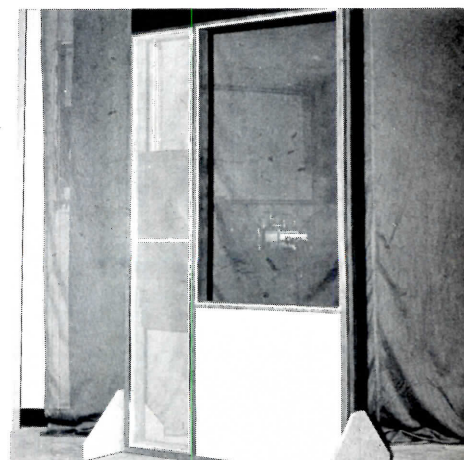

FIXED-GLASS WINDOW PANEL, prefabricated on site, is ventilated by sliding panels at left.

New products start on p. 108

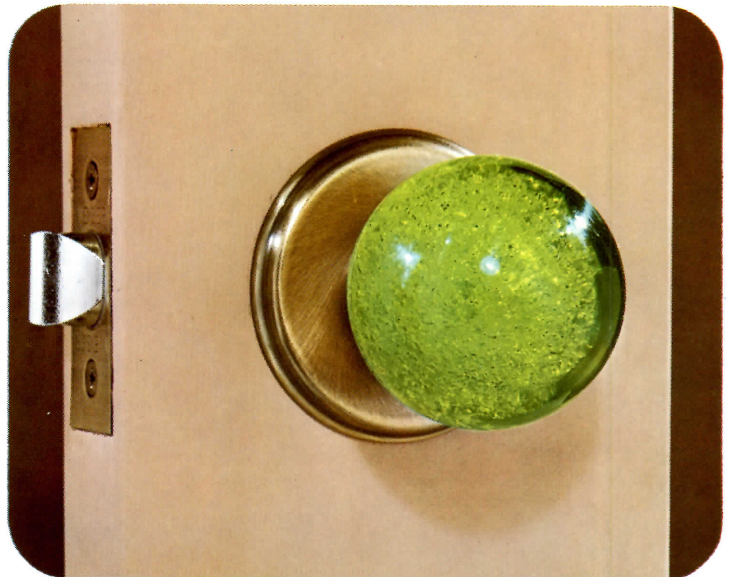
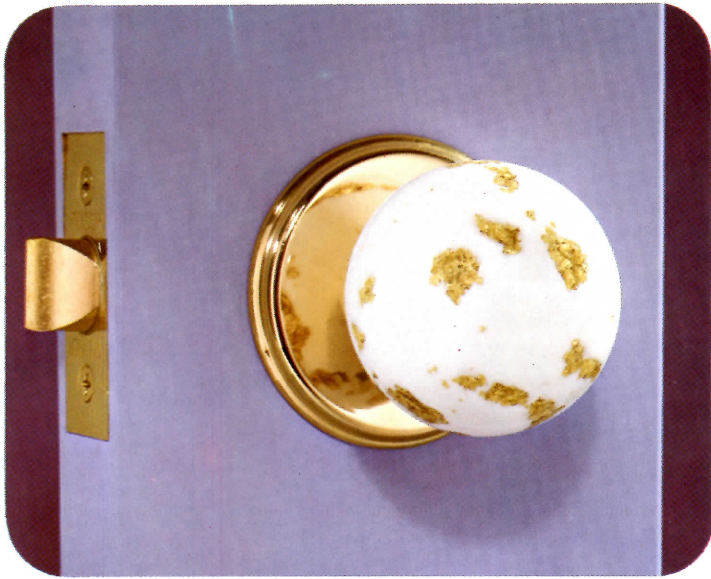

Custom - Crafted

The beauty of crystal—the durability of marble! New G Series locks by Weiser introduce glass-like knobs in four distinct colors—clear gold, olive crystal, white gold, and clear crystal. Custom-crafted, these decorative knobs open up interesting new possibilities in decoration for interior doors. Colored knobs may be combined with a metal rose of any Weiser finish—thus providing a perfect coordination with the entrance door locks used on the home.

WEISER® LOCKS

WEISER COMPANY • SOUTH GATE, CALIFORNIA
DIVISION OF NORRIS INDUSTRIES

“LOCKING-BY-KNOB” CONVENIENCE IS EXCLUSIVE WITH WEISER

heating & air conditioning



Evaporator-blower cooling unit for hydronically heated homes will be available in 1969 in 1½-, 2-, 2½-, 3-, 3½-, 4- and 5-ton capacities for use with maker's low-silhouette (18" high) condensing units. York, Pa. *Circle 307 on Reader Service card*

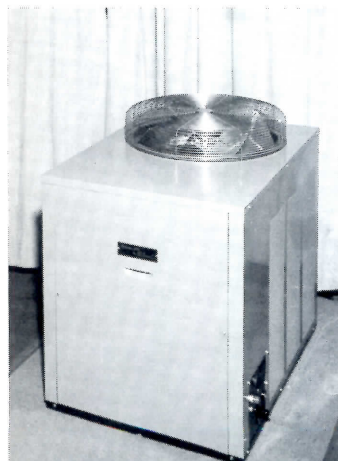

Three-ton chiller is air-cooled, produces 7.2 gpm of 45° water, attaches to furnace system for air conditioning or is used in industrial cooling processes. Only 40"x 29"x34"—50% smaller than earlier models. Arkla Air Conditioning, Shreveport, La. *Circle 308 on Reader Service card*

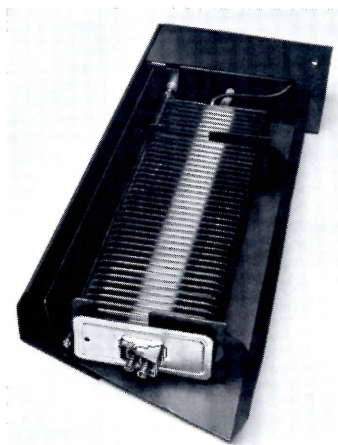

Electric baseboard heater in cutaway form shows safety switch at top of unit and ¼" gap between back and top that permits cool air from floor to mix with warm air and keep the steel enclosure cool. Derham Manufacturing, Corvallis, Ore. *Circle 309 on Reader Service card*

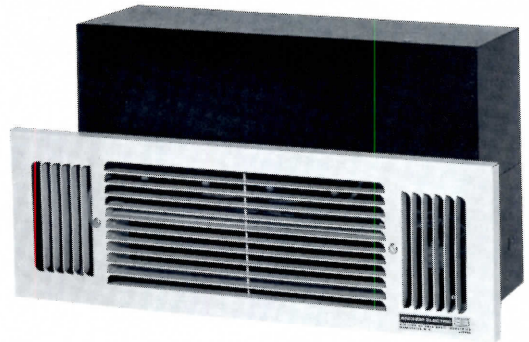

Wall heater installs easily between studs, has a 5"x15" grille that protrudes only ⅝". The fan-forced heater has two safety thermostats and interchangeable wattages of 750, 1100, 1500 and 2250. Anchor Electric, Manchester, N.H. *Circle 310 on Reader Service card*

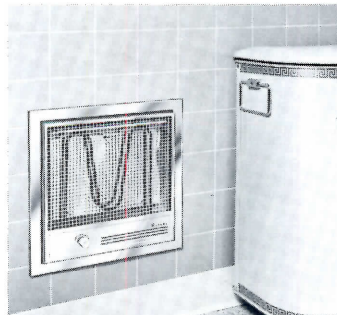

Radiant element provides fast, even heat for bathrooms. Unit is available in three wattages, two voltages, six models. Grille is 10½" high and 14½" wide. Slip-strap mounting permits easy installation between studs. Hunter, Memphis, Tenn. *Circle 311 on Reader Service card*

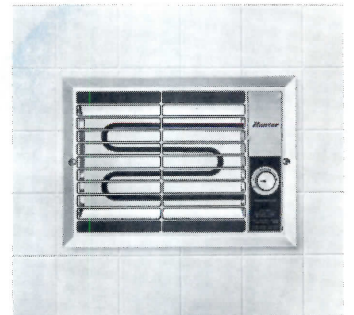

Bathroom heater provides radiant heat, has thermostat for accurate control. When recessed, unit measures 15" square, extends 1" from wall. When unit is surface mounted, it measures 12½" square, protrudes 2½". Markel Electric Products, Buffalo, N.Y. *Circle 312 on Reader Service card*



Air conditioning system, left, has cooling capacities of 34,000, 48,000 and 63,000 Btuh, can be used with solid-state gas furnace, right. Small unit at left of furnace is electronic air cleaner. General Electric, Louisville, Ky. *Circle 313 on Reader Service card*

New products continued on p. 114



USS United States Steel
TRADEMARK

tools & equipment

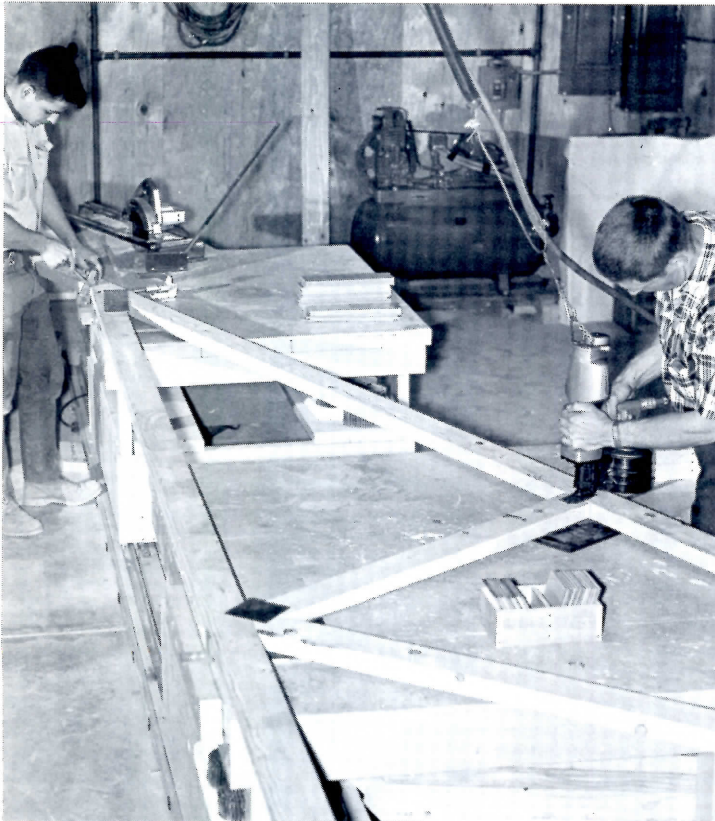

Floor stapler automatically positions and drives 1/2" 16-gauge staples in any thickness of hardwood flooring. Handle and shoe may be removed to convert tool to a conventional, trigger-operated stapler for sub-flooring, etc. Bostitch, East Greenwich, R. I. Circle 317 on Reader Service card

Portable saw has a self-contained 6 1/2-hp gas-powered motor, weighs 29 3/4 lbs and will cut through concrete, masonry and metal, wet or dry. A built-in governor assures constant cutting speed under all conditions. Robert G. Evans, Kansas City, Mo. Circle 318 on Reader Service card

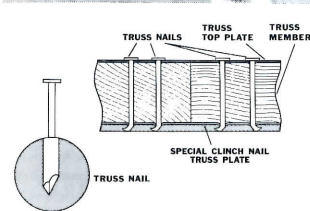

Speedier truss system is nailed from only one side, eliminates time and labor of flipping. Special divergent-point nails anchor in a two-ply steel-and-composition-board bottom plate (cross-section, left). Bostitch, East Greenwich, R.I. Circle 314 on Reader Service card



Power buggy, only 30" wide so it will go through standard doors, is equipped with traction tires. A 7-cu.-ft. hopper will carry bulk materials, and a flat tray holds blocks and bricks. Aeroil Products, South Hackensack, N.J. Circle 319 on Reader Service card

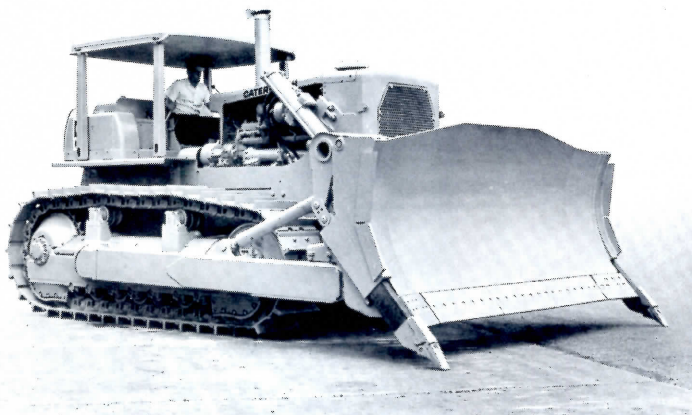

Rip dozer has heavy duty hydraulically adjustable ripper shanks at both ends of the blade that act as bits in penetrating clay soils, help to pull cutting edge in and reduce cycle time. Also can be used to cut roots, remove stumps. Caterpillar, Peoria, Ill. 61602.

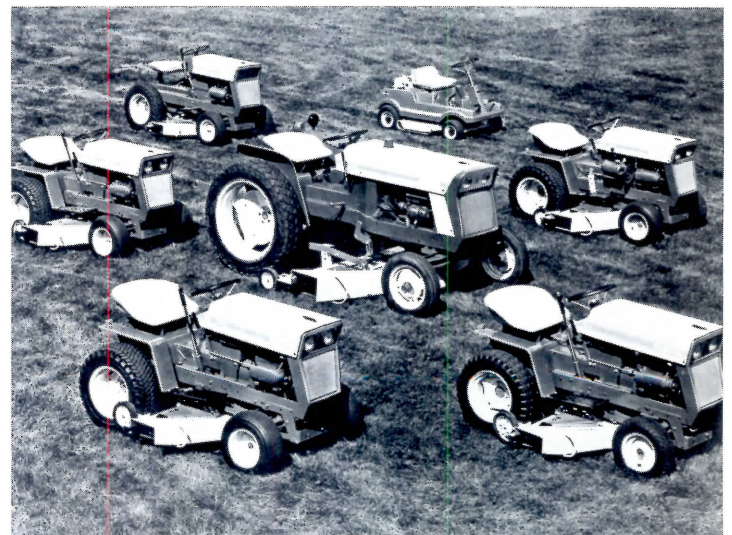

Small tractors include a riding mower (top), five small garden models and a new, larger, 15-hp tractor (center) that can be used with a 48" or 60" rotary mover, snow thrower or front-mounted blade. International Harvester, Chicago. Circle 320 on Reader Service card

Laminate trimmer makes a flush or bevel cut on flat or curved surfaces. Unit has 1/2-hp motor, adjustable depth guide, clear plastic chip shield, nonrolling guide to stop glue build-up, can be converted to a router. Black & Decker, Towson, Md. Circle 316 on Reader Service card

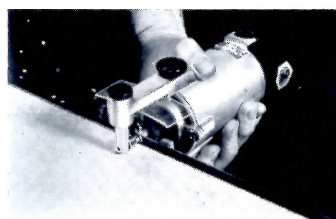

Memo to Bldg. Prod.
Advertising Dept.

Subject: House & Home
Planners Digest

Bob:

It might be a good
idea to look into
this method of
distributing our product
literature to home-
planning families
next year.

Here are some
possible advantages:

1. The Digest can
deliver our message
daily throughout the
year to custom-house
planners identified
by F. W. Dodge — over
50,000 a year!

2. Each literature
request would come
from a pre-qualified
positive prospect.

3. We'd save money
by sending literature
only to bona-fide
new custom-house
planners.

Why not give House & Home
a call for more
information today.

— Jim

**SPECIAL
INTRODUCTORY
OFFER**

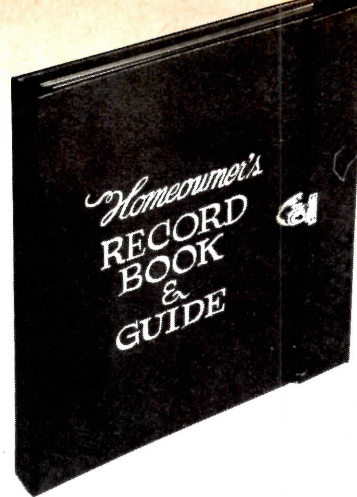

Home owner's Record Book & Guide

**GIVE THIS HANDSOME,
LOOSE-LEAF BOOK TO YOUR NEW HOME-
OWNERS — IT'S DESIGNED TO HELP THEM
WITH DAY-TO-DAY MAINTENANCE PROBLEMS
AND WITH ESSENTIAL RECORD KEEPING.**

IT INCLUDES—

★ CONVENIENT FORMS FOR RECORDING
HOME PURCHASE DATA . . . REPAIR AND IM-
PROVEMENT COSTS . . . TAX AND MORTGAGE
PAYMENTS . . . WARRANTY DATES . . . YEAR-
TO-YEAR UTILITY CHARGES . . . INSURANCE
DATA, ETC.

★ USEFUL INFORMATION ON HOME MAINTENANCE PLUS REPAIR TIPS ON LAWN, TREE AND SHRUBBERY CARE . . . IDEAS FOR PRESERVING AND IMPROVING THE VALUE AND BEAUTY OF A NEW HOME.

IT HELPS YOU—

- EXPLAIN HOME MAINTENANCE AND CARE TO YOUR BUYERS
- MINIMIZE CALL BACKS
- CREATE GOOD WILL
- ADD A PERSONAL TOUCH TO YOUR MERCHANDISING

THIS UNIQUE BOOK IS YOURS ON A FREE EXAMINATION OFFER FROM

HOUSE & HOME PLANNER'S DIGEST

A unique publication distributed daily to new home-planning families reported by F. W. Dodge giving manufacturers an opportunity to offer their product literature to over 50,000 prime prospects annually.

To obtain a
copy of the
**HOMEOWNER'S
RECORD BOOK
& GUIDE**
for **FREE**
examination
and approval,
fill in and mail
this coupon

HOUSE & HOME PLANNER'S DIGEST
330 West 42nd Street, New York, N.Y. 10036

Please send me the HOMEOWNER'S RECORD BOOK & GUIDE for 10 days free examination. In 10 days I will remit \$6.95 plus any local tax and postage. Otherwise, I will return the book postpaid.

NAME _____

ADDRESS _____

CITY _____ STATE _____ ZIP _____

tools & equipment

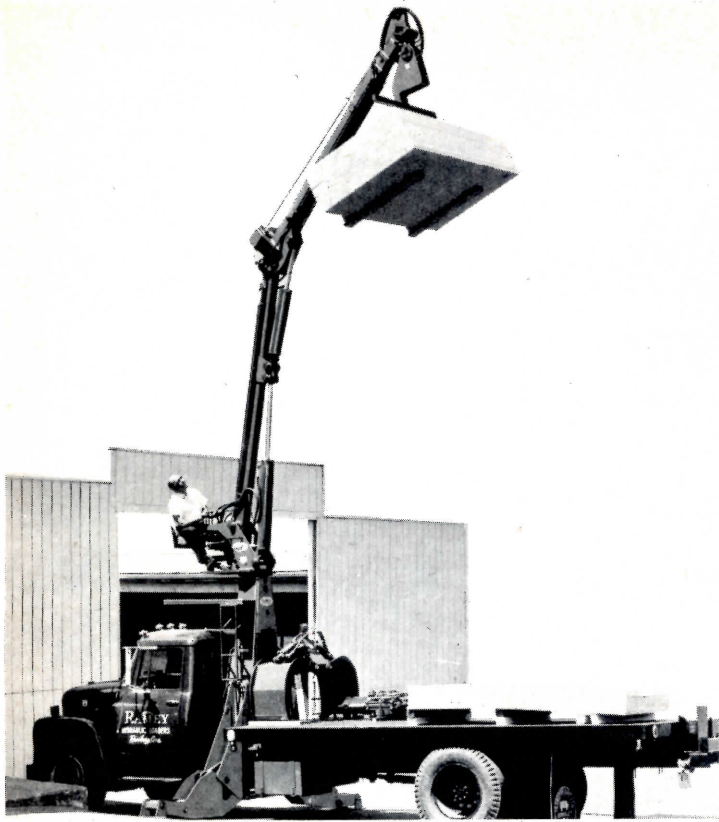

Hydraulic crane, truck-mounted for mobility on the construction site, has a lifting capacity of 12,000 lbs., a vertical reach of 32' and a 360° swing to turn load to any position. Ramey Hydraulic Loaders, Roseberg, Ore. *Circle 321 on Reader Service card*



Electric caulking gun dispenses all standard 1/10- and 1/2-gallon cartridge-packed compounds in a smooth uniform bead at any of a full range of trigger-controlled speeds. Only 7 1/4 lbs., the tool can apply heavy sealants without heat. Skil, Chicago. *Circle 322 on Reader Service card*

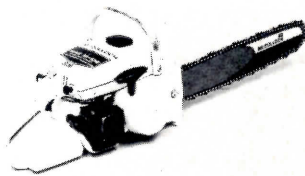

Gas-powered saw has electric starter and an alternator/generator that recharges the starter batteries during operation. Saw weighs only 15 lbs., has fingertip chain oiling, sound muffler, comes with 16" guide bar. McCulloch, Los Angeles. *Circle 323 on Reader Service card*



High-speed trencher has a double digging chain line and a high-capacity banana-shaped conveyor belt, will dig trenches from 2' wide to 5' deep at up to 1,500' per hour. The 60-hp unit has hydraulic controls. Davis Mfg., Wichita, Kans. *Circle 324 on Reader Service card*

outdoor living

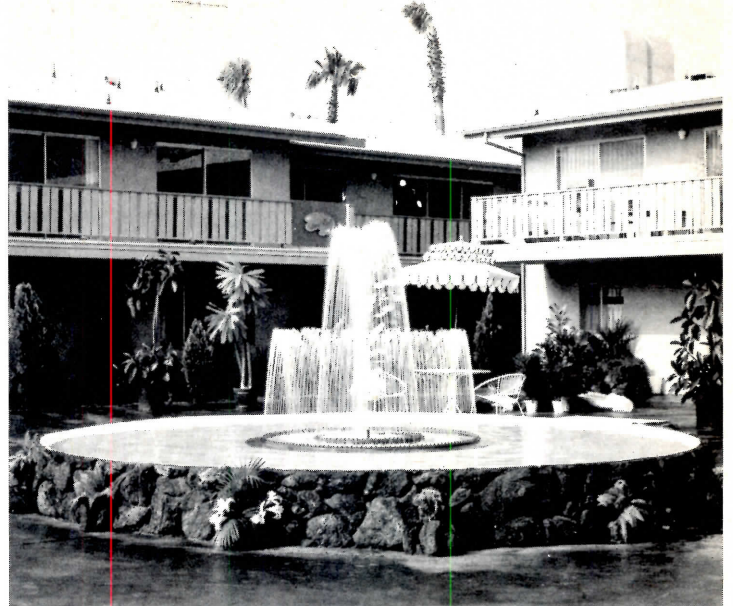

Two-ring jet fountain helps to landscape a courtyard in a garden apartment project. Manufacturer has a complete line of sprays, jets, rings, pumps, lights, and self-contained units. Roman Fountains, North Hollywood, Calif. *Circle 325 on Reader Service card*



Self-contained fountain is shipped completely assembled and ready to plug in and use after adding recirculating water. Many sizes and a variety of static or changing water patterns are available. Fibre-Metal Products, Chester, Pa. *Circle 326 on Reader Service card*

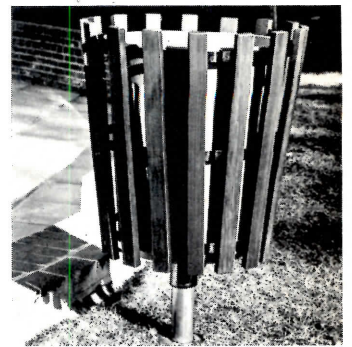

Trash receptacle is good-looking as well as strong. Made of steel, it is faced with walnut-stained cypress slats that resist rot. The 27-lb. unit comes with 22-gal. plastic container and 2' steel mounting post. Victor Stanley, Dunkirk, Md. *Circle 327 on Reader Service card*

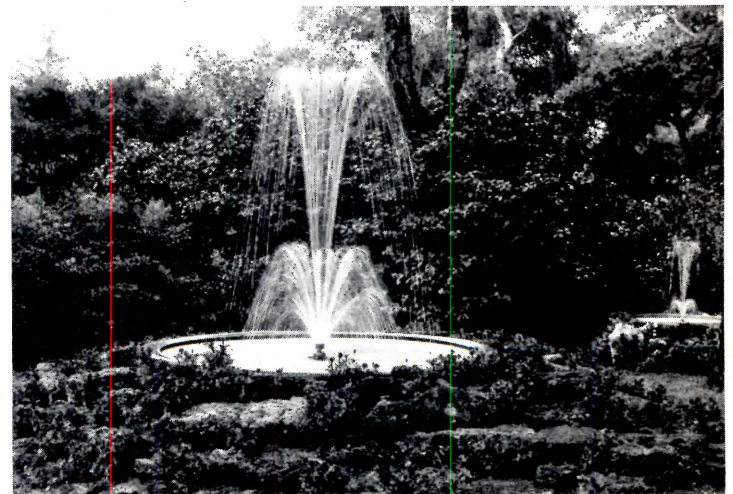

Three-tier fountain has rotating nozzles that break up water streams into light-catching droplets. Complete one-, two- or three-tier fountains include 3' to 8' bowls, recirculators, underwater lighting. Rain Jet, Burbank, Calif. *Circle 328 on Reader Service card*

Float-Away Door, announces **no** price increase.

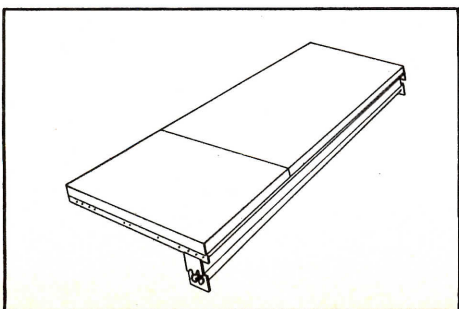
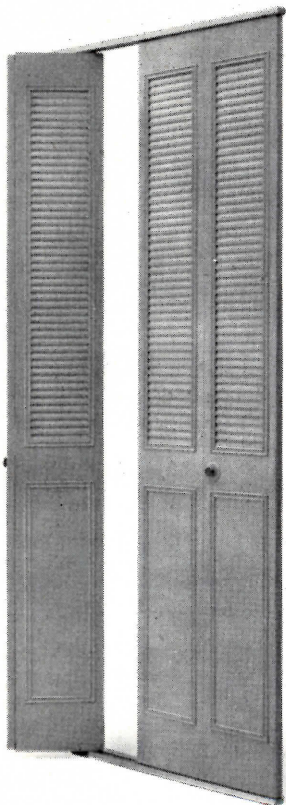

If you were a Float-Away dealer, you'd already be selling the finest metal bifold and expandable shelf available at any price.

And now, with no price increase and the same top quality line, you'd be more competitive than ever.

But, our closet system dealers can offer more than the best.

They can offer the most.

For starters, Float-Away is the only closet door manufacturer who can make closet doors to meet oddball opening sizes. An invaluable service to the rehab or high-rise builder.

If you're supplying a rehab or high-rise customer, we can develop special delivery installation programs that could save him hundreds of hours.

And Float-Away doors, (available in five decorator styles), can be installed by unskilled labor.

All this plus a quality closet door and shelf line that hasn't gone up a penny.

If you'd like to become a Float-Away dealer or customer, contact us in Atlanta.

We're opening some new territories and we wouldn't want you to lose your competitive edge.

FLOAT-AWAY[®]
COMPLETE CLOSET SYSTEMS

Department HH-12, 1123 Zonolite Road, N.E., Atlanta, Ga. 30306 Phone (404) 875-7986

water treatment



Kitchen water purifier measures only 19 $\frac{3}{4}$ " x 10 $\frac{1}{2}$ ", is only 5 $\frac{5}{8}$ " deep and can be mounted on or under wall cabinets near a water line. Unit processes three to six gallons daily, removes all chemicals. Culligan, Northbrook, Ill. *Circle 329 on Reader Service card*

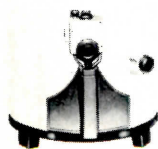

Gas water heater carries a ten-year warranty, is one of a five-model line of gas and LP-gas units that come in 30-, 40- and 50-gal. sizes, are 45 $\frac{3}{16}$ " or 51 $\frac{1}{16}$ " high. Heaters have recovery rates of 37.8 gal. and up per hour. Ruud Mfg., Chicago. *Circle 330 on Reader Service card*

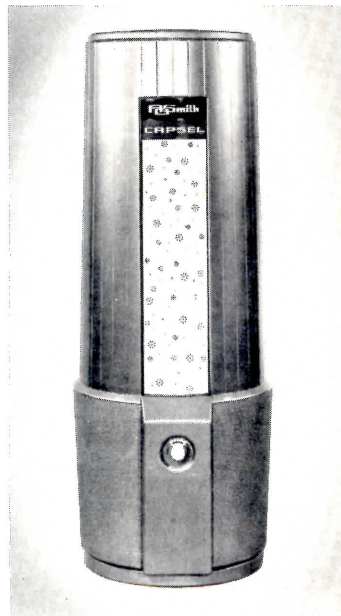

Prototype water heater has a glass-lined steel tank with a permanently bonded polyurethane jacket that insulates and protects the unit. The plastic jacket replaces the usual glass fiber insulation and outer steel shell. A. O. Smith, Kankakee, Ill. *Circle 331 on Reader Service card*

structural materials

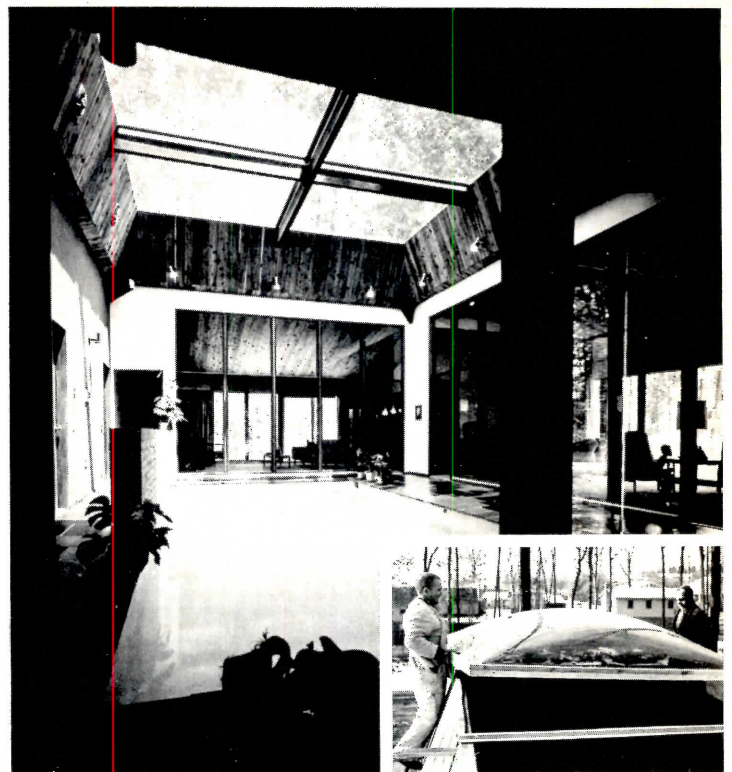

Plexiglas skylights, shown covering an indoor pool, can be used singly or in multiples. The tinted acrylic filters sun's rays, controls glare and heat. Lightweight domes can be handled by two men. Rohm and Haas, Philadelphia. *Circle 332 on Reader Service card*

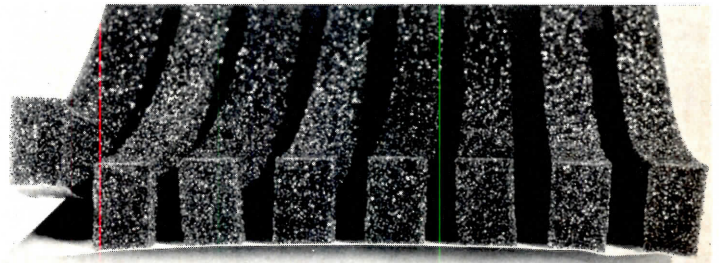

Foam tape for use as an acoustic caulking material or weatherstripping, is adhesive-backed, sticks to any surface, comes in flexible rolls in $\frac{1}{4}$ " to 54" widths and $\frac{1}{16}$ " to 1" thicknesses in many colors. Arlon Products, Harbor City, Calif. *Circle 333 on Reader Service card*



Partition system has prefabbed panels of gypsumboard glued to paperboard ribs. Panels are shipped flat, opened to 1 $\frac{5}{8}$ " rib thickness at site, positioned on floor runner, tipped into position and attached. Pabco, San Francisco. *Circle 334 on Reader Service card*



Underneath it all, the strong, silent kind

Structural sub-flooring and resilient carpet underlayment, all in one fast application.

Completely eliminates built-up plywood sub-flooring. Installs directly on floor joists 16" on centers. It is a strong, rugged work deck. Plates and room partition framing are constructed right on 4-Way Floor Decking.

With rubber pad and 44-ounce carpet, lab tests proved an Impact Insulation Class of 72. Sound Transmission Class of 50. This is outstanding

sound-deadening construction.

And—it's easy construction. All edges are matched tongue and groove. Panels are 2' x 8', weigh only 48 pounds. Saw-cuts are effortless. Tools stay sharp, clean.

Made with three plies of 15/32" insulating Homasote building board, permanently laminated with a waterproof glueline and sanded on the bottom side, 4-Way Floor Decking is a strong, silent 1-11/32" thick.

It's stocked at building material suppliers from coast-to-coast.
Call your local supplier for free samples or write direct
to Homasote, Dept. HH-1.

8-605



na

Company

TRENTON, N. J. 08603



Cash in...

on the **WORLD** of **Leisure Living**

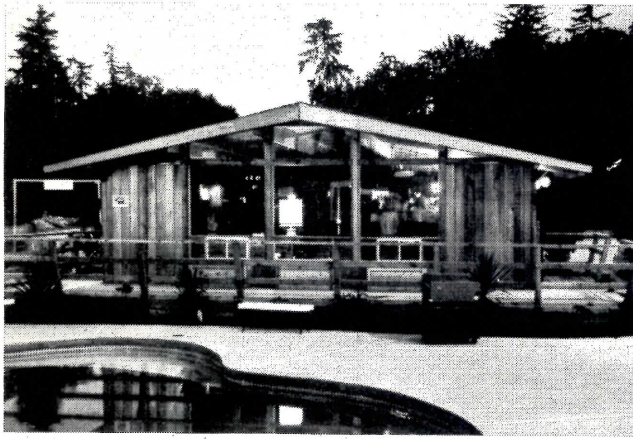

Sell World-Famous **LINDAL Cedar Homes**

Cash in on the booming leisure home market, today's fastest growing industry. To reap the rewards of this tremendous market, investigate our complete Lindal distributor-dealer profit package.

- Distributor and Dealer operation manuals
- Promotion and financing assistance
- Lindal Cedar Homes construction manual
- Designs for PERMANENT HOMES, APARTMENTS and MOTELS also available.

Send for 34-page, 4-color brochure and detail information on "Profit Potentials with LINDAL Cedar Homes."



LINDAL Cedar Homes

9004 S. 19th St., Tacoma, Washington 98465
Phone A/C 206-564-3581

Other plants in England • Ireland • Canada

NEW PRODUCTS

kitchens



Range water tap dispenses 185° water at a touch right at cooking area, can be used for instant hot drinks, sauces and other food preparation, as well as soaking pans. Range, 30" wide, is being test-marketed. Frigidaire, Dayton, Ohio. *Circle 335 on Reader Service card*

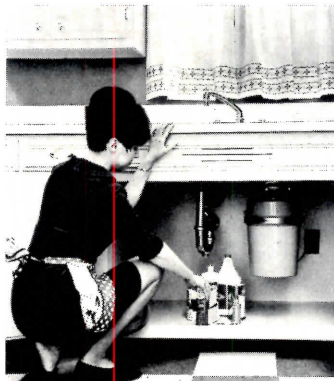

Food waste disposer features two exclusive improvements: 1) positive-pressure seal to prevent water damage to motor and 2) grinding chamber of urethane with a stainless steel liner to reduce noise and vibration. Maytag, Newton, Iowa. *Circle 336 on Reader Service card*



Simulated-wood front makes range part of overall kitchen decor. Traditional (above), Early American and French Provincial designs are available as optional extras in the form of easy-to-install kits. Philco-Ford, Philadelphia, Pa. *Circle 337 on Reader Service card*



Convertible refrigerator door can be hinged left or right to meet space requirements. Handles are interchangeable and hinge-screw holes pre-drilled, so conversion can be made with ordinary tools. Gibson, Greenville, Mich. *Circle 338 on Reader Service card*

New products continued on p. 128

the persuaders . . .

SELF-CLEANING OVENS

You'll appeal to the ladies when you install a Whirlpool self-cleaning oven in your homes. It eliminates the household chore women dislike more than any other. The Whirlpool "do everything" oven that even cleans itself automatically is now available in several models for the builder. There are two 24" built-in models in brushed chrome, white or decorator colors. Also Connoisseur® ranges which fit flush with counters and provide two ovens—a self-cleaning one below and an eye-level at top. And, of course, free-standing models with self-cleaning ovens. Ask your Whirlpool distributor for complete details.

Whirlpool
CORPORATION

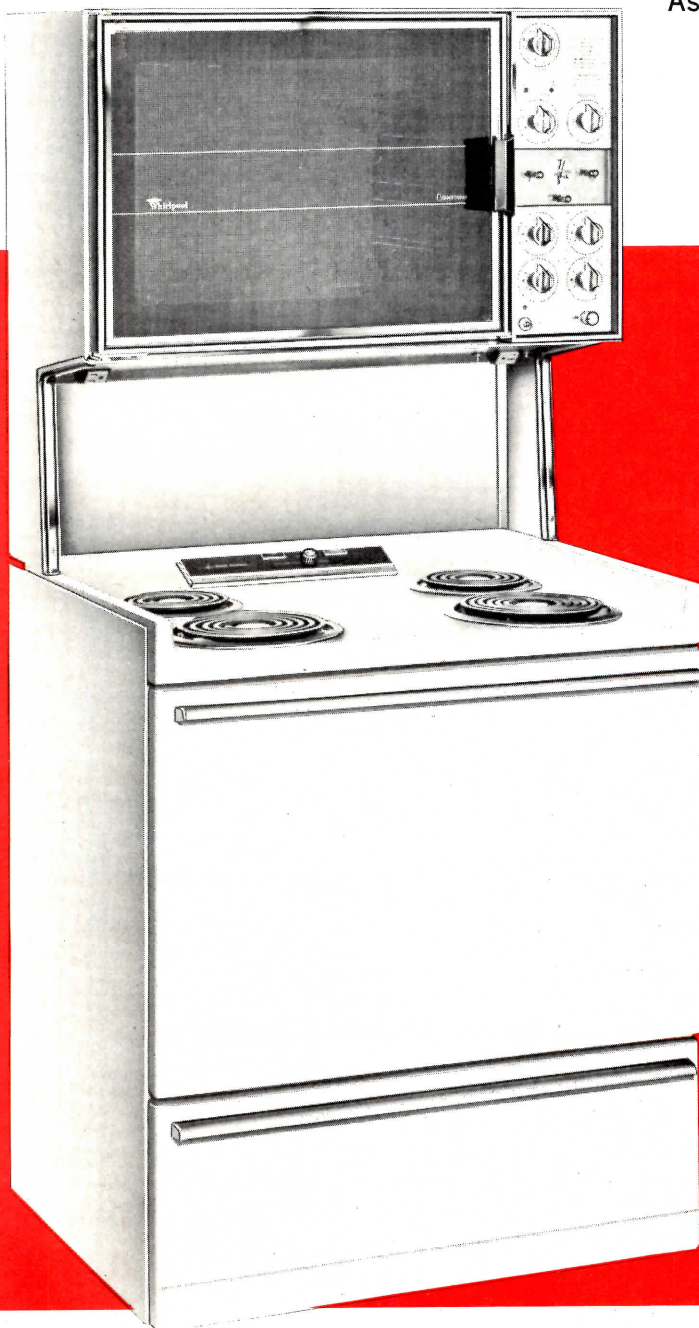

Model RTE9678 Imperial Connoisseur has a self-cleaning lower oven, plus an eye-level oven above.



Model RTE197 lets you build in every modern cooking convenience, minus the drudgery of oven cleaning.

flooring



Parquet flooring is available in a new pattern in oak, teak, maple, walnut or cherry. Hardwood tiles are 14¼" square and 5/16" thick, can be cemented on wood or insulated concrete sub-flooring. Harris Mfg., Johnson City, Tenn.
 Circle 340 on Reader Service card



Outdoor-indoor carpet made of olefin fiber features easy maintenance—it can be cleaned with a vacuum cleaner or a hose. It's available in smooth or embossed patterns in a variety of colors that are fade proof. Orcco Industries, Encino, Calif.
 Circle 341 on Reader Service card



Brick-patterned sheet vinyl, .055 thick, is flexible enough to form coving and has a moisture-resistant backing that makes it suitable for use on all grade levels. It meets FHA standards. Robbins Products, Tuscumbia, Ala. Circle 342 on Reader Service card



Striped tile makes a small room look larger when 12"x12" vinyl asbestos tiles are all laid in the same direction, creating parallel lines. Seven colors include orange, brown, off-white and blue. Kentile Floors, 58 Second Ave., Brooklyn, N.Y. 11215

New products continued on p. 130

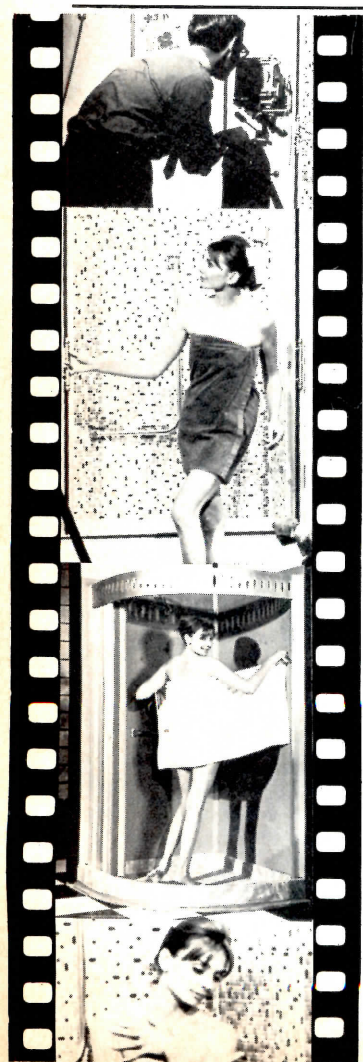

Coming Soon... to your Office!

*An exciting film about
 the bath, beauty—and the builder*



DON'T MISS

AND THE BATH
STARRING SHOWERFOLD®
TUB AND SHOWER ENCLOSURES

Here's your chance to preview the sight and sound of Showerfold's new story. See what's up and coming in shower and tub enclosures and Marblemold® shower floors. See Showerfold product innovations which will make your bathrooms more appealing.

Want to know more? Use the coupon to arrange for your own personal preview showing of Showerfold's "Beauty And The Bath" . . . in your own office, at your convenience.

SHOWERFOLD DIVISION
KINKEAD INDUSTRIES INCORPORATED.

5860 N. Pulaski Road, Chicago, Illinois 60646
 12601 Western Ave., Garden Grove, Cal. 92641

Circle 109 on Reader Service card

MAIL COUPON TODAY

Showerfold Division, Kinkead Industries Inc.
 5860 N. Pulaski Road, Chicago, Illinois 60646

YES! Please set up my personal preview of Showerfold's film, "Beauty And The Bath",

on _____ at _____
 Date Time

Phone me to confirm this arrangement. _____

NAME _____

COMPANY _____

ADDRESS _____

CITY & ZIP _____

TELEPHONE _____

At Ruskin Place, 7 Maytags average 300 loads a week with not one repair in 15 months.



"If we had it to do over, we'd have only Maytags," writes Mrs. Bonnie Eicholz.

Ruskin Place is a new garden apartment complex of 104 units in Kansas City, Missouri. Luxury facilities include a clubhouse, heated indoor-outdoor pool, sauna bath, party room, and two brands of washing machines. Seven of these are Maytags.

Writes the Manager, Mrs. Bonnie Eicholz: "There is no comparison with Maytags and the other machines on repair costs. Not one cent has been spent for parts, even though the Maytags have had heavier use.

We haven't had a single repair since the Maytags were installed 15 months ago. The other brands of washers all have cost as much for repairs as the money they take in. The Maytags are ticket-operated, which means no problem with making change, pilferage, and vandalism. If we had it to do over, we'd have only Maytags."

The tenants also seem to prefer the Maytags. According to Mrs. Eicholz, "4 out of 5 families use the Maytags. In some cases, people walk a block to get to them.

They like the big tubs. And Maytag gets the sand out of children's clothes, doesn't leave it in like the other machines."

We don't say that all Maytags will equal the record that Mrs. Eicholz has enjoyed. But dependability is what we try to build into every Maytag Commercial Washer and Dryer.

MAIL NOW! Find out what Maytag dependability can do for you.



THE MAYTAG COMPANY Advertising Dept. HH-1 Newton, Iowa 50208.		
GENTLEMEN: Please rush me full information on the dependable Maytag-Equipped Laundry package.		
Name _____		
Address _____		
City _____	State _____	
Zip Code _____	Phone _____	

electrical equipment



Dimmer switch permits continuous adjustment of light level from full brightness to candle glow by means of a rotary control. Use of standard switch boxes and cover plates makes installation easy. Ideal Industries, Sycamore, Ill. Circle 347 on Reader Service card



Combination fan/light for bathrooms can be wired for separate or simultaneous operation of vent fan and light. Blower motor floats on neoprene cushions, providing a low sound-level rating. The silver-anodized grille is 13 1/4" across and extends 2 1/8" below the ceiling. Adjustable brackets included. NuTone, Cincinnati, Ohio. Circle 349 on Reader Service card



Garage-door opener is radio-controlled from car: driver opens door and turns on light by pushing button on hand-held transmitter. Another push closes the door; light goes off automatically within two minutes. The system is designed for easy installation, carries a one-year guarantee. Stanley, New Britain, Conn. Circle 350 on Reader Service card

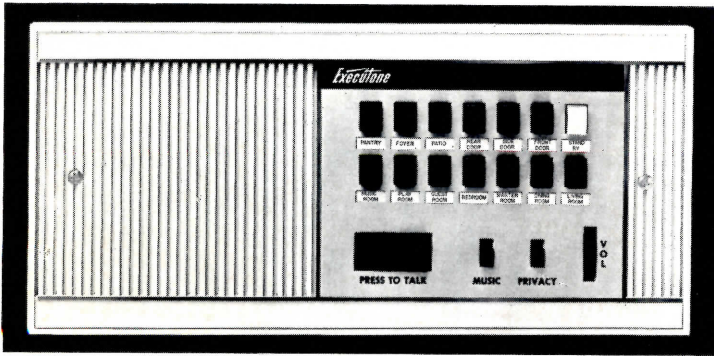

Intercom system offers quick communication with front and back doors plus up to 11 rooms at the touch of a button. It can also be connected to a hi-fi or radio to pipe music throughout the house. Executone, Long Island City, N.Y. Circle 348 on Reader Service card

New Literature starts on p. 135

This is not an offering of these shares for sale, or an offer to buy, or a solicitation of an offer to buy, any of such shares. The offering is made only by the Prospectus.



1,131,900 Shares

Boise Cascade Corporation

Common Stock
(\$2.50 par value)

Price \$69.50 per share

Copies of the Prospectus may be obtained from any of the several underwriters only in states in which such underwriters are qualified to act as dealers in securities and in which the Prospectus may legally be distributed.

Blyth & Co., Inc.

- | | | | |
|--|------------------------------|--|---|
| Drexel Harriman Ripley
Incorporated | The First Boston Corporation | Eastman Dillon, Union Securities & Co. | Glore Forgan, Wm. R. Staats Inc. |
| Goldman, Sachs & Co. | Halsey, Stuart & Co. Inc. | Hornblower & Weeks-Hemphill, Noyes | Kidder, Peabody & Co.
Incorporated |
| Lazard Frères & Co. | Lehman Brothers | Loeb, Rhoades & Co. | Merrill Lynch, Pierce, Fenner & Smith
Incorporated |
| Paine, Webber, Jackson & Curtis | Salomon Brothers & Hutzler | Smith, Barney & Co.
Incorporated | Stone & Webster Securities Corporation |
| Wertheim & Co. | White, Weld & Co. | Dean Witter & Co.
Incorporated | A. G. Becker & Co.
Incorporated |

December 4, 1968

Introducing the Panelpac[®]

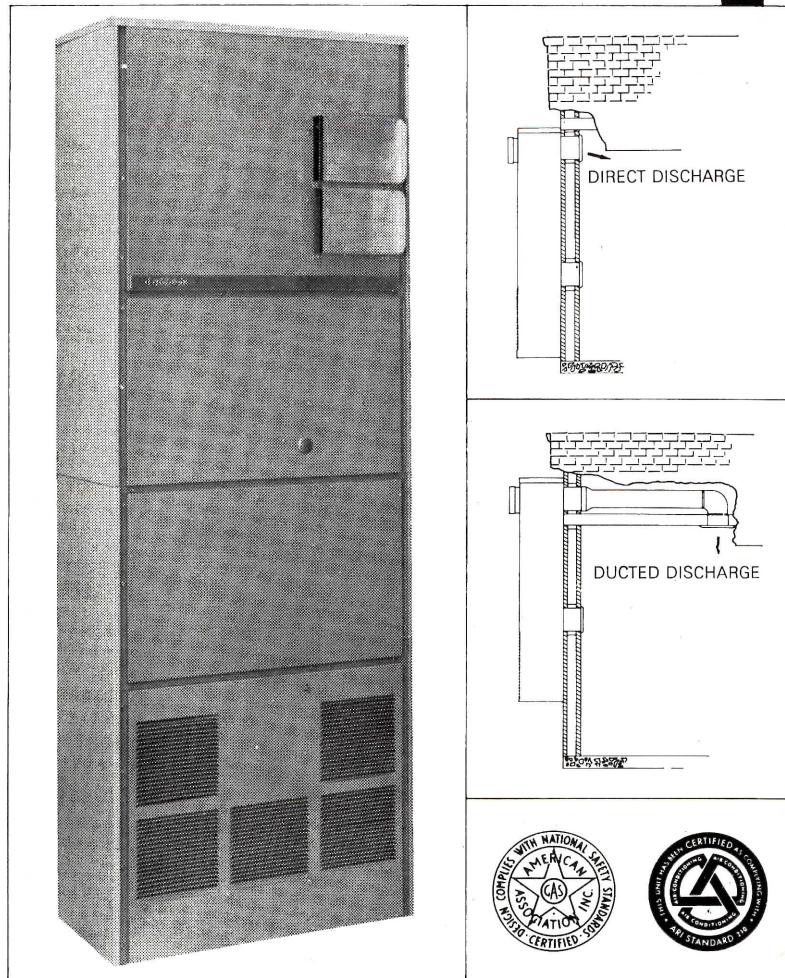

**the first gas-electric, vertical wall-hung,
year 'round air conditioner.**

And there's no venting required. The Panelpac combines Day & Night's famous Duopac reliability with a trim new potential. It may be recessed into a wall with only 4 inches exposed on the outside. Another Day & Night exclusive.

Who needs Panelpacs? Anyone concerned with pre-fabricated or relocatable buildings, add-on residential applications and new school construction or modernization. You can use free-throw or duct it into several areas. Installation is super-simple and servicing is done completely from the outside.

Day & Night Panelpacs are available as electric-electrics as well as gas-electrics. The choice is up to you.

day & night Manufacturing Company

855 Anaheim-Puente Road, La Puente, Calif. 91747

You made your point. Send me additional facts about Panelpacs.

NAME _____

ADDRESS _____

CITY _____ STATE _____ ZIP _____

HEATING • AIR CONDITIONING • WATER HEATING

HH-3

Making a kitchen work is Chambers' business

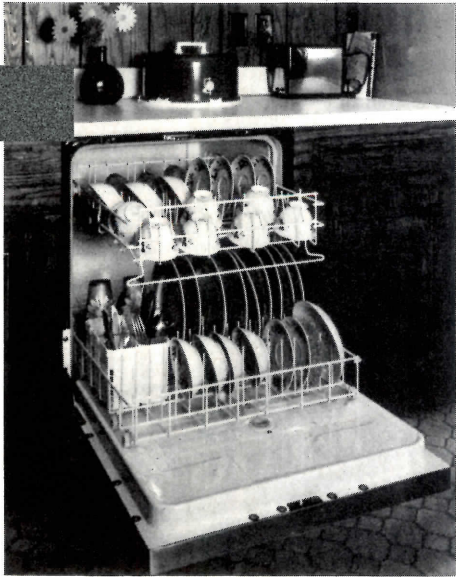

SELF-CLEAN DISHWASHER

The most advanced dishwasher on the market today. Features built-in disposer that eliminates pre-rinsing, easy push-button operation and convenient roll-out racks. • Dual Swirl-Spray Arms under both upper and lower racks • Easily installed • Automatic detergent and rinsing agent dispensers • Full choice of colors available, also Decorator Doors.

BUILT-IN REFRIGERATOR/FREEZERS

Chambers offers Refrigerator / Freezer combinations in a wide choice of models for any size kitchen. Over-under and side-by-side models available. • Completely built-in – self-supporting and self-framing • Frost-free • Positive, silent magnetic-closing doors • Automatic ice-makers available • Full choice of attractive colors, plus Decorator Doors for panels of the owner's choice.

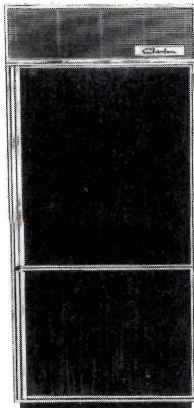

DOUBLE SELF-CLEAN OVENS

Especially designed for the kitchen that has everything! Double and single ovens feature automatic self-cleaning cycle, automatic start-stop-hold cooking. Closed-door broiling • Self-cooling – no vent needed • Meat temperature gauge • Built-in rotisserie • Automatic signal lights • Super-Thaw for cooking frozen meats • Easily installed • Beautiful styling • Full choice of colors to blend with any kitchen.

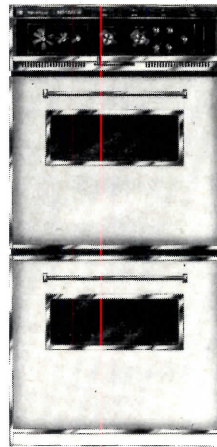

SELF-CLEANING DROP-IN RANGE

Completely automatic self-cleaning range installs easily, blends in with any decor. Features programmed start-stop-hold cooking • Closed-door broiling • Built-in Rotisserie • Easy-to-clean brushed chrome top surface • Wide choice of colors available.



CONVENTIONAL BUILT-INS

Chambers offers a complete choice of conventional built-in ovens, gas or electric. Automatic clock control. • Optional rotisserie available • Easily installed, even where space is a problem • Wide choice of colors, also Decorator Doors that accept panels of your choice.

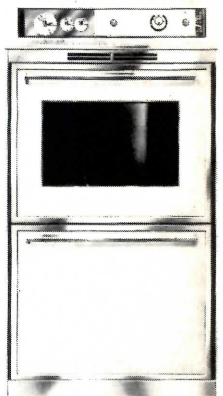

IN-A-TOP BROILER AND GRIDDLE

Featured on Chambers surface and console ranges, the In-A-Top Broiler/Griddle offers the convenience of counter-top broiling, with no burned fingers, no hot racks to touch. Available on gas or electric models. Griddle is thermostat-controlled. • Beautiful, easy-cleaning Satin Chrome finish.

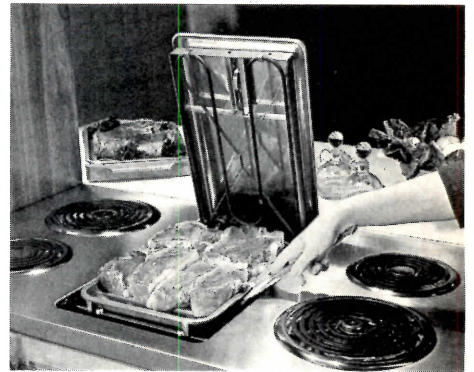

Subsidiary of Rangaire Corporation, Oxford, Mississippi 38655

For copies of free literature, circle the indicated number on the Reader Service card, p. 119.

METAL PANEL SYSTEMS, non-insulated or insulated with urethane, for walls, roofs and partitions are described in a four-color catalog that shows the full line of colors, finishes and patterns in galvanized steel or aluminum. A special interlocking sealed joint system is detailed. Glaros Products, Pittsburgh, Pa. *Circle 351 on Reader Service card*

HUBLESS PIPE FITTINGS, in forty or more types of configurations, are shown in eight pages that give weights, sizes, types of couplings and list prices. Alabama Pipe, Anniston, Ala. *Circle 352 on Reader Service card*

HUBLESS PIPE INSTALLATIONS are discussed in a 20-page booklet that gives bracing suggestions, includes black-and-white photographs and drawings of actual installations. Cast Iron Soil Pipe Institute, Washington, D.C. *Circle 353 on Reader Service card*

HEAVY-DUTY TOOLS, such as drills, sanders, jig-saws, rotary hammers and bench grinders, are listed in a 35-page catalog that shows drawings of the individual tools and their accessories and gives complete descriptions and specifications. Milwaukee Electric Tool, Brookfield, Wis. *Circle 354 on Reader Service card*

FOUNTAIN DISPLAYS are illustrated with pictures and drawings in a 29-page guide of instant fountains, fountain kits and custom water displays of all varieties. Jets, sprays and pumps, their capacities, shipping weights and retail prices.

Roman Fountains, North Hollywood, Calif. *Circle 355 on Reader Service card*

STAINLESS STEEL SINKS, catalogued by basic groups and styles in a 100-model line, then listed by size, types of finish and gauge of steel. Photographs show many model installations. Jensen-Thorsen, Addison, Ill. *Circle 356 on Reader Service card*

WOOD RESEARCH. A technical pamphlet lists all available recent research papers turned out at this top-notch laboratory. One describes a new wood-frame research house that claims savings in both labor and material. U.S. Department of Agriculture, Forest Products Laboratory, Madison, Wis. 53705.

STEEL WIRE used in prestressed concrete is described in a technical pamphlet that lists physical properties, design criteria and capacity. Charts and graphs show tests of stress and load curves for various sizes of patented strands. CF&I Steel, Denver, Colo. *Circle 358 on Reader Service card*

PAVING STONES of harder-than-granite, nonslip quartzite are shown in a four-color brochure that lists the various color combinations available and discusses the advantages of the material. Rock of Ages, Barre, Vt. *Circle 359 on Reader Service card*

WATERPROOF COATINGS for interior masonry—concrete block or stucco—in residential basements, garages, warehouses and manufacturing plants are discussed. Goodyear, Akron, Ohio. *Circle 360 on Reader Service card*

DRINKING FOUNTAINS and electric water coolers for offices and plants are featured in a four-

page four-color bulletin that contains photos and drawings of models and includes specifications and rough-in dimensions. Halsey W. Taylor, Warren, Ohio. *Circle 361 on Reader Service card*

STRUCTURAL MATERIALS of all kinds—concrete forms, sheathing, sub-flooring, decking, gypsum wall and ceiling systems, interior panels, etc.—are listed in a complete 102-page products selector guide that illustrates various products and their applications, gives specifications and details on their properties and displays the various finishes in four-color photographs. Georgia-Pacific, Portland, Ore. *Circle 362 on Reader Service card*

GLASS BLOCK is compared with sheet glass for shading and protecting capacities, with details on abnormal heat problems. Diagrams illustrate heat and light paths through glass masonry units. Glass Block Institute, Pittsburgh, Pa. *Circle 363 on Reader Service card*

WOOD DOORS of both flush and panel variety are shown in four-color photos and drawings. Types of finishes and cores, methods of installation and specifications are given and grades of woods listed. Mohawk Flush Doors, South Bend, Ind. *Circle 364 on Reader Service card*

ELECTRONIC DIMMER SWITCHES. Various styles for different wattages are illustrated in a four-page brochure that includes installation diagrams and ordering information. Ideal Industries, Sycamore, Ill. *Circle 365 on Reader Service card*

New literature continued on p. 136

DIAZIT - THE WHITEPRINTERS that perform wonders

Reproduces any typed, drawn or written material on translucent or opaque sheets.

Superior results consistently obtainable with all types of diazo material—in blue, black, red line or sepia—including

- MYLAR ■ FOILS
- ACETATES ■ FILM

Ready for immediate use, without need of special venting, wiring or plumbing. Prints to 42" wide, any length, up to 21' per minute—at material cost of 1¢ per square foot.

Take a good look at the whiteprinters that outperform others costing \$200 to \$500 more.

Priced from \$249*.

*f.o.b. Youngsville, N.C.





Circle reader service card or contact:

DIAZIT COMPANY INC.
Phone 919/556-5188
Route U.S. #1, Youngsville, N.C. 27599

Circle 123 on Reader Service card

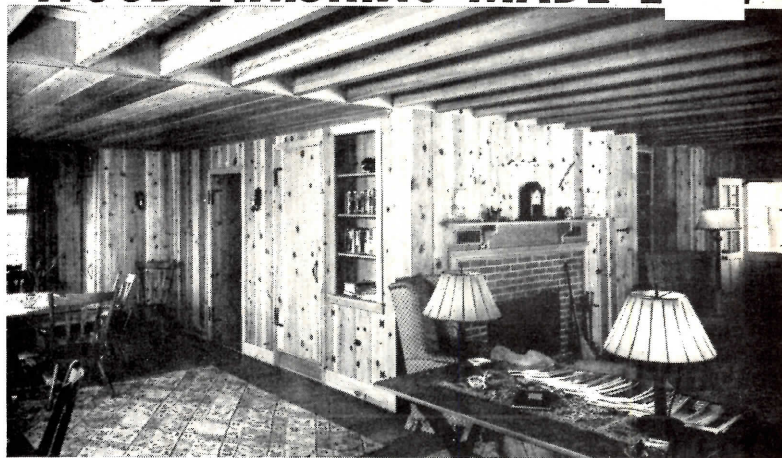
WOOD FINISHING MADE E



Home in Beach Haven, N.J.; Architect: Savery, Scheetz & Gilmore, Philadelphia, Pa.; Cabot's Stain Wax on paneling.

Cabot's STAIN WA
Stains, Waxes, Seals in one operation

Time was when wood finishing was a long, arduous task. Today, Cabot's Stain Wax does the job in a single application. This unique "three-in-one" finish, suitable for all wood paneling, brings out the best in wood, enhancing the grain and producing a soft, satin finish in your choice of twelve colors plus black, white, and natural. When a flat finish is desired, use Cabot's Interior Stains.



Samuel Cabot Inc.

130 S. Terminal Trust Bldg., Boston, Mass. 02210

- Send color card on Cabot's Stain Wax
- Send color card on Cabot's Interior Stains

Circle 116 on Reader Service card

new

refab... wood-burning

FIREPLACE

Installs in about
the space of a chair —
Approx. **5** sq. ft.

Ideal for Apartments & Townhouses

Prefabricated
complete package from
base to chimney top
— including mesh screen

Designed for corner
or wall installation — or to
stack for upper floors

**NO MASONRY—
NO FOOTERS—installs
anywhere**

MODEL
L28

Majestic[®]
Thulman[®]
fireplace

"Does it have a wood-burning fireplace?" is fast becoming one of the first things an apartment or townhouse prospect asks about! Now, with this new Majestic Thulman Fireplace you can make your answer "Yes" easier than ever. Occupying such little space and installed without ma-

sonry or footers you can always find a spot for it. Even "tuck it in" the corner, if wall space is extra tight. And records show that renters will pay \$10 to \$15 per month extra!

Write today for complete "specs" on the Model L28 as well as other Majestic Fireplaces.

Remember that Majestic also manufactures Gasilator — the gas-fired prefabricated unit; Contemporary free-standing (wood or gas) fireplaces; Decorative or heating Electric fireplaces; and the Circulator and fireplace components.

The Majestic Co., Inc., 413 Erie Street, Huntington, Indiana 46750
Circle 117 on Reader Service card

NEW LITERATURE

starts on p. 135

FIRE CONTROL SYSTEMS that include smoke detectors used in combination with electro-magnetic door holders and closers are described in an eight-page brochure that shows photographs and wiring diagrams for various applications. Eaton Yale & Towne, Bensenville, Ill. *Circle 366 on Reader Service card*

METAL DOORS AND FRAMES. An eight-page brochure with drawings of the maker's patented frame corners and heavy-duty zinc-coated doors, cutaways of a foam-core door and illustrations of the fire doors and sidelight arrangements available. Amweld, Niles, Ohio. *Circle 367 on Reader Service card*

PREFAB HOMES. Renderings and floor plan drawings that include model numbers and dimensions in catalog of a complete line of one- and two-story houses, split-levels and split-foyer models, townhouses and duplexes, as well as nursing homes and a dormitory. U.S. Steel Homes, New Albany, Ind. *Circle 368 on Reader Service card*

HUMIDIFIERS. Their advantages, methods of operation, capacities and maintenance are discussed in an eight-page booklet that includes a conversion table of outdoor-indoor relative humidity. Research Products, Madison, Wis. *Circle 369 on Reader Service card*

Annual H&H indexes

Copies of House & Home's editorial indexes for 1965, 1966 and 1967 are still available. Each is an eight-page, cross-referenced listing of subjects covered that year by this magazine. To get copies (there's no charge) write to: Reader Service Dept., House & Home, 330 West 42nd St., New York, N.Y. 10036.

RESILIENT FLOORINGS are displayed in full color in a 16-page catalog that includes information on sizes, gauges, uses, installation and specifications for vinyl asbestos tiles. Azrock Floor Products, San Antonio, Tex. *Circle 370 on Reader Service card*

ACCOUNTING SYSTEMS, especially designed to reduce contractors' costs on payroll and billing, etc., are discussed in a booklet that displays various types of accounting forms, business machines and filing equipment. Burroughs, Rochester, N.Y. *Circle 371 on Reader Service card*

HARDBOARD PANELINGS. Many grains, stains, colors and finishes are displayed in a 24-page four-color booklet that includes model numbers, installation photos and information on matching mouldings. Masonite, Chicago. *Circle 372 on Reader Service card*

WALLPAPERS. A cross-referenced guide to a complete line of more than 4,000 patterns and colors. Imperial Wallpaper Mill, Cleveland, Ohio. *Circle 373 on Reader Service card*

WALL PANELING of vinyl-clad hardboard and plywood is displayed in four-color photographs that indicate the variety of grains and stain colors available. Also shown are decorative marble-like panelings in soft colors for bathrooms. Complete details on sizes and matching trims are included. Abitibi, Birmingham, Mich. *Circle 374 on Reader Service card*

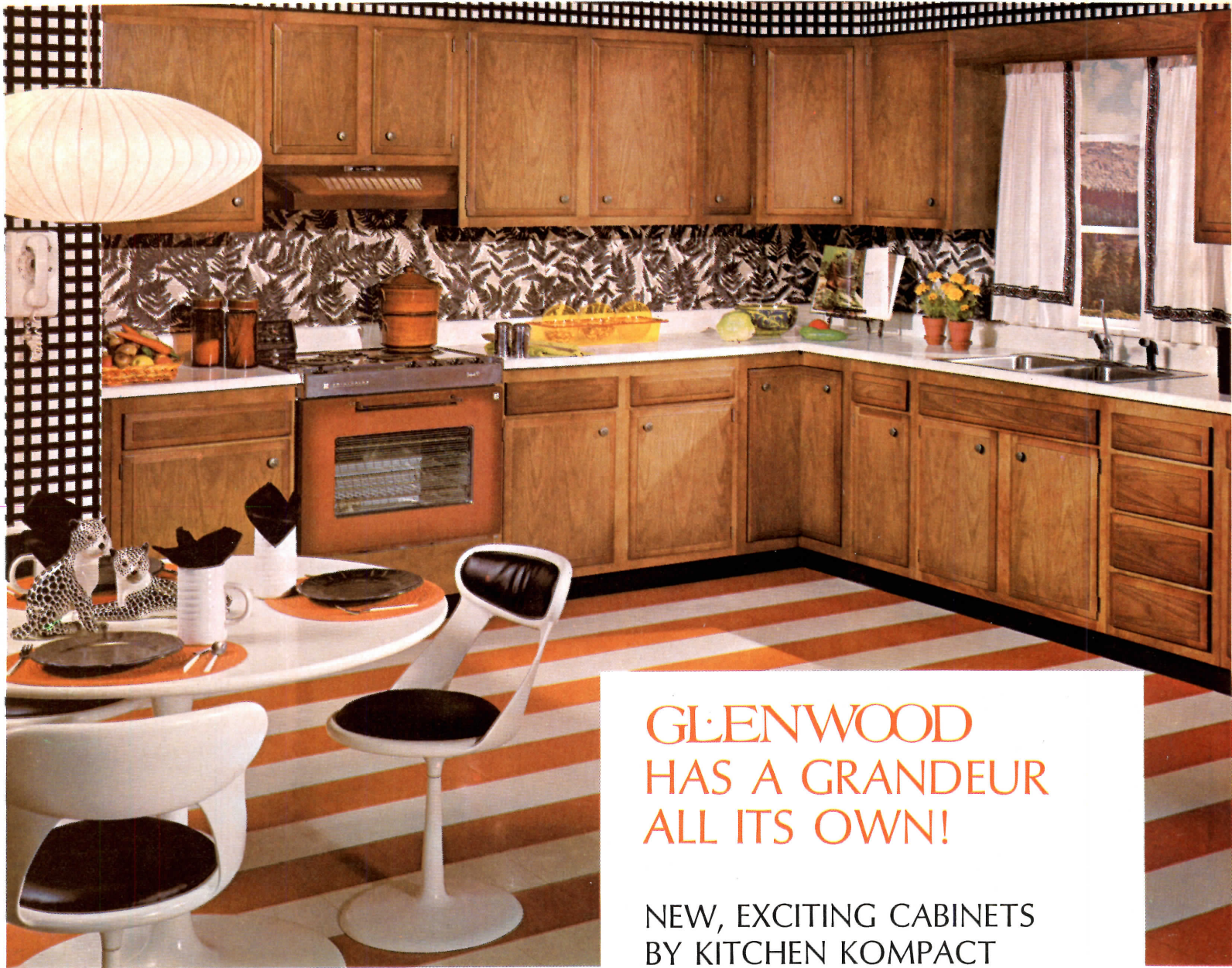

GLENWOOD HAS A GRANDEUR ALL ITS OWN!

NEW, EXCITING CABINETS BY KITCHEN KOMPACT

Now, Kitchen Kompact introduces a great new look to kitchen cabinets. It is Glenwood—an aristocratic walnut finish and grain pattern with clean, classic styling. Glenwood has a grandeur all its own!

Kitchen Kompact cabinet construction equals its stylish appearance. Drawers are of one-piece Durium—a new, high impact-resistant material that is virtually indestructible. An improved, roller-free suspension system makes drawer action even easier.

All KK cabinets wear the famous Mobil “Family Proof” finish—a highly resistant finish, formulated exclusively for Kitchen Kompact. So exceptionally tough, the KK finish is resistant to household chemicals, mild acids, water and alcohol, even nail polish.

See the two distinguished KK lines soon: new, exciting Glenwood and the exceedingly popular Mellowood. You couldn’t recommend a cabinet with more value to your customers.

Kitchen Kompact is available from fully stocked distributors in most major markets. Look in the Yellow Pages for your nearest KK distributor.

Kitchen Kompact cabinets have been “Quality Certified” by the National Kitchen Cabinet Association. It’s your assurance of proven performance and satisfaction.



KITCHEN KOMPACT, INC., 911 EAST 11TH STREET,
JEFFERSONVILLE, INDIANA 47130



BETTER Homes  For Clevelanders
IMPERIAL VILLAGE
The big step towards better living
By BETTER HOMES FOR CLEVELAND FOUNDATION

How vinyl (PVC) pipe made plumbing rehabilitation feasible in this 1908 Cleveland apartment

1. In rehabilitation projects, the magic word is "cost". This is particularly true in the re-plumbing part of the job. During recent months, in a typical rehabilitation project in Cleveland, Ohio, involving 110 apartment units, piping made of rigid Geon vinyl (PVC) was used for the drain, waste and vent system throughout.

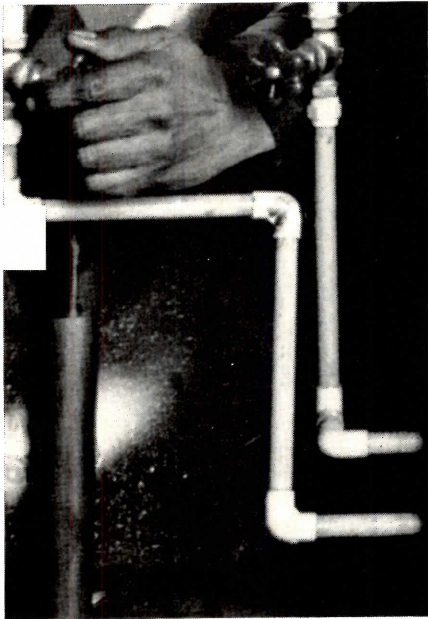

2. In piping for hot and cold water distribution lines, a heat resistant material, CPVC, tradenamed hi-temp Geon vinyl, was used.

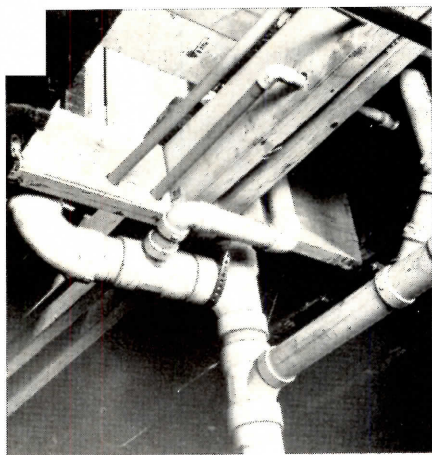

3. Cost factor of the vinyl plumbing systems for rehabilitation has been highly favorable. On this project, dollar savings were greater than one-third on bills of materials cost.

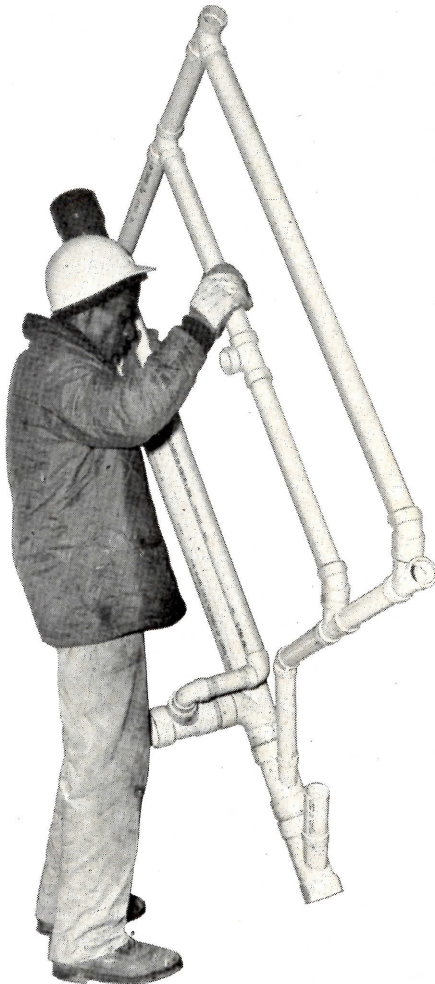

4. PVC pipe is lightweight and easy to install through and around the existing framing. It can readily be preassembled.



5. Installation was remarkably easy in tight, hard-to-get-at places because solvent cemented joints eliminated threading and soldering.



6. Maximum safety was achieved because torches were not required for installation; this was especially important in confined, "tinder-dry" construction.



7. The simple method of joining PVC and CPVC piping is highly efficient—on one job only four leaks out of 5000 joints. And they were easily corrected. Expansion joints, shown here, were used between floors and performed equally well.

For more than 15 years, the raw material experts in pioneering PVC pipe have been our technical men and development engineers. Our experience can be your experience. For information on PVC and CPVC pipe, contact B.F. Goodrich Chemical Company, Dept. H-15, 3135 Euclid Avenue, Cleveland, Ohio 44115.

B.F. Goodrich Chemical Company
a division of The B.F. Goodrich Company



House & Home ADVERTISERS' INDEX

	Page			
Ador Corp. (Sub. of Rusco Industries, Inc.)	120W1	Leigh Products, Inc.	58	Wallace-Murray Corp.
Alliance Mfg. Co.	103	Lennox Industries, Inc.	48	William Wallace Div.
Andersen Corp.	142, 143	Leviton Mfg. Co., Inc.	35-38	Weiser Lock
Artistic Brass, Inc.	60	Levitt & Sons, Inc.	28	Westinghouse
Azrock Floor Products	2nd Cover	Lightcraft of California (Nutone Div.)	9	Whirlpool Corp.
		Lindal Cedar Homes	126	Wiegand Co., Edwin L.
		Lycos Systems, Inc.	120E1	William Products, Inc.
				Wood Information Bureau
B. F. Goodrich Chemical Co.	138, 139			129
Becker Mfg. Co., Inc.	28			
Berns Air King Corp.	101			
Blu-Ray, Inc.	30	3M Corp.	120W4, S3, M3, N1	Zell Products Co.
Blyth & Co., Inc.	132	Majestic Co., Inc.	136	120E2A, E2B, M4A, M4B, N2A, N2B
Boise Cascade Corp. (Bldg. Prods. Div.)	62, 63	Malta Mfg. Co.	66	
Broan Mfg. Co.	104	Marlite Div. (Masonite Corp.)	65	
		Marvin Windows	15	
Cabot, Inc., Samuel	135	Maytag Co., The	131	
Cambridge Tile Mfg. Co., The	49	Moe Light Div. (Thomas Industries, Inc.)	16, 17	
Carrier Air Conditioning Co.	64	Moen Div. (Standard Screw Co.)	46, 47	
Casings, Inc.	106			
Certain-Teed Products Corp.	38D, 39	National Gypsum Co.	32, 33	
Chambers Corp.	134	National Homes Corp.	57	
Chrysler Corp. (Airtemp)	54	National Oak Flooring Mfrs. Assn.	100	
Corning Glass Works	52, 53	NuTone, Inc.	1, 2	
Day & Night Mfg. Co.	133	O'Keefe & Merritt	120W5, SW3	
Delta Faucet Co.	42	Olympic Stain Co.	4th Cover	
Diazi Co., Inc.	135			
Edison Electric Institute	141	Pacific Lumber Co.	13	
Emerson Electric Co. (Builder Products Div.)	107	Portland Cement Assn.	10, 11	
		Price Pfister Brass Mfg. Co.	99	
Float-Away Door Co.	123	R. A. Watt Co., Inc.	130	
Formica Corp.	51	Rangaire Corp.	120S1, SW1	
Friedrich Refrigerators, Inc. Central Air Cond. Div.	120M2, S2, SW2	Red Cedar Shingle & Handsplit Shake Bureau	50	
		Reinforced Plastics Div. (Reichold Chemicals, Inc.)	61	
General Electric Co.	115, 116, 117, 118	Scherich Co., H. J.	38B	
George D. Roper Sales Corp.	45	Schlage Lock Co.	43	
Georgia-Pacific Corp.	6, 7	Sloane Mfg. Div., R&G	55	
		Southern California Edison Co.	120W6	
		Sunset Magazine (Lane Magazine & Book Co.)	120W2, W3	
Hayden, Miller & Co.	14	Tappan Co.	41	
Holub Industries, Inc.	44	Thermador	102	
Homasote Co.	125	(Div. of Norris Inds.)		
Hunter Div. (Robbins & Myers, Inc.)	105			
I-XL Furniture Co. (Div. of Westinghouse)	25	United States Gypsum Co.	144, 3rd Cover	
Inland Homes Corp.	120M4, N2	United States Steel Corp.	112, 113	
Journal-Sentinel (The Journal Co.)	120M1			
Kemper Brothers, Inc.	59			
Kingsberry Homes	38C			
Kinthead Industries Showerfold Div.	128			
Kitchen Kompact, Inc.	137			
KitchenAid Home Dishwasher Div. (Hobart Mfg. Co.)	111			

ADVERTISING SALES STAFF

ATLANTA 30309
Glen N. Dougherty
1375 Peachtree St. N.E.
(404) 892-2868

BOSTON 02116
David Persson
McGraw Hill Bldg.,
607 Boylston St.
(617) 262-1160

CHICAGO 60611
John L. Filson;
James R. Schaffer;
Ray W. Stoddard,
645 N. Michigan Ave.,
(312) 664-5800

CLEVELAND 44113
Milton H. Hall, Jr.
55 Public Square
(216) 781-7000

DALLAS 75201
Richard Poole,
1800 Republic Natl. Bank Tower
(214) 747-9721

DENVER 80202
Richard W. Carpenter
1700 Broadway,
(303) 255-5483

DETROIT 48226
Stuart G. McKenzie
2600 Penobscot Bldg.
(313) 962-1793

HOUSTON 77002
Robert A. Wallin
2270 Humble Bldg.
(713) 224-8381

LOS ANGELES 90017
Donald Hanson,
1125 W. Sixth St.,
(213) 482-5450

NEW YORK 10036
Donald W. Thompson,
Charles M. Murtaugh
500 Fifth Ave.,
(212) 971-3686

PHILADELPHIA 19103
Donald C. Stanley
Six Penn Center Plaza
(215) 568-6161

PORTLAND 97204
Harry Abney,
Mohawk Bldg.,
222 S.W. Morrison St.,
Suite 218
(503) 223-5118

SAN FRANCISCO 94111
Dwight Lowell,
255 California St.,
(415) 362-4600

ADVERTISING PRODUCTION MANAGER

Vito De Stefano
McGraw Hill, Inc.
330 West 42nd St.
New York, N. Y. 10036
(212) 971-3204

The advertising index and reader service numbers published by HOUSE & HOME is a service to its readers. HOUSE & HOME does not assume responsibility to advertisers for errors or omissions.

W denotes Western edition
M denotes Mid-Western edition
N denotes North Central edition
E denotes Eastern edition
S denotes Southern edition
SW denotes Southwest (Swing)

Why build just houses?

With Total Electric Homes you build more house for the money, and more profits, too!



A Total Electric Home is full of features that turn browsers into buyers. Fast.

Features like flameless electric heat. Electric self-cleaning ovens. Electric clothes dryers. Electric air conditioning. Features that'll help you sell faster and more profitably.

Electric heat has arrived. Millions of families already enjoy it. And millions more say they want it. In fact, a recent Department of Commerce study shows twice as many home buyers want electric heat as builders are now providing. A big reason: nationwide ads like the one pictured are selling the benefits of carefree electric living in Life, Look, Better Homes & Gardens, and American Home.

Why not take advantage of the growing preference for Total Electric Living? Your electric light and power company will welcome the opportunity to work with you.

LIVE THE CAREFREE ELECTRIC WAY

"Electric heat is so clean I can use colors I never dared use before"

Maybe you're not ready to go quite as far as our white-on-white living room. No matter. The point is, with carefree electric heating and cooling you can decorate with light colors to your heart's content... confidently pick the new pastels you've yearned for. Because electric heat is flameless. So you can't buy cleaner heat for your furniture, walls, window sills and draperies. In any home, old or new. Mobile home and apartment, too. Take a step toward the carefree life. Call your electric heating contractor or your electric light and power company.



Live the carefree way with
Flameless Electric Heat



Live Better Electrically

Edison Electric Institute
750 Third Ave., N.Y., N.Y. 10017
This Gold Medallion identifies a home where everything's electric, including the heat.

LIVE BETTER ELECTRICALLY · Edison Electric Institute · 750 Third Avenue, New York, N.Y. 10017

Visit the "Total Electric Way" at the NAHB Show—Booth 1102

New Andersen Perma-Shield[®] value of wood plus a rigid vinyl

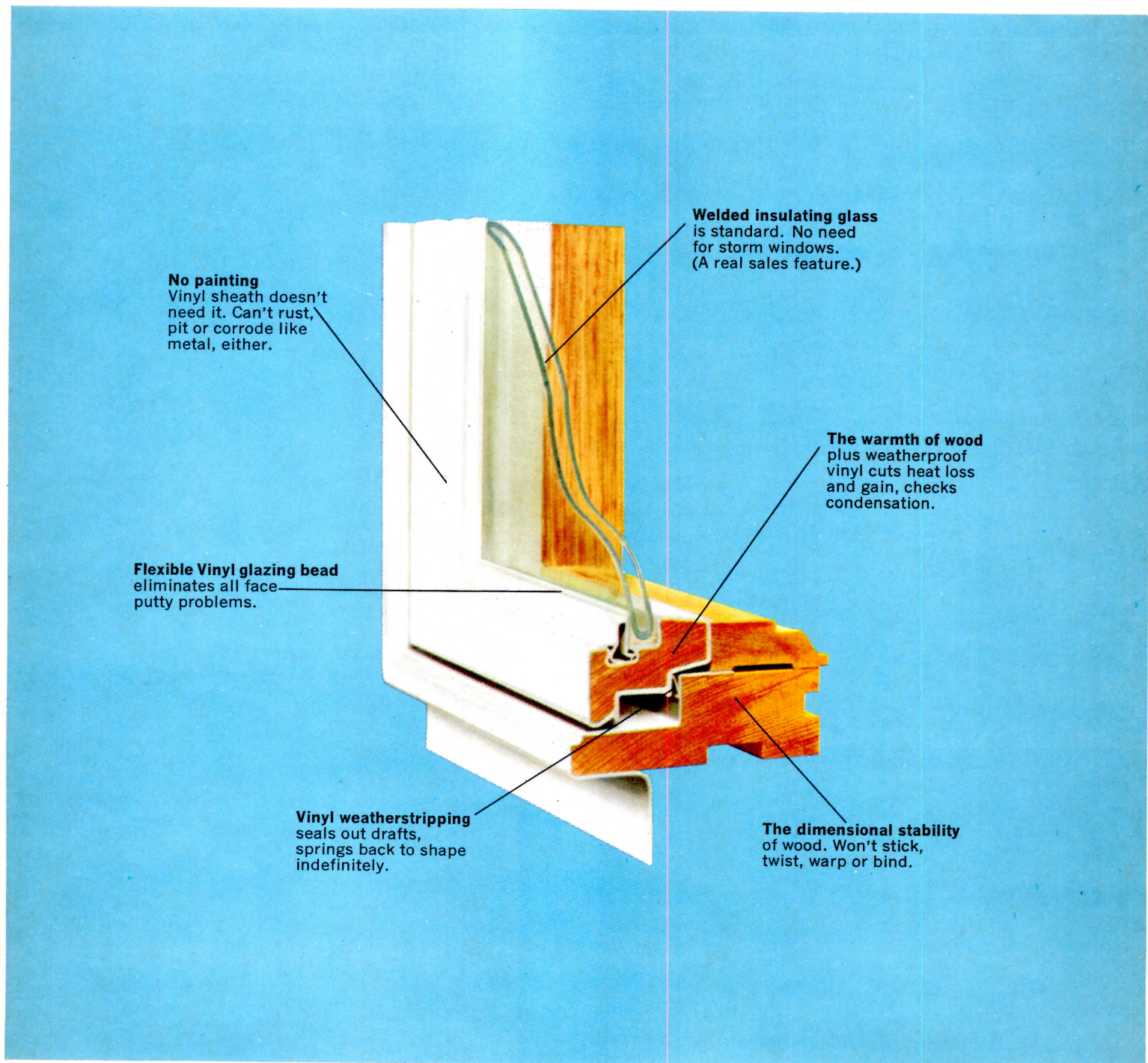

New Andersen

Window offer the insulating shield that needs no painting.

(No wonder you're seeing more of them lately.)

Inside a Perma-Shield sash there's a core of warm, stable wood. Outside, there's a thick sheath of rigid, weatherproof vinyl. And the glazing is welded insulating glass.

Is it the perfect window? You'll have to decide about that for yourself. We're proud of it, and we're pleased that Perma-Shield windows are being specified for some of the *best* new commercial buildings and residences.

Wide range of styles and sizes.

Choose casements, awning style, fixed types, single or multiples right from stock. There are 26 basic Perma-Shield sizes and 3 sizes of gliding doors—6, 8 and 12 feet.

For more information check Sweets file. Or mail the coupon below for literature or a Perma-Shield Demonstration in your office.

See us at Booth No. 2410.

Andersen Corporation
Bayport, Minnesota 55003

- Please send complete Perma-Shield Literature.
- I'd like a Perma-Shield Demonstration in my office. Please have an Andersen Distributor call me for an appointment.

Name _____

Firm _____

Address _____

City _____ State _____ Zip _____

Andersen Windowalls™ 
Window Beauty is Andersen

HH-19 A



Washington Club Inn, Virginia Beach, Virginia, features 40, 8-foot Andersen Perma-Shield Gliding Doors. Guests get a sweeping view of the ocean through snugly weathertight gliding doors. No problems ... even under the most severe salt-air conditions.
Architect: Evan J. McCorkle, Virginia Beach, Va.



Emma Norton Methodist Girls' Residence, St. Paul. Difficult elevation could make window maintenance a nightmare, but there's little or no maintenance with Perma-Shield. They've been performance proved on thousands of residential and commercial jobs like this one—exposed to every climate over the last 9 years.
Architect: Progressive Design Associates, St. Paul, Minn.



Low maintenance home, Long Lake, Minn. The Perma-Shield Windows in this home won't need painting, or storm windows, and they won't pit or corrode like metal. They combine the insulating value of wood and the maintenance savings of a rigid vinyl shield.
Architect: George F. Panuska, Virgin Islands.

Perma-Shield Windows

This is ridging | a weakness of ordinary wallboard.
↓

