

McGraw-Hill's marketing and management publication of housing and light construction

# House & Home

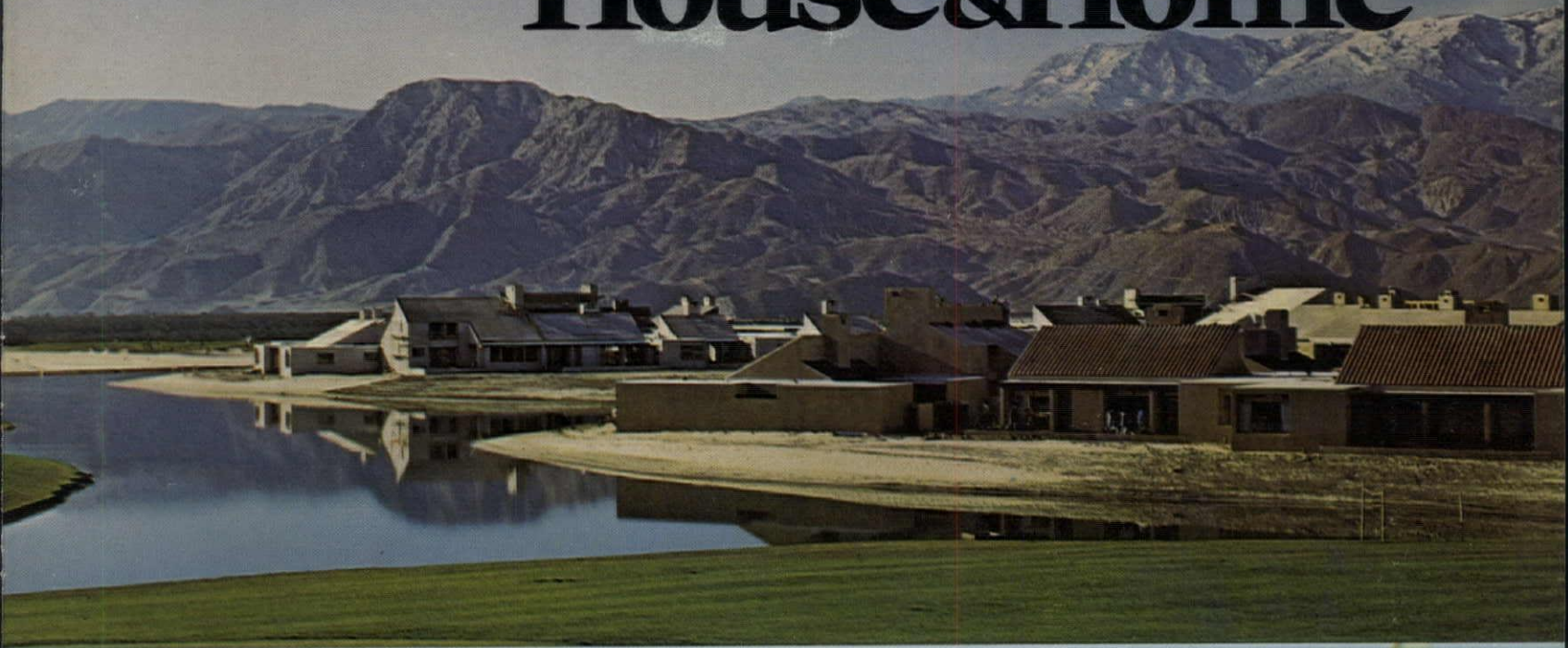

MAY 1971

# California

under the glitter, a growing sense of what the market wants

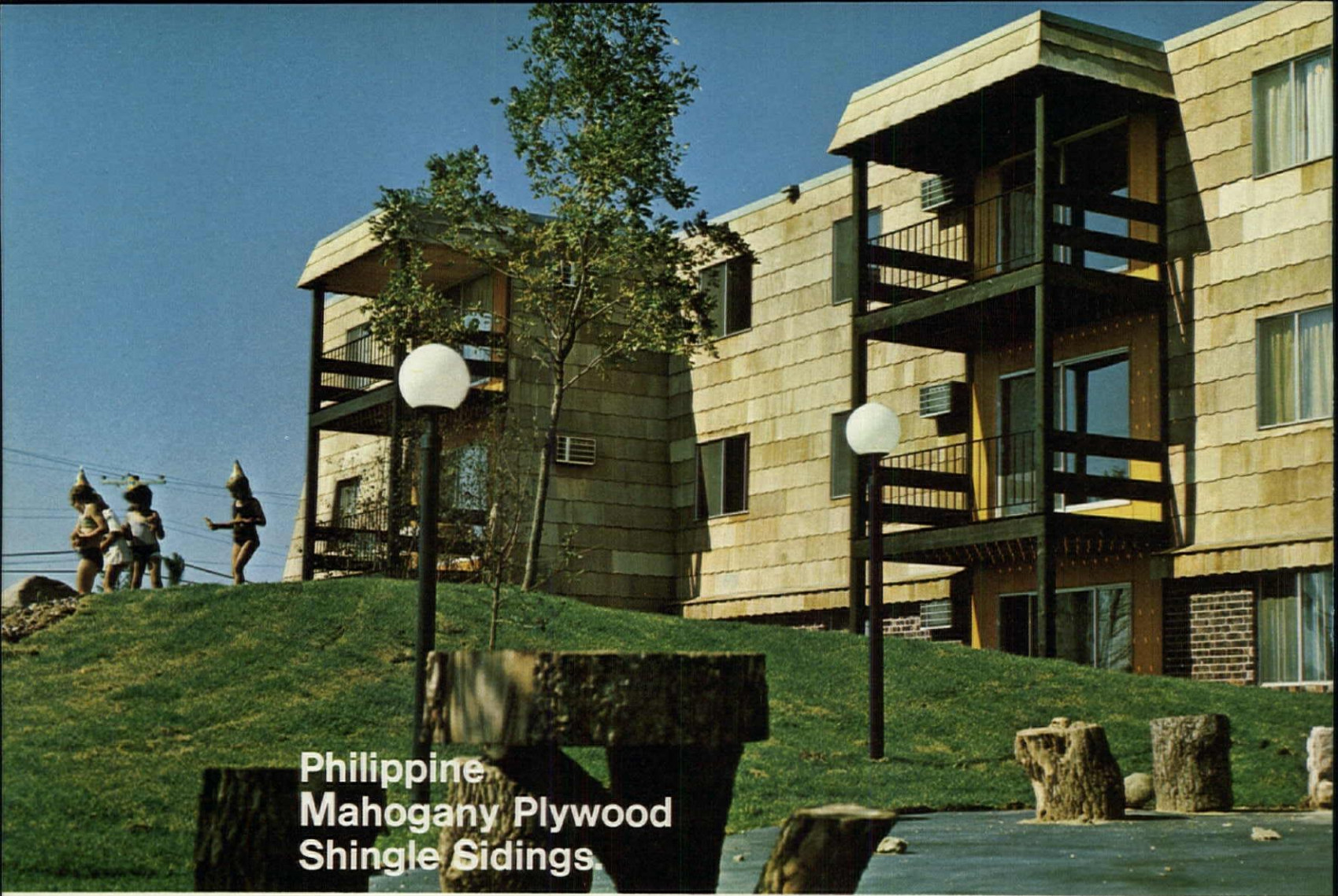

**Philippine  
Mahogany Plywood  
Shingle Sidings.**

**Rough Sawn or Striated.**

**Up they go, ten at a time!**

Boise Cascade has done it again. We've put together two quality plywood sidings with all the sales appeal of hand-split shakes or rough-sawn shingles.

The choice is yours!

Both apply fast in 16"x48" panels of 10 random shingles per panel. You can shim our "shingles" for added shadow lines. Custom prefinish or stain them on site, beautifully. Or buy them prestained by us in your choice of four inviting colors.

And our Rough Sawn or Striated Plywood Shingle Sidings are as economically priced as they are economical to apply!

We build quality into every panel. With face veneers of Philippine mahogany cut from our own forests. Peeled in our own mills. Exterior glued to selected cores and backs. And tested to meet APA 303 Specialty Siding requirements... as well as tough standards of our own!

Put both our beautiful Shingle Sidings to work... and watch your buildings sell!

For Philippine Mahogany Plywood Shingle Siding samples and information, fill out and mail to: Boise Cascade Sidings, P.O. Box 7727, Boise, Idaho 83707.

**New! Striated Shingle Siding for the look of hand-split shakes.**



Name \_\_\_\_\_

Address \_\_\_\_\_

City \_\_\_\_\_ State \_\_\_\_\_ Zip \_\_\_\_\_

PMSB \_\_\_\_\_ HH \_\_\_\_\_



 **Boise Cascade  
Wood Products Division**

# The NuTone Central Cleaning System Treats a lady like a lady!



And it's profitably nice for you, too. ▷

Nice product. Nice sales feature.

# Nice profit-built-in!

Women love NuTone Central Cleaning Systems because they really get the job done and they don't have to haul around a big, clumsy, cumbersome . . . and sometimes very heavy, power unit. All they have to contend with is a very flexible, extremely light weight cleaning hose that reaches 25 feet in any direction. Plugs into nearest inlet . . . and away you go. Quiet, too, because the power unit is out of the living area. There are two great systems to choose from.

## First the Deluxe 350 System.

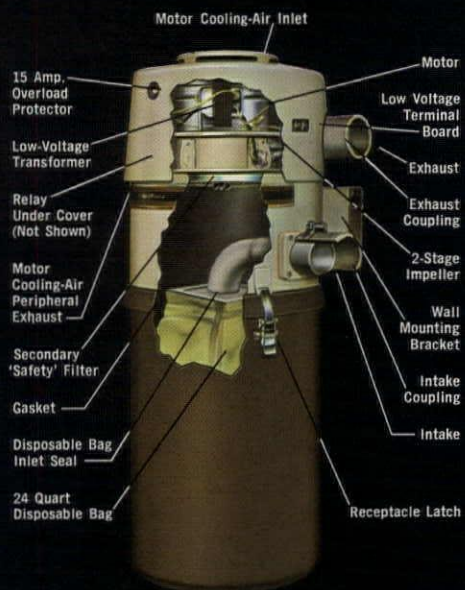

The powerful one. Has a big 2-horsepower motor and that's a lot of housepower. U.L. listed. The unit may or may not be exhausted to the outside. Cleaning tools are resilient-vinyl and very nice to furniture. The power unit installs easily in out-of-way space. Tools and hose are easy to store, too.

## This is NuTone's Basic 351 System.

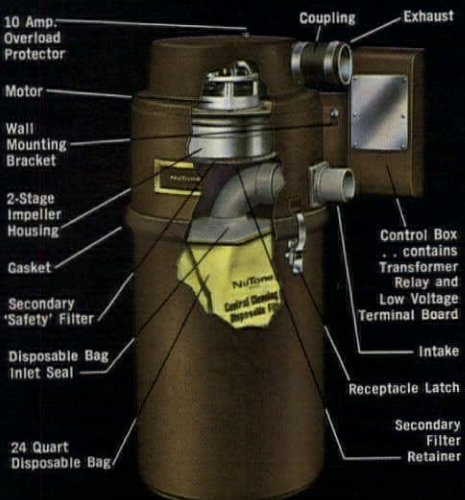

Has all of the great benefits of Deluxe but is more compact to fit space and budget needs. 1-horsepower unit may or may not be exhausted to outside. Lightweight cleaning tools have non-rigid housings. Won't mar furniture. Tools fit into carrying case, equipped with wall-hanger.

Two great central cleaning systems that know how to treat a lady. And — no pun intended — they're both great ways for you to clean up too. There's a nice profit margin built-in. Get the whole story . . . For the name of your nearest Sales Distributor or Service Center, **Dial NuTone: 800-243-6000.** Call FREE, any hour, any day. (In Conn., call collect: 1-800-942-0655.) Or, look in the Yellow Pages under "Electric Appliances — Small (or Major)"



373—Tools, Wands, Caddy. A 'fitted-case', thin and so lightweight! But sturdy! It hangs on a wall, transports easily from room-to-room.



360 Automatic-Inlet (closed)



390 Air-Power Brush

371 Hose in 360 Inlet



↑ Automatic Inlet, in floor, with hose inserted.  
 Portable Tool Caddy, Power Unit and Hose on Storage-Hanger (Included).  
 ↓ Cleaning Tools and Wands.



**NuTone** **SCOVILL**

Madison and Red Bank Roads, Cincinnati, Ohio 45227  
 Dept. HH-5. Form 689. Printed in U.S.A.

EDITOR  
John F. Goldsmith

SENIOR EDITORS  
Maxwell C. Huntoon Jr.  
Edwin W. Rochon

ASSOCIATE EDITORS  
William J. Dukes  
John Kirk  
June R. Vollman  
Jenepher Walker

ART DEPARTMENT  
Marianne Vlazny, *assistant*  
Jan V. White, *consultant*

EDITORIAL ASSISTANTS  
Nancy Jane Davis  
Ellin Kaknes  
Peggy Stevely

CONTRIBUTING EDITORS  
Frank Lalli  
Andrew R. Mandala, *Washington*  
David Thaler  
H. Clarke Wells

EDITORIAL CONSULTANT  
Carl Norcross

CONSULTING ECONOMIST  
George A. Christie

MCGRAW-HILL WORLD NEWS  
Walter Stanbury, *director*  
20 domestic and  
international news bureaus

ADVERTISING SALES MANAGER  
John S. Renouard

MARKETING SERVICES MANAGER  
Henry G. Hardwick

CIRCULATION MANAGER  
Joseph D. Holbrook

PUBLISHER  
James E. Boddorf

# House & Home

McGraw-Hill's marketing and management publication of housing and light construction

Volume 39 Number 5 / May 1971

## FEATURES

- 73 Letter to a corporation that's buying a builder: an editorial  
Congratulations—but there are a few things you ought to know
- 74 California: under the glitter, a growing sense of the market  
76 California's land planning  
Two new projects show that at last, it's getting better
- 84 California's townhouses  
Up to now the market has been quiet, but a boom may be starting
- 88 California's single-family houses  
A top builder shows how to fit the model to the buyer
- 92 California's approach to housing atmosphere  
How a bayside sandpit was turned into a Caribbean village
- 96 More housing jobs for blacks?  
A big builder who's providing them tells why it pays off

## NEWS

- 4 To cut lumber prices, Uncle Sam may let industry cut more trees
- 8 Wallboard prices pegged for two years—three industry giants guilty
- 12 Romney calls FBI into housing subsidy scandal
- 16 Foes show how to halt public housing in Chicago—and perhaps everywhere
- 20 Washington suburb fights plan to lease its townhouses to the poor
- 24 Mortgage-form critics threaten to delay new secondary loan market
- 28 Mortgage men find a money machine—the GNMA security apparatus
- 37 President sets 6% guideline for building wage increases
- 52 Does spending time and money on a problem site make sense?
- 62 For tomorrow's apartments: a constant air-circulation system

## DEPARTMENTS

- 33 Housing stock prices
- 64 The apartment scene  
Can't find the man to maintain your apartments? How about the man who built them?
- 66 The modular scene  
The real role of industrialized housing is to make up for the shortage of labor
- 68 The zoning scene  
Contour clustering is a better way to create open space, and it can cut costs
- 70 Letters
- 107 Personal business
- 131 Reader service card
- 133 Products
- 158 Literature
- 164 Index
- Cover Views of three California projects. From top to bottom:  
Mission Hills, Palm Springs. *Photo:* Leland Lee. *Story on page 76.*  
Coronado Cays, Coronado. *Photo:* Charles AquaViva. *Story on page 92.*  
Village Park, Encinitas. *Photo:* Julius Shulman. *Story on page 84.*

House & Home, May 1971, Vol. 39 No. 5. Published monthly by McGraw-Hill Inc. Founder: James H. McGraw (1860-1948). Subscription rates, U.S. and possessions and Canada: for individuals within circulation specifications, \$9 per year, for others, \$15 per year. All other countries, \$30 per year. Single copy, if available, \$2. The publisher reserves the right to accept or reject any subscription.

Executive, Editorial, Circulation, and Advertising offices: McGraw-Hill, 330 West 42nd Street, New York, N.Y. 10036. Telephone: 971-3333. Second class postage paid at Washington, D.C. and at additional mailing offices. Published at 1500 Eckington Place, N.E., Washington, D.C. 20002. Title \* in U.S. Patent Office. Copyright © 1971 by McGraw-Hill Inc. All rights reserved. The contents of this publication may not be reproduced either in whole or in part without consent of copyright owner.

Officers of the McGraw-Hill Publications Company: John R. Emery, President; J. Elton Tuohig, Senior Vice President; George H. Reppert, Group Vice President; Vice Presidents: Ralph Blackburn, Circulation; John R. Callahan, Editorial; William P. Giglio, Administration; David G. Jensen, Manufacturing; Jerome D. Luntz, Planning & Development; Joseph C. Page, Marketing; Robert M. Wilhelm, Finance.

Officers of the Corporation: Shelton Fisher, president; Joseph H. Allen, group vice president, publications and business services; John J. Cooke, senior vice president and secretary; Ralph J. Webb, treasurer.

This issue of House & Home is published in national and separate editions noted or allowed for as follows: Western W1-W10, Eastern E1-E2, North Central N1-N2, Southern S1-S6, Swing SW1-SW2.

Postmaster: Please send form 3579 to Fulfillment Manager, House & Home, P.O. Box 430, Hightstown, N.J. 08520.

## To cut down lumber prices, Uncle Sam may let the industry cut down more trees

The Nixon Administration, busy trying to restrain construction costs by moderating wage increases, was working on another front last month to hold the line on lumber prices.

To do so, it looks as though the federal government may permit increased cutting from federal forests.

Prices for lumber spiraled upward earlier this year and President Nixon—who has been outspoken in his criticism of the wage-price spiral in construction—ordered an investigation.

The inquiry, undertaken by an informal administration group headed by Hendrix Houthakker of the President's Council of Economic Advisers, was looking into these possible causes:

- Increased speculation in the trading of lumber and plywood futures in the Chicago commodity markets.

- Suspicion that some lumber companies had been deliberately holding back on cutting timber from federal lands to await higher prices.

- Chronic boxcar shortages, which effectively slow the movement of softwood lumber and plywood to eastern markets.

**Prices and speculation.** The major problem this year, as it was in early 1969, has been a sharp upswing in prices for raw timber. The increases are not as severe this time, but prices earlier this year climbed about 30% above prices as recent as those for, say, last November.

While prices seem to have leveled, they have been as high as \$92 per 1,000 feet of plywood, up from \$75 when the increases began.

At the same time, futures trading reached fever pitch. More than 23,000 lumber and 25,000 plywood futures contracts were negotiated on the Chicago Mercantile Exchange in February compared with 650 lumber and 1,400 plywood contracts in February 1970.

**Cutting policies.** James R. Turnbull, executive vice president of the National Forest Products Assn., had urged the investigating group to look into federal timber sale practices, which permit buyers to delay

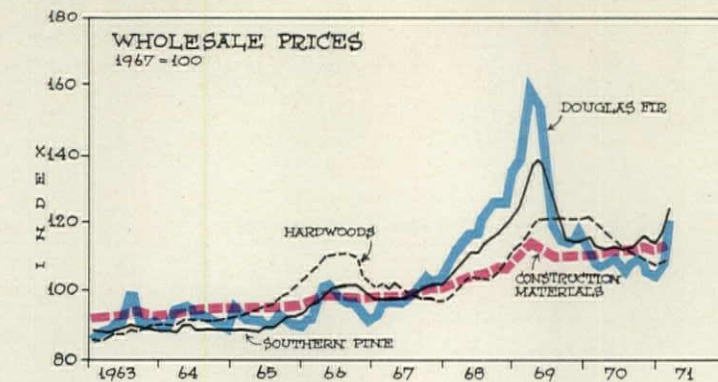

logging until prices climb significantly. Turnbull said:

"Timber purchased by such speculators usually remains unharvested until the market price for lumber and plywood rises enough so that these speculators can sell the contract cutting rights to established manufacturers.

"There is no effective time limit during which this timber must be harvested. There is no penalty for declining to cut or for holding sales off the market indefinitely while awaiting a product selling value sufficient to realize a profit on timber."

For years, Turnbull's association has sought regulations requiring bidder qualifications. The rules would limit bidding to companies "reasonably capable of operating federal timber sales."

**New program.** Houthakker's panel was still working up its recommendations in mid-April, but he was confident the findings would be made "within a few weeks."

Houthakker was certain the group would recommend nothing specific on pricing; rather, he indicated, the panel was "seeking to do something to influence the supply."

### Loan guaranty plan for condominiums

A construction financing company has devised a plan to guarantee construction loans in order to permit more builders to erect condominium housing.

First General Resources Co. says its own informal survey shows that a large majority of the nation's builders are often reluctant or unable to build condominiums because lenders require that 50% to 75% of the units be sold before making the

More boxcars would be one answer. This has been a sore point for lumber companies, and the National Association of Home Builders has pointed out that the Interstate Commerce Commission has already ordered Eastern railroads to return empty cars to the West.

**Larger harvest.** For its part, however, the administration has been hinting at increased harvesting—and it is along these lines that the Houthakker group has moved. As recently as January, in its report to the President and to Congress, the Council of Economic Advisers may have sensed an imminent lumber shortage. The CEA stated:

"An increase in the timber harvest through intensified management promises broad public benefits. Not only will consumers of wood products, particularly purchasers of housing, benefit through lower prices, but this can be achieved while keeping our timber resources intact."

**Conservation.** The council went further in an effort to mollify conservationists.

"In the past," the CEA said, "cutting has frequently been synonymous with denuding the land, but this is by no means inevitable."

construction loan.

The company, with headquarters at 505 Park Avenue in New York City, says it will guarantee construction loans and thus eliminate the pre-construction sale requirement.

First General has set up a condominium housing division to guide builders. Martin A. Sloane, the general manager, says the company will also launch a mortgage investment trust to assist the new division.

"By partial cutting and careful selection the negative aesthetic and environmental impact of harvesting can often be kept to a minimum.

"Indeed, increased harvests can offer benefits beyond the increased supply of timber, for intensified forest management can also result in a natural increase in wildlife and improved opportunities for recreation."

**Timber owners.** It is, of course, on federal lands where the great supply lies. Only 16% of the total inventory is in the hands of private industry, but private industry has accounted for nearly one third of the total supply of softwood sawtimber harvests. Public lands have accounted for about 40% and the remainder has come from private holdings.

The council, in its report, noted that "in times of increased demand it is to these private holdings that the forest industry has commonly turned to augment supply. As a result of past cuttings, however, this source of supply has been reduced."

This decline in supply has come about at a time when the demand for lumber products is expected to increase markedly. To accommodate housing demand during the 1970s, some economists estimate, the annual consumption of softwood lumber and plywood will increase by some 75%.

For the economy as a whole, it is estimated that annual demand for softwood sawtimber could total 70 billion board feet by 1978, about 40% above the consumption level in 1969.

The government can ease the immediate problem by moving more boxcars west and by revising sales techniques to get rid of speculators in lumber.

But it seems equally clear that the government is eyeing a long-term solution to a problem that is likely to become more acute: the nation is going to need more lumber.

And Secretary of Agriculture Clifford M. Hardin has already said, "The best way to increase the lumber supply in the next decade or so is to dip further into the national forest reserves."

—ANDREW R. MANDALA  
Washington

# There's only one.

# MOEN

One handle. One quality. One-of-a-kind. That's Chateau by Moen. Chateau's kitchen faucet may not belong in the Museum of Modern Art—but it does belong in your kitchens. That's where its fingertip operation really shines.

*Nonstop. That's the kind of built-in performance Chateau offers. That means reduced maintenance and fewer callbacks keep your costs from soaring.*

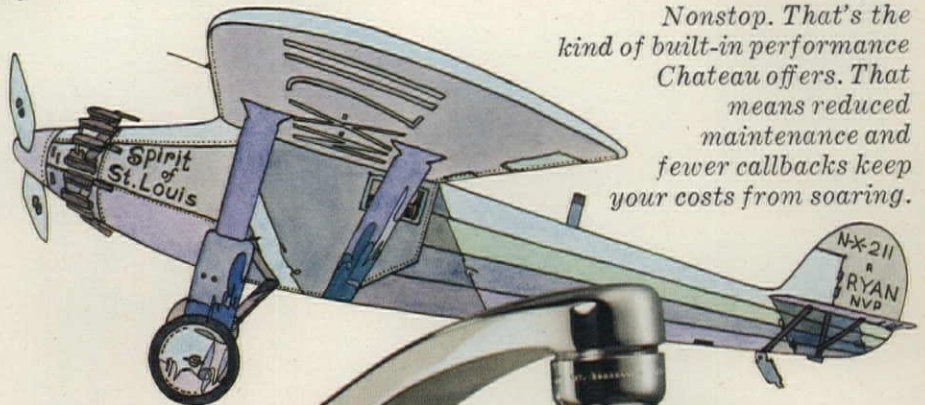

*Chateau towers above the rest in quality, convenience and performance. You can't top that.*

There's one sure way to control water volume and temperature. Just rely on this simple cartridge. It's unique. And because it fits every Moen and Chateau faucet it's the only part needed for repairs. How's that for simplifying inventory!



Chateau by Moen faucets and shower valves put luxury in your homes—single-handedly. Get Chateau by Moen. From your local plumbing contractor.

**Chateau**  
BY **MOEN**®

MOEN, A DIVISION OF *Stanadyne* • ELYRIA, OHIO 44035

B-714

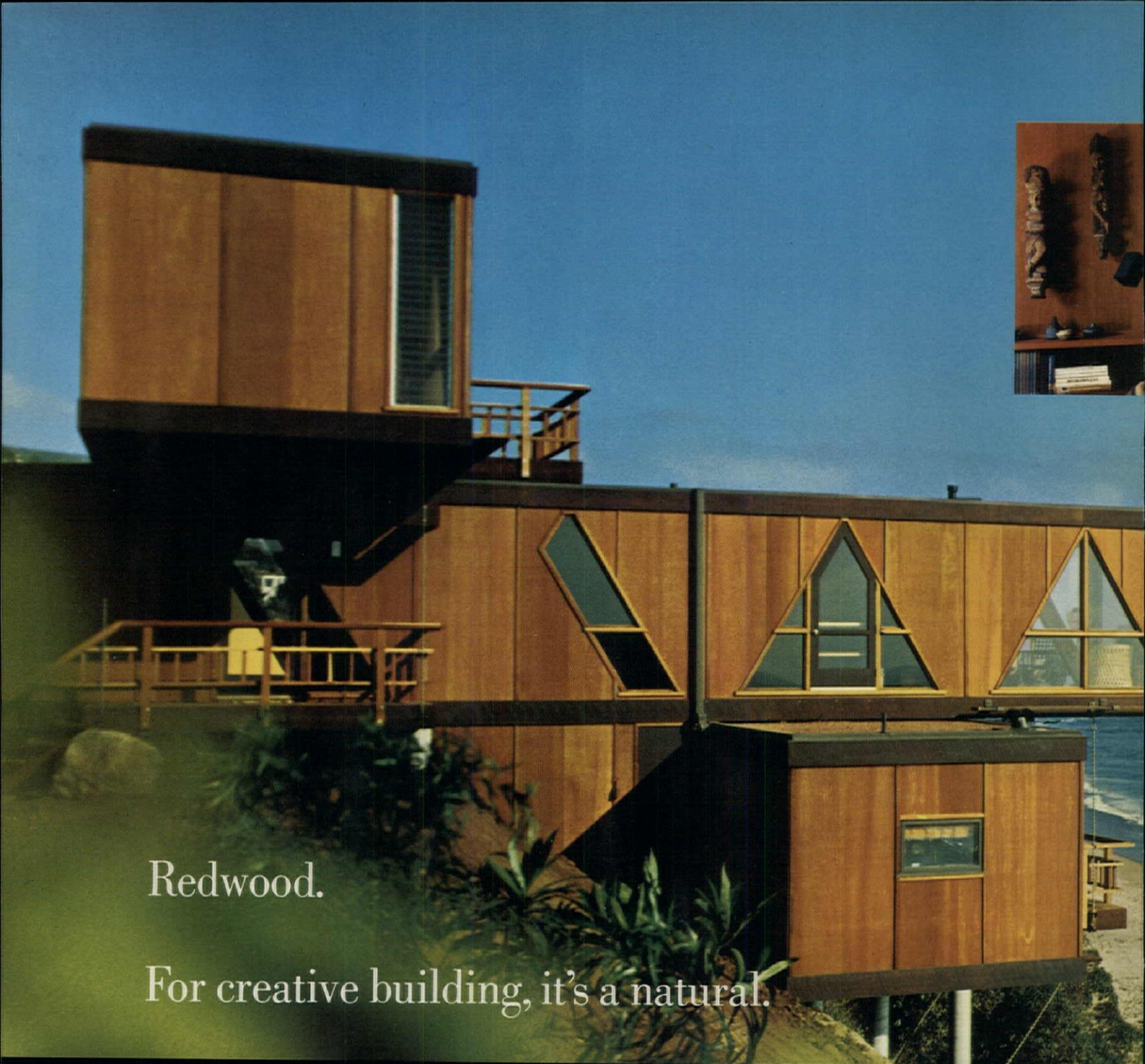

Redwood.

For creative building, it's a natural.

New ideas.

They keep the building industry churning with excitement. And right in the thick of it, you'll find redwood. Redwood, the old reliable, making its own unique contribution to the age of innovation.

As in the modular beauty above.

Here, creative design and redwood are combined to set a total environment. Redwood, with its soft, natural beauty, lends architectural unity throughout. While the rich texture and color creates its own warm, informal mood — an environment people like living in. (And where people like living, you find sales easier.)

Outside, the long lengths of redwood fascia provide smooth, unbroken lines. Straight grained and knot-free, it stains uniformly. Same for the redwood rails,

trim and decking. And the big, light sheets of exterior clear-grade redwood plywood siding. (Available in 3 lengths, 5 groove widths.)

Inside, the unity is completed. Clear grade redwood lumber, with its contrasting tones, adds interest and style. Becomes part of a total look. (And is available in a variety of textures and patterns.)

Overall, redwood is easy to work, yet stands up to the meanest weather.

The result? Everyone gets his money's worth. The buyer, in redwood's low maintenance, beauty and durability. The builder, in redwood's easy application, versatility and sales power.

Redwood.

The stuff reputations are made of.



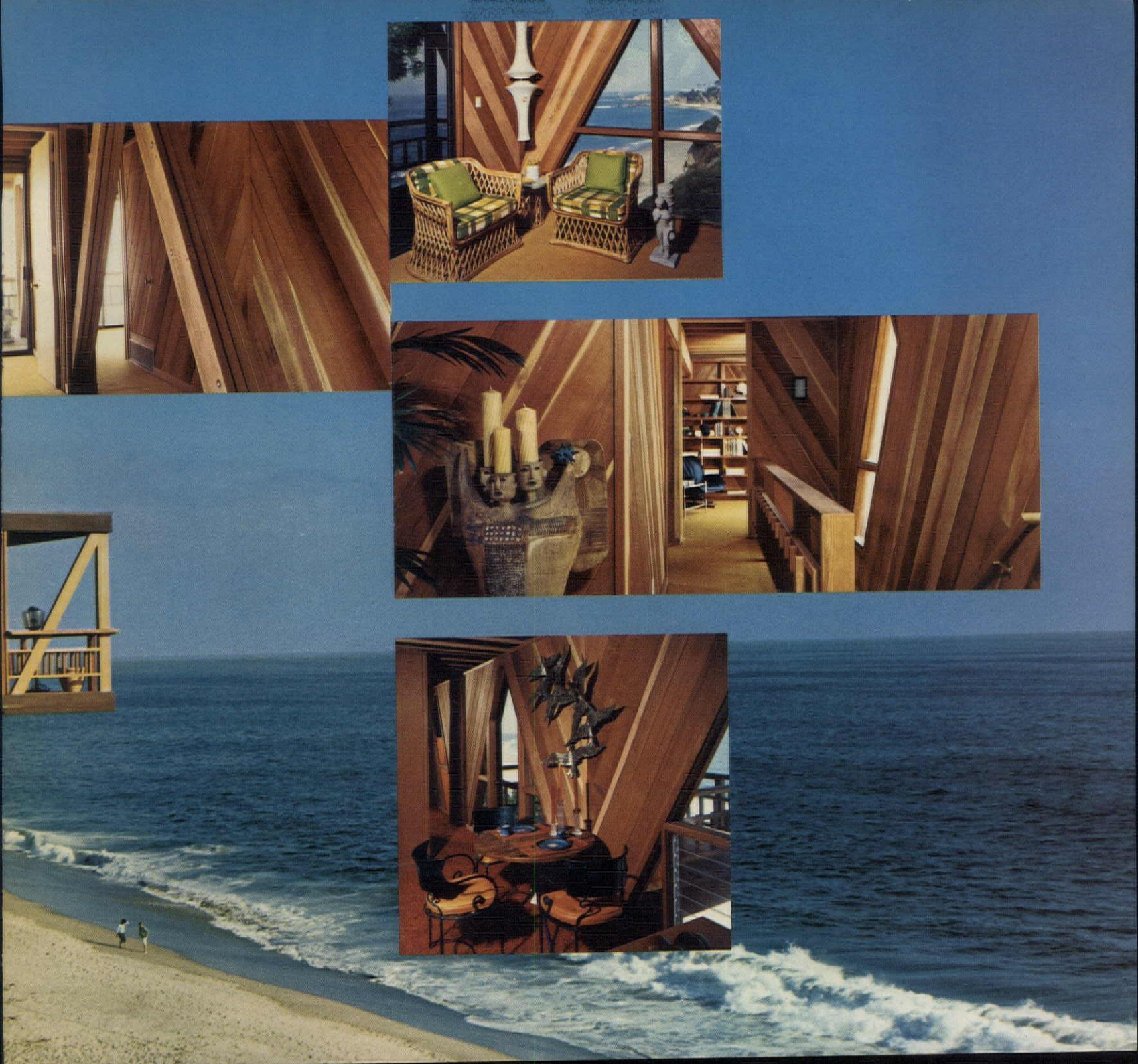

Residence of Fred Lang, Landscape Architect, South Laguna, California. Architect: Lamont Langworthy, AIA.

**CALIFORNIA  
REDWOOD  
ASSOCIATION**

Write Dept. CE for free literature: Redwood Ideas—exterior/interior solutions.

617 Montgomery Street, San Francisco, California 94111 • MEMBER MILLS: Willits Redwood Products Company • Georgia-Pacific Corporation  
Boise Cascade Corporation • Arcata Redwood Company • Simpson Timber Company • Miller Redwood Company • The Pacific Lumber Company

## Wallboard price pegged for two years; U.S., National, Kaiser Gypsum held guilty

A federal district judge in San Francisco has ruled that three major producers conspired to stabilize and maintain gypsum wallboard prices for a two-year period between Dec. 15, 1965, and Jan. 1, 1968, in violation of the Sherman Antitrust Act.

The companies named were U.S. Gypsum Co., Chicago, National Gypsum Co., Buffalo, N.Y.; and Kaiser Gypsum Co. Inc., Oakland, Calif. Charges against a fourth defendant, Fibreboard Corp. of San Francisco, had been dismissed by the court April 17, 1970.

The decision by Federal District Judge Alfonso J. Zirpoli on March 18 stems from 24 civil suits brought by six northern California specialty wallboard dealers, seeking to recover damages from the four defendants for alleged violations of antitrust laws.

**Pricing technique.** Judge Zirpoli ruled that the manufacturers had combined and conspired to stabilize prices in a deteriorating gypsum wallboard market—where price-cutting was the order of the day—by adopting policies under which they would sell only at list prices, withdraw all discounts, ignore competitive prices by single-plant producers and centralize pricing authority within each company.

The manufacturers succeeded in stabilizing the price of gypsum wallboard, Judge Zirpoli declared. He added that even despite lower residential housing starts and excess wallboard capacity, the wholesale price index rose throughout 1966.

Further court proceedings were ordered to determine damages to be awarded to dealers.

The judge found that the manufacturers did not violate the Sherman Act's restraint-of-trade prohibitions when they conspired with one another to verify wallboard prices quoted to them by customers whom they had reason to doubt.

**Builders' interests.** Besides the cases decided, the judge said there are pending some 60 "backburner" cases, involving purchases of wallboard by contractors and tract builders.

The judge explained the background of the case. He noted that demand for wallboard increased rapidly after World War II, in an

accelerated market for housing. Tract builders, constructing 300 or more homes at a time, were looking for speed of installation and economy, and wallboard soon became a standard material for interior partitions and ceilings in one and two-family residential construction.

This in turn encouraged major multiplant producers to expand facilities, and smaller operators to enter the market. By the mid-'60s, he said, housing demand fell, and the gypsum industry had excess capacity.

**Price war.** Prices, which had held fairly steady, were upset, and "there were strong incentives to cutting prices, extending credit, or 'any kind of thing you could do to get an order.'" There was no advantage to publishing a lower price, because competition would immediately meet it. Price deviations started appearing in the form of exceptions to list prices or

terms, and these had a snowballing effect. Single-plant producers, usually unable to compete in terms of customer service, cut prices instead.

The judge reported that many purchasers were prompt to exploit the market weakness, often playing one manufacturer against another for better prices or terms. Other competitive practices were "job price protection," allowing the customer to buy enough wallboard at a stipulated price to complete a particular project, and use of cashiers' checks from producer to dealer as a means of price deviation.

**Producers' defense.** Judge Zirpoli said that many buyers attempted to obtain lower prices by being evasive or deceptive about prices offered by competitors, and to obtain job price protection from several suppliers so they could get excess quantities of gypsum wallboard

at the protected price.

As a result, the manufacturers started the practice of verifying with the competitor a price reported offered to a particular customer, where the reliability of the claim was questionable. The judge found this to be no violation of the Sherman Act.

**Pegging.** According to Judge Zirpoli, U.S. Gypsum's realized price on ½" wallboard dropped from \$40.66 per 1,000 sq. ft. in 1964 to an estimated \$34.23 in September, 1965, and a further reduction to \$32.23 in December was expected. The decline in ¾" fire-rated wallboard was even more severe. Anticipating further price cutting and loss in gross profit, the company started a new pricing policy whose success, according to the judge, was dependent on major competitors following suit.

On Nov. 17, 1965, the company announced that it would withdraw all discounts effective Jan. 1, 1966, and would sell only at list prices. The company also determined to ignore the competition of single-plant producers and to centralize pricing authority in one person, but did not publicly announce this. The new policy was adopted by Kaiser and National, and the court concluded that they had advance notice of it.

On Jan. 26, 1966, U.S. Gypsum announced its intention to withdraw any exceptions to terms of sale (such as extended discounting on bills), effective March 1, and this also was followed by the others.

Both U.S. Gypsum and Kaiser generally adhered to list prices in 1966 and 1967, and National until 1968. The judge concluded that by Jan. 1, 1968, all defendants had withdrawn from the conspiracy.\*

A Kaiser spokesman said its attorneys are studying the decision with a view to possible appeal, and to determine its effect on similar cases that are pending.

—JENNESS KEENE  
McGraw-Hill News,  
San Francisco

\*New housing used 6.1 billion sq. ft. of gypsum in 1970 and will use 7.1 billion this year and 7.6 billion next year, according to a housing industry analysis by Laird Inc., New York stockbrokers. The gypsum industry will be using 75% of capacity next year, but prices are not expected to rise until it utilizes 80%.

## HUD gets its own maverick newspaper

It's called *Quest*, and it bills itself as an unofficial house organ of the Housing and Urban Development Department.

The brash newcomer is done up in newsletter style and printed independently by a group of HUD employees. It promises to do its share "of muckraking those indiscretions that have been sequestered," and it adds:

"This will be done because of our feeling that it is better to wash our dirty linen in public than not to wash it at all."

**Breakthrough.** The editors are quick with the impertinent question. The rebel publication asks if one of HUD's proudest programs, Operation Breakthrough, is not merely "housing for the affluent."

The article contends that Jersey City's Breakthrough project, for example, will cost \$20 million to build. The paper says this averages to \$38,000 per apartment, and that two-bedroom units will rent from \$225 to \$350 a month.

"Is this a cost breakthrough?" the editors ask.

Another article declares: "What this department needs is a good union to work for the

good of all employees."

**Phone numbers.** The paper lists such "useful telephone numbers" as those for abortion and draft counseling services, the American Civil Liberties Union, the Black Panther Party, the Drug Offenders Rights Committee and the Peace Center.

An editorial admits that *Quest* will be biased. It hopes, it says, "to be a call to action and to espouse ideas and ideals that have been thwarted or avoided through the normal in-house channels."

Jay Thal, a program analyst in the renewal and housing management office, edits *Quest* along with Daniel Schulder, an assistant manpower director in the Model Cities division, and John Carberry, a program development specialist in the office of community affairs.

**HUD's reaction.** The department seemed to be keeping its cool.

Robert C. Kinkor, assistant public affairs director, said after viewing the first issue:

"I have little reaction. I felt it was neither good nor bad."

The department's only proviso, Kinkor said, is that any employees working on the publication do so on their own time.



"I fetched my sea-born treasures home."

Ralph Waldo Emerson

Designs inspired by European masters. The classic Grecian. The captivating Copa from Italy's Riviera. The elegant Marquis of noble French breeding. The sleek Scandinavian-born Facet. Superb design from abroad combined with superb engineering and craftsmanship from America. Lever Locksets by Kwikset. The best of both worlds.

Kwikset Sales and Service Company, A subsidiary of Emhart Corporation, Anaheim, California

*kwikset* **K** *locksets*

America's Largest Selling Residential Locksets

CIRCLE 9 ON READER SERVICE CARD

# PPG glass presents 8 ways to bring



**1** The indoor-outdoor A-frame. Glass walls of an A-frame fourplex unit wrap around an enclosed courtyard to provide indoor-outdoor living with complete privacy. Also note the use of clerestory windows to add drama, light and an airy feeling to the room's interior.



**2** The front-door merchandiser. A two-story glass entry and a foyer with circular staircase can provide an exciting transition from outdoors to indoors. It's also a unique design detail that can be a successful front-door merchandiser.

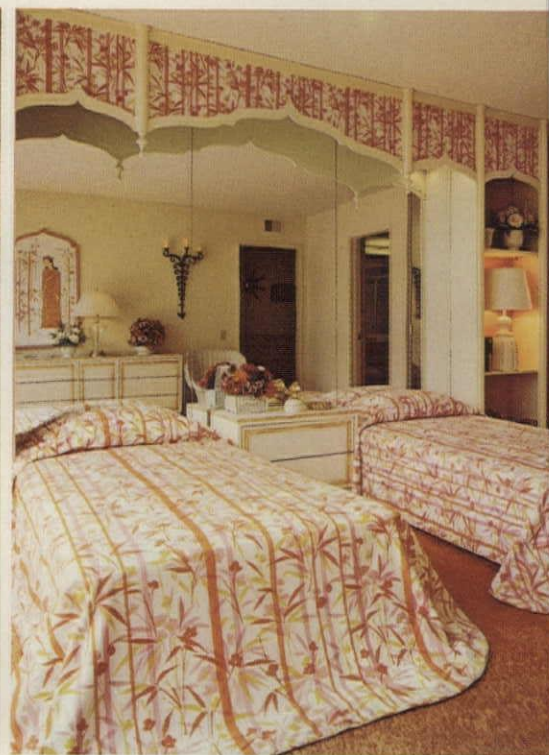

**3** The mirrored headboard. A mirrored wall, instead of an ordinary headboard, adds a touch of drama to this master bedroom. An idea like this is the perfect place for PPG *High-Fidelity*® mirrors. They give you the finest reflection.



**6** The bigger window seat. The multiple window treatment in this living room provides the opportunity for a generous window seat, an oldtime detail experiencing a revival.

In large expanses of glass like this, PPG *Twindow*® insulating glass is a natural. It cuts heat loss through the glass by as much as 50%.



**7** The prestigious front door. This two-story, glass-clad entrance provides a prestigious "front door" for an entire complex. It's also a good place to use PPG tinted glass or *Herculite K* safety glass.

# outer space to high-density.



**4** The atrium entrance. Interior entrances to apartments can be enhanced by an atrium-type court. And in a traffic area such as this, PPG *Herculite*<sup>®</sup> K safety glass is a "must."



**5** The mirrored spa. An in-complex health spa is one of the most desirable amenities in high-density today. Mirrored walls can add to the visual impact, making the area look much larger than it actually is. And, of course, mirrors in an area like this can certainly be called a beauty aid.



**8** The living room "pit." This is the living room conversation pit, a popular feature in many new high-density developments. An idea such as this is a good application for PPG *Twindow* insulating glass. It lets in the view, but not the weather.

KEY TO PHOTOS: 1: L'Atrium, Dallas, Texas. Developer-Owner: Devane Clarke. 2: Monticello in the Hills, Toledo, Ohio. Builder: Scholz Homes. 3: Coronado Cay, Coronado, Calif. Developer: Cedric Sanders Corp. & Signal Properties, Inc. 4, 7: Skyline Terrace Apartments, San Francisco, Calif. Builder: Pringle Construction Co. 5: Sixty-01, Seattle, Wash. Developer: W-O Associates. 6: Oak Brook, Chicago, Ill. Builder: Del E. Webb, Corp. 8: Deep Well Ranch, Palm Springs, Calif. Developers: William Bone Companies & ALODEX Corp.

Of course, these are just a few ideas on high-density from PPG. You can get hundreds more by sending the coupon for PPG's new 48-page, full-color brochure—"PPG Lifestyle/70s." See how PPG *Twindow* insulating glass, *High-Fidelity* mirrors, *Herculite K* tempered safety glass and PPG tinted glass can open up your plans—and open up the potential for sales, rentals and profits.

## PPG: a Concern for the Future

PPG Industries, "PPG Lifestyle/70s"  
Department HH-1-5  
One Gateway Center  
Pittsburgh, Pa. 15222

Gentlemen: Please send me a free copy of "PPG Lifestyle/70s" at the following address:

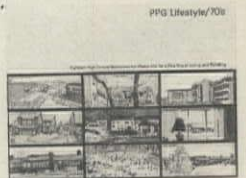

Name \_\_\_\_\_

Address \_\_\_\_\_

City \_\_\_\_\_ State \_\_\_\_\_ Zip \_\_\_\_\_



## Developer responsible for landscape? Chicago HBA suspends a builder who says no

The Homebuilders Assn. of Chicagoland has just suspended one of its larger members—the Real Estate Corporation of America (REALCOA). The ostensible reason was the company's refusal to pay \$1,000 for a customer's retaining wall, but the real issue is how much responsibility a builder must assume for the environment he sells.

Why would a \$5-million-a-year builder accept suspension from both the local and national homebuilders groups rather than pay what appears to be a trifling sum? (His suspension by the local automatically suspends him from the NAHB.)

"It's not the money," claims Harold M. Palmer, REALCOA president. "We always fix things that go wrong in our homes."

Palmer fears that if he pays for the disputed wall, he will open a Pandora's box and that claims will come flying out at him from the residents of the subdivision who have already built retaining walls.

**The dispute.** The problem developed two years ago when Bruno Zydek bought a house and lot in Hickory Hills, a



REALCOA'S PALMER  
*'It's not the money'*

REALCOA subdivision. Zydek complained of the water flow across his land and insisted that it was up to REALCOA to provide a remedy that would prevent damage to his property. Zydek charges that the grade engineering job was bad, but Palmer contends that the land formation itself is the problem.

Palmer maintains that he never contracted to provide more than the agreed-upon house and basic land grading. He asserts that his customers knew from the outset that he would do no landscaping.

When REALCOA did not correct the problem, the Zydeks notified the builders association, which tried to arbitrate.



HBA'S WIDDICOMBE  
*'Puts everybody on notice'*

The association sent two inspectors to the site, and each independently reported that a retaining wall was necessary. Palmer refused to build the wall, and he has been suspended for a year. He cannot be reinstated until he pays for the wall.

**Precedent?** Originally, Palmer claimed that a wall was not necessary and that the Zydeks were the only customers who had complained to him. But in an interview he hinted at a wider problem.

Other residents of the subdivision have put in retaining walls, he said, but have not asked REALCOA to pay. Were Palmer to pay for the Zydek

wall, as the association demands, he is afraid that the other buyers would possibly be entitled to compensation for their walls. There are 227 residents, and if Zydek's lot is as typical as Palmer claims, the cost of the retaining walls could run to hundreds of thousands of dollars.

**The HBA stand.** The association's executive vice president, Robert K. Widdicombe Jr., says: "A builder shouldn't start building unless he accepts the responsibility of adequately providing for what he sells. Our arbitration and ethics committee found that REALCOA should at least have given the homebuyer more instruction on what to expect with his home."

Widdicombe believes that REALCOA has "set itself above its own association by refusing to go along with our reasonable requests," and he cautions that a trade association must protect the public.

"This action against one of our own members puts everybody in our industry on notice," he warns. "If we don't regulate ourselves, we will be regulated by someone else." —M.A.

## Romney calls the FBI into a widening inquiry on housing's subsidy scandals

More than 200 instances of apparent law violations or irregularity in government housing programs have been referred to the FBI, according to Housing Secretary George Romney.

Romney testified before Chairman Wright Patman's House Banking Committee, which had reported that it found numerous cases in which dilapidated and overpriced houses were sold to poor people assisted by federal housing subsidies (NEWS, Feb.)

Romney conceded that, with some exceptions, his Housing and Urban Development Department's follow-up investigations "confirmed in major part the committee's findings."

**Falsehoods.** Romney said HUD found 41 cases that appeared to violate the law against making false statements to the FHA, and that these had been referred to the FBI.

He said another 45 matters that were referred to the bureau involved false statements and

certifications concerning required repairs, ownership, and fraudulent appraisals.

The 86 cases turned up in HUD's Section 235 interest-subsidy program to encourage home ownership among the poor.

The Washington newsletter *Housing Affairs* said the scandal and increasing costs might mean the end of both the 235 program and its twin, the Section 236 program for rental housing. Romney himself said the Section 235 difficulties "lead me to believe we ought to examine alternative methods. . ."

**Wider probe.** The House committee's inquiry had begun with the Section 235 program, but HUD's subsequent investigation broadened over housing programs generally.

Romney said another 112 instances were referred to the FBI and that they involved false statements, discrepancies in purchase agreements, and efforts by realty brokers to circumvent FHA regulations.

Romney said nine of the FHA's own staff appraisers were involved in cases referred to the FBI, and that five more had been disciplined.

**Detroit's scandal.** Romney did not say so, but housing experts said several of the referrals were probably based on irregularities reported by Don Ball of the *Detroit News*.

The *News*, which has tangled with Romney politically (NEWS, Sept. '70 *et seq.*), reported numerous cases in which realty brokers bought dilapidated homes for extremely low prices and in which appraisers assigned vastly higher values to the properties.

The brokers then arranged for poor families to buy the overpriced houses, often lending the 3% downpayment. Mortgage bankers advanced the purchase money, charging a deep discount on the loan. The FHA insured the loan.

The families could seldom make the mortgage payments,

and the results were foreclosures from which everybody—except the U.S. government—profited.

The broker profited from the big markup of the house. The poor family got a few months' free occupancy. And upon foreclosure, the mortgage banker got virtually the full mortgage amount back from the FHA. Since he had often discounted the loan as much as 10%—that is, he had lent only \$18,000 on a \$20,000 mortgage—he had a clear profit of \$2,000.

The only loser was the FHA, which was obliged to foreclose because it had insured the loans.

In that area alone, HUD suspended 99 free-lance appraisers, although it reinstated 80 of them.

**The 235 suspension.** Romney suspended all existing-house activity in the Section 235 program in January. That suspension still holds for 222 FHA insuring offices but it has been lifted for those serving 28 areas.



The Crestbrooke as built by Rowland & Lynch, Spartanburg, S.C.

## Get into profitable FHA 235 Housing, and leave the red tape to us.

Now's the time to get into this government-subsidized, single-family housing program—because current mortgage conditions don't affect availability of financing. And the modest monthly payments enable lower income families to afford homes for the first time. A bigger homebuying market for you!  Don't let the details slow you down. Call the expert who's been thoroughly trained to handle them — the Kingsberry Man. He can help you prepare specifications, estimate your costs accurately, and provide you with "marked"

**Nobody cuts it like the Kingsberry Man**

blueprints at no cost.  What else do you get from the Kingsberry Man? A full range of qualified models to choose from—more than 25 of them, with built-in curb appeal—ranging from 780 sq. ft. to 1268 sq. ft. Also, Kingsberry offers a new sectionalized model that qualifies under the 235 program!  Whether or not you've already applied for funds under the 235

program, the Kingsberry Man can come to your rescue and help cut the red tape...fast! Get in touch with him today—just mail the coupon. You'll get action in a hurry.

  
**KINGSBERRY HOMES**

Boise Cascade  
Manufactured Housing Group  
61 Perimeter Park East, Atlanta, Georgia 30341

Rudy A. Brown, Director-Marketing/Kingsberry Homes/Dept. HH-5  
61 Perimeter Park East/Atlanta, Georgia 30341/(404) 458-3241.

Please send more information on the Kingsberry program and have the Kingsberry Man call on me.

I presently do  do not  have funds committed under the FHA 235 program.

Name \_\_\_\_\_

Firm \_\_\_\_\_

No. lots I now have ready to build on \_\_\_\_\_

No. of homes \_\_\_\_\_, apts. \_\_\_\_\_ I built last year.

Address \_\_\_\_\_ Phone \_\_\_\_\_

City \_\_\_\_\_ State \_\_\_\_\_ Zip \_\_\_\_\_







# new

## Bayside...<sup>T.M.</sup> lap siding

multi-level textured hardboard  
in easy-to-install 12" x 16' laps

Introducing Bayside—a completely new siding with an embossed rough cedar texture.

Now, for the first time you can offer the beauty of multi-level textured siding combined with the proved durability, consistency, freedom from defects and easy finishing of X-90 hardboard.



Plus, Bayside lap is quickly and inexpensively installed because it comes in 16-foot lengths. You don't have to double course or use a backer. Top edge is machined to eliminate gaps under the lap. Bottom edge is beveled to stagger the horizontal lines. May be stained or painted.

Get details from your Masonite representative, or Masonite Corporation, Dept. HH-5, Box 777, Chicago, Illinois 60690.

THE  
MARK  
OF  
INTEGRITY



Masonite and X-90 are registered trademarks of Masonite Corporation.

## Foes show how to halt public housing in Chicago—and perhaps everywhere else

"This may be the end of public housing," says Federal Judge Richard B. Austin, summing up Chicago's bitter battle over shelter for the poor.

The fight climaxed in March, when Mayor Richard J. Daley, seeking reelection, took a public stand in opposition to a public housing plan based on Judge Austin's 1969 decision that such housing can no longer be concentrated in large slum projects.

The mayor then proposed his own housing plan but did not say how it would be funded. Public housing construction, already suspended, will be halted indefinitely if the Mayor refuses either to build public housing that complies with the judge's order or to provide financially feasible alternatives.

Several observers felt that, if the mayor were successful in blocking the court's plan, public housing might indeed be doomed throughout the country. They said the same tactics could be used anywhere to avoid dispersing units, and there is no law that public housing must be built.

**Near-panic.** The Chicago standoff developed after near-panic erupted over a plan to scatter public housing throughout white neighborhoods.

Judge Austin had found that the Chicago Housing Authority had been discriminating in the selection of sites, with 98% of its public housing in Negro areas. He ruled that any new units must be scattered throughout the city in small low-density projects. Only 25% could be placed in minority areas.

The CHA did not respond for almost two years, and the judge then ordered the CHA to present a list of sites to the City Council.

**Uproar over sites.** The CHA filed a plan for 275 sites with

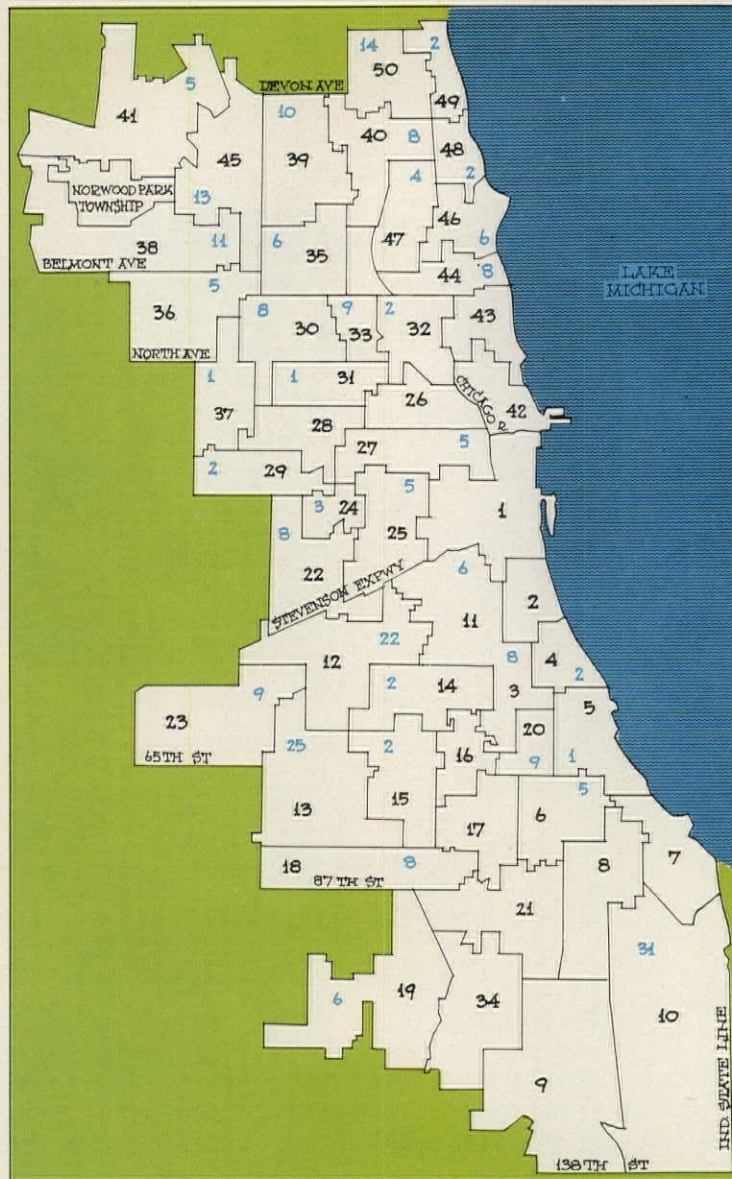

Public housing map that caused near-panic in Chicago shows how units would have been scattered. Ward numbers are in black. Blue numerals show number of units.

the council in March but did not release publicity that was supposed to explain the plan and to prevent panic.

Public reaction was immediate when a map of the sites was published. From all over Chicago came anguished cries of white property owners who thought they were to be inundated with typical public housing projects. Judge Austin knows first-hand about the reaction of near-panic. He has a stack of hate mail on his desk.

After a two-year silence on public housing, Mayor Daley entered the fray. In a speech against the CHA plan shortly after its appearance, he stated that public housing should be built only where it is "needed and accepted." He said that the plan would be "detrimental to all the people of Chicago."

The City Council did not

disapprove the plan. If it had, councilmen could have been held in contempt of court. Instead, they sent it to committee, where it can sit forever.

**Mayor's plan.** Mayor Daley came out later with his own housing plan for "new towns in town." It would supposedly offer housing for black and white families of all incomes. The mayor's aides suggest these towns can be built on little-used industrial tracts.

But funding is up in the air. Mayor Daley suggests that city or state funds can be used. Comments Judge Austin:

"There isn't enough money in the city and state to pay for the regular services. Where will money suddenly be found for public housing?"

Chicago receives no federal housing funds now and will not be eligible until it complies

with Austin's order. An estimated \$50 to \$80 million was lost in the two years since the ruling.

Even if other money were found, Judge Austin believes, that the same constitutional principles would apply to any new housing.

**The voters.** A complication was the mayoral election. Observers say that Mayor Daley had been reluctant to have the site map released by the CHA until after the election April 6. But Daley was considered a shoo-in, and even Judge Austin conceded:

"Daley will be reelected. The fuss may narrow or increase his victory by some unknown number of votes." (The mayor polled 70% of the vote to win a fifth four-year term.)

The 70-year-old judge is considered to be above politics. Ironically, he was recommended for his lifetime job by Mayor Daley.

**Around the nation.** Judge Austin concedes that the Chicago dispute may encourage opposition to public housing in other cities. He points out that the city can refuse to build public housing if it wishes to evade his order.

Neighborhood opposition has virtually killed public housing in Cleveland, but a citizens group is suing in federal court there to open the suburbs to public housing without the suburbs' consent.

Public housing may already be dead in San Francisco. Last month, a plan that follows the guidelines of Judge Austin's decision exactly was turned down by the Department of Housing and Urban Development for want of money.

—MARILYN ADAMS  
McGraw-Hill World News,  
Chicago



MAYOR DALEY  
*'Detrimental to all'*



JUDGE AUSTIN  
*'This may be the end'*

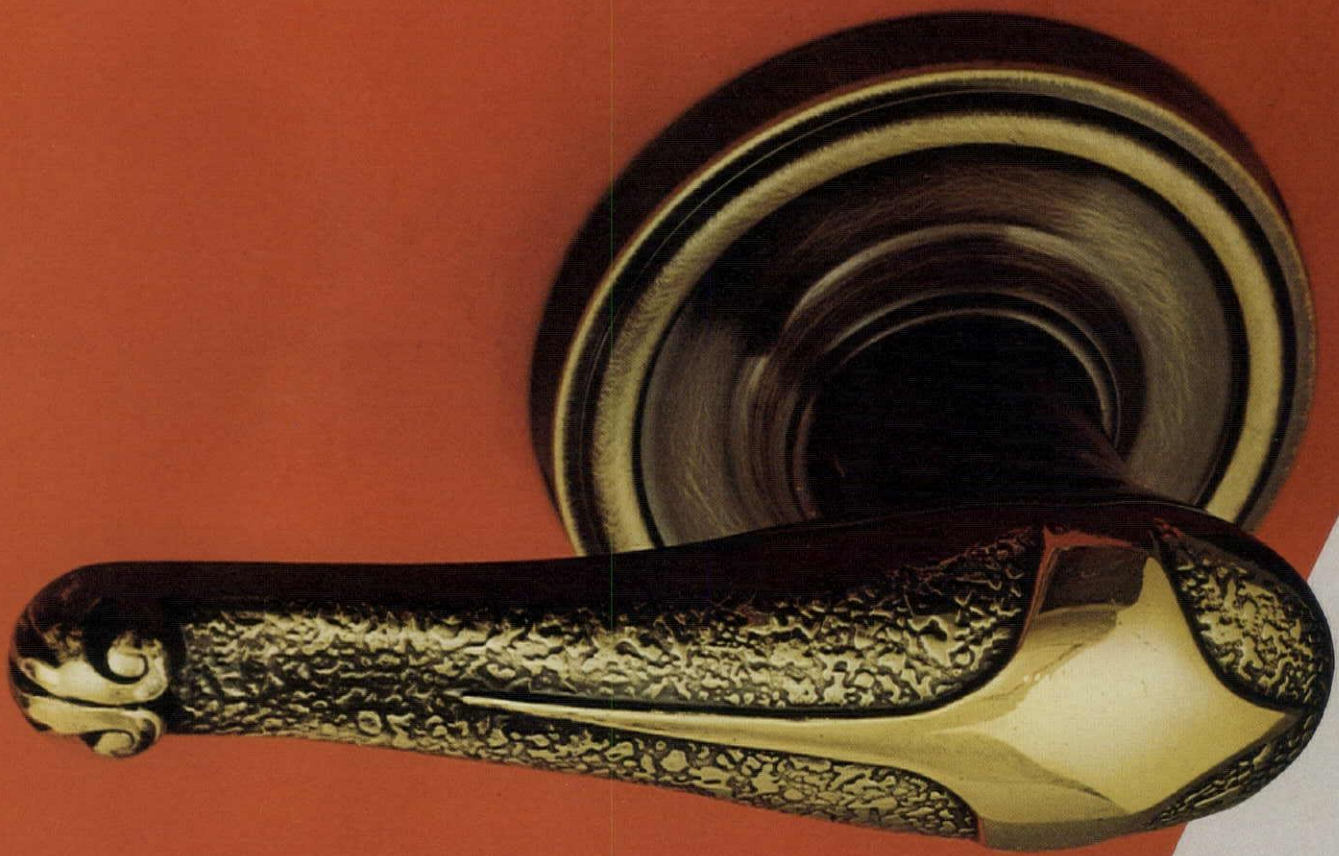

# ...and it's panic-proof, too.

Ah, the visual delights of our classic Colonial Lever Handle! Sensitive proportioned, rich in detail, and it saves lives. It's panic-proof. It locks people out, but never in. To escape, one simple, instinctive turn of the inside knob opens and unlocks the door. So — with all the points of beauty the Colonial shows here, the most beautiful won't photograph. No matter. We see it.

Surely you do, too — don't you?

**WESLOCK®**

**The LEADER in Lock Ideas!**

CIRCLE 17 ON READER SERVICE CARD

# WANTED PRESIDENT

Kaufman and Broad, the nation's largest independent company primarily engaged in housing, had 1970 sales of \$152,347,000 with pre-tax income rising 40% to \$12,431,000, the greatest growth of any company in our industry. We believe the past is prologue—we have just begun.

As a result of planned expansion, we are seeking an exceptional executive of unusual intelligence, motivation and achievement in the shelter industry to become President of a major subsidiary. He will run a large, independent operation as though it were his own business, backed by the resources of a \$157 million corporation. The successful candidate will have run a multi-location residential development company or division with sales in excess of \$5 million.

To the right individual we can offer an exceptional stock option plan as well as attractive salary, incentive compensation, benefit programs and opportunity for growth.

Write directly to us, Eli Broad or Eugene Rosenfeld, giving complete information in your first letter. Sorry, no phone calls.

P.S. We are also seeking a hard-driving Marketing and a knowledgeable Construction executive with multi-location experience.



## KAUFMAN AND BROAD INC.

10801 National Boulevard • Los Angeles, California 90064  
*Listed on the New York, American and Pacific Coast Stock Exchanges.* Offices presently in Illinois, Michigan, New York/New Jersey, Northern California, Southern California, Toronto, France and Germany.

# The whole house cooling and heating systems that do everything you want.



## From the people who make everything you need.

It's a comfort to know that Chrysler Airtemp can provide you with the right sized cooling and heating systems for any home or apartment your homeowner has in mind.

Airtemp specializes in producing residential cooling units from a popular 1½-ton capacity to a powerful 4-ton size. Plus, you can select our gas, oil or electric heating systems to match your cooling capacities.

Then if you want true total comfort, select the versatile Airtemp humidifiers and air cleaners. And add the

final touch with matching refrigerant lines, evaporator coils and thermostat.

So offer your customers the finest year-round climate system available: Chrysler Airtemp.

Airtemp goes one better.



## Washington suburbs fight plan to rescue townhouse project by renting it to the poor

"Enjoy gracious living in newly discovered Swiss Chalet-type garden apartments located along the grassy shores of the beautiful Potomac. . . It's easy. . . Simply declare yourself poor. Wealth makes no difference. Move in today and stay until Congress agrees to give you money for nothing. Only we can afford to make such a deal. . . Because of support of generous taxpayers. . . If you are interested, contact the Reverend Ralph Abernuty today. . ."

The leaflets—several hundred of them—were distributed by unknown persons throughout affluent Montgomery County, Maryland, which comprises a major portion of the Washington suburbs. They were passed around to dramatize the discontent of some residents with a local proposal that would have permitted poor families to lease apartments—through public housing—in a financially troubled townhouse development smack in the middle of a well-to-do neighborhood.

**Injunction.** While the local housing authority was ready to move ahead on the leasing

arrangements, Circuit Court Judge Kathryn J. Shook stepped in with a 30-day injunction barring rental agreements.

But, when 10 of the 52 new townhouses in the development were placed on the auction block, one of the original investors, Per Olof Holtze, bid high. He immediately said he would be willing to lease the units to the housing authority once the court order expired.

**A bail-out.** The development that was being considered for the public housing project is called Watkins Glen. Its houses were designed to sell at about \$45,000 but the project had been in trouble almost from the outset, and the public housing proposal was considered a way out for the developers.

The investors, in addition to Holtze, are Charles R. Wolfe and Wolfgang H. Altman. The three have put up more than half of the \$300,000 cost of the project which, they say, would have done all right had not the Maryland Roads Commission acquired part of the land for a highway spur.

The housing project was de-

layed, and the developers had to pay higher interest rates than they had expected.

**Enter HUD.** With foreclosure imminent, the Montgomery County Housing Authority's director, Troy Chapman, had earlier convinced the regional office of the Department of Housing and Urban Development to permit the authority to lease the townhouses and use them as subsidy housing for poor families.

"Some occupants will be fully employed," Chapman said at the time. "Some will be partially employed. Some will be on welfare. Some will be black. Some will be white."

Chapman planned to use Section 236 of the 1970 Housing Act, which permits a family to pay no less than 25% of its income for housing. The Housing Department would make up the difference for the renters.

**Luxury and race.** Several citizens' groups opposed the "luxurious housing for subsidized people." These groups feared a decline in property values and an impacting of schools.

One telephone caller told

Chapman:

"The only way to stop this sort of thing and get somebody in your chair with a rational point of view is to shoot you." Some observers attributed racial overtones to the message.

An official of a local citizens' group, Kenneth Brown, president of Regency Estates Civic Assn., said at the time that some members of this group "will stand up and be counted in saying their feelings are racial, while others will be concerned with the social impact of a small ghetto of poor people."

**No decision.** The battle is not over.

Residents of the area crowded early hearings on the leasing plan, and most voiced objections to the proposal. Meanwhile, the suit filed by some residents, which led to Judge Shook's injunction, is yet to be decided. Until then, the 34 completed units in the 52-unit development lie vacant, awaiting a decision as to who—or whether anyone—will occupy what a nearby sign advertises as "luxury townhouses." —A.M.

## There are now so many Levitt companies that it takes a company to manage them

And the manager is ITT Levitt Inc., just organized to oversee six Levitt operating corporations.

With creation of the new company, the Levitt organization realigns its management to fit broad operations that now span virtually every sector of the shelter industry.

The old table of organization had Levitt & Sons Inc. doing all the single-family building as well as managing the half-dozen divisions set up since serious expansion began in 1960.

That got to be a bit much for Levitt & Sons Inc., the headquarters company—and for some of the ambitious new divisions, too.

With a nice bow to corporate diplomacy, the then president of Levitt & Sons, Richard M. Wasserman, described the need for change this way:

"With these new businesses successfully launched with their own corporate staffs, it became necessary to make our structure conform to the new shape of our activities."

**New lineup.** Wasserman becomes president and chief executive of ITT Levitt, the company set up as the umbrella. Two veteran Levitt hands, Richard P. Bernhard and Norman Peterfreund, take portfolios as executive vice presidents of operations and finance respectively. William J. Levitt, who built the modern-day Levitt or-

ganization but who has been rather more concerned with other matters of late (*see box*), holds title as chairman.

The old Levitt & Sons Inc. becomes an operating unit concerned totally with developing residential communities in the eastern United States and Puerto Rico. Louis E. Fischer steps up from a senior vice presidency

to run the operation.

The other operating divisions are Levitt Building Systems Inc., Levitt Multihousing Corp., ITT Levitt Development Corp., Levitt United Corp., and Levitt France S.A.

**Beyond Levittown.** The Levitt organization was founded in 1929 and made its name with its first Levittown, built on Long Island after World War II.

The organization has since expanded its single-family detached-house building to the West Coast and Florida and to Puerto Rico and Europe. It has begun building garden and high-rise apartments, modules and mobile-modulars, and government sponsored housing; and it has begun selling land.

Levitt recently built its 100,000th home, making it history's largest private building organization on volume.

The entire Levitt organization was acquired by International Telephone and Telegraph in 1968. The Levitt headquarters remain at Lake Success, on Long Island.

### For Bill Levitt at 64—a brand new picture

William J. Levitt is going into the motion picture business.

America's master builder, who turned 64 in February, has just organized the Levitt-Pickman Film Corp. with Jerome Pickman, former head of American Continental Films. The intent is to produce and distribute movies, and the corporation will begin with distribution of Federico Fellini's "The Clowns."

Levitt-Pickman has headquarters at 505 Park Avenue in New York City.



FILMDOM'S LEVITT  
Building a new career

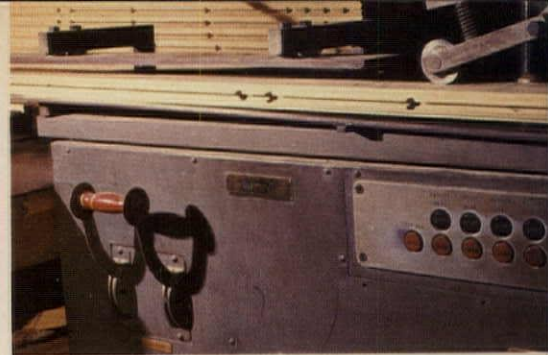
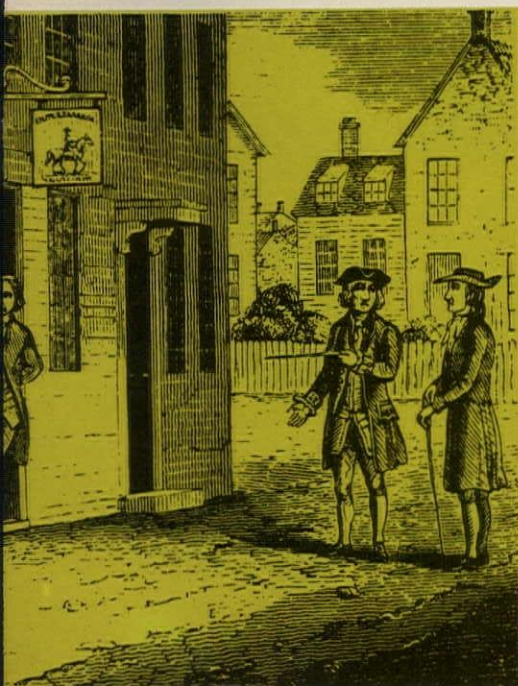
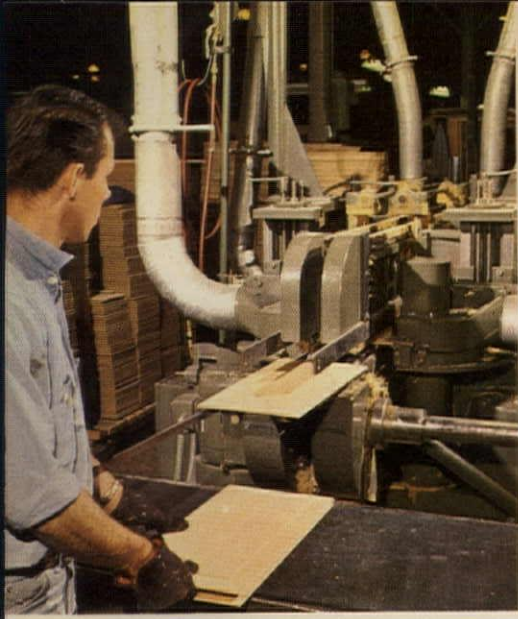

## You can see only 7 of the 33 ways Nord doors are *better*

If you could examine this door before it was finished, you could see only 7 of the 33 reasons it is a *better* door.

You could see the rich beauty and strength of the straight grain, old growth Western wood—but you couldn't see the three steps that provided uniform moisture content for trouble-free service.

You could see the precision match of all parts—stiles, rails, mullions and panels—but you couldn't see all the manufacturing care that provided the true matching and fit.

Yes, you could see only a few of the important reasons why NORD doors are out of the "commodity" class, even though at first glance a NORD door might look like it came from any one of a dozen or more factories.

Nord has prepared a booklet, "33 WAYS NORD MAKES IT BETTER," that you should have. It's yours for the asking. Simply put your name and the words, "33-NORD" on your business letterhead and mail it to E. A. Nord Company, Everett, Washington 98201. Your copy will come promptly.

It can help you to *better* entrances for *better* homes that *sell better!*

One of the best features of *COLONIAL CREST* doors is that you may have any one of the eight designs, carved into our six-panel Colonial door for *LESS* than virtually every other stile and rail door design without carving!

**NORD**

makes it better... *naturally*

CIRCLE 21 ON READER SERVICE CARD







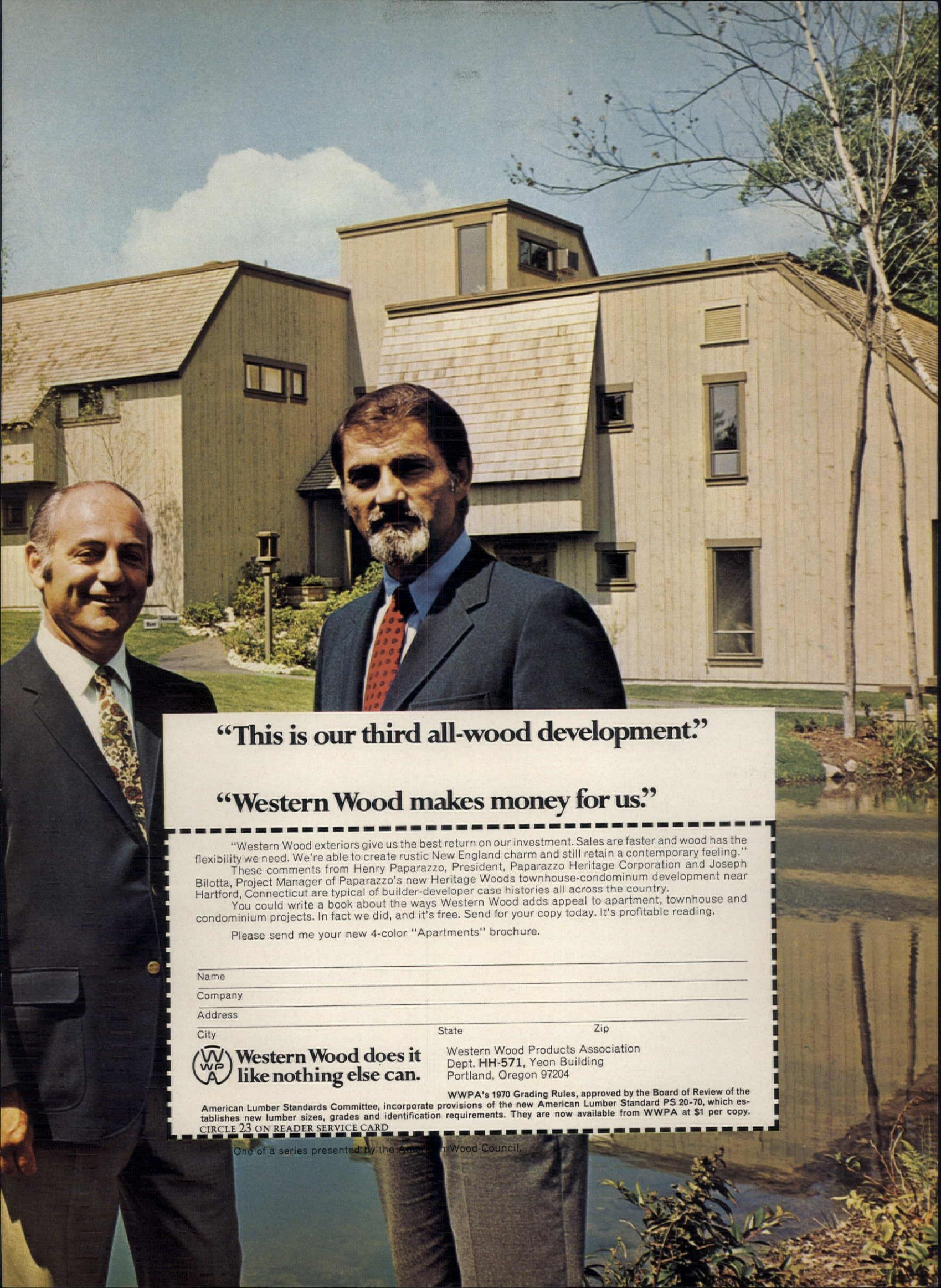

**“This is our third all-wood development.”**

**“Western Wood makes money for us.”**

“Western Wood exteriors give us the best return on our investment. Sales are faster and wood has the flexibility we need. We're able to create rustic New England charm and still retain a contemporary feeling.”

These comments from Henry Paparazzo, President, Paparazzo Heritage Corporation and Joseph Bilotta, Project Manager of Paparazzo's new Heritage Woods townhouse-condominium development near Hartford, Connecticut are typical of builder-developer case histories all across the country.

You could write a book about the ways Western Wood adds appeal to apartment, townhouse and condominium projects. In fact we did, and it's free. Send for your copy today. It's profitable reading.

Please send me your new 4-color "Apartments" brochure.

Name \_\_\_\_\_

Company \_\_\_\_\_

Address \_\_\_\_\_

City \_\_\_\_\_

State \_\_\_\_\_

Zip \_\_\_\_\_



**Western Wood does it like nothing else can.**

Western Wood Products Association  
Dept. HH-571, Yeon Building  
Portland, Oregon 97204

WWPA's 1970 Grading Rules, approved by the Board of Review of the American Lumber Standards Committee, incorporate provisions of the new American Lumber Standard PS 20-70, which establishes new lumber sizes, grades and identification requirements. They are now available from WWPA at \$1 per copy.  
**CIRCLE 23 ON READER SERVICE CARD**

One of a series presented by the American Wood Council.

## Critics of mortgage forms threaten court fight that could stall secondary market

Consumer opposition to the forms that would be used in a secondary market for conventional mortgages may not have ended with the public meetings held in Washington last month to air criticism of the documents.

Unless the forms are altered to effect what critics consider "a reasonable compromise" with the consumer, the critics may take their case to court. And a counsel for the Consumers Federation of America, Anthony Z. Roisman, added:

"We may institute class-action suits against lenders if we feel the forms don't give the consumer a fair shake."

The attorney, who had just finished testifying at the indignation meetings, indicated he wasn't satisfied with the way the meetings went. He complained that the moderator, former Congressman Albert Rains, "seems to have an investor bias."

**The sessions.** Rains sat for two days of meetings sponsored by the Federal National Mortgage Assn. and the Federal Home Loan Mortgage Corp., both of which would operate new secondary markets in conventional mortgages. Forty witnesses testified, dividing about evenly between lender and consumer orientation.

The meetings had been proposed by the consumer advocate Ralph Nader and by Senator William Proxmire (D., Wisc.), both of whom testified that consumers were being ignored by FNMA and FHLMC. Housing Secretary George Romney, attempting to meet Nader's criticism, published the forms in the *Federal Register* and stated he would personally approve the FNMA forms before any secondary market for conventional mortgages is permitted to begin. The same forms are to be used in both markets, so court action could delay the markets indefinitely.

The attorney who said his group might seek litigation indicated that "once Secretary Romney puts his stamp of approval on the forms, we could go to court under the Administrative Procedures Act." Such a suit would involve the government and a hearing examiner could rule on the forms.



### Another builder moves onto the Big Board

Shapell Industries listed on the New York Stock Exchange on April 6 under ticker symbol SHA. The stock opened at 35 1/4.

The photo above shows the exchange's president, Robert W. Haack (at left), as he welcomed Nathan Shapell, president and chairman of the company, and David Shapell, executive vice president, to the New

York trading floor.

Shapell, with headquarters in Beverly Hills, Cal., builds single- and multifamily homes and townhouses. The 3 1/2 million shares outstanding had been trading over the counter since the company went public in August 1969. It joins such builders as Kaufman & Broad, Jim Walter, and Del Webb on the Big Board.

**Whose home?** Criticism centered on several issues: prepayment penalties, late charges, acceleration of the mortgage, escrow accounts required by lenders but which bear no interest, control over insurance proceeds or condemnation awards, and right of entry.

Nader, in his testimony, contended that "the major fault of the FNMA form is that it assumes that the consumer's home belongs to the lender—which it does not.

"The form gives the lender complete and absolute discretionary control over insurance proceeds or condemnation awards, regardless of whether his security interest is impaired by the consumer's proposed use of the funds. It also gives the lender the power to invade the consumer's home for any reason, or no reason at all, without prior notice and make an 'inspection.'"

**"Legal overkill."** Nader argued that the lender has only two rights: to seize the house if the consumer fails to make the agreed-upon payments and to require the consumer to maintain the value of his home above the balance owed on the mortgage. He said any powers granted to the lender in excess of those

rights should be eliminated.

Proxmire said the forms constitute a form of "legal overkill." He charged that "the lender is given every conceivable form of protection at the expense of the homebuyer."

Consumer groups seek to change the forms to eliminate prepayment penalties, permit the payment of interest on escrow payments, give the homeowner discretionary powers over the use of hazard insurance proceeds, provide sufficient notice by lenders of their intention to accelerate the mortgage, and fix "late" charges at a maximum of 2% of the late installment.

**Lenders' stand.** The Mortgage Bankers Association's president, Everett C. Spelman, said the critics "appear unconcerned with or unaware of the major part the individual plays in providing funds for mortgage investment."

Spelman emphasized the need to strike a balance between the borrower-consumer and the saver-consumer. He contended:

"It is obvious that the borrower benefits from the availability of funds for home financing. It is less obvious that he benefits from protection given to lenders in mortgage instruments. But

he definitely does benefit from both."

**And a warning.** Defending the forms largely as written, Spelman argued that "the protections (to the institution) are for him (the consumer) and are demanded by the institution investing his funds.

"Without these protections, the money will not be lent; it will not be available from private investors, or from FNMA or FHLMC. Having no secondary market purchasers for their mortgages, FNMA and FHLMC would quickly reach the limits of their effectiveness."

Spelman, as did numerous other investor witnesses, argued in favor of a substantial "late" charge:

"The late charge works well as a deterrent against chronic delinquencies and helps keep borrowers from accumulating delinquent payments to the point where foreclosure cannot be avoided."

The MBA president also said that a prepayment penalty much enhances the marketability of a mortgage.

"Borrowers have contracted to pay a fixed rate of return for a definite period of time," Spelman pointed out. "If a mortgage is prepaid prior to its scheduled maturity, the lender is faced with reinvesting his savers' funds at a reinvestment cost."

Spelman and other investor witnesses were equally assertive on the question of prepaying taxes and insurance. The forms, they argued, assure that taxes and premiums will be paid when due, and investors are protected against the likelihood of the imposition of prior tax liens and the loss of insurance coverage.

Investor spokesmen stressed that a balance was needed between the investor and consumer, but at the same time warned against making the form unworkable or unmarketable—a factor which would effectively kill the program.

Equally troublesome, however, may be the spectre of a drawn-out court battle, as hinted by the consumer group's counsel.

That, says a Senate housing aide, "could hold up the program for years." —A.M.

# Bare walls will never move Billy Johnson's parents.

What they want is something special on the walls. Durable and scrubbable. Something pretty, too. Like Wall-Tex®. It keeps the walls looking nice—just wash away the creative urges of a kid like Billy Johnson. That protects his parents' deposit on an apartment or the value of their new home. And gives you an extra sales point. Wall-Tex. The fabric-backed vinyl wall-covering. Over 700 patterns for any room, any decor. Pre-trimmed for easy hanging. And it's easy to take down when it's time to change. Check out the Wall-Tex sample books. You'll find just what you need. To add sales appeal to your homes or apartments . . . and merchandising value. There's only one Wall-Tex. It's available everywhere and, yes, it will help you move Billy Johnson's parents.

**Wall-Tex**  
First in Vinyl Wallcovering



COLUMBUS COATED FABRICS  
Division of Borden Chemical, Borden, Inc.  
Columbus, Ohio 43216

CIRCLE 25 ON READER SERVICE CARD



You tell us what your next job is . . .

and we'll tell you how **FHA multi-family financing** can give you a bigger profit.

Maybe you don't know all that's available to you through FHA multi-family financing. But we do. And we're busting to tell you.

Usually, you can get 90% loans — up to 40 years. No participation by the lender. And no achievement clause in the commitment.

So far, so good. It gets even better. Interest rates are substantially below conventional rates. And discounts are small or, in some cases, nonexistent.

Right now, funds are especially plentiful for construction and permanent loans on luxury and middle income apartments. And prospects are equally promising for

low rent subsidized apartments, nursing homes, land loans — and on it goes.

Friend, this is the dawning of the age of FHA!

And as good as FHA is, we've made it even better with a few zingers of our own. Like a computer that can analyze your project in minutes and tell you if it's feasible. Like a staff of gung-ho red-tape-cutters. Like the ability to process a project anywhere in the United States — because of our Washington, D.C. office and our network of operating companies.

For an analysis of your project or more information, call or write us today. We're talking profits — now!



Associated Mortgage Companies, Inc., 1120 Connecticut Avenue,  
N.W., Washington, D.C. 20036 (202) 338-3500  
Associated-East Mortgage Co., Camden, N.J. (609) 365-4550  
Associated-Midwest, Inc., Chicago, Ill. (312) 346-4588  
Associated Mortgage Companies of Virginia, Inc., Hampton, Va. (703) 838-1600  
The Berens Companies, Washington D. C. (202) 333-8600  
City-Wide Mortgage Co., Kansas City, Mo. (816) 221-9100  
Pringle-Associated Mortgage Corporation, New Orleans, La. (504) 486-5501  
Southern Mortgage Company, Aiken, S.C. (803) 648-2621  
**Mortgage Sales and Placement:** AMCO Investor Services, Inc., New York City

New elegance for the bath...

# Crystal Glo



Also available with heavy plate 23 karat hard gold finish.



**Harcraft**

Great music... fine paintings... exceptional works of art never go out of style. Exceptional design also endures. Harcraft's CRYSTAL GLO,<sup>®</sup> in a few short years, has become a standard of excellence in the building industry. The signature of the home builder who cares about elegance... about people... is the signature of the builder who specifies CRYSTAL GLO.

To complement the magic of CRYSTAL GLO, Harcraft will soon introduce a new low-cost line of plumbing brass.

Write or call us. We'll gladly arrange a personal presentation. And prove, once again, that homes and apartments equipped with Harcraft do sell faster.

HARCRAFT BRASS Division of Harvey Aluminum  
19200 South Western Ave., Torrance, California 90509  
Phone: (213) 775-2181

CIRCLE 27 ON READER SERVICE CARD

H&H MAY 1971 27

## Mortgage men discover a money machine—the new Ginny May securities apparatus

Mortgage-backed securities are being called the wave of the future by virtually every knowledgeable mortgage man.

The securities, guaranteed by the Government National Mortgage Assn., have—in one year's time—lived up to their advance billing, and then some.

This fact became evident during the recent New Orleans conference of the Mortgage Bankers Assn. The mortgage men crowded the south ballroom of the Royal Sonesta Hotel on two successive days to hear four experts explain the do's and do-not's of mortgage backed securities.

Mortgage money—usually the center of attention at these MBA conferences—failed to attract more than passing interest. The mortgage bankers were too busy rushing to sessions to hear about the newest—and perhaps easiest—money-making opportunity.

**The market.** The securities are, of course, credit instruments backed by FHA and VA mortgages and guaranteed by GNMA. Issuers—mortgage bankers, commercial banks, savings and loans, and others—sell them directly to investors or place them with Wall Street underwriters who have already developed a secondary market.

Woodward Kingman, Ginny May's president, told the mort-

gage bankers that \$900 million worth of small (\$2 million and up) issues of the securities have been sold and delivered in the program's first year. A few large bond-type issues backed by GNMA also have been sold, raising the total beyond \$2.2 billion.

Pension funds are still expected to invest heavily in the securities, but Kingman explained that savings and loan associations have so far purchased the largest share.

**Top profits.** To mortgage bankers and other issuers, the securities represent a method of side-stepping tight money. By originating the loans and then selling them to underwriters, the mortgage men not only turn a neat profit on the sale; they increase their regular servicing income.

The drop in FHA interest rates, from 8½% to 7% early this year, brought a little bonanza for mortgage bankers. When the basic coupon rate on a mortgage drops, investors will then pay a premium price for any mortgage that carries the older and higher rate.

With the coupon rate now at 7%, several packages of securities backed by the old 8½% mortgages are now selling to investors at prices as high as 107 cents on the dollar. Since the mortgage bankers bought

the original loans from builders at deep discounts, or well under 100 cents on the dollar, the profit is considerable.

The issuer of the security also receives a servicing fee of .44% rather than the .38% he can get by servicing loans for the Federal National Mortgage Assn., the big mortgage purchasing company, or for private investors.

And, say mortgage experts, it is in servicing fees that the mortgage banker sees the real profit potential. One mortgage banker said in New Orleans: "We don't need to make a profit on the sale.

"Just knowing we've got .44%—and for the life of the mortgage pool—is enough for mortgage bankers."

**Risks.** That .44% is not clear profit. Richard L. Buchanan, vice president of the Metropolitan Mortgage Corp. of Cleveland, explained during a panel discussion of GNMA securities: "There is a small cost of foreclosure which the issuer of these securities must bear."

Buchanan said his firm figures this cost at from two to three basis points, bringing the net servicing fee to either .42 or .41%. But that is still higher than that available from Fanny May or the private market.

The panelists agreed that they saw no problem as yet

about handling mortgage foreclosures while at the same time making the monthly payments of interest and principal on the foreclosed mortgages to their individual investors. William Johnson, vice president of National Homes Acceptance Corp. of Lafayette, Ind., said delinquencies might have to run as high as 40% to 50% before an issuer found it difficult to make the pass-through payments. Kingman agreed, noting that no issuer has yet run into any problem meeting his monthly payment schedule.

**New securities.** The GNMA president indicated the present program is working so well that he is expanding the concept to include mortgage-backed securities for multifamily construction loans.

The possibilities for mortgage-backed securities are already recognized by most in the home financing industry, and Wall Street firms are opening dealerships.

For many mortgage companies, the business of dealing directly in mortgages—that is originating loans and selling them outright to an investor—has already become passé. From the interest in the newer program shown at the MBA sessions, it would seem that the trend into the securities market can only accelerate. —A. M.

## Savings-rate control dies quietly, and Congress argues over how to revive corpse

The House and Senate have played out a little cat-and-mouse game with housing.

The two chambers have been at odds all year as to what to do about dividend and interest controls over banks and S&Ls.

Housing interests have always argued that rate control provides funds for homebuilding and financing because the savings and loan associations, traditional suppliers of housing money, have been permitted a slight rate advantage over banks.

But pressure has been building from many in the Nixon administration to abolish rate control. Their argument is that controls discriminate against small savers.

**Senate's balk.** With the authority for bank and S&L regulatory agencies to set the savings

rates for their constituent institutions set to expire March 21, neither House nor Senate could decide how best to handle an extension.

The House did enact a measure prior to the expiration date, and it would extend rate control for two years. In the Senate, however, Wisconsin Democrat William Proxmire complained that the Banking Committee needed more time to hear witnesses on the rate question.

Proxmire, chairman of the financial institutions subcommittee, introduced a joint resolution to extend the rate-control authority for just two months, to June 1. Proxmire said he wanted to hold hearings on the House-passed measure before the Senate voted on any two-year extension.

**Death of controls.** Meanwhile, March 21 drew nearer, with both sides adamant. Aides to the House Banking Committee stated privately: "We've done our work. If the Senate wants to extend rate control, let them pass our bill. We're not going to pass a two-month extension."

Senate Banking Committee aides were equally perturbed over the House's refusal to go along with their minor resolution. March 21 came and went—and rate control expired.

Had money been tight, the result would have been an immediate bumping up of savings rates around the country. But with funds in plentiful supply, banks and savings and loans had no reason to change their rates. The expiration date passed al-

most unnoticed.

It was the House that finally acquiesced. It passed the Senate joint resolution extending the measure until June 1. As the House was voting, Senator Proxmire's subcommittee was preparing to hold its hearings on the House bill to extend the legislation until 1973.

**Doubts.** Whether that will eventually become law is uncertain, since even the administration is not in agreement with the extension.

Meanwhile, a Presidential Commission on Financial Structure and Regulation is working on this same problem—whether rate control is even needed in today's economy. It may be the commission, in the last analysis, that has the final say—and it might say no. —A. M.



## Potlatch Engineered Wood Products help you build better for less...

Lock-Deck® laminated decking with laminated posts and beams have opened the way to a whole new world of wonderful architectural designs that once had to compromise beauty for strength and economy. In one easy application you get both a structural roof system and a handsome finished

ceiling. Laminated wall and partition systems can give you both structural and finished walls inside and out. Tremendous strength, freedom from warping, twisting or checking, and wide choice of species, patterns and factory finishes are just a few of the inherent advantages of new Potlatch

laminated wood products from the forests where innovations grow.

### **Potlatch**

**WOOD PRODUCTS GROUP**  
P.O. Box 3591 • San Francisco, CA 94119

Potlatch, the forests where innovations grow... in wood products and factory-built structures, in paperboard and packaging, in business and printing papers.

CIRCLE 29 ON READER SERVICE CARD

H&H MAY 1971 29





PPG Coating Technology adds value to factory-finished metal

# PPG DURACRON® Coil Coatings say it loud and clear— this is quality construction

PPG Coil Coatings say quality—say it beautifully—and go on saying it for years.

There's more to PPG Coil Coatings than just a visual expression of good construction. Prefinished aluminum building products in PPG colors bring stand-out values to builders in these days of rising costs and shrinking profits. Siding, shingles and trim, with PPG coatings, deliver real economies and installation benefits to the building

site. And they promote enthusiastic buyer reactions to help close deals.

With building products finished with PPG DURACRON Coatings, the buyer can be assured the color will last—and will require practically no maintenance. These new architectural coatings are specifically formulated for exterior surfaces and are baked on at the factory to a tough, hard, mar-resistant finish. They stay clean and bright in any climate and retain their

fresh appearance.

Get the complete sales-building quality story on aluminum products finished with PPG Coil Coatings from Sweet's Architectural File, your siding manufacturer or PPG INDUSTRIES, Inc., Dept. 16W, One Gateway Center, Pittsburgh, Pa. 15222.

**PPG: a Concern for the Future**

Coil  
Coatings   
INDUSTRIES

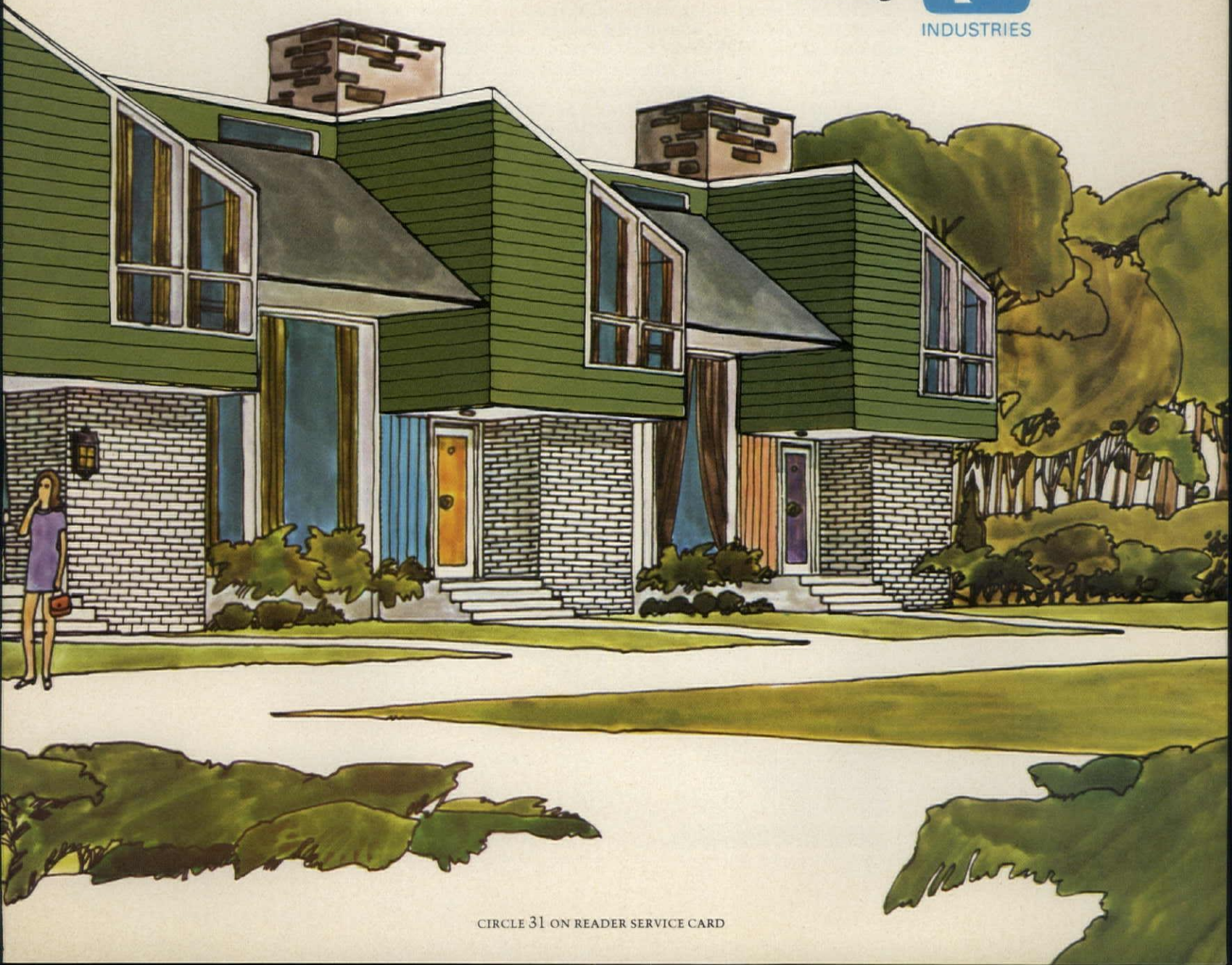



# CORIAN.<sup>®</sup>

## Tops—in solid elegance

These counter tops are Du Pont CORIAN<sup>®</sup>—the first new choice in kitchen counter-top material in 30 years. CORIAN is a solid material that needs no edging. Its warm, opalescent beauty and delicate pattern will never fade or wear away because they go all the way through. Solidly elegant. Solidly durable.

CORIAN is exceptionally tough. It resists stains, scratches, impact damage, burns and heat. And because of its solid composition, surface damage can be easily repaired.

It's easy to install. CORIAN is available in 25" and 30" widths for both wall and island units, with or without prefitted stainless-steel sinks. It can be sawed, drilled, shaped and polished with ordinary tools. CORIAN. When you want the top—in three elegant colors. For more information, write: Du Pont Company, Room 22372, Wilmington, Delaware 19898.

\*Du Pont registered trademark for its line of methacrylate building products.



BUILDING PRODUCTS



# Housing stocks have been surging upward along a broad front for five months

HOUSE & HOME's index of 25 housing stocks rose from 387.33 to 418.39 in the month ended April 1. It was the fifth consecutive monthly gain. Issues on the index are indicated by dots (•) in the tables at right. Here's the composite index:



HOUSE & HOME  
VALUE INDEX  
OF 25 BUILDING STOCKS

SHARPE PRICES OF JANUARY 1966 = 100  
1966 69 70 71

How top 5 did in each group:

	Apr. '70	Mar. '71	Apr. '71
<b>Builders</b>	401	503	539
<b>Land develop.</b>	480	560	593
<b>Mortgage cos.</b>	608	740	795
<b>Mobile homes</b>	559	687	763
<b>S&amp;Ls</b>	146	170	185

## HOUSING'S STOCK PRICES

COMPANY	April 2 Bid/Close	Chng. Prev. Month
<b>BUILDING</b>		
Behring Corp. b	16 3/4	- 1 1/2
Bramalea Cons (Can.)	4 1/2	- 3/8
Capital Divers (Can.)	1.10	
Centex Corp.	24 1/2	
Christiana Cos. b	12 1/2	+ 2 1/2
Cons. Bldg. (Can.)	1.70	- .05
Dev. Corp. Amer.	32	+ 2 1/2
Dev. Int. Corp.	19 1/2	+ 4 1/2
Edwards Indus.	11 1/4	+ 2 1/2
First Hartford Rity.	9	+ 1 1/4
First Nat. Rity. b	2 1/4	- 1/4
Frouge	2	+ 1/4
•General Bldrs. b	7 1/4	- 1/2
Hunt Building Marts.	5 1/2	+ 1/2
•Kaufman & Bd. e	57 1/4	+ 3 1/4
Key Co. b	9 1/2	- 1 1/2
Leisure Technology Corp. b	25 1/2	+ 3 1/2
H. Miller & Sons.	10 1/4	+ 1 1/2
McGrath Corp.	8	+ 1 1/2
National Environment (Sproul Homes)	1 1/4	- 1/4
•Presidential Realty A b	14 1/2	+ 1 1/2
Presley Development	38	+ 6 1/4
Pulte Homes	15 1/2	- 1 1/2
Robino-Ladd	21 1/2	+ 3 1/2
Ryan Homes	7 1/2	+ 7
Shapell Industries.	35 1/2	+ 5 1/2

a—stock newly added to table. b—closing price ASE. c—closing price NYSE. d—not traded on date quoted. g—closing price MSE. h—closing price PCSE. k—not available. —Computed in HOUSE & HOME's 25-stock value index. y—adjusted for 2-for-1 reverse split. z—adjusted for 3 for 2 split. NA—not applicable.

Sources: New York Hanseatic Corp., Gairdner & Co., National Assn. of Securities Dealers, Philip Beer of Russell & Saxe, American Stock Exchange, New York Stock Exchange, Midwest Stock Exchange, Pacific Coast Stock Exchange. Listings include only companies which derive a major part of their income from housing activity and are actively traded.

Standard Pacific Corp. b	8 1/2	+ 1/4	Canaverl Int. b	6	- 1/8
U.S. Home & Dev. b	48	+ 4 1/2	Crawford Corp.	5 1/2	+ 1 1/2
•Jim Walter e	40 1/2	+ 2 1/2	•Deltona Corp. b	41 1/2	+ 1 1/4
•Del E. Webb e	11 1/2	+ 1 1/4	Disc Inc.	4 1/2	- 3/4
Washington Homes	23 1/2	+ 8 1/4	Don the Beachcomber Ent. (Garden Land)	7	
Western Orbis b	5 1/2	+ 3/8	FPA Corp. (Fla. Palm-Aire)	9 1/2	- 1 1/4
<b>S&amp;Ls</b>			•Gen. Devel. e	29	- 1/4
American Fin.	33 1/4	+ 7/8	•Holly Corp. b	2 1/2	+ 3 1/4
Calif. Fin. e	9	+ 3/4	Horizon Corp.	42	+ 3 1/2
Empire Fin. b	16 1/4	+ 3/8	Major Realty	10 1/2	+ 1 1/2
•Far West Fin. e	15 1/2	+ 1 1/2	•McCulloch Oil b	51 1/2	+ 8 1/2
•Fin. Fed. e	18 1/2	+ 2 1/4	Scientific Resources e (Sunasco)	1 1/4	+ 1/4
•First Char. Fin. e	49 1/4	+ 4 1/2	So. Rty. & Util. b	6 1/2	+ 3/8
First Lincon Fin.	9	+ 2 1/2	<b>DIVERSIFIED COMPANIES</b>		
First S&L Shares b	21 1/4	+ 1 1/4	Boise Cascade e	42 1/2	- 1 1/8
First Surety	4 1/2	+ 3/8	Citizens Financial b	16 1/4	- 1/8
First West Fin.	2 1/4	- 1/4	City Invest. e	23	+ 2 1/2
Gibraltar Fin. e	25	+ 1 1/4	CNA Financial e	20 1/4	- 1 1/2
•Great West Fin. e	26 1/4	+ 1 1/2	Cousins Props.	42	+ 4
Hawthorne Fin.	13 1/2	+ 1 1/4	Forest City Entr. b	26 1/2	+ 6 1/2
•Imperial Corp. e	15 1/2	+ 1	Great Southwest Corp.	2 1/2	- 3/8
Trans-Cst. Inv.	9 1/2	- 1	Investors Funding b	11 1/4	- 1
Trans World Fin. e	12 1/2	+ 1 1/2	Leroy Corp.	3 1/4	+ 1/4
Union Fin. b	11 1/2	+ 3/8	Rouse Co.	42 1/4	+ 4 1/2
United Fin. Cal. e	11 3/4	+ 1 1/4	Tishman Realty e	24 1/2	- 3/8
Wesco Fin. e	23	- 1/2	<b>MOBILE HOMES &amp; MODULES</b>		
<b>MORTGAGE BANKING</b>			Con. Chem. Co. b	10 3/4	- 1/4
Charter Co.	50	+ 15	•Champion Homes b	33 1/2	+ 5 1/4
CMI Investment Corp. b	30	+ 3/4	Commodore Corp. b	10	- 1 1/2
•Colwell b	26 1/4	- 2 1/2	•Fleetwood e	35 1/2	+ 5
•Cont. Mtg. Investors e	23 1/2	+ 5 1/4	•Guerdon b	20 1/2	+ 3/8
Excel Investment	11 1/4	- 3/8	Mobile Home Industries	15 1/2	+ 1 1/2
FNMA e	68 1/2	+ 6 1/2	Monarch Ind. e	20 1/2	+ 1 1/8
First Mtg. Ins. Co.	12 1/4	+ 2 1/4	•Redman Indus. e	29 1/4	+ 2 1/4
•First Mtg. Investors e	31 1/2	+ 2 1/2	Rex-Noreco b	20 1/2	+ 4 1/2
•Lomas & Net Fin.	16 1/2	+ 1 1/2	•Skyline e	32 1/2	+ 3 1/2
•MGIC Invest. Corp. e	86 1/4	+ 4 1/2	Town & Country Mobile b	9 1/4	- 1 1/8
Midwestern Fin. b	23	- 5/4	Zimmer Homes b	15 1/2	- 3/8
Mortg. Associates.	35	+ 3 1/4	<b>Hodgson Houses</b>		
Mortg. Trust of Amer.	26 1/2	+ 3 1/2	Modular Housing Systems Inc.	19	- 2 1/4
North Amer. Mtg. Inv. b.	28 1/4	+ 2 1/2	Nat. Homes A. e	32 1/2	+ 5 1/4
Palomar Finan.	13	+ 1 1/4	Nationwide Homes	7 1/2	+ 3/8
UIP Corp. b	3 1/2	- 1/4	Shelter Resources	10	- 2 1/2
(United Imp. & Inv.)			Stirling Homex	22 1/2	- 2
<b>LAND DEVELOPMENT</b>			Swift Industries	3 1/2	- 3/4
All-State Properties	1 1/2	+ 3/8			
American Land	1/2				
•AMREP b	35 1/2	- 1 1/2			
Arvida	13 1/2	+ 1 1/4			
Atlantic Imp.	15				

# Raynor can fill this opening with any of nearly 1,200 residential garage doors

From the glamorous styling of custom-designed, carved wood panels to the functional security of attractive steel doors. From the classic simplicity of flush wood, to the enduring translucent beauty of fiberglass. One-car or two-car. Standard or custom sizes. Raynor offers you every popular garage door style in every popular material, in a full price range. And there's more. Electric operators, complete accessory lists, fast delivery, the industry's finest guarantees, the very latest engineering advances. All in one complete line. Send for free literature. Raynor Manufacturing Company, Dixon, Ill. 61021.



**RAYNOR**  
The Brand You Can Depend On



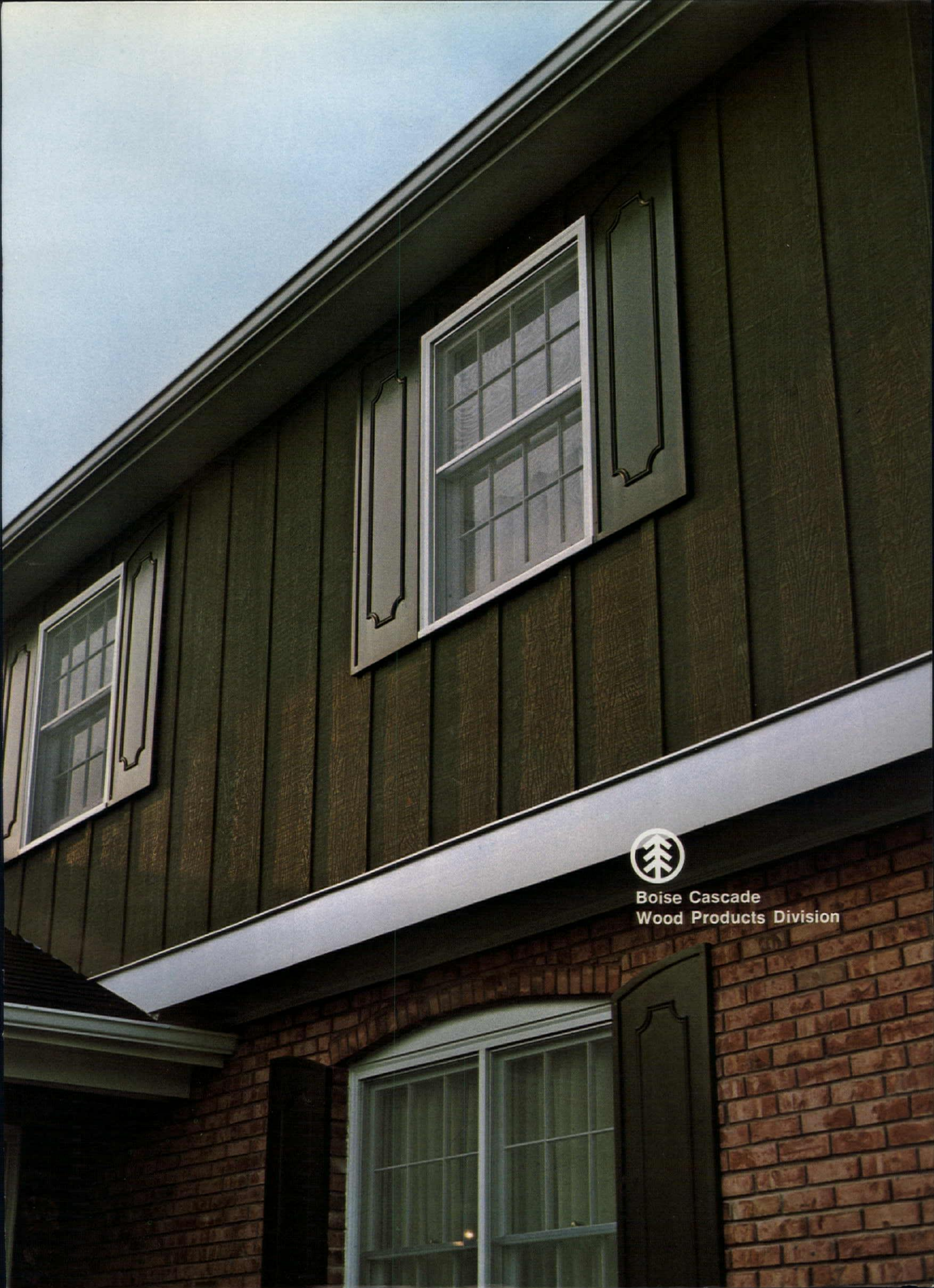

Boise Cascade  
Wood Products Division

# Only the best-selling van gives you all these better ideas



## Easy, out-front servicing.

Simply raise the convenient outside hood and your routine service points are right at hand: radiator, oil level, battery, windshield

washer reservoir, voltage regulator, wiper motor, brake master cylinder. Better ideas make servicing fast, easy.

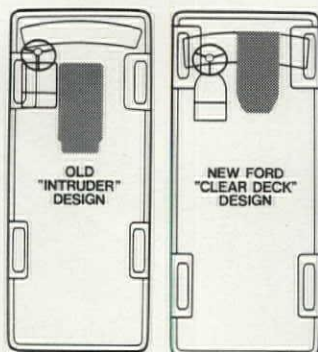

## Engine clear forward.

The engine is moved forward in Ford's clear-deck van—all the way out of the cargo area. Clear floor space behind driver's seat measures over 8½ ft. in Econoline Van . . . over 10 ft. in the Supervan.

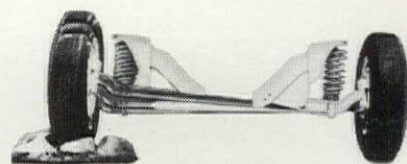

**Strong, smooth-riding Twin-I-Beam.** The independent front suspension that has revolutionized truck riding qualities. Two forged steel I-beam axles give it strength . . . big coil springs give it a smoother ride.



**Biggest payload of all.** Husky construction and high capacity axles allow you to carry a heavier load than any other van. Maximum payload of 4320 lbs. is largest in industry.

Sales leader for 10 straight years.

## Shorter outside, easier to park.

Overall length of Econoline Vans is significantly shorter than other makes. This means easier parking and better maneuverability in city delivery operations

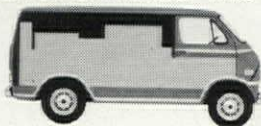

—time saved on every trip.

## Wider at top for built-ins.

Body sides are more vertical, wider apart at top than other vans. So built-in units fit better and leave more aisle. Modular units, designed to fit and work together allow you to custom design almost any interior you need. Job packages, such as insulated florist's van, are also available.

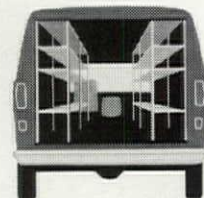

## Driver's "walk-thru" to rear.

Econoline's forward engine position clears the deck for the driver, too. He can easily step from his seat into the rear load area and exit through side or rear doors.

See your Ford Dealer and see all the better ideas in America's best-selling van—Ford Econoline.

A better idea for safety: Buckle up.



# FORD ECONOLINE VANS



Model	Max. Payload	Max. GVW
E-300	4320 lbs.	8300 lbs.
E-200	1800 lbs.	5400 lbs.
E-100	1120 lbs.	4500 lbs.

## President imposes wage guidelines on building unions—and labor fights back

The Nixon Administration—although it officially denies it—has thrown up wage guideposts for the construction industry.

In the second round of the government - vs. - construction workers bout this year, President Nixon has signed an executive order that sets up a "cooperative system of constraints" for wages and prices in construction.

At the same time, the President restored the Davis-Bacon Act provisions he had suspended February 23. These rules provide that workmen must be paid prevailing union wages on all federal projects (NEWS, April).

The President's new order would establish labor-management boards to review collective bargaining agreements for each craft. A labor-management-public committee would review the boards' findings.

**Labor's objection.** The requirement that has aroused the unions says that wage raises, to be approved by the various

stabilization boards, must be supported by greater productivity and a rise in the cost of living. Moreover, they can't exceed the average annual increases negotiated during the 1960s—about 6% a year, according to Labor Secretary James D. Hodgson.

C. J. Haggerty, president of the building and construction trades department of the AFL-CIO, insisted that the President had set up "full controls" over construction wages. He rejected the administration's own statement that the rules were something less.

The 17 AFL-CIO construction unions, representing 3½ million craftsmen, said they could find no legal basis to fight the plan, and their leaders agreed to serve on the stabilization panel.

But on being named to the board, S. Frank Raftery, president of the painters, warned:

"Our people will never accept a limit of 6% in increases."

And the AFL-CIO president,

George Meany, said that wage restraints applied to a single industry were unfair and unworkable.

**Penalties.** Lawyers for the unions said the executive order, although full of "ambiguities and uncertainties," would permit the Secretary of Labor to set fines as high as \$5,000 if he feels the order has been violated.

The administration has consistently maintained it intends to hold down the skyrocketing wage rises in the construction field. As early as January, in his economic report, President Nixon decried the wage increases and called for a voluntary program to slow the rise in both prices and wages.

When no voluntary program developed, Mr. Nixon suspended the Davis-Bacon provisions. But, with 300 to 400 wage contracts for construction crafts in the throes of renegotiation, Secretary Hodgson continued to

try to arrange a voluntary program.

**Loopholes.** The new executive order does permit "equity adjustments" to restore traditional relationships among crafts in a locality, or with the same craft in a neighboring area. If plumbers received a large increase a year ago, another craft in the same area might be permitted a raise of more than 6% in order to gain wage equity.

But Hodgson insists that the administration is going to stabilize construction wages. Should any contract be found wanting under the new executive order, the Secretary can freeze the Davis-Bacon wage level for any affected craft and area. That would restore the rate that prevailed prior to the settlement.

Moreover, says Hodgson, should the new stabilization system prove unworkable, the President might again suspend the Davis-Bacon provisions on a nationwide basis. —A.M.

# Rez®

## The best thing that's happening to wood

REZ Double-Tones . . . a one-coat system, specially designed for rough-sawn or textured exterior woods. Extra-heavily pigmented, yet costs no more than conventional stains. A time and material saver because one coat beautifies and protects like two coats of ordinary semi-transparent stain.

REZ Color Tones . . . semi-transparent stains for *both exterior and interior wood surfaces*. Perfect for matching inside/outside beams, eaves and ceilings, etc.

For additional information, see Sweet's Catalog 9.9/Re or write to The REZ Company, Box 142, Springdale, Pa. 15144.

**Rez®** Natural Wood Finishes

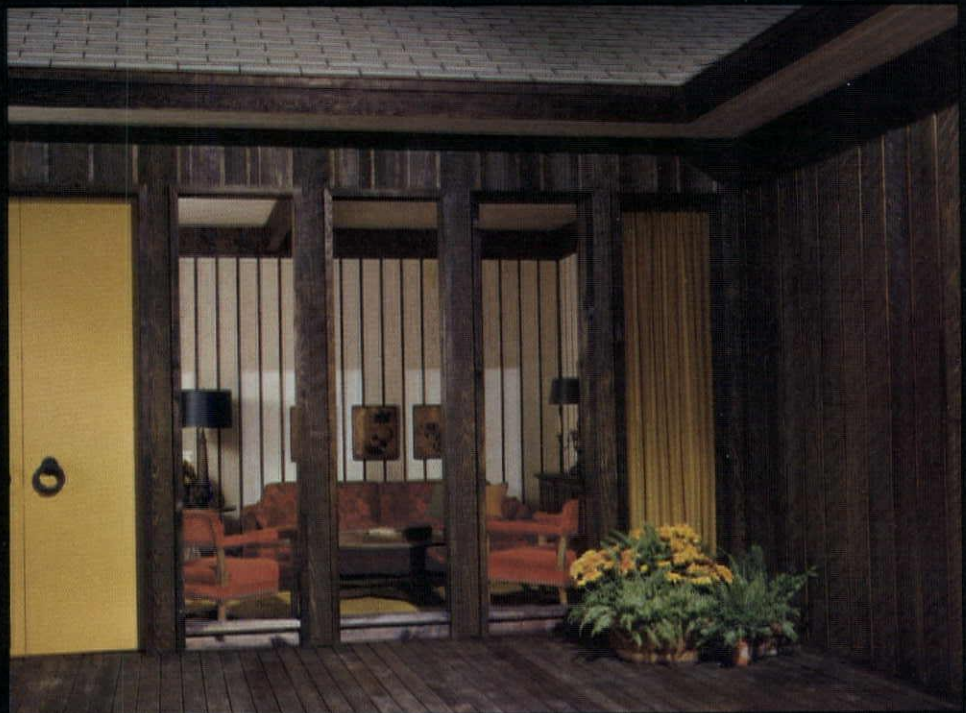



*If it has a patio,  
it needs...*

**WABASH**

# PATIO DOORS

A functional passageway capable of combining beauty with operational efficiency is a must for any new home builder or home remodeler whose plans include a patio or back yard. And a Wabash Wood Patio Door unit provides this combination better than anything else. All Wabash units are made of high-grade Western Pine and are Dri-Vac treated to resist weather, rot, and insect damage.

Wabash ready-to-install Patio Doors are packaged in complete units with detailed, illustrated instructions and factory installed hardware, including—tempered or tempered insulating glass; adjustable tandem-wheel roller units; poly pile weatherstripping; removable colonial or diamond wood grids; neoprene frost barrier; pre-assembled screen section; and attractive door latches. You can even reverse Wabash Wood Patio Door panels either before or after installation.

Whether you build or remodel, a patio is not complete without Wabash Patio Door units. Contact your local Wabash dealer or distributor today.

## WABASH, INC.

1217 FLORIDA ST. • MEMPHIS, TENN. 38106 • PH. 901/946-1671  
Quality Wood Products Since 1884

**FILL OUT AND MAIL THIS COUPON TODAY!**

- Please send me the name and address of my nearest Wabash Dealer or Distributor.
- I would like more information on ready-to-install Wabash all-wood Window Units, Patio Doors, and quality Louvered Products.

YOUR NAME \_\_\_\_\_

COMPANY \_\_\_\_\_

ADDRESS \_\_\_\_\_

CITY \_\_\_\_\_ STATE \_\_\_\_\_ ZIP \_\_\_\_\_

NEWS/PEOPLE

### Economist named for FNMA's board

FABIAN BACHRACH



U.S. TRUST'S O'LEARY  
Into the board room

James J. O'Leary, vice chairman and economist of the U.S. Trust Co. in New York City, has been nominated for the one vacancy opening among the 10 Federal National Mortgage Assn. board positions that are filled by management.

President Nixon was reported meanwhile to have decided on Louis R. Barba, immediate past president of the National Association of Home Builders, and Eugene A. Gullidge, another NAHB ex-president who is now FHA commissioner, as new members of the section named by the government.

Fanny May (for FNMA), as the association is popularly known, is a private corporation with the public purpose of buying and selling home mortgages. Ten board members are now appointed by the company management but five others are still named by President Nixon.

**Departures.** Fanny May's president, Oakley Hunter, announced the nomination of O'Leary to succeed Walter W. Heller, former chairman of the Council of Economic Advisers, who has asked to retire.

Of President Nixon's two nominees, Barba would replace Lloyd E. Clarke, yet another former president of NAHB, and Gullidge would succeed Sherman Unger, who was ousted from his post as the Housing Department's general counsel in a conflict-of-interest dispute (NEWS, Aug. '70) but who remained a director of FNMA.

**Board meeting.** Fanny May's shareholders will meet at the Washington Mayflower May 20. They will vote on the three new nominations and on the renominations of nine members of the management slate

and three members of the government slate.

Incumbents on the management slate, besides Hunter, are Gen. Lucius D. Clay (ret.), chairman of the board and senior managing director of Lehman Brothers Inc., the New York City investment banking house; William B. Ross, executive vice president of FNMA; Philip N. Brownstein, a Washington attorney; Joseph P. Hayden, president of the Midland Co., Cincinnati; John E. Krout, president of the Germantown (Pa.) Savings Bank; John M. O'Mara, partner of W. E. Hutton & Co., New York City stock brokerage; L. Roy Papp, partner of Stein, Roe & Farnham, Chicago; and Robert H. Pease, senior vice president of Draper & Kramer Inc., Chicago mortgage banking house.

The other three members of the government slate, whom President Nixon is expected to renominate, are Charles P. Landt, president of the Cameron-Brown Co., a mortgage banking concern in Raleigh, N.C.; Paul A. Volcker, undersecretary of the treasury; and Julian H. Zimmerman, a former FHA commissioner who is now president of Lumbermen's Investment Corp. of Austin, Tex.

### Factory housing men get new leader

The mobile-home builder Ira H. Gordon has taken over the presidency of the National Assn. of Building Manufacturers with a strong plea for building code reform.

Gordon says the trade association, representing most of the nation's factory housing producers, is now trying to develop uniform codes in all states.

"We can live with 50 different state codes," he says, "but

it's tough to compete with more than 8,000 different codes throughout the states."

Gordon is president of Swift Industries of Pittsburgh, the parent for subsidiaries that manufacture mobiles, modulars, and precut houses, and which develop land. He was elected at the NABM's San Francisco convention to succeed John O. Richardson. Association's headquarters are in Washington.



Flow-Matic by  PRICE PFISTER



**american  
beauty**

## **PRICE PFISTER**

Manufacturers of Plumbing Brass • Pacoima, Calif. 91331  
• Subsidiary of Norris Industries •

CIRCLE 39 ON READER SERVICE CARD



# The Electric Door. It'll supercharge your customers' interest.

The word is convenience. We can help you deliver it.

The Electric Door offers your customers the ultimate convenience in garage door operation. They press a button on a tiny transmitter and the garage door opens. An inside light flashes on. They drive in, touch the button again, the door closes and locks. Fast.

Simple. And very, very safe. The ladies in particular will appreciate that aspect.

The Electric Door concept is based on a brand new automatic garage door opener we created especially for you — the Builder Model 85 Electric Opener. Its low price will surprise you.

And as you know, your local factory-trained Overhead Door distributor will install the opener and warrant it for a full year.

Another reason The Electric Door can help you sell your homes: your customers know us — they know we've been building the finest garage doors in America for 50 years. They trust us. So can you.

Put The Electric Door in your homes. You'll soon see how it can be a "super closer" in more ways than one.

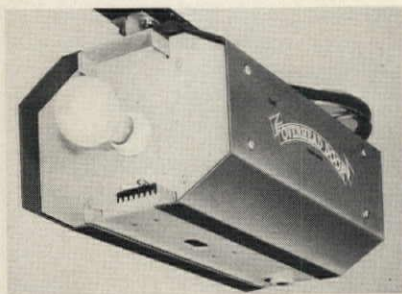

# Set up your own home manu- facturing system on a small investment



*Senco leads you to automated 2-house per day manufacturing system*  
**Cleveland's Production Homes discovers new "middle ground" in automated housing with Senco portable nailers and staplers**

## THIS FREE CASE HISTORY

outlines the growth plan of one of Ohio's most successful and imaginative builder firms, who developed its own economical 2-house-per-day manufacturing system with the help of Senco portable automatic nailers and staplers.

This report could well serve as a guide for small and medium-sized, but progressive, builders throughout the country who want to automate, but who are not ready for heavy investment in sophisticated equipment.

**WRITE FOR YOUR COPY TODAY!** It could be your first big step toward new profit levels, and increased production potential, *without huge expense.*

Senco Products, Inc., Cincinnati, Ohio 45244, Dept. 109



CIRCLE 170 ON READER SERVICE CARD

# Is your answering service bugging you?

Dictaphone has a machine to make sure you never lose another cent through a missed phone call or a garbled message. In fact, we have a whole line of them.

They're called Ansafones. You can buy one outright or possibly lease it for about what you're paying your answering service now. And it works for you 24 hrs. a day, 7 days a week.

For a free brochure describing how much an Ansafone can help you, mail this coupon now.

## ▶ Dictaphone

Box B20, 120 Old Post Road, Rye, New York 10580  
Please send me full details of the Ansafone line.

Name \_\_\_\_\_  
Company \_\_\_\_\_ Phone \_\_\_\_\_  
Address \_\_\_\_\_  
City \_\_\_\_\_ State \_\_\_\_\_ Zip Code \_\_\_\_\_

Ansafone and Dictaphone are registered trademarks of Dictaphone Corp.

## NEWS/PEOPLE



**MORTGAGING'S COSTA**  
*To private practice*



**RYAN'S GREENE**  
*To greener fields?*

## Founder and president both leave big Dallas mortgage banking company

Two widely known leaders in the mortgage banking profession have just left their posts with one of the Southwest's biggest mortgage banking companies.

M. J. (Bill) Greene, 51, has resigned as president of Southern Trust & Mortgage Co. of Dallas.

Aubrey M. Costa has retired from the chairmanship to pursue private interests.

Greene, newly elected president of the Texas Mortgage Bankers Assn., had been with Southern Trust 21 years. Costa had founded the company 47 years ago and was primarily responsible for building its servicing portfolio to its present level of \$525 million. He was president of the MBA of America in 1951-52 and, at 74, he is widely regarded as one of mortgaging's leading elder statesmen.

**Reasons.** Of the two men, Greene, at least, was reportedly at odds with some of the policies imposed upon Southern Trust after Costa sold the company to Bright & Schiff, a Dallas oil and motor freight company, in 1962. Greene signed a five-year contract with the buyers in 1966, but when the pact expired in February, he left. He joins the Ryan Mortgage Co. of Fort Worth as vice chairman and chief executive. (Ryan's servicing exceeds \$450 million.)

Costa had become almost inactive in Southern Trust, but he retained the chairmanship. He never moved into the company's new offices on Stemmons Freeway, operating instead from his private eyrie in the tower of the First National Bank building in downtown Dallas. He controls several corporations operating in Dallas real

estate, and he is vice president of the Dallas Urban League and a member of the city's Tri-Racial Committee. It is the rare visitor, particularly among financial men or journalists, who leaves the city without calling on Costa, for he is often described as a kind of unofficial Mr. Dallas.

**Timing.** Costa said there was no connection between the two departures, although they came on the same date.

"It just looked like the right day for me to retire," he said. "Bill Greene made his own decision."

Greene said merely that Ryan offered "a better opportunity and a better future." —E.W.R.

Harland G. Keller, former president who recently retired as chairman of the executive committee of Bankers Mortgage Co. of California, has teamed again with his former associate, Raymond H. Lapin.

Keller has been elected chairman of R. H. Lapin & Co., organized in San Francisco last September as a mortgage banking concern.

Lapin founded Bankers Mortgage in 1954 and sold it to Transamerica Corp. ten years later (News, Apr. '64) before becoming president of the Federal National Mortgage Assn. in Washington (1967-70). Keller was president of Bankers from 1966 to 1968, when he was succeeded by Kent Colwell (News, May '68).

John R. Jensen, long a senior vice president of Bankers, has resigned as president of Transamerica Mortgage Advisors Inc. to become vice president for property development with Dillingham Corp., the Hawaii land and transport complex.

How does our  
 "know-it-all"  
 help make  
 "instant housing"  
 instant?

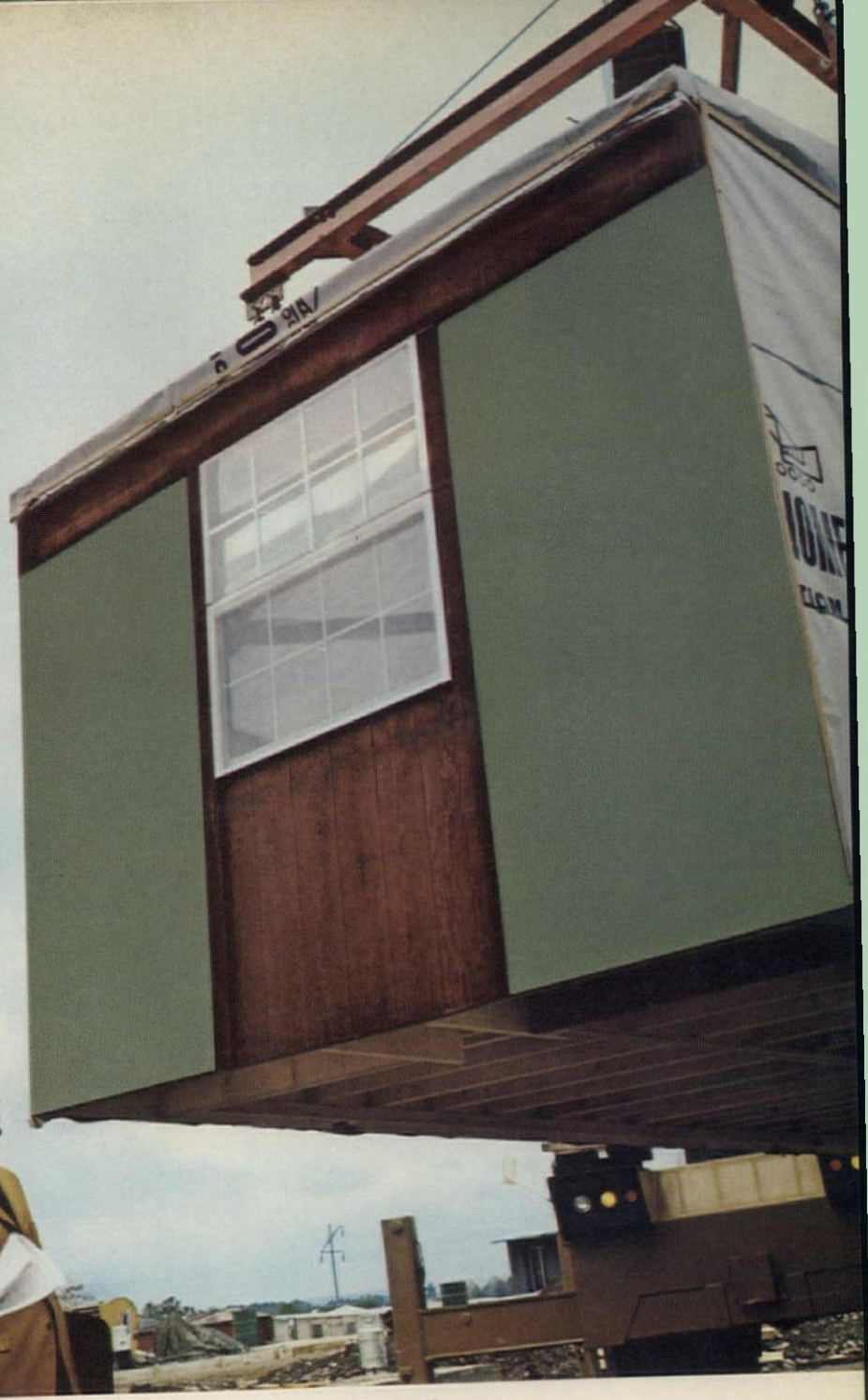

## With our PF-L® Siding.



**U.S. Plywood**

A Division of U.S. Plywood-Champion Papers Inc.  
 777 Third Avenue, New York, N.Y. 10017

When fabricating modular or "instant housing," there's a mighty good man to have around. From factory to building site. Our "know-it-all." Our Builder Service Representative. The Stirling Homex Corporation of Avon, New York, will testify to that. As the nation's leader in modular housing, they wanted the facts about PF-L, our prefinished siding surfaced with Tedlar®. Our man had them.

**Installation?** Fast and easy. Instant prefinished panels. Prefinished battens and corner moldings. Everything for quick installation.

**Durability?** PF-L siding with its factory-applied finish of Tedlar is so tough that it will last for 30 years. And the finish won't flake, crack, chip, peel, craze or blister. Virtually the most durable exterior finish ever developed.

**Maintenance?** Almost none. An occasional hosing washes it clean. Unaffected by chemicals and solvents. The most stubborn staining agents wipe off easily with household solvents. Dent-and-damage resistant, too.

**Cost?** True, PF-L siding with all its advantages is more expensive than some other sidings. But, when long-term maintenance is considered, it's more economical than other siding products. It can be used with brick for versatility of design and still save money. Big savings are possible, too, where PF-L siding is installed directly to studs. As our Builder Service Representative will tell you, PF-L with Tedlar is ideal not only for "instant housing," but also for homes, apartments, schools, commercial buildings. Give our "know-it-all" a call. At your local U.S. Plywood Branch Office.

\*Du Pont's registered trademark for its polyvinyl fluoride film.



Northampton includes single-family, townhouse, apartment, high-rise, commercial and industrial land uses. It is at Exit 33 on the 65-mile circumferential Capital Beltway, 3 miles from the District Line. Washington's other new satellite towns, Columbia and Reston, are about 15 miles away.

**NORTHAMPTON CORPORATION**  
A Wholly-Owned Subsidiary of  
DISC Incorporated



# **NORTHAMPTON** a new town in the shadow of the Nation's Capital

Northampton is closer to Washington than any other new town! Only 3 miles from the District Line. Reston, Va. and Columbia, Md. are about 15 miles away.

That's just for starters. Northampton fronts on the Capital Beltway. It's minutes from any part of the Washington Metropolitan Area. Take Exit 33 and you are there.

Big things are happening. Growth rate in the Washington Metropolitan Area from 1960 to 1970 was the greatest in the nation. 38.4%! That's more than double the rate of the runner up. Prince George's County, where Northampton is located, gained 84%! Far and away the highest in the area. And now the County has

a modern, new, streamlined form of government to meet these challenges, now and for the future.

The 2800 acre new town package planned at Northampton includes everything from a 27 hole golf course to the Prince George's Community College, a 300 acre town core with commercial, office, and hotel-convention facilities, a center for government, and a complete variety of residential uses. Phase I is under way.

A *planned* new town. Close-in. On the Beltway. In the fastest-growing county in the Nation's fastest-growing market. That's Northampton.

**the fastest growing market in the country**  
**Prince George's County, Maryland**

To get the facts, write to: William J. Levitt, Jr., Chairman of the Board  
Northampton Corporation, 1828 L St., N.W., Washington, D. C. 20036. Phone: 202-223-6505



**a timesaving  
guide  
to the 1971  
PCBC exhibits**

**Builders attending the fast-growing PCBC show in San Francisco this June will encounter a colorful array of new products displayed in several areas of the Fairmont Hotel and—for the first time—in the Masonic Temple as well. PRODUCTS PCBC has been created by House & Home and its advertisers to organize your shopping tour of the newly expanded exhibit areas. Copies will be available free at the show.**

**PRODUCTS**

**PCBC**

**FROM HOUSE & HOME**

**see the best, newest, most exciting**

This pocket sized guide to the exhibits is a collection of building products, materials, tools and equipment . . . in each case especially selected by the exhibitors themselves as being the best, the newest, the most exciting they will be offering in 1971. Each product will be handsomely illustrated in full color, described in detail and identified by company and booth number.

**save time and steps**

With a significant expansion of exhibits at this year's PCBC show, booths will be located in the Mason-

ic Temple as well as in several areas of the Fairmont Hotel.

For this reason the order of presentation in PRODUCTS PCBC will be by booth sequence for each separate exhibit area. Thus, all exhibits at the Masonic Temple will be grouped together in PRODUCTS PCBC, enabling you to move quickly and efficiently through the exhibits to pinpoint products of special interest to you.

**can't make the show?**

If you can't make the show this year you can use PRODUCTS PCBC to see for yourself just what the participating exhibitors are displaying as

their best, their newest, their most exciting. Every copy of PRODUCTS PCBC, including those distributed at the show, will have two reader service cards so that you and your associates can request catalog information by mail.

**reserve your copy now**

If you can't make the show, you can reserve a copy now by sending one dollar along with your name and address to PRODUCTS PCBC, House & Home, 330 West 42nd St., New York, New York 10036. Your copy will be mailed immediately on publication in late May.

**Be sure to attend the Pacific Coast Builders Conference in San Francisco: June 2, 3, 4**

THOMAS J. CARLILE is president of Data Core, a consulting company established about six years ago



to assist builders and developers of townhouse and condominium projects.

Data Core's service is all-inclusive—ranging from site selection through planning, financing, financial planning, construction, marketing, and post-sales management. Currently, the company is involved with 28 projects in areas from California to New York and from Montana to Florida.

During a speech he delivered at a recent meeting of the Producer's Council, a national organization of building products manufacturers, Tom Carlile sounded off on...

## "The games FHA plays"

The Federal Housing Administration was created for the purpose of *insuring* housing mortgage risks. It should return to that role.

In 37 years of existence, the FHA has layered rule-upon-rule and regulation-upon-regulation to the point that they are now in the position of being architect, designer, land planner, engineer, administrator, mortgage credit advisor, dictator, and builder.

In short, FHA is in the building business—without *accepting the risk*.

In condominium processing, the FHA has hedged its bet further by requiring the builder to take *all* the risk of building the project and proving the market by requiring a mandatory 80% presale requirement, *before* FHA will assume any risk whatsoever.

Even this protective device does not reduce processing time or prevent the local offices from "massaging" the project.

Our experience with the FHA field offices across the country has varied from excellent to miserable—with the accent on the miserable.

Parenthetically, I must say there *are* many employees and offices who truly try to serve the individual and the home-buying public.

But, it is necessary to call attention to the problem by dwelling on the negative.

We find that in FHA offices which have not previously processed a townhouse or condominium project, an average of 12 months is required to complete processing, despite all of their "accelerated procedures."

We have taken the same product, the same documents, and the same expertise to 19 indi-

vidual FHA field offices throughout the country. These offices use the same processing guidelines and supposedly have parallel qualified staffs. It has been our experience that the processing of virtually identical projects runs from four months in one office to 24 months in another.

Remember, we are talking about single-family home ownership and these same offices can process an entire detached subdivision in 30 days.

The FHA, obviously, is not a truly national organization.

Where is the equity? What is the reason that one method of home ownership can be denied so long while another is treated as routine?

We stay with our clients and process, if necessary, through local FHA offices for 24 months, or longer. But for each builder who succeeds, I can cite you case histories of others who wanted to get into the townhouse and condominium field and who want to today; but who have neither the expertise, the financial capacity, or the ability to endure these unreasonable delays.

They could also have been your customers!

So far, I have said that time delays are costing you and your customer untold dollars—dollars that can mean the difference between red and black ink on your balance sheet.

How, after 37 years of trial and error by the FHA, can these unnecessary delays exist?

I have given certain identifiable names to the following illustrations supplied by our clients.

**Go-along to get-along.** This game is motivated by a *fear of reprisal* on the part of every sponsor-builder-developer.

How does it work? Typically, if you are crass enough to mention how another FHA office in their own organization treats a similar problem, you are tabled. Or, in the more rude offices told: "We don't give a damn how they do it anywhere else, we'll process it our way in this office."

If you are so ill-informed as to suggest that you have some knowledge in any field of production or marketing, many offices go to great lengths to prove that you have *no* knowledge in *their* jurisdiction.

And if you happen to know what the FHA manuals say, you can surely expect that your interpretation is wrong.

To avoid the above pitfalls, builder-developers have learned certain rules: 1) always smile, 2) never approach a problem directly, 3) be completely amazed and recognize profusely the excessive work-load that prevents the office from establishing and meeting time goals for *any* project, 4) overlook all inadequacies, vainly hoping it may somehow work to your advantage.

In other words, stay in your place; accept all abuse humbly; don't complain, and, above all, expect the unexpected gratefully.

**Federal man speaketh with forked tongue.** This game has developed, quite obviously, because in 37 years, the passing of thousands of diverse-minded administrators and the attempt to systematize changing personalities has led to inconsistencies in the FHA manuals. Of course the builder-developer should not point this out in an official way.

However, one of the manual's instructions, designed to be

helpful to those knowledgeable in the housing business, has been completely subverted on all levels of FHA and HUD.

Typically in a project there are three stages of processing. They are the feasibility stage, the conditional commitment stage, and the firm commitment stage. Manual instructions state that a knowledgeable developer shall have the prerogative of submitting his project in sufficient completeness so that he can go from submission to firm commitment without the intermediate processing steps.

But we have examples that FHA and HUD personnel on all levels want to have a hand in the authorship of land plans prior to their submission to city authorities.

Complying with this desire leads to two complications: 1) it makes a complete submission impossible by a builder-developer, 2) it puts the builder-developer between city and federal planners, neither of whom typically will accept the other's recommendations.

We have encountered offices that will not accept architectural plans until all other processing is completed.

It works this way—FHA officials say: "Bring us a complete package and we'll process directly to final commitment, but—we want to see your preliminary plans before you get started, however—don't submit a package until it's approved."



TO PAGE 48



# NEW FROM CARADCO— A PROBLEM-FREE PANEL DOOR RICH IN ELEGANCE

As you can see, our new Molded Panel Door is an eye-fu! Its deep-carved panels and wood-textured surface recall the handcrafted doors of bygone days. And it welcomes paint or pigmented stain.

Elegance aside, can a door look this good and also be practical? And how! In fact, the panels of this factory-primed door won't split, won't check, won't shrink, won't show paint lines. A tough, one-piece door face makes all those problems a thing of the past.

Total cost: less than conventional panel doors.

What more can we say, except that Caradco has a complete line of windows and doors every bit as good. Call or write.

**CARADCO**<sup>®</sup>  
SCOVILL

THE WINDOW AND  
DOOR PEOPLE

DUBUQUE, IOWA 52001

Eastern Assembly Plant  
Hainesport, New Jersey

Ohio Assembly Plant  
Columbus, Ohio



# 5 times lighter than concrete!



## Molded-Stone sinks.®

You'll like them for their ease of handling—ease of installation. Your customers will like them for their great decorator colors and easy-to-keep-clean surface.

Laundry tubs don't have to be dull. And Molded-Stone® tubs prove it. Single and double tub models come in four smart colors. There's a full line of accessories, including a drinking fountain and liquid soap dispenser. Molded-Stone® sinks are so light, they're *one-fifth* the weight of concrete. And the smooth, high-density surface shrugs off rust, stains and corrosion. Molded-Stone® sinks offer you less work and increased profit. Contact your Fiat plumbing products representative today, or write Dept. HH-5

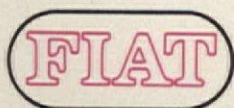

**FORMICA CORPORATION**

© 1971 Cincinnati, Ohio 45202 • subsidiary of

**CYANAMID**



CONTINUED FROM PAGE 46

**Administrative ping-pong.** In this game the developer, known as "the ball," acquires a site, has it professionally planned and engineered, and proceeds to the point of municipal approval of his zoning and land plan. This is called "the serve."

The "return" is from HUD area land planners whose ploy is to recommend countless changes to the approved plan which invalidate the conditions of the city's approval.

"Net ball": Advantage FHA.

Through a succession of similar serves and returns the game can be played until the ball cracks.

Score 0-0.

Engineering fees doubled.

Land plan scrapped.

Banker leaves game early.

Purchase option expired.

Deposited forfeited.

Long-term value status quo maintained by FHA and City Hall.

**The Daisy game.** It works like this: although FHA procedures call for concurrent processing within their offices, many offices are reluctant to give up the pleasant pastime whereby no two people look at a sponsor's plan at the same time.

Each section that must approve the plan shall not know anything about it until the preceding section has taken the plan, sniffed it, felt it, plucked the petals off of it, and written down secret recommendations to be locked in their desk and to be brought out only if it appears that others will approve the plan.

This can stretch 20 days' processing to 20 months to the hilarity and amusement of all but the sponsor.

The description of these games is slightly exaggerated but the steps are real.

What then is the alternative for the builder-developer? Realistically, the developer plays the game, accepts the compromises and, if he's lucky, finds some way to maintain his concept and preserve part of his profit.

In the past FHA attacked these problems and games in a swift, decisive manner. It was called "Project Hard-Nose."

Project Hard-Nose consisted of teams of highly capable men with the agency who had the authority to go to the individual field offices, take over the processing, and break the log-jam. Project Hard-Nose, for some unknown reason, faded silently into the night.

While it existed the builder-developer had quick decisive answers, *not always favorable*, but at least a decision in a short period of time.

Our solution to the FHA dilemma is reinstatement of this type of approach.

We propose that your industry produce for service with the Federal Government 12 of your most competent men to be combined with 6 of FHA's most competent men in 6 three-man teams, each team to be assigned to one of FHA's regions.

These teams would be given the authority and responsibility to work out processing problems in reluctant FHA offices. They would make necessary decisions affecting clogged projects and implement these decisions immediately. This program could be financed by a modest increase in FHA application fees.

We further recommend that these teams be responsible only to the FHA Commissioner with authority to by-pass all other administrative levels.

You represent the strongest financial, political, and productive muscle in the housing industry. Therefore, you are the logical ones to undertake the program that would benefit the entire industry.

We call upon your Executive Committee to involve itself by studying these problems and to seek a meeting as soon as possible with the Secretary of HUD, the FHA Commissioner, and the White House to push for solutions.

In conclusion, a rapidly expanding and healthy housing industry will facilitate a rapid recovery of the economy, a healthy and expanding housing industry will enable us to achieve our national housing goals with existing facilities and tools. Such a goal can be realized only if these problems are solved.

# Simpson



Ruf-Sawn Shadow Groove on Casa Grande Apartments Architect: Maxwell Starkman Developer: Hy Weisel

## Appearance that pays off...and lasts.

Apartment units rent faster, keep tenants longer, when they exhibit the warmth and charm that only redwood can provide. Why settle for the ordinary when Simpson has put redwood exteriors within the reach of every construction budget? Ruf-Sawn redwood plywood gives you every traditional advantage of redwood... plus the economies and ease of application of panel construction.

The range of Simpson patterns and grades offers you a choice to fit any design concept; to get just the effect you want, at a price you can afford.

For more information about Simpson Redwood Plywood, write or call: Simpson Timber Company; 2000 Washington Building; Seattle, Wash. 98101; (206) 682-2828.



# The electric climate is for builders who want a faster return on their investment.

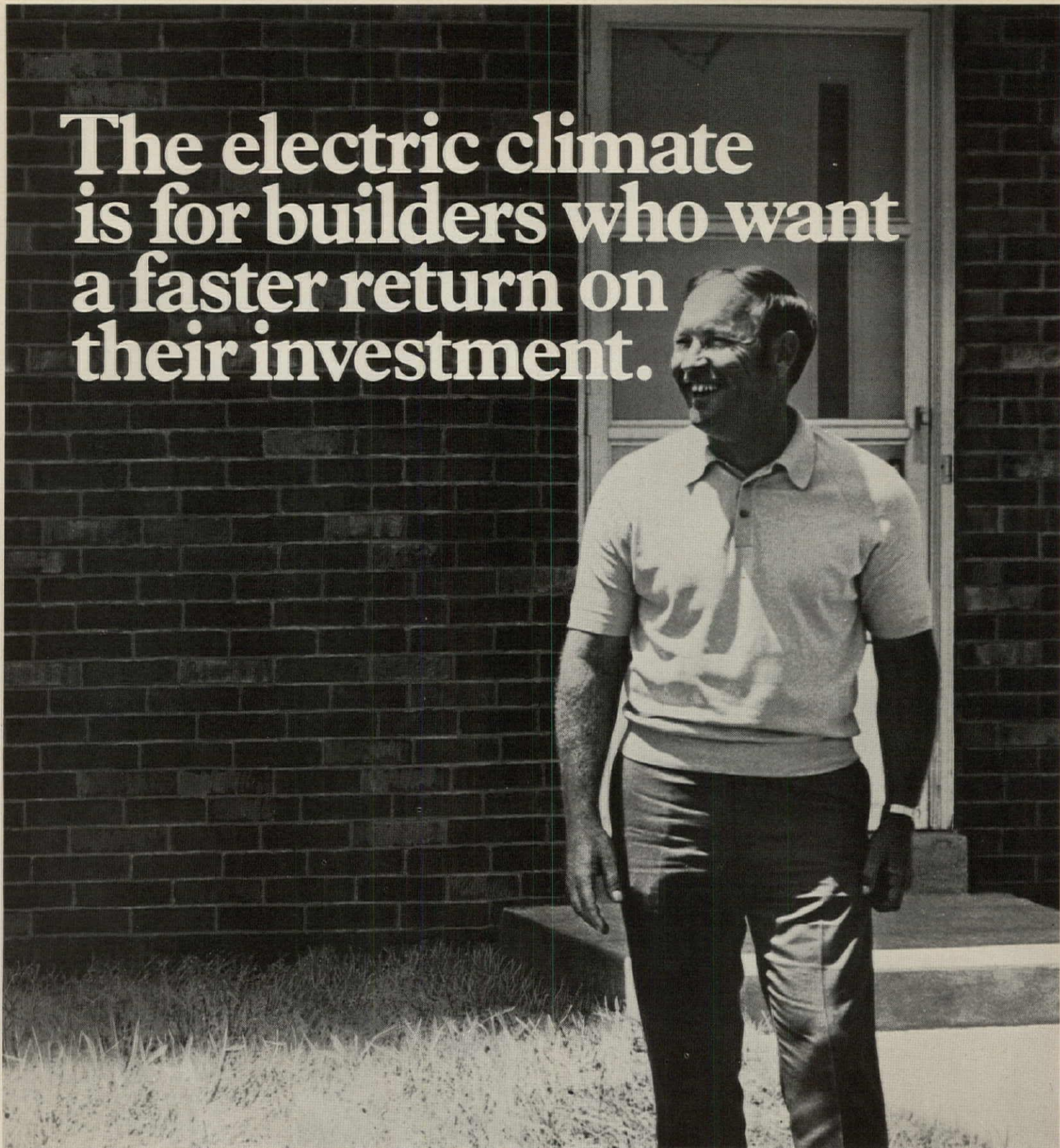

**The electric climate's unique benefits convinced Albert Miller to try it in 16 units—now he's putting it in 50 more!**

Those first 16 total-electric units made Albert Miller of Lexington, Ky., a solid believer in *the electric climate*. Installing everything electric, including the heat, gave him several benefits.

"For one thing," Mr. Miller says, "I discovered that I can build total-electric houses faster because electric equipment is easier and faster to in-

stall. In fact, it speeds up my construction by two weeks to a month in the winter! So I save time *and* labor costs. How do they sell? As fast as I can build them! I've got 50 more units going up now!"

Make this *your* year to discover the exclusive benefits of *the electric climate*. Talk to your electric utility company today.

"Awarded to homes exemplifying electrical excellence."



## Live better electrically

Edison Electric Institute, 750 Third Avenue, New York, N.Y. 10017

“Aren’t you clever, Air King, darling, to design these new all-aluminum hoods so nice and squared. The built-in look’s just what I want for my kitchen. And those groovy interchangeable panels in front let me match my kitchen color. You’re too much!”

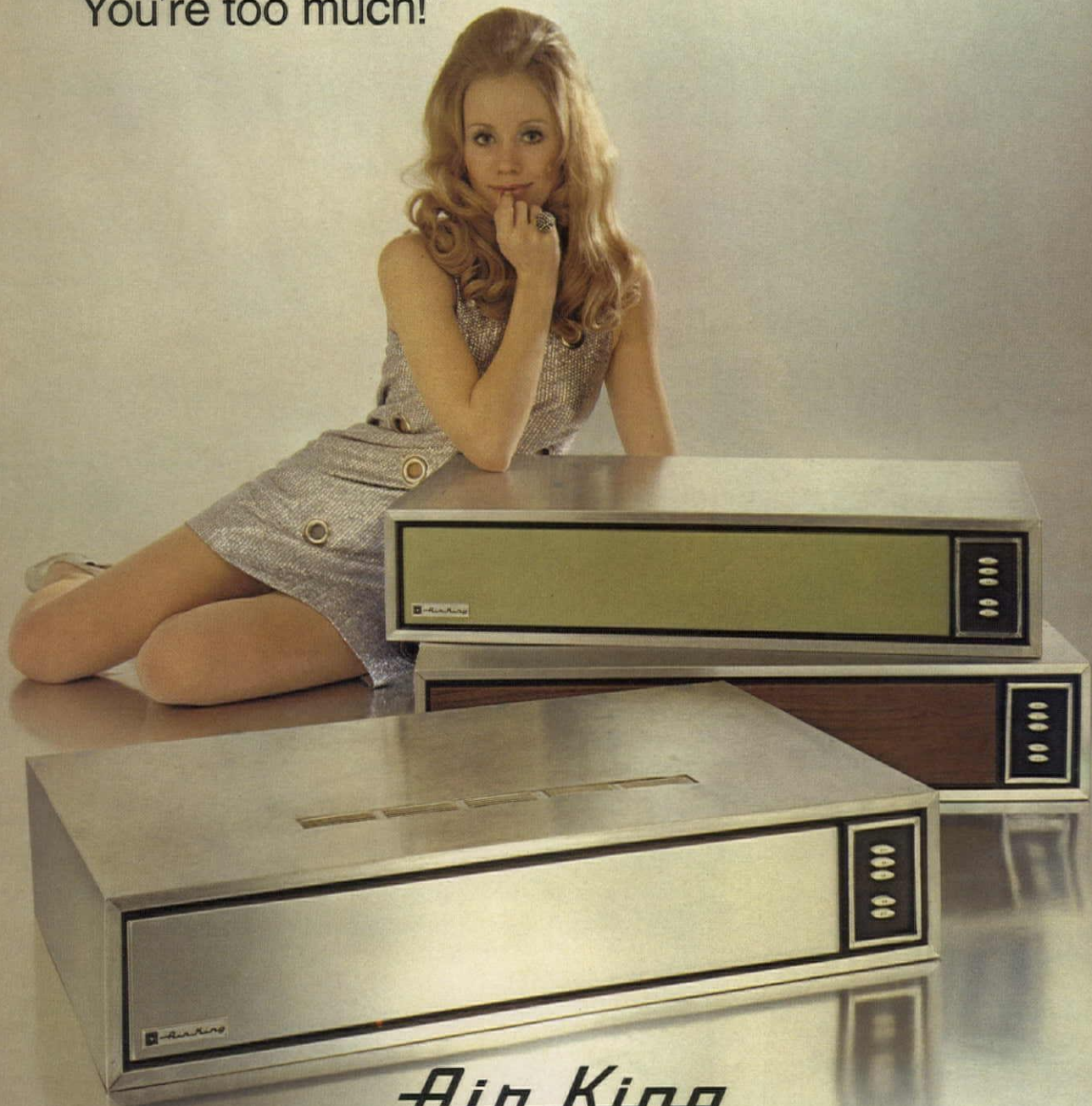

*Air King*

New squared-front hoods available in ductless and ducted models. Write for catalog. Air King Corp., 3057 N. Rockwell, Chicago, Ill. 60618

fashions designed for Alcoa by Oscar de la Renta

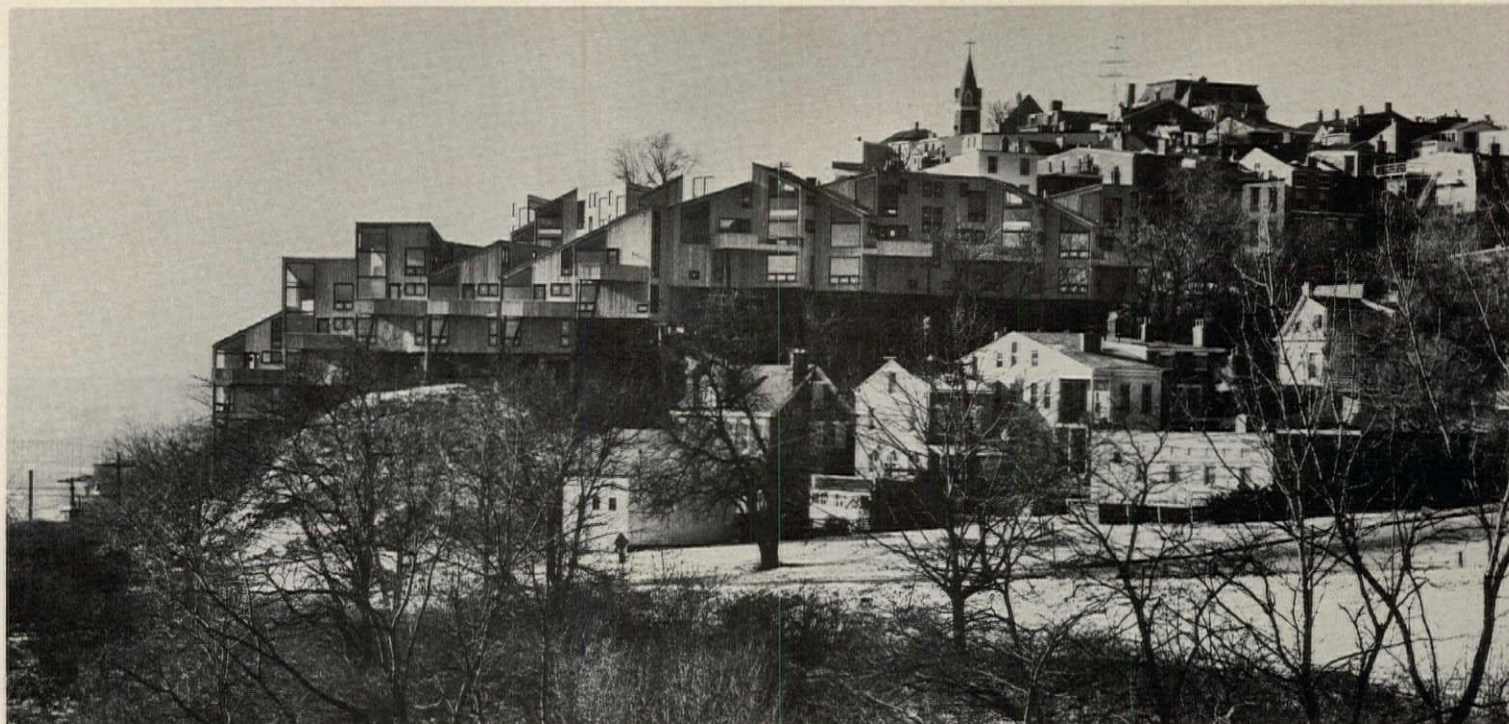

## Does spending time and money on a problem site make sense?

Yes, if it's also a prime site and your marketing plan zeros in on the right target. Case in point: The Cloisters, a 17-unit townhouse condominium built by Towne Properties on Mt. Adams in Cincinnati.

The site was too good to pass up, says Al Robinson, district manager. It commands a panoramic view of the Ohio River, and is in a high-status residential area.

But it also posed a problem:

it's steep, oddly shaped, and confined. So, Towne Properties had to excavate temporary roads across the slope for pier drilling equipment and then regrade when foundation work was done.

The foundation consists of concrete piers sunk into limestone and tied together at the top with concrete grade beams. This rigid frame supports a pole structure built up to floor levels of each unit.

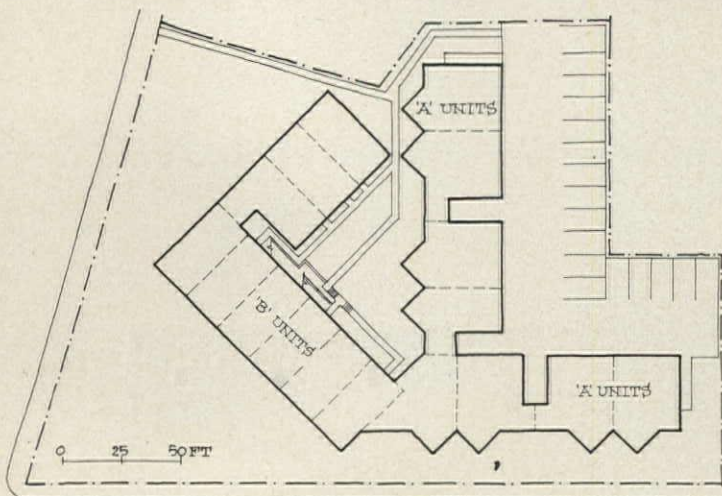

For a look inside, and details on the market, turn to page 58.

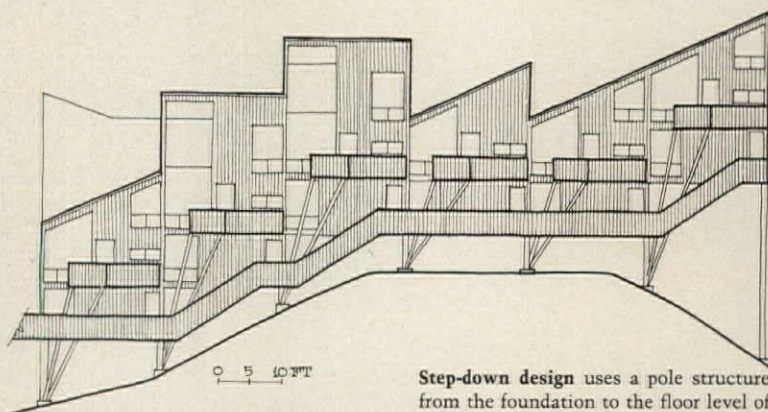

Step-down design uses a pole structure from the foundation to the floor level of each unit.

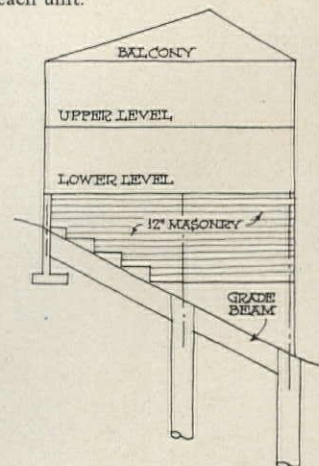
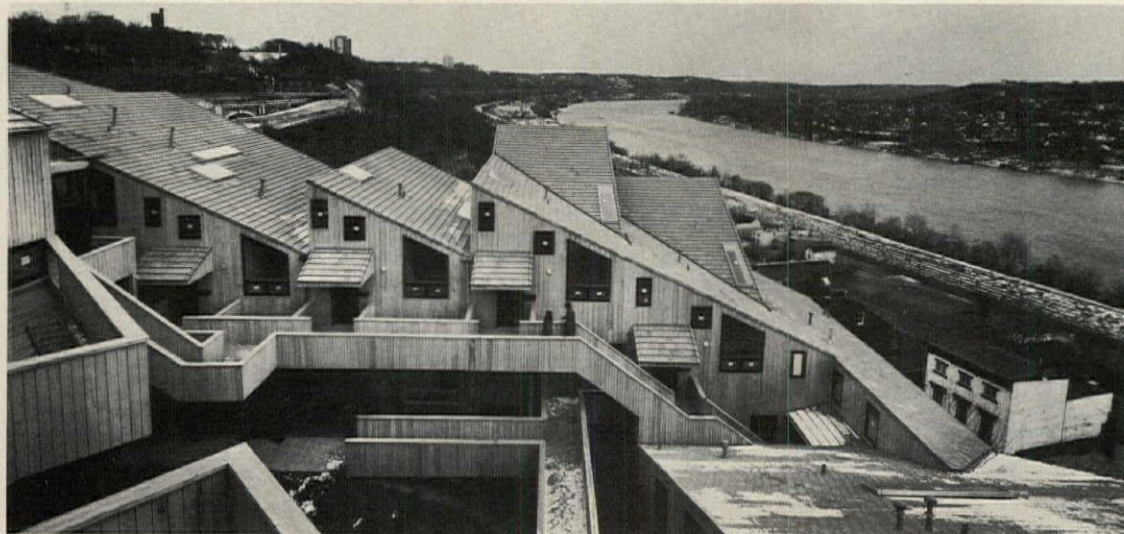

Concrete piers and grade beams form the hillside foundation.



Noted Marina apartment developers, George Ponty, seated, and Max Fenmore, check over plans for their newest deluxe residence complex. One of their completed projects is seen through window behind them.

**Ponty-Fenmore choose Royalweve carpet for their high-style Marina projects.**

**And for very good reasons...**

When being "with it" is the name of the game, resources dwindle down to a precious few. That's why Ponty-Fenmore rely on Mand Carpet Mills and their Kodel fabrics as an important source of carpeting for their Marina apartment projects. Says George Ponty: "We demand ultra high style colorations and textures, because we design our units for young adults who turn on to the bright and beautiful. Royalweve carpeting provides wild colors and textures *plus* the performance any apartment builder knows must be built into his floor covering products."

*Contract Division*



Mand Carpet Mills — The Colorful Carpet Company  
2310 E. 52nd Street, Los Angeles, Calif. 90058  
3740 West 74th Street, Chicago, Illinois 60629

Interiors by  
Robert Englander, V.P.,  
C. Tony Pereira Designers.  
Carpet installation by  
Metzler, Inc., Los Angeles.



PHOTOS: NORMAN MCGRATH

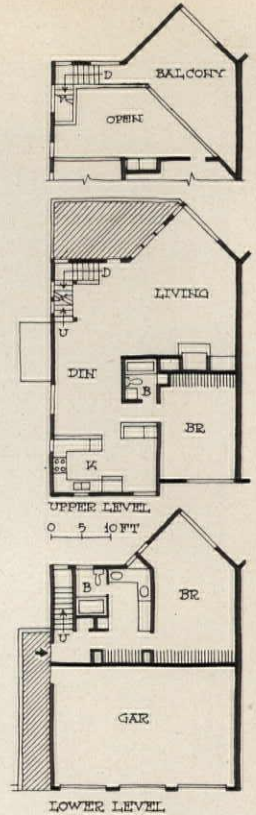
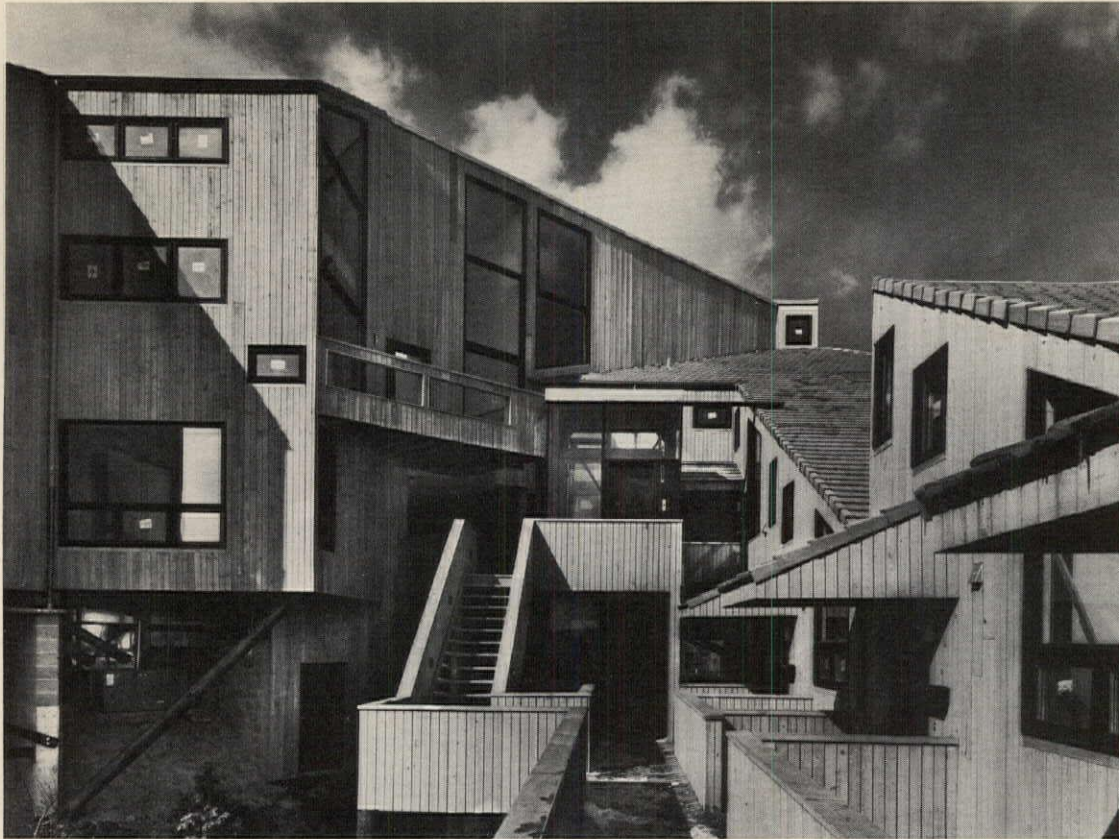

*Problem site . . . continued from page 52*

Families accustomed to spacious surroundings—the high-income and semi-retirement market—were targets for the \$62,000-\$85,000 units shown here and on page 52.

Five are sold. (Cincinnati Reds' catcher Johnny Bench is one buyer.) Two more are on contract, hinging on buyers selling present homes. And now that money has eased, Towne Properties expects to sell the balance by August.

The design evolved from two basically different site characteristics requiring two basic plans—A units for the flat area and B units stepping down the hillside.

In B units (not shown) bedrooms are on the lower level; living and entertaining areas are open above.

*Architects:* Hardy Holzman Pfeiffer Associates; *Structural Engineer:* Miller-Tallarico-McNinch & Hoeffel.

Inclined elevator (glass-enclosed structure in center of photo) connects B units to parking area at top level.

A-unit plan has garage on lower level. To provide variety, alternate A-unit plans are reversed throughout.



Angled balcony windows serve a dual purpose: they take maximum advantage of the view and offer design relief to the basic rectangular plan.



Two-level living space in A unit is shown from open area (left) at foot of balcony stairs and more-formal area (right) beneath balcony.



- A—Korad on siding
- B—Korad on shutters
- C—Korad on doors
- D—Korad on roof ventilator
- E—Korad on soffits
- F—Korad on gutters and downspouts
- G—Korad on trim

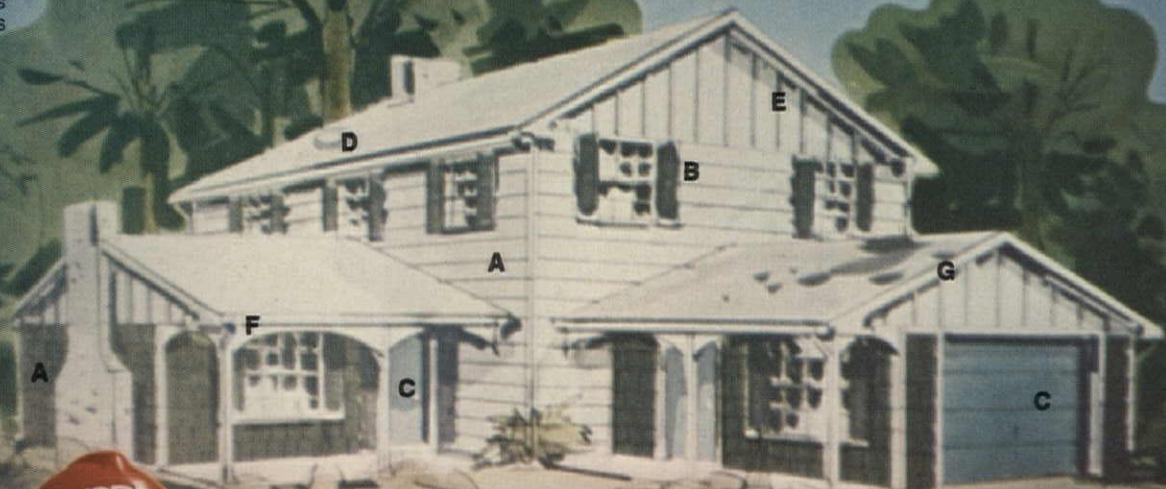

All around your house

# Korad<sup>®</sup> ends painting- and repainting and repainting

Building products prefinished with Korad acrylic film eliminate the cost and scheduling problems of job-site painting ... and Korad saves the homeowner the time and money of repainting and repainting and repainting.

Korad is a solid, 100% acrylic plastic film that is factory bonded to wood, metal and plastic building products. Korad film is thick—3 times thicker than most paints for superior mar and scratch protection.

Being an acrylic plastic, Korad film has outstanding resistance to chalking, fading, cracking and chipping. Korad is factory-bonded to almost any surface, becoming integral with the material.

Korad acrylic film is available on all kinds of building products to eliminate field painting of exterior surfaces.

Call our special number (215) 592-6719, or write us to get the names of material suppliers and samples of Korad colors.



Korad is your first line of defense

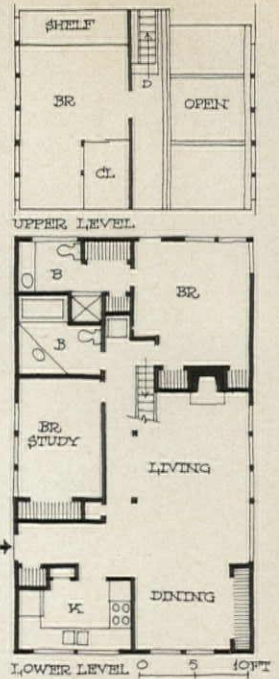

Double-wide modular plan includes two bedrooms and two baths on the first floor and third bedroom above. Total living area is 1,100 sq. ft. House rests on steel I-beams on concrete piers and has electric heat.

### What can happen when you marry an A-frame with a double-wide modular?

You get a house with an extra bedroom, a cathedral ceiling, large gable windows, and a roof line that avoids the box-like look. But you also face a problem when hauling the house down a highway.

The manufacturer of this A-

frame, mobile modular has solved the problem by hinging the top third of the A-frame so it folds down during transit.

Since opening its factory last May, Landmark Industries of Atlanta reports selling 250 A-frame modulars—both single-

wide and double-wide units. Buyers are mobile-home dealers and vacation-home developers in Florida and other southeastern states.

Carpeted and furnished, the double-wide unit shown here sells for \$12,094 without land.



Living room has prefab fireplace faced with 1/2" polystyrene brick. All furniture and appliances are included in basic price. Stairs lead to bedroom balcony.



Gable window wall is butt-hinged at upper plate (double 2 x 4s) and folds down in transit to site. Deck off living room was added at owner's expense.

# We're going to straighten out your thinking about doors.

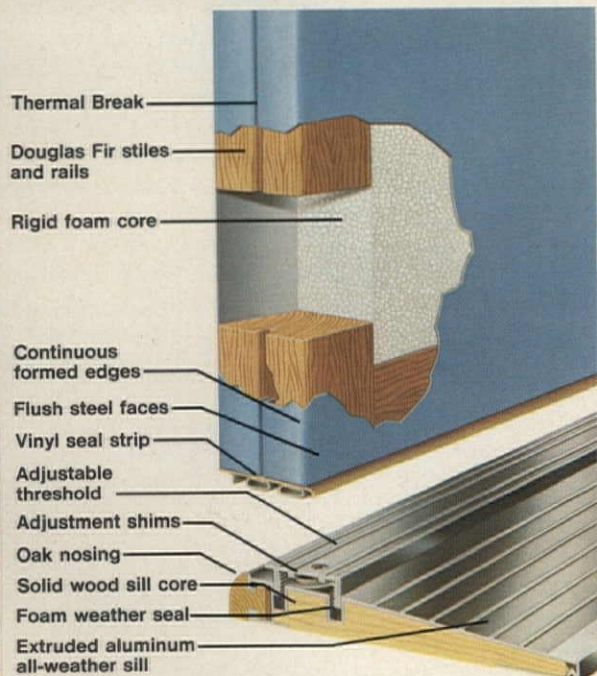

Every Ever-Straight door comes complete with adjustable sill-threshold, magnetic weatherstripping and patented "thermal break". Nothing gets in from the outside unless it's invited.

Go ahead. Put wood doors on your homes and you might save a few bucks. But be ready when those doors start warping, sticking, twisting, shrinking, swelling or leaking.

Because you're going to get callbacks. In fact, our builder customers tell us doors used to be their number one callback problem, until they switched to the Ever-Straight door by Pease.

Warping is really no excuse for a callback on an Ever-Straight door, because it just won't warp. Ever. It's made with strong, zinc-coated steel panels and insulated with a solid core of polystyrene foam.

Actually, an Ever-Straight door is a complete entrance system, pre-hung in its own frame. It stays straight and true and weathertight, with its adjustable sill-threshold and magnetic weatherstripping. (Not to mention the patented "thermal break"—you know it's an Ever-Straight when you see the slot in the door edge.)

So install Ever-Straight doors all around, in every home you build. And suddenly, your door problems will be all straightened out. Write us for further information and the name of your nearest distributor.

Make a grand entrance

**Pease**  
**Ever Strait Doors**<sup>®</sup>  
Pease Company | 900 Forest Avenue • Hamilton, Ohio 45012

U.S. Patents No. 3,153,817; 3,273,287; 3,238,573; 3,426,479. Patented in Canada 1965, 1966; and in United Kingdom 1962. Other patents pending. © Pease Company 1971

CIRCLE 61 ON READER SERVICE CARD

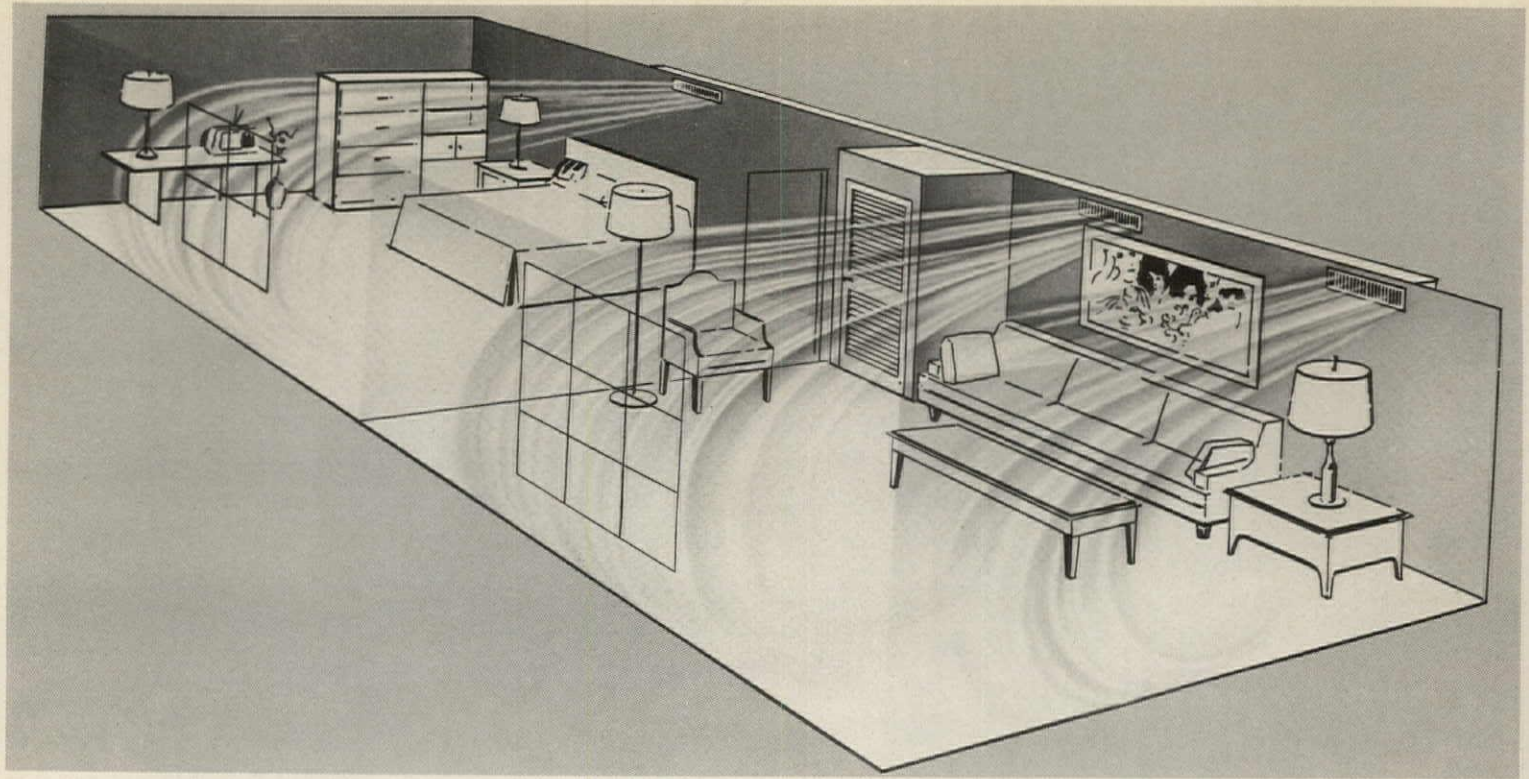

**For tomorrow's apartments:  
a constant-circulation system  
for central heating and cooling**

This new approach to indoor climate control is designed to hold temperatures to within 2° of the thermostat setting, according to the manufacturer, Carrier Corp.

Reason: the fan-coil operates continuously, so there is no on-off cycle.

The system works via a duct mounted behind an inside wall. A steady stream of warm or chilled air flows from dampers, across the ceiling and down the window wall, gradually mixing with the room air.

Carrier says its Volumaster system has these additional advantages over other central and split systems:

1. *Reduces drafts.* Because the air stream clings to the ceiling longer, it tempers the room air gradually. There are no sudden drafts.

2. *Low noise level.* Though the fan motor runs constantly, it runs at slow speeds and is hardly audible.

3. *Controls humidity.* Window condensation is reduced in winter, and moisture is removed from the air in summer.

Volumaster is recommended for buildings of 100 units and over. As yet Carrier has no figures on installation costs—but claims that operating and maintenance costs are lower.

CIRCLE 275 ON READER SERVICE CARD

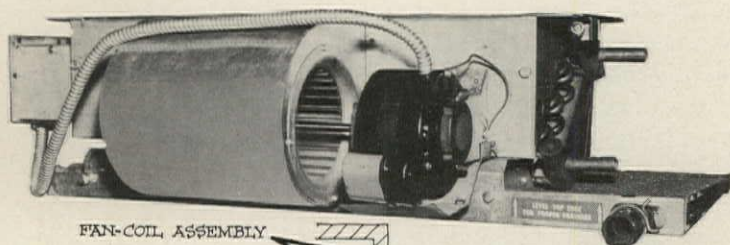

FAN-COIL ASSEMBLY

Components of the system consist of a standard double-wide fan-coil, solid state control module, wall thermostat, automatic changeover element, and counterbalanced damper to regulate the air volume. System requires separate boiler and chiller with standard two-pipe or four-pipe distribution. A condensate drain can be connected to the bath or sink drain line.

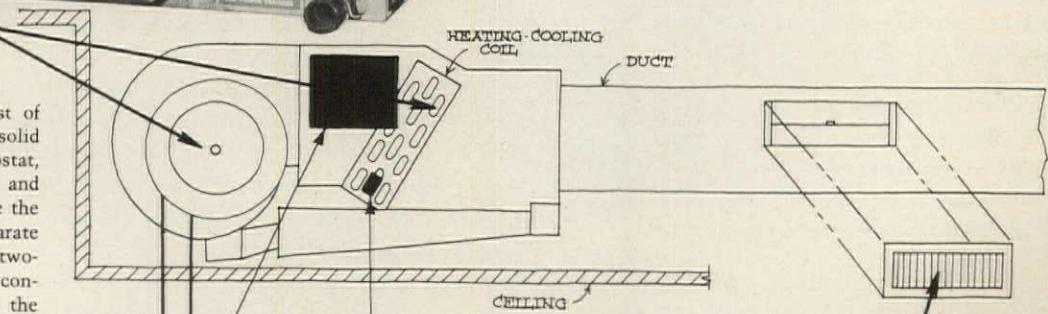

SOLID STATE CONTROL

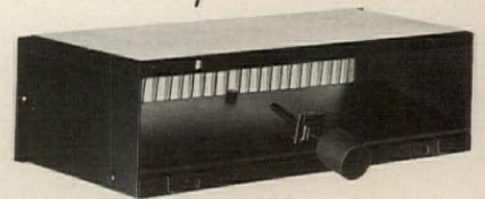
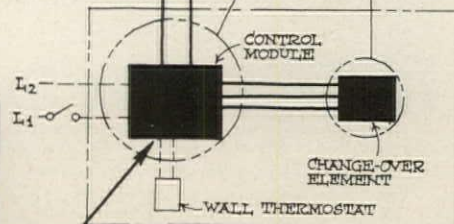

DAMPER ASSEMBLY (REAR VIEW)

# We've got something for everyone. From utter luxury to basic economy.



For your most demanding customers we have the Luxor® toilet... for the total look of luxury. Shown here in Bone, this truly low silhouette toilet is of one-piece design with a beautifully contoured seat and cover. Behind that smart looking flushing actuator is the built-in convenience of a Vent-Away® toilet ventilator. (Vent-Away ends unpleasant odors to make bathrooms company fresh... always.)

Our famous Elongated Cadet,™ here in Venetian



Pink, is one of America's best selling toilets. It's modestly priced for the new home market as well as modernization. The elongated style is much

© American-Standard 1971

wanted by today's homemakers for its easier cleaning and better bathroom sanitation.

Modern one-piece styling with elongated bowl are the highlights of the Carlyle,™ shown with the Margate™ Bidet in matching Manchu Yellow. Carlyle also includes special contoured



seat and cover.

The compact design of this Fawn Beige toilet led to its name, the Compact®. It comes complete with Vent-Away toilet ventilator and the preferred elongated bowl. Glenwall® is the first off-the-floor toilet at a truly low price.



A proven seller for new homes. Available with round or elongated bowl. Vent-Away is optional. Color featured is Regency Blue. Toilets are also available in a smart green called Bayberry and classic White.

For more details call your American-Standard distributor. Or write to American-Standard, P.O. Box 2003, New Brunswick, N.J. 08903

**AMERICAN  
STANDARD**  
PLUMBING / HEATING



**"Can't find the right man  
to maintain your apartments?  
Give the job to the man  
who builds them"**

Perhaps the above suggestion sounds a bit Machiavellian, but that's exactly how we do it at our place. The men who oversee the design and construction of our new apartments are the same men who have to keep up those apartments when they're no longer new.

Why saddle our construction men with such an unpopular chore? First, because if they know they'll have to cope with maintenance, they'll start anticipating problems—and taking remedial steps—at the design and construction stage. Second, because we want the job done right at a price we can bear.

Maintenance may be the most unpopular job in the apartment business, but it's also a vital one. Tenants are increasingly sensitive about it, to the extent that they are demanding the legal right to order maintenance work themselves and bill you for it.

In California, for example, the civil code now allows tenants to make their own repairs and use rent money to pay for them. Specifically, if a landlord fails to make a requested repair in 30 days, the tenant may order the repair made through means of his own and use up to one month's rent to pay the bill. As an alternative, the new law permits the tenant to vacate immediately regardless of any lease commitment he may have signed.

With legislation like this hanging over his head, a landlord can't afford to slough off upkeep.

**Growing pains.** We started out ten years ago with the small apartment developer's typical approach to maintenance. We turned it over to our resident managers. If a repair was absolutely beyond the managers' capabilities, we let them call in a professional. Otherwise, they handled it.

As our apartment network approached 500 units, we decided the managers' time was better spent renting apartments and handling tenants. So we started developing a separate maintenance crew.

To avoid overlap and keep purchasing under control, we made this general distinction: resident managers handle normal household cleaning, maintenance men handle everything else. In other words, the managers' upkeep function is limited to keeping things tidy. They are authorized to purchase cleaning supplies, and order out carpet shampooing, drapery cleaning, and general apartment cleaning. But when anything needs replacing or repair, the

decision and purchase are handled by the maintenance department.

Resident managers have a vested interest in replacing carpet and anything else that helps show their apartments to best advantage. So we decided to let impartial maintenance men make all the replacement decisions.

By the time we reached 1,000 apartments, we had a full-fledged maintenance staff equipped with a fleet of vans and organized according to specialty, i.e., pool cleaning, painting, and gardening, as opposed to general maintenance.

**Lost and found.** This system worked well until it began creating inventory problems. When our property management division reached the 2,000-apartment level, we either had to start an inventory department to watch the tools and parts in our vans, or eliminate the vans.

So at 2,000 units we got rid of our rolling stock. Now our maintenance men commute to their jobs in their own cars, provide most of their own tools, and store their parts and supplies in the apartment projects. Each building-maintenance man, assigned permanently to about 500 apartments, has a small workshop and storeroom in every project he oversees.

We generally buy parts and supplies not more than three months in advance of need. This means we lose some of the savings offered by large-volume purchasing. But we make up for it with what we save in pilferage and accounting personnel. We don't want to get involved in the mechanics of maintaining big parts inventories, and we don't like the idea of tying up any more working capital than necessary.

**Separate responsibilities.** As we approached 3,000 apartments, we decided to make a further refinement in the maintenance setup. We took it out of the hands of the property management division and gave it to the construction department.

For years the property manager and his maintenance men had hassled with construction to make the new projects easier and cheaper to keep up. Now there's no hassle. Property management concentrates on management, and construction worries about maintenance.

We had always made a valiant effort to avoid designing maintenance problems into our complexes. We encouraged feedback from maintenance to construction, and we made property management a member of the plans-review committee. Generally

speaking, critiques from maintenance men as well as tenants about the performance and livability of our established apartments found their way into new designs and construction methods.

But coordinating maintenance and construction under one executive has streamlined the feedback channel dramatically. The maintenance manager who sets work schedules and enforces performance standards for apartment upkeep reports directly to the design and construction vice-president. Now there is no inter-departmental note-passing on product and design performance.

In effect, each new complex is a proving ground for products and materials. And with construction analyzing the results, problems are solved much faster.

For example, consider the dilemma of lighting public corridors. Incandescent ceiling fixtures are no good because they trap heat and accelerate bulb replacement. Wall-mounted fixtures let heat escape, but they have other problems, i.e., bulbs can be stolen too easily and furniture movers damage them. Construction came up with a structural solution to the dilemma: built-in ceiling troffers with low-wattage fluorescent tubes.

Our maintenance-oriented construction department tends to tailor new apartments to our maintenance capabilities. When property management was overseeing maintenance, we had to tailor our maintenance set-up to suit the new projects after they were designed and built.

**Tandem advice.** While good design and construction can save maintenance dollars, you also need established standards for upkeep work itself.

Take a routine job like cleaning an apartment. How good a job should you do? You can't leave it up to the resident managers' judgement. Managers are too generous about refurbishing vacated apartments. If you let them, they'll shampoo carpets and repaint completely whether necessary or not. After all, an apartment shows best when it's freshly painted and shampooed. The fact that it may cost a month's rent is the accounting department's worry.

To be consistent about the quality of your upkeep and how much you should be spending on it, don't leave it up to anyone's judgment. Spell it out on paper.

But in the last analysis, maintenance problems—or lack of them—begin and end during design and construction.

H. CLARKE WELLS, MARKETING VICE PRESIDENT, L. B. NELSON CORP., PALO ALTO, CALIF.



# Our Superoo shag carpet. Its whole story is a big fat yarn.



We've got a new shaggy carpet story for you.

It concerns the richest, plushest, most luxurious shag carpet we've ever put on the market. In fact, it's so rich and plush and luxurious that you might gain weight just looking at it.

The new carpet is Superoo. The yarn we use to make it is 100% plied Kodel polyester. Kodel is fatter than any other polyester. So that makes our Superoo fatter and thicker, too. And our unique

oven-set process makes Superoo's texture stay thicker and plusher.

But thickness and plushness are only part of the story. Superoo is offered in 15 solids and 9 coordinating tri-colors. From muted tones like Tahitian Teak and Gold Affection to vibrant color blasts like Cherry and Lemon Twist.

Take a look at the new Superoo. It's a story you can really sink your feet into.



**WALTER CARPET MILLS**

A Component of Ludlow Corporation  
P.O. Box 1252, City of Industry, California 91747

"The right carpets for the right people."



**"The real role of industrialized housing is to make up for the growing shortage of skilled labor"**

Industrialized housing in general and Operation Breakthrough in particular have been the targets of much criticism by the homebuilding industry. The reasoning: new technology will not really help reduce the high cost of housing since land and money are the real culprits. One can hardly quarrel with this statement, but, then, I haven't heard any universal claims of major short-term cost reductions attributed to industrialized housing.

Industrialized housing is really needed to help satisfy huge long-range housing requirements and also to gain some stabilization of costs in an area where tangible progress can be realized. A review of recent housing history shows why.

If, by some unknown magic, land and financing cost problems were quickly resolved, production would then be the industry's prime problem. Yet, in the past ten years, as starts have inched over the 1.5 million level, labor shortages have promptly developed. So, the continuing reference to the production rate of 2 million reached in 1950 merely magnifies this weakness in the industry.

We all know that the majority of those 1950 starts were simple, duplicated, rectangular ranch homes, much easier to produce than today's average unit. During the past 20 years many changes have taken place, not only in the product but also in the manner of construction.

The use of sub-assembled component parts has been the major innovation, plus the use of more factory finished materials. In addition, housing design has generally become more complicated with a definite trend to two-story stylized units in larger multifamily projects.

In this same period, we also saw the general attrition of skilled labor within the residential construction industry—through retirement, a lack of adequate training programs, and because of low and inconsistent levels of activity. Every year of very low starts, such as 1966, saw a loss of some of homebuilding's best labor supply to industries offering more security and year-round employment.

Most builders depend to a large degree on the easy availability of an ample supply of competitive subcontractors. In major metropolitan areas these crews have generally remained available although not always as competitive as desired.

It is obvious to most, however, that this situation is gradually getting worse even in

the most prolific markets. In satellite towns of metropolitan areas where housing has retreated due to lack of land and high land costs, labor problems are multiplied. In smaller communities not near any metropolitan area, construction labor conditions are impossible. There is just no local skilled labor supply for a project of any reasonable size. And as the labor supply lessened, not only have costs increased, but efficiency has decreased.

Certain studies attempt to show that the percentage of total housing costs attributable to labor is lower today than 20 years ago. However, with increasing usage of panels, roof trusses, assembled windows and stairs, pre-hung doors, factory finished components, and generally larger pieces and parts, site labor is in reality much less efficient than 20 years ago.

The site labor factor has gradually shifted into the supplier's factory where mass production methods use less-skilled labor more productively and supply a higher quality product in the process.

**Wages and productivity.** Skyrocketing site-pay rates, combined with lower efficiency, have encouraged increased factory production—not only in components but also in total housing units, thus creating the inevitable modular housing industry.

We should not expect any dramatic initial cost advantages from modular construction. Unfortunately, we still generally must use conventional materials and methods. And, while savings are realized by volume purchasing and more efficient use of labor, they are somewhat balanced by higher overhead and transportation costs. In the future, design, materials, and methods-innovation will be adapted to factory mass-production systems, and it will become increasingly more difficult for conventional site-built housing to be competitive. Today, however, it is hardly necessary for the modular unit to sell at a lower price.

**Instant need: efficient production.** In today's market, the important factors are cost control and speed of construction which remove many of conventional building's uncertainties and provide savings in financing costs and general overhead. The builder who claims no interest in modular systems because he sees no short-range advantages is evincing a natural reaction to a new concept which threatens a traditional process.

Reaction to Operation Breakthrough was also natural enough . . . "Who the

hell are these non-builders, claiming they will quickly solve all the problems of cost and production with some silly contest?" Excessive publicity and expectations for Breakthrough brought on similar excesses in negative reaction. Most builders are sufficiently experienced to realize the obvious faults, but not big enough to admit the inevitability of the concept.

The success of Operation Breakthrough and the eventual validity of the various systems chosen for prototypes are not really important, nor should they be expected. What is important is the accelerated impetus to modular concepts generally. In this sense, Breakthrough has served a very useful purpose. In reality this was the original intention.

It is true we are a new industry in its infancy and any real meaningful productive capacity which will constitute a major share of housing starts is still years away. Therefore, while modular housing is having and will continue to have a major impact on housing publicity, and also on the thinking of major housing producers, it will not have a major volume-impact on our short-term housing needs.

**The future: a combined approach.** It is also clear that most of the current major homebuilding companies have a substantial and growing interest in the modular housing industry. Many are already designing modular units and planning manufacturing plants. Others are even further committed to a definite move into the factory as an integral part of their operations.

Consequently, builders are becoming manufacturers and in reverse order, manufacturers are becoming builders—both as a matter of necessity. Actually, both are still primarily builders and the total organization must be proficient in land acquisition and planning, zoning, design, marketing, and all the other ingredients necessary to a successful operation. But most meaningful, the best part of the product will be manufactured in a factory.

It is inevitable that in another decade most major housing producers will operate this way—either with their own plants or in agreement with major housing manufacturers. An idealistic dream, maybe . . . but those companies such as Modular Housing Systems currently moving ahead, going through the very important learning experiences, will have the edge in future years, and that dream becomes more practical every day.

JOSEPH C. GRASSO, EXECUTIVE VICE PRESIDENT, MODULAR HOUSING SYSTEMS INC., NORTHUMBERLAND, PA.



New from Oxford Tile ...

# Morocco®

ceramic wall tile

No. 203  
Palm Green

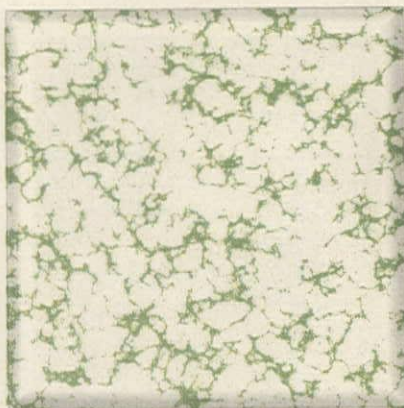

No. 207  
Dune Tan

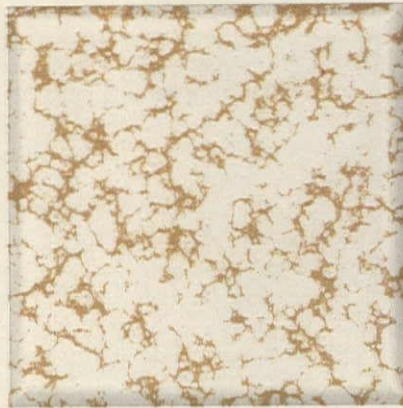

No. 205 Citron Yellow



No. 204 Medina Blue

Morocco is an exquisitely beautiful tile comparing favorably with the finest handcraft ceramics of Safi. It has a marble-like pattern combined with delicate color and soft lustre. The effect is one of unusual charm and is especially recommended for whole wall installations such as in bathrooms and powder rooms. Morocco is also appealing in the kitchen or playroom

as well as in half-walls, room dividers, counter tops and other practical modern-day decoration.

The tiles are precision-edged and self-spacing. With the new adhesives and simplified method of application, installations are easy and foolproof.

Bathroom accessories available in harmonizing colors.

**OXFORD TILE COMPANY,**  
CAMBRIDGE, OHIO





**"Contour clustering is a better way to create open space, and it can cut costs too"**

The advantages of cluster design have been well publicized. As the schematic drawing (Fig. 1) at right shows, clustering increases open space enormously, and also makes possible many construction economies.

Linear clustering is a corollary of ordinary cluster design. In a linear cluster, (Fig. 2) buildings are run along contours—in effect, molding construction into the site. And the result can be a more attractive and more economical design than the ordinary cluster.

Logical building areas are chosen on the basis of slope, soils, vegetation, and water table. Construction parallels the site contours, minimizing cut-and-fill as well as destructive over-spills of fill. By running units as continuous buildings, side yards and end-wall construction are reduced. (Each side yard opening costs approximately \$30 per lin. ft.) In order to provide views of open space rather than other buildings, all units are through, typically with two stories on the parking side and three on the open space side. Back-to-back units are less desirable and reduce rent rolls.

**Preserving trees.** The diagram (Fig. 3) shows a logical division of the site into areas of totally cleared, selectively cleared, and untouched woodland.

No trees are left in totally cleared areas because skinning damage might occur to any trees left standing. Also, regrading is almost always necessary in the cleared area, and raising the grade over a tree's roots can kill the tree. (A small tree well is nothing but a slow death for the tree. Air movement and water percolation are critical to the root system.)

Snow fence is used around areas to be left untouched, and topsoil and leaf mulch are stockpiled for later redistribution.

**Drainage.** An efficient system is achieved by using natural surface drainage, percolation, and natural swales, rather than costly curbing, piping, and culverts. Bollards, rather than curbs, define parking areas, permitting the flow of water into surface drainage swales. Parking and roads are constructed without curbs and are graded to direct drainage into swales and catch basins if necessary. Water percolates into the ground. This helps to avoid flooding, loss of trees, and lowering of the water table.

**A profitable method.** Dollars are saved by reduced construction, restricted clearing, and natural drainage. Restricted clear-

SINGLE FAMILY

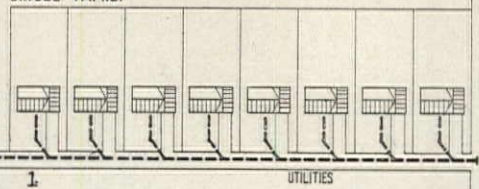

TOWN HOUSES

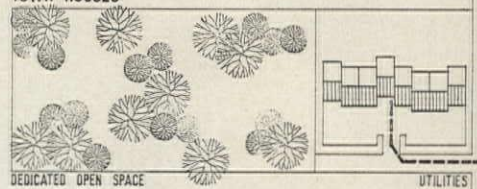

Conventional plan vs. standard cluster

ing typically saves \$250-\$750 per acre in clearing costs and cuts landscaping costs by \$300-500 per unit. Seeding of flatter, cleared areas costs 2¢-5¢ per sq. ft. More sophisticated cover for steeper areas costs 10¢-25¢ per sq. ft. and also requires much more maintenance than existing natural vegetation.

Cover	Additional cost/sq. ft.	Runoff factor	Maintenance cost/acre
Natural Seed/	—	20%	—
Lawn	.02-.05	60%	\$2500
Vines, etc.	.10-.25	40%	\$5000 1st two years \$ 600 thereafter

Because units with shade trees command higher rentals of \$10-\$15 a month, mortgages generally are \$500 per unit higher. Thus, contour clustering is practical and profitable as well as beautiful.

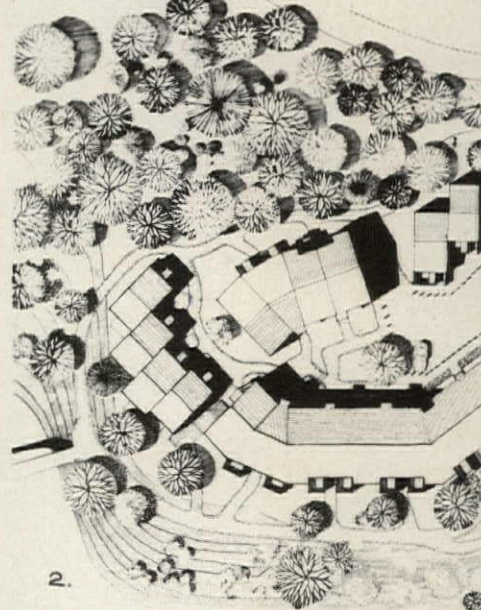

Linear clustering affords an improved approach

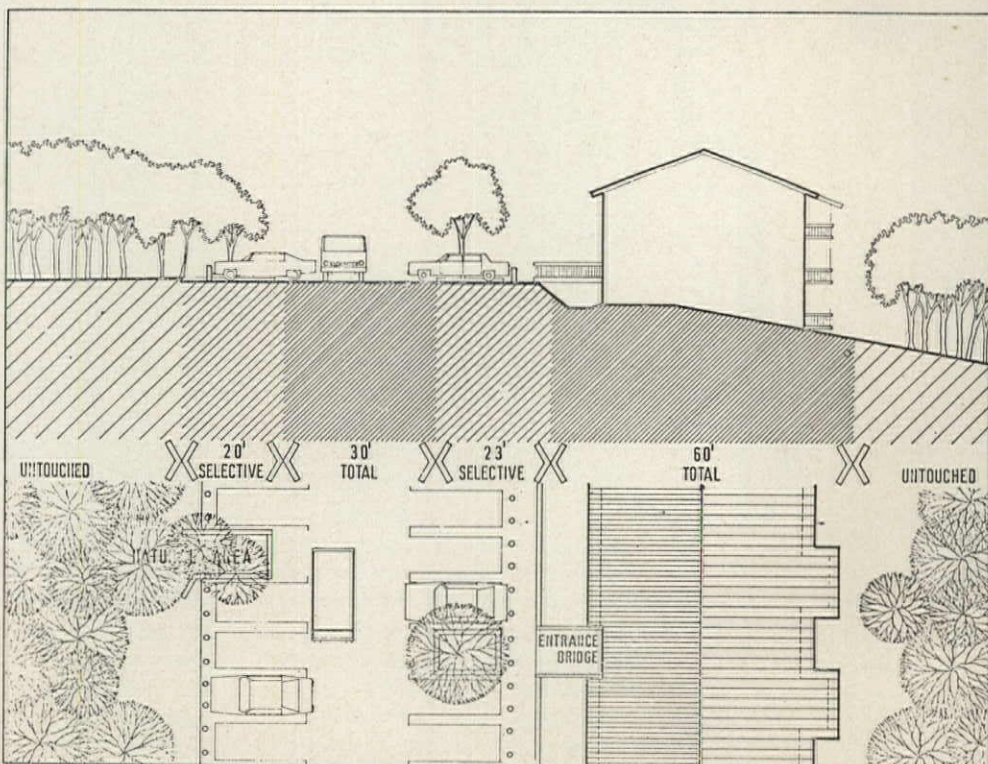

Sectional view shows method of tree preservation

JOHN RAHENKAMP, PRESIDENT, RAHENKAMP SACHS WELLS AND ASSOC. INC., PHILADELPHIA, PA.

# Who's introducing elegant new vanities with modest price tags?

## Miami-Carey.

Striking beauty and smart styling make our new vanities look a lot more expensive than their actual price. These distinctive units will let you add more luxury and function to baths of homes even in the low price range.

Miami-Carey's entry into the bathroom vanity business gives you a more complete package of bathroom products from a single supply source. This means simplified purchasing and coordinated deliveries direct to your job site.

Our two-door vanities are available in Driftwood White with gold trim and in Autumn Cherry with accent brown trim. All vanities

have a washable, stain-resistant woodgrain vinyl exterior, shelf space inside for storage, and coordinated hardware. They're available in three popular sizes — 24", 30" and 36" widths — giving you great space flexibility. And you'll find they blend tastefully with Miami-Carey's decorator cabinets, lights, accessories and lavatory ensembles. We have ventilating fans and heaters too.

To find out how you can add sales-stimulating vanities to your homes at a modest cost, just return the coupon. Miami-Carey Company, Division of Panacorn Corporation, Monroe, Ohio 45050.

Yes, I'm interested in your vanities and other bathroom products.

Name \_\_\_\_\_

Company \_\_\_\_\_

Address \_\_\_\_\_

City \_\_\_\_\_

State \_\_\_\_\_ Zip \_\_\_\_\_

**MIAMI CAREY**<sup>®</sup>

Dept. HH-571  
Miami-Carey Company  
A Division of Panacorn  
Corporation  
Monroe, Ohio 45050

CIRCLE 69 ON READER SERVICE CARD



# SHWA

**new symbol on the New York Stock Exchange**

**Shapell Industries is a producer of single family homes, townhouses, apartments, condominiums, and wholly self-contained communities. Shapell has a reputation for quality housing in thirty cities.**

**In the year ended December 31, 1970 net income totaled \$4,050,000, equal to \$1.15 a share, on sales of \$32,434,000.**



**Shapell Industries**  
**Growth Built On Quality**

8857 W. Olympic Blvd.  
Beverly Hills, California 90211

CIRCLE 194 ON READER SERVICE CARD

## CHECKED YOUR FINANCIAL SPECS LATELY?



**Delta  
Trend  
Fund**

Investing for possible **Capital Appreciation** in enterprises where significant changes appear to be setting new trends

For Prospectus: Contact

### Delaware Management Company, Inc.

7 Penn Center, Philadelphia, Pa. 19103 • Phone 215/LO 4-2556

Gentlemen: Please mail me a Delta Trend Fund Prospectus without obligation.

name \_\_\_\_\_

address \_\_\_\_\_

city/state/zip \_\_\_\_\_

CIRCLE 70 ON READER SERVICE CARD

## LETTERS

### Modular housing

H&H: Your January editorial regarding HOUSE & HOME's attitude toward modular housing has left me with the impression that perhaps you and others on your staff aren't exactly current on this subject.

For example, you refer to sectionals as something entirely different from modular houses—but they are one and the same. And your statistics are equally upsetting, inasmuch as they are obviously not based on any *real* facts. In this regard, last fall I published a book entitled "Modular Housing in the Real," which was based in large part on a national survey of manufacturers who produced only code-conforming modular housing. A total of 94 manufacturers indicated in writing that their production for the year 1969 (not 1970) was 13,375 units. Quite obviously, if we extend this statistic to include those manufacturers who did not participate in this survey, the total modular production for 1969 would be considerably higher. Your estimated figure of 10,000 for last year (1970) must be construed as just a little on the low side, inasmuch as the 1969 survey respondents projected a 300% increase for 1970.

I might add that my office is currently in the process of collecting similar data for 1970, and the survey returns thus far indicate that the totals may well be more "revolutionary" than "evolutionary." Why can't HOUSE & HOME open both eyes instead of just one and report facts instead of hearsay on this subject?

JOHN A. REIDELBACH, JR.  
Housing Consultant  
Annandale, Virginia

*We'll take reader Reidelbach's points as they were raised:*

*We agree that sectionals are the same as moduls. We should have explained more clearly that by sectionals, we meant the moduls that the mobile home industry has been producing for many years.*

*We quoted no statistics. We said we thought modular production would not exceed 10,000 for 1970, excluding 7,000 or so sectionals.*

*That estimate was indeed low. We can say that because we are in the process of tabulating what is probably the most extensive survey of modular housing ever made; it will be published when the computers are through with it. It shows that we were about 33% low on our total estimate of 17,000 moduls in 1970.*

*On the other hand, it's quite apparent that the prediction of a 300% increase from 1969 to 1970 is wildly optimistic. And since the total modular production for 1970 is less than 2% of total housing starts, we stand by our "evo-*

*lutionary rather than revolutionary" description of the modular industry.*

*Incidentally, reader Reidelbach's book, referred to in his letter, was noted in the "Literature" department of our February issue. It is a comprehensive, readable, and accurate primer on the subject of modular housing—ED.*

### Clifton Terrace

H&H: We feel compelled to reply to your February News article, "Probers report on Washington's Clifton Terrace rehab: a miserable failure."

Your reporter omitted a number of facts: to include them would have shown the report for what it was—a vicious attack on Washington's largest producer of low- and moderate-income housing.

First of all, at least one member of the subcommittee of the House District of Columbia Committee responsible for the report, Congressman Don Fraser, has disowned it on grounds that it is "one-sided," that the subcommittee staff improperly used congressional subpoena powers to compel persons to appear; that the report was prepared by the staff and released to the press without letting subcommittee members see it; that no hearings were held; and that the Housing Development Corp. was not invited to testify.

Secondly, although your reporter mentions an investigation conducted in 1969 by HUD officials after an attack on the project by an inner-city landlord, and subsequent findings that there was "no evidence of wrongdoing," he does not mention that that same former slumlord served as "technical advisor" to the subcommittee staff in making up the report.

The attitude and workings of the committee—which regularly impede progress toward solution of the District's housing problems—are not surprising. But the irresponsibility of your magazine in publishing a one-sided article about a one-sided report, without attempting to determine the facts, is.

H. CARL MOULTRIE  
Chairman of the board  
Housing Development Corp.  
Washington, D.C.

*Some facts were omitted, but Reader Moultrie cites inclusions as omissions; i.e., that no hearings were held and that the HDC was not invited to testify. The article reports both circumstances. HOUSE & HOME took great care to present both sides of the controversy, and such omissions as did occur were the result of a lack of space rather than of irresponsibility. No article with finite space limitations can include all the facts about any subject—ED.*



## Sanspray. The Great Stone Facing.

Imagine an exterior wall cladding with all the beauty and durability of stone. Plus the low cost, easy installation and maintenance freedom of plywood. And you're into Sanspray®. A natural stone aggregate bonded to plywood. The most exciting thing to happen to exteriors in a long, long time.

That's Sanspray's large aggregate pictured above. There's also a small aggregate (equally distinctive). And a

range of colors you have to see to appreciate; like Tangerine, Pearl Gray, Gaelic Green, Monterey Sand . . . and others.

But the hidden beauty of Sanspray lies in its low cost—far less than most stone and masonry wall claddings. Far lighter, too, and much easier to install. Saw it. Drill it. Glue it. Nail it directly to framing members. Then forget it. Because Sanspray is virtually maintenance-free,

in all climates. Sanspray. The beauty treatment for all residential, light commercial and industrial buildings. Find out more about it at your local U.S. Plywood Branch Office.



**U.S. Plywood**

A Division of U.S. Plywood-Champion Papers Inc.  
777 Third Avenue, New York, N.Y. 10017



# SECURITY

IS A  
COMFORTABLE FEELING

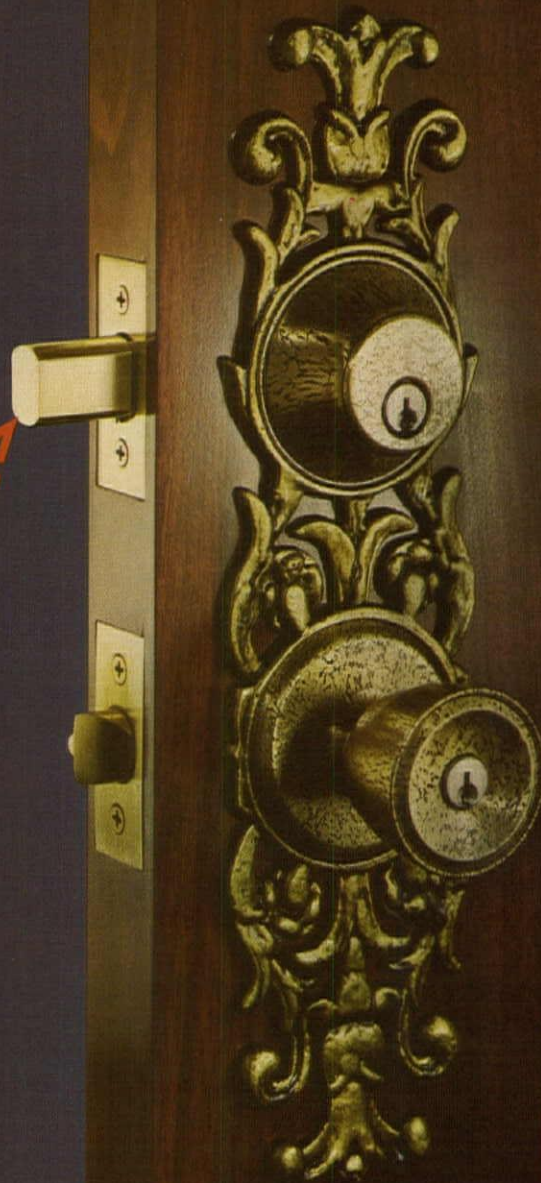
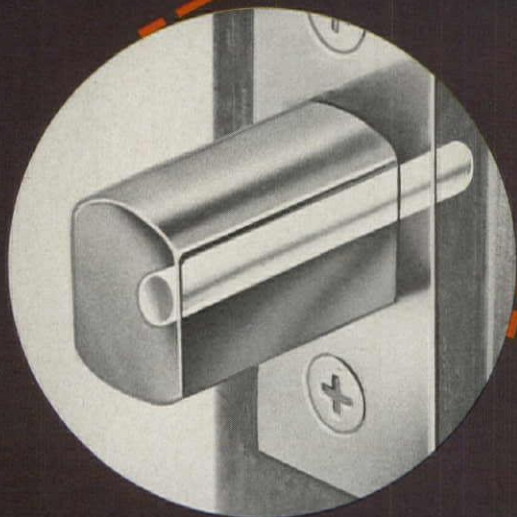

For real home security, here's the combination you need. A Weiser Deadbolt mounted with a Weiser Key-Knob Lock. Look what this gives you—

- **FULL 1" PROJECTION DEADBOLT**—a free-turning hardened steel insert makes it impossible to saw through the bolt.
- **FULL 1/2" PROJECTION LATCH BOLT**—deadlocked against pressure and manipulation by a credit card or other object.
- **2 RUGGED LOCKSETS** made from finest quality materials precision manufactured to combine security and outstanding styling.

## WEISER® LOCKS

WEISER COMPANY • SOUTH GATE, CALIFORNIA  
DIVISION OF NORRIS INDUSTRIES

## *An open letter*

### **To that giant corporation that is just about to acquire a homebuilding company**

Gentlemen:

Welcome aboard. It's good to know that yet another major corporation has enough confidence in our industry to justify sinking a few million bucks in it. Yes, I know it's stock and not cash. It's still a lot of bread.

Considering the size of your purchase, and knowing how careful you corporate types are when it comes to spending big money, I'm confident that you've researched your prospective builder right down to his toenails, and that he's passed all tests with flying colors. Obviously he's successful, or you wouldn't have considered buying him in the first place. Likewise you must have confidence that with your help, he can grow a lot bigger than he is now.

Nevertheless, on the off chance that you haven't yet put your name on the dotted line, I'd like to inject a small note of caution. Very small. Just in case.

You see, not all of these deals wind up peaches and cream for everybody. Sometimes they don't work out—we did a piece on that back last October called "The High Cost of Mergers"—and it gets expensive and unpleasant for all concerned. And the reason usually is that the corporation didn't think enough about the psychology of the homebuilder and his business.

What I'm getting at is that the builder is a swinger—businesswise, that is. He got where he is not just because he's a bright boy but because he has an intuitive flair for housing, can make fast decisions, and has gambler's guts. Otherwise he'd still be building five houses a year, or maybe selling shoes, instead of running a multi-million-dollar building company.

Now, you need this cat. When you buy the company, you're really buying him—not just land and lumber and trucks. He's the one that will make your new housing division profitable. The question is, are your corporate arteries flexible enough to handle him?

For instance, take the question of making decisions. Your builder probably started out as pretty much of a one-man show, so he made his decisions fast. And right, otherwise he wouldn't be here. By now he's probably got a management team running the show, but you can bet your corporate dollar those other guys move fast too. And you can also be pretty sure that your builder keeps the

final responsibility in his own paws. No buck passing. No one else to pass it to.

How is this going to work when he's part of your shop? Will you let him keep on working this way? Or will a whole batch of committees and vice presidents have to pass on all his major decisions, with suitable memos to make sure that if something goes wrong it can't be pinned on them? Remember that if a decision that should take days takes weeks or months instead, that old money meter will keep right on ticking, and a project that should have made a bundle will wind up in the red. Since your builder is not an experienced memo writer, the blame will probably wind up on his lap, and he may justifiably become fretful.

Or take the question of money, if you'll pardon my bringing up a delicate subject (after all, your builder is marrying you for your money.) You may think that your builder is financially small potatoes compared to you, and you're right, but he's also used to moving pretty hefty sums around at a speed that might keep your comptroller awake nights. And there's a very legitimate reason: if he doesn't get half a million clams up by tomorrow, somebody else is going to slap a down payment on that big piece of land and the next three year's work goes out the window.

If that happens a couple of times, because your comptroller and some of your vice presidents think that just on principle, money shouldn't move that fast, your builder will progress from fretful to hostile, and sooner or later he'll start climbing the wall. Ultimately he may grit his teeth, work out his contract period, and because he's already got what is euphemistically called in the trade his "go to hell money," walk out. Then after a couple of years, or whatever the no-build clause in his contract calls for, he starts a new business—maybe competing with you.

I don't mean to infer that his happens every time a big corporation buys a builder.

But it's happened a lot, and it will happen again. Whether or not it happens to you depends on whether you can control your builder to your own corporate satisfaction and at the same time give him room to swing. And he's got to swing.

Lots of luck.

Sincerely,  
MAXWELL C. HUNTOON JR.

# California

*Under the glitter, a growing sense of the market*

*If housing has a Mecca, it is California. Ever since the mid-sixties, builders by the thousands have made the pilgrimage to the West Coast to study California models, California design, California decorating, and California merchandising. And they have begun incorporating what they have seen in projects all the way from Michigan to Virginia to Colorado.*

*Unfortunately, the transplant doesn't always take. Not everything that glitters in California is gold, and the indiscriminating visitor sometimes fails to check whether or not anything sound underlies the color and excitement.*

*The result can be a glamorous bomb.*

*But the builder who takes the time and trouble to poke beneath the glitter will find that, more and more, the best California housing is based on sound marketing sense. The glamour remains—indeed, it's stronger than ever. But it's there not for its own sake but to serve a purpose. And that's the subject of the next 20 pages.*







Cluster units are part of Mission Hills, a new recreation project in Palm Springs, Calif. Details are shown on the following page.

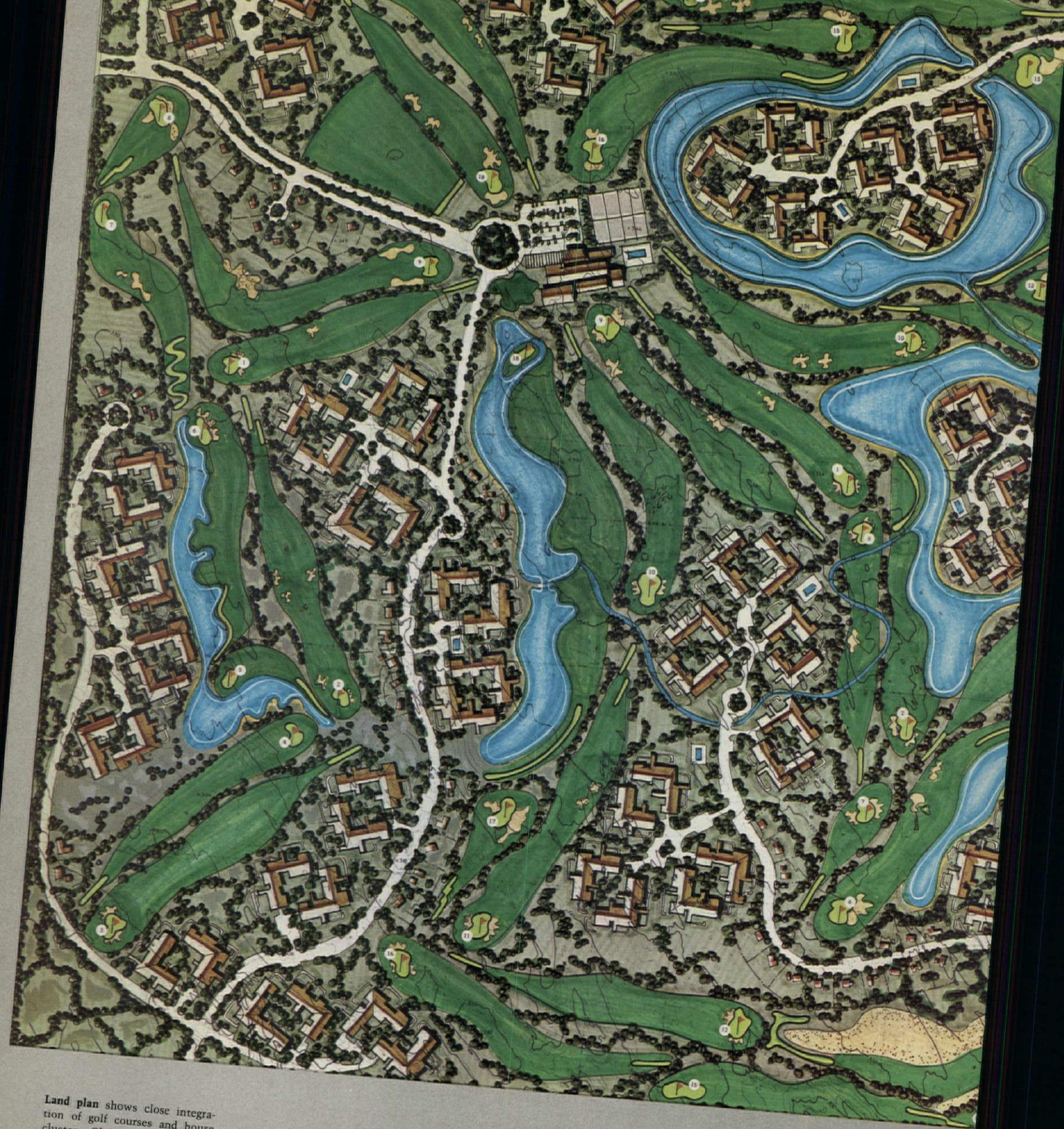

**Land plan** shows close integration of golf courses and house clusters. Club is at upper left of center. First course, on left side of plan, has been completed.



At long last, *land planning* seems to be happening in California. In the past, high land cost and a predominantly single-family market have combined to produce unrelieved crowding, and most developers have been reluctant to make more than token gestures toward open-space planning. But two new projects in the resort town of Palm Springs offer hope that something better may be on the way. The first is a large project with a relatively low net density, the second a small project with a high net density. Both offer a quality of planning—including the housing—that could be profitably emulated anywhere in the country.

### Mission Hills: a classic example of clusters and green space

There are two ways of looking at this 680-acre project.

As a piece of land planning, it is a superb example of the advantages of clustering. The project's 1,100 units (1,000 attached condominiums and 100 single-family houses) are being built on roughly 300 acres—a gross density of about 3.5 units per acre. But even at that density there is almost total indoor and outdoor privacy. Every house has a view of part of the 340 acres of golf-course green space and many also overlook parts of the 45 acres of man-made lakes woven through the project (see the following page).

As a recreation community, Mission Hills may well be the best example to date of how a golf course (two courses, in this case) can be integrated with housing. The entire design package—land plan, architecture, and golf-course design—is being handled by one firm—Desmond Muirhead, Inc. Muirhead himself is both a planner and a golf-course architect, hence uniquely qualified to put the two elements together (H&H, June '68) and to do so on a sound economic basis (H&H, Nov. '70). The result is a golf-course green-belt system that enhances the houses enorm-



Model area (top photo) faces lake. Present price range is \$42,000 to \$85,000 on leased land. Clubhouse (bottom photo) is focal point of project.



condominium is changed  
tly from preliminary  
previous pa  
ws typical cluster  
del area with lake in  
golf course  
in ear.

ously, and houses that take full advantage of the green areas.

This combination is paying off. Says Max Genet Jr., developer of Mission Hills: "We're selling twice as fast as any other project in the Palm Springs area. The first condominium of 50 units was sold out weeks after we opened the models, and we have reservations for half the second condominium (it will have 100 units) even though they're only at the grading stage."

A key reason for this sales rate, Genet feels, is the fact that the first course was in and playing when the models opened: "People don't want to buy a house in a resort area and then have to go looking for a golf club and other recreation facilities. They want to get it all with their house. And that's what we're offering."



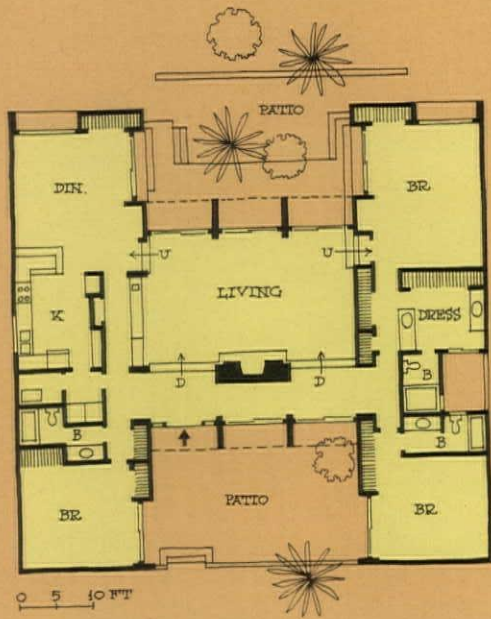

Three models out of the five first offered are shown in plans. Photo below shows view of lake from model living room. First models were designed by Walz & MacLeod. Model interiors are by Gary Jon.

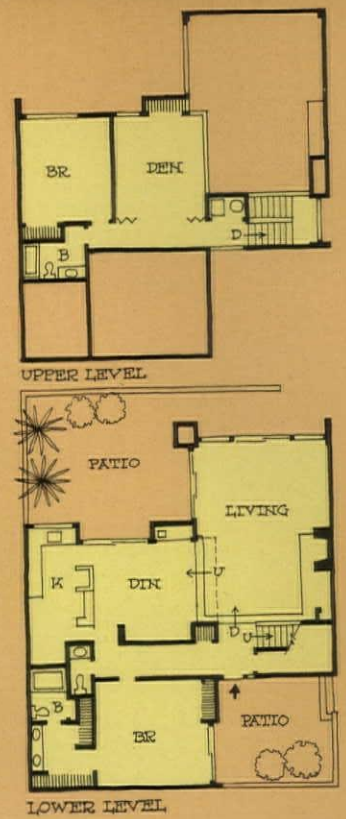
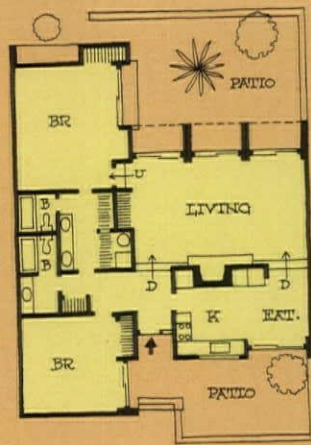

LELAND LEE

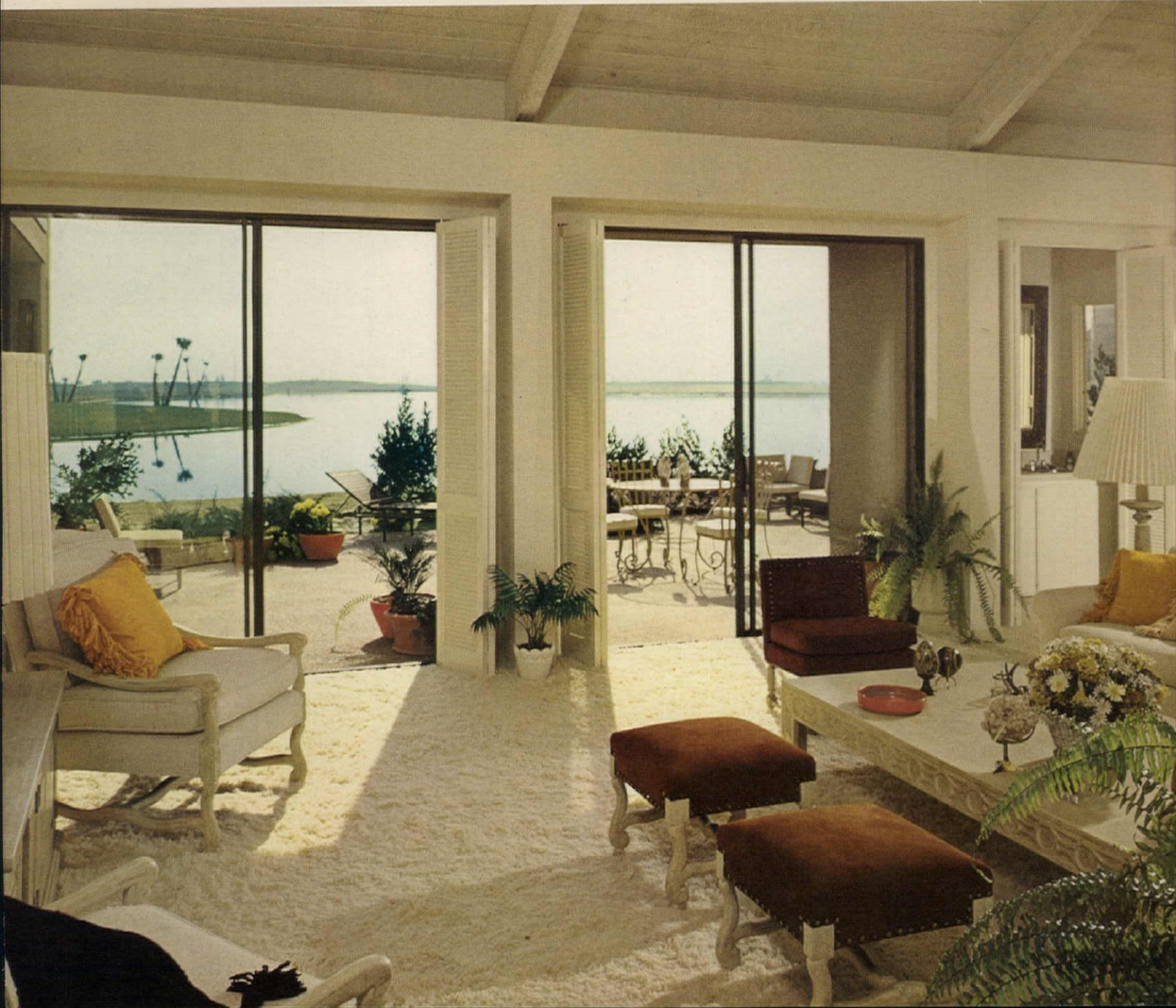



Site plan is divided into three phases, each with its own center green area and pool. First phase is at bottom, second phase, just completed, at upper right, third phase, just starting, at upper left. Detached units line the outside edge of the site, and a wall separates them from adjacent properties.

Entrance (right) has guard to check visitors. Wall runs around the entire project.



PHOTOS: JULIUS SHULMAN

## Deepwell Ranch: a lesson in opening up a single-family project

In terms of density—111 houses on 24 acres, or just under five units per acre—this project typifies the Southern California single-family development. But in terms of how that density is executed, the project is decidedly atypical: it has real open areas.

**Model area (below)** is a cul-de-sac with the road temporarily grassed over. Attached houses are on either side of the road, visible beyond iron fence.

To achieve this open space, architect Barry Berkus pulled 80 of the houses into clusters of three and four units each—a much more efficient land-saving method than the com-

monly used zero-lot-line siting. This makes possible a central green area for each group of about two dozen units. Entrances and garages are on a perimeter street, and living areas face into the common green.

Not everyone wants to live on a common green, so the builder, Deepwell Development Co., has put 31 detached units around the periphery of the project. They are zero-lot-line houses, each with its own pool. But

like the attached units, they are condominiums, so owners get the advantages of condominium maintenance.

Sales, says William Fruehling, project director, have gone extremely well. The first phase, which opened in May 1970, is long since sold out; the second, which opened the first of this year, has only a couple of units left; and there have already been half a dozen reservations for the third phase, where construction began only last month.



Lowest-priced model at \$41,950 (on leased land), this two-bedroom house is part of the complex of attached houses in Deepwell Ranch's second phase. It has a living room with a full glass wall opening into the center court, and for more private outdoor living, there is a side court enclosed on three sides by the kitchen, living room, and master bedroom. Like all other models in the project, it can be purchased with its own lot in fee simple as well as on leased land. Extra cost: \$6,000.

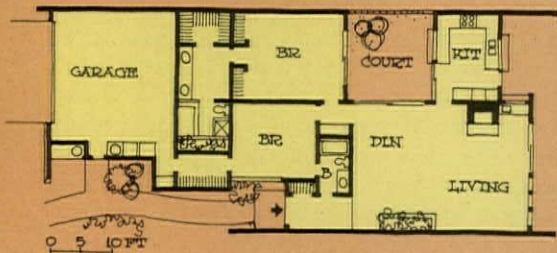

Living room (above) has glass wall that opens to a common center green with pool. Patio (left) has a small health pool installed in it. Luxurious master bedroom suite includes large master bath (photo immediately below) and master bedroom that opens out to the side patio (bottom photo).







PHOTOS: JULIUS SHULMAN

Highest-priced model at \$56,960 (on leased land), this model is one of the detached houses built around the perimeter of the project. It has three bedrooms—the third may also be used as a study—two baths, and such luxury touches as a wet bar and a patio garden off the master bedroom. Like the attached units, it is available with fee simple lot. Extra cost: \$10,000. Model decorations are by Carole Eichen Interiors Inc.

Private pool (top) is in rear patio. View from kitchen (bottom) shows perimeter wall that surrounds the project.

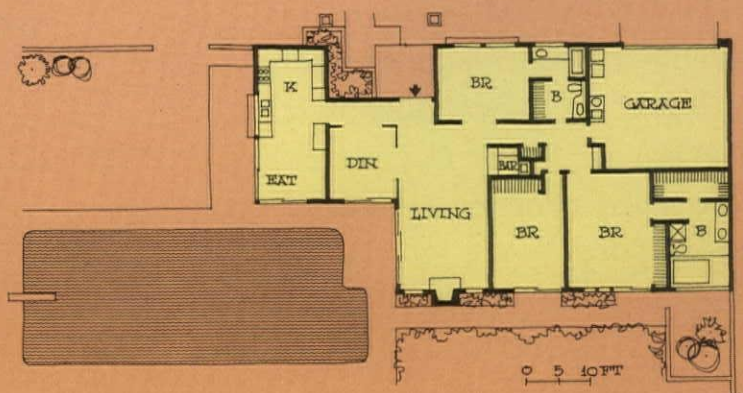



Typical group of townhouses (above) includes six units. Master bedroom (top of facing page) is in one-story end unit, living room (right) is in two-bedroom, two-story unit.

# Townhouses

have never boomed in California, despite their ability to combine single-family living with efficient land use. But now two factors—rising prices and a growing distaste for the maintenance that goes with the conventional house—are changing the picture. Townhouse building is on the increase in California. And the range it encompasses is demonstrated by the projects on the next four pages.

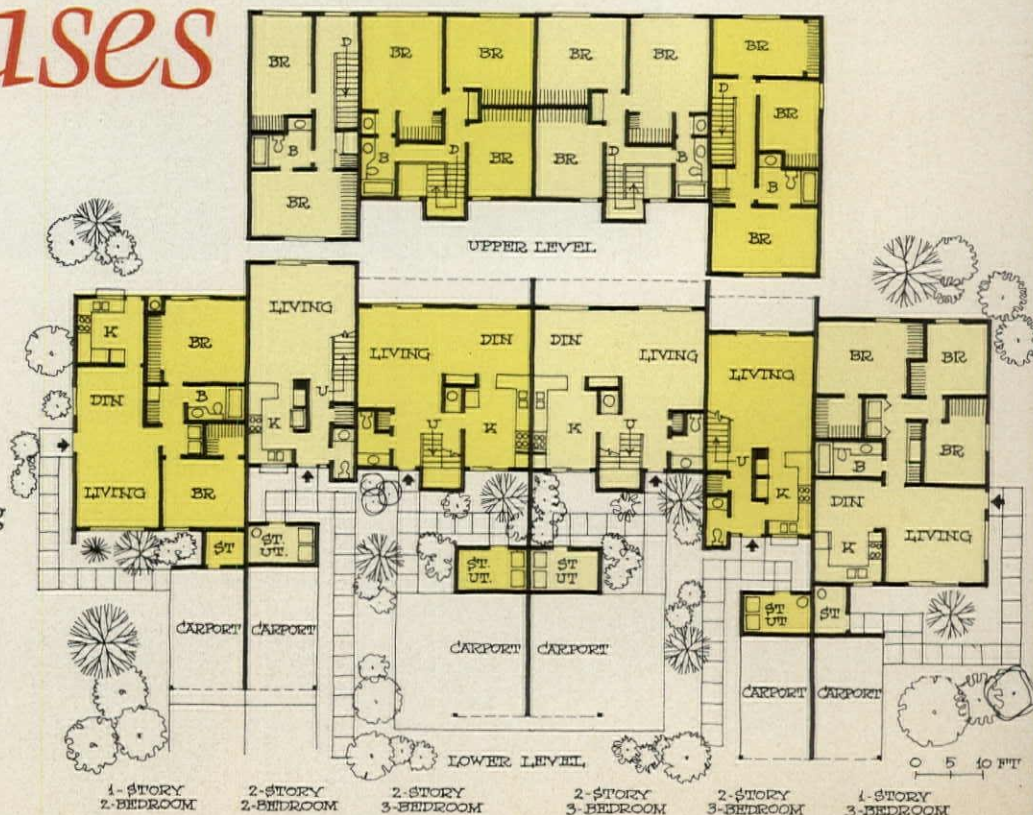



### Village Park: price is the big feature

"Two years ago," says Armando Ortega, sales and marketing director, "we wouldn't have built townhouses in this project. People insisted on single-family houses." The change is shown by Village Park's housing mix: its 900 acres will include 2,000 townhouses vs. 1,700 single-family units.

"Price is the reason," says Ortega. The townhouses sell

for from \$17,995 to \$23,395, and the price includes a share in the condominium recreation complex. By contrast, houses are priced from \$24,495 to \$29,995, and the cost per square foot is higher.

Village Park is being built by Avco Community Developers Inc., in Encinitas. It opened in February, and more than 100 units have been sold.

PHOTOS: JULIUS SHULMAN





## The Bluffs: better environment is the big feature

And townhouses are the key to the environment. Typical competing single-family projects in the area are built to densities of up to five units per acre; the townhouses permit densities of up to seven per acre, and leave far more greenbelt area in the bargain.

The units shown here are the last group in The Bluffs, which opened five years and about 1,000 townhouses ago. And the townhouses are selling better (65 so far and an expected 300 by year's end) than when The Bluffs opened.

"Acceptance is much wider now," says George Holstein III, developer of The Bluffs. "A few years ago people didn't understand the townhouse concept. Now they can drive around and see how well it works. And the majority of our buyers today came from referrals."

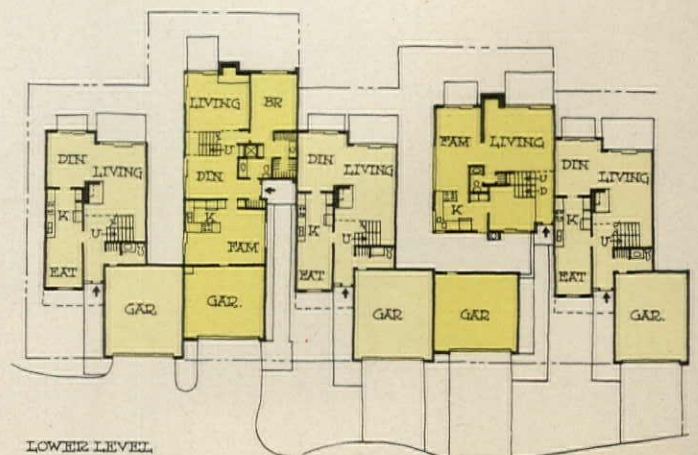
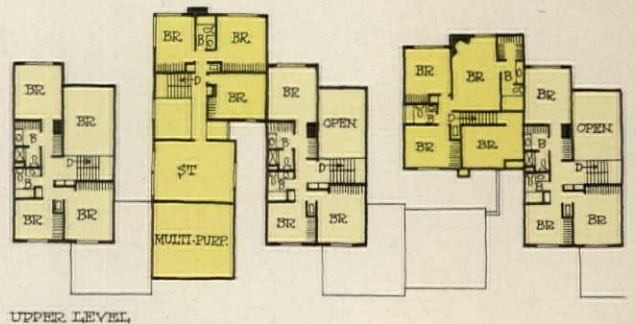



Model area (above, left) has glassed-in garage as a sales office. Houses sell for from \$30,000 to \$55,000 on leased land. Lot purchase adds from \$5,000 to \$12,000, and most buyers opt for the leases. Greenbelt area (above) at rear of model area typifies open space made possible by townhouse design. Living room (left) of typical model overlooks the rear green area.

PHOTOS: JULIUS SHULMAN

In the final analysis, conventional *houses* are still the backbone of California housing, and the most competitive item too. So it's not surprising that the marketing of the single-family house has in some cases become a fine art. Case in point is Mission Viejo, an 11,000-acre project in Orange County, which saw 431 houses sold by early April—probably tops in the country. On the next four pages, John Martin, marketing vice president of Mission Viejo, analyzes the project's two newest programs in terms of which houses were planned for what buyers, and which buyers actually bought them.



PHOTOS: DEAN HESKETH

The New Madrid series includes five models ranging in price from \$28,000 to \$40,000.

"We went to this price range because everyone else was lowering prices," says Martin, "and we thought we'd have little competition." The strategy worked; the models opened in February, and 131 had been sold by April 1. The overall success of Mission Viejo can be deduced from the fact that more than half of these sales were to people moving up from smaller Mission Viejo homes.

Two-story model (left) is top of the New Madrid line. Its living area is shown below, its plan at lower left of facing page. Interior decorating is by Carole Eichen.



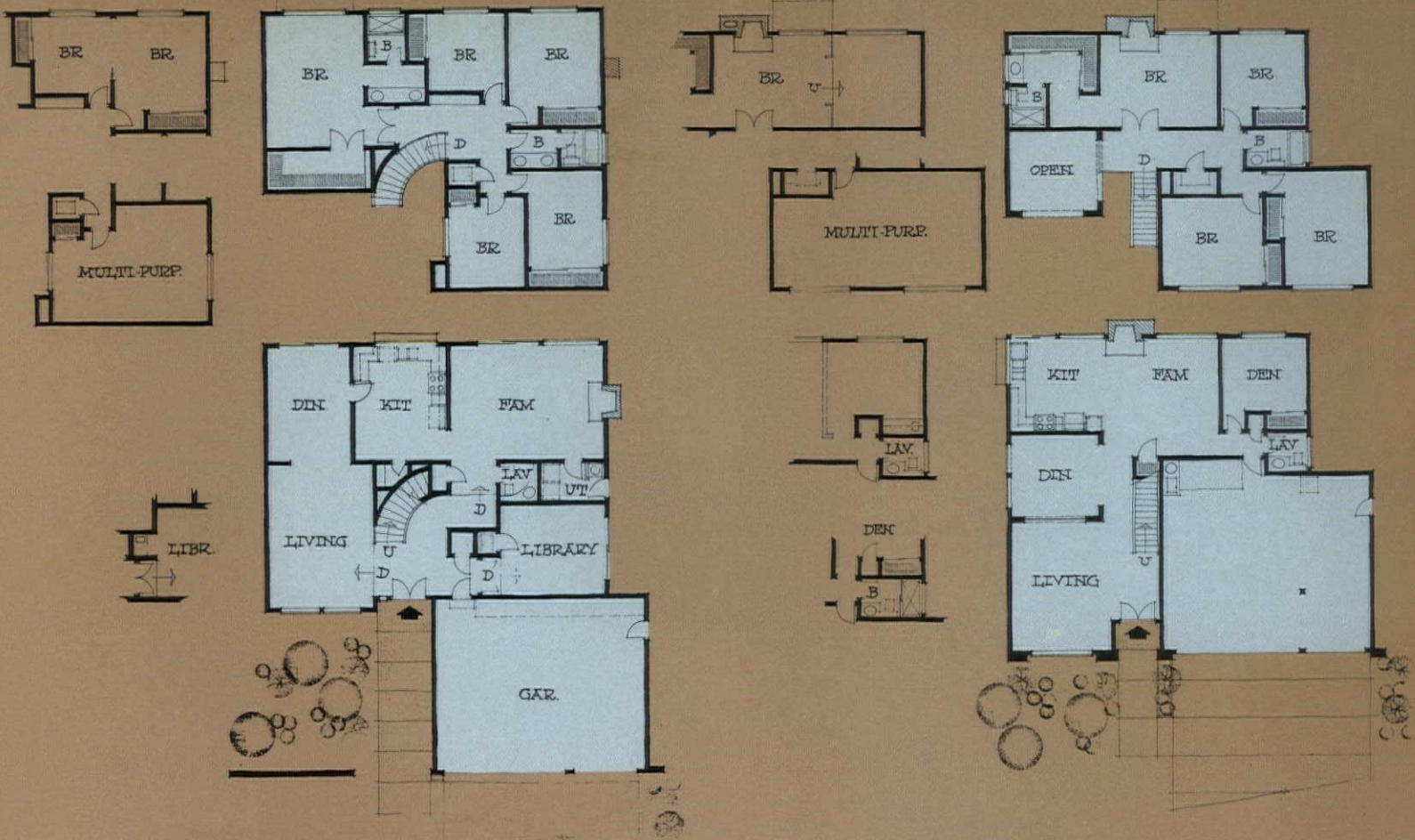

**\$39,500 model:** 40 years old with three children (median age 10); \$17-\$20,000 income, self-employed or in professional or managerial category. Top features: curved stairs, library, three-car garage.

**\$35,995 model:** 33 years old with two children (5-9 years old); \$15,000 income; second-time buyer on tight budget. Top features: master bedroom suite, three-car garage, large secondary bedrooms.

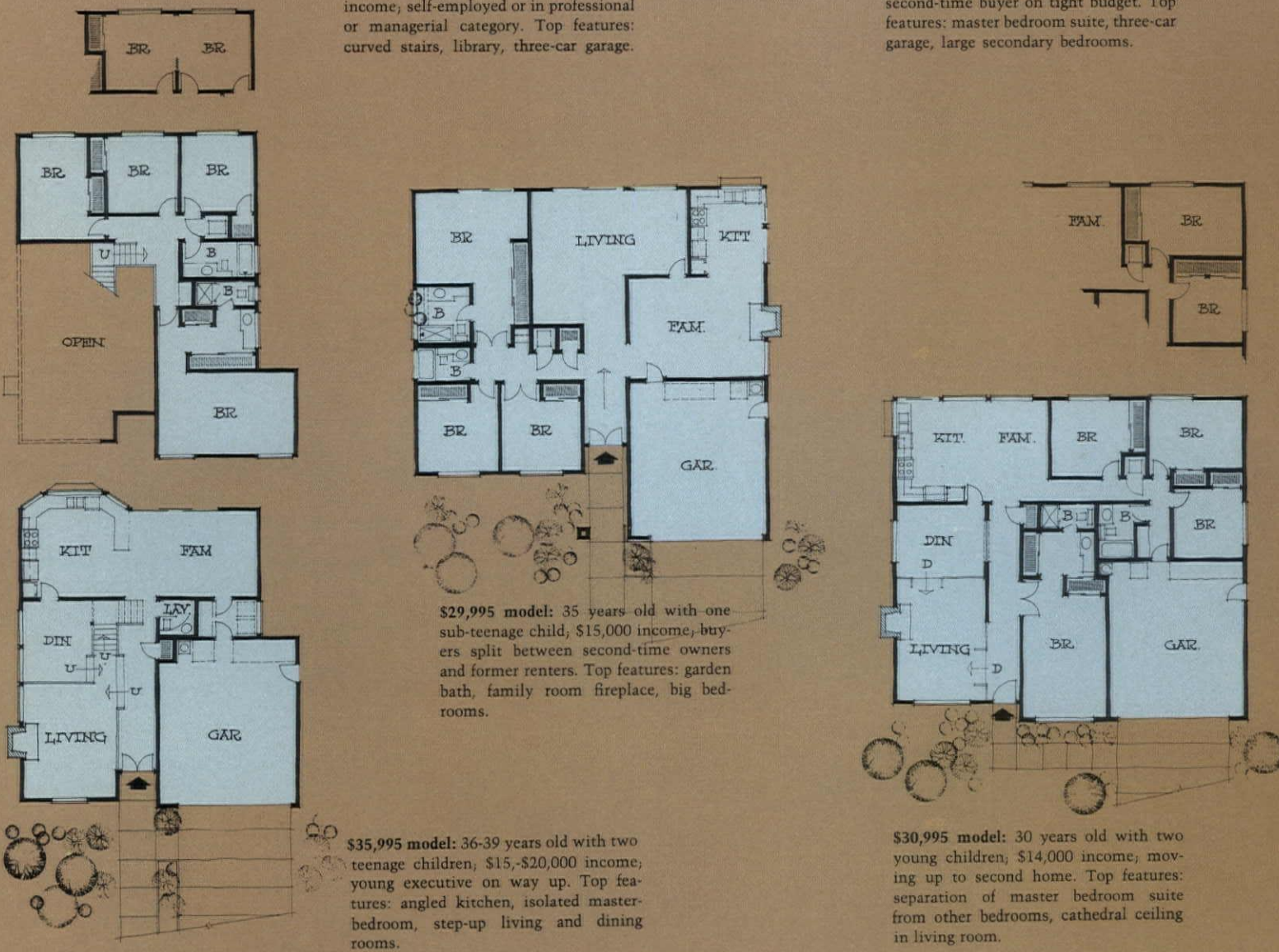

**\$29,995 model:** 35 years old with one sub-teenage child; \$15,000 income; buyers split between second-time owners and former renters. Top features: garden bath, family room fireplace, big bedrooms.

**\$35,995 model:** 36-39 years old with two teenage children; \$15-\$20,000 income; young executive on way up. Top features: angled kitchen, isolated master-bedroom, step-up living and dining rooms.

**\$30,995 model:** 30 years old with two young children; \$14,000 income; moving up to second home. Top features: separation of master bedroom suite from other bedrooms, cathedral ceiling in living room.



PHOTOS: DEAN HESKETH



The Seville series includes six models ranging in price from \$25,000 to \$33,000. They differ from the New Madrid models in that they are 1) lower in price, 2) more oriented to the empty-nester market, and 3) built on smaller lots with zero-lot-line siting.

"These are also trade-up buyers," says Martin, "but as empty nesters they're less interested in keeping up grounds than are New Madrid buyers." So far this year 142 Seville homes have been sold.

**Four-bedroom model** (top of page) has a sales office built on one side. It is also available in a three-bedroom version (center plan on facing page). Living-dining area (left) is in middle-of-the-line, two-bedroom model (lower right corner on facing page).



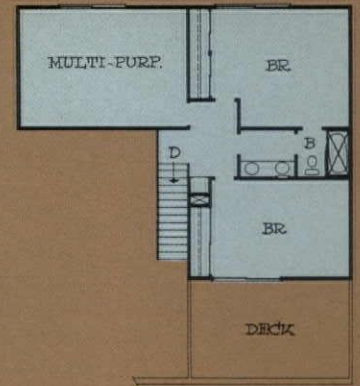
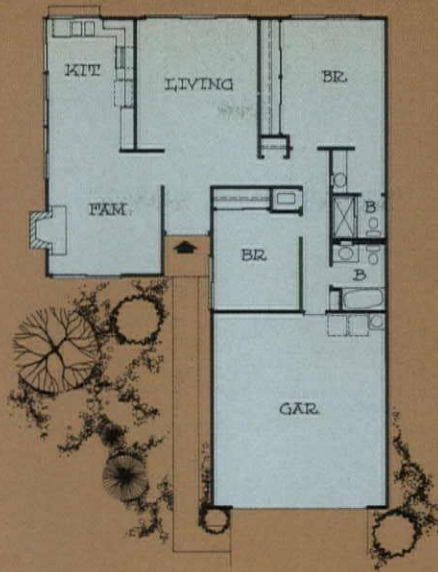
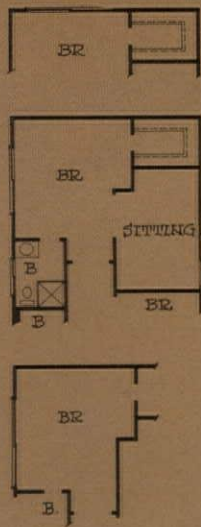

**\$26,495 model:** 28 years old with one child (2-3 years old); just starting out. Top features: courtyard effect behind entrance wall, combined kitchen-family room with fireplace.

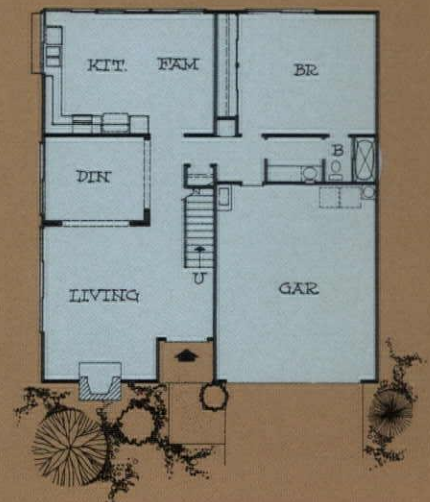
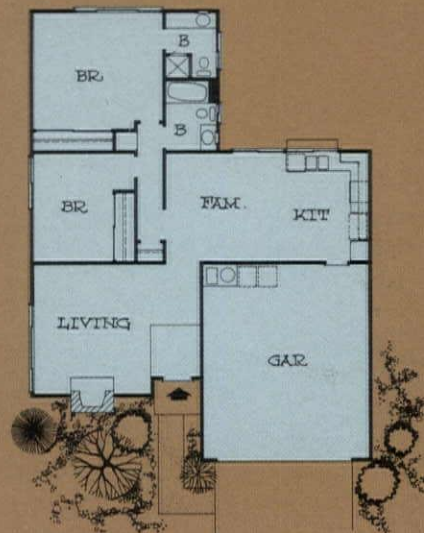
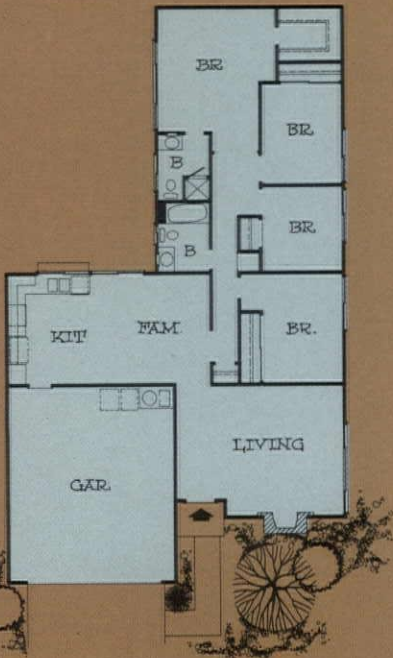
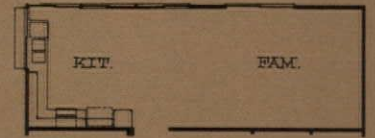

**\$28,495 model:** 29 years old with two young children; second-time buyer because of birth of younger child. Top features: covered entrance; isolation of family room from living room.

**\$24,995 model:** 26 years old with no children, generally a first-time buyer. Top features: open, spacious arrangement of combination kitchen and family room; large master bedroom suite.

**\$32,995 model:** 36 years old; primarily with two teenage children. Top features: two-level dining room arch; unusually large size of all bedrooms (many of the buyers have four or five children.)

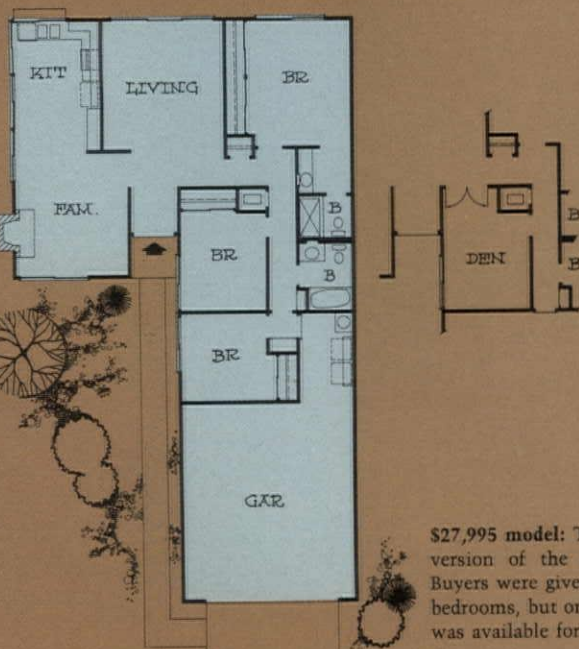

**\$27,995 model:** This is a three-bedroom version of the model at top center. Buyers were given option on number of bedrooms, but only two-bedroom model was available for viewing.

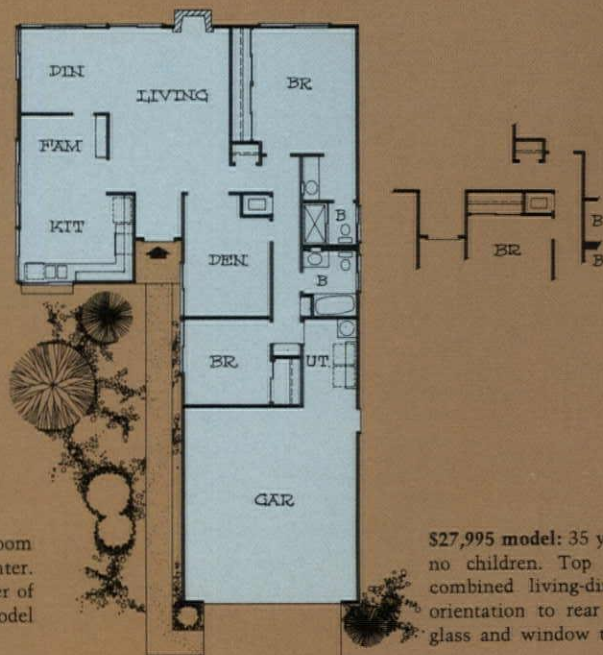

**\$27,995 model:** 35 years old with one or no children. Top features: expansive combined living-dining room and its orientation to rear patio; wide use of glass and window treatment.



Twin gazebos on corners of bayside walkways flank a beach club, just visible at extreme right. Floating slips, behind nearest gazebo, are for owners' boats. Photo on facing page shows how dropping the perimeter walk from the projects base grade helps reduce the unsightliness of the concrete bulkheads.

*Few things are more important than the atmosphere of a project—the total impression it creates. Yet by and large, few things get less attention from the developer; atmosphere emerges as an accidental by-product of the project's architecture and, occasionally, its site. The next four pages show a fortunate exception: a waterfront community in Southern California whose atmosphere results from the meticulous planning of everything from recreation buildings to house numbers.*



## **Coronado Cays: a waterfront community with Caribbean character**

This could have been a very ordinary project, despite its extraordinary setting—Coronado Island, on San Diego Bay and just a stone's throw from the Pacific Ocean. The site was 370 acres of nothing but sand; no trees or vegetation, and no other natural features to suggest a theme for the project.

So a theme was created. Architect Randy Williams had traveled extensively in the Caribbean, sketching architectural details that might be transla-

table into new housing. These details—a few of them are shown on the next two pages—became the basis of Coronado Cays.

The result is apparent in the pictures above and at left. Instead of a series of sandspits edged with unesthetic concrete bulkheads, Coronado Cays has touches like tiled fenceposts, ornate gazebos, seawall stairways—all combining to create the flavor of a Caribbean island.

When it is completed, Coronado Cays will have about 1,500 townhouses and detached houses on 170 acres. Forty of the original acres were turned into waterways, another 166 are leased by San Diego to Coronado Cays Co., and will be used for apartments and commercial development, and about 18 acres were given to the city as sites for schools, parks, etc. Coronado Cays Co. is a joint venture of Signal Properties and Cedric E. Sanders.

LEGEND:

- 1 PARK
- 2 MULTI-FAMILY
- 3 JAMAICA VILLAGE
- 4 GREEN TURTLE CAY
- 5 ANTIGUA VILLAGE
- 6 SAHAMA VILLAGE
- 7 WATERFRONT VILLAGES
- 8 VILLAGE HOMES
- 9 PARK & MUNICIPAL FACILITIES
- 10 SCHOOL & PARK
- 11 WATERFRONT HOMES
- 12 SHOPPING CENTER

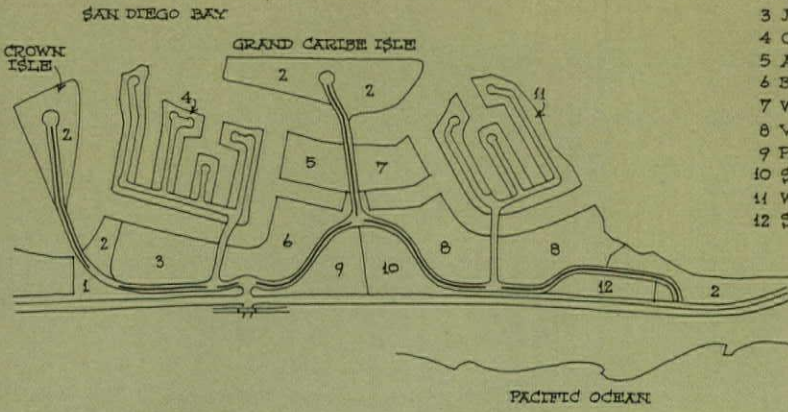

The site plan at left shows the extent of Coronado Cay's residential areas. The fingered island at left is just now being developed; it will have custom houses on it. The section at the left of the project's shore side was the first to be developed; it is called Jamaica Village, and it is there that the photos on this page were made. Along with the photos are the sketches from which architect Randy Williams designed Coronado Cays.



Stairway and fencing (above) on walkway is borrowed from Port of Spain (below). Entrance gate derives from sketch at far right, made in Haiti. Stairway (center) is from Hamilton, Bermuda.

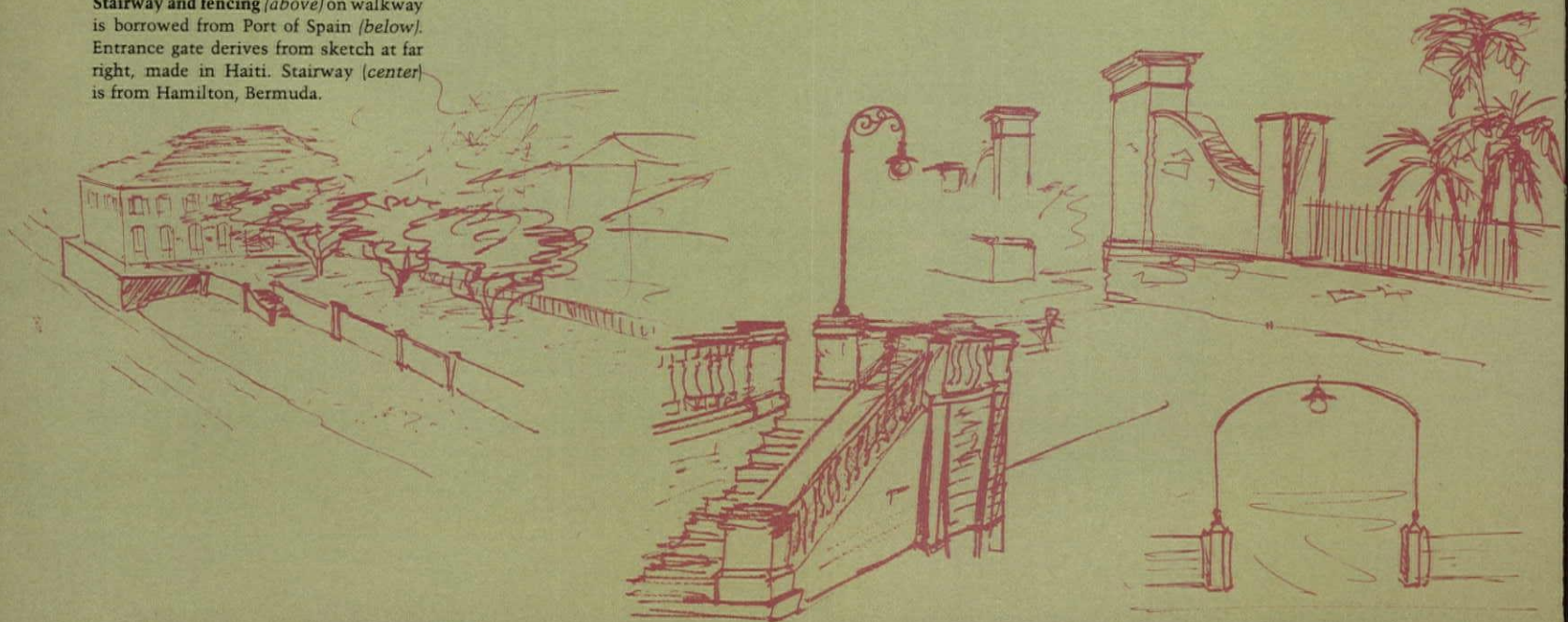

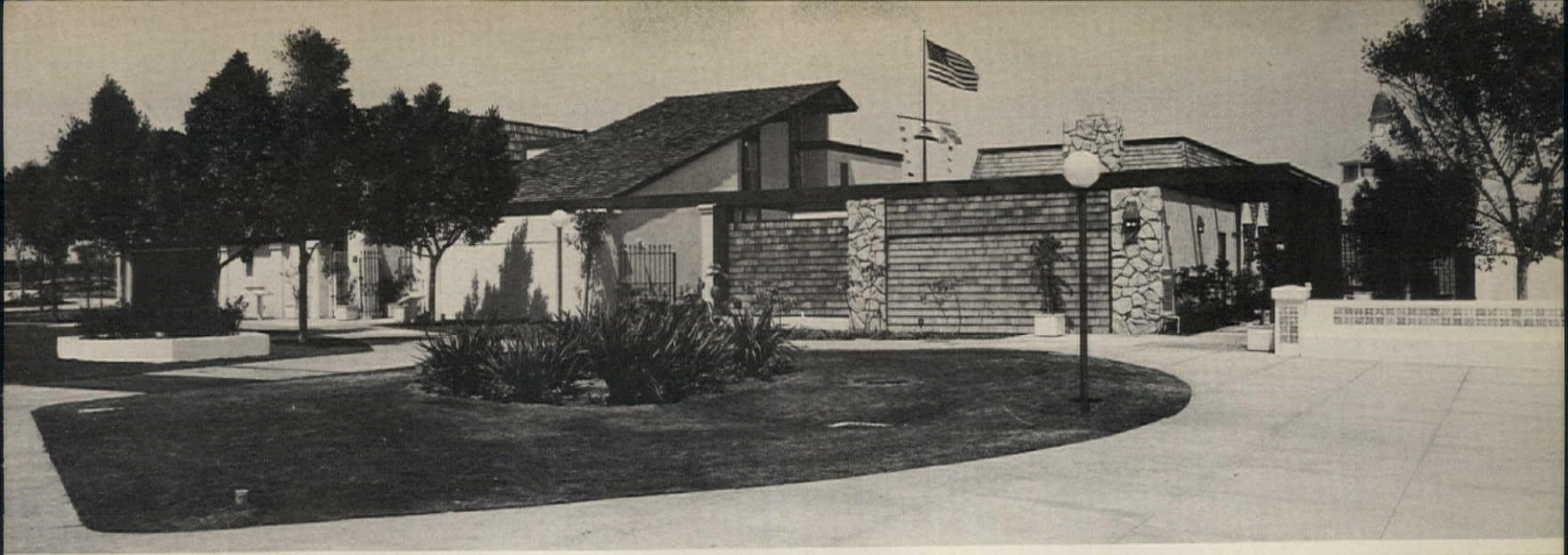

Courtyard with iron gate (*below*) helped established motif of townhouse entrances (*above*).

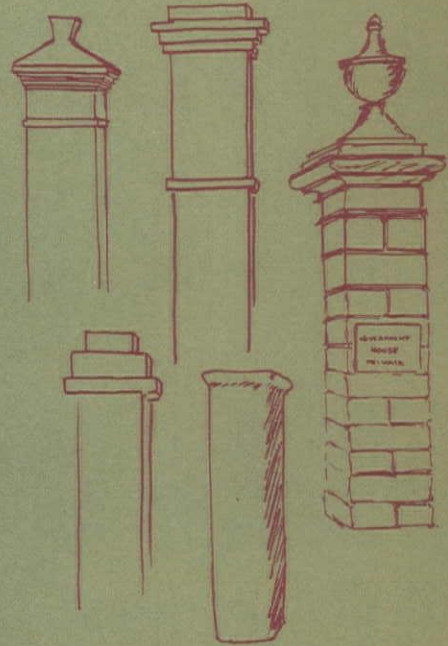

Pavilion with striped roof (*above*) in Virgin Island was inspiration for Coronado Cay's beach club (*below*).

Tile street signs in Bermuda (*above*) led Williams to tiled house numbers and village insignia (*left*). Tiles were hand-made in Mexico.



# More jobs for blacks?

You can fight the equal employment law. . .

You can go along grudgingly. . .

Or you can do a lot more  
than the law requires. . .

Here's why one building company  
chose the last course—  
and how it gets results



PHOTOS: JOHN KIRK

It pays to go out of your way to bring blacks into the construction field, says Building Systems Inc., a Cleveland-based producer of components and low-income housing. And the payoff comes in two ways:

**The reward is financial.** "We have already discovered," says BSI President Stanley Rothenfeld, "that when we approach equal employment in a positive way with a smile on our face—instead of grumbling—we make more money. That's why we're here."

Alan Gressel, a BSI vice president, cites turnkey projects as one example. He says he can charge more than his competitors and still land jobs because local housing authority officials know "we'll really put some blacks to work."

In turn, Gressel prods BSI's subcontractors to hire blacks. For instance, he'll tell one: "Get six more black guys on this job and I'll get you an extra ten grand."

**The reward is social accomplishment.** Gressel, a white man who formerly directed the Urban League's Operation Equality in Cleveland, says he does more for blacks now than he ever did in his former job: "All I have to do is hang out a few dollars ahead of them [white subs] and they go. The housing gets built. And if there were no dollars they wouldn't go."

Considerable confusion still surrounds the federal equal opportunity law\* even though it has been on the books for seven years. The law forbids job discrimination on the grounds of race, creed, color, sex, age, religion, or national origin. In theory, it affects any employer with 25 or more employees. In practice, it has little muscle unless the employer is doing business with the government in one way or another.

A builder is affected, then, if he builds public or FHA-insured housing. A few examples: single-family houses that will be FHA-mortgaged, housing for the elderly under Section 231, and turnkey projects.

In such cases, two Presidential Executive Orders\*\* require that an employer act affirmatively to hire minorities.

An FHA official in Cleveland explains affirmative action: "The Government isn't



BSI's president, Stanley Rothenfeld, sums up company policy toward minority employment: "Treat people as people!" Thus, he sees that blacks get jobs not only with his organization but also with contractors and subs doing business with BSI.

trying to jam quotas down the builders' throats," says William Bowen, assistant to Cleveland's FHA director. "Instead, we simply want builders to try giving blacks a chance. And to try *harder* on each subsequent job."

The government, Bowen explains, is especially interested in involving the heretofore all-white contractor in minority hiring. So he says he'd rather have a construction job done by a white contractor who agreed to hire his first black man than by a black contractor—even though he could put a black man in every trade.

Is affirmative action costly? "Certainly," says Rothenfeld. "But," he continues, "not only do we feel strongly that blacks should get jobs, we also know that to comply with government requirements we must be committed."

Here is how publicly-owned BSI, which did \$26 million in sales last year, carries out that commitment as it manufactures components and builds and rehabs houses and apartments:



BSI's EEO officer, Charles Pinkney, knows he can't make the world accept the black man as an equal. So he doesn't try. Instead, he says, "I'm happy to get a white subcontractor to attempt EEO—to add just one more black man the next time out."

## How BSI manages its equal-opportunity plan: "We make it a full-time job for one executive"

Many management men whose job it is to see that blacks and other minorities get a fair shake have to sandwich that responsibility in between their other duties.

Not so Charles Pinkney, who joined BSI last September after Rothenfeld decided to "treat equal employment around this place on a programmed basis—not hit or miss." His sole responsibility is the company's EEO program.

Pinkney, a former partner in a Cleveland real estate agency, is also president of the otherwise all-white city council of Warrensville Heights, a Cleveland suburb.

He has no illusions about race relations: "I know I can't make the world treat blacks as equals, so I'm not about to try." Instead, he says, "I'm happy to get a white subcontractor to attempt EEO—to add just one more black man the next time he starts a job."

In keeping with that one-step-at-a-time attitude, Pinkney takes a skeptical view of his title, "Equal Employment Opportunity Officer", says he believes "Affirmative Action Administrator" is more to the point.

Job titles aside, Pinkney reports to the vice president in charge of development, Alan Gressel, and is therefore in at the start of all housing projects. His duties include:

Setting up joint ventures between white subcontractors and inexperienced black subs (see page 100).

Alerting black subs when white general contractors working for BSI start to get informal bids. If the subs wait until the job is formally reported, it's usually too late, he says. By then, the contractors have already made their decisions.

Getting minority-hiring commitments from white subcontractors about to embark on a new project for BSI—and persuading them to increase their commitments

\*Title VII of the Civil Rights Act of 1964.

\*\*Executive Orders 11246 and 11375 were issued by President Johnson in September 1965 and October 1967, respectively.

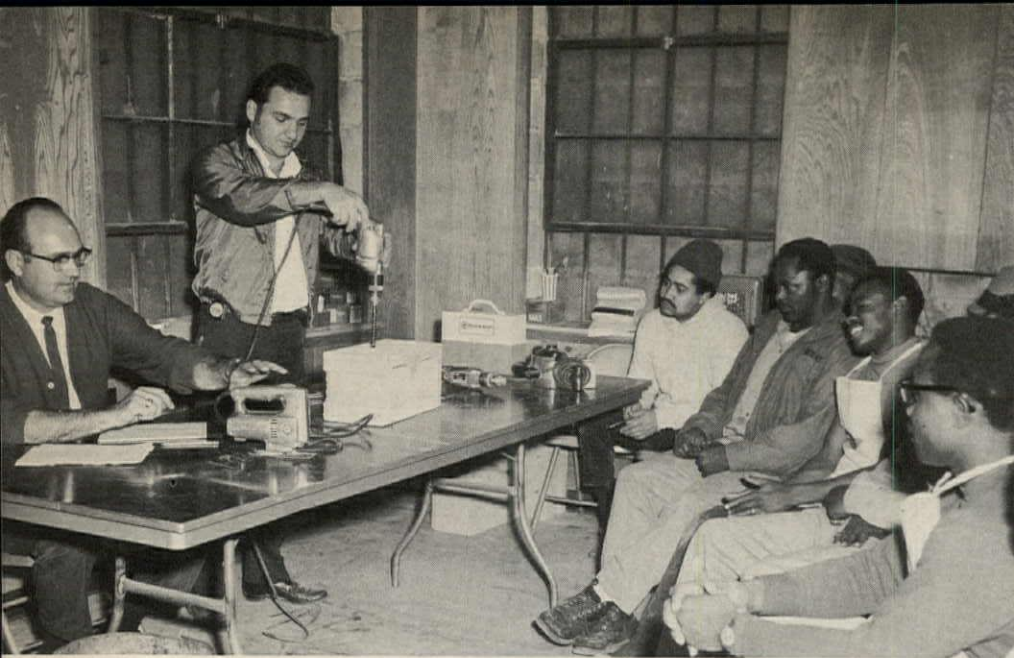

Rehab instruction for unskilled blacks combined classroom and on-job training. Some 150 trainees went on to remodel thousands of kitchens, floors, and baths.



on each subsequent project it undertakes.

Checking construction sites to see that white subs are complying with their EEO commitments. "Remember," Pinkney cautions, "if a sub isn't in compliance, then BSI is automatically not in compliance, too."

Recruiting black workers and trainees when a specific job opens up. Typically, he visits the leaders in the black community—the head of the Workers Defense League, for example—and gets the names of candidates. Later, he interviews the candidates privately and recommends some to white subcontractors.

At times, white subs come to Pinkney, asking for black construction workers to meet their minority-hiring commitments. He introduces them to job-candidate sources in the black community, later phones his sources to see how many black men were hired.

Rectifying unfair practices by BSI's subcontractors. He cites an example: "A white foreman working for a sub fired a black worker so the foreman's brother could get a job. The black man complained to me. I looked into the case and had the man reinstated. The foreman's brother was also kept. But I straightened out that foreman."

There are even times when Pinkney has to defend BSI itself against race-bias accusations. An electrical sub bids high, doesn't get the job, and charges discrimination, for example. Another sub—not on Pinkney's alert list—misses out on a chance to bid and charges BSI ignored him.

Pinkney believes—as do most observers of the minority scene—that the benefits of equal employment go well beyond the obvious giving of a job to a black man.

"The black man who is working soon becomes the black man who is living in pleasant surroundings," he says. "And the black man living in pleasant surroundings stands a better chance of becoming a more productive worker."

Outside the company, Pinkney says reactions to his activities are neither strongly positive nor strongly negative.

The black reaction: "Some people consider me an Uncle Tom, but others understand what I'm trying to achieve."

The union reaction: "I don't meet open resistance, but I've run into some union reps who get peeved because they see the



blacks taking jobs away from those good-standing union members."

The subcontractor reaction: "I guess some of them resent my work, but they never indicate it to me. In fact, they soon want to comply with the law, and they usually say to me, 'Just tell us what to do and how to do it.'"

### How BSI creates jobs for unskilled blacks: "We train them to handle rehab work"

With only three weeks of BSI training behind them, 60 men completed the following rehab job daily for better than a year:

Two men—each trained as a carpenter and as a plumber—enter an apartment kitchen at 8 a.m., dismantle the old cabinets, bust a hole in the concrete wall, take out the galvanized plumbing (which dates back to 1939), install copper plumbing, plaster the wall, put up new cabinets according to a blueprint, and leave the apartment by 4 p.m.

The project began in mid-1968 when BSI contracted with the Cleveland Metropolitan Housing Authority to remodel 12 types of kitchen in 4,904 public housing units and to train men to do the job. The trainees: hard-core unemployed from the Cleveland ghetto and Housing Authority janitors.

Later BSI won similar agreements to teach other unskilled workers to lay floor tile and to install laminated plastic paneling on bathroom walls.

BSI, the trainees, and CMHA benefited from the experience:

"We'll apply what we learned in this program to our own training programs," says Ted Booth, BSI's vice president and general manager. One lesson learned: training the hard-core unemployed is possible—and it can be done quickly. "That," declares Booth, "is a big breakthrough in conventional thinking about the hard-core man."

The black trainees ended their 16-month assignment with full-time jobs in CMHA's maintenance department. Later, some be-



Typical trainee David Sanders—seen here with wife and child—never held a steady job until he went to work for Cleveland Housing Authority, following completion of the kitchen rehab training program (see photos on opposite page) offered by BSI.

came supervisors and project managers, and a few went into business for themselves.

Conversely, CMHA beefed up its depleted maintenance department. Some of the men hired were skilled enough in kitchen plumbing to undertake a complete bathroom rehab project with little extra training.

What about the problems frequently encountered by trainers of the hard-core unemployed: absenteeism and tardiness, for example, and failure to grasp textbook instruction?

Booth says they were not a factor in the BSI program: "In the first 30 days of the kitchen program, most of the guys came in a half-hour early. And we had no problems with reading and writing because we didn't use textbooks. We showed them everything they had to learn."

BSI's training approach was pretty much the same for all three programs. Here's the way it went:

Booth was the executive administrator of the program. Reporting to him was the program manager, John Price, a black manager of warehousing and shipping at a BSI subsidiary. Under Price were two instructors—Al Bennet, a white, non-union plumber; and Ed Skok, a white, union carpenter. Price and Skok have been with BSI 13 and 8 years, respectively. Bennet was hired for the training assignment.

Weeks before the students walked into the classroom, the instructors rehearsed the rehab job.

"We installed a kitchen ourselves, making notes on what we thought were critical teaching areas," explains Skok. "Then we compared our observations and drew up an outline of the course."

The rehearsal also enabled the instructors to compile two basic lists: the materials to be used on the job, right down to the nipples, elbows, and fittings; and the necessary tools—both power and manual.

Training groups were kept small—12 to 14 men. The first class also included two experienced CMHA supervisors who would be overseeing the rehab work. They were asked to take the course so they would know what the trainees had been taught and what standards had been set.

Each class opened with what amounted to a pep talk. Its gist: this is a special project. You men will be the first black trainees ever to go out and rehab thousands of kitchens in public housing with such a short training period.

Then the men were taught how to use power tools ("Some of them had never even held a hand saw," says Skok.) They watched demonstrations by the instructors, practiced with the tools, and listened to a talk on safety by a power-tool salesman.

Next came instruction in rehab skills. And this included the remodeling of a kitchen in the classroom. Two weeks after starting the course, the trainees, who had now formed two-man crews, moved out to the job for the final week of instruction.

Based on their observation of each trainee, the instructors reorganized some crews, pairing slower worker with slower worker and faster worker with faster worker in the interest of crew harmony.

On the first day, three crews installed a kitchen apiece under supervision while the remaining three crews watched. The second day, the roles were reversed.

At week's end, each crew was able to remodel a kitchen in one day. Subsequently, some crews were able to complete two kitchens in a day.

The learning process was not a one-way street. Booth and his training team came out of the program with a keener understanding of the hard-core unemployed.

"Typically, the trainee is scared," Booth says, "because he doesn't know what he can actually do. And some men are so scared that they drop out of the program without giving themselves a fair test." So Booth advises: "Praise them for their willingness to learn, and never reprimand them for their inability to learn. If you make a mistake, admit it to the class. And, above all, be



Blacks and whites build together at two Cleveland housing projects joint-ventured by black general contractor Percy Johnson (photo on opposite page) and BSI. The projects: Park Place I and Central Park West.



consistent—support the trainees when they're right; discipline them when they're wrong."

What do you do with the men who treat the training as a joke? Says Booth: "Either they knuckle down or out they go."

### How BSI builds business for black subcontractors: "We get white subs to joint venture with them"

The joint venture program is aimed at helping black subs gain the experience they need to compete successfully, Pinkney says.

"A black sub's experience is limited to a small job," he explains. "So he avoids bidding on major housing projects. Or he bids too high or too low because he knows little of the rudiments: how to determine the number of men needed; how to schedule work; how to buy supplies in large quantities, and so on."

Under the BSI-sponsored joint venture: the white sub pays all expenses, including the entire payroll; and some of his men train the black sub's employees.

The black sub takes roughly 25% of the venture's net profits initially—when he's totally inexperienced. As he learns, his percentage of the profits will increase.

Why would a white sub get involved in a deal like that?

Some don't because BSI doesn't always insist on it. Others don't because they can earn more elsewhere.

But white subcontractors who need the work badly sign up. So do the subs who like the promise of still more jobs that cooperation brings.

There are no second chances, however. Rothenfeld says BSI won't engage a white sub on any job not requiring affirmative action if that sub has earlier turned down a joint-venture proposal. "He cannot pick and choose," Rothenfeld says.

To make joint venturing more palatable, Pinkney says he'll help any white sub who wants to take advantage of the federal government's subsidized training programs under Section 404 of the 1969 Housing and



**Joint-venture participants**—Percy Johnson, a black general contractor who heads Kinsdale Construction Co., and Walter Zaremba, BSI vice president—at one of their construction sites—a \$2.4-million townhouse and apartment project.

Urban Development Act. The subsidy money is paid to the white contractor, helps him offset his payroll expenses. The amount of subsidy paid depends on how experienced the trainee is. (The less experience, the higher the subsidy.)

BSI itself also joint ventures with blacks. Its most successful venture thus far has been with a black general contractor: Percy Johnson, who heads Kinsdale Construction Company in Cleveland (see photo at right).

BSI pays Johnson a fee for supervising the construction plus 25% of each job's profits. In addition, BSI lines up the jobs, assists Johnson with estimating and cost control, and handles all of his accounting.

When Johnson was introduced to BSI of-

ficials two years ago, he was a successful general contractor who couldn't get more than a half-million performance bond because he had limited equity.

"I could get the \$200,000 church or the \$500,000 remodel," Johnson reminisces.

"But I could never get that \$2.4 million Park Place."

Johnson's first joint venture job with BSI: seven family-unit houses (some single, others duplex) for CMHA in a black neighborhood in Cleveland.

Since then, Johnson's firm has completed \$6 million worth of housing in cooperation with BSI. "Today," says Johnson, "I get as much bonding as I need." Rothenfeld pegs his capacity, "backed by us," at about \$5 million.

Johnson admits that when he started his affiliation with BSI, the relationship was a one-way street, in his favor. "But now it's a two-way street," he contends. "I'm good for BSI just like it was good for me. BSI wouldn't get those buildings built without black people." —JOHN KIRK

## In a city with more than its share of urban ills . . . . . here's what key people are saying—and doing—about job equality

Plagued by racial friction, high unemployment in the building trades, and water pollution that threatens to halt all construction, Cleveland nervously awaits a pickup in the nation's economy to solve its problems.

Against that backdrop the following spokesmen offer their observations on equal employment opportunity:

*John Cole, the city's contract compliance officer, prods builders into hiring blacks on housing projects. Cole, a black man who works for an understanding black mayor, accepts no excuses that the unions have no blacks.*

"We pressure the builders," he says, "by telling them we don't care where they get the blacks—from the hiring hall or off the street—just as long as they're on the job and getting equal pay."

Cole concedes that such pres-

sure "saddles the builders with one hell of a problem. Once the builders start making demands on the unions, the unions will start sending them 'bums' [low-producing workers] or more men than they requested."

*Raymond Mooney, the NAACP's Cleveland director, thinks BSI's job-equality program is headed in the right direction, and is also pleased that the company hired a black EEO officer ("He's on our side!").*

But, he says, the BSI program doesn't go far enough. What's needed is more hiring of black skills and the development of more black general contractors like Percy Johnson (*photo above*).

Mooney is particularly concerned about the inability of black subs to get adequate performance bonds when they seek to undertake a project on their own. "Unless a black

sub joint-ventures with a white sub, he can't get the bond to do the job," Mooney charges. He promises an investigation of the bonding companies on grounds that they're prejudiced. *A spokesman for the Cleveland Building and Construction Trades Council, representing 19 unions, reports the Council has just conceived a hometown plan to bring more black labor into construction. Its five-year goal: to raise the number of minority group employees in each craft to a level proportionate to their percentage of the Greater Cleveland labor market.*

The plan establishes a permanent office and a full-time board to work on minority hiring in both private and public construction.

It has been approved by the U.S. Labor Dept. and by the leaders of three local groups—the Urban League, Building

Trades Employers Assn., and Workers Defense League.

Next, the plan must be accepted by the membership of both the unions and the three local groups.

Once approved, the spokesman says, some 18 months will be needed to get the plan operating.

*An Urban League spokesman is pessimistic about the Trades Council plan: "Sure, the union officials say they'll push for this. But we've seen too many promises made and then not fulfilled."*

He is surprised that the unions think 18 months will be needed to get the plan working, and hopes for some changes in employment practices in six months.

Delays, he says, will only indicate to unemployed blacks that the plan is just another game being played by the white man.

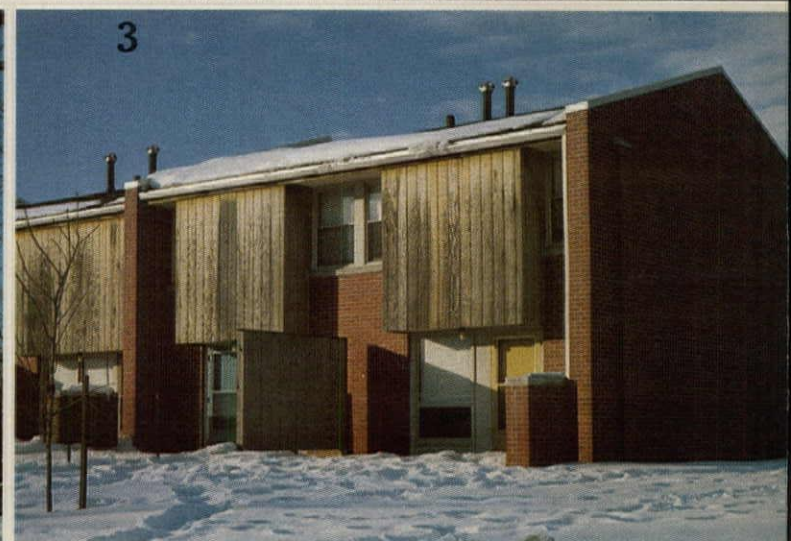

# Why high-quality Andersen Windows belong in low-income housing.

If you're planning a public housing project, Andersen Windows are more practical on a total cost basis.

Made in complete units, they cost less to install. And there's no on-site exterior painting when you specify our Perma-Shield® Windows. Made with a thick vinyl sheathing on the outside, these windows will save significantly on maintenance costs over the years. They won't need scraping, painting or refinishing.

Fuel costs are lower. Andersen Windows are made with a solid core of wood—one of nature's best insulators. Our weathertight construction and welded insulating glass (optional) complete the tight design against heat, cold, dust and drafts.

Andersen Windows will cost less over the long run, and their beauty lasts as long as the building. That's why it pays to specify the best.

## 1. Minneapolis Housing for the Elderly

The architects wanted to make this large, 290-unit housing project into a real "home" for the residents. So Bettenburg, Townsend, Stolte and Comb, Inc. created a living community with friendly courtyard and recreation areas.

Adding warmth and pleasantness to the surroundings are Perma-Shield Fixed and Casement Windows equipped with welded insulating glass which seals out cold Minnesota winters and keeps residents snug and warm.

## 2. Columbia Court Public Housing

Precast concrete "shadow panels" give this 90-unit complex in Muskegon Heights, Michigan its distinctive look.

The architects, Haughey, Black & Associates, designed special recesses into the panels where Perma-Shield Casement windows fit snugly.

The white vinyl sheathing on the outside blends well with the smooth-surfaced concrete. These windows can be opened straight out, allowing elderly residents to clean both surfaces from the inside—another cost-cutting benefit of Andersen Windows.

## 3. Family Housing Project

Hackner, Schroeder, Roslansky & Associates received an award from the Wisconsin Chapter of the A.I.A. for this series of townhouse groups in La Crosse, Wisconsin.

They were cited for the use of materials which added dignity and distinction to these low-cost dwellings. Among the materials used were Andersen Beauty-Line™ and Narroline™ Windows.

Beauty-Line windows combine a fixed upper sash with a ventilating, awning-style lower sash. They can be used singly or in groups, making them as versatile as they are attractive.

## 4. Award-winning Low-Rent Apartments

Located in Herman, Minnesota, this group of one-story 4-plexes received an award from the Minnesota Chapter of the A.I.A. for being the best representative example of the theme of "Involvement."

The architects, R. F. Ackermann and Associates, carried the residential character of the neighborhood into these apartments with a warm and simple design.

Adding to this feeling are graceful gliding doors by Andersen. They open onto comfortable, private decks. Andersen Beauty-Line Windows provide picture window beauty at a practical price.

For more information on Andersen Windows and Gliding Doors, check your Sweet's file or contact your nearest dealer or distributor.

**Andersen Windows™**  
Window beauty is Andersen. Andersen Corp., Bayport, Minnesota 55003



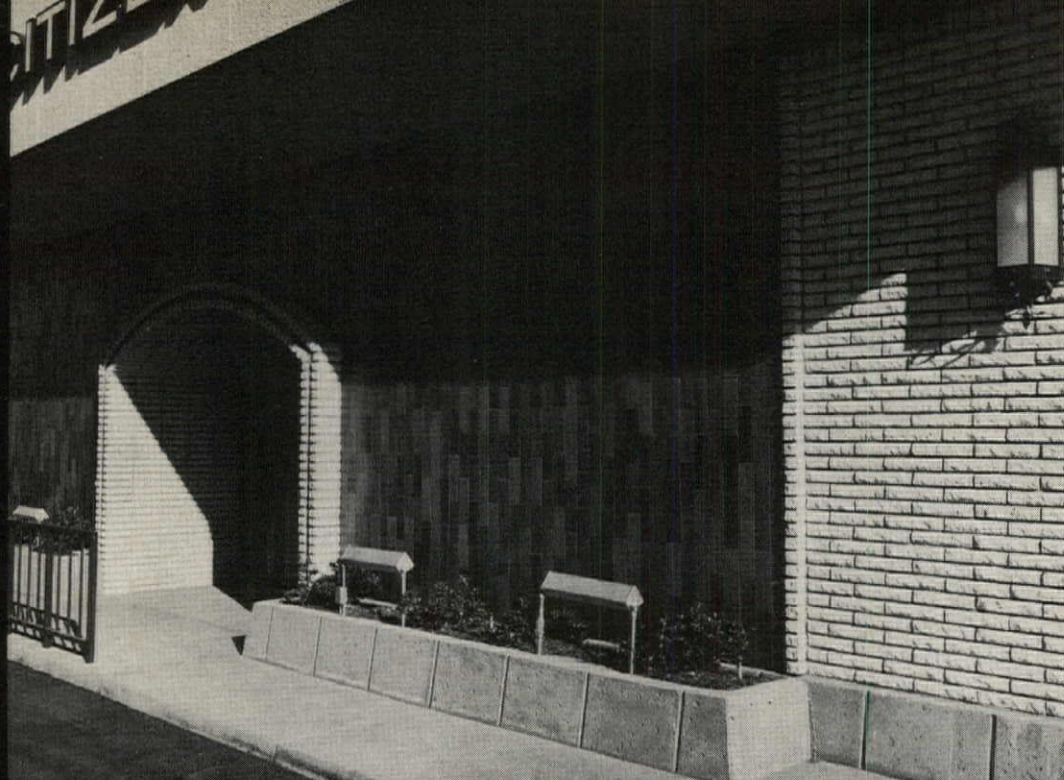

what is  
the aesthetic range  
in carpet  
for a  
**bank**  
**clinic**  
**restaurant**  
**motel?**

**BERVEN OF CALIFORNIA'S**

newly published color catalog  
and specifications guide  
details  
*the beautiful way  
to be practical*

8 pages of textural/color recommendations  
highlighting the broad range of the Berven Of  
California line. Select from tight weaves, provocative  
textures and imaginative color theming for  
both residential and commercial installations.



B E R V E N



Send for this free 8-page library reference Catalog

General and Administrative Offices:  
2600 Ventura Ave., Fresno, CA 93717.

Chicago (312) 644-9110; Cincinnati (513) 721-4462; Dallas (214) 742-6231; Denver (303) 255-2066; Detroit (Ferndale) (313) 546-8846; Fresno (209) 268-0771; Honolulu (808) 946-5071; Houston (713) JA 6-1331; Los Angeles (213) 749-7641; Miami (305) 759-4649; Minneapolis (612) 339-7195; Verona, N.J. (201) 239-8602; Orange, CA (714) 835-8505; Phoenix (602) 266-3100; Portland (503) 235-8471; Sacramento (916) 452-4385; San Francisco (415) 421-5001; Seattle (206) 682-7196; Spokane (509) MA 4-4118.

Dept. HH 2600 Ventura Ave., Fresno, CA 93717

Please send \_\_\_\_\_ copies of your free color catalog.

YOUR NAME: \_\_\_\_\_

TITLE: \_\_\_\_\_

FIRM: \_\_\_\_\_

TYPE:  Architect  Builder  
 Interior Designer  Building Management.

Other \_\_\_\_\_  
(PLEASE SPECIFY)

ADDRESS: \_\_\_\_\_

CITY: \_\_\_\_\_

STATE: \_\_\_\_\_

ZIP: \_\_\_\_\_

PHONE: \_\_\_\_\_

CIRCLE 104 ON READER SERVICE CARD

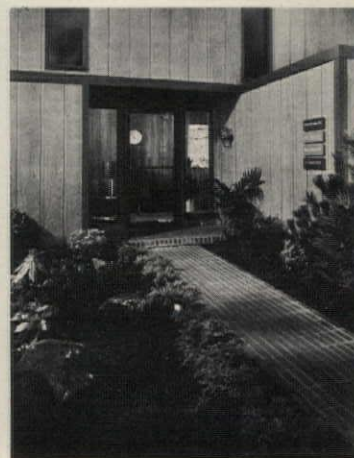

**Long-scarce cypress is now available as the facing on plywood siding**

The exteriors above—one residential, the other commercial—show the striking grain of cypress wood. But only the face ply is the real thing. It is bonded permanently to plywood panels and will weather as well as traditional cypress planks. Until some decades ago when it

became scarce, cypress was used everywhere—from sailing ships to siding—because of its immunity to moisture, decay, and insects. In fact, 250-year-old buildings in St. Augustine, Fla., still have their siding. The face ply on this paneling has the same protective oils,

so it can be colored with semi-transparent stain or left to weather a silvery gray. Panels are 4' x 8', 9', or 10'; come in saw kerf, T 1-11, reverse board-and-batten (*above left*), or plain board-and-batten (*right*). Boise Cascade, Boise, Idaho. CIRCLE 259 ON READER SERVICE CARD



**Packaged redwood decking** comes in pre-assembled 3' or 4' squares made of 2 x 4 surfaced redwood lumber. "Reddi-Deck" squares can be used singly or together, all in one direction or in alternating directions as shown, for patios, staggered steps, or sun decks on balconies or rooftops. Framing is extended so squares interlock; lumber is spaced 3/16" apart for drainage, and weather-resistant nails don't show. Georgia-Pacific, Portland, Ore.

CIRCLE 260 ON READER SERVICE CARD



**Super-size bathtub**, literally a bathing pool, measures 5½' x 7', and it is one seamless piece of warm-to-the-touch fiberglass. The oval bathing area has a sculptured edge and leaves seating space at the four corners. Tub can be installed on a platform as shown or sunken in floor, has a 4"-high lip. "The Bath" comes in gold, avocado, sand, white, and a bold blue. Single or dual controls and showerheads in various finishes. Kohler, Kohler, Wisc.

CIRCLE 261 ON READER SERVICE CARD

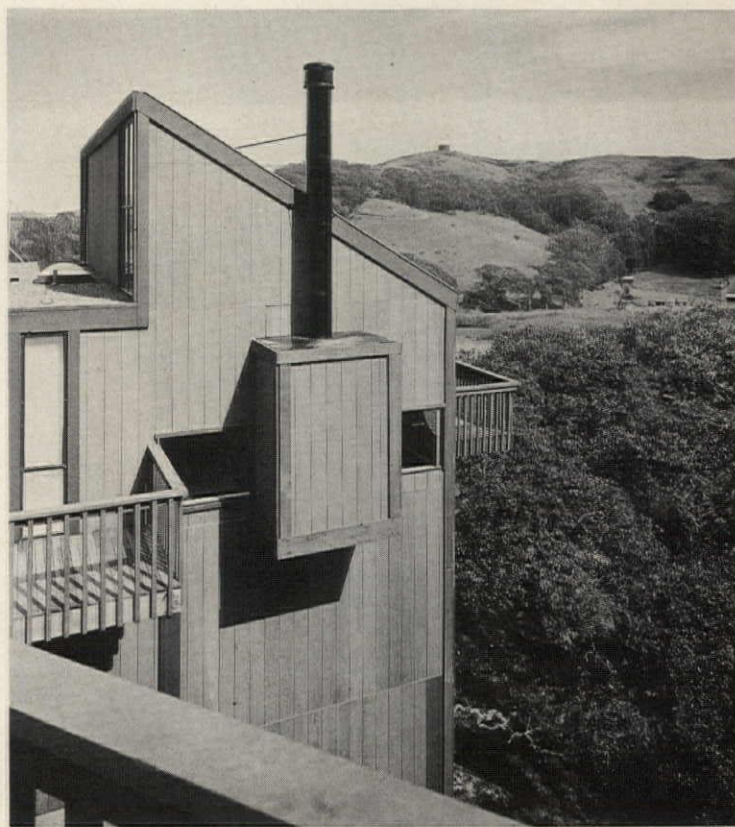

**Redwood plywood** is shown on award-winning house by architects Fisher-Friedman Assocs. and builder Allan-Marin in Mill Valley, Calif. (H&H, Sept. '70). Resawn plywood panels have a T 1-11 pattern and are trimmed in dark-stained red-

wood lumber. Panels are 4' x 8', 9', or 10' in inverted battens 12" o.c., T 1-11 patterns 4", 8", or 4" and 12" o.c., or plain, in saw or brush texture. California Redwood Assn., San Francisco, Calif.

CIRCLE 262 ON READER SERVICE CARD



**Rough-sawn siding looks rustic, retards fire**

The board-and-batten exteriors above are cedar plywood that has been impregnated with fire retardant chemicals. The rough-sawn texture is unchanged, so these townhouses have a warm, natural look in their wooded setting. But the chemicals so effectively protect the

wood that it will not support fire and has been given UL's highest fire retardant rating. The "Non-com" treated siding is being used by Lincoln Properties in a 280-unit St. Louis project. Koppers, Pittsburgh, Pa.

CIRCLE 251 ON READER SERVICE CARD

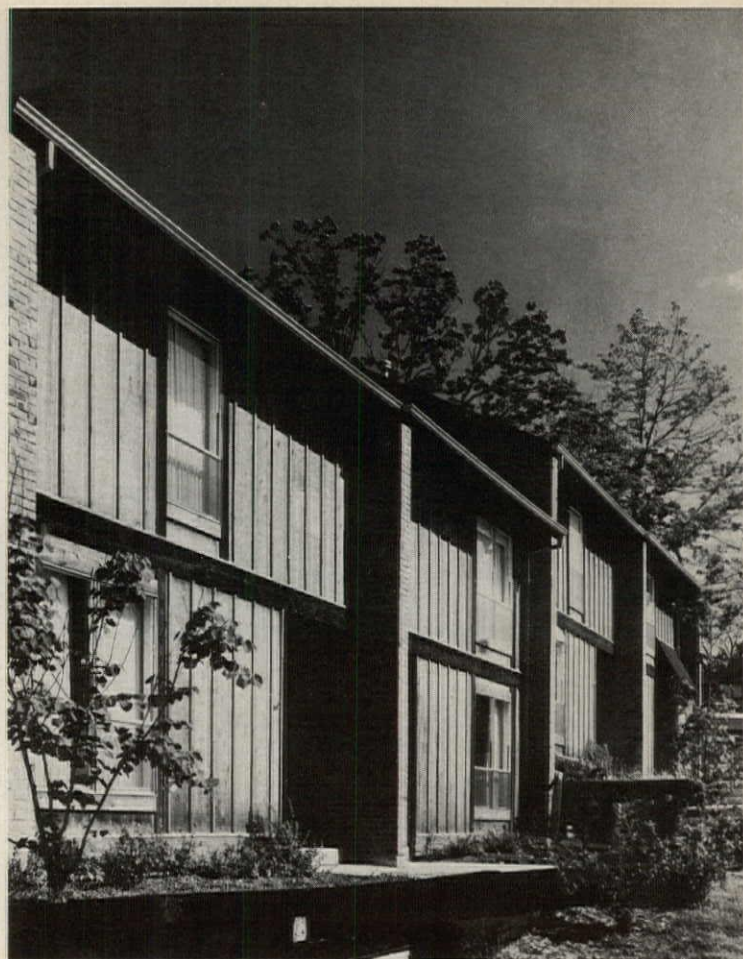

Vinyl flooring has factory-cut edges spaced to match pattern. Seaming liquid and vinyl sand are poured into the space and excess sand wiped away so edges are permanently welded and seam doesn't

show. "Winfield" pattern of small octagons and squares set in larger octagons contrasts slate and lizard finishes. Black or white. National Floor Products, Florence, Ala.

CIRCLE 252 ON READER SERVICE CARD

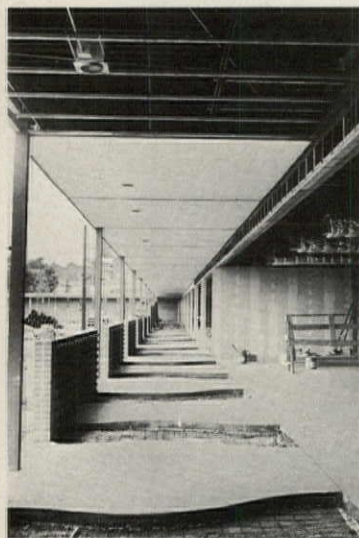

**Exterior ceiling board goes up like drywall**

Designed for use on exterior ceilings not directly exposed to the weather, such as the covered walkway shown above, the 4'-wide panels go up as easily as drywall. They may be nailed or screwed to metal or wood studs or furring strips. Joints can be finished with metal

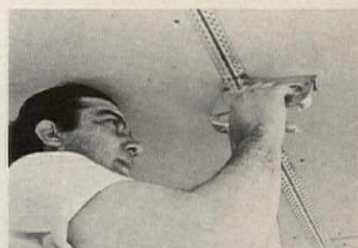

trim, matching metal moldings, or joint compound, as the photos at right show. Panels are 1/2" thick, have a fireproof gypsum core and grain-free surfaces treated to repel moisture, and can be used up to 12' long. U.S. Gypsum, Chicago.

CIRCLE 253 ON READER SERVICE CARD



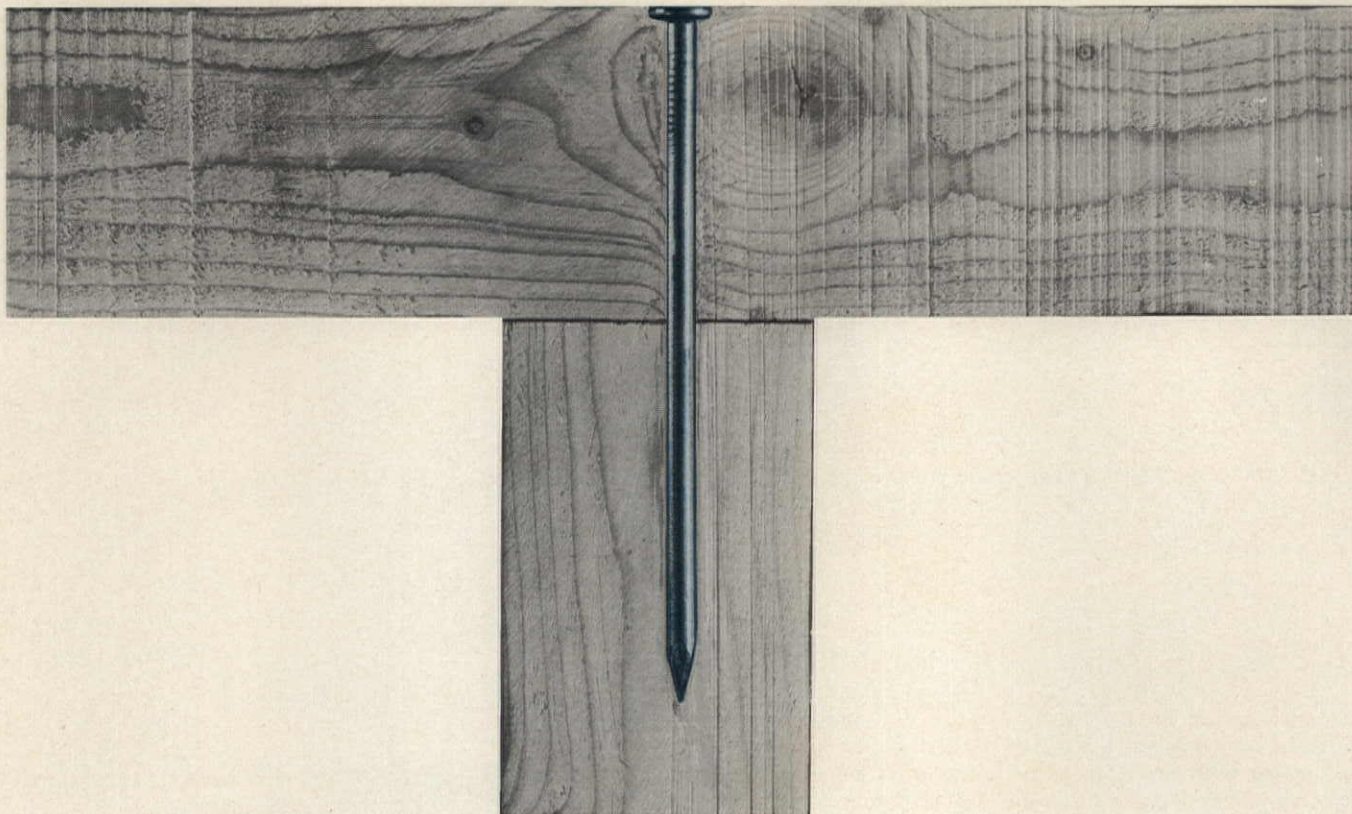

## What's uncommon about 16d common nails?

Quick-loading cartridge holds 120 16d common nails. Cartridges of 16d box or sinker nails also available.

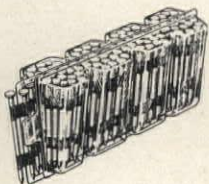

**Paslode Stallion®** drives as many as 5,000 nails an hour, weighs 11 pounds, operates on compressed air at 80 to 100 psi. Safety bottom trip is standard.

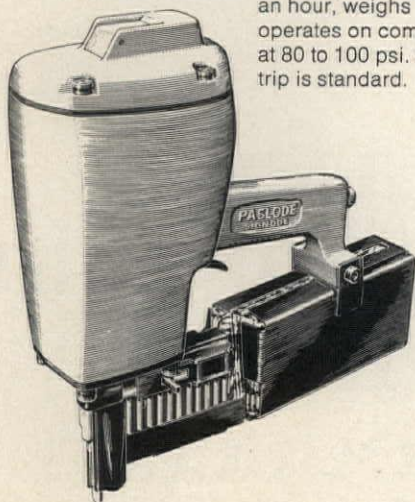

■ Two things. First, Paslode's 11-pound *Stallion*® is the only portable pneumatic nailing tool that will drive "genuine" 16d commons—3½" long by .162" diameter, per Federal Specification FF-N-105a. And the *Stallion* drives them home with a single blow, at the rate of up to 5,000 nails per hour.

Second thing: Strength. That .162" diameter gives 16d commons greater shear strength than other 3½" nails. That's why commons are called for in many different construction and industrial standards and specifications, including FHA Minimum Property Standards.

Also important, Paslode 16d cartridge-fed nails are *Pascote*® coated for increased holding power.

If your job requires the strength of 16d commons, it will pay you to talk to Paslode. In fact, if you drive any kind of nails in quantity it will pay you to talk to Paslode. Let us send you free literature on the Paslode line of heavy duty nailing and stapling tools, and a cost of nailing calculator.

**PASLODE®**  
 COMPANY, DIVISION OF SIGNODE®  
 8080 McCormick Blvd., Dept. HH, Skokie, Ill. 60076  
 In Canada: Paslode Canada Registered

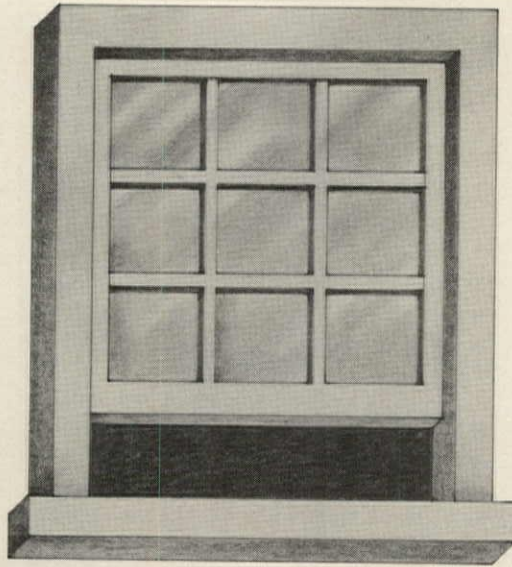

**Not long ago, a few  
people began experimenting  
with Geon vinyl  
for building products.**

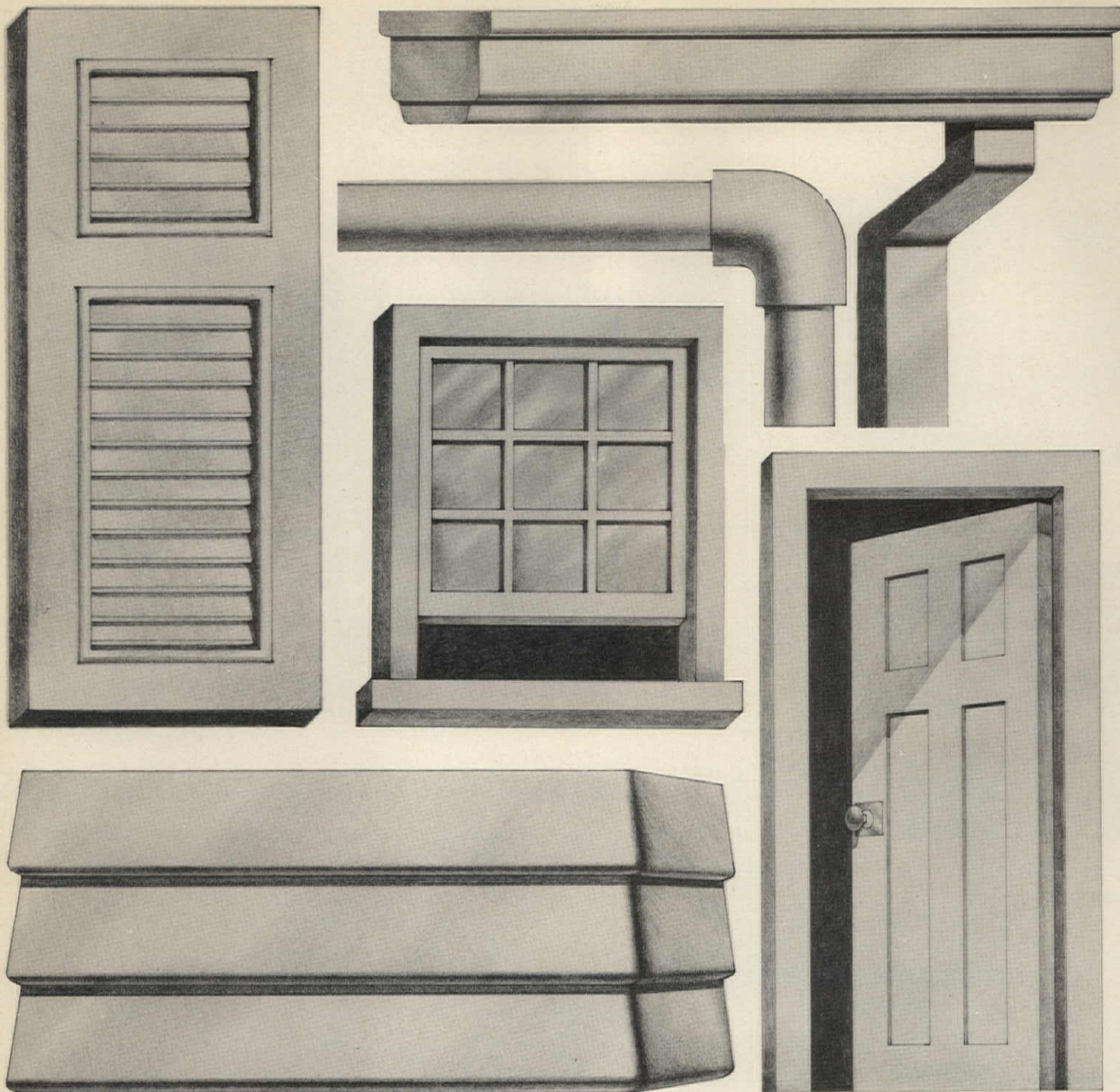

# Eureka.

Vinyl building products caught on in a hurry.

Today there are at least five major manufacturers using our Geon® vinyl for windows. Windows that stay warm and need no painting. Seven or more using Geon vinyl for siding that resists denting, retains a soft, even color. Siding that can be horizontal, vertical or look like stone.

And there are scores of people using Geon vinyl to make hot and cold water pipes, drain pipes, shutters, gutters and downspouts, entrance ways, venting systems, corner beads, cabinet door frames, prefinished

moldings, paneling trim, weatherstrip and more.

The buyer of houses today likes the maintenance-free beauty that vinyl gives him. And you can't get too much of a good thing like vinyl.

**B.F. Goodrich Chemical Company.** The people who started it all in vinyl. Dept. H-23, 3135 Euclid Avenue, Cleveland, Ohio 44115.

**B.F. Goodrich** *...in pursuit of excellence*

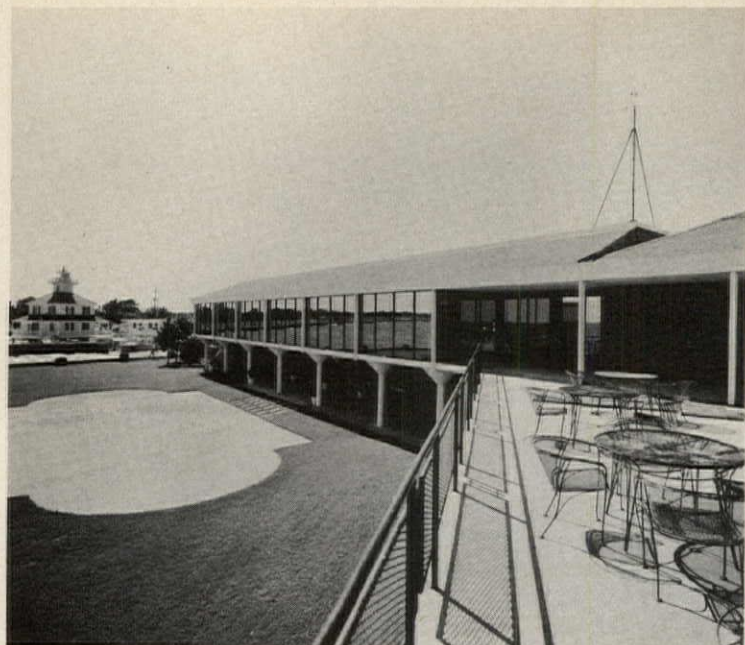

**Sun control glazing cuts both heat and glare**



The reflective glass shown above and at left can substantially reduce interior heat—and thereby air conditioning costs—and glare. A transparent weatherproof metallic film, tinted bronze, coats the outside of the glass and cuts visible light by 39%. On a hot summer day of 230 Btus of solar energy an hour, "Solar-cool" reduces heat gain to 135 Btus (vs. 200 for clear glass). For single or double glazing, PPG Industries, Pittsburgh, Pa.

CIRCLE 254 ON READER SERVICE CARD



**Built-in vacuum system** comes in three models: for medium to large new homes; for small to medium new homes, garden apartments, townhouses, or condominiums; and for existing homes. "Super-Vac" power units go in basement, attic,

or garage, are connected to inlets by vinyl tubing through walls, floors, or ceilings, may be vented to outside, and need emptying only three or four times a year. Tappan, Mansfield, Ohio.

CIRCLE 256 ON READER SERVICE CARD



**Electronic calculator**, small enough to fit in an attache case (above) or a pocket, measures only 4" x 6½" x 3" thick, weighs just 1½ lbs. Ten-position keyboard, eight-place answer display panel with automatic decimals and minus signs, and a rechargeable battery. Four circuits (right) are only ¼" in size. Sharp Electronics, Paramus, N.J.

CIRCLE 255 ON READER SERVICE CARD

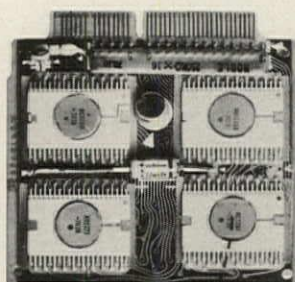
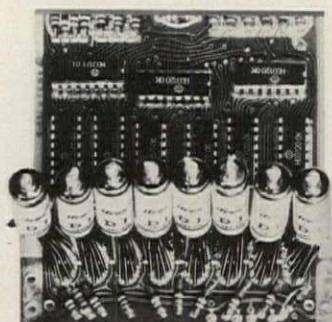

magnified  
view  
of  
ELSI-8

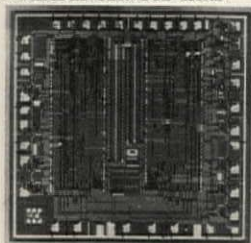

actual size  
of ELSI-8

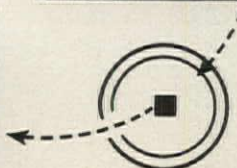

**Redesigned insulation packaging** now has plastic handles that make batts easy to lift, as the girl above demonstrates, and comes in brown basketweave pattern. Handles are color coded for insulation widths. Insulation may be applied as shown or overlapped on studs, since product is identified only on edges. Certain-teed, Valley Forge, Pa.

CIRCLE 257 ON READER SERVICE CARD



**Corner prefab fireplace** is 30" square. If brick is used behind the fireplace as shown, the unit can be placed as close as 6" to combustible walls. "Fire Diamond" comes with lift-off screen, can be ordered in matte black or one of ten porcelain enamel colors, is 28" high. The 8"-dia. chimney is 96" long. Malm, Santa Rosa, Calif.

CIRCLE 258 ON READER SERVICE CARD

# The Great Indoors System. One installation leads to another installation.

Give the homes you build all the comforts of home. With Bryant's totally integrated system of heating, cooling, air cleaning and humidification.

It will make your homes more saleable. Start with a Bryant Quietline<sup>®</sup> gas, oil, or electric furnace, and you're on your way to The Great Indoors.

Add on a Bryant gas or electric air conditioning system. Bryant dealers offer both options. In Quietline<sup>®</sup> models.

Then add a Bryant electronic air cleaner for a cleaner, healthier home.

And a Bryant power humidifier for

a more comfortable, static-free heating season.

Or to save space inside, install a Bryant outdoor cooling-heating unit.

Bryant gives you a lot to choose from. Naturally every component matches every other component. They were made for each other. All this, and quiet too.

So go on, install the Great Indoors System. You can't beat it. Especially when you join it.

Bryant Air Conditioning Company,  
7310 West Morris Street, Indianapolis,  
Indiana 46231.

**bryant**<sup>®</sup>  
The Great Indoors<sup>®</sup> People

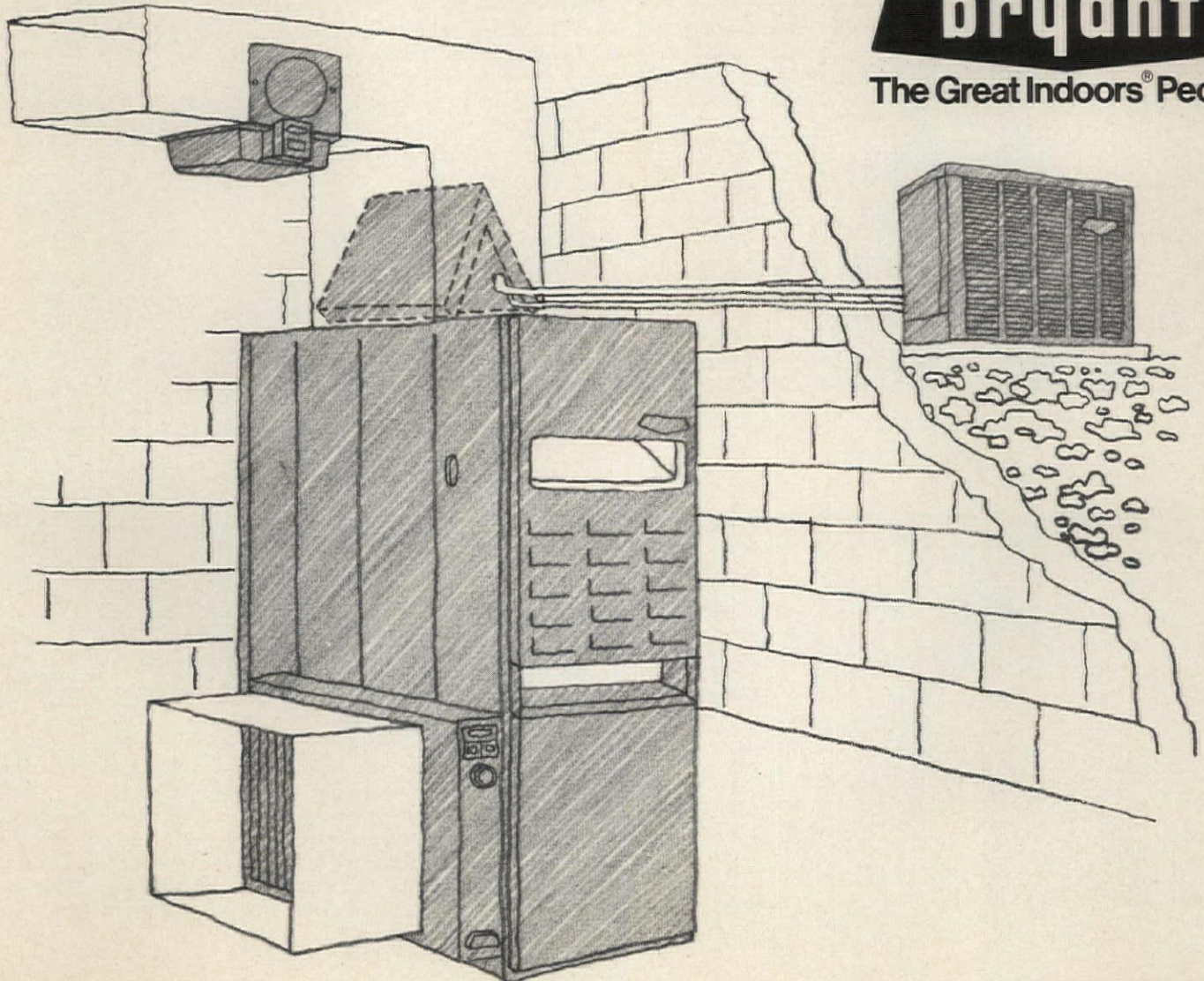

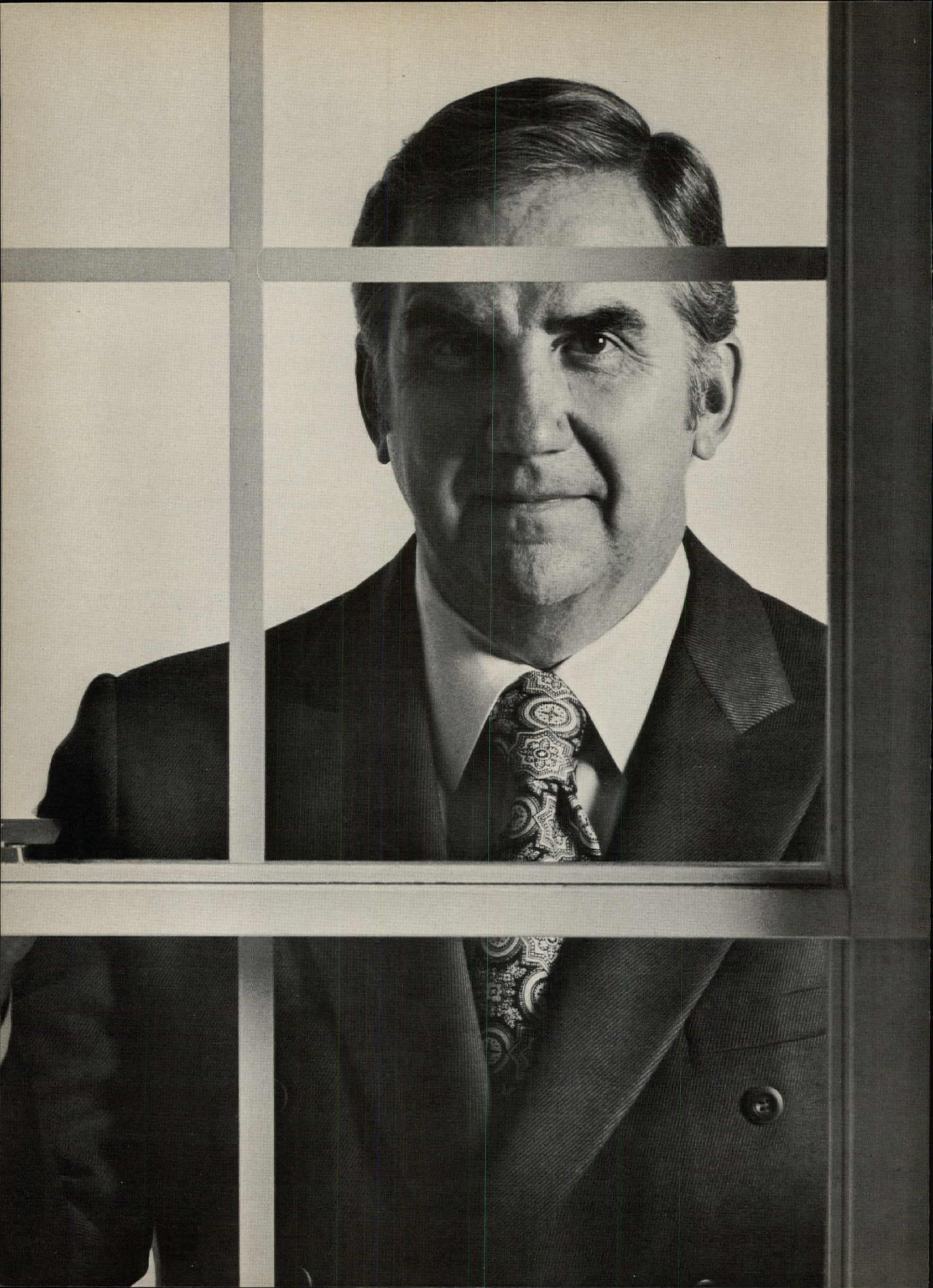

# Your new salesman calls on 8 million prospects every weekend.

That's a lot of salesmanship. And Ed McMahon's doing it to help you, by pre-selling your customers on the quality features in a home. And the beauty of Ponderosa Pine wood windows and wood panel doors, too.

Ed's hosting a new guest interview program, "Celebrity Homes", sponsored by the members of Ponderosa Pine on NBC Weekend Monitor. Every Saturday and Sunday from April 3 to May 16, millions of people are hearing Ed's guests talk about homes and home decorating ideas. They're also hearing some useful tips that'll help them see the quality in the houses and apartments you build. Like the quality of wood windows.

#### He's talking your customers' language.

A recent consumer survey showed the popularity of wood windows has grown by 10% in the last two years, while the popularity of metal windows fell by 10%. It showed some of the reasons, too. People consider wood windows more versatile and better looking than metal. And there's a growing awareness that wood windows cut condensation and provide better insulation. So more people these days expect to see wood windows in the higher-quality, better-built homes.

#### Wood windows are great insulators.

Wood makes good homes better for several reasons. First, wood is a poor conductor of heat. So wood helps prevent heat loss. Modern wood windows, with insulating glass, control temperature so well that no storm windows are needed. And that's an extra bonus of convenience any

home buyer will appreciate.

Since wood windows don't transmit heat—or cold—like metal windows do, they cut down on condensation. When it's cold

outside, metal windows get cold inside—and condensation runs down on window-sills, walls and drapes. Wood windows stay warm—and dry—on the sash inside.

#### Humidity control is a good selling point.

Wood windows allow your customers to enjoy the extra benefit of humidity control, without worrying about messy condensation. This is the age of the tight house. And wood windows are an important part of that kind of construction.

#### The new wood window.

Modern wood windows are precision fitted, and engineered so they open and close easily. They're chemically treated to last a house-time. And they're fully weather-stripped to prevent annoying drafts.

#### Here's something else to sell.

Wood windows are designed to be cleaned more easily. Some have snap-out grilles to create the effect of segmented windows, but offer the convenience of cleaning one big window instead of lots of little ones. Some windows pivot so the outside turns in for cleaning. Still others let your customer take the sash out of its frame, wash it, and put it back in just a minute or two. These are benefits any homeowner will understand—and expect.

#### Tune in with your customers.

This spring, on "Celebrity Homes", sponsored by the members of Ponderosa Pine Woodwork, Ed McMahon is constantly reminding your customers why they should insist on wood windows and wood panel doors.

Keep your radio tuned to NBC Weekend Monitor. You'll see what we mean.



**Ponderosa  
Pine** Woodwork

39 S. La Salle Chicago, Ill. 60603

A member of the American Wood Council



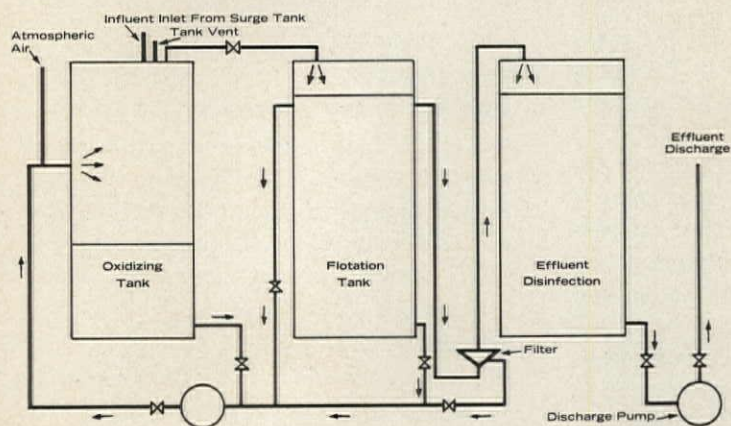
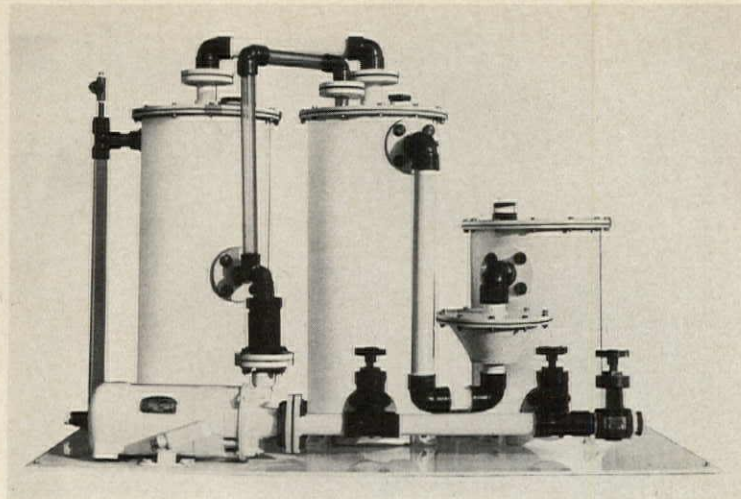

**Modular automatic waste treatment plant**

The packaged system above, shipped palletized, is ready to operate. Treatment process is completely enclosed, and the only moving part is a pump, so little maintenance is required and no supervision is needed. Controlled oxidation process takes in air from atmosphere

(at left in drawing) to speed up oxidation, handles up to 8,000 ppm suspended solids, 1,900 ppm BOD. Units, packaged to handle from 1,750 to 50,000 gpd, or from five to 50 houses are compact. Aquanox, Englewood Cliffs, N.J.

CIRCLE 201 ON READER SERVICE CARD

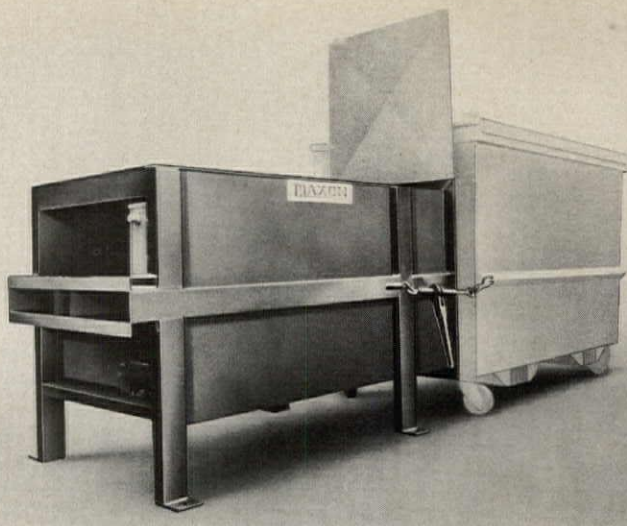

Refuse compactor has 1/2-cu.-yd. capacity, hydraulically compacts trash to 1/5 normal size in 3- and 4-cu.-yd. bins that can be hauled away. And it operates on just 110-v. current. Useful for apartment projects, as

well as stores and restaurants, because it saves container space, reduces number of garbage pickups per week. Maxon, Huntington Park, Calif.

CIRCLE 202 ON READER SERVICE CARD



Gas incinerator is designed to produce no odors and no smoke. A jet flame from the front of burner into combustion chamber consumes food wastes and trash. A second flame from the rear part of burner creates intense heat through which burnt products must pass on the way to the flue. This "after-burner" consumes smoke and odors. Unit holds 1 1/2 bushels, or an average day's waste for a large family. Locke Stove, Kansas City, Mo.

CIRCLE 203 ON READER SERVICE CARD

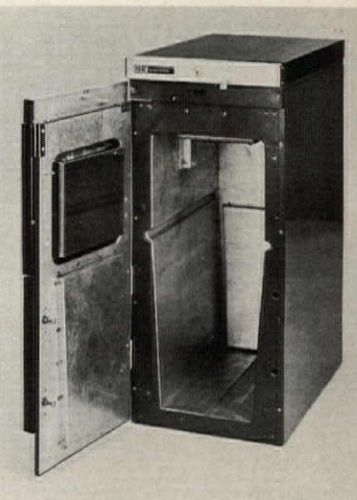

**A household trash compactor with its own slide-out waste can**

Both the freestanding model shown above and a built-in unit, not shown, operate the same way: all trash is put through the tilt-down front panel until a certain amount accumulates. Then a key is turned (left), the control lever moved over,

and the door pressed in to start the hydraulic ram. When one cycle is complete, unit shuts off automatically. After several cycles have been completed and trash bag is full, the front door is opened wide, and the basket slides out to be carried away to the garbage can or the garbage pickup spot. Before the unit

is used again, both the plastic basket and the stainless interior can be thoroughly washed. Both models come in avocado, gold, copper, and white, and the free-standing model has a mar-resistant vinyl top. In-Sink-Erator, Racine, Wis.

CIRCLE 204 ON READER SERVICE CARD





# How do you give your customers that special effect *for little or no extra cost?*



1.



2.



3.

You can dress up your new construction with the rugged enduring beauty of stone by spending about \$1.00 more per square foot than you do for face brick. In-the-wall costs vary by area, but one ton of FEATHEROCK Veneer equals the coverage of five tons of other stone. Special footings are unnecessary, and the light weight along with flat back make FEATHEROCK go up faster. Acoustical and insulation values are plus benefits.

Send in the coupon opposite to get more information on how FEATHEROCK can help you give your client that extra special look at a cost that will please him.



**featherock**<sup>®</sup>, INC.

6331 HOLLYWOOD BOULEVARD  
LOS ANGELES, CALIFORNIA 90028

1. Interior using Featherock bold face veneer.  
Color: Charcoal  
Residence: Mr. & Mrs. Jack Burns,  
Reisterstown, Maryland
2. Exterior using Featherock bold face veneer.  
Color: Charcoal.  
Residence: Mr. & Mrs. Bob Brockett,  
Modesto, Calif.
3. Interior using Featherock bold face veneer.  
Color: Charcoal.  
Residence: Mr. & Mrs. Bob Brockett,  
Modesto, Calif.

Please send me technical data on Featherock  
Dept. HH 5-71

Name \_\_\_\_\_

Firm \_\_\_\_\_ Position \_\_\_\_\_

Address \_\_\_\_\_

City \_\_\_\_\_ State \_\_\_\_\_ Zip \_\_\_\_\_

## The first half of a pickup costs the most.



There's only one reason why anyone buys a pickup.

To carry a load.

And if it doesn't do a good job of that, all the chrome headlight rings, vinyl tops and door-to-door deep pile carpeting in the world won't make it a better truck.

But it's impossible to figure out how a truck's going to behave under loaded conditions when you're at the dealer's with an empty pickup.

All you can do is look for certain things. If you look for the right things, that's enough.

For riding with no loads or light loads, look for a suspension system that smooths out a road's rough spots. A torsion bar suspension. There's an INTERNATIONAL that has it as standard equipment.

For heavy loads, you'll need leaf

springs all around. They'll give you twice as many points of suspension as an all-coil system.

Most International pickups come with leaf springs all around.

So you and your load will ride with a little more stability and a little more safety.

To take care of a heavy load in back, look for a truck engine up front. Not a car engine. A truck engine. One that's made to give you maximum torque, economy and long life.

All of the V-8's available in the International fit these requirements—because they're the same engines we bolt into our big, gas-engined highway rigs. And the GVW on those trucks runs upwards of 27,500 pounds.

A vital link between the power up

**But the last half  
is more important.**

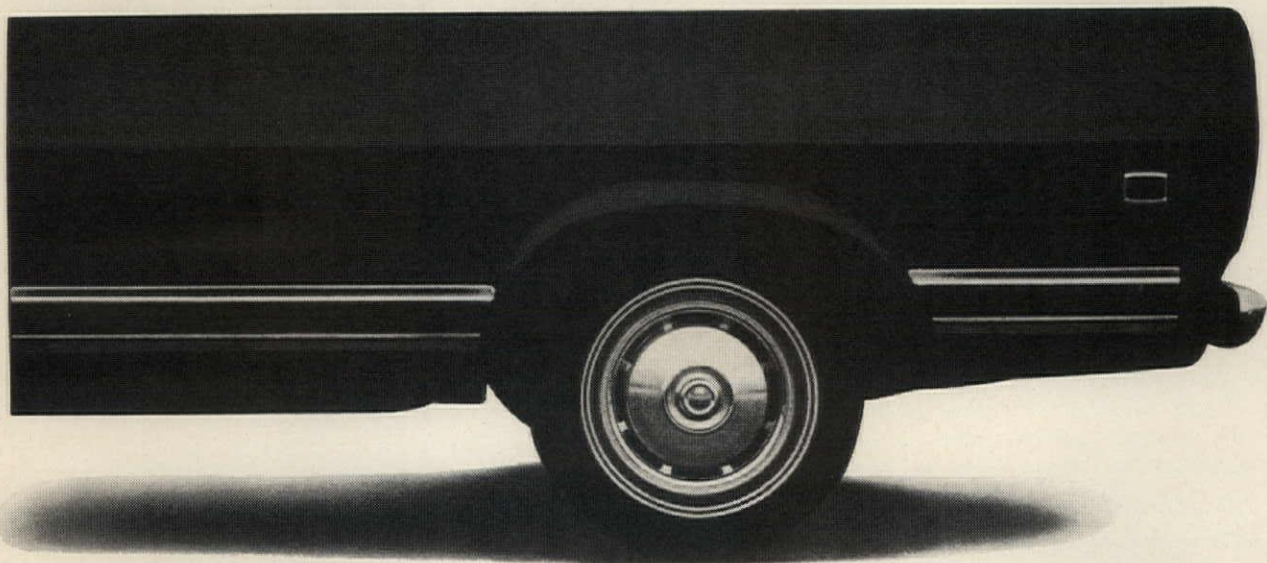

front and the weight in the back is the transmission. Since it's going to be doing a truck's job—make sure it's a truck transmission. We have seven available—two 3-speeds, two 4-speeds, a 5-speed heavy duty, a 5-speed with overdrive and a 3-speed automatic.

Just to make sure that everything else is up to hauling a heavy load, check on the little things.

Like smooth beds so you won't mar a load. Gas tanks mounted *outside* the cab. Direct-reading gauges instead of idiot lights. Optional extra-duty cooling and electrical systems. Optional four-wheel drive. And an optional 6-man cab.

They're the things you'll find on every International pickup.

And when you're through checking on all the things that will take care of that

load in the back, check on the things that will take care of you.

Plush interiors. Air conditioning. Power steering. Power brakes. AM-FM.

They're the things you'll find available with an International.

Finally, when you've done all the looking, you'll see a big difference between the International and anything else with a bed in the back.

Because the International is built around the most important part first.

The last half.

You can see it and test drive it at your International dealer's showroom.



**INTERNATIONAL TRUCKS**

International Harvester Company  
401 N. Michigan Ave., Chicago, Ill. 60611.

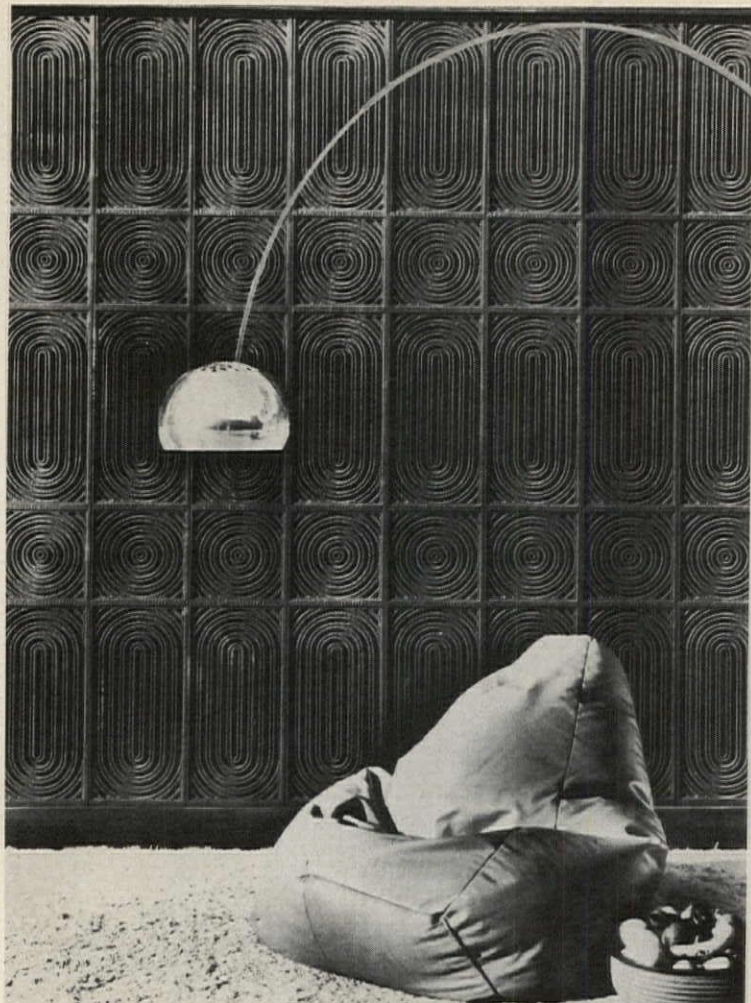

**Carved wood modules** of all-heart redwood can be used to decorate walls, doors, furniture, or fixtures. Panels are part of the "Linea" line of panels with geometric patterns, and they are 11 1/4" wide and come in lengths up to 96". Edges are T&G for easy installation, and all the patterns in the line are bold and deeply carved. Forms & Surfaces, Santa Barbara, Calif.

CIRCLE 240 ON READER SERVICE CARD



**Textured oak paneling** comes in four tones—a green, a gold, a medium brown, and a deep brown—called "Etched Oak." "Forest-glo" panels have a low-sheen finish that brings up color, grain, and texture while protecting them from abrasion and the stains of dirt, grease, alcohol, ink, and most household chemicals. It wipes clean with a sponge and won't crack, craze, or yellow with age. V-grooves are irregularly placed on 4'-wide panels that are 7' to 10' long. Weyerhaeuser, Tacoma, Wash.

CIRCLE 241 ON READER SERVICE CARD



**Low-cost hardwood panels** are priced at the level normal for high-quality printed wood-grains. Two lines of "Masterpiece" plywood panels are available: "Sterling" in cedar, teak, walnut, rosewood, cherry, or hickory; and "Mt. Vernon" in elm, ash, or birch. Both are 4' x 8', V-grooved, and pre-finished for sheen as well as protection. Potlatch/International, San Francisco.

CIRCLE 242 ON READER SERVICE CARD

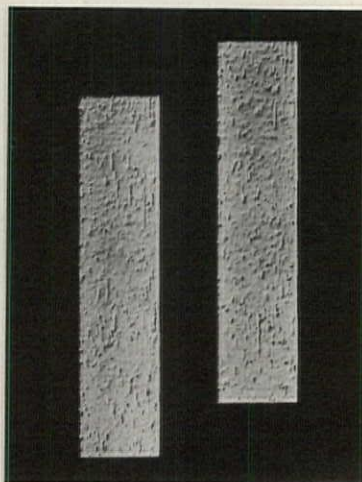

**Rough-surfaced clay tiles** have a handcrafted look at production-line prices. New wirecutting process cuts the smooth skin and exposes the body of tile before it is glazed and fired so that glaze settles into depressions and gives tile individual texture. Wirecut tiles are available in two designs in two lines: "Terrain" in five colors in the 4"x8" "Tessin" line and "Velour" in 11 colors in the 2 1/16"x9 7/16" "Contur" line. Gail International, Redwood City, Calif.

CIRCLE 243 ON READER SERVICE CARD

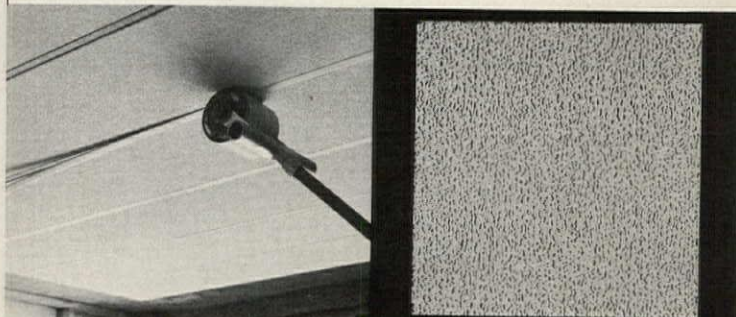
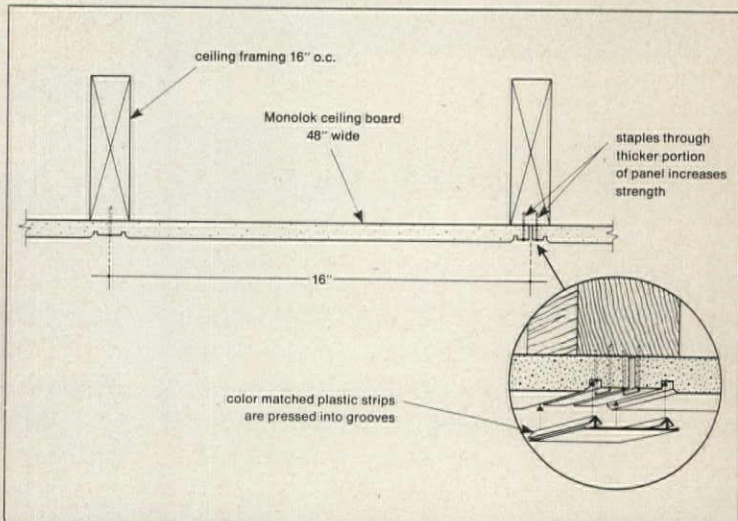

**Ceiling system** is based on panels that are 4' wide and up to 14' long. Panels are stapled to ceiling framing (drawing, above), then staples and joints are hidden by color-matched plastic strips that are easily pressed, as shown here, into grooves 16" o.c. "Monolok" system comes in two

embossed patterns: "Madera" the stippled one shown here, which has a polyvinyl-acetate finish, and "Trieste", which has a more subtly textured surface and a vinyl finish. No-glare surfaces are washable. Simpson Timber, Seattle, Wash.

CIRCLE 244 ON READER SERVICE CARD

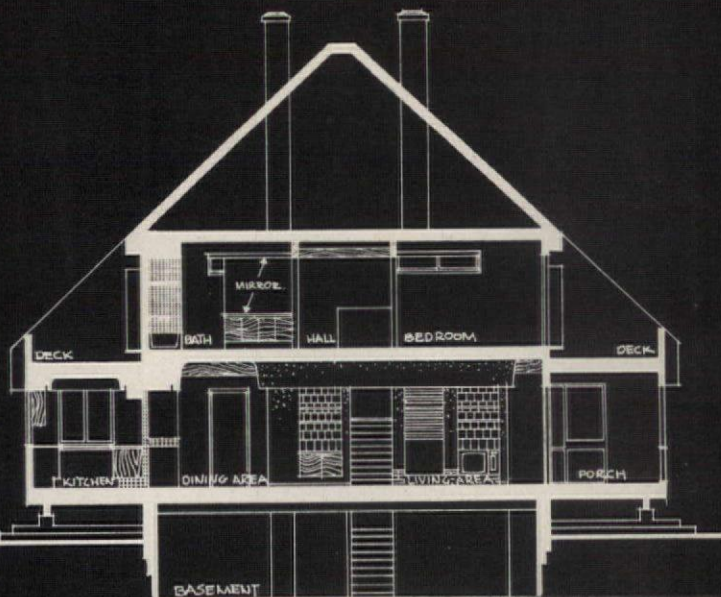

Residence at Gardner, Kansas. Certigrade Shingles No. 1 Grade: roof, 24" Royals; walls, 16" Fivex.  
Architects: Seligson / Eggen. Owner-contractor: Henry McGrew.



## Red cedar shingles restore some great planes to the Great Plains.

Owner Henry McGrew decided some rural renewal was in order after he bought this farmhouse near Kansas City. The building was structurally sound, so minimum cost turned the trick. Red cedar shingles for the expansive plane surfaces of the outside. New wall surfaces and a double-sided fireplace for the inside. New doors and windows for in-between.

Red cedar shingles were selected for

several reasons. Their natural beauty looks inviting from a distance — something that Kansas has lots of. Their rich texture complements a rustic environment. And their inherent warmth projects a sense of informality.

Red cedar is also practical. It is naturally insulative against the coldest Great Plains winter, the hottest summer. It withstands even hurricane

force winds. And it requires no maintenance for decades.

For your next remodeling project, specify the enduring beauty of red cedar Certigrade shingles or Certi-Split handsplit shakes. For details and money-saving application tips, write: 5510 White Building, Seattle, Wa. 98101. (In Canada: Suite 1500, 1055 West Hastings St., Vancouver 1, B.C.)



**Red Cedar Shingle & Handsplit Shake Bureau**

One of a series presented by members of the American Wood Council.

# "We've never had to replace one single faucet during the entire 8-year history of Marina City"

*Robert R. Butler*

Building Superintendent

And he's talking about more than 5000 faucets. Delta faucets.

The success of Chicago's famous Marina City is no accident. It's the result of specifying Delta single-handle faucets exclusively in the building complex.

Mr. Butler, who's been at Marina City from its beginning, figures that in 8 years less than \$200 was spent to maintain over 5000 faucets. But low maintenance cost is just one of the advantages you get when you specify Delta single-handle faucets.

Delta's also simply beautiful . . . simply beautiful to look at, beautifully convenient to operate. And that prompted many Marina City tenants building new homes to ask where and how they can get Delta faucets.

Let us tell you more about Delta faucets. Write Delta Faucet Company, a Division of Masco Corporation, Greensburg, Indiana 47240. That's forward thinking.

**Delta Faucet.  
Simply beautiful.**

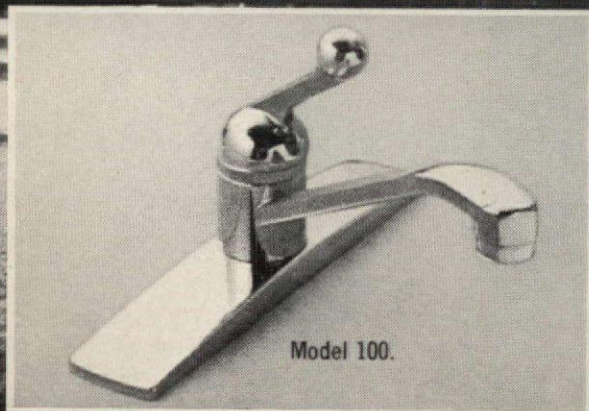

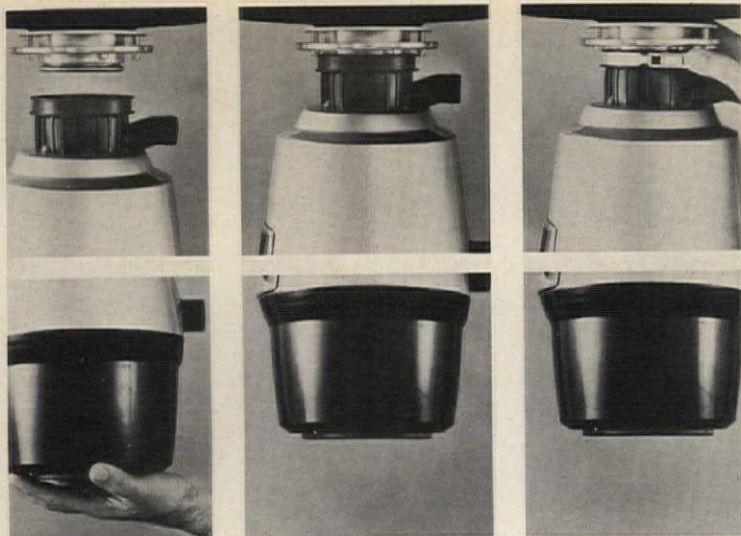

Easy-to-install waste disposer reduces kitchen noise by suspending unit from a rubber hush cushion. Other sound reducers are a fiberglass sound sponge around the motor and soft rubber splash guards and drain closures. Installation does not require holding the unit in place while complicated alignments are made; just push the disposer up and it suspends, then clamp it in place (above, left to right). Three models are available. Stainless steel parts guaranteed against failure due to corrosion for 20 yrs.; other parts, five yrs. Waste-King, Vernon, Calif. CIRCLE 211 ON READER SERVICE CARD



Board-and-batten construction of these oak cabinets is genuine—horizontal battens on the door backs hold together the vertical deep v-grooved boards on the front. Black strap colonial hardware with hammered edges complements the New-

port cabinets which come in five finishes of oak—four are shades of brown, the fifth is a subtle green—all of which bring up the rich grain patterns of oak. Mutschler, Napanee, Ind.

CIRCLE 212 ON READER SERVICE CARD



## "Showers of Diamonds"

### Fountains by RAIN JET

SPARKLING ELEGANCE! Patented fountain heads sculpture jewel-like water droplets into a rotating crystal chandelier. Complete Fountain and Bowl Assemblies (no plumbing needed), or Fountain Heads only. Also "Aquavators" for installation in existing pools. Choice of sizes. Send for free full-color literature and prices.

RAIN JET CORP., 301 S. Flower St., Burbank, California 91503  
Dept. FC

CIRCLE 171 ON READER SERVICE CARD

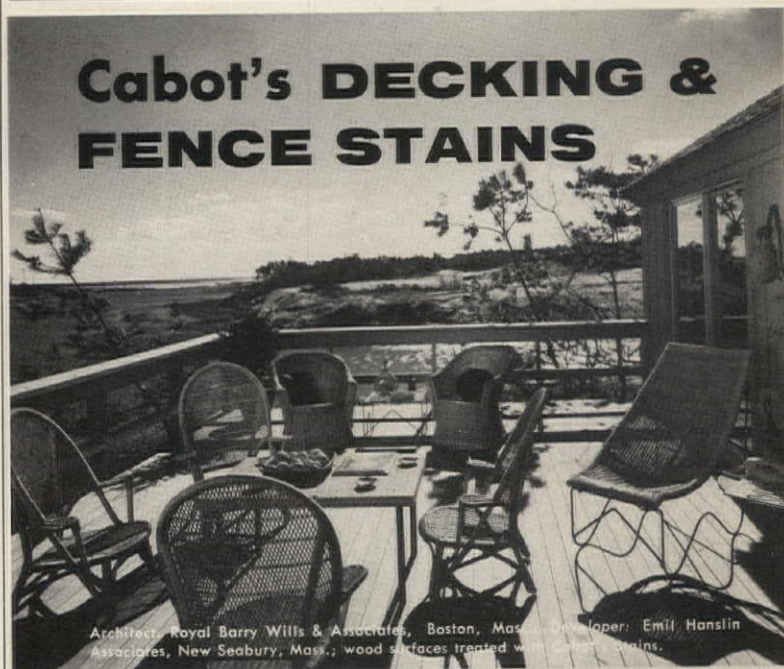

## Cabot's DECKING & FENCE STAINS

Architect: Royal Barry Wills & Associates, Boston, Mass.; Designer: Emil Hanslin Associates, New Seabury, Mass.; wood surfaces treated with Cabot's Decking & Fence Stains.

Wood decking and wood fencing, popular now as never before, require a finish both decorative and durable. Cabot's Decking & Fence Stains, developed specifically for this purpose, beautify and protect wood surfaces under the most difficult conditions. The stained surface resists cracking and peeling, mellows with age, will not rub-off or track-off. Available in eleven pleasing colors; suitable for all types of wood.



### Samuel Cabot Inc.

One Union St., Dept. 530, Boston, Mass. 02108

- Send color card on Decking & Fence Stains
- Send full-color Cabot handbook on wood stains.

CIRCLE 149 ON READER SERVICE CARD



Compotite waterproofing can result in a fully tiled shower area at no more than the cost of a tub or open-base receptor. For Compotite is less in price than any other shower pan material. Beautify your baths, upstairs laundry rooms, and other wet-areas with everlasting ceramic tile based on Compotite. Give her the tile she loves!



**Compotite**  
Shower Pan  
P.O. Box 26188  
Los Angeles, California 90026  
Phone: (213) 483-4444

CIRCLE 172 ON READER SERVICE CARD



Early American cabinets have warm, cherry-like finish on raised-panel doors and solid pine drawer fronts. Hardware was custom-designed for the "Country Salem" look. Features include dovetailed drawers on a suspension slide and adjustable shelves in base and wall cabinets, which have large interior spaces. Construction features include maple frames, deep top and back rails for secure mounting and big corner blocks. Brammer, Davenport, Iowa.  
CIRCLE 213 ON READER SERVICE CARD

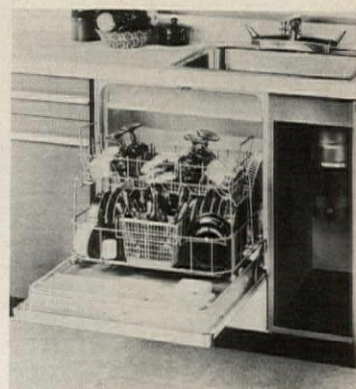

Undersink dishwasher fits under single 24" sink or under double 36" sink with disposer. Ideal for small apartment kitchens, the 24"-wide dishwasher has 10-place-setting capacity, two-level washing action, automatic dual detergent dispenser, two rollout cushion-coated random loading racks, self-cleaning action, soft-food disposer, automatic water-level control, and 6-compartment silverware basket. Hotpoint, Louisville, Ky.  
CIRCLE 214 ON READER SERVICE CARD

# LUCKY YOU IF YOU LIVE IN THE WEST!

Your builder can specify

## A CRESTWOOD KITCHEN!

Offices and showrooms: Crestwood Kitchens Inc.,  
2970 Winchester Blvd., Campbell, Ca. 95008.  
Phone: (408) 379-6200.

(Architects and builders: See Crestwood booths 708-709, PCBC, Garden Room, Fairmont Hotel, San Francisco, June 2, 3, 4)

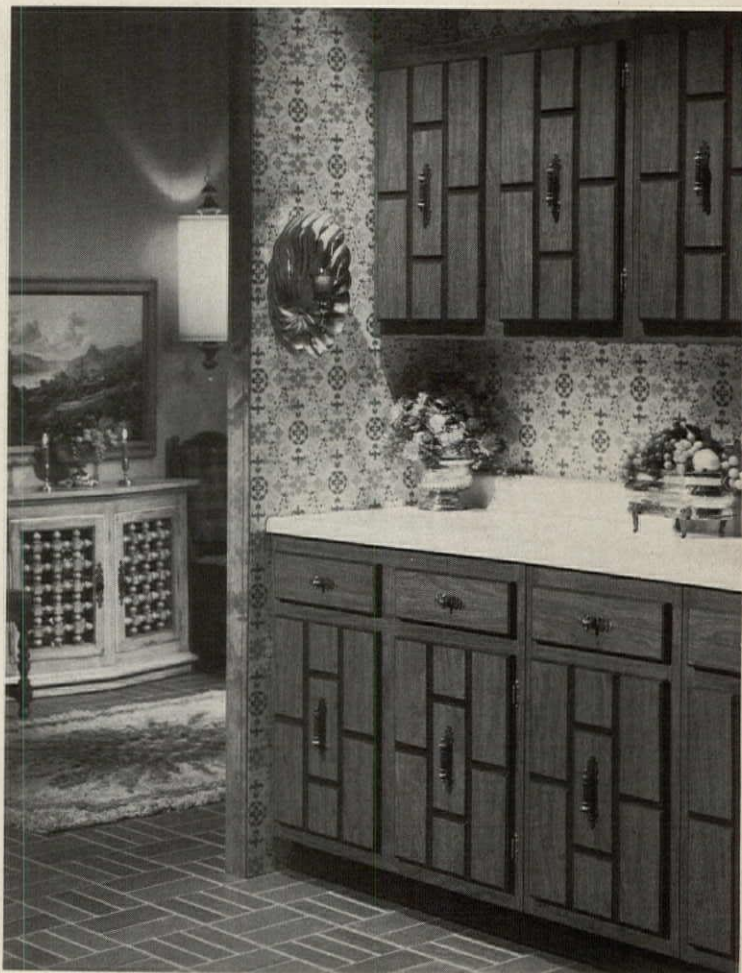

Kitchen cabinets with high-pressure plastic laminate finish look and feel like natural wood. The doors are decorated with distinctive toned incisions. Solid cast furniture hardware completes the styling of these AristOKraft cabinets which meet

requirements for low-maintenance construction and finish. "Mandalay" kitchen cabinets to fit individual requirements for any size or shape of kitchen. United Cabinet, Jasper, Ind.

CIRCLE 215 ON READER SERVICE CARD



You don't have to know anything about shingles to know this one's exceptional.

It's thicker. Heavier. Looks like a wood shake. It's random-edged like a wood shake. Has character like a wood shake. But it isn't wood.

A wood shake can't begin to protect like this one. Against hurricane winds. Fire. Rain, snow and melting ice.

We've taken the best protection features of highest quality asphalt. And added the heart warming look of natural wood. The result is a distinguished shake shingle of uncommon beauty, ideal for gambrel or mansard roofs on traditional or modern homes.

Because it's thicker, heavier (half again as heavy as an ordinary shingle) and embellished with jumbo granules, the Bird

## Bird architect<sup>®</sup> 70 asphalt random shake shingles



# Bold, Brawny, Beautiful

Architect 70 brings massive dimension and character to your roof.

And the random edging, as with natural wood shakes, gives a deep, sculptured shadow line for a look of strength and substance. Warm nature tones of Cypresswood, Oakwood and Ebonywood enhance even more the captivating good looks of the Bird Architect 70.

Planning to build or re-roof? Look into the bold, brawny, beautiful one. See your Bird dealer or send coupon now. See our catalog in Sweets.

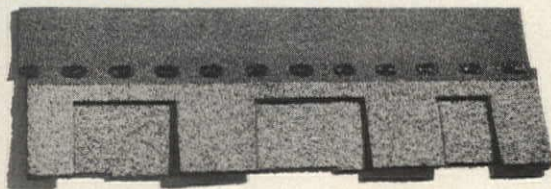

**BIRD  
& SON**  
QUALITY PRODUCTS SINCE 1795

Bird & Son, Inc., East Walpole, Mass.

Please send me all the facts on the bold, brawny, beautiful one – Bird Architect<sup>®</sup> 70 asphalt random shake shingle.

Name \_\_\_\_\_

Street \_\_\_\_\_ City \_\_\_\_\_

City \_\_\_\_\_ State \_\_\_\_\_ Zip \_\_\_\_\_

House & Home – May

# residential garage doors that harmonize



Cathedral Lites



Sunburst Lite



Custom Co-ordinated Panels

## From the Crawford Design Team

The ideal way to add buyer appeal to any home . . . garage doors that harmonize with your entrance doors . . . the costs are low and any or all of these ideas are available now. You can order one, today, or get full details from your local Crawford distributor or write.



**CRAWFORD**

**Crawford Door Company, 4270 High Street, Ecorse, Michigan 48229.**

division of The Celotex Corp.

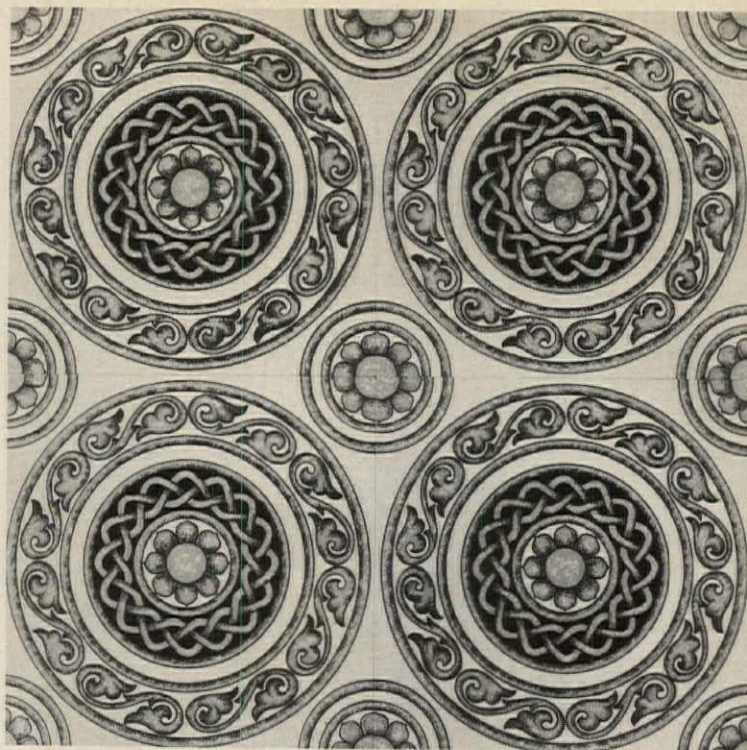

Vinyl tiles in a circular motif are designed to appear seamless (above) or to resemble palazzo tiles four centuries old (left). "Villa" comes in five three-color combinations: gold and white on black, brown and white on gold, bamboo and gold on red, beige and brown on green, and two blues on white. Tiles are 12" square, go with traditional or contemporary decor. Amtico Div., American Biltrite Rubber, Trenton, N.J.

CIRCLE 230 ON READER SERVICE CARD

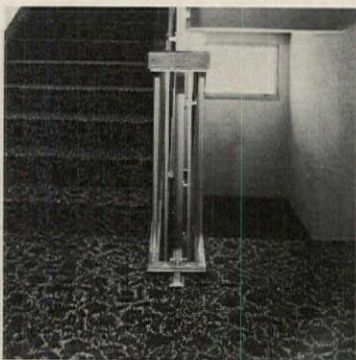

Flocked carpet has 27 million fibers per sq. yd. to take rough commercial wear. Patented French process flocks nylon monofilament yarn into non-woven fabric that is given an expanded PVC backing. "Flocrest" is stain resistant, washable, good for indoors or out. Available in ten colors plus three patterns as 14½" tiles or in 59"-wide rolls. Floor Crest, Massapequa, N.Y.

CIRCLE 231 ON READER SERVICE CARD



Printed carpet is made of continuous filament nylon that is tightly packed so that it will wear well in any room of the home as well as in light commercial installations. "Modernaire" is a blend of unusual colors in a geometric pattern that resembles stained glass. The carpeting is 12' wide on a high density foam backing, and it is stain resistant. Congoleum, Kearny, N.J.

CIRCLE 232 ON READER SERVICE CARD

# Distinctive Apartments

Completely covered with  
Shakertown 8' panels of  
shakes or shingles as  
"People Pleasers."

Immediate favorable response to your buildings is assured when you use the ever popular Western Red Cedar textures available in Shakertown 8' panels. Three-ply Shakertown Barn Shake Panels effectively wrapped this multi-story Rubicon East apartment in Berkeley, California. Large, one-man panels apply rapidly with built-in self-alignment factor and matching annular threaded nails. Panels are also available in Rough Sawn and Shingle Textures in natural or semi-transparent finishes.

Weiner & Fischer, Architects  
Len-Ray Construction Co. Contractor

Write for descriptive folder . . .



## Shakertown®

FIRST NAME IN CEDAR SHAKES

SHAKERTOWN CORPORATION  
DEPT. HH-5  
4416 LEE ROAD  
CLEVELAND, OHIO 44128

In Canada:  
BESTWOOD INDUSTRIES, LTD.  
P. O. BOX 2042  
VANCOUVER 3, B. C.

# The New Leader in Elegance Valley Faucet

## Starburst Series ...guaranteed to please

a new elegance at your fingertip

Something really new has burst upon the horizon of functional beauty in the bath. It's Valley's Starburst lavatory series that features a completely new shape in acrylic handles...a shape that combines the lever type flow control and temperature control in a unique configuration. All the other Valley features are here too. five-year parts warranty, one year no-call-back guarantee with \$10 labor allowance\*, the durability of Triplate finish, and trouble-free Hydroseal control action with the Feather Touch. See your Valley distributor for all the good news about Starburst, and how you can profit from this new innovation in elegance from Valley.

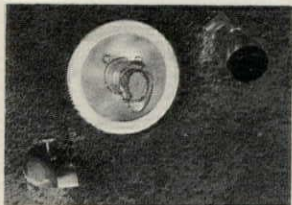

Including the Industry's Outstanding Warranty

\$10 bucks says you won't have to disconnect a Valley faucet for a year after proper installation.\*

\*Full warranty and guarantee detailed in package.

**EASTMAN CENTRAL D**

a division of

**UNITED STATES BRASS CORPORATION**

SUBSIDIARY OF HYDROMETALS, INC.  
901 TENTH STREET, PLANO, TEXAS 75074



VALLEY TRIMWARE • SPEEDFLEX SUPPLIES • DURO FITTINGS • CONNECTORS  
LOOK FOR THESE MARKS FOR SUPERIOR PLUMBING QUALITY

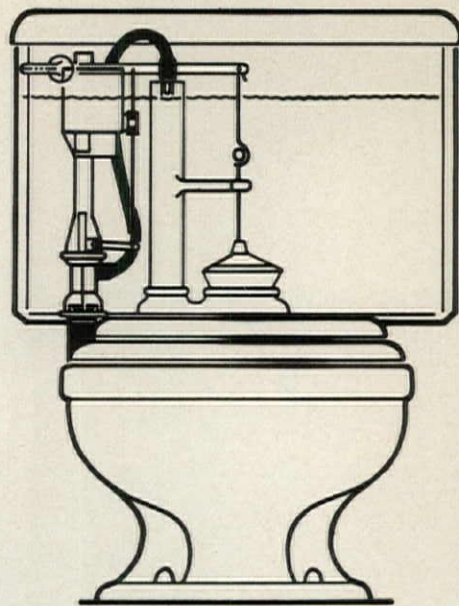

Non-corroding flush valve of plastic and stainless steel replaces old-fashioned float arm and ball with a polyethylene float like an upside-down can that slides on a plastic rod. The float, connected to the ballcock (valve) by an arm of special noncorrosive stainless, shuts water off positively rather than gradually. Refilling is quieter and faster, starts and runs at full pressure until tank is full. Leaks in tank or tank ball seat cause re-filling whenever one gal. has been lost. Sound of constant refilling "signals" need for repairs, thus saving thousands of gals. of water a year. Fluidmaster, Anaheim, Calif.

CIRCLE 236 ON READER SERVICE CARD

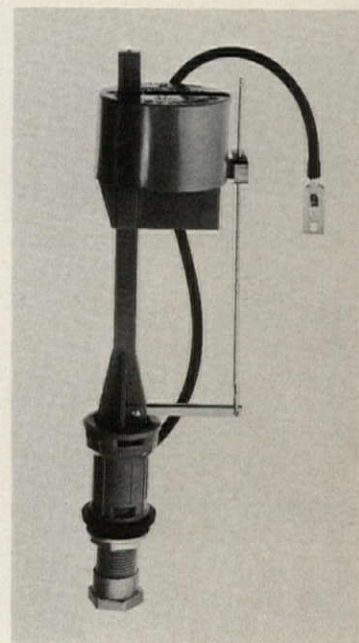
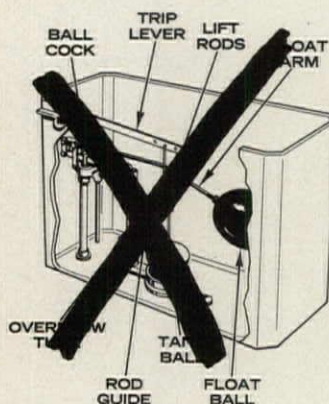

Shut-off device can be used with the Fluidmaster ballcock shown above. Instead of relying on the audible signal of successive tank refills, "Control Gard" shuts the water off. Water stays off until repairs of leaking tank or valve are made, thus saving costly water bills in apartment projects or repair bills for flooded rooms. Fail-Safe, Little Rock, Ark.

CIRCLE 237 ON READER SERVICE CARD



*Photo courtesy Andersen Corp.*

## **Comfort is no longer enough. You've got to build in safety, too.**

**For sliding  
glass doors,  
use Thermopane®  
insulating glass units  
made with Tuf-flex®  
tempered  
safety glass.**

That does it. Because Tuf-flex is safer than ordinary glass. By a mile. Even if it's hit hard enough to break (not easy) it doesn't break like regular annealed glass. It turns into pebble-like pieces that are very unlikely to cause serious injury. So when you combine Thermopane comfort with Tuf-flex safety, you've

really got a big sales point with your customers. Thermopane/Tuf-flex units in clear, grey and bronze are available in standard sizes. Made only by Libbey-Owens-Ford Company, Toledo, Ohio 43624.

**LIBBEY-OWENS-FORD**



# You install them, we'll service them.

*Would you believe  
900 service agencies?*

You are a super builder. The best thing you can do with your time is keep on building and marketing your residential properties.

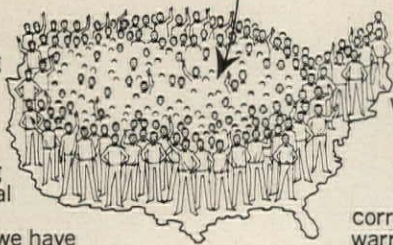

That's why we have service agencies with parts available all over the U.S.

You install our dishwashers, they'll service them. And we'll pick up the bills. (One year—both parts and labor.)

Of course, our dishwashers really don't need that much service. That's why we even underwrite the cost of a "satisfaction-guaranteed-or-your-money-back"

program—both on our built-in and convertible dishwashers. We've simply got a great product.

Our stainless steel models have a 20-year corrosion protection warranty. Two of our models also have

extended parts warranties on their timers.

It's a simple plan. And we've already got the agencies. Now all we need is you.

For more information, drop a postcard to: Dick Schaub, VP Marketing, Waste King Universal, 3300 East 50th St., Los Angeles, California 90058.

## The stainless steel dishwasher.



CIRCLE 173 ON READER SERVICE CARD

## PRODUCTS/WINDOWS

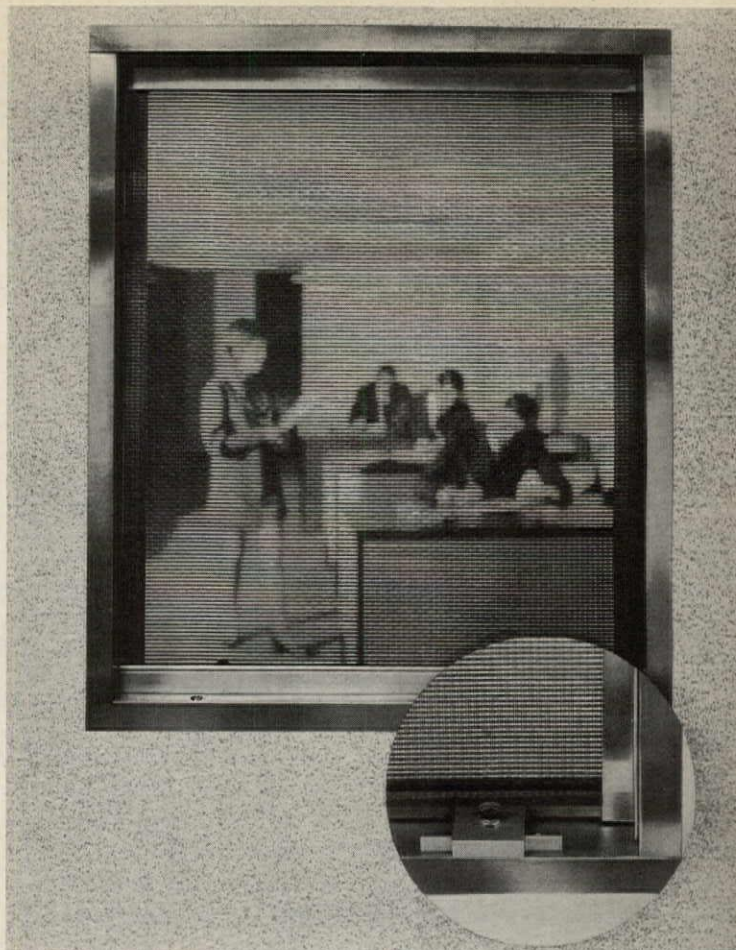

Fiberglass screening diffuses sun's light, cuts interior glare, and blocks heat rays before they reach window glass, thereby reducing solar heat and, consequently, air conditioning costs. Fiberglass won't stretch or shrink, can't corrode, never needs painting, and resists salt air and industrial fumes. Virginia Iron & Metal, Richmond, Va.

CIRCLE 216 ON READER SERVICE CARD



## The incomparable<sup>+</sup> new 747 is ahead of its time.

**\*No Whiteprinter — even at twice the price — can deliver bigger or better prints day after day.**

With better printing features heretofore unobtainable in tabletops, the new 747 virtually eliminates down time — electronic components are in a replaceable modular unit / new mercury contacts improve evenness and intensity of light — machine runs for hours without strain / with speeds to 15 f.p.m., copy quality is unmatched by any tabletop / 3-speed selective vapor development assures perfect prints, eliminates liquids in machine.

Find out about the incomparable 747. Get a demonstration. 1-year warranty. 600 dealers.

Low cost lease plan. Blu-Ray, Incorporated, 1 Westbrook Rd., Essex, Conn. 06426. Tel: (203) 767-0141.

**BLU-RAY**

CIRCLE 156 ON READER SERVICE CARD

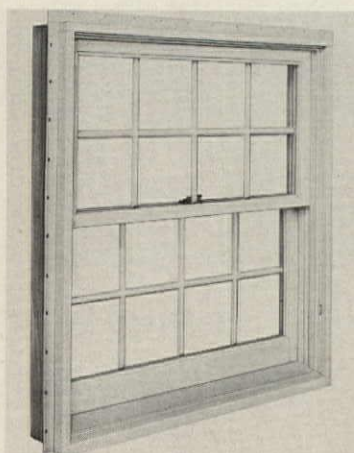

Maintenance-free wood window is double-hung, has vinyl protecting the exterior frame and steel weatherstrips, a vinyl nailing flange, and exterior sash that is factory treated, primed, and finished. Shipped pre-assembled and ready to install. Even the glass is wood-bead glazed on the inside for easy reglazing. Malta, Gahanna, Ohio.

CIRCLE 217 ON READER SERVICE CARD



Double-hung wood window tilts in for easy washing of upper and lower sash, both of which can be lifted out easily. Tilt-in window comes in 74 sizes, can be ordered with block and tackle or spring balances, with standard or 3/4" insulating glass. Hand lifts are milled in and jamb liners removable. Biltbest, Ste. Genevieve, Mo.

CIRCLE 218 ON READER SERVICE CARD

look to the leader....  
look to **Majestic**<sup>®</sup>



**FIREPLACE  
headquarters**

----- where you can buy a  
fireplace of your design choice

----- built-in, free-standing or  
wall-hanging -- wood-burning,  
gas-fired or electric

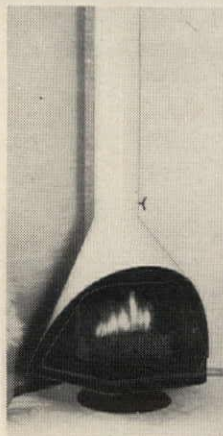
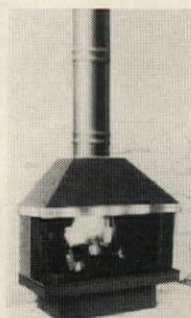
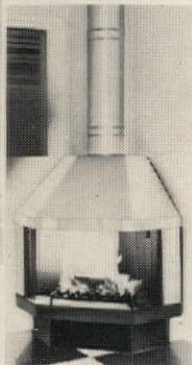
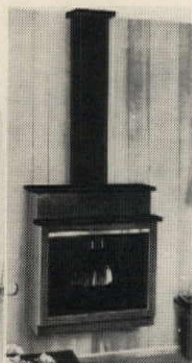
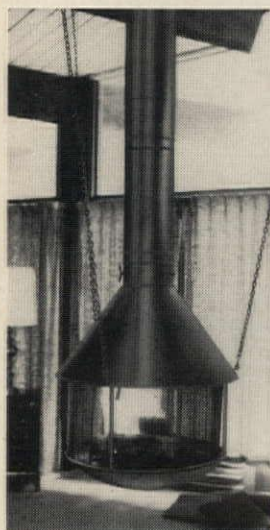

The Majestic Company  
Huntington, Indiana 46750

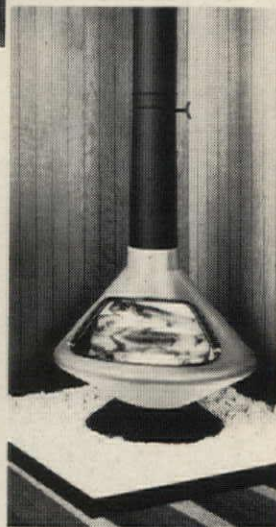

**america's leading fireplace  
manufacturer**

Write today  
for free  
brochures

**Majestic**<sup>®</sup>  
An American-Standard Company

## "Women's Lib" can move wives

(right into your homes and apartments).

Ban The Garbage Can



"Women's Lib Begins At Home" . . . our theme for 1971 which millions of women will read and heed. Because In-Sink-Erator disposers ensure freedom from garbage problems, they're powerful sales persuaders. Eight models to choose from; over 800 Service Centers nationwide. With 50 units or more you get a free maintenance program that saves a sinkful of service costs.



**EMERSON** IN-SINK-ERATOR DIVISION  
EMERSON ELECTRIC CO.  
4700 - 21st STREET, RACINE, WIS. 53406

## IN SINK ERATOR®

World's Largest Producer of Garbage Disposers and Trash Compactors

CIRCLE 174 ON READER SERVICE CARD

# Book new profits. Install HB Fuller Tweed-TEX epoxy flooring system.

The profit potential in installing H. B. Fuller Tweed-TEX flooring system means that you can be adding some new figures to this book.

Tweed-TEX is a light weight, epoxy based, durable seamless floor that bonds to nearly any type of sound substrate. Fast installation. Low labor requirement. No solvents. No noxious odors. No shrinkage. When finished, the floor has the look of rich tweed.

The beauty for you — no costly equipment to get into a profitable business.

Write us and we'll tell you more about it.



**HB FULLER COMPANY**

2400 Kasota Ave., St. Paul, Minn. 55108 • Dept. HH-5

## LITERATURE

**Concrete admixture.** A concentrated, liquid admixture for concrete is described in a loose-leaf information sheet. According to the manufacturer, the product adds strength and lessens setting time of concrete and it provides cold weather protection. The circular tells how much to use, how to use it, and what results can be expected. Thoro, Standard Dry Wall, Miami, Fla.

CIRCLE 301 ON READER SERVICE CARD

**Figured glass.** Float, drawn sheet, and heat-absorbing glass are discussed in a new brochure that includes descriptions of manufacturing processes for various categories of glass, color and thickness availabilities, and suggested architectural and decorative uses in commercial and residential buildings. Glaverbel, Manhasset, N.Y.

CIRCLE 302 ON READER SERVICE CARD

**Vibratory compactors.** Compactors for construction jobs from small jobs to large projects are available from the manufacturer who offers this four-color brochure on small upright rammers, plate and backhoe-mounted compactors, and small self-propelled drum compactors. The products include compactors for earth, rock, and asphalt. Ingersoll-Rand, New York City.

CIRCLE 303 ON READER SERVICE CARD

**Construction glass products.** Two technical catalogs give information on glazing, design loads, effects on cooling and heating of all kinds of architectural glass—reflective with silver or golden coating, regular and colored transparent, safety, insulating, decorative, and spandrel. The spandrel glass is treated in a separate booklet. Libbey-Owens-Ford, Toledo, Ohio.

CIRCLE 304 ON READER SERVICE CARD

**Concrete in apartments.** A new bulletin illustrates in photographs, charts, and two-color renderings how a construction method combining precast and poured concrete enabled decks and walls of an 18-story apartment building to be erected at a rate of a floor a week. Precast concrete decks and poured-in-place bearing walls were used. Flexicore, Dayton, Ohio.

CIRCLE 305 ON READER SERVICE CARD

**Ceramic tile.** The 1971 Handbook for Ceramic Tile Installation includes updated information and several technical changes for more clarity. A chart of performance levels also includes additional information on floors of light performance levels. The booklet is revised periodically by an industry-wide committee so that it provides current, accurate data on ceramic tile installation. Interior and exterior floors and walls, countertops, shower receptors, swimming pools,

refrigerator and steam rooms are discussed. Tile Council of America Inc., New York City.

CIRCLE 306 ON READER SERVICE CARD

**Gypsum board.** Different kinds of gypsum wallboard are described in a new publication which deals with their uses, composition, and correct handling and installation methods. Simply written, the manual is technically exact and comprehensive. An informative glossary defines basic drywall terms. Copies are available for \$.35 each from the Gypsum Assn., 201 North Wells St., Chicago, Ill. 60606.

**Steel joist systems.** A technical digest contains results of a research project dealing with the proper spacing of bridging for open web steel joists. Detailed reports are provided in text, diagrams, and tables, along with a bibliography of other published works on open web steel joists. \$1 per copy, Steel Joist Institute, 2001 Jefferson Davis Highway, Suite 707, Arlington, Va. 22202

**Alarm control.** The alarm control system described in this information folder detects unauthorized intrusions, burglaries, fires, and automatically dials out a message to specified authorities or central stations. Then a "listen-in" device allows confirmation of the validity of the alarm. Easily concealed miniature microphones permit listening in for 6 min. and detect whispers, shuffles, and other unusual, but low sounds. The brochure includes complete drawings and information on the modular control system. Acron, Lakewood, N.J.

CIRCLE 307 ON READER SERVICE CARD

**Fire codes.** A 10-volume set of fire code manuals covers 206 separate standards, many of which are new or revised to reflect developments in technology or fire experience. Subjects of each volume are: 1) flammable liquids, ovens, and boiler-furnaces; 2) gases; 3) combustible solids, dusts, and explosives; 4) building construction and facilities; 5) electrical systems; 6) sprinklers, fire pumps, and water tanks; 7) alarm and extinguishing systems; 8) portable and manual fire control equipment; 9) occupancy standards and process hazards; and 10) transportation. These standards are widely used throughout the U.S. and Canada. The complete set of 10 volumes (8,002 pages) is available for \$40; individual volumes are \$5 each. National Fire Protection Assn., 60 Batterymarch St., Boston, Mass. 02110

**Wall paneling.** Pre-finished v-grooved wall panels and cotton backed wood veneer are described and illustrated in a full-color in-

TO PAGE 160





**We've just  
made every  
Certain-teed  
product  
even better.**

**With  
nationwide  
service  
geared to  
your needs.**

Service that means the right product, in the right quantity, on site, on time. Because we realize that the best products aren't worth a bag of wet cement if you can't get them when and where you need them.

To save you time and money, we have a nationwide network of distributors—full-line stocking distributors, not sample case salesmen. And we back them with still more stock at all Certain-

teed plants and warehouses. Then tie everything together with a fast-reacting, time-saving, order-processing network. So when your order comes in, we know what to move, when, and where, with a minimum of delays and red tape.

Is this the kind of service you've been looking for? Then contact your nearest Certain-teed building materials distributor, and let him show how he can save you both time and money. Or

write us and we'll put you in touch with him. Certain-teed Products Corporation, Shelter Materials Group, Valley Forge, Pa. 19481.



**The  
Timely  
Company**

Roofing • vinyl siding • building insulation • millwork • carpeting

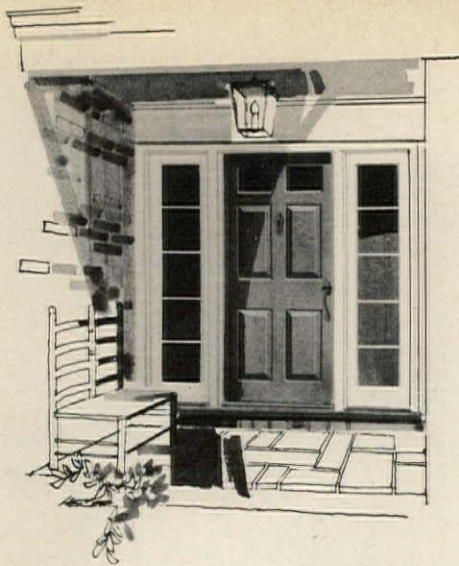

## Dura-Mor . . . the care-free entranceway

New Dura • Mor Entranceways keep saying "welcome!" . . . vinyl exteriors won't need painting for 20 years!

Select from many custom designs—insulated sidelights or pattern glass to match. Write for free full-color catalog. Or see Sweet's Architectural or Light Construction file 8.1/MO.

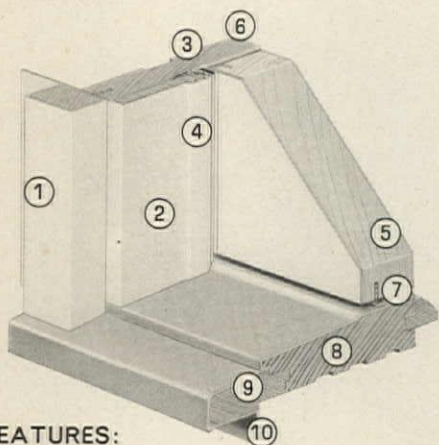

### FEATURES:

- ① Rigid vinyl encased trim.
- ② Rigid vinyl clad wood stop.
- ③ Permanent bar magnet for tight weather seal.
- ④ Magnet protected in duo-durometer bellows.
- ⑤ Insulated door and glass.
- ⑥ Interior jamb not clad, permits any finish.
- ⑦ Double, self-adjusting weatherstrip.
- ⑧ Rigid vinyl basic sill.
- ⑨ Continuous rigid vinyl clad sill band.
- ⑩ Trim fins below sill, at sides and head.



**MORGAN**  
*Company*

OSHKOSH, WISCONSIN 54901

## LITERATURE (FROM PAGE 158)

formation brochure. The matched face veneers, which come in numbered sets, are available in teak, rosewood, and walnut. The v-grooved panels, in rosewood or ebony, are 4' x 8' and 1/4" thick. Genuine wood, thin sliced and mounted on cotton back, can be used on irregular surfaces and applied with adhesive. Bangkok Industries, Philadelphia, Pa. CIRCLE 308 ON READER SERVICE CARD

**Drapery hardware.** "Architects guide to drapery hardware" is the name of a new information catalog from this manufacturer of drapery hardware for all uses. Diagrams, charts, and tables aid the text in explaining the specific uses of each type of hardware discussed. Kirsch, Sturgis, Mich.

CIRCLE 309 ON READER SERVICE CARD

**Structural sandwich construction.** An illustrated booklet containing background information on structural sandwich construction, detailed design procedures and formulas, and a discussion of test methods for evaluating materials has been reissued by a producer of honeycomb core material. The booklet was originally issued by the Forest Products Laboratory of the U.S. Department of Agriculture. The Verticel Co., Englewood, Colo. CIRCLE 310 ON READER SERVICE CARD

**Cooling low-rental homes.** An illustrated booklet demonstrates various methods of cooling all styles of homes and apartments. Particularly aimed at improving cooling in low-rental units, the booklet shows wall, window, and roof cooling units and includes specifications, descriptions, and diagrams. Phil Rich Fan, Houston, Texas.

CIRCLE 311 ON READER SERVICE CARD

**Sculptured tile.** Classically sculptured interior ceramic tiles are described and pictured in a full-color information flyer. The 4 1/4" x 4 1/4" tiles are available in white, antique white, beige, yellow, gold, and antique gold. They are shown in use in a reception area, a bath, and around a fireplace—three uses which demonstrate the versatility of this new line. U.S. Ceramic Tile, Canton, Ohio.

CIRCLE 312 ON READER SERVICE CARD

**The P.U.D. Handbook.** A complete guide to planning, processing, and developing a planned unit development includes an introduction to the P.U.D. concept, plus discussions of land and space planning, the regulatory agencies that deal with P.U.D., marketing the project, and developing and working with home owners associations. The appendix includes sample literature, documents, and legal forms,

and a case study discusses the success of one California development. Although the discussion is based on P.U.D. in California, the basic guidelines are applicable to any section of the country, according to the publisher. \$9.95 per copy from Associated Home Builders of the Greater Eastbay Inc., P.O. Box 5008, Elmwood Station, Berkeley, Calif. 94705

**Ceiling and wall paneling.** Pre-finished hardboard for walls and ceilings in 4' panels, 16" x 8' planks, 16" square ceiling blocks, and 5'-wide mural panels are described in a full-color booklet. Shown are textures, linen stripes, white leather planks, and woodgrains. Accessories and moldings are also discussed in the booklet. Marlite, Dover, Ohio. CIRCLE 313 ON READER SERVICE CARD

**Ceramic floor tiles.** A new line of imported floor tiles for indoor and outdoor use is introduced in a full-color brochure. The tiles are 1/2" thick and 8" x 4", and come glazed or unglazed in sienna-violet, tobacco, patrician red, cognac, and other colors. The backs are slotted to insure adhesion under all conditions. Amsterdam Corp., New York City.

CIRCLE 314 ON READER SERVICE CARD

**Asphalt and vinyl tile.** Color comparison charts of asphalt and vinyl asbestos tile have been issued for use by architects and specifiers. Shown are commercial equivalents for manufacturers' color lines and patterns. Manufacturers represented include, Amtico, Armstrong, Azrock, Congoleum, Flintkote, GAF, and Kentile. Asphalt and Vinyl Asbestos Tile Institute, New York City.

CIRCLE 315 ON READER SERVICE CARD

**Drywall tools.** The latest catalog of this manufacturer's drywall products has been issued and redesigned for easy reference. Included in the catalog listings are drywall tape, hammers, saws, lifters, texture machines, and hundreds of other items. Goldblatt, Kansas City, Kans.

CIRCLE 316 ON READER SERVICE CARD

**Measuring concrete consistency.** An information placard that is designed for easy reference and for hanging on bulletin boards or at jobsites gives a step-by-step method for testing the consistency of concrete. The test is based on the American Society for Testing and Materials standard slump test for portland cement, and is clearly illustrated in drawings. Master Builders, Cleveland, Ohio.

CIRCLE 317 ON READER SERVICE CARD

**Carpet installation.** How-to photos, instructions for installation and

TO PAGE 162

# You'll Never use a 2x10 joist again!

■ Not if you're interested in saving time and money and getting a top quality floor or roof system.

■ The TJI Series joist will span up to 28 feet at 2 feet O.C. for floor systems and up to 40 feet for roofs. It's so lightweight that one man can handle a 20 foot joist with ease. Broad flanges allow much faster nailing of decking, too.

■ Need holes for ductwork, plumbing or wiring? You can have them in almost any size in the TJI. They drill so quickly you'll save a great deal on labor.

■ Shrinkage? Warp? Twist? Crook? Never in the TJI! It's always uniform and far more rigid than ordinary joists.

■ Costs? In many areas they'll actually compete with solid sawn lumber, but even where the original cost is slightly higher the savings you achieve with TJI make them extremely economical.

■ They're available in any length for multiple spans and in depths from 10 to 24 inches. On-time delivery too!

■ More information? Free design manual or cost estimate on your next project? Just inquire.

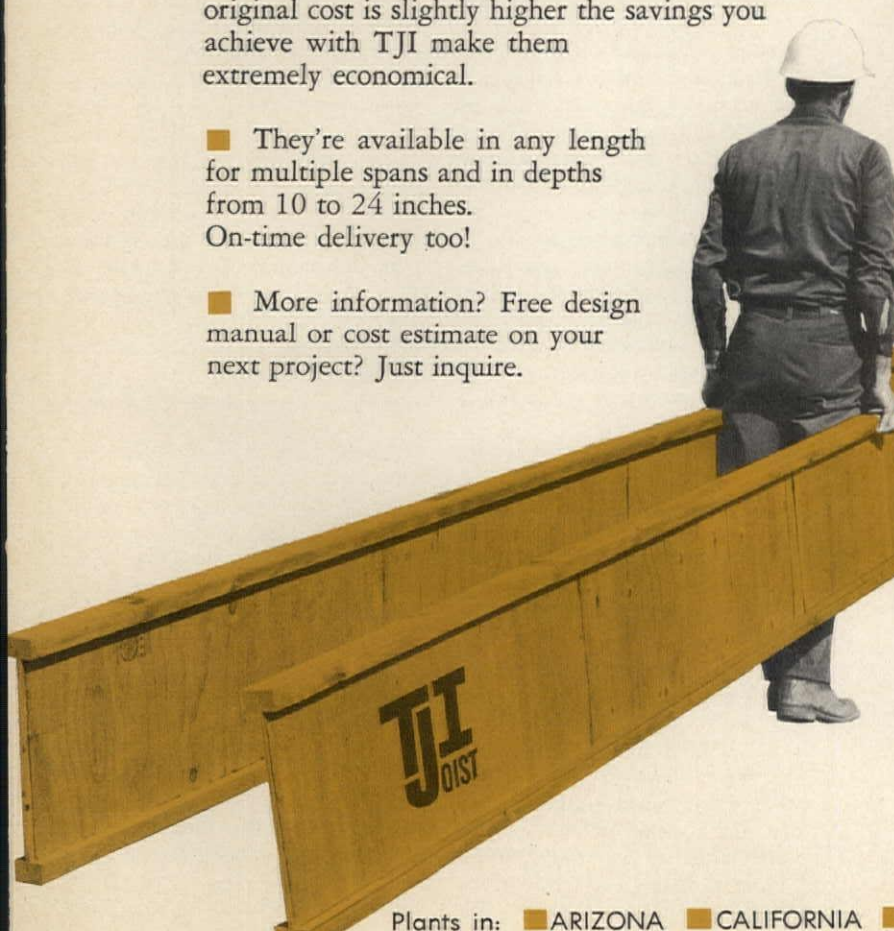
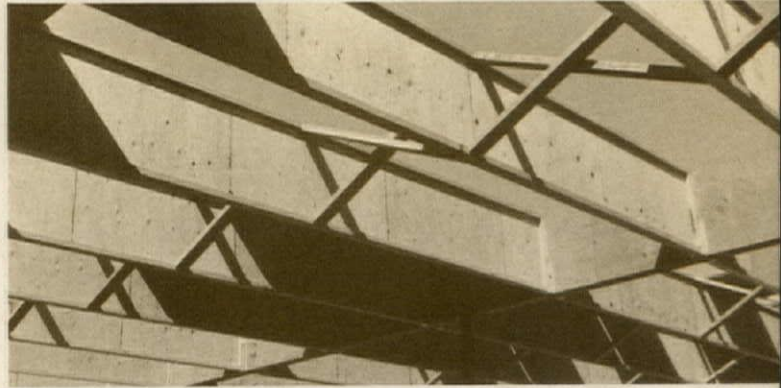
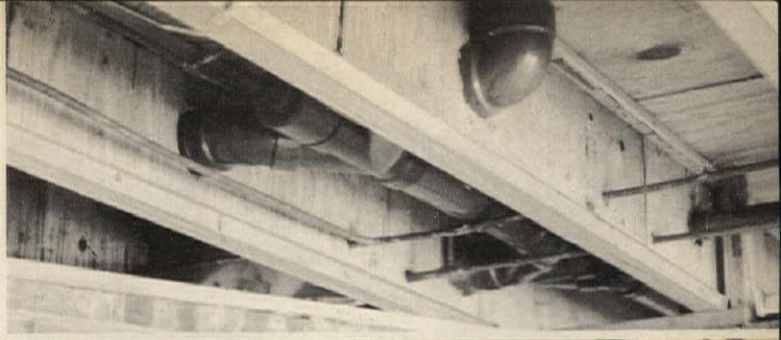

## Trus Joist<sup>®</sup>

9777 CHINDEN BOULEVARD

BOISE, IDAHO 83702

Plants in: ■ ARIZONA ■ CALIFORNIA ■ IDAHO ■ IOWA ■ OHIO ■ OREGON ■ CANADA (Alberta)

CIRCLE 161 ON READER SERVICE CARD

H&H MAY 1971 161

# Up tight and out of sight.



File your plans, prints, charts, maps, fabrics, or wallpaper in 20% of the space required by flat drawer storage • One vertical binder from Plan Hold has the capacity of two flat drawers, and costs 1/6 as much • Patented Friction-grip binders can hold up to 100 prints each • Cut your filing time by 70% using wall-mount, cabinet or mobile files • Write for a free catalog of money-saving filing systems.



P.O. Box 4907, Carson, California 90745

CIRCLE 175 ON READER SERVICE CARD

Make your bathrooms luxuriously modern and excitingly feminine with Alsons Personal Showers. Capitalize on today's bright new bathroom trends. No special rough-in required. 22 models to choose from. Alsons... America's freshest new bathroom ideas.

## The Alsons Personal Shower

**alsons**  
PRODUCTS CORPORATION  
Sarasot, Michigan • Covina, California

CIRCLE 162 ON READER SERVICE CARD

## LITERATURE (FROM PAGE 160)

firmer seaming and fastening, and recommended procedures are included in a new brochure on carpets backed with Duon secondary backing. The booklet gives instructions for installation over pad or cushion, or for direct glue-down installation, which the manufacturer says will be particularly helpful for commercial and contract installations. Duon is part of a new line of non-woven carpet backings which is explained in the booklet. Phillips Fibers, Greenville, S.C.

CIRCLE 318 ON READER SERVICE CARD

**Cement and concrete.** A thesaurus covering the areas of concrete and cement technology has been issued jointly by the American Concrete Institute and the Portland Cement Assn. There are approximately 1,800 entries with the main emphasis on specific key terms relating to cement and concrete subjects. Copies are \$5 each and may be ordered from the American Concrete Institute, Dept. H&H, P.O. Box 4754, Detroit, Mich. 48219.

**Panel drapery and dividers.** Folding window coverings or room dividers which can be laminated with fabric, wallpaper, or vinyl, or which come in several woodstains and colors are described in a full-color brochure. Various uses in residential and commercial buildings are shown, along with technical drawings and the manufacturer's discussion of the advantages of these panels. Ohline, Gardena, Calif.

CIRCLE 319 ON READER SERVICE CARD

**Window problems.** A manufacturer of aluminum windows and related maintenance equipment has released a full-color brochure giving solutions to such common window problems as water, noise, and cold infiltration. Illustrations show the manufacturer's products in schools, hotels, hospitals, offices, and public buildings. Also illustrated is a new sash washer that automatically cleans and dries windows from the inside. DeVac, Minneapolis, Minn.

CIRCLE 320 ON READER SERVICE CARD

**Truck catalog.** A new four-color catalog gives full information on a 50-ton truck with an 11'8" loading height (said to be the lowest of any 50-ton truck), a loader matched body, oil-cooled disc brakes, and a 600-hp-motor. Graphs and specifications are included. Ask for form AE020076, Caterpillar, Dept. H&H, Peoria, Ill. 61602.

**Cedar panels.** Full-color photographs and drawings illustrate a variety of panels in 8' lengths with 14" and 7" exposures. Textures shown include barn and hand split shakes and shingles in rough sawn, machine grooved, and shingle tex-

tures. Semi-transparent, natural oil, and opaque stains are also shown on the panels, which can be used for interior or exterior applications. Shakertown, Cleveland, Ohio.

CIRCLE 321 ON READER SERVICE CARD

**Land planning.** An extensive study of land planning and various solutions to land use problems are discussed in a booklet issued by the U.S. Savings and Loan League. The booklet contains case studies of new towns, alternate site plans, and planned unit developments and their home owners associations. Extensive photographs, plans, and tables are included. Copies of "Land Planning—Better Housing Environments, Vol. 1b" are available at \$2 per copy (less for large orders) from the U.S. Savings & Loan League, 221 North LaSalle St., Chicago.

**Ceiling systems.** Several complete lines of ceiling system products are described and illustrated in a new four-color, tab-indexed catalog. Installation information and photographs are included along with product descriptions, technical data, and maintenance recommendations. The systems described include a complete system of integrating air handling, lighting, and fire protection and a ceramic system that is unaffected by high moisture and other extreme conditions, Armstrong, Lancaster, Pa.

CIRCLE 322 ON READER SERVICE CARD

**Industrial equipment.** A thorough guide to this manufacturer's 1971 industrial equipment includes products that are available, and also lists district sales offices and supplies credit information to make ordering simpler. Details, illustrations, and specifications are included for a wide range of tractors, excavators, loaders, backhoes, fork lifts, and trailers. Rental and warranty information is also included. This buyers' guide was prepared especially for quantity users of industrial equipment. International Harvester, Chicago.

CIRCLE 323 ON READER SERVICE CARD

**Drainage systems.** A letter-size information folder contains the results of this manufacturer's study of different types of pipe systems. A chart compares cast iron with plastic, stainless steel, and other materials. Tyler Pipe, Tyler, Texas.

CIRCLE 324 ON READER SERVICE CARD

**Plywood use.** A handy reference booklet includes tabulated information on construction uses of softwood plywood, including discussions of sheathing, siding, structural components, underlayment, and cabinetry. Timber Engineering Co., Washington, D.C.

CIRCLE 325 ON READER SERVICE CARD



## **With steel doors as good as Float-Away, why pay the high price of wood?**

Today the wooden closet door has about priced itself out of the market, in both homes and apartments.

Lumber prices have climbed 15% in less than a year. Wood doors are up \$1 to \$2 each. More increases are on the way.

Now is a good time to take a hard look at what you're getting for your money—regardless of what kind of door you have used in the past. Compare Float-Away steel closet doors and shelves for initial price and cost of

installation. Examine the unique new Floata-Plate finishing process, exclusive with Float-Away. Compare for appearance, quality and durability.

Float-Away is the best door you can buy—and today that buy looks better than ever.

Call or write for complete details. Float-Away, Dept. HH-05, 1123 Zonolite Rd., N.E., Atlanta, Georgia 30306, (404) 875-7986 ■ In Canada: Richards-Wilcox of Canada Ltd., Box 5060, London 12, Ontario.

**FLOAT-AWAY®**  
COMPLETE CLOSET SYSTEMS

CIRCLE 163 ON READER SERVICE CARD

Division of  
Kinkead Industries 

H&H MAY 1971 163

# ADVERTISERS INDEX

Pre-filed catalogs of the manufacturers listed below are available in the 1971 Sweet's Catalog File as follows.

- A Architectural File (green)
- I Industrial Construction File (blue)
- L Light Construction File (yellow)
- D Interior Design File (black)

W Denotes Western edition  
 M denotes Mid-Western edition  
 N denotes North Central edition  
 E denotes Eastern edition  
 S denotes Southern edition  
 SW denotes Southwest (Swing)

A-L	Air King Corp.	51
	Alliance Mfg. Co.	132W7
	Alsons Products Corp.	162
	American Motors	113
A	American Olean Tile	53
A	American Panel Products, Inc.	127
A	American Standard Inc.	63
A-L	Andersen Corp.	102, 103, 122
	Apeco	115-119
	Associated Mortgage Co.	26
	B. F. Goodrich Chemical Co.	136, 137
A-D	Berven of California	104
A-D	Bird & Son, Inc.	151
	Blu-Ray, Inc.	156
	Boise Cascade Corp.	Cov. II, 34, 35
	Bostitch (Textron, Inc.)	56
	Bryant Air Conditioning Co.	139
A-L	Cabot, Inc., Samuel	149
A-L-D	California Redwood Assn.	6, 7
	Cameron Brown Co.	132S2-S3
A-I-L	Caradco	47
A-I-L	Certain-teed Products Corp.	159
	Chicago Mercantile Exchange	132W3
A-L	Chrysler Corp./Airtemp	19
	Citizens and Southern National Bank, The	132S5
	Columbus Coated Fabrics	25
A-L	Compotite ShowerPan	150
	Craig Corp.	111
A	Crawford Door Co.	152
	Crestwood Kitchens	150
	Delaware Management Co., Inc.	70
A-L-D	Delta Faucet Co.	148
	Dictaphone Corp.	42
	DuPont Co.	32
	E. A. Nord Sales Co.	21
	Econo Car International	125
	Edison Electric Institute	50
	Featherock, Inc.	143
	Float-Away Door Co.	163
	Ford Motor Co. (Truck Div.)	36
A-I-L-D	Formica Corp.	48
A-I-L-D	Georgia-Pacific Corp.	54, 55
A-I	H. B. Fuller	158
	Harcraft Brass	27
	Home Comfort Products Co.	129, 130
A-L	Hotpoint Div./General Electric Co.	128
A	In-Sink-Erator Div. Emerson Electric Co.	158
	International Harvester Co.	144, 145
	Kaufman & Broad	18
	Kingsberry Homes	13
	Kwikset (Div. of Emhart Corp.)	9
	Landmark Industries, Inc.	132S1
	Lear Siegler, Inc.	132E1
A-I-L	Libby-Owens-Ford Co.	155
	Lyon Van Lines, Inc.	114
	Majestic Co., Inc.	157
	Mand Carpet Mills	57
A-L-D	Masonite Corp.	14, 15
	Medusa Portland Cement	132N1
A	Miami-Carey Co. (Div. of Panacorp)	69
	Mitsubishi Aircraft	126
	Modern Maid, Inc.	105, 106
A-L	Moen Div. (Stanadyne)	5
A-L	Morgan Co.	160

	Norris Industries	132W4-W5
	North American Van Lines	123
	Northampton Corp.	44
	NuTone, Inc.	1, 2
	Olympic Stain Co.	Cov. IV
A-I-L	Overhead Door Corp.	40, 41
	Oxford Tile Co.	67
	PCBC	45
A-I-L-D	PPG Industries	10, 11
	PPG Industries (Coil Coatings)	30, 31
	Payne Co., The	132W2, S6, SW1
	Paslode Co.	135
	Pease Co.	61
	Plan-Hold Corp.	162
D	Pomona Tile (Div. of American Olean)	53
	Ponderosa Pine Woodwork Assn.	140, 141
A-L	Potlatch Forests, Inc.	29
	Price Pfister	39
	Rain Jet Corp.	149
A-I-D	Raynor Mfg. Co.	33
A-L	Red Cedar Shingle & Handsplit Shake Bureau	147
A-L	Rez Co., The	37
A	Rohm and Haas Co.	59
	San Valle Tile Kilns	132W9
	Senco Products, Inc.	42
A	Shakertown Corp.	153
	Shapell Industries	70
A-I-D	Simpson Timber Co.	49
A-I	Sonoco Products Co.	121
	Southern California Edison Co.	132W8
	Southern California Gas Co.	132W1
	State Farm Insurance	108
	Sweets Light Construction File	164
	Trailer Coach Assn.	132W10
	Trus Joist Corp.	161
A-L-D	U.S. Plywood	43, 71
A-I	United States Gypsum Co.	Cov. III
	Valley Faucet Div. (U.S. Brass Corp.)	154
	W. A. Sheaffer Pen Co.	122
	Wabash, Inc.	38
	Walter Carpet Mills	65
	Waste King Universal	156
	Weiser Lock	72
	Weslock Co.	17
A-I-L-D	Western Wood Products Assn.	22, 23
	Williamson Co.	132N2

### Advertising

#### Sales Staff

**ATLANTA 30309**  
 Glen N. Dougherty  
 1375 Peachtree St. N.E.  
 (404) 892-2868

**BOSTON 02116**  
 David Persson  
 McGraw Hill Bldg.  
 607 Boylston St.  
 (617) 262-1160

**CHICAGO 60611**  
 Karl Keeler Jr.  
 Charles E. Durham, Jr.  
 645 N. Michigan Ave.  
 (312) 664-5800

**CLEVELAND 44113**  
 Milton H. Hall, Jr.  
 55 Public Square  
 (216) 781-7000

**DALLAS 75201**  
 Jerry Ambroze  
 1800 Republic Natl. Bank  
 (214) 747-9721

**DENVER 80202**  
 Richard Powers  
 1700 Broadway  
 (303) 266-3863

**DETROIT 48226**  
 Charles E. Durham, Jr.  
 2600 Penobscot Bldg.  
 (313) 962-1793

**HOUSTON 77002**  
 Jerry Ambroze  
 2270 Humble Bldg.  
 (713) 224-8381

**LOS ANGELES 90017**  
 Donald Hanson  
 1125 W. Sixth St.  
 (213) 482-5450

**NEW YORK 10036**  
 David Persson  
 500 Fifth Ave.  
 (212) 971-3686

**PHILADELPHIA 19103**  
 Raymond L. Kammer  
 Six Penn Center Plaza  
 (215) 568-6161

**SAN FRANCISCO 94111**  
 Stephen D. Blacker  
 425 Battery Street  
 (415) 362-4600

**BUSINESS MANAGER**  
 Vito De Stefano  
 McGraw-Hill, Inc.  
 330 West 42nd St.  
 New York, N.Y. 10036  
 (212) 971-3204

# The top products used by leading builders are found in this



# open book

Sweet's Light Construction Catalog File where reference turns to preference



Proof of the pudding is in a study just completed. Send for your free copy to:

Mr. Robert Eddings  
 Sweet's Div. of McGraw-Hill Information Systems Co.  
 330 West 42nd Street, New York, N.Y. 10036