

McGraw-Hill's marketing and management publication of housing and light construction \$2 per copy

December 1972

House & Home



**New
Products
for 1973**

Slater. Still the best decorator devices.

Slater pioneered decorator devices, and we still make the finest line in the industry.

At Slater, we make them better, or we won't make them. Our expanded Decorator Line of spec grade touch switches and receptacles, for example. And we've come up with a unique idea added to a great modular concept—personalized embossing on the touch switch. You know there isn't a motel around that wouldn't love to see its name on every switch in the building. We can emboss other things, too, like switch functions (fan, disposal, etc.). The possibilities are limitless:

A small detail? Let's face it. An advantage is an advantage.

The Decorator Series includes the 885 receptacle, the 770 touch switch and a wide variety of combination devices, plus 20 amp versions. All duplex receptacles are available with AUTO-GROUND™. And—speaking of advantages—the modular design of our Decorator Series permits fabulous inventory control. One plate fits both switch and receptacle.

And last, but not least, are the colors. The newest decorator pastels belong in the newest buildings. The only part of an installation that the customer sees is the devices installed on the wall. If he likes what he sees, so much the better.

Slater. The Decorator Line that makes *you* look good.

We have a whole bunch of new ideas at Slater. But they all boil down to one thing: It's good business to do business with Slater. The leader.

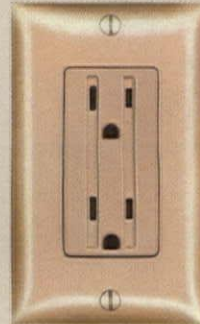
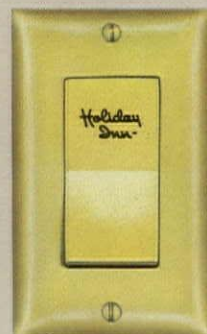
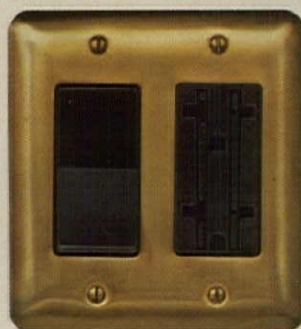
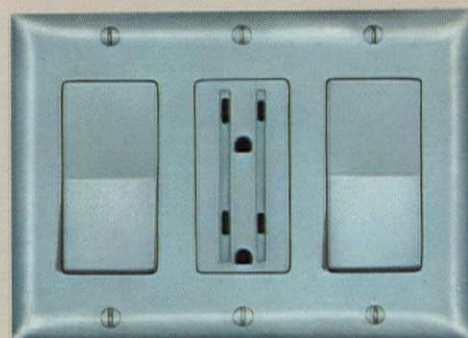

 **Slater**

GLEN COVE, L.I., N.Y. 11542
HEAVY DUTY AND RESIDENTIAL GRADE WIRING DEVICES

The place to see in '73

NuTone NAHB
Booth 2326

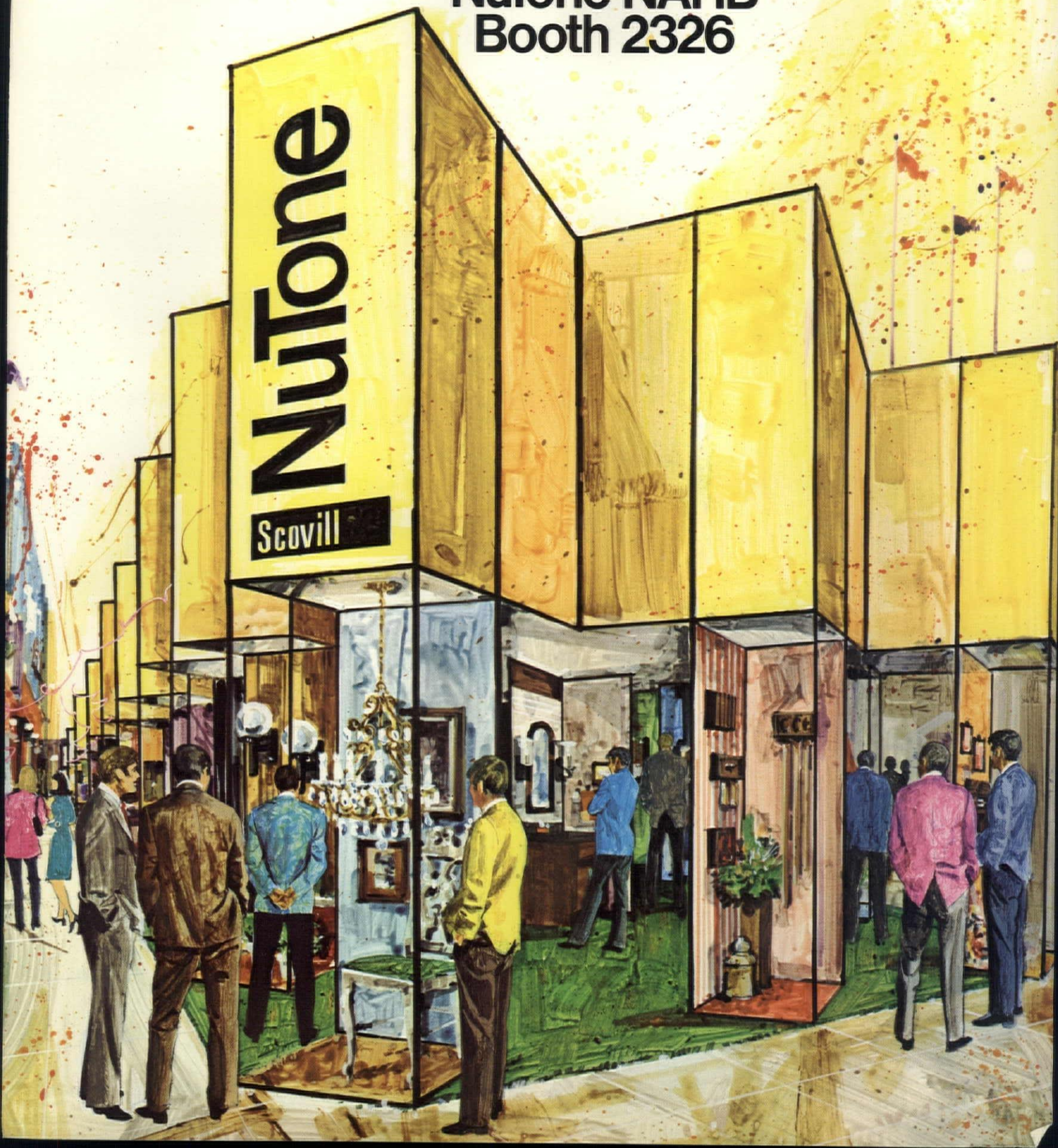

The new things you'll see in '73

New Custom Styled Range Hoods

with delivery time you need, at prices you can afford.

New Security Alarm Systems

Fire, heat, smoke and forced-entry detection . . . with standby battery power for greater dependability. All with simplest installation.

New High CFM/Low Sone Rated Bathroom Fans

NuTone's "Quietest" with customer-appealing styling.

New Automatic Garage Door Operators

Now . . . a garage door system designed and engineered by NuTone — the company that specializes in products profitable for the home building industry.

New Beautiful, Practical Bathroom Cabinets

An exciting new selection of NuTone cabinets styled and priced to add sales appeal and profit to your 1973 homes and apartments.

Don't miss us. See all these products *and more* at NuTone.

NuTone NAHB Booth 2326 . . . the place to be in '73!

NuTone Housing Products

Scovill

Dept. HH12. Form 1061. Printed in U.S.A.



EDITOR
John F. Goldsmith

MANAGING EDITOR
Maxwell C. Huntoon Jr.

SENIOR EDITOR
Edwin W. Rochon

ASSOCIATE EDITORS
Michael J. Robinson
J. Michael Stimson
June R. Vollman

ASSISTANT EDITORS
Natalie Gerardi
Elise Platt

ART DEPARTMENT
Sona Gordon, *director*
Faye Eng, *assistant*
Jan V. White, *consultant*
J. Dyck Fledderus, *drafting*

EDITORIAL ASSISTANTS
Denise H. Martenis
Eileen Silver
Birute R. Zimlicki

BOARD OF CONTRIBUTORS
Herbert L. Aist
Carole Eichen
Joseph C. Grasso
Robert W. Hayes
John Rahenkamp
Walter S. Sachs Jr.
H. Clarke Wells
Lenard L. Wolfe

CONSULTING ECONOMIST
George A. Christie

MCGRAW-HILL WORLD NEWS
Walter Stanbury, *director*
20 domestic and
international news bureaus

ADVERTISING SALES MANAGER
John S. Renouard

BUSINESS MANAGER
Vito De Stefano

MARKETING SERVICES MANAGER
Henry G. Hardwick

CIRCULATION MANAGER
Joseph D. Holbrook

PUBLISHER
James E. Boddorf



House & Home, December 1972, Vol. 42, No. 6. Published monthly by McGraw-Hill Inc. Founder: James H. McGraw (1860-1948). Subscription rates, U.S. and possessions and Canada: for individuals within circulation specifications, \$9 per year, for others, \$15 per year. All other countries, \$30 per year. Single copy, if available, \$2. The publisher reserves the right to accept or reject any subscription.

Executive, Editorial, Circulation, and Advertising offices: McGraw-Hill, 1221 Avenue of the Americas, New York, N.Y. 10020. Telephone: 997-1221. Second class postage paid at Washington, D.C. and at additional mailing offices. Published at 1500 Eckington Place, N.E., Washington, D.C. 20002. Title* in U.S. Patent Office. Copyright© 1972 by McGraw-Hill Inc. All rights reserved. The contents of this publication may not be reproduced either in whole or in part without consent of copyright owner.

Officers of McGraw-Hill Publications Company: John R. Emery, president; J. Elton Tuohig, senior vice president-services; David J. McGrath, group vice president, vice presidents: Ralph Blackburn, circulation, John R. Callahan, editorial; John B. Hoglund, controller; David G. Jensen, manufacturing; Jerome D. Luntz, planning & development; Joseph C. Page, marketing.

Officers of the corporation: Shelton Fisher, president; Wallace F. Traendly, group president, Publications Company and Information Systems Company; John J. Cooke, senior vice president and secretary; Ralph J. Webb, treasurer.

This issue of House & Home is published in national and separate editions.

Postmaster: Please send form 3579 to Fulfillment Manager, House & Home, P.O. Box 430, Hightstown, N.J. 08520.

House & Home

McGraw-Hill's marketing and management publication of housing and light construction

Volume 42 Number 6/December 1972

FEATURES

- 87 Product preview for 1973
- 106 The gentle art of headhunting: how to hire and keep the key executive
- 110 Subsidy housing: how good design can pay off

NEWS

- 4 The President wants to use his mandate to cut back housing subsidies
- 4 Congress settles into the same old housing-as-usual stance
- 9 The winner and still champ in Alabama is Senator John Sparkman
- 9 HLBB's Preston Martin quits the day after new blast from Wright Patman
- 10 California votes to protect its coastline from the developers
- 10 Big builders widen their invasion of eastern states
- 19 Commercial banks signal the mortgage market: You can bank on it
- 20 Latest condominium sales technique—selling 'em by the month
- 24 California's housing market begins to spill into Nevada
- 28 Houston's builders discover a route to instant millions
- 34 Nader's men call mobile homes fire traps—and mobile men cry foul
- 34 A look at the mortgage banking industry at peak of its prosperity
- 48 This condominium project was built to test a market
- 54 Slab-on-grade foundation lets you build on problem soils—at less cost

DEPARTMENTS

- 32 Housing stock prices
- 58 The mortgage scene
How a builder can make two profits out of apartments
- 64 The planning scene
Imaginative planning is the stuff salable housing is made of
- 68 The modular scene
Behind those modular failures: no grasp of the industry's ABCs
- 72 The merchandising scene
Decorated models can do a double-pronged marketing job
- 77 Job/land market
- 81 Letters
- 128 Products
- 203 Reader's service card
- 210 Literature
- 219 Advertisers' index



The President would like to use his mandate to slash housing subsidies . . .

There's no mandate for housing tucked away in the historic landslide of Nixon votes that swept the country on election day.

In fact, housing programs and legislation are certain to be buffeted severely during the two more years of divided government guaranteed by the voters when they split their tickets to make sure that the Democrats would be back in control of both houses of Congress.

This balance of power that is almost identical to what prevailed during the past two years all but guarantees that a drastic move toward wide housing reform just won't happen, even though powerful administration officials are saying that major changes are a must.

At the Department of Housing and Urban Development, about the only certainty is that George Romney won't be there for the housing industry to kick around any more.

Cutbacks. If President Nixon's first housing decision is to name Romney's successor, his second is likely to be cutting back on housing subsidies and grants as part of his commitment to pushing total government spending back to \$250 billion.

In an interview published in the *Washington Star-News* after the election, the President re-emphasized his determination to shut off new programs that cost money.

The reforms in such areas as housing, education and health care "must be reforms within our budget limitation," he said. On reorganization and special revenue-sharing (or block grants), he pointed out that Congress had given him no action. He is determined, he also said, "to accomplish as much as I can of that reorganization through executive action."

At another point the President said that HUD is "too fat, too bloated. They came in and, they did some good things," but in those programs that aren't cut, "we are going to find ways to do them with less people."

At least one housing lobbyist says \$1 billion could be cut from the housing budget if President Nixon wanted to.

At the office of Sen. William Proxmire, ranking Democrat on the banking committee and

chairman of the appropriation subcommittee that approves the HUD budget, staffers say that if President Nixon could find as much as \$500 million to cut from HUD's budget—now running about \$4.5 billion a year—"it would be phenomenal." Proxmire, a vigorous opponent of government waste and the only Democratic senator to advocate giving the President authority to cut programs to reach the \$250 billion total, is already preparing to take a much bigger role as a critic of the housing programs.

Hearings on spending. As chairman of the Joint Economic Committee until January, when Patman takes over, Proxmire, on the day after election, was trying to arrange December hearings on

. . . But Congress seems to be settling into same old housing-as-usual stance

Congressional leaders will begin the new year searching for a new consensus to enable the House and Senate to deal with housing problems.

For decades housing legislation was demonstrably one of the great successes of the New Deal and postwar eras. The programs made it possible for middle and working-class voters to buy homes in the suburbs with ever-lower down payments and ever-longer mortgages guaranteed by the federal government. This brought new business and profits to the banks, the savings and loan associations and the home builders, and it brought the blessings of the electorate to the congressmen and senators who swept the legislation through Congress.

And all this with little cost to the taxpayer.

But with the rise of the subsidy programs (800,000 starts in the last two years) and the scandals, housing programs have suddenly become controversial, expensive and politically dangerous, especially to House members.

Same old team. George Gross, counsel to the lower chamber's housing committee, spells it out this way: "Virtually every congressional district is affected one way or another by subsidized housing issues, particularly the often bitterly divisive issue of site location . . . played out

housing subsidies with such witnesses as Elmer Staats, the congressional watchdog who heads the General Accounting Office, and with Secretary Romney.

Proxmire would like to question Staats on the future of housing and community development programs which Romney, in his late-October speech to the Mortgage Bankers Assn., described as "\$100 billion mistakes" which "we can no longer afford."

Romney's proposals. Romney, in this semi-swan song, suggested several "long-range" solutions to the housing problem, including as the first on his list "the termination of a direct federal role in housing." That would

mean, he said, ending subsidy programs, spinning off FHA as a private agency, and arranging housing allowances and income subsidies for the poor.

Assuming all this can't be done—and it can't—Romney suggested that as an alternative the Federal government turn the entire housing program package over to the states—including the staffs of the FHA and HUD local and regional offices, and make block grants to the states with no strings attached. Romney listed other variations, including "partial decentralization" of housing programs to the states.

Romney also conceded:

"We can't just wash out the section 235 and 236 programs overnight. . . . We will certainly need several years for the transition if 235 and 236 are to be wound down at all."

Trial balloon. Some industry experts reported that Romney had cleared these suggestions with the White House, and they implied he was floating a balloon to indicate which way the Nixon Administration wind was blowing.

"Absolutely not," said one of Romney's closest associates.

Regardless of this, the Romney "alternatives" are clearly in line with the revenue-sharing, more-power-to-the-states philosophy that President Nixon endorses.

One reason for the go-slow approach is the political reverberations still ringing from the crashing last-minute collapse of the 1972 omnibus housing bill.

Nearly every interest group heaved a silent sigh of relief (some not so silent) over a bill that had so many controversial features that they—and the Democratic leaders of the House—much preferred to see it die before the legislators would find themselves having to take a public stand on it.

Prosperity. The fall-back position still holds: Just by continuing housing programs and housing subsidies as they were, housing starts are expected to reach 1.9 million in 1973. That's boom-level by comparison with any year except 1972, which is finally expected to chalk up the all-time record of 2.2 or 2.3 million starts. —DON LOOMIS

McGraw-Hill World News
Washington

TO PAGE 9

NORRIS INDUSTRIES, a new force in building products brings you ideas in decorative faucets

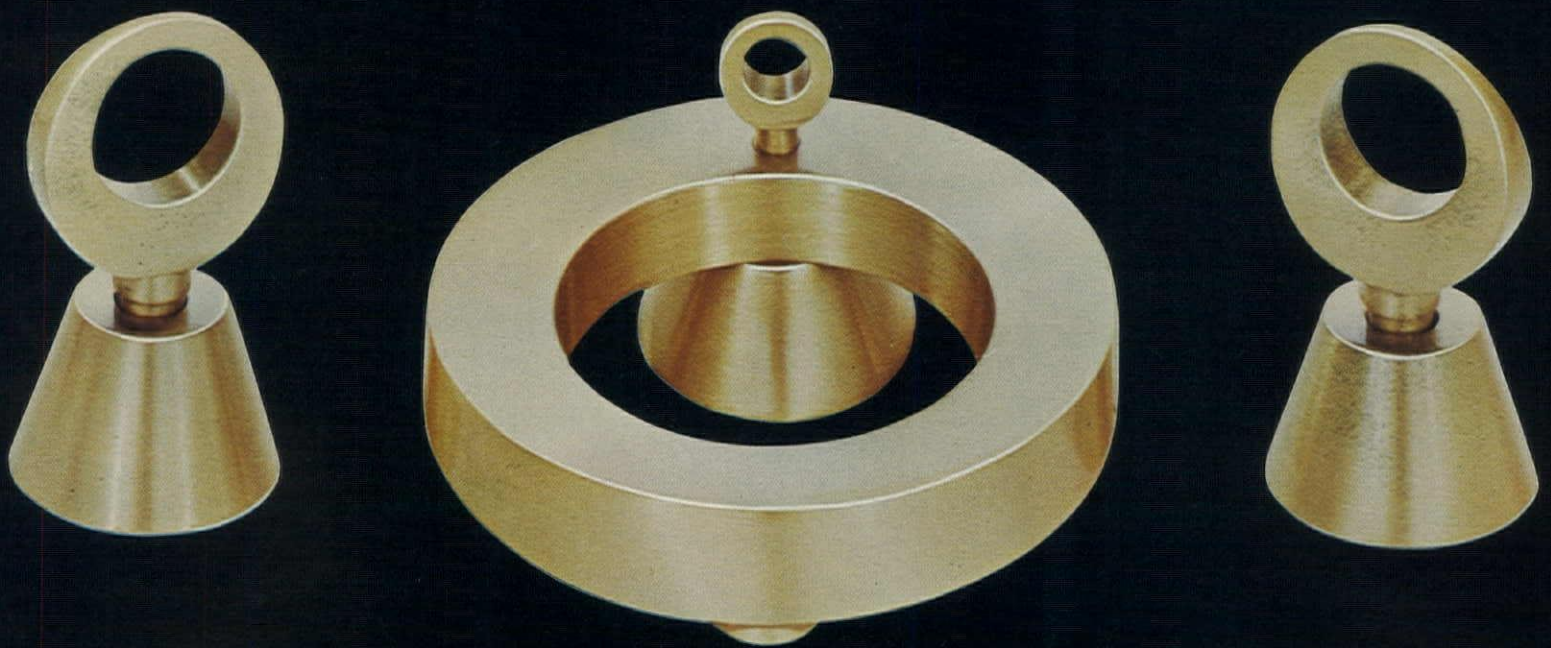

Ideas in decorative faucets from Artistic

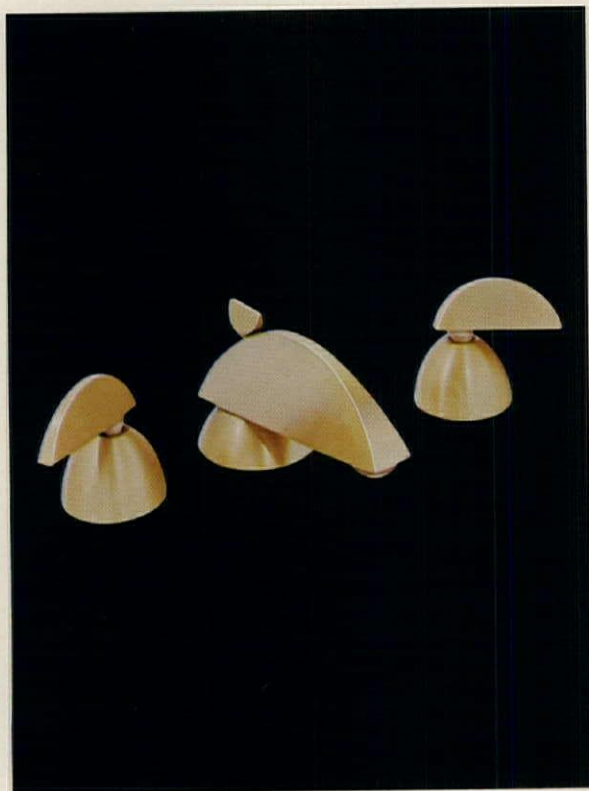

Libra — beautiful, balanced design

The late Frank Lloyd Wright derived great inspiration from nature's own architectural wonders... plants small or mighty as they might be. We think that Wright would appreciate the feeling of the LIBRA lavatory set, as it conveys the balance so important in the works of nature. In translating that balance to gleaming, functional metal, full recognition is paid to the wonders of our natural environment.

CIRCLE 60 ON READER SERVICE CARD

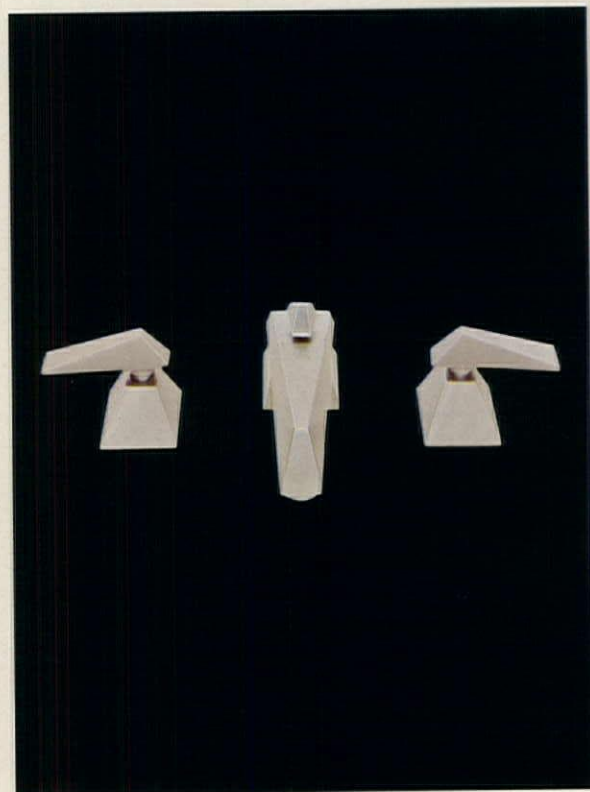

Aquarius — for the age in which we live

The age of Aquarius is all about us now...or so say the astrologers. In 1972 and in years to come we also see the age of gracious living brought within the reach of every householder in America. An important part of gracious living is including bathroom fixtures like the AQUARIUS lavatory set in the appointments of the home or apartment. Smooth, flowing lines emerge with a true contemporary feeling in this attractive bathroom fixture.

CIRCLE 61 ON READER SERVICE CARD

Brass, another **NORRIS INDUSTRIES** company



Aries — pioneering the look of luxury

Far out in space...light years away...the stars and constellations remind us of the infinity of the mighty universe around us. The ARIES lavatory set further reminds us that man has looked about the universe for inspiration in everyday life. The simple act of turning on a bathroom fixture in the morning becomes a part of gracious living, when you have the ARIES lavatory set in your bathroom.

CIRCLE 62 ON READER SERVICE CARD

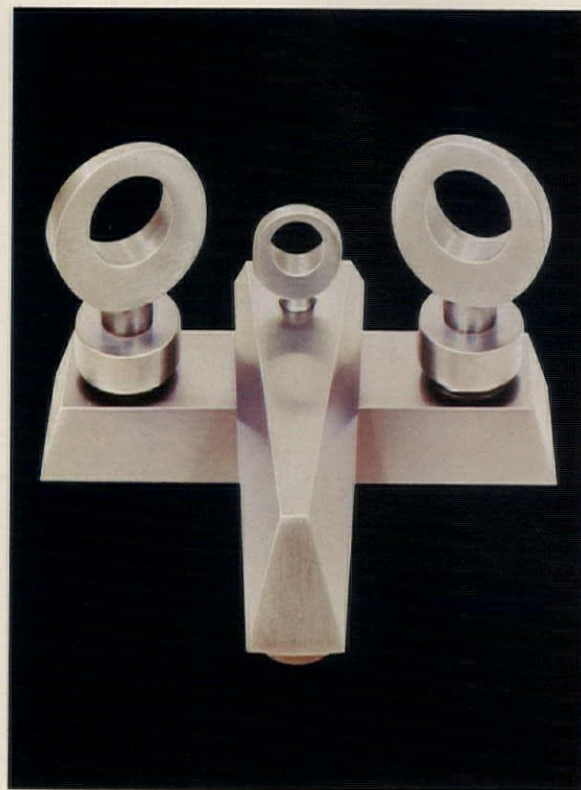

Pisces — clean, contemporary styling

Everything about the PISCES centerset speaks of adapting a classic motif to the contemporary bathroom setting...and beyond to Tomorrow. Here is styling that is free in form, clean and modern in its feeling, yet ageless in its beauty. Just the right addition to any of today's graciously designed bathrooms, in homes or apartments.

CIRCLE 63 ON READER SERVICE CARD

More ideas from **NORRIS INDUSTRIES,** a new force in building products.

IDEAS IN LOCK STYLES



WEISER LOCKS
4100 ARDMORE AVENUE
SOUTH GATE, CALIF. 90280

**CIRCLE 64 ON
READER SERVICE CARD**

IDEAS IN BATHROOM FIXTURES



PLUMBINGWARE
POST OFFICE BOX 157
WALNUT, CALIF. 91789

**CIRCLE 65 ON
READER SERVICE CARD**

IDEAS IN MAJOR APPLIANCES



WASTE KING-UNIVERSAL
3300 EAST 50th STREET
LOS ANGELES, CALIF. 90058

**CIRCLE 66 ON
READER SERVICE CARD**

IDEAS IN PLUMBING BRASS



PRICE-PFISTER
13500 PAXTON STREET
PACOIMA, CALIF. 91331

**CIRCLE 67 ON
READER SERVICE CARD**

IDEAS IN KITCHEN PRODUCTS



THERMADOR
5119 DISTRICT BOULEVARD
LOS ANGELES, CALIF. 90022

**CIRCLE 68 ON
READER SERVICE CARD**

IDEAS FOR THE ELECTRICAL CONTRACTOR

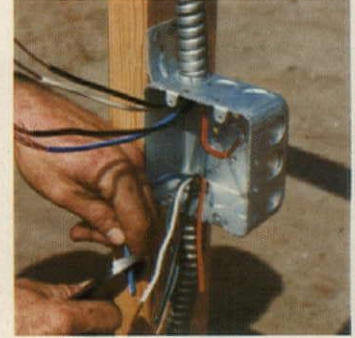

BOWERS
6700 AVALON BOULEVARD
LOS ANGELES, CALIF. 90003

**CIRCLE 69 ON
READER SERVICE CARD**

Winner and still champ in old Alabam—Senator John Sparkman at 72

John Sparkman met the challenge of the red-headed whiz-kid Winton Blount in their second voting showdown—and at 72 the senator won hands down.

Sparkman polled about 60% of the vote as a Democrat despite a record-breaking landslide for President Nixon, who took 80% of the popular vote in Alabama.

Blount, 51, had the active backing of the President, who put everything but himself into Alabama to support his former Postmaster General.

Sparkman had the active backing of George Wallace, Alabama's disabled veteran of the political wars.

In their first duel twenty years before, Sparkman and Blount had been fronting for somebody else—Sparkman as Adlai Stevenson's vice presidential running mate and Blount as the Alabama champion of the Eisenhower forces. The result was the same. Sparkman triumphed easily in Alabama.

Money men's role. This time



Congratulations come by telephone to Sen. John Sparkman at his election-night headquarters in Alabama. Senator's daughter, Mrs. Tazwell Shepard, and wife are with him.

the specter of Wisconsin's William Proxmire effectively whipped Alabama's and much of the nation's financial community into line behind the chairman of the Senate's powerful Banking, Housing and Urban Affairs Committee. In a Democratic Congress Proxmire would

have stepped into a defeated Sparkman's shoes.

The Sparkman-Blount contest started mildly enough, but as the Republican's challenge faltered, the tempo was increased to the point where both major candidates lost their tempers before the television cameras.

Old pro's technique. Both major candidates saw their mistake immediately, but it was the old pro, Sparkman, who turned the miscue to his own advantage. Speaking slowly and deliberately, with just the right touch of sadness in his voice, Sparkman presented himself as the aggrieved party.

Had some all-wise political observer but seen it, it was Sparkman all the way. His opponent carried such handicaps as slow mail deliveries, the hostility of organized labor and personal wealth as typified by his air-conditioned horse barns. Meanwhile, the veteran of 36 years in Congress was opening for Alabama voters his briefcase full of IOUs from them. Television spots and newspaper ads hammered home this theme:

"Whoever you are, wherever you live, you are benefitting from Sparkman legislation."

—WILLIAM MAHONEY
McGraw-Hill World News,
Montgomery

New Congress seems to settle back into old housing-as-usual stance . . . continued

FROM PAGE 4

1972 housing bomb is a demand by some members that housing legislation be taken away from the Senate Banking and Currency Committee entirely. They would hand it to a new and separate committee on housing and urban development. There's also talk of splitting the housing subcommittee up. These agitations will gain some support from the general movement toward congressional reform, and from the fact that—while the party balance shifted only slightly in House and Senate—all told, the 93rd Congress will have 100 new members. But the best guess is that the committee structure will remain as is.

Same old issues. Gross points out that the controversial issues of 1972 will remain the same in 1973, and with minor changes in committee membership, "these issues should be resolved in the same way."

Gross comes to this conclusion: "I expect only minor extension of programs before June 30 of next year (when the extensions expire), then I expect a period of one to two years of protracted consideration of new

programs and approaches, particularly with respect to the housing subsidy programs."

And same lobbyists. The National Association of Home Builders has launched its own counter-offensive in behalf of the subsidy programs.

Just after election the NAHB published a 160-page report, "*Federal Housing Subsidies: Their Nature and Effectiveness, and What We Should Do about Them*," by Anthony Downs of

the Real Estate Research Corp. of Chicago. That report had several conclusions and recommendations the home builders don't agree with. For instance, it said that the biggest single cause of housing problems is poverty, and a good way of tackling that directly would be through income maintenance programs.

But Downs concluded that Congress isn't about to adopt any such thing. The present subsidy programs—which he sees as

good programs—should be continued, he said, to produce 400,000 homes a year for the poor.

Same old bill. The home builders will hang in there for yet another omnibus housing bill. So will their supporters in Congress because, as one knowledgeable source put it: "The housing programs have not been able to fly by themselves. If a revamped urban renewal program came up for a vote all by itself, it would get murdered."

President Nixon's proposed new Department of Housing and Urban Development will definitely be tried again, as will his move for consolidating urban renewal and other community development programs into a block-grant program.

Sen. William Proxmire (D., Wis.) sees "a good chance for dramatic changes in housing" and hopes that the housing bill will be split up into separate parts.

The bottleneck on housing is the House, and the expectation is that the Senate won't be allowed to vote on housing this time around until it gets before it a bill already passed by the House. —D.L.

Preston Martin resigns as chief of Bank Board

Chairman Preston Martin of the Federal Home Loan Bank Board became the first high-ranking member of the Nixon team to leave his post after the election [News, Sept.].

He announced his resignation to the 7,000 bankers gathered for the 80th annual convention of the U.S. Savings & Loan League in Miami just one day after Wright Patman, chairman of the House Banking and Currency Committee, repeated his charge that "overly ambitious administrative grabs" by the Board were making sensitive issues in the S&L industry "more volatile."

Opposition. Patman opposes the conversion of mutual savings institutions to capital stock status and variable interest rate mortgages, two reforms that Martin had pushed.

Martin denied that his resignation had anything to do with policy differences. His reasons were "personal and familial," he said, adding, "It's time to get back into private industry."

Martin denied rumors that he would accept an executive position with Kaufman & Broad, the big Los Angeles-based homebuilder. K&B would only admit that they had talked to him.

Big builders see the 'underhoused' Northeast as the place to sell 'em

The push that began when half a dozen of the nation's largest builders moved into the New York area [News, Nov. '71] is now spreading to the Boston, Philadelphia and Washington, D.C., suburbs.

Kaufman & Broad of Los Angeles, the nation's largest publicly held homebuilder, and Hoffman-Rosner of Hoffman Estates, Ill., a large Chicago builder, both think the Northeast needs the sort of large-scale single-family building operations they can provide.

Kaufman & Broad has established a New England division to build single-family homes in Massachusetts, Connecticut and Rhode Island, and Hoffman-Rosner will concentrate first on the New York/Philadelphia corridor, eventually expanding to Boston and Washington.

And Centex Corp. of Dallas plans to begin building high-rise condominiums in the Washington suburb of Alexandria, Va. in March 1973. The company is already building a similar project in Palisades Park, N.J., across the river from New York City.

Void. Eugene S. Rosenfeld, president of K&B, explained his company's decision to move into New England:

"Our research has pinpointed New England as a market with a large void in \$20,000 to \$30,000 homes in desirable residential areas around city centers," he said. "We believe this market has been overlooked too long."

A Hoffman-Rosner official agreed. "You can't believe how underhoused the East is," he said. "There has always been a kind of resistance out there to the larger builders, and the smaller builders just haven't been doing the job."

Boston suburbs. Kaufman & Broad's first New England project will be to build 524 two- and three-bedroom homes in Stoughton, Mass., a Boston suburb. The company also has options on sites for 2,300 homes in other Boston suburbs, and it expects to expand into Hartford, Conn. and Providence, R.I. beginning next year.

K&B is already building in California, Illinois, Michigan, New Jersey and New York, and in Canada, France and Germany. (More than 2,500 families visited K&B's first German community, located in Wehrheim, ten miles north of Frankfurt, during its opening week. They bought 73 of the one- and two-family homes priced from \$45,000 to

MAURY LEVIN



K&B'S ROSENFELD
Eastward ho!

\$70,000, for a total of \$4.4 million in sales.)

The company believes that the New England division has a sales potential of \$20 million in its second full year of operation and foresees a strong continuing demand over the next several years.

Rosenfeld cited the present population of nearly ten million in Connecticut, Massachusetts and Rhode Island—the states where the division will operate. He also noted a low vacancy level and projections that the rate of household formations will increase during the 1970s as the basis for this forecast. He predicted that housing starts for the three states will be approximately 100,000 in 1972, up 20% from 1971, with the entire gain coming in the single-family home area. The company projects a similar increase in 1973.

New York area. K&B has already built a number of successful projects in central and southern New Jersey and on Long Island, N.Y. Recently it also took over development of Levitt's Cambridge Park project in Evesham Township, N.J., a Philadelphia suburb.

Showcase. Hoffman-Rosner has been building single-family homes in the \$20,000 to \$40,000 range in the Chicago suburbs. It will build the same type of homes in the Northeast in 1973, but it is not yet ready to disclose the sites.

A spokesman explained that the company plans to begin with several smaller projects, using these as a showcase.

Washington condos. The Centex project in Alexandria, Va., will consist of four high-rise condominiums containing one-, two- and three-bedroom units priced from \$30,000 to \$60,000. The Washington Metro Rapid Transit System has bought a portion of the site to build a subway station and parking area.

In addition to the Washington and New Jersey projects, the company has condominium developments under way in the Miami, St. Petersburg, San Francisco and Chicago areas.

Conservationists score in California, Colorado; voters uphold property tax

California conservationists won the hard-fought battle over proposition 20, the Coastal Protection Initiative, when voters approved the plan that will regulate building along California's 1,072 miles of coastline in a zone that extends 1,000 yards inland from mean high tide.

The housing industry, oil companies, public utilities and some labor unions had mounted a \$1-million ad campaign against the measure. They charged that it benefited only those who own beach-front homes and that it would cut the coastal cities in two, creating jurisdictional problems and making intelligent planning impossible.

Commissions. Proposition 20 sets up a 12-member California Coastal Zone Commission, plus six regional commissions, which will draw up a coastal conservation plan to be submitted to the state legislature in 1976. In the interim the state and

regional commissions will have veto power over all new developments.

Builder reaction. "It's a shame that the public must pay higher prices, not for better planning and product but because of additional cost borne by a developer because of the additional time spent working on a project through additional governmental bureaucracy," said Bill Deane, president of Deane & Deane of Half Moon Bay, Calif. Much of the company's land holdings lie within the permit area, where Deane is currently building 176 single-family homes, a golf course and a 400-room hotel.

Raymond L. Watson, executive vice president of the Irvine Co. of Newport Beach, echoed Deane's fear that the new rules would mean delays and higher costs, but added:

"Advocates of the proposition have assured us that our worst

fears about its impact would not be realized. They have told us that it was designed to encourage responsible land-use planning, not to obstruct it."

Irvine is planning a 10,000-acre resort along 3½ miles of coast between Newport Beach and Laguna Beach.

Approval. Eli Broad, chairman of Kaufman & Broad of Los Angeles, pointed to the ugliness of the oil facilities and some of the other things that had been built along California's coast and said that the new rule is "probably a step in the right direction."

Olympics. In Colorado, voters turned down bond issues that would have provided funds for the 1976 Winter Olympic Games. The anti-Olympic forces had feared that the games would set off excessive land development and building of recreational homes that would damage the environment.

Major developers surveyed denied that the games would have had a significant impact on building. Few new projects had been planned in anticipation of them, they said.

Property tax. In California, Michigan, Colorado and Oregon, voters defeated various proposals to abolish or restrict the use of property taxes to finance schools and other facilities.

The California proposals would have clamped tight ceilings on property taxes and raised corporate income taxes and various sales and excise taxes instead. It was beaten by nearly 2 to 1, as were the Colorado and Oregon proposals. The Michigan proposition was defeated by 58% of the voters.

The vote in favor of property taxes flies in the face of court rulings that financing schools with such taxes is unconstitutional. The issue is now pending before the Supreme Court.

1973's challenge: What can the builder put in... to take more out...sooner?

Leigh suggests some answers . . .





Does Leigh know builders and building?

Let's see...

You know the dollars you want to *take out* of a unit.
 You know how fast you must move that unit.
 How much to *put in*? And what? And where?
 The builder's eternal dilemma!
 Leigh thinks it knows its builder customers... and the tightrope they must walk.
 We understand. So—when we put in a feature it's there to help you with your bottom line... your take out.
 A feature that has real appeal to the buyer.

It must look smart... or sound solid... or operate smoothly.

Or it must cost you as little to install as is possible.
 When you look at the total cost for Leigh's *put-ins* we think you'll agree that we know how to help builders with their *take out*.

Talk to us. Or to one of the fine firms who help move our goods out to you from ten plants and four warehouses.

Leigh Products, Incorporated, Coopersville, Michigan 49404. 616/837-8141.



A. Leigh Deco-Glo electric fireplaces. One model mounts on wall or in corner. Three colors and four trim kits create 24 variations. Real wood logs.
 CIRCLE 93 ON READER SERVICE CARD

B. Leigh adjustable linen closet shelves arrive ready to install, complete with hardware. Do it in minutes with a screwdriver. Won't sag, buckle or warp.
 CIRCLE 94 ON READER SERVICE CARD

C. Leigh Glass Wall Thermo-Base® diffusers blanket window walls or sliding glass doors with warm air in winter, cool air in summer. Eliminate drafts.
 CIRCLE 95 ON READER SERVICE CARD

D. Ives hydraulic power closers for interior doors. Rugged steel construction. Unit is sealed—needs no adjustment.
 CIRCLE 96 ON READER SERVICE CARD

E. Ives door knockers for apartment doors, guest rooms. With number plate, card holder. Also available with one-way viewer. Hand polished solid brass.
 CIRCLE 97 ON READER SERVICE CARD

F. Leigh has a line of mail boxes that lock with a key. Exclusive scroll-type hinge shuts out weather. The style and quality found in higher priced models.
 CIRCLE 98 ON READER SERVICE CARD

G. Leigh colonial mailboxes of Cylolac® construction. Sturdy overlapping aluminum lid. Bronze eagle accent. Can really dress up the front of your units.
 CIRCLE 99 ON READER SERVICE CARD

H. Leigh duct-free range hoods are pre-wired for easy installation. Four sizes, four colors. Totally enclosed lighting.
 CIRCLE 100 ON READER SERVICE CARD

I. New Leigh decorator shutters are rust-proof aluminum. Soft matte finish. Won't warp, crack or rot. In Early American, Heritage and Classic designs.
 CIRCLE 101 ON READER SERVICE CARD

J. Leigh Turbo-Flo turbine powered humidifier runs on air from furnace blower. Low cost. Installs quickly. Needs no wiring or electrical hookup. Big water reservoir can't rust.
 CIRCLE 102 ON READER SERVICE CARD

K. Leigh undereaves and attic ventilators in natural or white enameled aluminum, or galvanized steel. Easy, quick installation. Meet F.H.A. requirements.
 CIRCLE 103 ON READER SERVICE CARD

L. Rutt Custom Kitchens, made by Leigh's Rutt-Williams Division. Every item is handcrafted of fine wood. Mortise and tenon

construction throughout. Wide variety of styles.
 CIRCLE 104 ON READER SERVICE CARD

M. Leigh power roof ventilators. Giant 9-bladed fan keeps air moving fast. Leigh patented design. Thermostat control. 144-sq. in ventilator fits over single rafter space. Meets F.H.A. requirements. 1000 CFM capacity.
 CIRCLE 105 ON READER SERVICE CARD

N. Leigh KLIP-LOCK suspended ceiling grid systems in baked-on white vinyl, electro-galvanized and wood grained steel. For homes, offices and stores. Interlocking tabs cut installation time and eliminate need for splice plates and connectors. Competitively priced and designed for those who want the best.
 CIRCLE 106 ON READER SERVICE CARD

O. Williams Vanities by Leigh's Rutt-Williams Division. Complete, top-quality bathrooms at modest cost. Everything—cabinets, tops, medicine cabinets, mirrors, and lighting—arrives together, ready to install!
 CIRCLE 107 ON READER SERVICE CARD

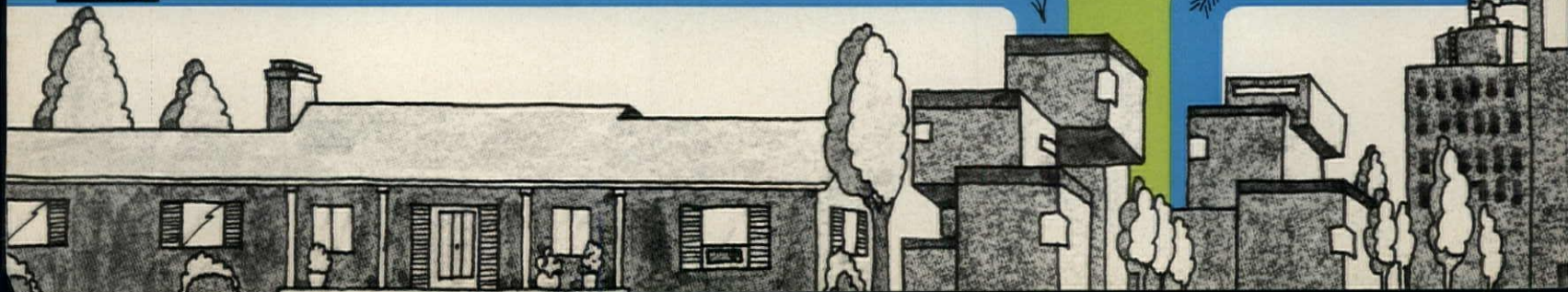

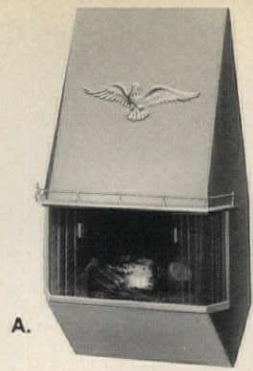

A.

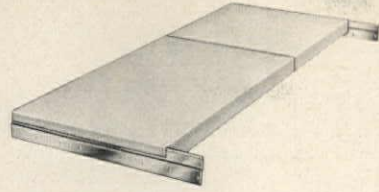

B.

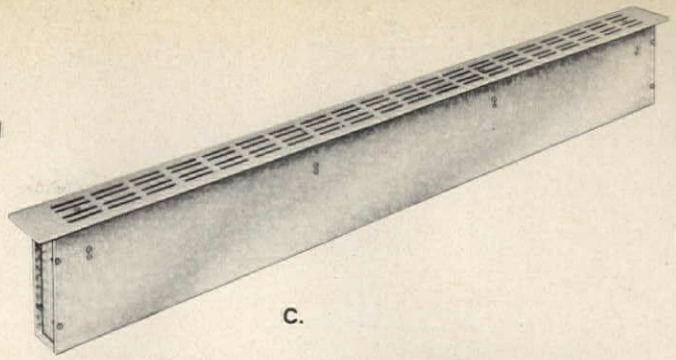

C.

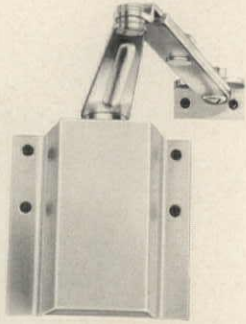

D.



E.



F.



G.

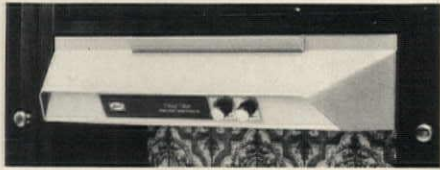

H.



I.

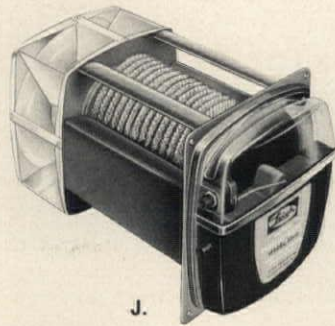

J.

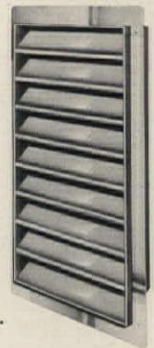

K.



L.



M.

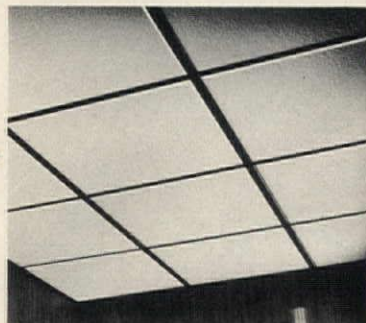

N.



O.

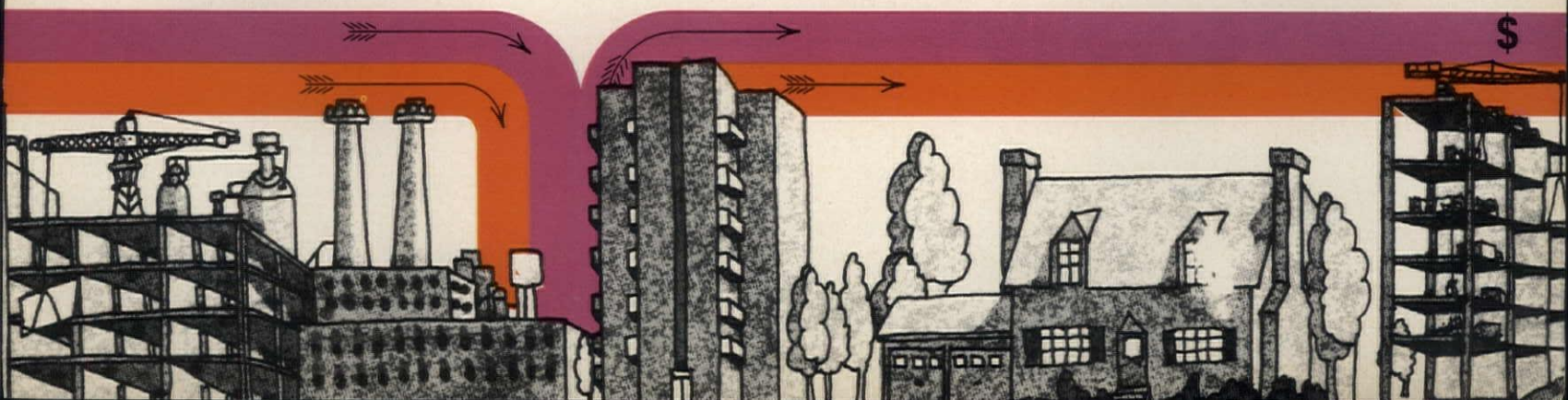



The complete closet... helps the builder save and sell!

Leigh closet doors and shelves can put you ahead in the put-and-take game. They add good looks, livability and value to your project... assure that you'll take out more than you put in.

See your distributor. Or write or call Leigh Products Inc., Coopersville, Michigan 49404. 616/837-8141.

Leigh Full-Vu Doors give you beauty that sells... simplicity that saves you money... and balanced suspension system that eliminates call-backs.

Leigh doors save you money from start to finish. The initial cost is less than wood. They're pre-finished in white... instant sales appeal as is—or as a base for colors of your choice.

The doors are formed in one piece from heavy gauge steel. Panels and louvers can't loosen or fall out. Installation is fast and easy.

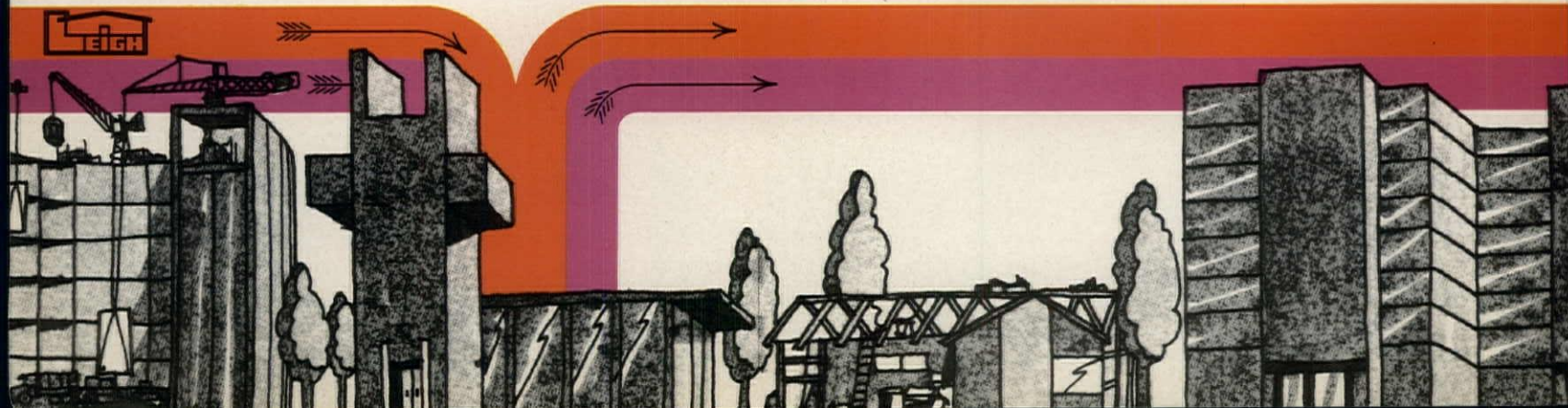



The Exclusive Balanced Suspension System assures smooth operation even in out-of-square openings. The doors never jump the track, and they can't sag, bind or stick. They're quiet, with built-in sound-deadening material.

Nine distinctive styles to choose from, in 6'8", 7'6" and 8'0" heights. In standard widths from 1'6" to 8'0".

CIRCLE 108 ON READER SERVICE CARD

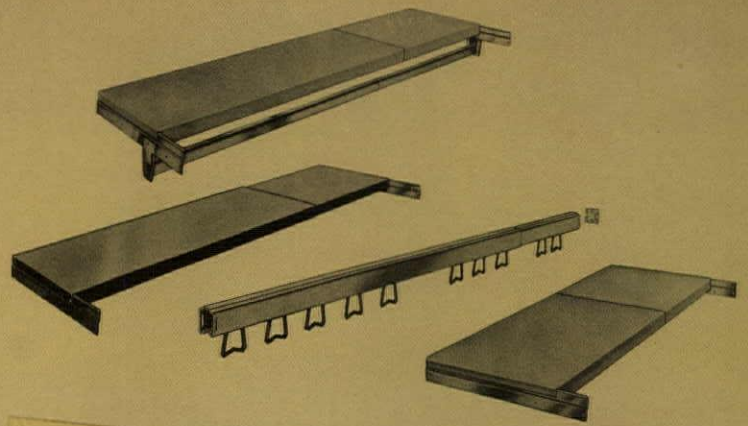

Leigh adjustable steel closet shelves cut your on-site labor costs 75%!

Leigh eliminates the costly cutting, fitting and finishing of wooden shelves.

And Leigh's efficient production, large volume sales and effective distribution services give you further savings by providing high quality at lowest costs.

Leigh shelves are pre-finished. They come to you complete with hardware, ready to install in minutes with only a screwdriver. They won't sag or warp.

Pre-finished in elegant white baked-on enamel. Protected with a scuff coat that keeps them new-looking for years.

Available with or without rods.

Leigh also makes adjustable linen closet shelves and a complete assortment of shelf mounting accessories.

CIRCLE 109 ON READER SERVICE CARD

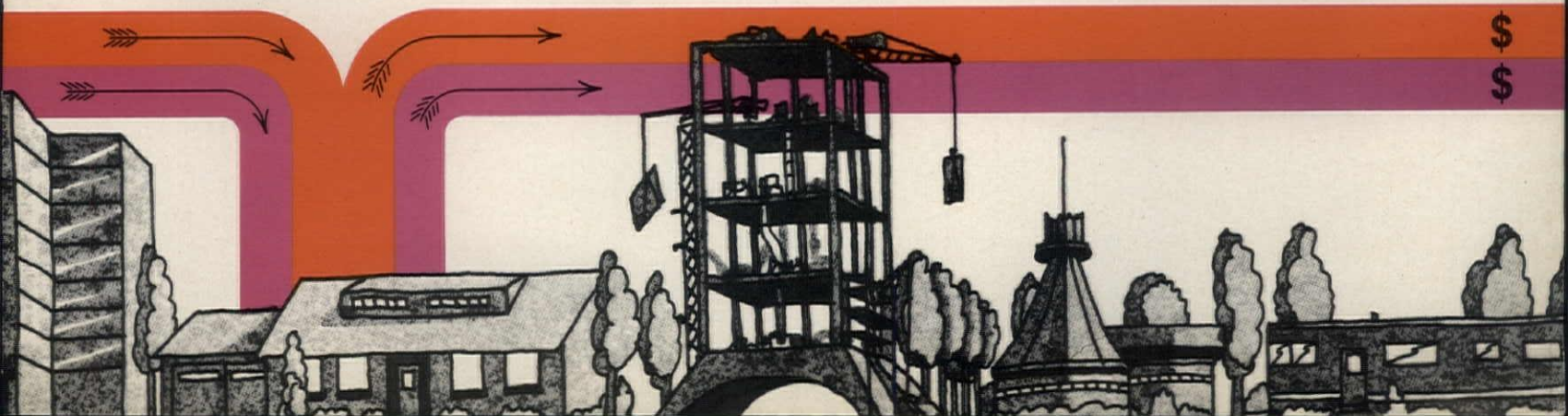



Will fine cabinetry pay out? Leigh's Rutt-Williams Division can help you decide.

Helping sell homes, apartments and townhouses in almost any price range is a job you can assign to Williams bathrooms. They're elegant. And efficient.

Mt. Vernon, shown, is one of Williams' many in-stock models.

Good news: A Williams bathroom is a complete, top-quality package at modest cost. Cabinets, tops, medicine cabinets and mirrors, and lighting arrive all together, ready to install. Cultured marble tops are available in white and three colors with integral bowls.

Or buy only those pieces that you find turn your prospects into customers. All promise to add beauty, sales appeal, *value* far beyond their cost!

To help you decide what to put in to take out more, send for the full-color Williams catalog: Rutt-Williams, Division of Leigh Products, Inc., 1536 Grant Street, Elkhart, Indiana 46514. Telephone 219/264-0631. Or contact your distributor of fine stock cabinets.

CIRCLE 110 ON READER SERVICE CARD



Now comes the challenge: dare you upgrade your kitchens with *custom* cabinetry?

The careful crafting of fine woods has got to cost you more than out-of-stock look-a-likes. Some builders of better homes have tried Rutt... and smile all the way to the bank.

Rutt kitchens combine beauty and practicality to an unmatched degree... and women can tell from across the room. We're building a new plant to keep up with the demand... and more than a third of our new business is in new construction.

The Georgetown kitchen at right is handcrafted of selected cherrywood. Fussy hand-detailing. Mortise and tenon construction. Blind dovetailed drawers on metal slides. Antique English Brass hardware finish. The china deck cabinets have real leaded glass doors. Even our Gourmet hood panel inserts are cherry.

For answers to your challenging questions—or a catalog showing the complete range of styles—write Rutt-Williams Division, Leigh Products, Inc., Goodville, Pennsylvania 17528. 215/445-2271.

CIRCLE 111 ON READER SERVICE CARD

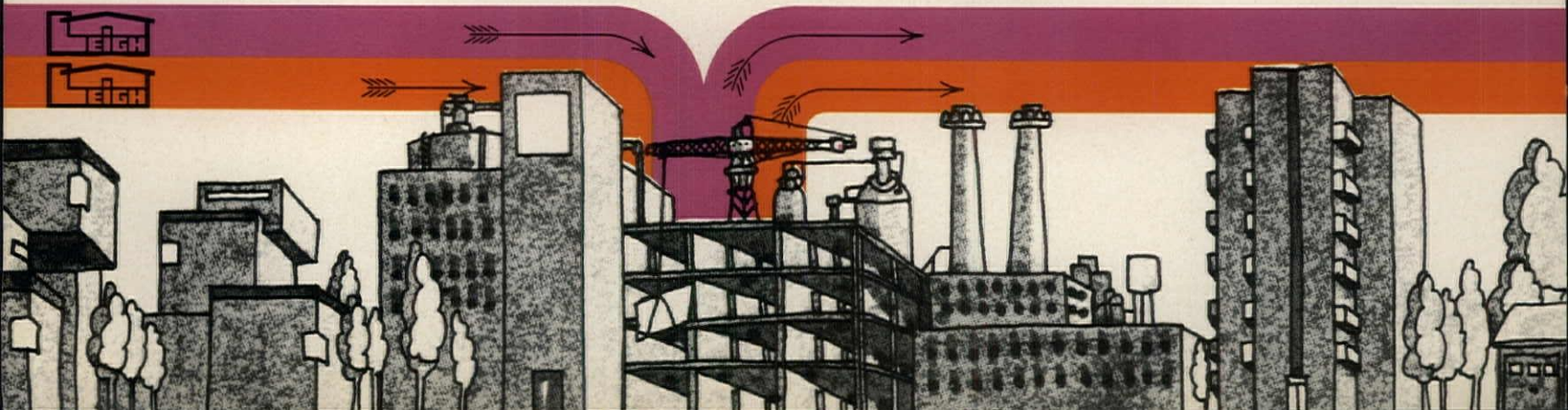



\$
\$



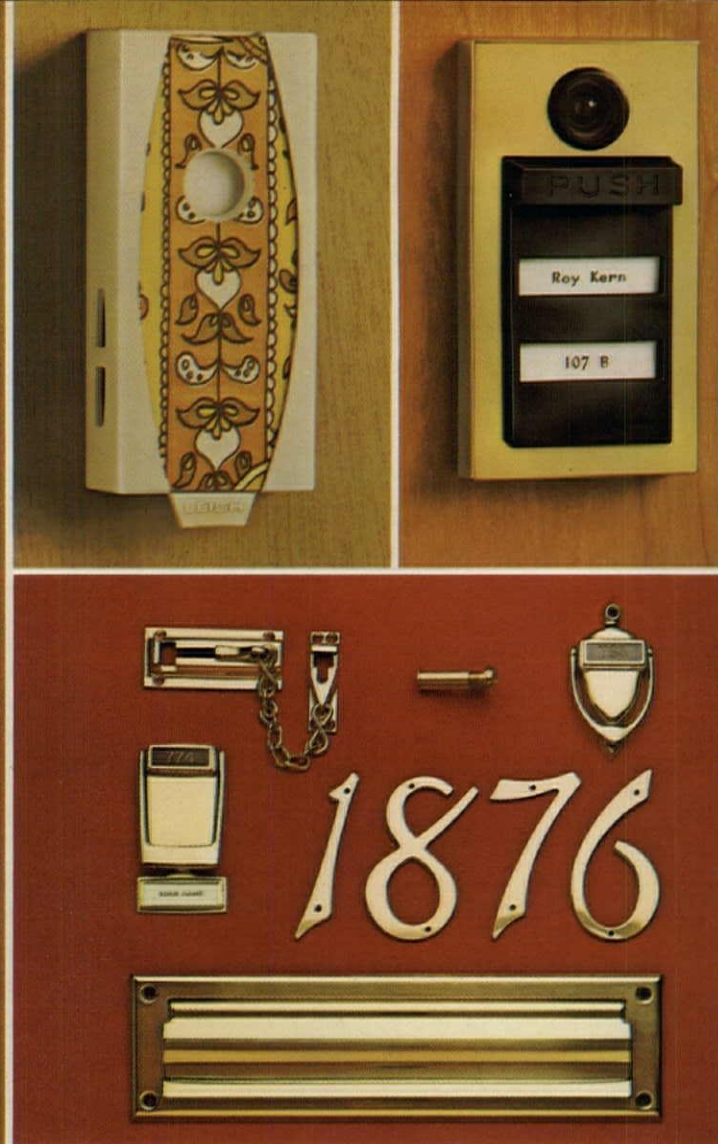
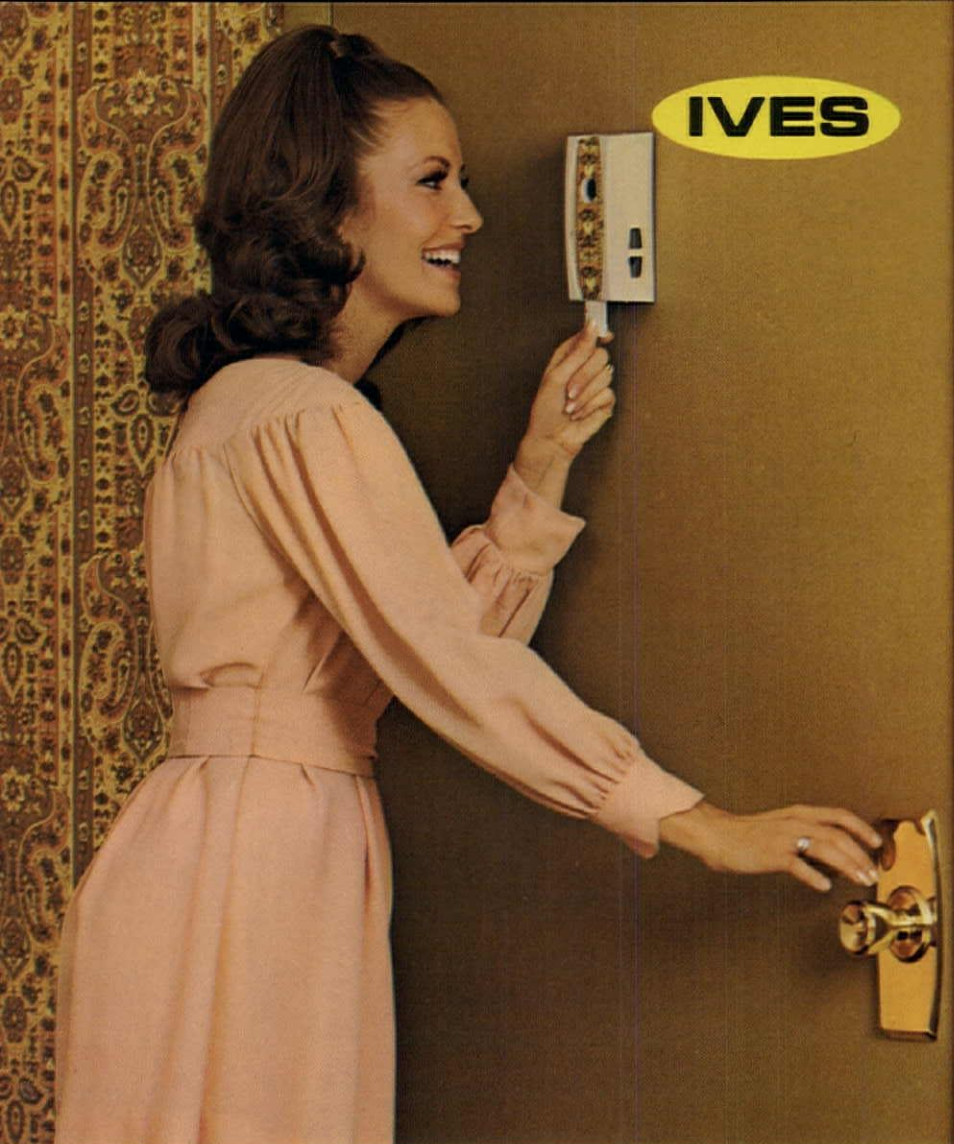

Over 90 years of builders' hardware experience has gone into Ives new, different door chime.

It's the first non-electric door chime with a decorator panel!

Inside decor of room or entranceway can be matched or complimented by papering or painting the panel recessed in the chime case.

Viewer with sliding shutter assures privacy, permits identification of caller, while melodious, two-tone chime affords ideal resonance and volume.

Outside, distinctively styled satin black push-bar frames the name and number cards, and is encased in a polished brass housing of traditional Ives quality.

Here's distinctive new smartness and convenience to appeal to your apartment, condominium or townhouse tenants.

Low in price, low in installation cost, Ives No. 790 chime requires no wiring, can be mounted in minutes.

Leigh's Ives Division has designed and made superior hardware for almost 100 years. Builders rely on Ives products for fast installation and outstanding quality. They can be specified for a wide range of projects and budgets. They add sales appeal . . . offering you the chance to take out more than you put in your project!

Ives Division of Leigh Products, Inc., New Haven, Connecticut 06508. 203/772-0310.

Write for the complete Ives Catalog or call your distributor today. CIRCLE 112 ON READER SERVICE CARD

Above: Typical Ives fine hardware: house numbers, chain door guards, letter box plates, one-way viewers, door knocker-viewers.

Quality You Can See... from



LEIGH PRODUCTS, INC.
COOPERSVILLE, MICHIGAN 49404



Commercial banks signal the mortgage market: You can bank on us this time

Don't count out commercial banks as a source of mortgage credit next year.

The myth dies hard that all bankers are graduates of the flinty Lionel Barrymore school of banking and that they run out on mortgage lending whenever credit tightens—as could happen in 1973.

There will always be some truth to that enduring tale, for the Federal Reserve operates through the banking system when it wants to pinch down inflation and the growth in the economy. The Fed has always found housing especially handy to squeeze.

But even if residential construction debt in bank portfolios dips next year, the decline is almost certain to be far more modest than in the 1966 and 1969-70 squeezes. Further, it could mask a more enduring if more slowly emerging trend for banks to increase their participation in the housing market.

Onward and upward. Bankers' rivals endorse this assessment. Says an S&L industry official:

"Banks, I'm sorry to say, will be a more substantial factor. So their volume dips next year—they won't close their mortgage departments, as a fair number did in 1966 and 1969-70."

Bankers agree. "In the past there was a tendency to turn the faucet off," admits Raymond O'Keefe, executive vice president of the Chase Manhattan in New York, "but now commercial banks are more closely wedded to real estate."

Clarke Stayman, senior vice president to the First National of Chicago and chairman of the American Bankers Association's real estate division, predicts that the banks' share of total real estate debt—which rose from 13.9% in 1960 to 16.5% in 1971—will keep on moving up slowly over this decade.

A politic approach. The banks' attachment to mortgages traces to several motives. Perhaps none is stronger than the perception that it would be politically dangerous to get out of step with the housing production goals of the 1968 housing act. When tight money did cause banks to cut back on mortgaging in 1969, Stayman recalls, the biggest bankers were called to Washington to have the public policy ex-

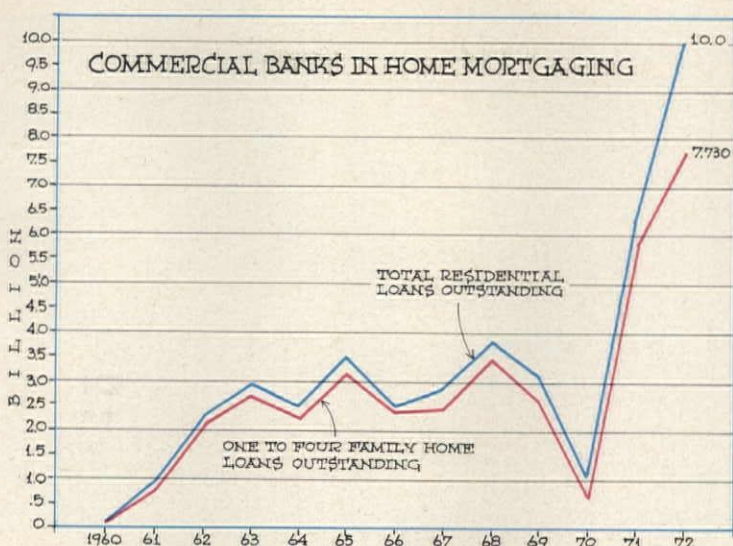

Commercial bank mortgage totals include construction loans. Figures do not include housing credit extended by REITs sponsored or mortgage companies owned by the banks. Data through 1971 are from the Federal Reserve; the data for 1972 are estimated.

plained to them.

But banks are now finding that social purpose and profit mix well, particularly in states that permit suburban branching—California and New York, for example. It is worthwhile to woo deposits and service income that affluent suburbanites are apt to bestow upon an institution that extends them a mortgage. The banks are also beginning to relish the deposit accounts of real estate developers.

Fringe profits. Philip Barrett, executive vice president of Citizens and Southern National in Atlanta, believes banks will soon be fighting to go deeper into the mortgage business on the premise that C&S has embraced: Income from interest on loans is going to decline, so fee income from services must increase.

Says Barrett: "A home purchase is the tallest financing transaction the average man ever makes. It is foolish for a commercial bank not to be involved, for a mortgage means you have a customer coming in each month for at least twelve years."

Once this customer begins to regard the bank as his own, he can be sold many services.

When the mosquito is mightier than the bulldozer

San Diego has come up with a new wrinkle: a mosquito moratorium.

The county's public health director, Dr. J.B. Askew, halted all building in three areas because the discharge of sewer effluent had caused excessive plant growth, rendering mos-

quito control impossible. The board of supervisors was still trying, several days after the moratorium, to find out how Askew imposed it without the board's knowledge. It shut down construction in the Alpine, Santee and Lakeside areas east and northeast of San Diego.

Risk of trouble. One new bank practice poses some threat. Liability management is daring modernization of technique from the banks' viewpoint, but it is one reason why the immediate outlook for bank support of mortgage finance is not unclouded. Liability management was developed by the free-wheeling First National City Bank of New York. It means that a bank searches out borrowable funds no matter how high the cost, so long as the return the bank itself can get on the money remains higher. Traditionally, banks had relied on deposits.

The catch to liability management is that the banks must roll over increasingly costly short-term liabilities when their lending is at longer and longer terms—mortgages, for instance. What would happen, asks Leonard Santow of Lehman Bros., the New York investment house, if Washington decided to prevent banks from getting these borrowable funds? Or if blue-chip corporations suddenly demanded to use their credit lines?

Mortgage dangers. Federal Reserve officials are blandly sure no

such contingency will arise in a form that threatens the banking structure. But the Fed is quite complacent about the possibility that a liquidity squeeze might be felt by banks on a scale that forces them to cut back their high volume of housing loans.

Some Washington officials wonder whether banks might not then pass up their commitments to make loans to the real estate investment trusts, which banks in increasing numbers are sponsoring. But O'Keefe of Chase, which has a REIT, insists that such credit obligations can't be palmed off: "The REIT's trustees wouldn't permit that kind of turnover, nor would we want it. We have to be purer than Caesar's wife."

The Coast's loss. California's bankers are, for somewhat different reasons, going to be tougher.

These bankers share the local concern about overbuilding. They are also bedeviled by a new political hazard, the concern among Californians for environmental quality. This has already added an environmental impact test to qualifications for building permits, and it may bar new construction within 1,000 yards of any river or the ocean.

John Vander Zee, vice president of the United Bank of California in Los Angeles, goes so far as to predict that the nation's housing starts will slump next year by almost half a million units—to 1.7 million—largely on the strength of cutbacks in California. These cutbacks, he acknowledges, will have to be made at the discretion of the banks. "Builders are like sheep," he says. "They follow one another."

And the nation's gain. One side effect of California's overdeveloped market may benefit the rest of the country, according to R. Gene Conatser, vice president of Bank of America in San Francisco.

California mortgage men have for years gone out of state for money—money they no longer need. So, while state law at the moment would deter it, Conatser is sure that later in the 1970s California may become an exporter of mortgage money.

—STAN WILSON
McGraw-Hill World News,
Washington

Developer tries a new way of selling vacation condominiums: by the month

The buyer may purchase his unit only for the time he wants to live in it, but he receives a deed and title, with all rights to resell and transfer ownership as he chooses.

At the same time he enjoys the advantages of renting: no large investment, no maintenance and repair, minimal expenditure for furnishings.

The builder expands his market from that small minority who can afford \$39,900 to \$140,000 for a second home to the considerably larger group who can afford \$4,000 to \$26,000.*

Eleven owners. The plan was developed by the Innisfree Corp. of San Francisco for its Brockway Springs development at Lake Tahoe. The company may resell a single unit as many as 11 times if all the buyers elect to take the minimum one-month share.

Innisfree charges a premium for its trouble, however. The least expensive unit, an 840-sq.-ft. one-bedroom townhouse that accommodates four, sells for \$51,900 to \$57,000. Under the time-sharing ownership plan, the company charges \$71,000 for the same unit.

The plan. Time-sharing ownership has been tried in this country before, but the Innisfree plan, which was copied from a technique that has been used successfully in France, offers a novel approach.

The buyer receives a grant deed stating that he has a one-eleventh undivided interest in a particular unit and an undivided percentage interest in the common areas of the project. The seller takes back a note secured with a deed of trust for the unpaid balance.

In addition, the buyer and Innisfree sign a separate agreement, which is recorded along with the deed, establishing the buyer's right to use and enjoy the unit for a certain period, his right to use the common-area facilities, and spelling out the maintenance to be provided, who is responsible for damage and other such details.

Differences. Other time-sharing plans are generally based on cross-deeding. This is less advantageous to the buyer because he is responsible for the whole unit even though he may own

*plus management fees and operating expenses.



New idea in condominiums: Brockway Springs, on the shores of Lake Tahoe, allows buyers to purchase a vacation condominium for only the time they may want to use it.

just a quarter share. For example, he may be held liable for payments that another buyer may miss. There is also the disadvantage of having to negotiate with co-buyers to set up schedules for the use of the unit.

David C. Irmer, president of Innisfree, says that his plan also has advantages over owning a vacation condominium outright and renting it part of the time.

"On the national average, someone who rents out his own vacation condominium for eight months of the year has 35 different families in it," he says. "And since they are renters with no equity interest, the chances are that they do not take as good care of the property as a time-sharing owner."

Still, Irmer plans to register with the SEC the 100 units he will build next year so that the company can handle rentals for any buyer who might want to rent his unit for all or part of his ownership period.

Project. The 37-acre Brockway project is being built on the site of the old Brockway Springs re-

sort hotel, which was famous for its hot springs. The community extends along 2,700 feet of lakefront, and all units have views of the lake and direct access to it.

The first phase of the project was built over a year ago by Wabash Consolidated, a subsidiary of Warner Consolidated of Cincinnati, Ohio. After about ten of the first 78 units were sold, Wabash entered into a marketing and sales contract with Innisfree that called for the companies to joint venture the balance of the land and the remaining units. These include 500 more condominiums and a 100-room hotel that will have a restaurant, bar and discotheque for the use of both condominium owners and hotel guests.

The company plans to build a little village at Brockway Springs complete with general store, beauty shop, barber shop and other stores. It is also planning a multi-purpose recreation building and a new boat dock. A tennis club has been built.

Cost. In dollars and cents, a 1,680-sq.-ft. three-bedroom, 2½-

bath townhouse for eight people would cost \$93,500 if a buyer purchased it outright. But if he bought it for two weeks in February and two in September, for example, his total purchase price would be \$8,000. Thus for \$2,559, an amount many families would spend on a summer vacation, a buyer could make a 25% down payment (\$2,000) plus pay for furniture (\$459) and closing costs (approximately \$100) and actually own one-eleventh of a condominium.

The \$6,000 balance would be financed over ten years at 10%, for monthly payments of approximately \$79.00, and operational costs for such items as insurance, utilities, maintenance, repairs, furniture replacement, management and property taxes would come to approximately \$510 a year, or \$42.50 a month. Thus the total monthly cost to the buyer would be about \$121.50.

Operation. The units are kept vacant for two weeks every six months for major maintenance, including complete cleaning, painting, replacing of furniture and checking appliances. There is a 24-hour period between each occupancy for cleaning the unit and checking the inventory.

Thus, when an owner arrives at his unit it is clean and ready for use. There are linens on the bed and one extra change of linen in the room. Additional services—such as daily maid service, laundry, bartenders and caterers—are available at an additional cost.

Future plans. Irmer envisages a future when people may buy a month in Brockway Springs, another in Acapulco, Mex., and perhaps one in Maui, Hawaii. The company is already negotiating for sites in these places and also in Flagstaff, Ariz. and Aspen, Colo. Irmer also foresees trading of units between owners in various locations.

At the same time, Innisfree's parent company, Hyatt Corp., is interested in buying resort hotels in various parts of the world and converting them into condominiums that can be set up as time-sharing investments, with the managers handling both rentals and hotel operation.

—JENNESS KEENE

McGraw-Hill World News,
San Francisco

For couples—free night in a mobile home

On the theory that if they try it they'll like it, a California developer is offering couples a novel free sample: a chance to try out the mobile-home life-style.

Rancho California, a residential community 58 miles north of San Diego, invites couples to spend two days and one night in a mobile home in its all-adult park.

"We give our Super Sample

guests a friendly welcome and tour of our park and then we leave them alone," says George W. Kingswood, manager of marketing communications. "We're confident they'll be thrilled with the comfort and convenience of this new life-style and so impressed with Rancho California's clean air, blue skies and beautiful country they'll want to return."



what
the world
needs now



PRICE PFISTER Manufacturers of Plumbing Brass • Pacolma, Calif. 91331 • Subsidiary of Norrls Industries

Andersen adds a finishing touch.

New Perma-Shield[®] Shutters



Now you can offer decorative shutters built to the same standards as Andersen Perma-Shield Windows and Gliding Doors.

Those standards being beauty, quality and durability.

These new shutters are natural partners of all windows and doors in the Perma-Shield line, so you can offer a complete, low maintenance, Perma-Shield package. But they match up just as well with almost any windows and doors. In either case, they add the selling points of beauty and low-maintenance to a home or any other building.

Even close up, Andersen Perma-Shield Shutters look like traditional wood shutters. Vacuum forming gives sharp details at the corners, and reproduces natural pine grain appearance on every panel and louver.

They are 1 1/8" thick with wide stiles, rails and center bars, giving both raised panel and louver styles a heavy reveal like real wood shutters.

But they have all the durability of Perma-Shield — the vinyl shell doesn't need painting, won't crack, chip or peel. Needs no maintenance. Korad® acrylic film on black units will not fade or bleach.

Rigid construction.

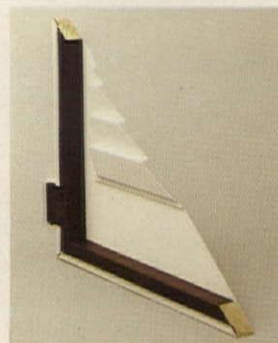

The toxic treated wood sub-frame means rigidity with lightness. Corners are mortised and tenoned and pinned. The center rail of the frame is glued to a rigid, one-piece vinyl shell. The vinyl shell is formed around the edge of the frame—this wrap-around

adds rigidity, locks the shell securely in place, and gives the look of a complete wood shutter.

Easy to install.

Andersen Perma-Shield Shutters fit varying exterior wall materials. A special mounting bracket is available for mounting on brick. A face-mounting package is also available for mounting the shutters to stone, brick, or other materials.

The shutters are held back against the wall by unique mounting hardware. All hardware is factory fitted, and made of zinc-plated steel with wrinkle-paint finish. Optional colonial-style shutter dogs add a touch of authenticity.

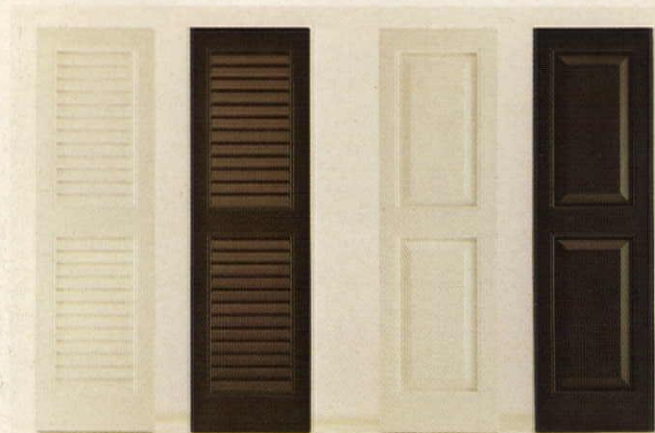

A beautiful match for almost any window or door.

With two styles—panel and louver; two colors—black and white; two widths—14" and 18"; and ten heights from 2'10" to 6'8", Perma-Shield Shutters offer a wide enough choice of size and style to look right, *be* right, with almost any window or door.

And they carry the Andersen name — always a good selling point.

For further information, talk to your Andersen dealer or distributor, or mail the coupon.



Mail to: Andersen Corporation, Bayport, Minnesota 55003
Please send information, including size tables, on Perma-Shield Shutters.

Name _____

Address _____

City _____ Zip _____

State _____

Visit us at NAHB. Booth 2410.
See all the new Andersen products.

Andersen Windowalls®
ANDERSEN CORPORATION BAYPORT, MINNESOTA 55003 

HH-122

Whither California? It's sprung a leak, and now it's spilling over into Nevada

For two decades it showed the way to the high, wide and handsome life.

For California was the promised land come true. It drew migrants from the world around, and it became the most populous of the 50 states without half trying.

Then its people began taking a harder look, and of a sudden California was paradise lost.

Today its former faithful are finding all the old problems they wanted to escape—plus some they hadn't even thought about: high taxes, overcrowding, freeways, smog, unemployment, riots, racial troubles, earthquakes.

New utopia. The search is on for a new utopia, and some people think it's next door.

Enough, in fact, so that Nevada is experiencing a housing boom unparalleled in its history. The 1970 census showed that the state's housing units had increased by 172,558—a whopping 69%—since 1960.

Blue sky and clean air remain the rule in Nevada. The smog and freeways have not yet invaded, and builder and buyer alike can still enjoy something of the relaxed outdoor life. The state's 110,000 square miles make it the eighth largest, and the result is that there is room to grow. The brooding landscape so forbidding to the state's early explorers has actually taken on an aura of mystery and romance, and part of Nevada's present-day attraction stems from this suggestion of something different.

And the boom goes on. For the first six months of 1972, construction is up 62.6% over 1971, itself a record year.

The census also shows a population of 488,738, a ten-year increase of 203,460. And 143,733 of this was due to migration. Government officials and builders agree that 90% of the influx is from California, and one state official, who has examined everything from automobile registrations to land sales, believes the ratio is even higher.

Housing market. In percentage terms Las Vegas is the nation's fastest growing metropolitan area, with a population increase of 115.2% in the last decade.

And it is still growing. The 1970 census showed a popula-

tion of 280,000; in 1971 it was 295,000; today it is estimated at well over 300,000.

This is reflected in building permits, which rose from 4,935 in 1970 to 7,919 in 1971 and an estimated 8,346 in 1972. De-

mand for new houses is beginning to be satisfied, however, and only 7,600 permits are predicted for 1973.

North to stability. Observers in Carson City, the state capital, say that the boom in the north-

DONALD DONDERO



The open desert is scene of Howard Homes condominium project northwest of Reno.

Mortgaging's J. Maxwell Pringle dies

J. Maxwell Pringle, widely regarded as the dean of New York City's mortgage brokerage fraternity in the 1960s, died in retirement at his home in Walnut Creek, Calif., on Oct. 26. He was 76.

Mr. Pringle was a pioneer in developing the private secondary market in FHA loans. He recognized in 1935 that the big eastern financial institutions would "buy" mortgages eastern anywhere else in the country.

From this concept was born a national mortgage market that was to become perhaps the housing industry's one most important facility in funneling large amounts of money from remote investors to builders in areas where capital was scarce.

His career. Mr. Pringle worked first through the mortgage department of a Wall Street investment house, Stern, Lauer & Co., but he founded Pringle-Hurd Inc. as a full-fledged mortgage brokerage in 1952. It became J. Maxwell Pringle & Co. in 1956 and it was placing \$150 million a year in mortgages when he sold out to Associated Mortgage Companies of Washington, D. C., in 1963.

It was in the mid-1960s that almost total blindness overtook Mr. Pringle, forcing a sharp curtailment of his business activi-

ties. Yet he remained a cheerful and familiar figure at mortgage conventions, appearing with his wife Anne and maintaining an intense interest in both the mortgage and bond markets. He retired as president of the Pringle company in 1965 and later moved to California.

And his legacy. Mr. Pringle's status as a pillar of the secondary market was widely recognized, but his role in the development of the instrument that is now described as the mortgage security was not nearly so well known.

In conjunction with the mortgage banking house of Weaver Bros. in Baltimore, Mr. Pringle developed one of the first securities ever backed up by—and sold in place of—the bulky FHA and VA loans themselves.

It was not until the mid-1960s that Metropolitan Life's collateral trust indenture appeared, and not until 1970 that the Government National Mortgage Assn. began to market pass-through securities and bonds in volume. These instruments have often been described as the most important developments in the mortgage market in half a century. They were all patterned in large part on the Pringle-Weaver mortgage security of the 1950s. —E. W. R.

ern part of the state, which some refer to as the New England of Nevada, is more important in the long term. They say that the glitter and glamor of southern Nevada attract a more transient population: People may go there to work on a seasonal or short-term basis.

The more conservative north, they believe, holds stronger attractions for those who come to stay—and for builders. The buyers are mostly retired or semi-retired persons who are not deterred by the lack of job opportunities in a state where gambling and tourism are the largest industries.

The biggest boom area is Lake Tahoe, at an altitude of 6,625 feet, astride the California border, despite a plethora of building restrictions and moratoriums [NEWS, March].

That boom is now spilling over into the valleys to the east. Carson City is a good example. Since 1970 the population has grown by almost a third, to 19,500, and the demand for housing has grown with it. In all of 1971, 15 permits were issued for multi-family homes totaling 163 units. In the first nine months of this year 14 permits were issued for a total of 149 units, and city authorities predict that new apartments will top 200.

Speculation. The story is the same in the Reno-Sparks area, which has an estimated population of 120,000. In 1969 only 437 new units were built. In 1970 the figures rose to 1,055 and in 1971 2,013. In the first nine months of 1972, 1,233 were built, and all were sold before completion.

The First American Title Co. of Nevada reported last month that it had just surveyed 796 new single-family houses in Reno-Sparks and found only 2% vacant. Apartment vacancies ran to only 1.8 percent, although 39% of 553 new townhouses remained unsold. There were virtually no vacancies in new single-family and townhouse units in Carson City, with only .02% of the multiples empty.

In the wealthy southwest section of Reno, in fact, one developer is building \$70,000 to \$80,000 homes on speculation—and he is selling them all before completion. —GUY SHIPLER

McGraw-Hill World News
Carson City

Miami-Carey. First choice for the final touches.



When you build you pay "attention to detail." When you install Miami-Carey products you add the "final touch" - style to speed the sale. Our 50 year reputation for quality keeps your customer sold.

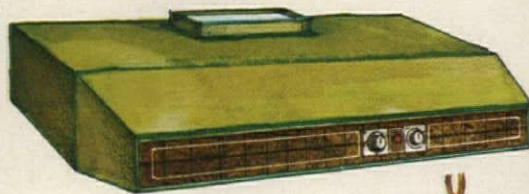

A sound investment

Miami-Carey door chimes add more than a decorative note. They greet your prospect with sight and sound to start the sale as she enters the home.

A range of range hoods

Whether you build apartments, condominiums or single dwellings Miami-Carey has the range hood you need. Vented or ductless - in the style, size, capacity or color you specify - we have it in our great new line.

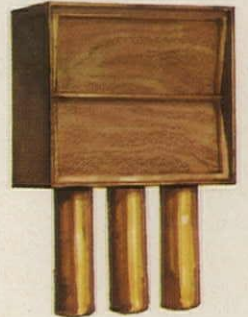

A reflection of quality

The Capistrano ensemble - one of the style leaders of our new bath cabinet and mirror line. Whatever price style or decor your homes require, specify Miami-Carey - the nation's leader in bath cabinets.



More than lights

To sell your houses you show them — to show them you turn on the light. Miami-Carey decorator lights add the "final touch" - warmth and beauty in the bath and throughout the house.

There's more to the Miami-Carey product line story, much more. Bathroom Accessories, Framed and Unframed Mirrors, Ventilating Fans, Heaters, and Washroom Equipment. We'll be glad to send you complete catalogs.

Visit with us in Houston NAHB Show - Booth 2214

All the more reason to specify

Miami-Carey

MIAMI
CAREY

203 Garver Road • Monroe, Ohio 45050

CIRCLE 25 ON READER SERVICE CARD



Introducing a beautiful side of

We don't have to tell you about GAF's existing roofing, flooring and siding products. Judging from the way you've accepted them, we know they've done a good job.

That's why we think you'll be pleased to hear that GAF is now in the vinyl siding business.

The name of our vinyl siding is Vanguard™. And that means leader.

Unlike non-vinyl sidings, Vanguard keeps its good looks all by itself.

That's because the colors, (there are 4 of them) go clear through the vinyl. So Vanguard won't show scratches, and never needs painting or finishing.

And since it's weather resistant, it won't rot or corrode either. Which means it'll last as long as the house you put it on.



GAF you've never seen before.

What's more, Vanguard's lightweight panels are much quicker and easier to install than most other types of siding. They can be cut and worked with ordinary tools. Special nailing flanges and preformed nailing slots help you put it up quickly and neatly. And, of course, there's no on-site painting or finishing for you either.

Finally this great new siding comes

with GAF's 20 year warranty against manufacturing defects.

Vanguard Vinyl from GAF. We think you'll be glad to have us on your side.

For further details, call your GAF Building Products distributor or write: GAF Corporation, Building Products Division, Dept. HH, 140 West 51 St., New York, New York. 10020



Houston builders find a route to instant millions—the water bond issue

Northwest Harris County utility district no. 1 outside of Houston, Tex., recently voted a \$4.5 million bond issue to provide water, sewage and drainage facilities.

There would be nothing unusual in this except that the district is a 600-acre parcel of raw land about to be developed by Marvin Eggett Inc. of Houston, and the \$4.5 million was voted by four people who had temporarily moved onto the tract in mobile homes.

A similar \$4.5 million bond issue was voted by the Cypress-Klein utility district. Again there were only four voters who had moved into the district temporarily. One was Chris R. Ploog, who was elected president. Ploog and Hansen H. Steel, a director of the district, are employees of Wimbledon Venture, which is developing the 367-acre tract. Wimbledon is a joint venture of McCrory-Hallbeck Development Co. and Domain Development of Houston.

This sort of thing happens all the time in the Houston area. It's perfectly legal.

Pay-later plan. The future homebuyers of the district and, eventually, the taxpayers of whichever nearby city annexes it are saddled with the cost of providing water, sewers and drainage—plus the interest on the bonds.

The developer doesn't have to pay a cent. The bond money covers such district organizational costs as engineers' fees, attorneys' fees, even the first three years' debt service on the bonds.

"It's a very fine arrangement," says one builder. "It gives us a form of financing that frees us from tying up large sums in utilities, so we can get down to providing first-class homes at an average of 10% to 15% less than they'd pay for comparable homes in other cities."

Complaints. Not everyone is enthusiastic. The Texas Water Commission thinks these districts should have to account to someone and file audits on how they spend their money.

And the *Houston Post*, one of the state's largest morning papers, ran a series of exposés charging developers with widespread abuses and pointing to loopholes in the laws which can



Notice of directors' meeting for the Harris County utilities district was found in a vacant pasture by Jim Simmons of Houston, who was searching for scrap tin. Texas law requires that such notices be displayed prominently "at a place convenient to the public."

allow a few people to get rich at the expense of taxpayers.

Flood control. The laws, which date from the early 1900s, were originally intended for flood control and irrigation. They make it possible for the state legislature, a majority of resident landowners or the owners of the majority value of a piece of land to form a water district. Such districts are empowered to tax, incur debt, take property by eminent domain, contract, sue and be sued.

Then, in the mid-1950s, developers found they were a convenient tool for financing water supply, sewage disposal, refuse collection and even fire protection.

Houston's advantage. Today Harris County, which encompasses the Houston metropolitan area, has more than 140 active water districts, many of them formed in the last ten years. There are another 40 in the

legal works and more on the drawing boards.

Although the laws under which these districts are created apply to the whole state, two thirds of the districts are in the Houston area. The reasons vary, but, in the main, other cities are simply less friendly to the concept than Houston is, and many, such as Dallas, are already hemmed in by suburban municipalities.

Critics. Even in Houston it is getting harder to play the water district game. Leonel Castillo, the new reform controller, has opposed Mayor Louie Welch on annexation of three such districts because they would add \$6 million to the \$32 million in bonded indebtedness the city has already picked up from other such annexations.

And the Texas Water Commission is drafting some rules to regulate the districts.

Several candidates in last

spring's primary election ran on platforms that included reform of water districts. But so far, at least, no one has come out for abolishing the system altogether.

"To say that water districts per se are bad and should be abandoned would be the height of foolishness," says David W. Tees of the University of Texas, who has been studying governmental districts for a special report to the governor. "State control should be tightened so that water districts cannot be formed so easily, and they can be abolished easier."

Proponents. There are some who view the system as a means to promote urban growth.

"It has worked here in Houston, so it's possible it could work elsewhere," says John T. Mitchell, a partner in the architectural-engineering-planning firm of McPherson-Mitchell & Moore.

"Such cities as San Antonio are looking at it as a means of solving some of their urban development problems," adds Frank Van Court, an attorney with Vinson, Elkins, Searls & Smith, the law firm with the largest water district practice in Houston.

But Tees is dubious about the system's prospects for success elsewhere:

"Houston had exactly the right set of combinations to make it flourish: water that is easy to find, a booming economy with people moving in every day and a city administration friendly to the district," he says.

Protest. In the meantime, the *Houston Post*, which had suspended its exposé during the primary campaign, has again begun printing stories with such headlines as "Two voters approve Bay Ridge bonds," and "Most water districts fail to audit expenses."

And if past experience is any guide, the advertising pages in its Sunday real estate section will drop from an average of 50 or 60 to a low of nine or ten as developers switch their ads to other papers to register their ire. They admit that the stories are for the most part correct, but complain that "they don't go far enough, and make it look like we're a bunch of crooks."

—BOB LEE

McGraw-Hill News, Houston

Levitt's \$4.2 million modular caper

ITT took a \$4.2-million write-off on preproduction costs applicable to ITT Levitt & Sons' modular plant in Battle Creek, Mich., Howard S. Geneen, ITT's chairman and president, revealed in announcing the company's third-quarter results. (ITT reported record income of \$111.9 million on sales of \$2 billion, up 11% from third quarter 1971.)

Geneen also admitted that there had been a 65% drop in net income from the operations of which ITT must divest itself to settle federal antitrust suits [News, Sept. '71]. These operations are Levitt & Sons, Avis Rent-a-Car, Canteen Corp., and Grinnell Corporation's fire protection division.

The company does not report its subsidiaries' results separ-

ately, but Geneen did announce higher earnings for Avis and Canteen Corp. Thus it appears likely that Levitt was responsible for a substantial portion of the 65% decline. Sale of a 23.3% interest in Avis in the second quarter and lower earnings for the Grinnell subsidiary also contributed.

New REIT handbook

The National Association of Real Estate Trusts has published the 1972-1973 *NAREIT Handbook of Member Trusts*, with data on 125 trusts with combined assets of \$7 billion.

Copies (\$40) are available from Robert Burr, executive director of NAREIT, 1101 17th St. N.W., Washington, D.C. 20036.

Introducing Triple Security!

with Kwikset's all new extra security cylinder deadlocks

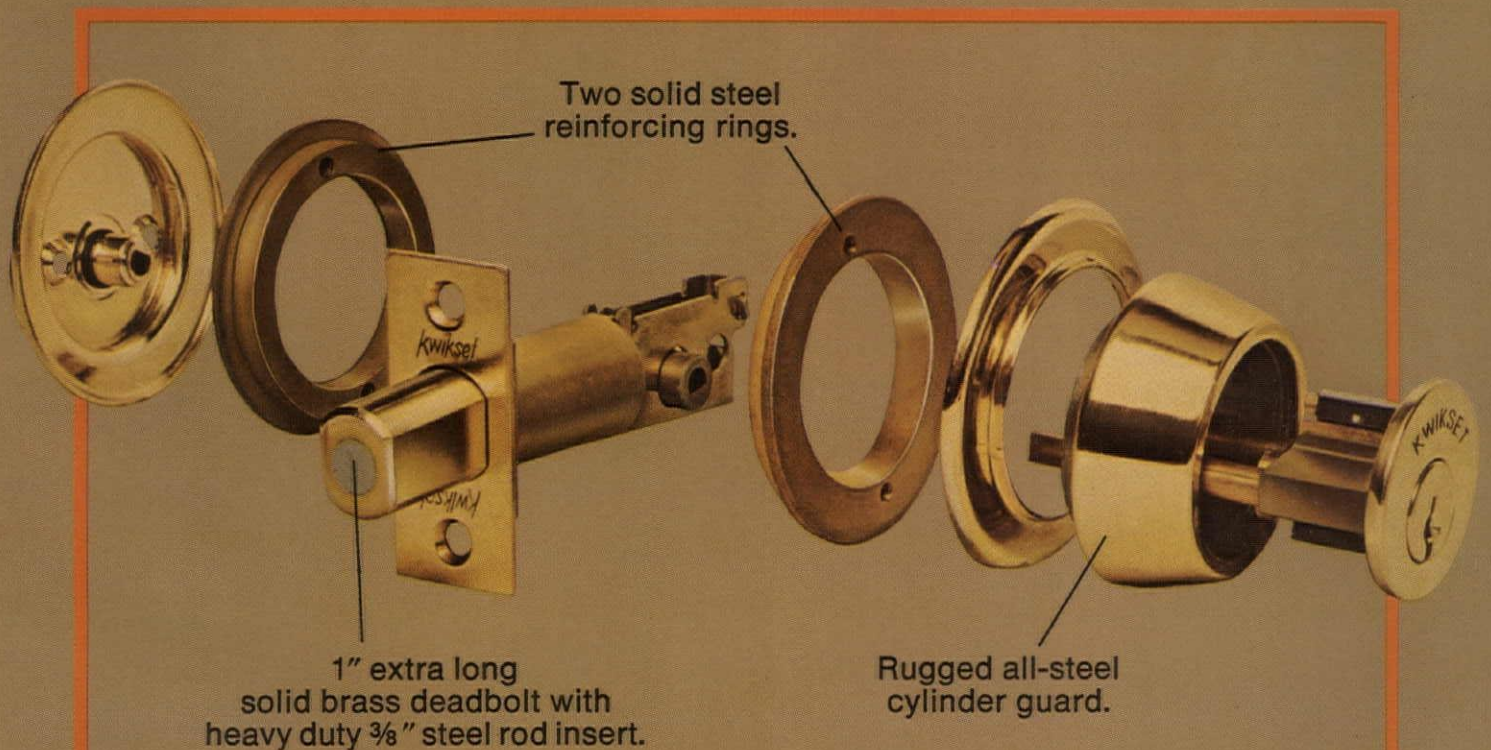

Kwikset's new 680 series cylinder deadlocks are distinguished by the very latest techniques in engineering, metallurgy and modern manufacturing methods. The result is a complete line of single and double cylinder extra security deadlocks that offer even greater protection than previous models. Now, every internal part in a 680-series deadlock is either solid steel or solid brass. Now, there are two heavy-duty steel reinforcing rings to resist pulling or prying cylinder from door. Now, the heavier steel cylinder guard is tapered and revolves

with any attempt to twist off with a pipe wrench or similar tool. Now, every 680 model features an exclusive massive double-size, (3 5/8" x 1 1/4"), heavy-gauge strike with four 1 1/2" staggered screws for maximum holding power to protect against kick-ins or break-downs. Now, the Kwikset 680-series meets all new building codes and is unsurpassed in the industry in value and security.

kwikset  **locksets**

America's Largest Selling Residential Locksets
Kwikset Sales and Service Company, Anaheim, California
A Subsidiary of Emhart Corporation

In Canada—International Hardware Company of Canada, Ltd., Bellville, Ontario



For everything from consider

Whether you're building apartments, condominiums or single family homes, don't make a decision until you've checked out Sears Contract lines.

These are appliances, designed with the Builder in mind—but the brand names are the ones many, many of your prospects buy at retail, with their own dollars. You know they've got quality.

And you can get them all from one single source, delivered to your schedule. Take a look:

Certified N.K.C.A. kitchen cabinets, an elegant example at the right prices from the long line offered by Sears.

Under-the-counter 1972 Kenmore Compactor. It compresses a week's-worth of trash and waste (for an average family of four) into 1/4th of its original volume and packs it in a poly-lined pick-up bag.

Kenmore Disposer makes quick, quiet work of food waste.

Kenmore Dishwasher has a porcelain finish liner for long wear.

Kenmore gas or electric ranges feature generous-sized ovens, no-drip cook tops, plus handy outlets for coffee maker, toaster, etc.

Vented or ventless hoods fit every Kenmore range.

Coldspot Refrigerator-Freezer is another 1972 Builder's line. Your choice of manual, automatic defrost or all-frostless operation. And you won't believe the value!

While you're at it, check our Contract Carpet Division for exciting new

cabinets to compactors, Sears.



Visit our booth number 1206 at the NAHB Show in Houston.

lines of Contract Carpet and Hard Surface Floor Coverings. One more way Sears stands ready to help you.

There are 10 good reasons why you should consider Sears.

1. Product leadership.
2. Dependable service.
3. Product quality.
4. Value/Price.
5. Strong brand recognition.
6. Delivery to your schedule.
7. Single source.
8. Contract Sales Specialists.
9. Kitchen planning available.
10. Over 85 years of customer satisfaction.

OK I'll consider Sears Contract Sales

Send brochure Send address of nearest Contract Sales office Have Contract Specialist call

Name _____ Position _____

Firm _____

Address _____

City _____ State _____ Zip _____

Sears, Roebuck and Co., Dept. 733G
303 East Ohio St., Chicago, Illinois 60611 (13-HH-1272 Kitchens)



suddenly: magnificence!
indoors and out



BUCHTAL

RUSTIC CERAMIC TILE

Magnificently impressive. Individualistic. Bold masses that make any place a place apart. Residences. Schools. Malls. Any place. Weather extremes? No effect. Maintenance? No need. Durability? No limit.

Exclusive U.S. representatives and distributors:
AMSTERDAM CORPORATION
41 EAST 42ND STREET, NEW YORK, N.Y. 10017
New York (212) 697-3300 • Philadelphia (215) 732-1492
Miami (305) 891-4331 • Oakland (415) 444-6050
Washington, D.C. (202) 529-8835
Call or write for free color brochures

NEWS/FINANCE

Mobiles drag stock average down

Mobile shares fell hard again despite a Kissinger market that raised prices on the big exchanges and buoyed most housing issues.

HOUSE & HOME's index of 25 housing industry stocks dipped to 527.64, from 529.22, in the month ended Nov. 1. The four other sections of the list managed gains, but the mobiles declined to 1,380 from 1,492.

One substitution was made. Commodore was factored into the mobiles' list to replace Guerdon, whose stock stopped trading when City Investing took over the company. The substitution did not affect the averages.

The index equates share values of January 1965 with 100. Issues on the index are overprinted in the lists.

Here's the 25-issue trace.

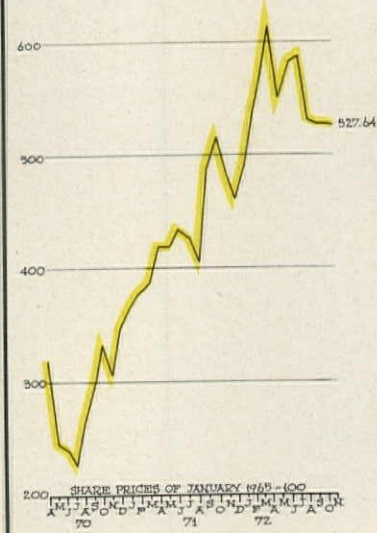

Here's how the five companies in each category performed.

	Nov. '71	Oct. '72	Nov. '72
Builders	557	450	451
Land develop.	551	367	370
Mortgage cos.	862	1,289	1,318
Mobile homes	1,285	1,492	1,380
S&Ls	202	234	241

Company	Nov. 1 Bid/Close	Chng. Prev. Month
BUILDING		
Alodex	4%	- 5%
AVCO Community Devel ^b	3 1/2%	- 1/2%
American Housing systems	5 1/4%	- 1%
American Urban Corp.	5%	+ 1/4%
Bramalea Cons. (Can.)	3%	- 1 1/2%
Building Systems Inc.	3%	- 1%
Capital Divers. (Can.) ^d	.56	-.02
•Centex Corp. ^e	28 1/2%	+ 1%
Chezem Dev. Corp. ^a	5 1/2%	+ 7%
Christiana Cos. ^b	4%	- 1%
Cons. Bldg. (Can.)	2.25	-.10
Dev. Corp. Amer. ^b	40%	+ 4%
Dev. Int. Corp.	3%	- 1/4%
Edwards Indus.	11 1/2%	- 1/4%
First Builders Bancorp.	4 1/2%	-
First Hartford Corp. ^b	4%	+ 3%
First Nat. Rlty. ^b	7%	-
FPA Corp. ^b	11 1/2%	+ 1%
Frouge Corp.	5 1/2%	- 1%
General Builders ^b	2%	- 1%
Gil Development	5%	-

Company	Nov. 1 Bid/Close	Chng. Prev. Month
Hallcraft Homes ^d	6 1/2%	- 1%
Hoffman Rosner Corp.	8%	- 1/4%
Homewood Corp.	19	- 2
Hunt Building Corp.	10 1/2%	- 1 1/2%
•Kaulman & Broad ^e	38 1/2%	+ 1/2%
Key Co. ^b	6 7/8%	+ 1 1/2%
Leadership Housing (Includes Behring Corp.)	6%	- 7%
Leisure Technology ^b	14%	- 3%
Lennar Corp. ^b	18 1/4%	- 3/4%
McCarthy Co. ^{hd}	5%	+ 1/4%
McKeon Const. ^b	6%	- 1 1/4%
H. Miller & Sons	13 1/4%	- 1/4%
National Environment (Sproul Homes)	1 7/8%	- 7%
L. B. Nelson Corp.	10 1/4%	- 1 1/4%
New America Ind.	6%	+ 3%
Oriole Homes Corp. ^b	31	+ 2
Pref. Corp. ^b	10%	- 1/4%
Presidential Realty ^b	12%	+ 1 1/4%
Presley Development ^b	13 1/4%	- 3/4%
Pulte Home Corp. ^b	8	+ 3%
Robino-Ladd Co. ^b	13%	+ 7%
•Ryan Homes ^b	28 1/4%	+ 1%
Ryland Group ^b	45 1/2%	+ 3 1/2%
Shapell Industries ^c	22	- 5%
Shaller Corp. of America	7 1/4%	- 3/4%
Standard Pacific ^b	4	- 1/4%
Universal House & Devel. ^b	3 1/4%	- 5%
•U.S. Financial ^c	24	- 4 1/2%
•U.S. Home Corp. ^e	27%	- 1%
Valley Forge Corp.	10%	+ 7%
Jim Walter ^e	28 1/4%	+ 1
Washington Homes	7%	- 1/4%
Del. E. Webb ^c	8%	+ 1
Western Orbis ^b	2 1/4%	-
Westchester Corp.	10%	+ 3%

SAVINGS & LOAN ASSNS.		
American Fin.	19%	+ 3
Calif. Fin. ^c	7%	- 3%
Citizens S&L Assn.	33%	-
Empire Fin. ^b	14	- 1/2
•Far West Fin. ^c	11 1/4%	+ 3%
Fin. Corp. of Santa Barb. ^b	31	+ 1 1/2%
•Fin. Fed. ^c	27%	+ 2 1/2%
•First Charter Fin. ^c	34 1/4%	+ 3%
First Lincoln Fin.	5%	-
First S&L Shares ^b	26%	- 3%
First Surety	5	+ 5%
First West Fin.	2 7/8%	+ 3/4%
Gibraltar Fin. ^c	29 1/2%	+ 1%
•Great West Fin. ^c	33%	+ 7%
Hawthorne Fin.	14%	+ 1%
•Imperial Corp. ^c	17 3/4%	+ 1%
Trans-Coast Inv.	6%	- 1%
Trans World Fin. ^c	15 1/4%	+ 3%
Union Fin. ^b	12%	+ 3%
United Fin. Cal. ^b	14	-
Wesco Fin. ^c	17 1/2%	+ 1%

MORTGAGING		
Charter Co. ^b	24%	- 2 1/2%
CMI Investment Corp. ^b	72	+ 5 1/2%
•Colwell ^c	19%	- 2%
Cont. Illinois Rlty. ^c	21 7/8%	- 1%
Excel Investment ^b	28	+ 3%
Fed Nat. Mtg. Assn. ^c	21%	+ 3
Financial Resources Gp. (Globe Mortgage)	3%	+ 1/4
First Mtg. Ins. Co.	28	+ 3
•Lomas & Net. Fin. ^c	23 1/2%	- 1/2%
•MGIC Inv. Corp. ^c	78 1/4%	+ 2%
Midwestern Fin. ^b	16%	- 4 1/4%
Mtg. Associates	21 1/2%	+ 1 1/2%
Palomar Fin. ^b	8%	- 5%
So. Cal. Mort. & Loan Corp.	11 1/2%	+ 1 1/4%
UPI Corp. ^b	2%	+ 1/4
(United Imp. & Inv.)		

MORTGAGE INV. TRUSTS		
Allison Mtg. ^b	29%	+ 3%
American Century ^b	24 1/2%	- 1%
Arlen Property Invest.	15 1/2%	+ 3%
Atico Mtg. ^c	22%	+ 3%
Baird & Warner	20%	+ 3%
BankAmerica Rlty.	28%	+ 1%
Bennett Mtg. Tr.	27 1/2%	-
Beneficial Standard Mtg. ^b	28 1/2%	+ 1 1/2%
Cameron Brown	31	-
Capital Mortgage SBI	27 1/2%	+ 1 1/2%
Chase Manhattan ^c	61%	+ 3
CI Mortgage group ^c	25	+ 1 1/4%
Citizens Mtg. ^b	15%	+ 1/2%
Citizens & So. Rlty. ^c	34%	+ 2 1/2%
Cleve. Trust Rlty. Investors	21 1/2%	+ 1%
Colwell Mtg. Trust ^b	29%	-
Conn. General ^b	26 1/4%	+ 1/4
•Cont. Mtg. Investors ^c	12%	- 3%
Cousins Mtg. & Eq. Inv. ^c	26%	+ 1
Diversified Mtg. Inv. ^c	28%	+ 1%
Equitable Life ^c	29 1/2%	- 7%
Fidenco Growth Inv. ^b	39	+ 3 1/4%
Fidelity Mtg. ^b	33 1/4%	+ 2 1/2%
First Memphis Realty	20%	+ 5%
•First Mtg. Investors ^c	25 1/2%	+ 1
First of Denver ^b	21 1/2%	+ 3%
First Pennsylvania ^c	26%	+ 1 1/2%
Franklin Realty ^b	8 1/2%	- 1%
Fraser Mtg.	22 1/2%	+ 1 1/4%
Galbreath Mtg.	28 1/2%	+ 1/4%
Great Amer. Mtg. Inv. ^c	34%	+ 2
Guardian Mtg. ^b	45 1/4%	+ 4%
Gulf Mtg. & Rlty. ^b	19 1/4%	+ 3%
Hamilton Inv.	17%	+ 1 1/2%

Company	Nov. 1 Bid/Close	Chng. Prev. Month
Heitman Mtg. Investors ^b	14%	+ 1
Hubbard R. E. Investments ^c	21	- 1/8
Larwin Mtg. ^b	30	+ 2
Lincoln Mtg. ^b	9%	+ 1/8
Mass Mutual Mtg. & Realty ^a	29 1/2	+ 3 1/2
Median Mtg. Investors.....	13 1/4	+ 1/8
Mony Mtg. Inv. ^c	13 1/2	+ 3/8
Mortgage Trust of Amer. ^c	23%	+ 1
National Mortgage Fund.....	14%	+ 1/4
North Amer. Mtg. Inv. ^c	33%	+ 3 1/8
Northwestern Mutual Life Mtg. & Rlty. ^c	24%	- 1/8
PNB Mtg. & Rlty. Investors ^b	24%	+ 3/8
Palomar Mtg. Inv. ^b	16%	+ 1 1/8
Penn. R. E. Inv. Tr. ^{bd}	12	- 1/2
Property Capital ^b	27 1/4	+ 2 3/4
Realty Income Tr. ^b	13%	- 3/8
Republic Mtg. ^b	18%	+ 1/4
B. F. Saul, R.E.I.T. ^c	23%	- 1/8
Security Mtg. Investors ^b	14%	+ 1 1/8
Stadium Realty Tr. ^c	9	- 3/4
State Mutual SBI ^b	25 1/2	+ 7/8
Sutro Mtg. ^b	18%	+ 1 1/4
Unionamerica Mtg. & Eq. ^b	26%	+ 2 3/8
U.S. Realty Inv. ^b	15 1/2	+ 1/8
Wachovia Realty Inc. ^c	33	+ 1
Wells Fargo Mtg. ^c	24%	+ 3/8

LAND DEVELOPERS

All-State Properties.....	1 1/4
American Land.....	.04	- .02 1/4
•AMREP Corp. ^c	17	+ 2 1/2
Arvida Corp. ^c	11 1/8	+ 1 1/8
Atlantic Imp.....	5
Canaverl Int.....	2 7/8	- 3/8
Cavanagh Communities ^c	6 1/8	- 3/8
Crawford Corp. ^c	5
•Deltona Corp. ^b	21	- 1 1/2
Disc. Inc. ^c	3 1/8	+ 1/4
Fairfield Communities.....	2%
•Gen. Development ^c	13 1/2	- 3/8
Getty Financial Corp. ^c	6 1/4
(formerly Don the Beach-comber)		
•Holly Corp. ^b	1 1/2
Horizon Corp. ^c	14 1/8	- 6 1/8
Landmark Land Co. ^b	3 1/4
(Gulf State Land)		
Land Resources.....	2 1/4	- 7/8
Major Realty.....	7 7/8	- 1/8
•McCulloch Oil ^c	20%	+ 3/8
Southern Rlty. & Util. ^b	5 1/2	- 1/2

MOBILE HOMES & MODULES

•Champion Home Bldrs. ^b	14%	- 2 1/4
•Commodore Corp. ^b	8%	- 3/4
Conchemco ^b	13%	- 3/8
De Rose Industries ^b	5%	- 1 1/8
•Fleetwood ^c	28%	+ 1/8
Golden West Mobile Homes ^b	11%	- 1 1/8
Moamco Corp. ^b	11%
(formerly Mobil Americana)		
Mobile Home Ind. ^c	16%	- 1 1/2
Monarch Ind. ^c	3	- 3/4
•Redman Ind. ^c	23%	- 3/8
Republic Housing Corp. ^c	8%	- 2
Rex-Noreco ^c	6	- 1
•Skyline ^c	44 1/4	- 3 1/2
Town & Country Mobile ^b	6%	+ 1/8
Triangle Mobile.....	3 1/4	- 3/8
Zimmer Homes ^b	7 1/8

Albee Homes.....	1 1/2	- 3/8
ASM Ind. (Formerly AABCO) ^c	7%	- 3/8
Brigadier Ind.....	4%	- 3/8
Environmental Communities.....	3 1/4	+ 1/4
Hodgson House.....	5 1/4	- 3/8
Liberty Homes.....	6%	- 1 1/2
Lindal Cedar Homes.....	7 1/2	- 3 1/2
Modular Dynamics.....	2 1/4	+ 1/4
Modular Housing Systems.....	5	- 1 1/4
Nationwide Homes ^b	10 1/2	+ 1/2
Shelter Resources ^b	13 1/4	- 1/2
Stirling Homex.....	25	+ .03
Swift Industries.....	1%	- 3/8

DIVERSIFIED COMPANIES

Amer. Cyanamid ^c	33%	- 3/8
Amer. Standard.....	11 1/4	+ 1/2
(Wm. Lyon)		
Arien Realty & Develop. ^c	13%	+ 3/8
AVCO Corp. ^c	15 1/2	- 3/4
Bethlehem Steel ^c	25 1/2	- 3 1/8
Boise Cascade ^c	11%	+ 2
CNA Financial (Larwin) ^c	21%	+ 2 1/4
Castle & Cooke ^c	17%
(Oceanic Prop.)		
CBS (Klingbeil) ^c	50%	- 2 1/2
Champion Int. Corp. ^c	20%	- 1 1/4
(U.S. Plywood-Champion)		
Christiana Securities.....	184	+ 5 1/2
Citizens Financial ^b	8%	- 1/2
City Investing ^c	14%	+ 3/8
(Sterling Forest)		
Corning Glass ^c	255 1/2	+ 37 3/4
Cousins Properties.....	24%
Dreyfus Corp. ^c	15	+ 1/2
(Bert Smohler)		
Environmental Systems.....	13	+ 2
Evans Products ^c	21%	- 1/8
Ferro Corp. ^c	45%	+ 3 1/8
First Gen. Resources.....	1 1/2	- 1/4
Fischback & More ^c	66 1/2	+ 6 1/2
Forest City Ent. ^b	14 1/2	- 1/4
Flagg Industries ^b	6	+ 3/8

Company	Nov. 1 Bid/Close	Chng. Prev. Month
Frank Paxton Corp.	14%	+ 1 1/4
(Builder Assistance Corp.)		
Fruehauf Corp. ^c	33 1/8	- 1 1/8
Fuqua Corp. ^c	19%	+ 2 1/2
Georgia Pacific ^c	40%	+ 1 1/2
Glasrock Products ^b	8%	- 1
Great Southwest Corp. ^c	1%	+ 1/8
Gulf Oil (Gulf Reston) ^c	23 1/2	- 1/4
INA Corp. (M. J. Brock) ^c	48 1/2	+ 5 1/8
Inland Steel (Scholz) ^c	32 1/2	+ 2 1/8
International Basic Econ.....	5%	- 1/4
International Paper ^c	37 1/2	+ 2 1/4
Internat. Tel. & Tel. ^c	54 1/4	+ 3/8
(Levitt)		
Investors Funding ^b	8%
Killearn Properties ^b	12	- 2
Leroy Corp. ^c	7	- 3/4
Ludlow Corp. ^c	20%	+ 1/4
Monogram Industries ^c	11 1/4
Monumental Corp. ^c	64 1/4	- 2 1/4
(Jos. Meyerhoff Org.)		
National Homes ^c	10%	- 2 1/8
Occidental Petroleum ^c	13%
(Occ. Pet. Land & Dev.)		
Pacific Coast Prop. ^b	2%	- 1/4
Perini Corp. ^b	4	+ 1/8
Philip Morris ^c	104%	+ 3 1/8
Prosher Corp. ^c	3 1/2	+ 3/8
Rouse Co. ^c	25 1/4	- 3 1/8
Santa Anita Consol.....	22	- 1 1/2
(Robt. H. Grant Corp.)		
Sayre & Fisher ^{ld}	2 1/8
Shareholders Capital Corp. ^c	1%	- 1/8
(Shareholders R.E. Group)		
Temple Industries ^c	22	- 1 1/4
Tishman Realty ^c	21%	+ 1 1/4
Titan Group Inc. ^c	3%	+ 3/8
UGI Corp. ^c	18 1/8	+ 1/8
Uris Bldg. ^c	14 1/2	- 1
Weil-McLain ^c	16%	+ 3/8
Westinghouse ^c	43%	+ 3/4
(Coral Ridge Prop.)		
Weyerhaeuser ^c	51 1/2	+ 2 1/2
(Weyer. Real Est. Co.)		
Whittaker (Vector Corp.) ^c	7	- 3/8
Wickes Corp. ^c	23%	- 1 1/8

SUPPLIERS

Alpha Portland Cement ^c	17	+ 1 1/2
Armstrong Cork ^c	32	- 2 1/4
Automated Building Comp. ^b	10	+ 1 1/8
Berven Carpets ^b	18	+ 3/8
Bird & Son.....	28 1/2	- 1 1/4
Black & Decker ^c	106%	+ 6 3/8
Carrier Corp. ^c	26	+ 2 1/4
Certain-teed ^c	21%	+ 1/8
Crane ^c	18 1/4	+ 1/4
Deere ^c	42	+ 1 1/2
Dexter ^c	22%	+ 2 1/8
Dover Corp. ^c	54%	+ 1/2
Emerson Electric ^c	90 1/4	+ 1 1/4
Emhart Corp. ^c	29%	+ 1/8
Fedders ^c	30%	- 3/4
Flintkote ^c	25%	+ 3/8
GAF Corp. ^c	21%	+ 7/8
General Electric ^c	64 1/2	+ 9 1/8
General Motors ^c	76 1/8	- 1 1/8
Gerber ^c	26%	- 2 1/4
Goodrich ^c	27%
Hercules.....	68%	+ 3/8
Hobart Manufacturing ^c	66	+ 1 1/4
Int. Harvester ^c	37%	+ 3/8
Johns Manville ^c	27%	- 1 1/8
Kaiser Aluminum ^c	16%	- 2 1/8
Keene Corp. ^c	9	+ 1/4
Kirsch ^c	36%	- 1 1/4
Leigh Products ^b	18 1/4	- 5 1/4
Magic Chef ^{cp}	22%	- 1/8
Masco Corp. ^c	59 1/4	+ 6 3/8
Masonite Corp. ^c	64%	- 2 1/8
Maytag ^c	40 1/4	+ 3 1/2
Modern Maid ^b	8%	- 1/4
National Gypsum ^c	17%	+ 3/8
Norris Industries ^c	43	- 7 3/4
Omark Ind. ^c	11%	+ 3/8
Otis Elevator ^c	39%	- 3/4
Overhead Door ^b	19 1/2	+ 1 1/4
Owens Corning Fibrgl ^c	45%	- 1 1/8
Pottlatch Forests ^c	22%	+ 3/4
PPG Industries ^c	39%	+ 2 3/8
Reynolds Metals ^c	16	+ 7/8
Rockwell Mfg. ^c	33%	+ 1 1/8
Rohm & Haas ^c	82 1/2	+ 9 3/8
Ronson ^c	7	+ 3/8
Roper Corp. ^c	28 1/4	+ 1 1/4
St. Regis Paper ^c	40%	+ 3
Scovill Mfg. ^c	27 1/2	+ 2 1/4
Sherwin Williams ^c	52 1/2	+ 1 1/8
Skil Corp. ^c	46%	+ 4 3/8
Stanley Works ^c	46%	+ 3/4
Tappan ^c	20%	- 3/8
Thomas Industries ^c	21%	+ 1
U.S. Gypsum ^c	24%	- 3/4
U.S. Steel ^c	28 1/2	- 7/8
Wallace Murray ^c	18%	+ 3/4
Weibull Corp. ^c	2%	- 1/8
Whirlpool Corp. ^c	38	+ 3 1/8

a—stock newly added to table. b—closing price ASE. c—closing price NYSE. d—not traded on date quoted. g—closing price MSE. h—closing price PCSE. —Computed in HOUSE & HOME's 25-stock value index. y—adjusted for 2-for-1 split. Source: Standard & Poor's, New York City.



WALL: H04 FLOOR: 492

custom decor
for walls... for floors



WALL: A03 FLOOR: 3715 & 495

VILLEROY & BOCH
DECORATED CERAMIC TILES

A designer's vision... interpreted
with a master's touch.

Exclusive U.S. representatives and distributors:

AMSTERDAM CORPORATION

41 EAST 42ND STREET, NEW YORK, N. Y. 10017

New York (212) 697-3300 • Philadelphia (215) 732-1492

Miami (305) 891-4331 • Oakland (415) 444-6050

Washington, D. C. (202) 529-8835

Call or write for free color brochures

Nader's men tag mobile homes as fire traps and the industry cries 'foul'

Mobile homes are now coming under attack as fire traps from a new wave of critics who insist that the units are far more hazardous to live in than conventional homes.

The industry denies the charges vehemently, but signs indicate that there will be more criticism before there is less.

A Ralph Nader task force has visited a dozen mobile-home factories, responding, it says, to "hundreds of complaints." It is scheduling for release by spring or summer a report on how unsafe mobile homes are to live in and what should be done about them.

The presidentially appointed National Commission on Fire Prevention, at work since 1968, will make its own recommendations for reducing mobile-home fire risks when it publishes a paper on fire prevention in June.

'Unfit.' The fire-trap charge has most recently been made by Ralf Hotchkiss, director of Nader's Center for Concerned Engineering, in testimony on mobile homes at a Chicago hearing held by the fire prevention commission.

Hotchkiss, after citing examples of hazardous design and flammable materials used in many mobile homes, made several recommendations for improvements to alleviate some of the particular ignition and escape problems. But, he contended that "even if these changes were made, mobile homes would still be fire traps unfit for human habitation."

Danger of death. Hotchkiss says the principal problem with mobile homes is that they burn quickly. While there is no more likelihood of fire starting in a mobile than in a conventional home, he argues, the occupants of the mobile are more likely to be killed. He testified:

"It is rarely more than a few minutes from the time a mobile-home fire starts until there is no hope of escaping alive."

Hotchkiss said that basic design deficiencies appear to be present in all mobile homes, regardless of their quality level. He cited these examples as fire hazards:

- Appliances are so close to the mobile's aluminum skin that the skin reflects any heat

from the appliance and thus raises the danger of ignition.

- Open hallways allow fire an unrestricted path.

- Density of furniture makes more fuel available per-square-foot.

- Flammable paneling of "kindling thickness" on all inte-

rior walls burns readily.

- Wiring practice and design spark a "high number of fatal electrical fires."

- Doors and windows are poorly designed for quick egress.

Safety steps. A good start on basic design change, Hotchkiss claimed, would be to require



New president of Mortgage Bankers Assn. is Everett Mattson (right), senior vice president vice president of Lomas & Nettleton Co., Houston, taking gavel here from the outgoing president, Philip Jackson of Birmingham, at the MBA's convention in San Francisco.

Mortgage men at peak of prosperity

The mortgage bankers staged their biggest and most successful convention last month and passed word quietly that they had just had their biggest and most successful year.

Their trade group, the Mortgage Bankers Assn., drew a record 5,600 members and wives to San Francisco. Their leaders imparted the agreeable intelligence that the profession had closed \$18 billion in loans in 1971, a startling increase of 38.5% over the previous peak year of 1970, and that even bigger things were to come.

Servicing volume had soared to \$92 billion in '71 and sailed beyond \$100 billion as the MBA convened. Its ebullient spokesmen were already talking about \$200 billion goals.

A walk on eggs. The key to this rampant prosperity was the FHA, the government agency that insures mortgages and thus renders them marketable. Nobody knew this better than the MBA members, and their appreciation of this circumstance inhibited all discussion of the convention's one volatile issue:

What to do with the troubled FHA itself, a housing-scandal

casualty often described these days as a kind of textbook case in government corruption?

The MBA kid-gloved that one. Its governors voted a resolution urging the government to set up "an independent federal agency" to handle FHA's insurance, but they were careful to add that this implied no abandonment of high-risk mortgages in the inner cities. The resolution did not even make clear whether such mortgages should be handled outside a new, sanitized FHA.

The unmentionable. Virtually every officer and official at the meeting voiced concern verging on panic at any suggestion that the FHA's role might be seriously curtailed or that mortgage-subsidy programs might be cut back. Secretary Romney struck near terror into the hearts of thousands when he suggested that Congress might like to consider whether to set up a completely private FHA and take the government entirely out of housing (see pp. 4-9).

The FHA, wayward though it might be, was still the mortgage men's darling in San Francisco. From panel and podium they defended it to a man. —E.W.R.

plasterboard on interior walls and firestops between the wall-studs. But he said he had scant hope for self-correction on the part of the industry because the most the industry has done so far is to "participate in the development of a weak standard [by the American National Standards Institute] . . . and even this standard is too often ignored."

The leading promoter of mobile-home standards in Congress has been Rep. Louis Frey Jr., whose solidly Republican district in Florida includes Orlando and Cape Kennedy. Last May, he proposed a National Mobile Home Safety Act in a speech in which he spelled out the lack of standards.

Lack of standards. Only about half the states have adopted the standards developed by the institute and five of the top ten manufacturing states have no standard whatsoever, Frey told the House. He cited insurance company reports that the average mobile home fire loss was \$1,529 in 1971 compared to \$350 for a conventional home, and that insurance rates on a \$6,000 mobile are comparable to those on a \$40,000 house.

Frey says only a federal standard will solve the problem, and Hotchkiss says some mobile home producers have told him they want a national standard.

Rebuttal. The Mobile Home Manufacturers Assn. has submitted testimony to the commission charging major inaccuracies and slanting of facts by Rep. Frey and the Nader group.

For instance, the association cited data showing that the "incidence of fire was almost twice as great for conventional homes as for mobile homes."

The Trailer Coach Assn., another industry group, quotes a publication of the National Fire Prevention Assn. showing that the loss per-mobile-home-fire (\$955) "was slightly below the average for all dwelling types," and that the "incidence of fires in one- and two-family homes in 1969 was about the same as in mobile homes."

Frankly, we thought the (Nader) center could do better," said Larry Davenport of the MHMA. He described the Hotchkiss testimony as "totally lacking in scholarship" and said parts of it were "laughable."

Everybody takes copper plumbing for granted. Clog-free, corrosion resistant and non-contaminating, copper quietly does its job for the life of the building, needing less maintenance than other materials. It's the dependable one.

Contributing to the long range economy of copper is its fast, easy installation. Copper requires no flammable joining compounds, needs no extra supporting hardware. Copper doesn't sag with heat or get brittle with cold. What's more, it can be altered easily and economically if a system change is ever needed.

Most important, copper does not create a po-

tential fire hazard. Copper will not burn and decompose to toxic gases or conduct fire through floors, walls and ceilings.

So, keep taking copper plumbing for granted. Copper is a quality product, backed by years of proven service and code acceptance everywhere. It may cost a little more to begin with, but first cost is the least cost when it's the last cost.

For a booklet listing 44 solid reasons why copper is your best buy, write: Copper Development Association Inc. 405 Lexington Avenue, New York, N.Y. 10017.

Copper plumbing. The dependable one.

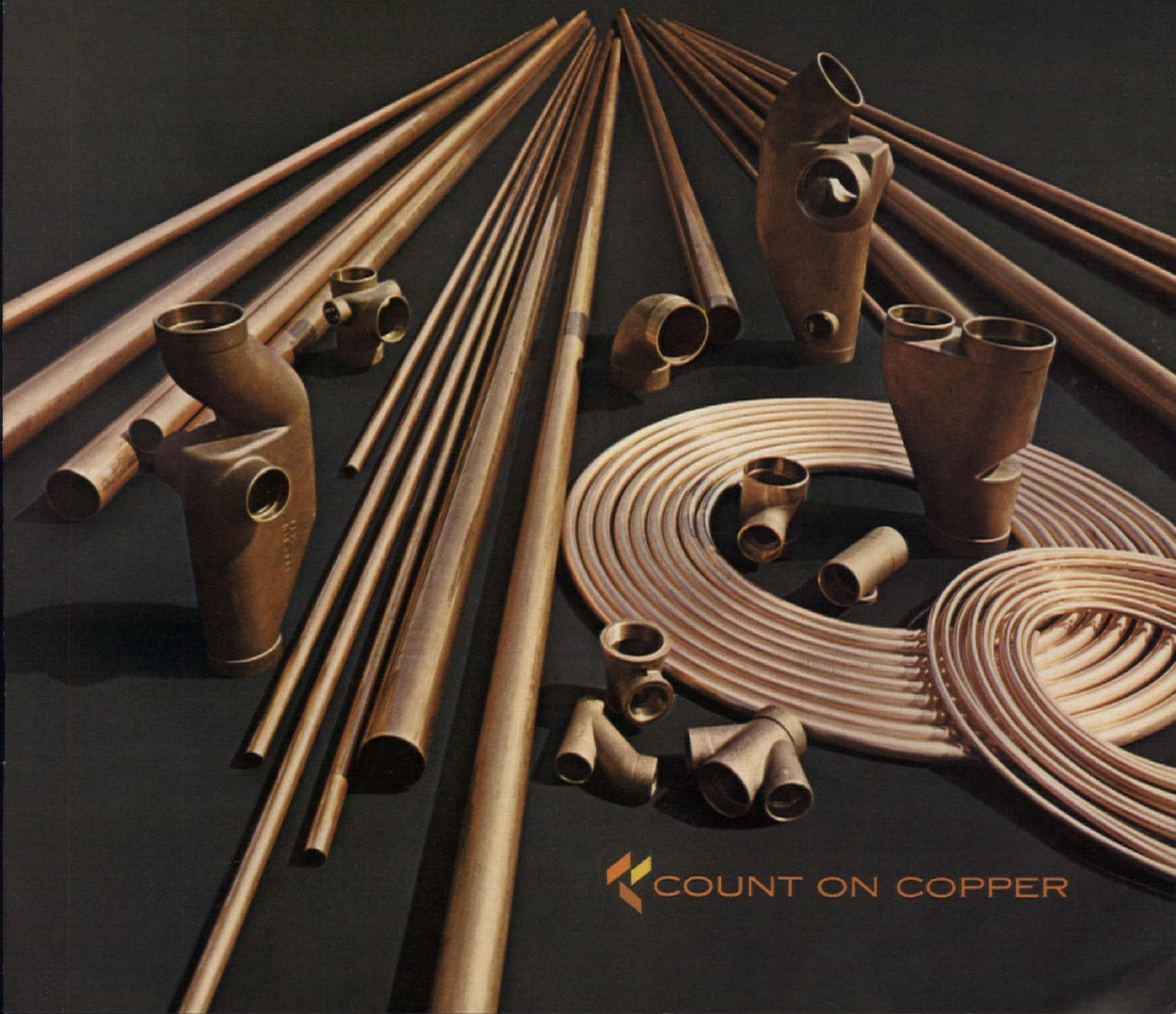

 COUNT ON COPPER



Florida, the cradle of the condominium, before the boom.

We've seen condominiums through thin

Money is just one of the things First Mortgage Investors has to offer condominium developers.

First we perform a battery of vital services you'd pay a small fortune for if we did them separately.

All of which are designed to make your project as risk-free and potentially profitable as possible.

These functions include:

A site and area inspection to make sure the land and neighborhood can support your project.

A review of similar jobs.

Documentation and careful scrutiny of all pertinent facts to determine feasibility.

And careful studies of your costs, cash-flow and profit opportunities.

Then, at the end, you get a clear picture of exactly where you stand and where your project's going.

Which, in the long run, can be worth more than any savings from a quicky commitment or a bargain-interest deal.

You see, FMI wrote the book on mortgage investment trusts. And we

cut our teeth on condominium financing.

So let us help you cut your teeth on condominium profits. Have your broker write or call First Mortgage Investors, 801 Forty-First Street, Miami Beach, Florida 33140. Phone 305/532-7361. Or contact one of our Regional Offices.

 **First Mortgage Investors.**

We wrote the book.



Florida 1972. The condo comes of age, and into its own.

and thick.

EASTERN DIVISION:
Robert O. Cahill, Senior Vice President
801 Forty-First Street,
Miami Beach, Fla. 33140
Phone: 305/532-7361

WESTERN DIVISION:
T. W. Owens, Senior Vice President
National Foundation Life Building
3535 N.W. 58th Street, Suite 700
Oklahoma City, Oklahoma 73112
Phone: 405/947-5695

**SOUTH FLA./CARIBBEAN
REGIONAL OFFICE:**
Donald E. Gray,
Vice President
9300 South Dadeland Blvd.
Miami, Florida 33156
Phone: 305/666-5971

SOUTHEASTERN REGIONAL OFFICE:
Owen N. Frakes,
Vice President
2233 Lee Road, Suite 217
Orlando, Florida 32789
Phone: 305/644-1200

NORTHEASTERN REGIONAL OFFICE:
James L. Osmond
Vice President
30 Evergreen Place
East Orange, New Jersey 07018
Phone: 201/674-2290

MIDWESTERN REGIONAL OFFICE:
George R. Callantine,
Vice President
1001 East Jefferson Boulevard
South Bend, Indiana 46617
Phone: 219/234-6096

SOUTH TEXAS REGIONAL OFFICE
Roy S. Simpson, Vice President
1109 Cullen Center Bank Building
600 Jefferson Street
Houston, Texas 77002
Phone: 713/229-9132

CENTRAL REGIONAL OFFICE:
T. W. Imes, Vice President
National Foundation Life Building
3535 N.W. 58 Street, Suite 700
Oklahoma City, Oklahoma 73112
Phone: 405/947-5695

MID-ATLANTIC REGIONAL OFFICE:
John S. Frisby, Vice President
7910 Woodmont Avenue
Suite 1118
Bethesda, Maryland 20014
Phone: 301/654-9140

SOUTHERN REGIONAL OFFICE:
Robert H. Jenkins, Vice President
4539 I-10 Service Road
Metairie, Louisiana 70002
Phone: 504/885-8696

Construction through the ages.

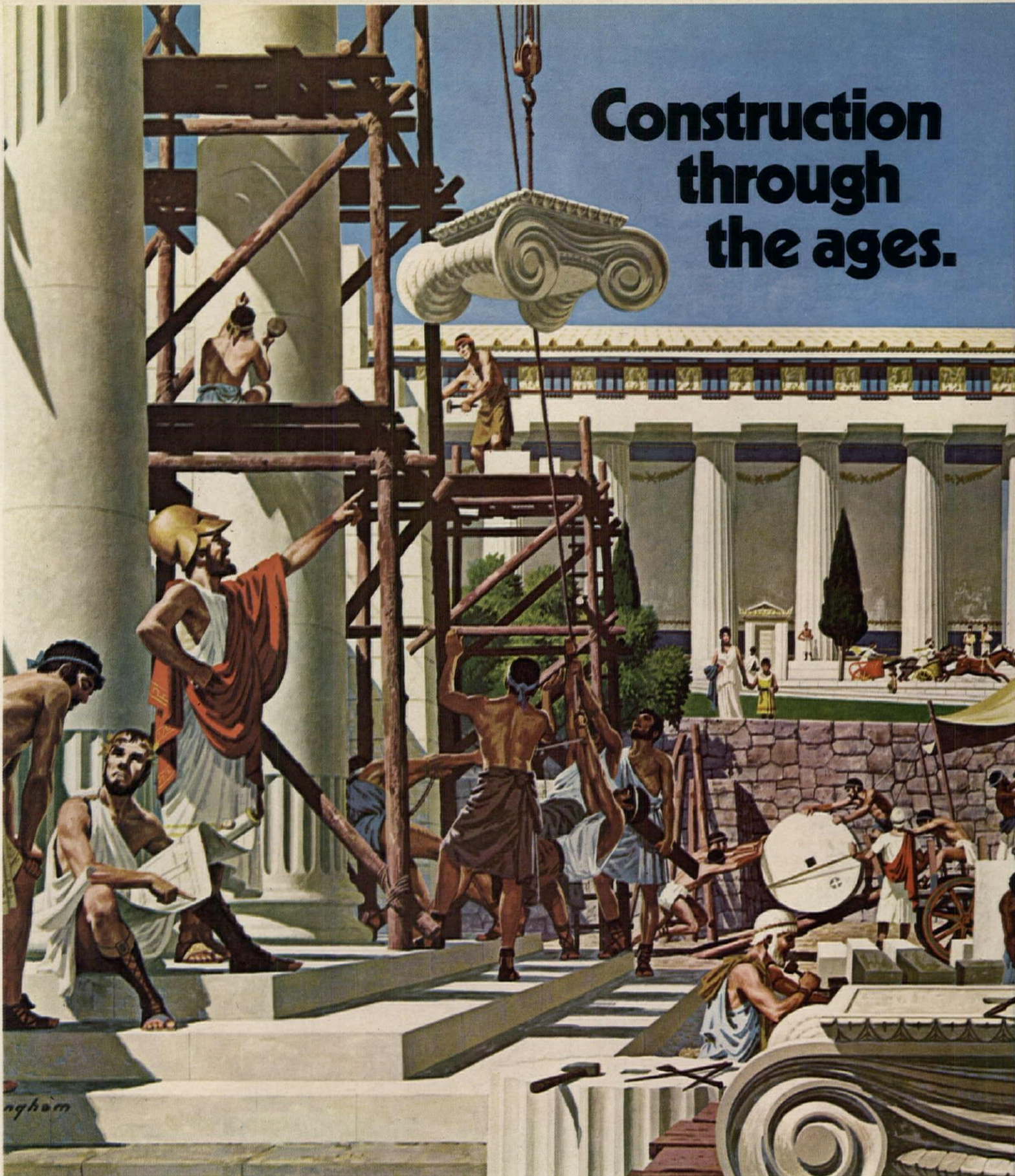

You now have an opportunity to own reproductions of a series of paintings depicting significant achievements in the History of Man the Builder...commissioned by The Celotex Corporation as a salute to the construction industry, past...present...and future.

Two sets of 5-prints each, in full color, 16" x 20" size for framing, are made available by Celotex. Prints are rolled in a heavy tube, with keyed explanatory text sheet for each painting describing the history of the period and construction methods portrayed.

Celotex*
BUILDING PRODUCTS

Celotex understands the man who builds.

The Celotex Corporation • Tampa, Florida 33622
A subsidiary of Jim Walter Corporation *Trademark

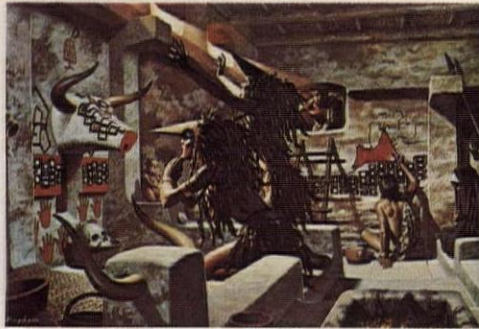
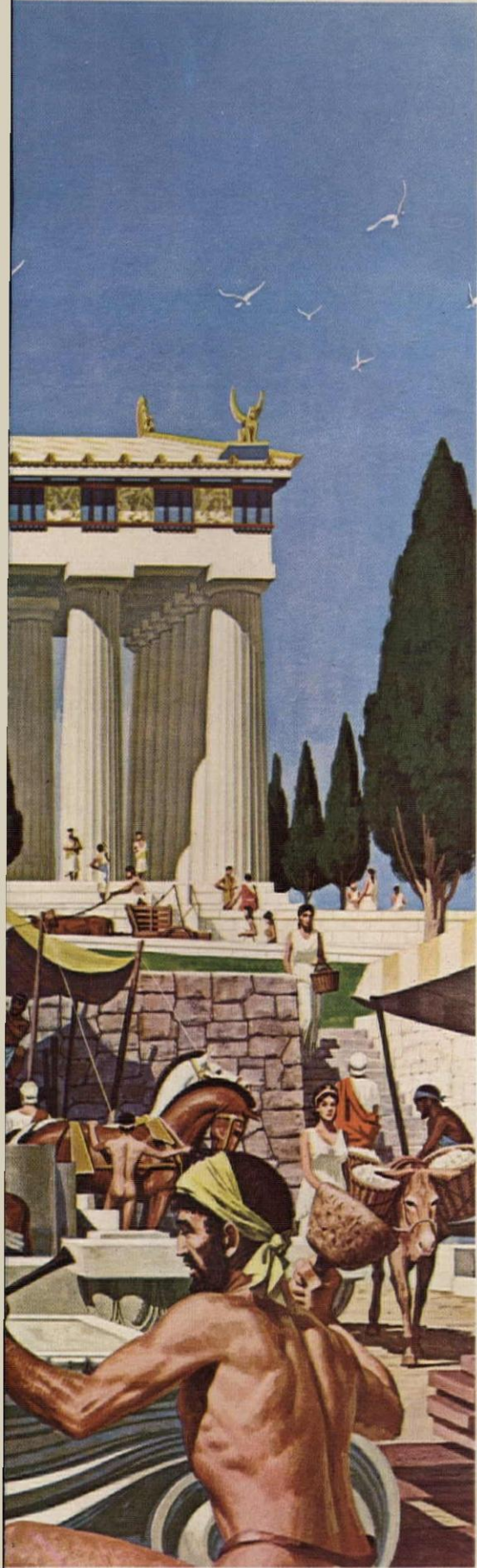

The Anatolian Plateau of Turkey — ca. 6200 B.C. A neolithic shrine at Catal Huyuk.

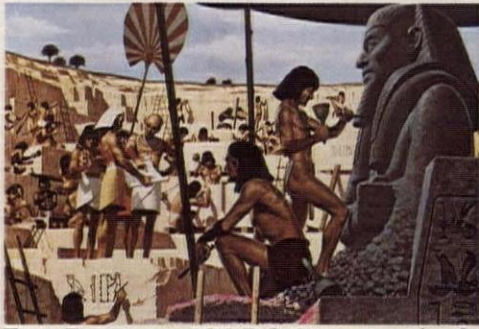

Tura, Egypt — ca. 2650 B.C. Stone-quarrying for the "Step Pyramid" of Zoser.

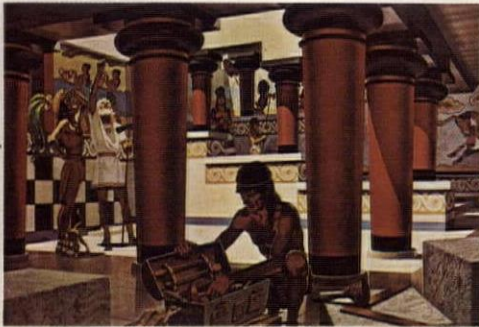

The Island of Crete — ca. 1550 B.C. The rebuilding of the Palace of Minos at Knossos.



The Acropolis, Athens, Greece — 409 B.C. Construction is resumed on the Erechtheum.

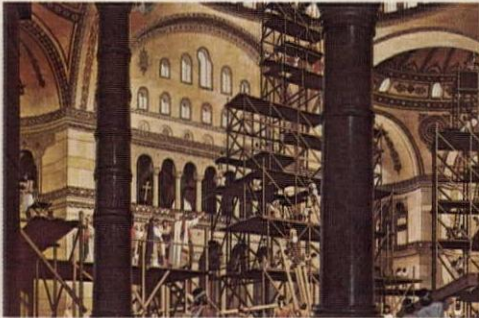

Sancta Sophia, Istanbul, Turkey—ca. 535 A.D. The classic Byzantine church nears completion.

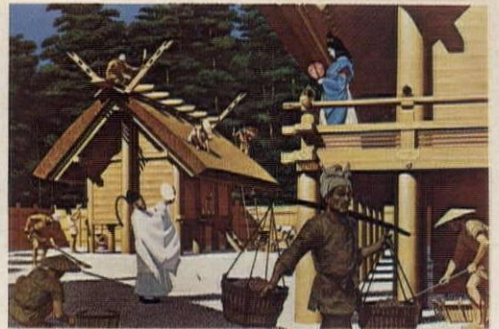

The Ise Forest, Japan — A.D. 689. The first rebuilding of the Naiku (Inner Shrine) at Ise.

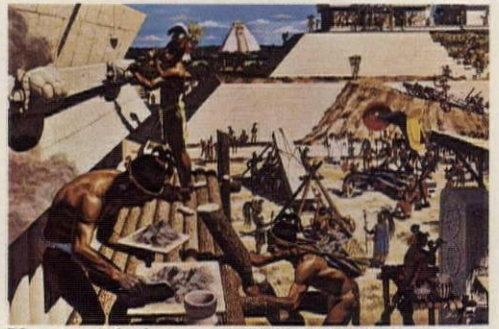

Yucatan, Mexico—ca. A.D. 987. The House of Turtles in the Mayan City of Uxmal nears completion.

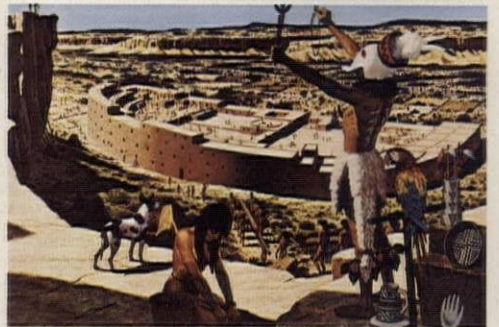

Chaco Canyon, New Mexico, U.S.A. — ca. A.D. 1067. The building of Pueblo Bonito.



Cambodia — ca. A.D. 1200. The construction of the Bayon in the Khmer city of Angkor Thom.



The Andes of Peru — ca. A.D. 1470. The rebel Ollantay builds his fortress-city, Ollantaytambo.

HOW TO ORDER: You can have one, or both, of these 5-print sets for the nominal reproduction, mailing and handling cost of \$3.00 per set, or both sets (10-prints total) for \$5.00. Send order with check payable to "Historical Construction Paintings." Specify "Set-I" or "Set-II." Mail order to: Historical Construction Paintings, Box 368, Miami, Florida 33145. Please allow 4 to 6 weeks for delivery.

**Set I
The Early
Period**

**Set II
The Later
Period**

The people who re-invented the faucet

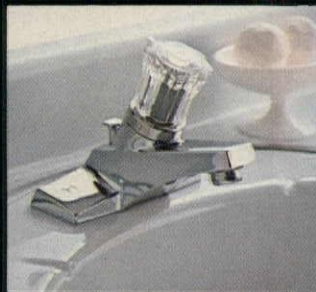

First, we designed the Bradtrol valve to make our single-control faucets last a lifetime. Designed it never to leak or wear out. Ever. Designed it with a single moving part, permanently lubricated. Then, backed the user with an 83 $\frac{1}{3}$ year guarantee on the cartridge.

We've put that Bradtrol cartridge into every single-control faucet we've ever sold. Bright chrome Cascade faucets for the bath and

kitchen. Elegant Sceptre in brushed and bright chrome or gold. And the same cartridge goes into our new Aurora line. The single-control faucets that come in five decorator colors to coordinate the entire bathroom. To brighten kitchens like never before.

But we didn't stop there. Now, we have a two-handle line, proven by over seven million faucets in use. With another exclusive Bradley

cartridge called Pos-I-Pak® that eliminates washers, seats, threads, packings. All the things that used to wear or corrode. That's why we can also back this cartridge with an 83 $\frac{1}{3}$ year guarantee.

Our two-handle line offers a style for every need. A crystal handle line for the bath. Bright chrome Olympian for bath and kitchen. Parisian... decorated vitreous china faucets. Aphrodite... 24 carat gold

have a lot of other new ideas for you.



on china... with coordinated ashtrays, towel bars, soap dishes and other accessories.

There's more. To complete the bathroom decor, Bradley now offers two complete lines of vanity tops. The classic look of simulated marble... and versatile, durable acrylic. Bradley takes care of the nuts and bolts of the business, too. With bath drains, float valves, basket strainers. Everything but the kitchen sink.

It's a bigger, better line than ever before. Everything you need from a single source. Bathroom and kitchen ideas from the people who re-invented the faucet. Write for detailed literature. Bradley Corporation, Faucet and Special Products Division, 9161 Fountain Boulevard, Menomonee Falls, Wisconsin 53051.



Bradley

Hotpoint Hustle: It's providing a sanitation center you can really clean up with.



With these 3 appliances you can free your buyers from some very messy work and make your homes a lot easier to sell or rent:

1. The Hotpoint Dishwasher

This is an appliance a lady can fall in love with.

Most feature Whisper-Clean™ operation. It comes from putting extra sound-deadening insulation on the top, sides, back and service panel, and even sandwiching it in the door. And it means we'll do her dishes without making a big noise about it.

Our Sani-Cycle model increases the water temperature for proper washing and drying results. And its Lift-A-Level™ rack adjusts easily so big platters and tall glassware all go in one load.

2. The Hotpoint Trash Compactor

This appliance tempts potential

tenants or home buyers with an end to daily trips to the trash cans.

It compresses a week's trash for an average family of 4 into one neat little package: cartons, bottles, plastics, cans, and more of the things customers normally have to carry to the trash cans.

3. The Hotpoint Disposer

The Hotpoint Disposer takes over where the Trash Compactor leaves off.

Its rugged stainless steel

shredders grind up food scraps and leftovers such as bones and large pieces of food. And it's approved for use with septic tanks.

Your Hotpoint builder representative wants to tell you more about our sanitation center.

And about all the other appliances Hotpoint can bring you: refrigerators, air conditioners, ovens and ranges, hoods, washers and dryers. And besides appliances, there are a lot of extras we can bring to your project.

He'll also tell you about the largest company-owned, company-trained service organization of any manufacturer in the business.

It all adds up to even better appliances and services for you and your customers.

Call your Hotpoint builder representative. And watch him come running.

Hotpoint. The difference is hustle.

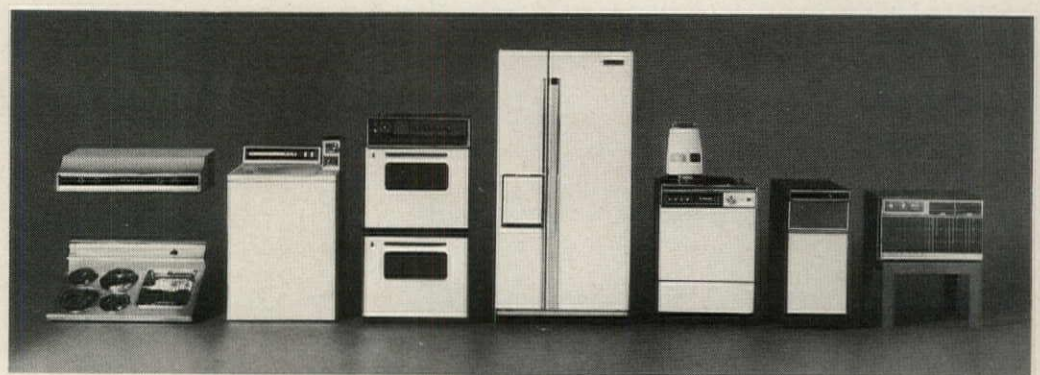

Hotpoint
A QUALITY PRODUCT OF GENERAL ELECTRIC COMPANY

What makes Aggreboard Aggreboard?



This.

Stones of uniform particle size and color. Sizes: 0 (silica sand), 125 (1/8"), 250 (1/4") and 500 (1/2"). Colors: Garnet Red, Cocoa Brown, Desert Brown, Sun Tan, Northern Green, Hartford White, Jewel White, Roma Grey and Black. Most colors available in the sizes listed.

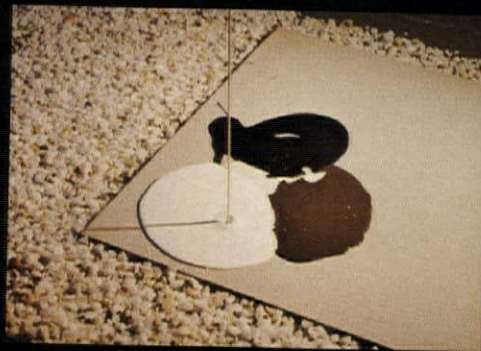

This.

U/V stable thermo-setting polyester resin matrix, 25-60 mil thick formed on the substrate to bond the aggregate. The cured matrix is a non-yellowing, non-porous enamel-like white. It can be tinted (as shown) to alter, or enhance the aggregate color.



And this.

Your choice of 3/8" DF graded exterior plywood; 1/2" Structasote 460 thermal insulation board (R = 1.0), termite, rot and fungi protected; 1/4" thick fireproof asbestos board, or insulated asbestos board panels in a variety of thicknesses and insulating cores.

VISTAS, Mount Holly, N.J., by U.S. Home Corp.



AGGREBOARD.
*Prefinished, structural sheathing/siding,
 4' X 8' and other sizes,
 or pre-cut to custom shapes.*

Modular Materials, Inc.

333 Hamilton Boulevard, South Plainfield, N.J. 07080 Tel: 201-754-1330



When a prospective buyer sees our kitchens, with KitchenAid dishwashers, suddenly he feels at home."

"Our affluent buyers are familiar with, recognize and appreciate KitchenAid dishwasher quality," says George M. Holstein III, President of Holstein Industries.

"We've created a community of beautiful homes, privacy, exciting views, parks and gardens, and we want to give people time to enjoy them. That's why the Holstein Company selected KitchenAid dishwashers. They're quiet and trouble-free."

Last year Holstein Industries installed KitchenAid dishwashers in more than 200 homes in Newport Beach, California. They're convinced that

KitchenAid quality can help them close sales. And minimize call-backs after the sale.

Because KitchenAid goes to a lot of trouble to make superior products. They pay off for the builders who install them and for customers who use them. Builders like you and customers like yours.

See all KitchenAid products, including the new trash compactor, at our Booth 3227 in Houston. Or ask your KitchenAid distributor about his builder plan. KitchenAid Division, Dept. 2DS-12, The Hobart Manufacturing Company, Troy, Ohio 45373.

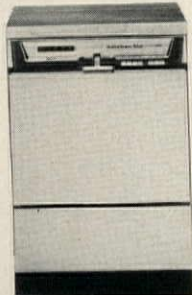

KitchenAid
Dishwashers and Disposers
Hot-water Dispensers
Trash Compactors



**OVER 900,000* PEOPLE HAVE SEEN THIS HOME.
AND YOU CAN SEE IT IN HOUSTON!
AND WHILE YOU'RE AT IT, YOU CAN LEARN ABOUT THE MANY
BENEFITS OF BECOMING A SCHOLZ BUILDER.**

The "New Generation" Home, latest addition to the famed Scholz Design Collection of luxury homes, and cover story feature house in the October 1972 issue of *House Beautiful* magazine, will be open for your inspection at the NAHB Show in Houston.

This exciting home, designed to provide the right environment for the contemporary family of the 70's, is attracting thousands of visitors to Scholz builder's developments in thirteen market areas of the country where it is being shown.

Visit the Scholz booth, #3515, at the show and learn more about the total merchandising program that is convincing custom builders throughout the country to become Scholz builder-dealers. Find out how 25 years and 30,000 homes worth of experience can help you build and sell more homes with less labor in less time and help you increase the return on your investment.

If you can't make it to the show—send in the coupon and we'll be glad to send you some information on

the Scholz Builder Program. (And we'll also tell you where to see the "New Generation" Home in your area.)

*Over 900,000 people have seen the Scholz "New Generation" dream home in the October 1972 issue of *House Beautiful* magazine.



SCHOLZ HOMES, INC.

The world's foremost producer of luxury homes
A subsidiary of  Inland Steel Urban Development Corporation.

Scholz Homes
P.O. Box 3355
Toledo, Ohio 43607

Tell me how to make more. Send free information on the Scholz Builder Program.

NAME _____

TITLE _____

COMPANY NAME _____

ADDRESS _____

CITY _____ STATE _____ ZIP _____



What multi-family developments are "making it"?

CIRCLE 47 ON READER SERVICE CARD

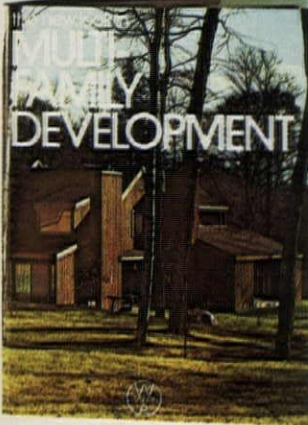

Our new Idea Booklet graphically details some of the most outstanding developments in the country. It includes descriptions of an all-wood condominium development constructed entirely of modular units. A PUD in the Midwest with a "close to nature" look. An in-town high density rental unit. And more. Each development is unique. Yet they all have two things in common—they're successful and they use Western Wood. Why Western Wood? It's versatile. Readily available. Your subs know how to work with it. It helps you meet construction schedules. And it has excellent customer appeal.

Our new 8-page, 4-color booklet includes many examples of manufactured and site-built housing developments that are "making it." Send the coupon for your free copy.

Name _____

Firm _____

Address _____

City _____

State _____

Zip _____



Western Wood Products Association

Dept.HH-1272 Yeon Building, Portland, Oregon 97204

One of a series presented by members of the American Wood Council.

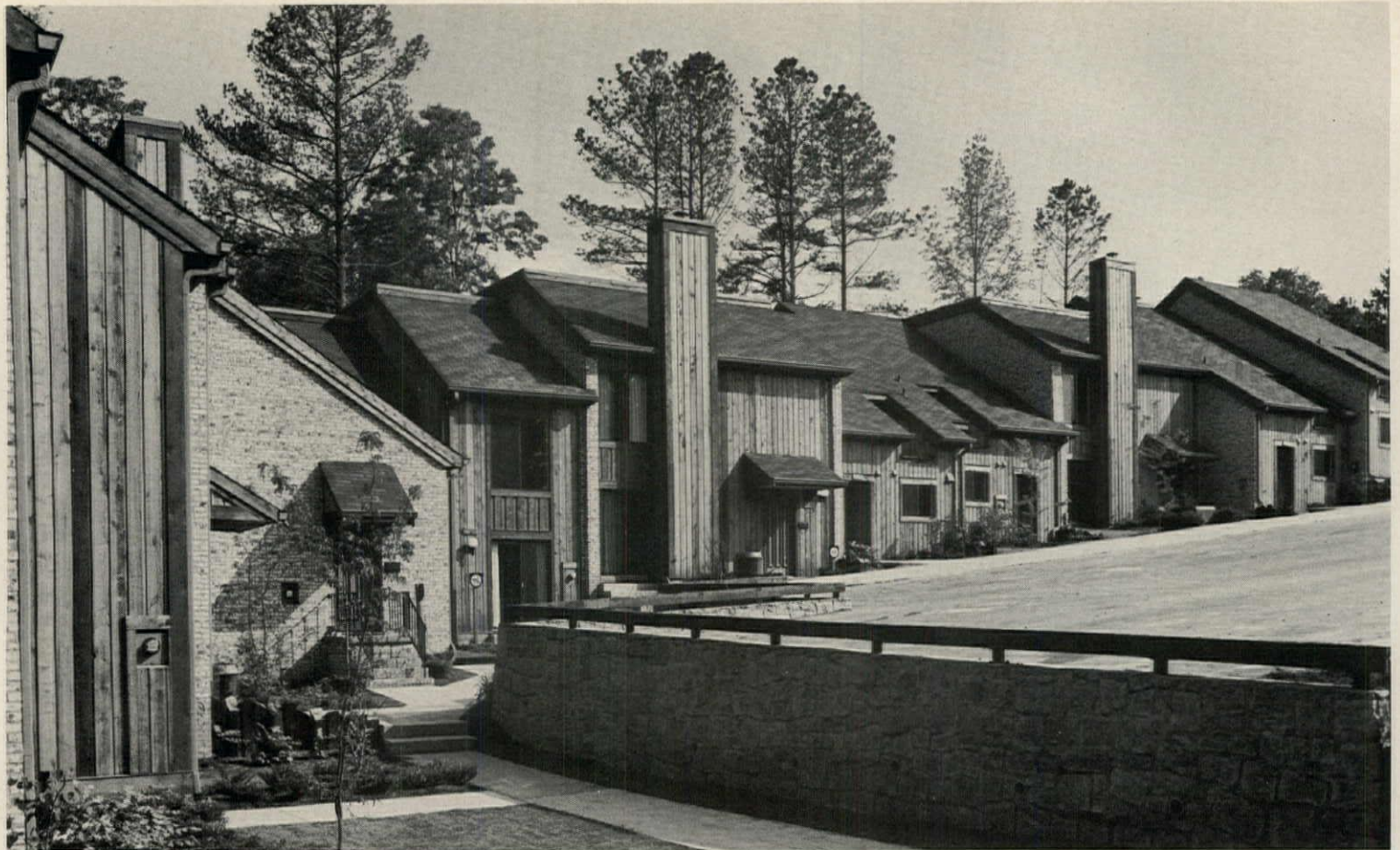

This condominium project was built to test a market

And the test turned out positive.

Crow, Pope & Land, which is building the project outside of Atlanta, wanted to find out how big and how solid a market there was for higher-priced condominiums. The company has seven other condominium projects in the Atlanta area, but all are well below the \$35,000 to \$60,000 range.

So the 17 units shown here were built in Cumberland, a new community being developed by Crow, Pope & Carter (friends but not relations). They sold quickly, and Crow, Pope & Land is now building 80 additional units that represent the balance of the project.

Three townhouse models are available: a two-bedroom unit with one full and two half-baths, a three-bedroom unit with two-and-a-half baths, and a four-bedroom unit with two-and-a-half baths. Houses can be built on slabs, or with full basements at \$4,000 premium. Prices start at \$32,500 and go up to \$49,900, but premium lakefront sites and interior extras can boost the top-of-the-range to about \$60,000. Buyers thus far have averaged 42 years in age, and include both former renters and former homeowners.

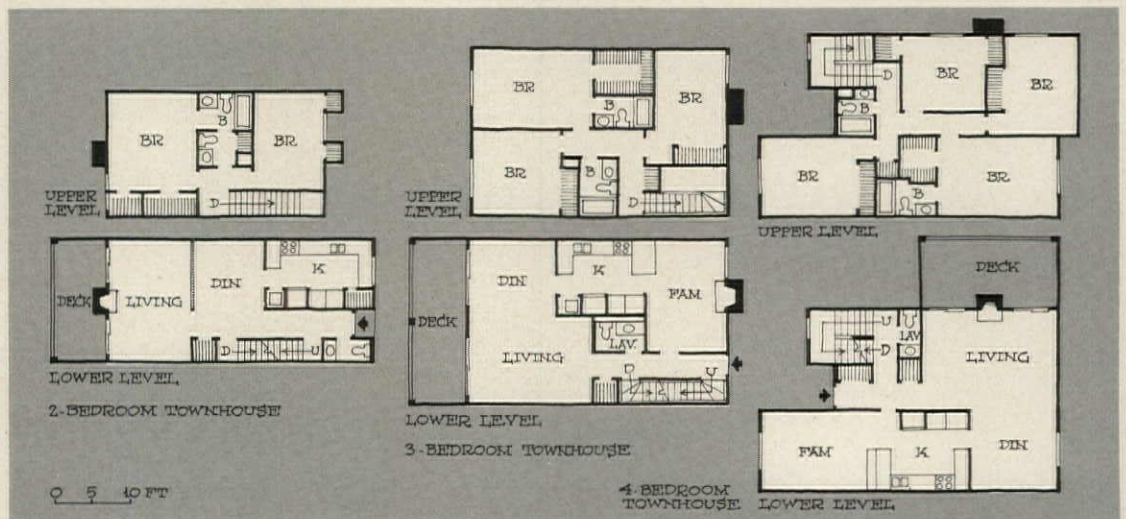

Rear patios (left) are separated by brick walls. Front entrances (right) are spaced to give feeling of privacy.

Instead of just a kitchen, build in some peace of mind.



Frigidaire built-in appliances offer the features that mean sales appeal for you and convenience for your buyers. But they have something else just as important to offer you and your buyers. Peace of mind.

That's because they're backed by a 54 year reputation for dependability, plus the Frigidaire 5-Year Nationwide Protection Plan, like the one that covers the dishwasher shown above: 1-year Warranty for repair of any defect in the entire Dishwasher, plus 4-year Protection Plan (parts only) for furnishing replacement for any defective or malfunctioning part in the Motor,



Pump, and other parts of the Water Circulating System. And it's backed by General Motors.

Another nice thing about Frigidaire built-in appliances, they're available from Frigidaire Builder-Distributors. These men are not factory reps, but local independent businessmen like yourself. They can offer on-site coordination, along with a full range of building materials. And, since they live and work in your community, they can give your order direct, personalized attention and continue to do so until installation is completed.

That should be enough to make any home buyer's and any builder's mind rest easy.

Every refrigerator is not a Frigidaire. Every Frigidaire is not a refrigerator.

NAHB Show Booth 3516



SCN-40

The only power nailer that drives a 4" nail



SGN-35

Drives 9 different nails 2" to 3 1/2" long



Gun Nailer®

The original in the portable power nailer business



Mini-Nailer

Drives 8 different nails 1 1/4" to 2" long

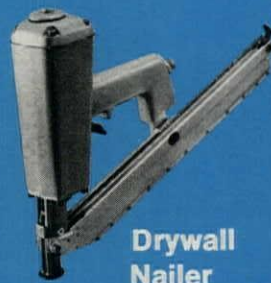

Drywall Nailer

First and only tool of its kind



Brad-Nailer

Brads come in 5 lengths, 7 colors to match work



Magnum® Stapler

Workhorse tools drive 24 different staples to 2" long

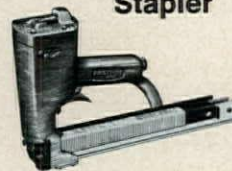

Mustang Stapler

High power with light weight drives 17 different staples to 1 1/8" long



Pinto II Stapler

Fast new challenger in the light wire field

Nine Paslode ways to drive fast and save money

These tools are part of Paslode's full line, which also includes border-wire clippers, stapling pliers and hammers, and automated framing, sheathing and pallet-making systems. There's a Paslode man or authorized

distributor's man near you to help you select the fasteners and tools and systems that are right for your needs.

Call him today, or write for more information.

 **PASLODE®**
COMPANY, DIVISION OF SIGNODE®
8080 McCormick Blvd., Dept. HH, Skokie, Ill. 60076
In Canada: Paslode Canada Registered

Canada at the NAHB show... blueprint to better building ideas

SPECIFICATIONS

Back up your blueprints with better building products from Canada! Canada's building products industry offers sophisticated products and systems manufactured to the most exacting standards from the finest materials.

Innovative design and careful workmanship have made Canada a world leader in new home building products and ideas. The product range

is extensive — from pre-engineered modular housing to pre-finished door packages, from sweeping staircases to exciting, new building components, from modular and custom-made wall systems to effective, economical water treatment systems. Combine Canadian quality and reliability with competitive prices and prompt delivery... and you've got a perfect blueprint for building better homes.

Canadian participants at NAHB:

Canadian Wood Council: wood products — dimension lumber panels, shakes, etc;

Fitzpatrick Stair Limited: circular and straight stairways

Gazelle Wall Systems Ltd.: modular and custom-made prefabricated wall systems

Hambro Structural Systems Limited: composite floor systems

Litoid Canada: decorative architectural paneling

Pollution Control Systems International Limited: automatic water sewage treatment systems

Sauder Industries Limited: pre-finished interior flush doors, upland hemlock jambs, stops and casing

Universal Sections Limited: building systems, aluminum siding and soffit, polystyrene concrete forms and modular housing



For more information on these companies and their products visit the:

**Canadian Exhibit in the Astrohall
Booth 2224, The NAHB show
Houston, Texas
January 7 to 11, 1973**

CANADIAN WOOD COUNCIL
CIRCLE 483 ON READER SERVICE CARD

FITZPATRICK STAIR LIMITED
CIRCLE 484 ON READER SERVICE CARD

GAZELLE WALL SYSTEMS LTD.
CIRCLE 485 ON READER SERVICE CARD

HAMBRO STRUCTURAL SYSTEMS LIMITED
CIRCLE 486 ON READER SERVICE CARD

LITOID CANADA
CIRCLE 487 ON READER SERVICE CARD

POLLUTION CONTROL SYSTEMS INTERNATIONAL LIMITED
CIRCLE 488 ON READER SERVICE CARD

SAUDER INDUSTRIES LIMITED
CIRCLE 489 ON READER SERVICE CARD

UNIVERSAL SECTIONS LIMITED
CIRCLE 490 ON READER SERVICE CARD



News! American systems for every

This was just the beginning.

This is Redi-Set® Systems 100, our famous pregrouted glazed tile sheets. Homeowners love the flexible, stain- and mildew-resistant

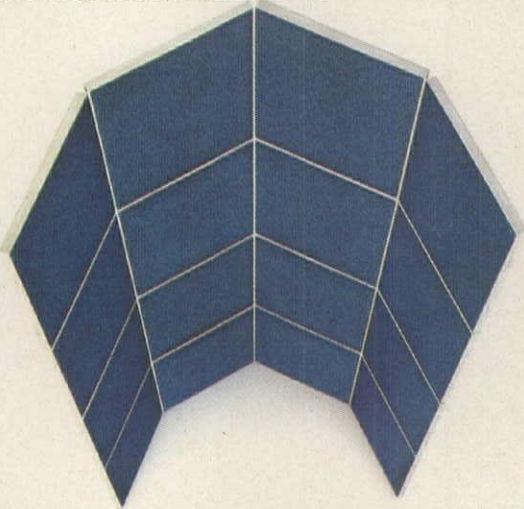

Redi-Set grout. It's waterproof, wipes clean, and won't crack—even when the building settles. Use Systems 100 in the luxury baths in your condominiums, apartments, custom and semi-custom housing, and for remodeling jobs. It comes in sheets of up to 16 tiles.



Anywhere there's a standard-size tub in a standard recess

there's where you use Redi-Set System 310 pre-grouted tub surround. It's designed to fit most

of the tub enclosures found in apartments, townhouses, industrialized housing, tract homes, and low-cost FHA housing. Installed in under an hour over almost any backup, this eight-sheet beauty is self-trimmed. Most grouting and most cuts are eliminated. Extension packages are available to extend tile to the ceiling.

The matching Redi-Set tile wainscot.

Almost anywhere you use System 310, you can add even more sales appeal with Redi-Set System 350, the matching pre-grouted wall sheets. It's quick and easy to build in. Or offer it as a trade-up option. Sheets are 2' by 2', and contain up to 36 tiles.



Olean ceramic tile kind of bath.



Redi-Set
shower
systems.

Redi-Set Systems 300 shower surrounds are sized to fit the four most popular receptor sizes. These units can be installed directly over properly sealed drywall. 72" high, there are extension packages available to extend the tile to the ceiling.

Visit our exhibit in
Booth 1503 at the NAHB Show

American Olean Tile Company
1746 Cannon Ave., Lansdale, Pa. 19446
Please send literature on your new Redi-Set systems.

Name _____

Street _____

City _____

State _____

Zip _____

**American
Olean**
A Division of National Gypsum Company

So give your prospects what they want a bathroom with the beauty and recognized low maintenance of ceramic tile; plus a new grout joint which is waterproof, stain- and mildew-resistant, and won't crack out. That's what they get with American Olean Redi-Set systems.

**Redi-Set pregouted ceramic tile.
It's the natural thing to use.**

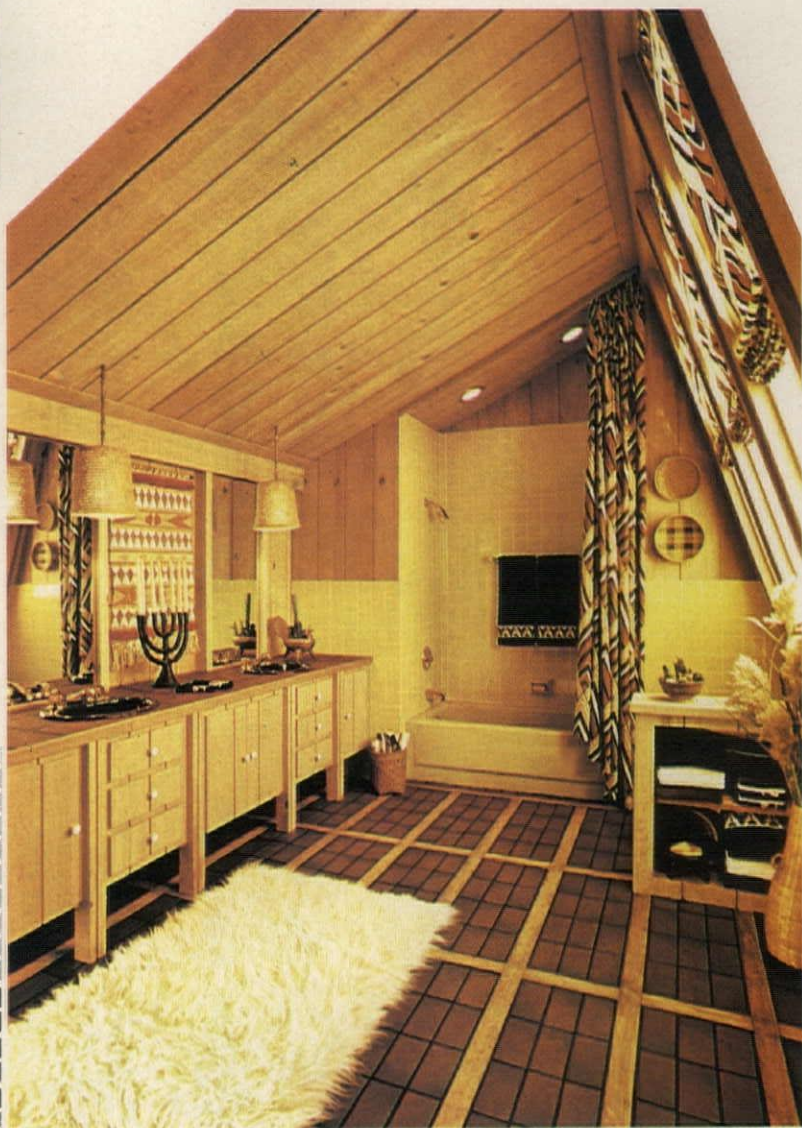

Slab-on-grade lets you build on rocky and soggy soils—at less cost

The new slab-on-grade (S-O-G) copes with the problem of uneven soil movement which cracks conventionally footed foundations and footed slabs because the footers move too. Piling don't move, but they are costly.

The old solution for spongy or plastic soil was a floating slab, with grade beams around the perimeter and through the center, which were reinforced by literally tons of rebars.

The new S-O-G solution uses the same grade beams to form a floating slab, but it prestresses and post-tensions the slab, making it stronger with less steel and costs 5%-25% less.

In Louisiana and Texas, where most of the action in proprietary prestressed, post-tensioned slabs is concentrated, three company names stand out:

- Pre-Stress Concrete Inc. (PSCI), Galena Park, Tex., near Houston, acquired the rights in 47 states to a slab patented by William F. Kelly. (He retains the rights to his system for Louisiana.) It was first introduced to Texas five or six years ago in the San Antonio area, which has some of the most expansive soils in the state.

Last year PSCI supplied strands for an estimated 7,000 slabs for single-family homes plus multifamily and commercial slabs.

- Prescon Corporation, Corpus Christi, Tex., developed and patented a second system. It is most actively installed by a Dallas area firm, Post-Tensioned Systems Inc. (PSI) of Grand Prairie, which was formed in March 1971.

Its first year PSI supplied tendons for some 7,000 slabs (3,000 single family, 4,000 multifamily) and will have a second-year volume of about 8,000 (50% multifamily, 40% single family and 10% warehouse slabs and tilt-up walls).

- Atlas Prestressing Corp., Denver, recently entered the S-O-G field. The firm, a spokesman said, is "the country's largest supplier of post-tensioned strand for commercial buildings". Within the past six months, Atlas installed more than 750,000' of strand for S-O-G construction in Texas and the Denver area.

Walter Snowden of Snowden

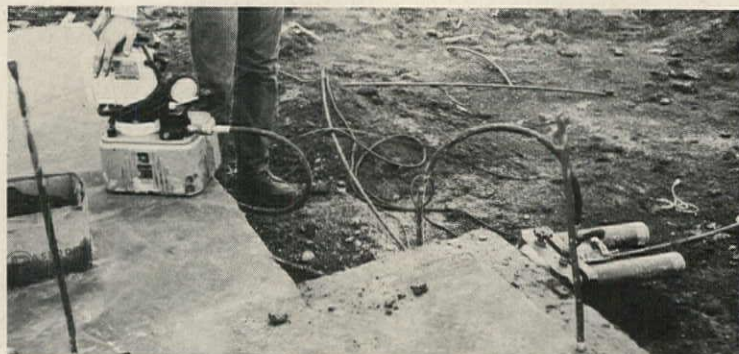
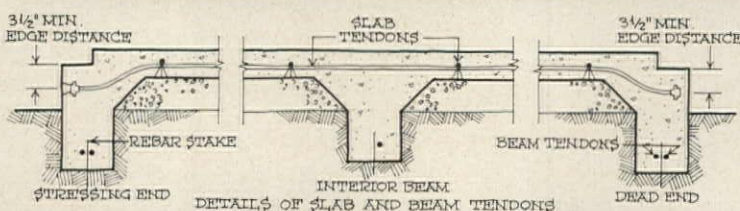

Ready-to-pour S-O-G includes prestressed tendons, forms around the perimeter and trenches dug to shape grade beams. At bottom tendons are post-tensioned.

& Meyer Inc., Austin, a soils/foundation/structural consulting firm, attributes the growth of S-O-G systems to a big breakthrough in soils analysis and slab design: being able to precisely predict the potential expansion of various soils.

"Prestressed, post-tensioned slabs on grade do not do everything the prestress people say they will, or even all that some builders think they do, but this is a good system. For the same soil conditions, most of the time prestressed, post-tensioned slabs will be slightly less expensive. The worse the condition, the more the builder is likely to save."

Snowden speaks from wide experience: "We have completed in excess of 22 million sq. ft. of slab in the past four years without a failure for one properly installed."

Here are the positive things

builders say about S-O-G:

- "A project of 208 garden apartments in southwest Houston which uses 100,000 sq. ft. of slab simply could not have been built on its present site using a conventional slab," says Tom Benson Jr., head of multifamily construction for Westchester Development Co.

"In this area the soil is extremely expansive 'Beaumont gumbo,'" says Benson. It develops wide cracks in dry weather and swells and heaves when wet. The conventionally reinforced slab engineered for this site would have cost \$1.30 per sq. ft. The S-O-G designed for this soil condition—Class 8, the most heavily reinforced—is costing \$1.05. The \$25,000 saving meant the difference between using and not using the site, says Benson.

- Charles E. Hughes, a construction superintendent for

Zachry Properties Division of H.B. Zachry Company, San Antonio, says S-O-G has proved very economical for a steeply sloping hill of nearly solid rock.

"Using S-O-G saves in trenching through rock, and it eliminates a lot of concrete required for building deep beams through fill to natural grade. If I get a building with a small fall from one end to the other, I have to pay up to \$1,000 for a deep beam on the bottom side. I save that by going to cable because I float the slab on fill."

- Danny Cate, construction analyst for the NPC Construction Division of Nash Phillips Copus of Austin, is convinced S-O-G is considerably more economical for rock and problem soils.

"We have done comparative studies, and we find we get our best costs when using S-O-G on rock. On some lots we used to spend \$1.35-\$1.50 per sq. ft. getting an FHA slab put in. With S-O-G, unless it is an extremely bad situation, we get it for \$1.15 to \$1.20 per sq. ft. This has enabled us to use some sites which otherwise we couldn't have considered economically feasible."

- James L. Lougee, production services manager for Raldon Corporation, Dallas, which is building large fourplex subdivisions plus single-family construction, is using S-O-G exclusively. In one and a half years his firm has built around 1,500 units. He estimates a modest 4¢-to-5¢-per-sq.-ft. saving since soil problems on his sites are not severe. "We would use S-O-G even where the cost is the same because we think it's a better slab," he says.

Texas builders attribute these disadvantages to S-O-G:

Tom Benson Jr.: "Even though S-O-G is widely used in Texas, there are few competent installers. When more people start using this, I think costs will come down."

James L. Lougee: "S-O-G requires more field supervision."

Danny Cate: "For a while our people did the stressing, but we had failures caused by not working to spec. After we started using a man who distributes, installs and stresses cable, we had no further problems."

—LORRAINE SMITH
McGraw-Hill News, Dallas



Rising 45 stories high on the shores of Lake Michigan in Chicago, Malibu is a \$36-million complex that contains 856 gracious apartment-homes, as well as tennis courts, handball courts, sauna facilities, swimming pools and boat launching and storage areas.



"Why did we use Gardencourt cabinets in the world's largest condominium?"

Because it's the one cabinet with everything we wanted."

Hy Pawlow, Vice President
Dunbar Builders Corporation, Chicago, Illinois

"The prospective condominium buyer is actually in the market for a quality home. What he *doesn't* want are all the little maintenance chores associated with conventional housing. For our kitchens, that makes Gardencourt the ideal cabinet. It looks just great. Yet it's about as maintenance-free as any cabinet I know of. It's ideal from the builder's viewpoint, too. It's priced right."

Gardencourt. We made it with convenience and care-free living in mind. All the components are covered with a tough but beautiful vinyl with pecan-grain finish.

We add a triple layer of clear vinyl on door and shelf edges for real protection where it's needed most. Inside, there's a light and airy buff vinyl. So clean-up is as simple as a damp cloth, inside and out.

Rugged polystyrene drawers have rounded

corners for easy cleaning. Door hinges are self-closing and easily reversible left or right on the job. For decorating versatility, we finish Gardencourt off with a handsome accent bar in Avocado, Flame or Black.

The result is a stylishly-beautiful cabinet that needs almost no maintenance, and looks great in any kitchen. And in your business, great looking kitchens are pretty important.

See your Scheirich Distributor.

H. J. Scheirich Co., P.O. Box 21037, Louisville, Kentucky 40201.

SCHEIRICH
CABINETRY
FINE FURNITURE FOR THE KITCHEN



St. Louis gets the single-stack PVC spirit

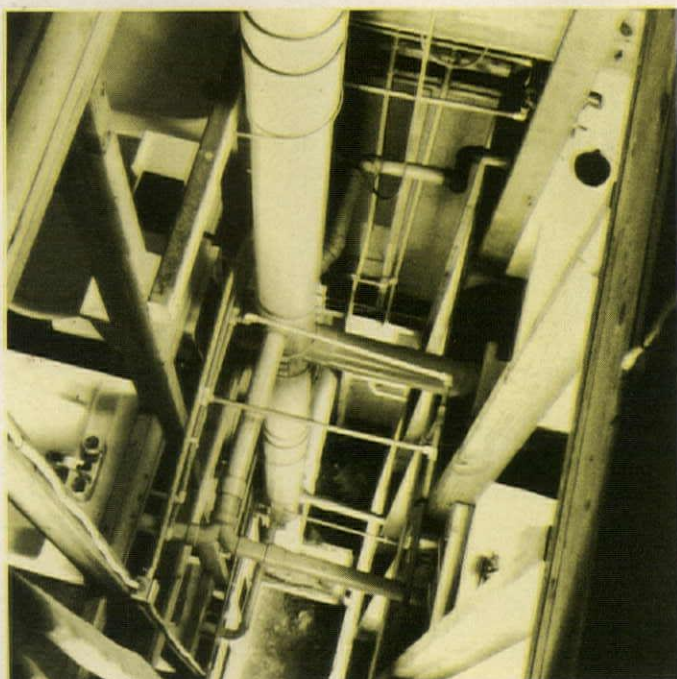

This new 13-story apartment building in downtown St. Louis' Laclede redevelopment area is a plumbing industry landmark. It uses a Genova single-stack PVC drain-waste-vent system — the first high-rise building in the U.S., outside of Philadelphia, to utilize this cost-saving concept. A HUD Operation Breakthrough project, the building is part of a 13-building complex that uses Genova single-stack PVC systems throughout. It's the wave of the future, and St. Louis has caught the spirit.

Genova
The people who get it done

Plants in Davison, Michigan 48423; Malvern, Arkansas 72104; Faribault, Minnesota 55021, and Lancaster, Pennsylvania / Branch warehouses in major cities.



A walk down the wilder side of loan packages—how builder can make two profits out of apartments, or, having your cake and eating it too

It isn't just the amount of money in the mortgage market that is fueling this year's housing boom.

A part of it is the increase in the number of market factors—and the innovation in lending patterns that competition has produced.

This is particularly marked in the apartment sector.

Not too long ago there were only two factors in the conventional apartment loan market: the life insurance companies and the local savings and loan associations.

Today there are at least five factors. The new entries include the eastern savings banks (as national lenders) and the real estate investment trusts. Furthermore, the S&Ls are now acquiring apartment loans out-of-state. And there are even a few mortgage bankers who will commit on and close apartment or commercial loans for their own account, warehousing the loan for resale to another investor at a more favorable time. In addition, nearly all these lenders are under the pressure of heavy cash flows crying out to be invested.

This new competition has had no pronounced effect so far on interest rates. Indeed, our projection is that mortgage rates will move up at least 1/2% by mid-1973.

The two-profit package. There has been real competition in what can be called creative risk-taking, however. Lending packages are being tailored with much more sophistication to builders' tax needs and merchandising patterns.

Here's one example, and it is the closest thing yet devised for giving a builder his cake and letting him eat it too.

When condominiums began to boom, some developers discovered that a good way to cash out of a rental building that had used up its tax shelter was to convert it to condominiums. With the right kind of project the return from conversion was significantly higher than from resale or refinancing.

The next step was to design a new apartment for eventual conversion. And the lenders now have developed the financing package for it.

It's a standard conventional mortgage, with standard interest rates, for 30 years, with a ten-year lock-in.

But it carries the right to convert the building to a condominium after the fourth year. For this privilege the lender is entitled to a pre-set percentage (typically 10% to 15%) of the conversion profit.

If the lender in this package is an S&L,

savings bank or mortgage banker, the builder has a commitment for end financing on his condominium sales.

If the lender is a life company or an REIT, it agrees to make partial releases as the builder sells condominium units. In effect, the end loan on his apartments becomes the blanket standby loan for his condominiums.

Thus in one package the builder has all the financing he needs for two deals, apartment and condominium. He's completely free to exercise the condominium option or not, any time between the fourth and thirtieth year. And he pays no advance premium for this flexibility.

If the market and his choice of site and design are right four or five years from now, he stands to recover his original investment twice—once in the years of maximum depreciation, once on the sale of the units. It makes a wonderful package for syndication.

Another bonus. The bounties of innovative lending don't end there. It's possible to make this same kind of deal with a minimum of equity. An extra wrinkle on the convertible loan is the convertible second mortgage.

In this, the borrower is committed to pay interest for only the first six years at, typically, 1 1/2% above the first mortgage rate. If the project is converted within this period, there is of course no problem. The loan will be discharged.

But if he decides to continue holding the

project as a rental property, he has two options. He can extend the second mortgage for a period of years at the same interest rate but with, of course, some amortization of principal. Or he can convert to land sale and 50-year leaseback, at a rental rate equal to the interest rate.

For this privilege the lender receives a participation—typically, 15%–25% of any increase in gross rents.

Finally, in this package, the lender does not underwrite the prospects of successful conversion. He is satisfied if the deal meets his standards for an apartment loan. Of course, it takes a special kind of apartment, and often a special sales approach, to market condominiums, particularly conversions, successfully. But that is the builder's lookout.

The no-equity deals. There are other innovative loan packages which make it possible to develop land or to build condominiums without a cent of equity—and without giving up any of the eventual profit. These are straight deals, but high priced.

One hundred percent land development loans are available at rates 2% to 3% above the prevailing land loan rate.

Condominium construction loans are available for 85% of value, which is essentially 100% of cost. The rate is usually 4% above prime, or 2% above the rate for standard construction loans.

These loans are usually limited to 40 units at a time. But if completed units are selling successfully, financing is continuously available for 40 units ahead of sales.

Obviously, lenders will not make loans on such liberal terms indiscriminately. They want a builder with some track record and a market that looks strong. They want better-than-average feasibility studies.

Still another example:

Assuming, again, that you have a good record and a good location, it's possible now to convert an existing apartment to condominiums without putting up any equity. These are joint ventures with old-line lenders, such as life insurance companies. The lender supplies all the funds to discharge the mortgage (or to acquire the building from another owner) plus the costs of remodeling and of carrying idle units during the changeover—in return for 20% of the profit plus his normal interest rate.

These are merely a few of the possible examples. In today's apartment market if a builder has a new concept, there is a very good chance he can find a loan package to match it.

EXOTIC LOAN PACKAGES

1. **Apartment-condo option**
 - Start as apartment
 - 75% first mortgage
 - 10% to 15% (loan coverage, not rate) second mortgage (interest only first six years)
 - After four years, builder has option to convert to condominiums. First mortgage converts to end financing for sales or blanket to standby loan.
 - If no conversion, second mortgage may convert to land sale and 50-yr. leaseback.
2. **Three-layer 100% loans**
 - 75% first mortgage
 - Land sale leaseback
 - Secondary financing to close equity gap. Constant on secondary financing is 16% to 17% or lender may become half-owner. Package may also be split three ways among lenders.
3. **100% condominium conversion loans**
 - Covers satisfaction of mortgage (or purchase of building) remodeling, carrying costs during changeover, joint venture with lender. Lender takes 20% of profit and normal rate.
4. **100% land loan**
 - Rates 2% to 3% above prevailing rate
5. **85% condominium construction loans**
 - Rates 2% above prevailing rate (4% above prime)

HENRY LYNGOS, VICE PRESIDENT, ADVANCE MORTGAGE CORP., DETROIT, MICH.

If people stop buying
richness and elegance, we'll be stuck
with a lot of locks.

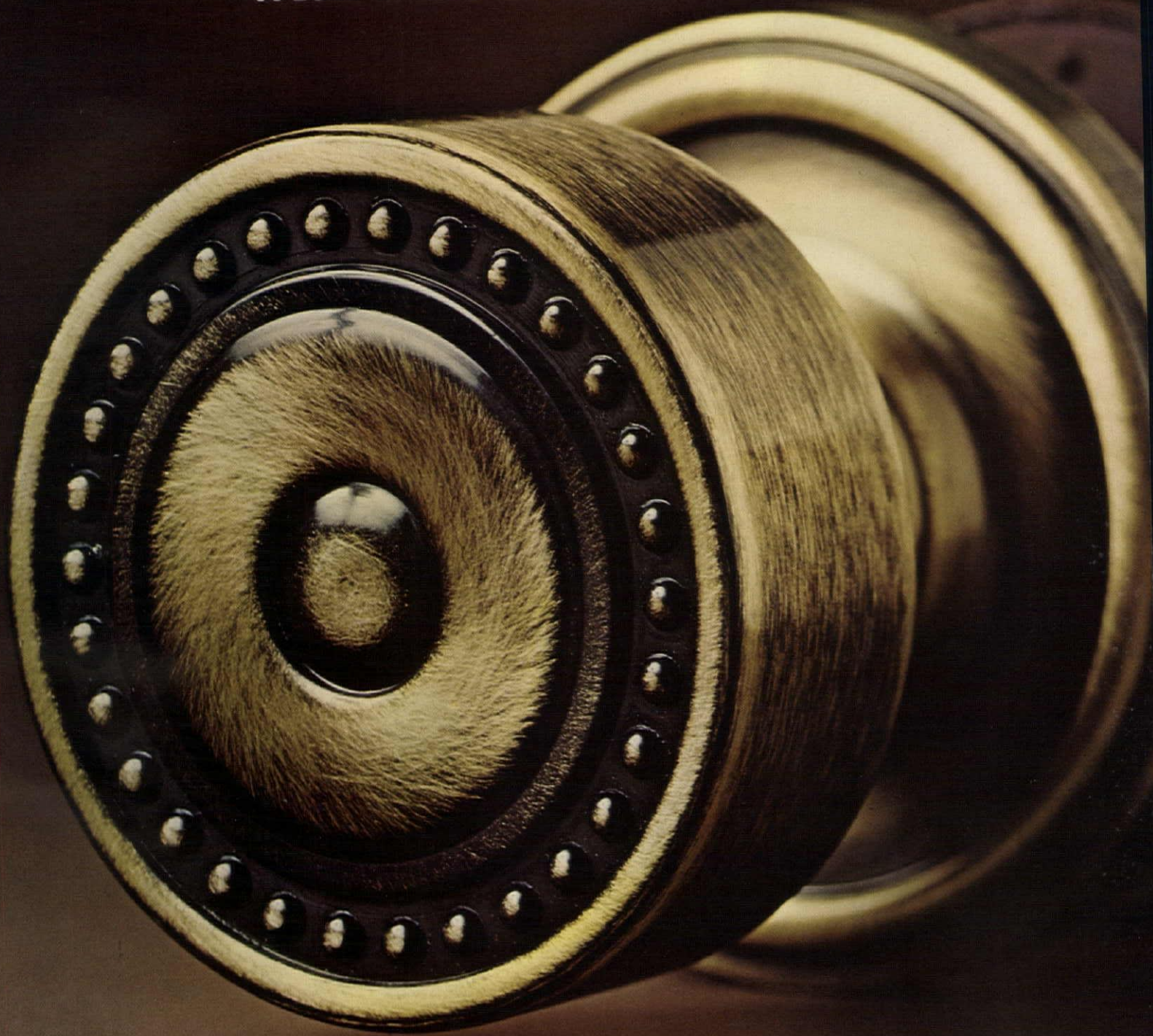

WESLOCK®
The LEADER in Lock Ideas!

Shown: NEW Regency knob style. Antique Brass.

CIRCLE 59 ON READER SERVICE CARD

announcing the **Gang-Nail®** blue ribbon symbol

Mr. Builder: Through the medium of national advertising in TIME and other consumer magazines, your customers are being introduced to the advantages of componentized building and our Gang-Nail Blue Ribbon Symbol! We are telling over 25 million of your potential customers what you already know that Gang-Nail Truss Systems represent the standard of excellence in engineered building systems for over 15 years uniform, strong trusses with unparalleled design flexibility — — trusses you can install with confidence.

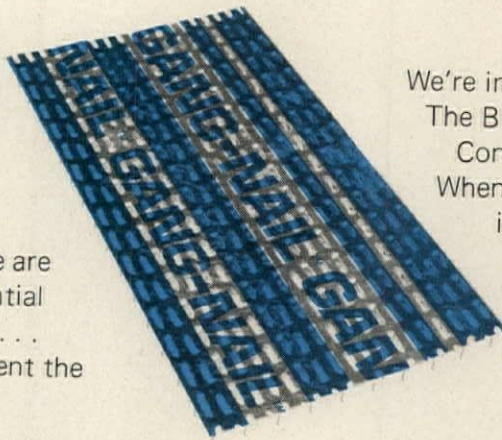

We're in the business of selling trusses. The Blue Ribbon on every Gang-Nail Connector is our badge of quality. When your customers see you wearing the blue ribbon, they know they are receiving the finest components. . . . in an age of growing consumer awareness, most won't settle for less!

See us at NAHB '73 or write:
Box 2037 AMF, Miami, Florida 33159
Toll-free phone (800) 327-3081

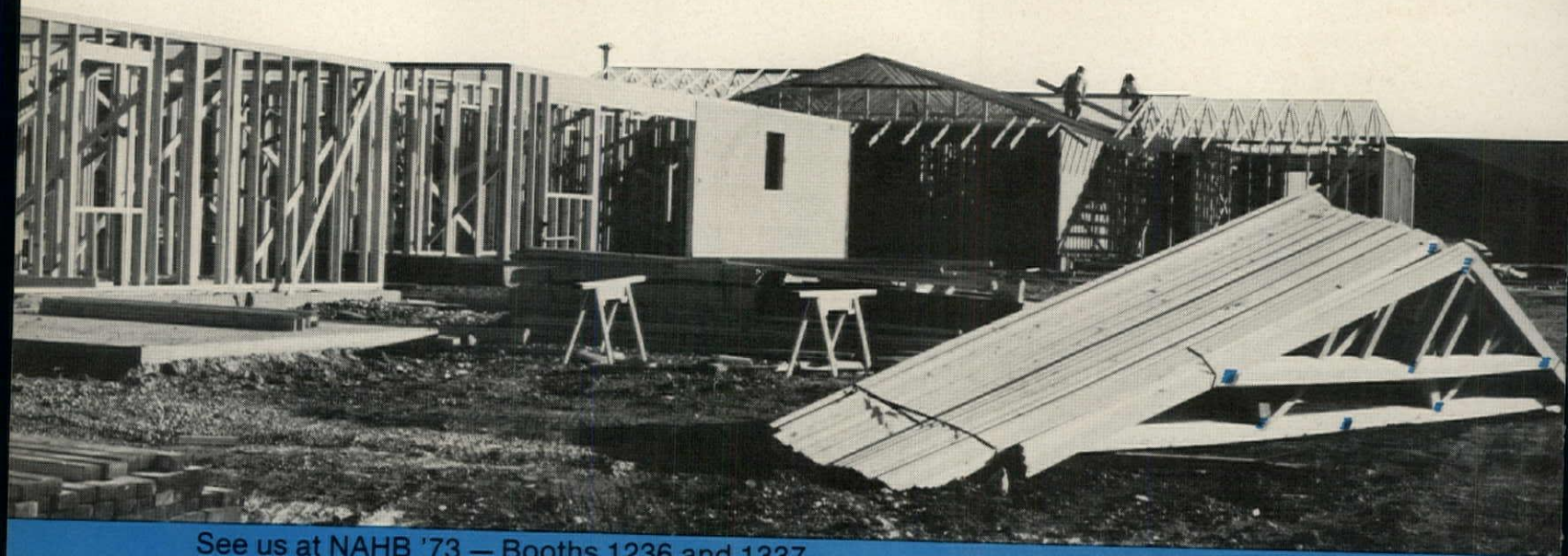

See us at NAHB '73 — Booths 1236 and 1337

©Automated Building Components, Inc. 1972



**Automated Building
Components, Inc.**

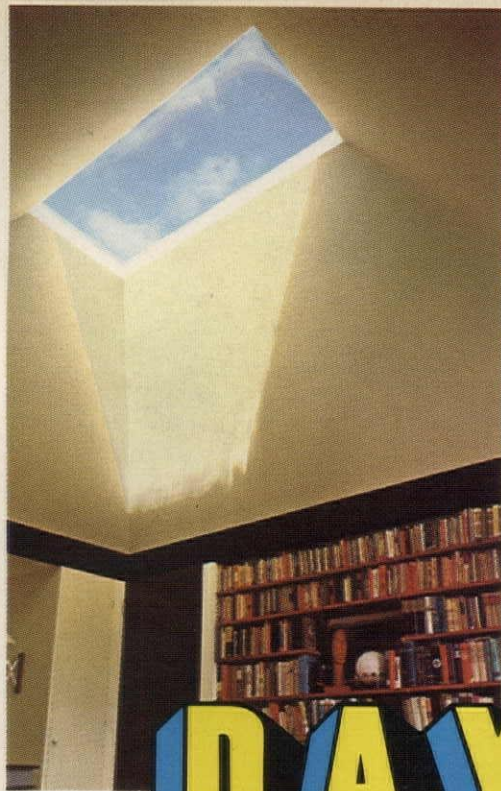

You build a more desirable home when you open it to natural light through single or multiple skylights of Plexiglas acrylic sheet.

Standard skylights of Plexiglas are available in a range of shapes and sizes to conform with any house design and permit the daylighting of all types of rooms, or even a completely enclosed atrium. In addition to crystal-clear colorless Plexiglas, you can choose from a range of grey and bronze tints that control solar heat and glare.

The light weight of Plexiglas makes installation of skylights economical. The toughness of Plexiglas insures safety and ease of maintenance. The time-proved weatherability of Plexiglas makes certain that your customers will be happy over the years with their windows to the sky.

Write for our brochure, "New Ideas in Home Daylighting with Plexiglas" and the names of skylight manufacturers.

PLEXIGLAS is a trademark Reg. U.S. Pat. Off.

FOR MORE
DESIRABLE HOMES:

DAYLIGHT WITH PLEXIGLAS®

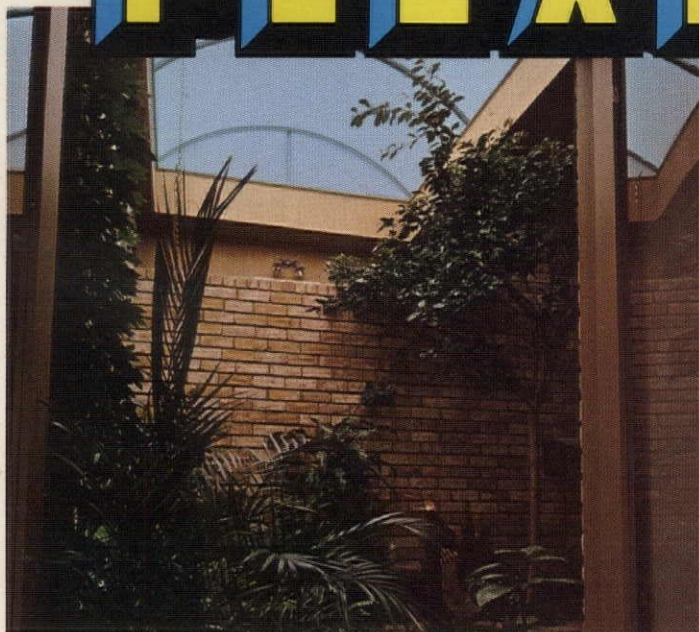

**ROHM
AND
HAAS** 
PHILADELPHIA, PA 19105

**As nice as our cabinets are,
they're only one of the reasons we're the
fastest growing company in the industry.
Here are some others:**



Our variety. On these two pages, we could only show you some of our lines. We have others. They're all in the low and middle price range and cover every styling requirement. Which means we can fill all of your kitchen and bathroom cabinet needs. We can give you what your customers want. When they want it. And when you buy a variety of lines from one manufacturer, you save on inventory space and costs.

Our value. Very simply, we think you'll find that all of our cabinets offer you the highest quality and styling at the best value.

Our size. As of November, 1972, Triangle Pacific had four manufacturing plants and eight regional warehouses. In December, we acquired the Dixie Cabinet Company, allowing us to even better serve the Southeast out of two plants in Tennessee and a warehouse in Fort Lauderdale. Our ever-increasing size and flexibility enable us to service builders of single and multi-family communities, as well as distributors or remodelers. No matter what their size.

Our sales force. Every Triangle Pacific salesman considers it his job to make your job easier. And to help you make more money selling our cabinets.

Our philosophy of growth. Every year, for the last three years, Triangle Pacific has added at least one new manufacturing facility. And our goal is to eventually have a plant within 500 miles of every major marketing area in the United States. But we're not growing just to grow. We're growing to be able to serve our customers more quickly and more economically. And it's working. Three years ago, we were selling cabinets in ten states. Last year, in thirty. This year, in all fifty.

Our distributors. Just as we're the fastest growing cabinet company in the United States, they're the fastest growing distributors in the United States. In short, they're making more money selling Triangle Pacific. You can, too. Call Bob Meltzer, President or Joe Nussbaum, V. P. Sales and Marketing and talk it over.



Triangle Pacific
Cabinet Corp.

9 Park Place, Great Neck, New York 11021, (516) 482-2600

In Houston, we'll be in Booth #3030.
Come and see for yourself why our business is growing as fast as it is and what that can mean to your business.

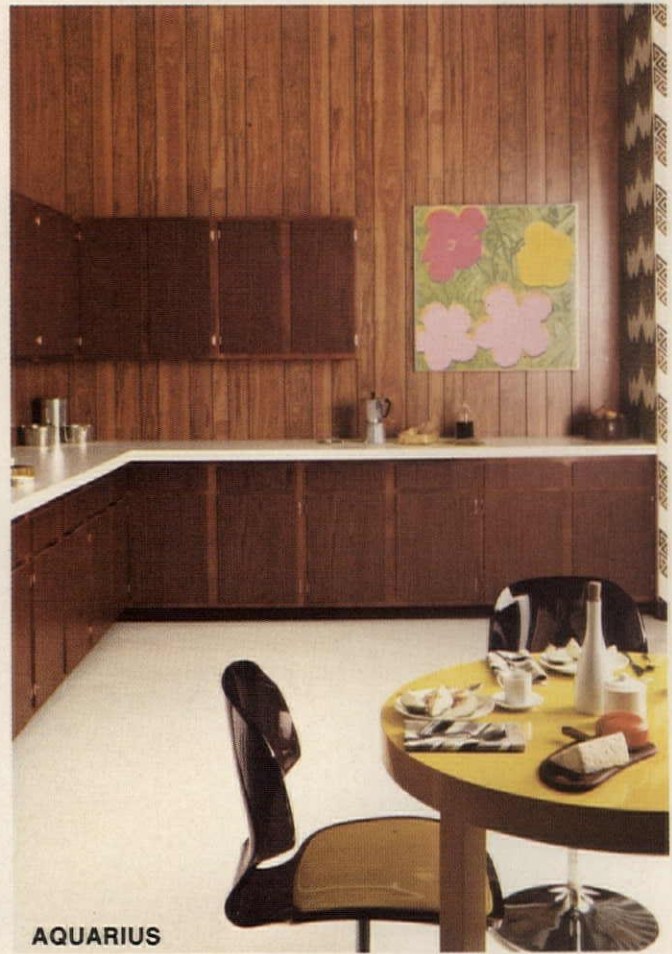
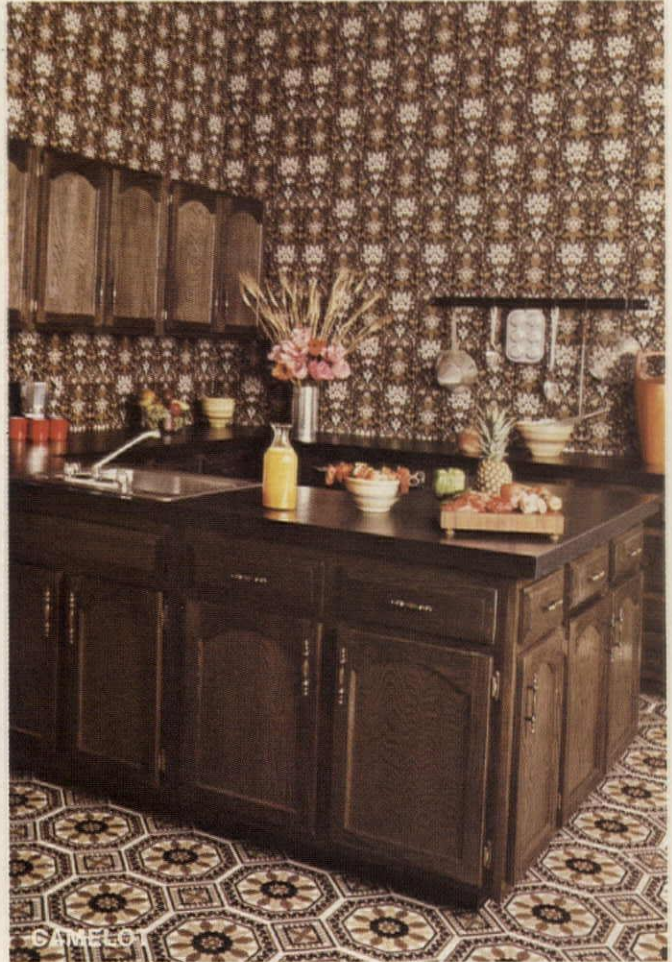



"Imaginative planning is the stuff salable housing is made of. . . Even small units can be extremely desirable if the design lets rooms borrow space from each other"

Primarily because of high land costs, the trend today is toward houses of minimum size. While this reduced size usually meets functional and practical needs of a family, it seldom satisfies the psychological need for space—especially for spatial variety. This is especially true of condominiums where units are small and close together and, for the most part, are expensive when costs are figured on a square-foot basis.

Many buyers of such units are moving from much larger homes to gain advantages like low maintenance, security and flexibility in living style. But this doesn't mean they will buy for those reasons alone. They also want a substitute for the larger space they are leaving. And that substitute can be psychological rather than actual space.

One way to achieve this is through the borrow system whereby space is simply exchanged between one or more rooms to suggest a feeling of more space.

This idea is not new; for years it has been known as open-planning. But somehow open-planning doesn't always work to its best advantage in small builder-housing. What often happens is that after model units are constructed, they look a little small to the builder. So to produce an illusion of space, he resorts to tricks such as insisting that his decorator place mirrors the full length of one wall.

Using the borrow-system, we can illustrate how psychological space is possible without decorating tricks.

A familiar example of borrowed-space occurs at the junction of living and dining rooms (Figure A). This planning approach allows both areas to be somewhat small, yet seem larger since they share one common open end. Why not adapt this concept for other areas?

One way is to borrow space vertically rather than horizontally (Figure B). Here the interrelationship of the master bedroom to the living area permits one to either look up from the living area or down from the master

bedroom and, additionally, through to the outdoors and the dining room.

Another approach is to borrow from nearby outside spaces, employing decks or terraces to increase the feeling of interior spaciousness (Figure C). Again, while this is not a new idea, the full potential of the indoor-outdoor relationship often is not realized since this approach involves an outside wall. It is extremely important that the wall be as transparent as possible. In other words, full height and width of glass—or as much as is practical—should be employed.

A third method of expanding a small space psychologically is through the dual orientation of a room. This works well for a small back bedroom where a jog in the exterior wall is possible (Figure D). Thus one can look in both directions as well as have a light source from each side, thereby widening the room on both ends.

A more far-out way to create a feeling of space is to use an entry or stairs to divide two rooms (Figure E). If the stairs are a see-through design (open risers, etc.) they function much the same as a window, providing a view through them from one room to another. Also, when the stairs are descended, both rooms are experienced simultaneously, thereby creating a dual expansion of space from the stairs themselves. This could be termed a three-way-borrow.

Thus one can begin to see the numerous opportunities that exist for an imaginative architect/planner to create psychological space through the borrow-system. Couple this approach with interior design treatments such as use of eye-expanding colors and materials, properly-scaled furniture and simplicity of window and/or door arrangements, and you can build far more total space (both physical and psychological) than might have been thought possible. And it will cost little, if any, more than a conventional plan. In addition, the interesting design effects created by psychological space will provide a large competitive edge in the marketplace.

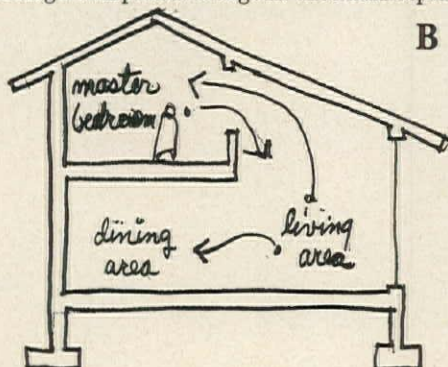
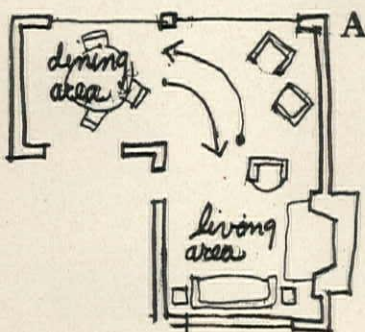
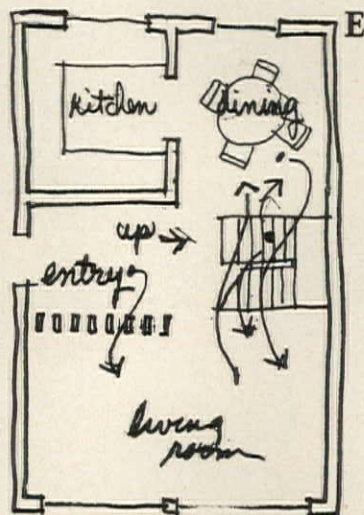
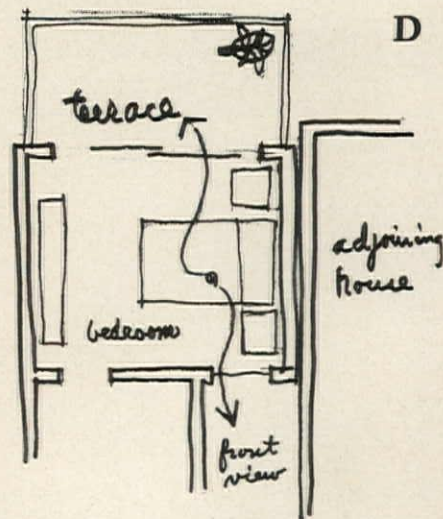
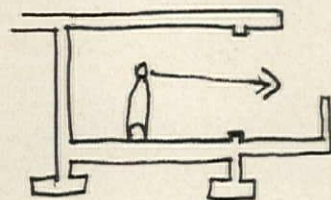
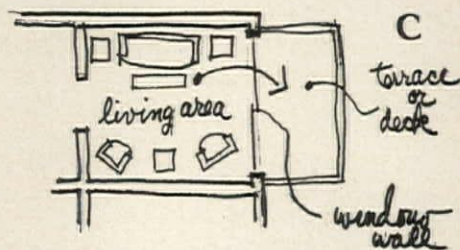

ROBERT W. HAYES, AIA, PLANNING CONSULTANT, SAN FRANCISCO, CALIF.

Symmons' new lav and sink trim: they're the best way to sell houses next to our shower.

When we invented the Temptrol single-handle, pressure-balanced shower, we gave you a system that could really help you sell houses. Because you could tell your customers that pressure-balancing would keep them comfortable in the shower, and prevent scalds and chills, as no other system could. The good-looking contemporary design didn't hurt, either. Now we've come out with new lav and sink trim that will help you do the same kind of selling job. It's just as low on maintenance, and just as pretty as anything we've ever made. Instead of washers, which wear out, it's got ceramic,



which is ageless. We've already tested it through more than a million cycles, and it's just as good as new. Tell that to your customers. Tell the husband he won't have to worry about high repair costs. Show the wife how the finger-tip action of the handle prevents spotting and staining. The whole family will appreciate the smooth movement of the lever handle for positive, accurate selection of temperature and flow. Temptrol shower system. And now, Temptrol lav and sink trim. Together, they're a package that will help you sell houses as no other systems can.

Temptrol

SYMMONS INDUSTRIES, INC.,
31 Brooks Drive, Braintree, Mass. 02184
Tel. (617) 848-2250



PRODUCTS '73

New Products from House & Home Advertisers



a timesaving
guide
to the 1973
NAHB exhibits

Builders attending the big sprawling NAHB convention in Houston next January will face a bewildering array of products, new and old, spread out over a huge exhibit area. Products '73 has been created by House & Home and its advertisers to organize your shopping tour of this impressive display. Copies will be available free at Houston.

see the best, newest, most exciting

This pocket sized guide to the exhibits is a collection of building products, materials, tools and equipment...in each case especially selected by the exhibitors themselves as being the best, the newest, the most exciting they will be offering in 1973. Each product will be handsomely illustrated in full color, described in detail and identified by company and booth number.

save time and steps

The order of presentation in Products '73 will be by booth sequence enabling you to move quickly and

efficiently through the aisles pinpointing just the specific products of interest to you.

The booth numbers will also be color coded to match the carpeting and banners that identify the different sections of the exhibit area. This means you can start your Products '73 tour at any exhibit and still save hours of time and thousands of footsteps.

can't make the show?

If you can't make the show this year you can use Products '73 to see for yourself just what the participating exhibitors are displaying as their

best, their newest, their most exciting. Every copy of Products '73, including those distributed in Houston, will have two reader service cards so that you and your associates can request catalog information by mail.

reserve your copy now

If you can't make the show, you can reserve a copy now by sending two dollars along with your name and address to Products '73, House & Home, 1221 Avenue of the Americas, New York, New York 10020. Your copy will be mailed immediately on publication in December.

Be sure to attend the NAHB Convention in Houston: January 7-11, 1973



**Early warning
fire detection as easy
to install as
a lighting fixture.**

It takes just a few minutes to install the Pyr-A-Larm Life-Safety detector . . . an early warning fire detection unit specifically designed for Breakthrough projects which meets HUD Guidelines Criteria for Industrialized Housing.

Self-contained, the Pyr-A-Larm Ionization Detector reacts to invisible products of combustion and sounds the alarm almost before there is any noticeable smoke, flame or heat. Audible alarm and power "on" lamp are built into the unit so wiring takes only minutes. Operates on 120 Vac input. HUD requirements are one-per-dwelling plus corridor protection for multi-family homes.

For full details about low cost, quality fire detection that can help you fulfill HUD specifications call or write:
Bill Columbus, PYROTRONICS,
8 Ridgedale Avenue, Cedar Knolls,
New Jersey 07927. Telephone
(201) 267-1300

Pyr-A-Larm[®]

CIRCLE 91 ON READER SERVICE CARD

**Designed for "operation
breakthrough" guidelines
for industrial housing.**



“Don't blame all modular manufacturers' problems on pie-in-the-sky predictions. . . Most failures were caused by not understanding industry ABCs”

We can all profit from the failures in the modular housing industry IF—if we properly analyze the real causes involved and not arrive at hasty, erroneous conclusions.

Due to excessive publicity given to the Stirling Homex bankruptcy, the industry is being characterized by the image of acres of modules with no place to go. This may be true of this one company whose chronicle in a recent issue of *Business Week* reads more like a Harold Robbins' novel. But I assure you it is not typical of the industry.

Any active modular housing plant must have finished inventory outside just as automobiles are seen in storage at their assembly plants. The excess of one company in this regard was not an industry-wide symptom, but was more likely an artificial condition created by the demands of Wall St.

We now also read about the other abuses of this same company—such as expensive airplanes, limousines and fancy offices. However, these were the very embellishments that impressed bank loan-officers, Wall St. analysts and government officials.

Suffice to state at this time that the major problems at Stirling Homex were *not* the obvious overproduction or lack of marketing. They go deeper and are much more involved than this oversimplification. Hard as it may be, I suggest that we should not get hung up on this one *un*typical company, but instead go on toward a solution of the *real* problems of the industry.

In analyzing over a dozen industry failures, one major factor is clearly evident in 85% of the cases: *Production volume was well below expectations, and production costs were above expectations.*

The essential ingredient. To be a valid concept the modular housing unit must first have economic feasibility out the factory door. Admittedly there are other necessary elements in a completely successful operation—marketing, transportation and site-work, for example. All are important and deserve adequate attention. But these prob-

lems, important as they are, become superfluous if the module is not cost-effective when it leaves the plant. And with the problem companies, most financial projections failed in the factory.

But while major cost overruns have been in the factory, the cause is *not* primarily production efficiency, but mainly design and material choices which created production problems. Frivolous design concepts, sometimes just-to-be-different and made without adequate consideration for manufacturing feasibility, have been widespread in the industry.

Major mistakes in design are not easily forgiven. Plant layout and expensive equipment rigidly oriented to such a product quickly develop negative value. Production volume is limited, but must continue due to prior commitments while overhead remains an excessive burden.

Satisfactory prompt corrections in production frequently are impossible since the defects are locked-in to prior decisions in design, materials and manufacturing. Turning around a modular operation in this condition can mean almost starting again from scratch.

Overhead on a per-unit basis creates the largest excesses over cost projections as production remains below expectations. A reasonable amount of direct labor inefficiency can be absorbed, but when an overhead geared to a 1,000-unit annual production has to be absorbed by only 400 units, the extra cost is intolerable.

Elementary requirements. Many companies have learned their lessons the hard way. Primarily because of inexperience, they ignored certain basics. To wit:

- The design process cannot be an independent function. It must be an integral part of the total operation. The use of outside architects who do not fully understand production, shipping and site-erection can only lead to future problems.

- An economically sound modular housing operation cannot be a custom-job shop that produces the designs of others for specific projects. To be efficient, a mass-production facility must have controlled repetition in volume.

- Flash Gordon designs should be avoided. These include vertical modules, steep pitched roofs, hinged and push-out sections. All look great on paper, but are a nightmare in the factory and at the site.

- Exotic new materials of a revolutionary nature which are untried and unproven should be bypassed. New materials and concepts, specifically oriented to modular housing, will come in time—but on an evolutionary basis.

- Production processes should be kept *simple*. Avoid wet operations requiring drying time. Simplify mechanical installation into sub-assemblies by careful design of these areas. Keep mechanicals *out* of floor systems.

- Prototypes should be produced and constructed before moving ahead with a factory and equipment. Each phase of the production and erection processes should be carefully time-studied in the prototype stage with design and material changes being made as necessary.

Sound concept. The basic reasoning that made the modular housing industry necessary still is valid. Every builder is more aware today than ever before of not only the cost and inefficiency of labor, but also the lack of quality.

We can all learn and profit from the mistakes of others if we properly analyze cause-and-effect. Modular failures will continue, but they all can have indirect benefits.

It's a fact—even your latest model home is full of old ideas, or variations of old ideas. ❁ But here's a new idea. The Tappan Trash Compactor.

An exciting convenience many home prospects have never seen, and most have never used. ❁ It takes the trouble out of trash by crushing bottles, cans, cartons and stuff into a neat, round package—with up to 3000 lbs. of compacting force. (That's 50 percent more pressure than most other brands.)

❁ And a Tappan

Trash Compactor is versatile. Only 15 inches wide. You can install it under-counter, end-of-counter or free-standing. ❁ Want a

Turn on the high pressure salesmanship.

competitive edge? Use a little high pressure salesmanship—the

Tappan Trash Compactor. You'll hardly have to say a word. ❁ For information and the name of your Tappan distributor, write Tappan, Dept. B 2612, Tappan Park, Mansfield, Ohio 44901.



TAPPAN.
WHEN YOU HAVE
A CHOICE

Tappan Trash Compactor.



The beauty of building with Franklin adhesives is that they help you build so beautifully.



And the beauty is not in the appearance alone. With Franklin adhesives it goes much deeper.

The structure you build is stronger from top to bottom, inside and out, because Franklin adhesives can be used throughout.

Roofing, flooring, siding. Resulting in more productive working time from your crew, lower costs, improved profitability.

Carpeting, paneling, cabinetry. The finishing touches that make such a difference... made better with Franklin adhesives.

Caulking and sealants, other Franklin products. Contributing substantially to the quality of your homes, your apartments, your building projects.

Franklin has been supplying the product to meet the specific application for nearly four decades, all supported by superior research and engineering, assuring you of dependability.

You will discover a Franklin product to satisfy your particular needs.

For example, Franklin Construction Adhesive meets the requirements of American Plywood Association Specification AFG-01, HUD-FHA Use of Materials Bulletin No. 60, and has received wide acceptance for use with the APA Glued Floor System.

Truly, the beauty of building with Franklin is more than a surface beauty. It is the beauty of a fine structure, a satisfied customer or client, an efficient operation resulting in greater quality and fewer callbacks... all amounting to the beauty of a more profitable return.

Learn more about Franklin products and how they can be meaningful to you. Mail the coupon today.

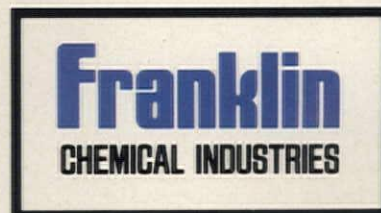

THE FRANKLIN GLUE COMPANY

2020 Bruck Street
Columbus, Ohio 43207

We want to know more about Franklin Adhesives.

Please send information. Have your representative call.

Name _____

Title _____

Company _____

Address _____

City _____ State _____ Zip _____

Type of Business _____

CIRCLE 71 ON READER SERVICE CARD



"Decorated models can do a double-pronged marketing job . . . All that's needed are a few off-beat touches —and maybe some personal help from your decorator"

After the model home or apartment complex has been decorated and furnished, there's a temptation for the builder to sit back, wait for his advertising to break and hope he'll be flooded with an endless stream of traffic.

Advertising is, of course, your most important promotional tool; but it can't always firm sagging sales after a grand opening.

One grouping that is often overlooked is the model interiors. You've waited all those months for your designer to complete them. Why should they become a passive part of your marketing effort?

In other words, your decorator helps to merchandise your basic product—shelter. Why not merchandise her basic product—the decorating?

The principal objective is to get broad exposure for the interior environment. Focusing on the inside of a house in a newspaper ad is not enough unless your interior designer has been able to create something truly newsworthy.

Since word-of-mouth is still the most powerful form of advertising, I suggest a promotion that involves both your models and your interior designer.

The most effective promotion actually is not very promotional. It is nothing more than making certain your models offer decorating tips, design ideas, creative accessories—decorating suggestions that visitor-prospects can glean from your model units.

This responsibility is yours. If I were the builder I would sit down with my decorator and go over point-by-point the newsworthy or innovative features in the models.

For example, an interesting, provocative dining-room set can be created by using two church pews, sawn in half and placed around an old oak table. It's the kind you find in off-the-beaten-path hotels and restaurants.

Consider what this accomplishes. First, rarely do you see this type of dining room set. So the prospect remembers it; your model sticks in his mind. But more important, the idea is one that he can duplicate with little effort and little money (not to mention the fun he'll have looking for these old relics).

But since you cannot always rely on word-of-mouth advertising, some subtle promotion may be needed to stimulate it. Here is where you, the builder, should start thinking like a public relations man.

One approach that works rather well is to announce that your interior designer will

A newspaper interview (either in the real estate or home furnishing section), with the decorator discussing the newest trends in furniture and interior design as show-cased at your development, has a certain amount of editorial appeal. An overt commercial pitch for your project should be avoided. If you have a truly good story, either you or your public relations man can make the initial approach.

Good photography is another vehicle for getting your model-home interiors in front of potential prospects. Newspapers and magazines will often accept a photograph of a novel piece of furniture cleverly used in a model. A pinball machine adjacent to an old player piano in a game room is usually good editorial fare for a local Sunday supplement.

In selecting photographs for submission, be sure each tells a mini-story in itself. Following are four examples that might be suitable for local or national publications.

Photo A. Sewing is enjoying a popularity revival, hence this little girl's sewing center with peg-board backing has appeal for the do-it-yourselfer. In color or black and white, the story comes across.

Photo B. A larger sewing room for mother can be easily and inexpensively reproduced by dad and the kids. The cutting table and storage shelves are built into the space normally reserved for a closet.

Photo C. Who isn't playing chess these days? The checkerboard flooring in this youngster's rumpus room caters to junior hoofers or budding Bobby Fischers. The room, a throwback to the Henry Aldrich soda fountain era of the 1940s was specifically designed to capture the nostalgic era.

Photo D. This turn-of-the-century nursery has Victorian accents and an antique crib rescued from a second hand store.



CAROLE EICHEN, CAROLE EICHEN INTERIORS, FULLERTON, CALIF.

make a weekend appearance at your model complex to offer free decorating tips.

While this might have a strong show-biz ring to it, you may be surprised at the crowd it can draw. In addition to the traffic generated, the builder and the decorator often get unusually candid comments and reactions to their product.

For best results, schedule the appearance from 1:00 to 4:00 p.m. on a Sunday. If your salesman has a hot prospect on the verge of buying, the decorator might help close the deal by taking the prospect on a personal tour of a model and explaining firsthand her design philosophies and objectives while fielding his questions.

Judicious use of publicity is another way to gain greater exposure for your model-home interiors, and thus create additional interest in your project.



LAWSON

All-American Bathroom Cabinets and Light Fixtures

The sales power of the bath is hardly a new discovery. (Fact is, Lawson pioneered the "bath extraordinaire" years ago with some of the first true decorator cabinets and mirrors.) Today, with your competition tougher than ever, Lawson continues to lead in bath products that give you that sales edge. The elegant new wood framed Lawson mirror-cabinets below, with their classic matching light fixtures, are supreme examples of this leadership. For sparkling new literature on cabinets, light fixtures and bathroom accessories, visit us in Booth 3133 at the NAHB Show in Houston. Or, if you prefer, write or phone the cabinet company builders know best: The F. H. Lawson Company, 800 Evans Street, Cincinnati, Ohio 45204; phone 513/251-2400.

Known For Quality Since 1816

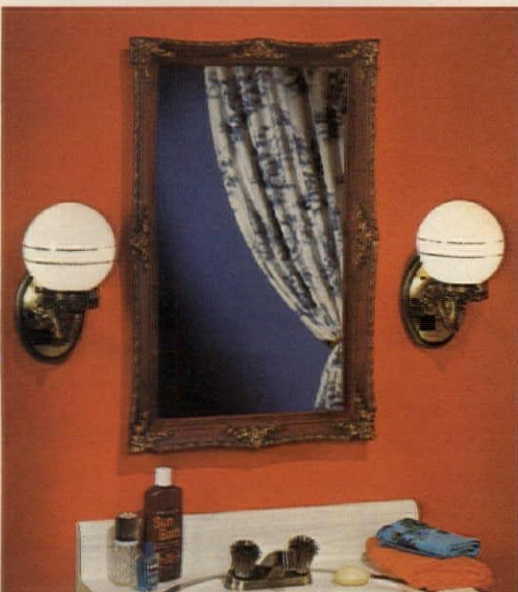
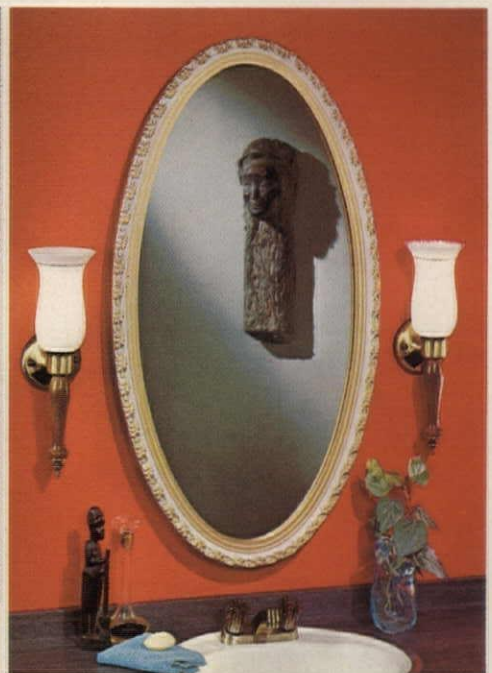
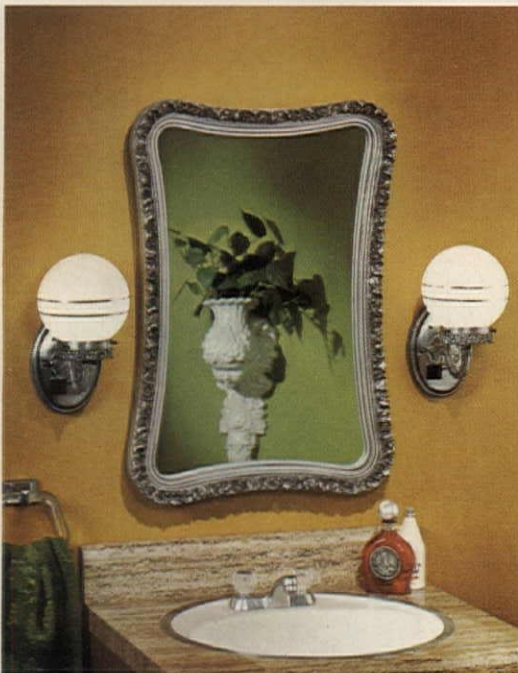

STYROFOAM TG stands alone as sheathing and high performance sidewall insulation.

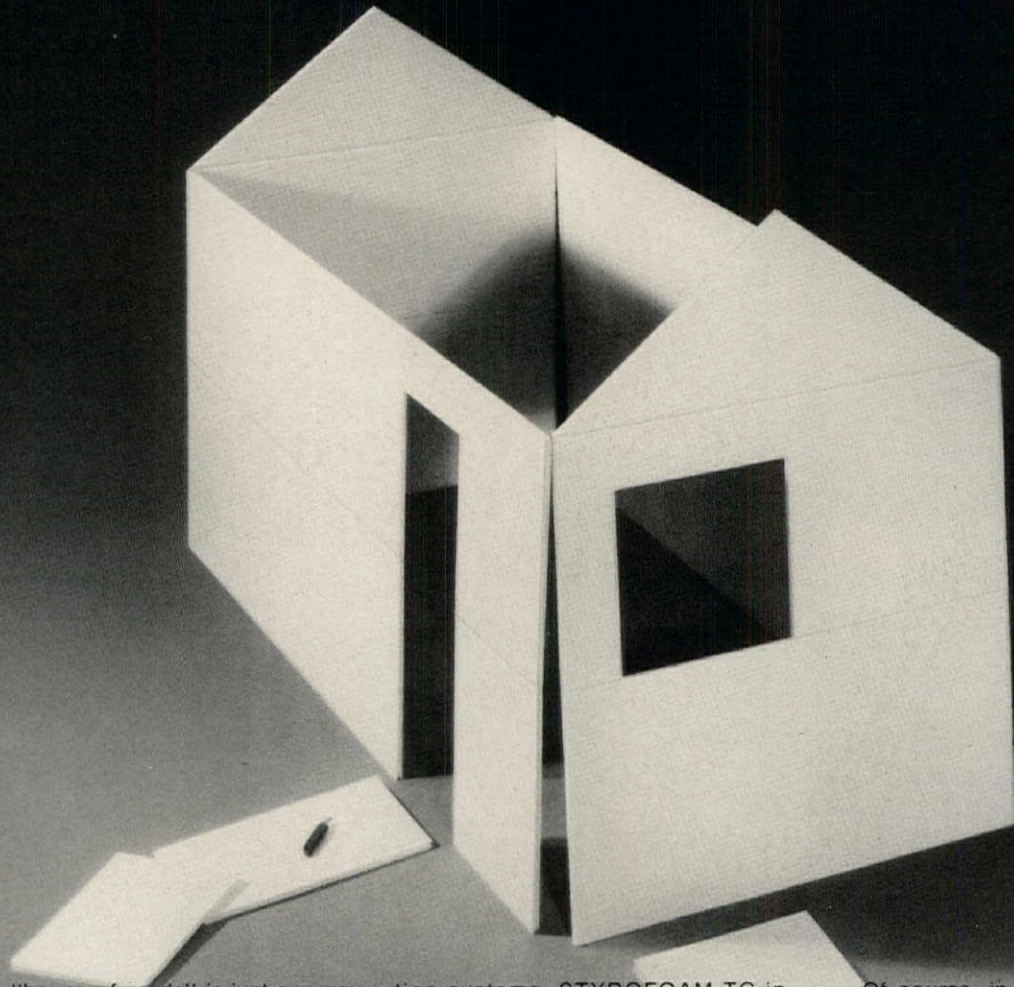

The "house of cards" is just our way of showing you that STYROFOAM® TG brand plastic foam insulation is rigid, so it can do the sheathing job. And because it's so lightweight, it can do the job in less time. But more importantly, STYROFOAM TG is high performance insulation, covering all of the outside of the frame . . . all the wood areas that go unprotected in conventional sheathing-batt insula-

tion systems. STYROFOAM TG insulates 100% of the sidewall area, other than door and window openings; no other insulation material can make this claim. And at the same time, STYROFOAM TG takes the place of conventional sheathing; no other insulation material can make this claim. Savings? Of course. Better performance? You bet!

Of course, in actual use STYROFOAM TG is not a structural sheathing; it needs the normal stud frame with corner bracing. But can you imagine any other insulation being able to stand up for a picture like this? And can you think of any other insulating material that can do the job of both sheathing and insulation? That's the point we're trying to make.

*Trademark of The Dow Chemical Company



Amspec Inc. / 1880 Mackenzie Drive / Columbus, Ohio 43220 / (614) 457-2580

We'll make our point even stronger at the NAHB Show in Houston. Stop at our booth and see STYROFOAM TG work; see how STYROFOAM TG stands alone as sheathing and high performance insulation.



Jerry J. Avison shows off the double Nord Imperial doors used in the Knightsbridge Condominium Apartments near Detroit.

From Michigan, An inside story on Nord entry doors.

Builder Jerry J. Avison is one of the three co-partners of the Lone Pine Apartments Company. His 68-unit Knightsbridge Condominium Apartments spread out over 16 lush acres in West Bloomfield Township. And to add to the luxury look of each interior, Jerry decided to use Nord carved entry doors inside.

Reasons: Price, Quality, Craftsmanship.

Explains Jerry, "Because the doors are located on the library, just off the living room, a quality, distinguished-looking door was needed. It had to be decorative and give a massive impression, as well as provide a warm reception for company." Nord's Imperial filled the bill. And Jerry found its quality craftsmanship helped sell these \$59,900 condominiums.

The Nord Philosophy.

As an independent builder, Jerry's free to be an innovator. And the same holds true of Nord. The Nord family's philosophy combines

natural wood and old-world craftsmanship with today's advanced technology. Which means builders like Jerry Avison can have Nord doors of distinction at "commodity" prices.

For full-color literature on Nord doors, just write "doors" on your letterhead and mail it to E. A. Nord Company, Everett, WA 98206.

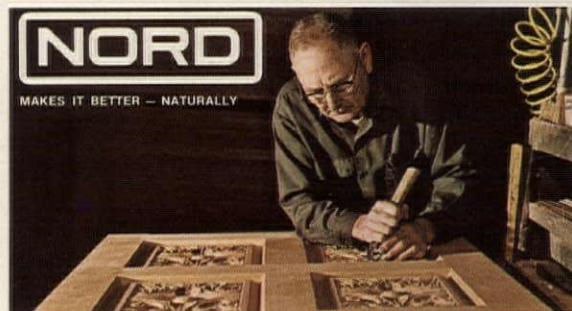

The skilled hands of one of Nord's artisans put the finishing touches on a carved entry door.

insist
on a
genuine **Genie**®

AUTOMATIC GARAGE DOOR OPENER SYSTEM
BY **ALLIANCE**

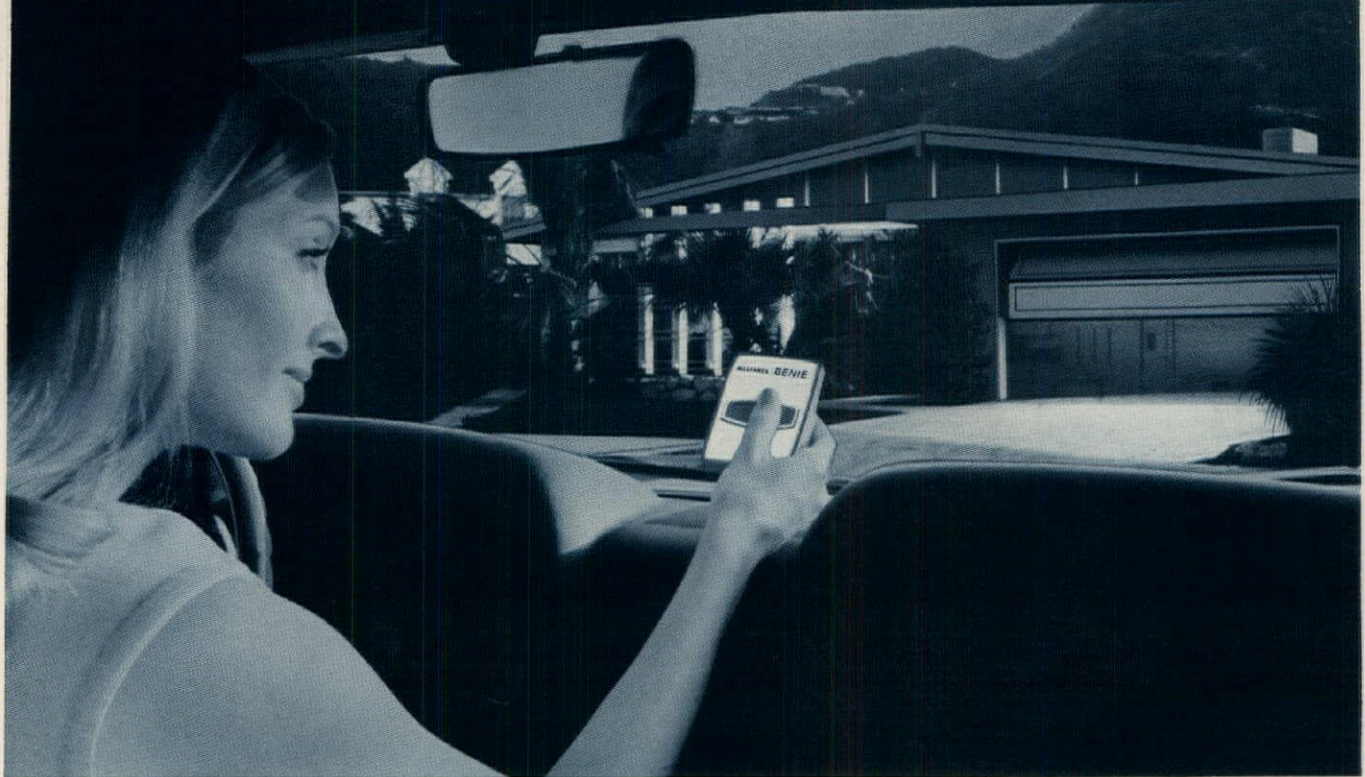

Genie—"the garage door picker-upper!"

Opens the door...turns on the light...closes the door...locks up tight!

Genie! The extra touch that closes home sales faster.

Genie! Pre-sold through national advertising and local promotion.

Genie! Backed by a nation-wide network of reliable dealer service outlets.

Genie! Performance-proved by satisfied users everywhere.

Call your local dealer or mail coupon today. You'll find out how the merchandising program for Genie Automatic Garage Door Opener Systems by Alliance can help you sell more homes.

The **ALLIANCE** Manufacturing Co., Inc.
Alliance, Ohio 44601 Dept. HH-12

Send booklet about Genie
and names of nearest dealers.

Name _____

Address _____

City _____

State _____ Zip _____



The **ALLIANCE** Manufacturing Co., Inc., Alliance, Ohio 44601
A NORTH AMERICAN PHILIPS COMPANY

® **Maker of the famous Antenna Rotator . . . Alliance Tenna-Rotor® . . . "TV's Better Color-Getter!"**

©1971 The Alliance Mfg. Co. Inc.

See us at Booth 2050, NAHB show, Houston

JOB MARKET

Division managers: full development responsibility. **Cost analysis:** monitor and analyze construction cost. **Contract negotiator:** review and originate subcontracts. **Take-off analyst:** create material lists/costs. **Construction manager:** oversee full project. **Real estate developer national**—Multifamily requires experienced personnel in various disciplines of light construction. Salary range \$10,000 to \$40,000—plus fringe benefits. The above positions are available immediately. Write giving experience and salary requirements to Box 1201 JOB MARKET House & Home, 1221 Avenue of the Americas, New York, N.Y. 10020.

Need Strong Developer/Builder: with capital patience, knowledge of annexation, utilities, zoning. Ann Arbor, Michigan. 436 acres. Expressway frontage. Contiguous to City. Two miles University of Michigan North Campus. Sell, participate. Write to Maynard Newton, Jr. EARL KEIM REALTY, 2349 East Stadium Boulevard, Ann Arbor, Michigan (313) 622-2571.

Construction superintendent: Aggressive, take charge man wanted by rapidly growing company in New Jersey. Must Have experience in one-family and multi-family projects. Reply TRIPLE "E" CONSTRUCTION INC., P.O. Box 28, Monmouth Junction, N.J. 08852.

Project director: Central California corporation needs manager experienced in construction, financing, and marketing of single family and apartment developments. Send resume and salary history to P.O. BOX 376, LODI, CALIFORNIA 95240.

Single family project manager: wanted immediately for high quality community building program. Must be strong in single family construction. Will manage several superintendents—no traveling. Career position with great opportunity for advancement. Send resume to President, IMPERIAL HOMES CORPORATION, 2551 Sunset Point Road, Clearwater, Florida 33515. A division of U.S. Home Corporation.

Director of marketing: wanted immediately for rapidly growing community builder currently grossing 24 million in a wide

range of single and multifamily communities around Clearwater, Florida. Extensive experience in all phases of merchandising essential. No traveling or selling. This new staff person will develop and coordinate all merchandising activities including advertising, sales displays, and printed sales tools by the advertising agencies. This is a career opportunity for growth and advancement. Mail complete resume to Executive Vice President, IMPERIAL HOMES CORPORATION, 2551 Sunset Point Road, Clearwater, Florida 33515—A div. of U.S. Home Corp.

Shelter Executive Personnel Recruitment Specialists. **Division president.** Multi project home builder to \$90,000 package. **Operations V-P.** Multi projects. Multi state home builder. Apartments and condos. To \$100,000. **Project managers.** Single multi-family. \$20-30,000. **Architects/Design directors.** National home builder. \$25,000. **Executive positions nationwide.** Fee Paid. VANCE EMPLOYMENT SERVICE, 917 Barfield Building, Amarillo, Texas 79101. 806-372/3456.

Sales Manager: shirt sleeve. Set up organization of dealer/builders in East for pre-cut cedar homes with significant exclusive feature. No salary or draw, but high incentive, including ownership participation. Call MR. RAYBURN, Saturday through Monday #717-775-7341. Wednesday and Thursday #914-698-8312.

LAND MARKET

Michigan: Recreation and hunting forties in Michigan's Upper Peninsula and Northern Wisconsin. All heavily timbered. Good access. Some on water, all with streams and lakes nearby. Write: Jeffery R. Jurmu, P.O. Box 303, Stephenson, Michigan 49887.

Illinois: Well-started PUD for sale or joint with strong builder... all or part of single-family, multi-family, commercial. Topography, plan, zoning, utilities, location all put together, within 20 minutes of downtown of major midwestern city, near 3 interstates. Also shelter investments. Box 102 LAND MARKET House & Home, 1221 Avenue of the Americas, New York, N.Y. 10020.



Here's why you don't know us

We weren't ready for you yet. For a quarter of a century, Zenith has been the leading supplier of metal bath products to the largest and finest retailers in America. Until we could offer the building industry that same top quality and service, we held back. But now we're ready:

Impressive New Product Line—Quality cabinets that complement the elegance of any new home. We're showing you two, but we've got 48 others. Plus a brand new catalog to give you all the details.

Unusual Delivery Policy—2 new plants and an extensive warehouse system with locations in many key cities to insure on-time delivery. Order it and forget it. It'll be there, probably early.

Sharpest Prices—Absolutely the best prices in America for quality medicine cabinets.

New Building Division—Set up specifically for the building industry. 65% more sales representatives too.

Jim Aruffo—Our new president, the leader of our dynamic, new, "make things happen" management team.

Now that you know us, call or write for our new catalog. And see us at the NAHB Show, January 7th—11th, Booth 2171.

ZENITH . . . we live up to our name!



Zenith

METAL PRODUCTS



32" One-Piece Shower

36" One-Piece Shower

48" and 60" Deluxe
One-Piece Shower

40" square Oriental Soaking Bath
60" Stretch-Out Tub and Surround



For complete freedom of choice in fiberglass: Designer Line

Three new tubs now give you a broader line than ever. With a choice of nine tub and shower models in 13 sizes, including above-floor installation. Covers every kind of bathing technique from 84" stretch-out to square oriental soaking tub. A complete choice of showers from remodeling units to a 60" wide luxury model with a built-in seat.

Designer Line is made by the company that's named by 75% of the architects who specify by name for commercial and institutional buildings.

For the best in fiberglass—as in all fixtures and fittings—it's American-Standard.

American-Standard, P.O. Box 2003,
New Brunswick, N.J. 08903.

 **AMERICAN
STANDARD**
PLUMBING / HEATING

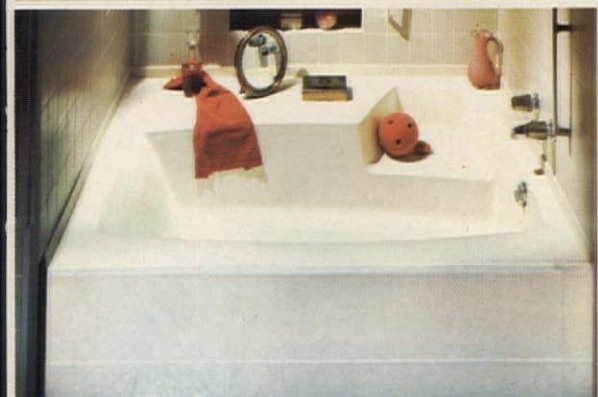

72" Oval Pool with end outlet
72 x 54" Gothic Pool, for two

84" Oval Pool with center outlet

When you're a builder-minded company like Whirlpool, you take better care, starting at the drawing board.



You make it your business to care — through every stage of engineering, manufacturing and distribution, up to and long after the builder turns over the keys.

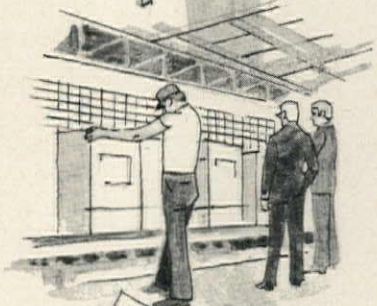

At Whirlpool, we try to build the kind of appliances you'd want in your own home. That doesn't just mean top of the line. The same, hard nosed quality control inspectors keep a watchful eye on our budget models, too.



Not just the way they're built but the way they're packaged — for secure shipment through a nationwide system of distribution points, to your building site.

And what happens *after* your buyer or tenant moves in, has always mattered to us. That's why we installed the Cool Line — a toll-free, day-or-night customer information number. So she'll call us, instead of you.

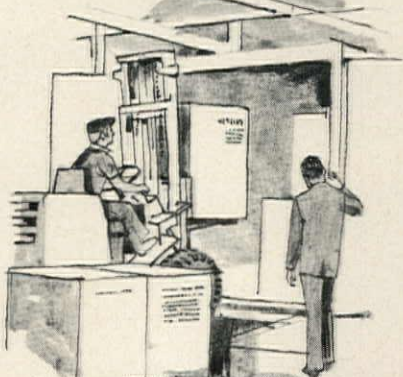

That's why Whirlpool Warranty Central Service pays the costs to honor our warranty obligations. (It's our responsibility, not yours.) And that's why we maintain a network of authorized Tech-Care Service centers in all 50 states — to make sure quality service is always available.

All things considered, there are *lots* of good reasons besides consumer acceptance of our brand name to plan Whirlpool appliances into your next project. So give your Whirlpool Distributor a call. You'll be doing business with someone who knows the builder business, who speaks your language, who does a lot more than write orders.

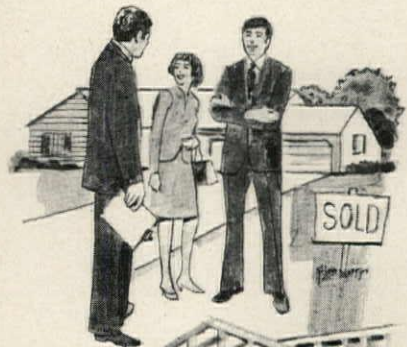

Whirlpool CORPORATION

...BUILDERS FOR BUILDERS

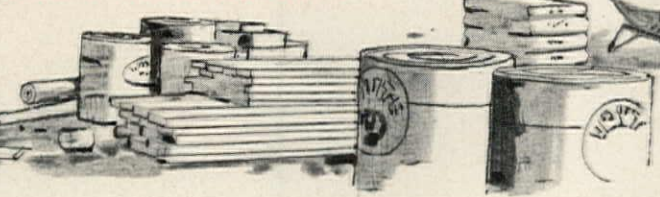

Modular housing

H&H: Compliments on a superb October issue telling both sides of the modular housing story—its failures and its successes. It was a fine example of objective reporting, especially when contrasted with recent lopsided reports that have appeared in the *Wall Street Journal*, *Barrons*, etc.

RICHARD L. BULLOCK,
executive vice president
National Association of
Building Manufacturers

H&H: Your analysis, the "Two Faces of Modular Housing", [Oct.] contains many incisive observations that were long overdue. It also makes a few statements that do not tally with the facts in evidence. Having had a modest role in the early stages of Operation Breakthrough (in Northeastern Ohio), I consider it a matter of public interest to set the record straight.

It is correct, as you state, that HUD promised to stimulate production—at the rate of about \$20,000,000. The fallacy lies in the promise, not the fulfillment. Operation Breakthrough clearly laid out three phases of action: 1) preparation of prototype sites, 2) production subsidies, and 3) market aggregation. There was nothing wrong with this phasing. But

when it came to implementing the program, HUD committed some spectacular errors that in the end killed the entire program. For example:

- In demanding prototype development sites in selected locations, HUD expected local authorities to furnish these exhibit areas free and pay for all site improvements; no funding was provided for this and, as a result, the most important locations in the nation—including Ohio—said "thanks but no thanks". As to the ten selected locations, weird assignments were made by HUD: California manufacturers exhibited in Wilmington, Del., while an Ohio producer was assigned to sites in Georgia and California.

- As to production subsidies paid, one portion duplicated normal development costs a manufacturer would have paid anyway; another portion supported—quite heavily—new component systems that went way beyond reasonable cost limits and lifted basic unit cost levels out of reach of most moderate-income buyers for whom the program was originally designed. Moreover, some of the more sensible component systems were already, at that time, in various stages of experimentation.

- The highly publicized market aggregation never got off the ground,

and no funding was anticipated for it at any time. Thus, the most important phase in the development and promotion of a new product designed for mass production and facing reluctant reception was left dangling in mid-air—which clearly accounts for your emphasis on the comparison between production and installation.

Quite obviously—as I vainly pointed out at that time—the whole concept was poorly conceived and badly misdirected. Wall Street apparently did not recognize these fallacies and went hook, line and sinker for HUD's glittering promises, ignoring the habitual losses on start-ups and expecting huge, early profits out of pamphlets and news releases rather than proven marketing processes.

It is sad, indeed, to visualize how narrowly HUD missed the boat. Instead of gunning for the prototype-site concept, it could have utilized readily available scattered sites in its over 2,000 urban renewal projects—most of them with all site improvements in place. A one-page directive from Secretary Romney could have made sites available in hundreds of communities, probably at a write-down. Furthermore, if HUD would, at least, have developed a plan for local public entities and regional or-

ganizations to institute some form of land banking for modular housing, potential demand would have been created before production started.

It would be frivolous to say "Better luck next time". After and beyond the modular concept, there may not be a next time—except dehydration, maybe???

JOHN H. HAAS,
housing consultant
Cleveland, Ohio

Impact zoning

H&H: I found your August article on impact zoning to be one of the most informative articles in quite some time, and you can be assured that land-use planning will be a key factor in land development as soon as the federal land-use agency is organized.

Must reading for all who desire to prepare themselves for impact zoning is an excellent, in-depth book entitled *Design with Nature*, by Ian L. McHarg, The Natural History Press, 1969, both in hard- and soft-bound. This volume deals mainly with the natural determinants of impact zoning which is the single most important factor in this zoning philosophy.

T. A. JACOBI,
landscape architect
The Architects Collaborative
Cambridge, Mass.

Weathering for sale ...



Long Island home; Architects: Vernon and Jay Sears, Quoque, Long Island; vertical siding treated with Cabot products.

To enhance
the beauty
of wood...

Cabot's STAINS

Why are stains often chosen over paints? Because wood and stains are made for each other . . . stains bring out the best in wood, blend naturally, beautifully into the setting. For the home shown here, the architects specified Cabot's Bleaching Oil to attain the weathered "driftwood" look . . . an effect heretofore found only in seacoast areas after years of exposure to salt air. Cabot's Stains, in 87 unique colors, protect the wood, enhance the grain, grow old gracefully, never crack, peel or blister.

**Samuel Cabot Inc.**

One Union St., Dept. 1230, Boston, Mass. 02108

- Send color cards on Cabot's Stains
 Send Cabot handbook on Wood Stains

"Cabot's Stains, the Original Stains and Standard for the Nation since 1877"

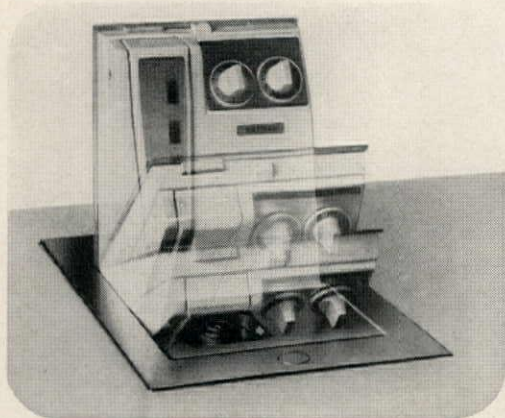

Hydraulic Lift-Lower Mechanism
Module raises and lowers in and out of counter. Closes flush with counter top.

Latch Release Knob
Retracts two latches located inside attachment well to unlock and release attachments.



3-Position Mixer Arm
1) Locks in horizontal position for mixing.
2) Raises even higher and locks in place to drip-clean beater.
3) Folds out of the way when not in use.

Beater Release Latch
Releases beater from power socket.

Professional Two-Way Mixing Action
Bowl and beater are powered by separate drives. Bowl rotates one way, beater the other way for smoother, more complete beating and mixing.

Beater Clutch and Arm Release
Button stops beater while bowl continues to rotate. Also releases arm to adjust to one of three positions.

Automatic Timer
Sets the Foodmatic for automatic use. Also can be set for manual use.

Solid-State Speed Control
Provides infinite choice of speeds. Solid-state circuitry assures no-stall power.

Speed Selector Guide
Imprinted on mixing arm.

1/3 HP Motor
Extra power to operate more than a dozen attachments. Will not stall at any speed.



New Ronson Built-in Foodmatic

Listed by Underwriters' Laboratories 

New Ronson Built-in Foodmatic

...the one appliance that does the work of dozens, does it better and in less space. It mixes, blends, slices, shreds, grinds meat, grates, sharpens knives, grinds coffee, juices oranges, crushes ice... it even cooks!

The following attachments are available for the Ronson Foodmatic



Two Beaters, Two Bowls, Turntable and Dough Hook
Turntable and heat-resistant glass bowls interlock to keep bowls firmly in place.



Deluxe Juicer
Comes with two interchangeable ceramic reamers... small for lemons and limes... large for oranges and grapefruits.



Knife and Scissors Sharpener
Hones knives and scissors to original sharpness in seconds.



Salad Slicer-Shredder
Comes with three types of discs.



Meat Grinder
Three grinding discs store in handy compartment.



Wide-Base Blender
Takes whole fruits and vegetables. Even crushes ice.

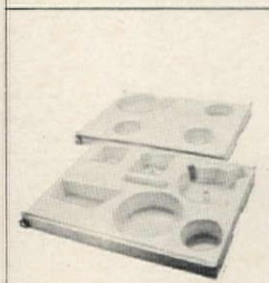

Two Custom-Molded Trays
Contoured to hold all attachments.



Ice Crusher
Dial settings for ice from chunks to shavings.



Coffee Mill
Grinds beans for drip, percolator or vacuum coffee makers.



Stirring Cooker
Stirs automatically as it cooks at dial-set temperatures from 100 to 400 degrees.

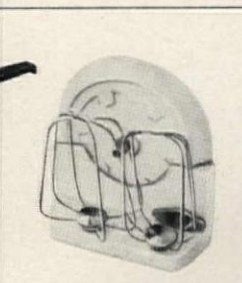

Mount Organizer
Holds beaters, turntable, blender key on cabinet door.



Recipe Booklet
Over 100 pages of recipes and illustrations for hundreds of drinks and dishes.



Portable On-Counter Model
Uses same attachments and has same operating features as Built-in Foodmatic. Storage trays can be mounted in kitchen cabinet.

Console Model
Free-standing cabinet with casters. Only 18" wide. Power module hydraulically lowers flush with "butcher-block" counter top. Uses same attachments and has same operating features as Built-in model.



Ronson Corporation
Built-in Major Appliance Department
One Ronson Road
Woodbridge, New Jersey 07095

HH/D

Please send me additional information on the Ronson Foodmatic.

Name _____

Street _____

City _____ State _____ Zip _____

RONSON

DIFFERENT BY DESIGN AND BETTER BECAUSE OF IT

Today's buyers want more than a new home, they want a new world.



Today's Americans want a world that's clean and pollution free. They're creating a heavy demand for natural gas. Because gas is clean-burning energy. In fact, there is no cleaner burning fuel. That's why gas is such a great way to heat a house, and cool it, too.

The gas industry is working very hard to meet the growing demand for clean gas energy. Sinking deeper wells than ever before. Drilling

under the ocean. Working to pipe in gas from Canada. Importing some LNG (liquefied natural gas) from overseas. Even researching to turn things like coal and oil into clean gas energy.

It's a lot of work, and it's expensive. And it's going to mean somewhat higher prices in the future. But all forms of energy will be going up. So gas will continue to be the most economical for your customers. And the cleanest.

Gas, clean energy for today and tomorrow

 American Gas Association

Visit our Booth 1500 at the NAHB Show in Houston, Jan. 7-11

BODY-BUILDING BABY SITTERS!



TRAILBLAZER — This space-saver, with its parallel step-slide design, provides years of fun and exercise for youngsters. Order Model 107 or a Junior Trail Blazer Model 106.



FLYING PONY SWINGS — Children pick a pony and gallop off to the land of sheer happiness with this 2-or up to 9-pony swing set. Rods prevent twists or sways. No sharp edges on ponies, grips or foot rests. Pipe frame coated with "Perma-Lok" to hold color, fight weather. Lifetime oil-impregnated bearings. Order Model 204.



BOUNCE-AROUND WHIRL — A spring-action whirl that is worth hours of safe pleasure. Hub assembly and main bearings guaranteed 3 full years. Colorful fiber glass center dome. Order Model 307 today.



TWIN RIDER — Solo or double, this patented teeter-bouncer carries a full year guarantee. Five faces to choose from. Heavy duty twin coil springs. Very low price. Order Model 608-3.



BACK STOPS — Miracle has every kind of backstop imaginable. Fiber glass or steel back stops. Fan or rectangles. Steel or nylon nets. All built to last and last. This popular model 741 will withstand years of action.



Call or write today
for your free
full-color catalog of
fascinating fun ideas.



Home Office
P.O. Box 275
Grinnell, Iowa 50112
Telephone 515/236-7536
TWX 910 - 520-2826

Eastern Division Office
Parkesburg, Pennsylvania
Telephone 215/857-5533
TWX 510 - 663-9016

Western Division Office
Los Angeles, California
Telephone 213/778-0544
TWX 910 - 321-3823

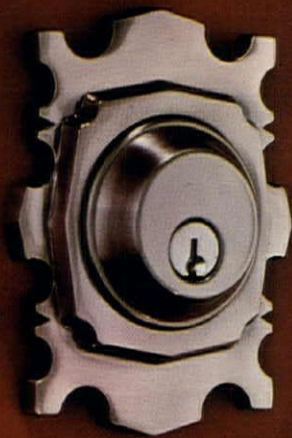

First Impressions-

On Mediterranean styled homes or those with a Colonial influence, new sectional handle sets by Weiser enhance the entrance with their rugged beauty. Stately sentinels of security, they'll be noticed and admired each time friends come to call. Whether used on a single carved door or in pairs on double door installations, Weiser sectional handle sets in El Cid or Heritage styling leave an impression of rugged security and matchless quality.

For a fresh approach in your hardware appointments — for entranceways that leave a lasting impression, specify sectional handle sets by Weiser.

WEISER® LOCKS

WEISER COMPANY
SOUTH GATE, CALIFORNIA

ANOTHER NORRIS INDUSTRIES BUILDING PRODUCT

CIRCLE 86 ON READER SERVICE CARD

products 1973

It's show time again—time for HOUSE & HOME's annual product preview to present the wide range of building and decorative products developed for today's housing. They run the gamut from bathroom accessories to structural materials, from kitchen cabinets to heavy equipment. And most will be on display in Houston as builders and manufacturers gather at the NAHB show. Also included in the issue are many interior accent items—not being featured at the Astrohall—that can be turned into marketing plus-factors for model homes and apartments. Many products shown are brand new; others are up-dated, revised, revamped versions of industry favorites. This year a number of manufacturers have stopped trying to revolutionize the housing world and have concentrated their efforts on improving existing products. Strong demands by builders and consumers alike have spearheaded this approach. Zeroing in on the ecological emphasis of the day, manufacturers have focused on environmental and safety features. The trend is toward low-maintenance, ease-of-installation and durability. Warm earthtones, crisp outdoor colors and rough textures reflect a growing interest in nature. Both interior and exterior products are being designed with this in mind. In all, 181 products are presented for inspection. An in-depth look follows on the next 18 pages and picks up again on page 128. For easy reference categories are indexed at right.

Bathrooms	88-89
continued	128
Coatings/Adhesives	182
Doors/Windows ..	90-91
continued	152, 156, 163
Electrical	104-105
Environmental	188
Exterior	98-99
continued	192
Fireplaces	100-101
continued	200
Flooring	96-97
continued	172, 176, 177
Furniture	100-101
continued	130
Heating/Cooling	138, 140
Interiors	94-95
continued	196
Kitchens	92-93
continued	132, 134
Lighting	98-99
Outdoor	104-105
Plumbing/Pipes	205
Structural	102-103
Tools	142, 146, 150

bathrooms

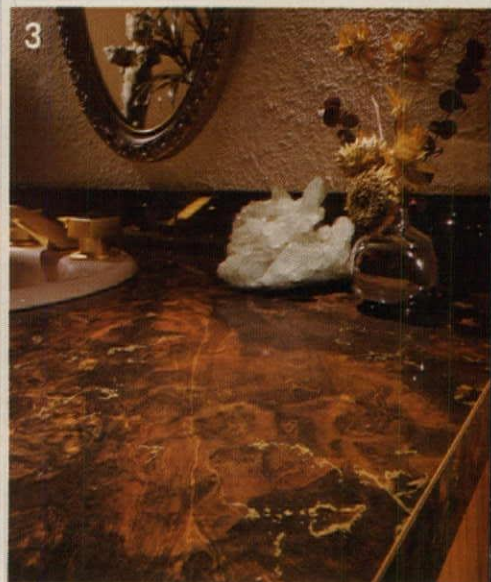

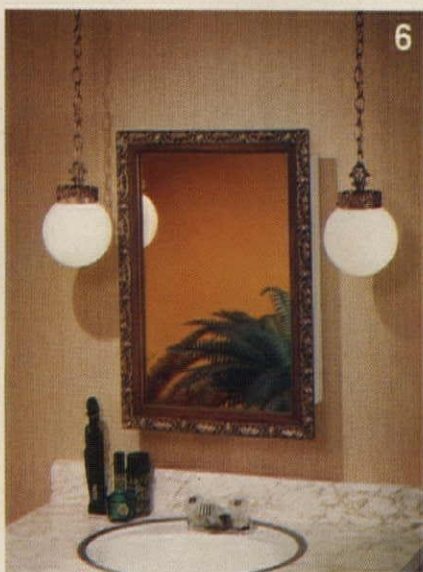

1. Personal shower with interchangeable hand spray attachments is a versatile bathroom fixture. Shown are a bidet attachment with a chrome finished aerator head, two standard sprays and a brush unit. Compact attachments are easy to store. Alsos, Somerset, Mich. *Circle 200 on reader service card.*

2. Rigid tub enclosure features frost, amber or avocado styrene panels in a cracked-ice pattern and an anodized aluminum frame. Doors with easy-grip handles slide easily in lubricated vinyl channels. A special T-lock design prevents accidental dislodgment of doors. Kinkead, U.S. Gypsum, Chicago. *Circle 201 on reader service card.*

3. Laminated plastic pattern, "Fire Agate" is a simulated sleek brown marble highlighted with orange undertones. It is designed specifically for vanity tops to coordinate with the popular browns, blacks and oranges of contemporary linens. Formica, Cincinnati. *Circle 202 on reader service card.*

4. Elegant "Ultra" fixtures in creamy bone are featured in a traditional custom bathroom. The 30"x20" "Ultra-lavatory" is equipped with an "Ultra-font" fitting that provides an up, then down, arc flow of water. A special "Luminar-flow" design prevents water from splashing and spraying. The "Luxor" toilet includes "Vent-Away", a device that removes odors through the wastepipes as the unit is flushed. A matching "Margate" bidet is also shown. The 42"-wide "Ultra-bath" features a large, luxurious bathing oval and "Heritage" fittings. American Standard, New Brunswick, N.J. *Circle 203 on reader service card.*

5. Wall-mounted toilet has siphon-jet flushing action for fast, quiet efficiency. The "Florentine" features a cyclac ABS water reservoir with a tapered, low silhouette design. The vitreous china bowl is finished in acid-resistant ceramic glaze. Borg-Warner, Mansfield, Ohio. *Circle 204 on reader service card.*

6. Medicine cabinets and coordinated incandescent lights make a complete decorative ensemble for the lavatory area. Light fixtures are available in combinations of pewter or brass with walnut finish and a wide variety of globes and shades.

Wall-mounted side-lights and single and double swags are offered. Cabinet is framed in walnut with gold accents. Surface-mounted unit has a swing door and a plate or float glass mirror. F. H. Lawson, Cincinnati. *Circle 205 on reader service card.*

7. Vanity tops with integral bowls are made of silicone and polyester and closely simulate the look of marble. Center, double and offset oval bowl tops are offered in six marbled colors. The tough, hard surface is impervious to sprays, medicines and other chemicals. Bradley, Menomonee Falls, Wis. *Circle 206 on reader service card.*

8. Side-lighted cabinet door is framed in a walnut finish with a gold-edged, linen-textured inner frame. Pre-wired lights are easily attached to the cabinet body. Plate or float glass mirror is electroplated, copperbacked and guaranteed for five years against silver spoilage. Miami-Carey, Monroe, Ohio. *Circle 207 on reader service card.*

9. Molded fiber glass "Uni-shower" is 48" wide. The compact one-piece unit is treated with an exclusive fire-retardant process. The curved decorative shower has an integral seat, molded-in soap and utility shelf and a built-in towel-rack safety-handle. Universal-Rundel, New Castle, Pa. *Circle 208 on reader service card.*

(For more on bathrooms turn to page 128.)

doors/windows

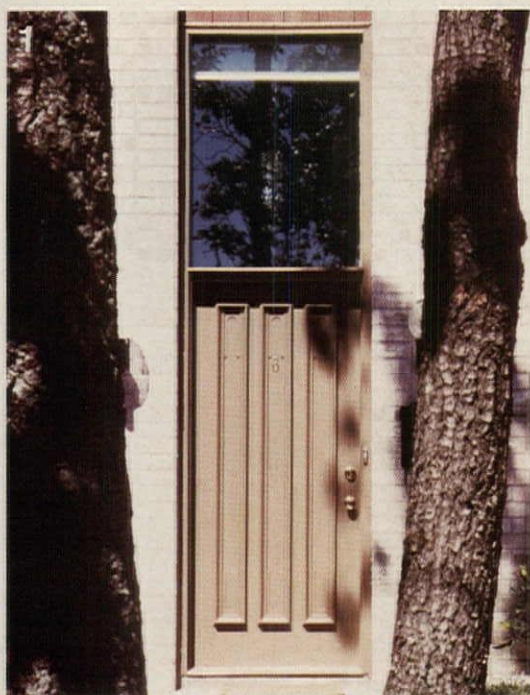



8



9

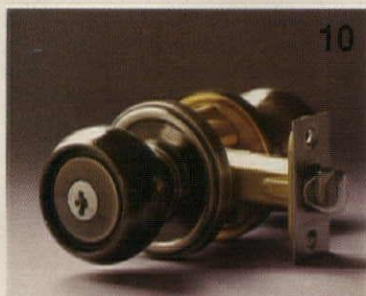

10



11

1. Foam-core steel door has a thermal-break edge that eliminates temperature convection between interior and exterior steel skins. Prehung doors with decorative moldings are available with or without door lights. Ever-Strait, Pease, Fairfield, Ohio. *Circle 209 on reader service card.*

2. & 3. Stile and rail doors, made of clear vertical-grain Douglas fir, are available in a full range of carved and panel designs. "Navajo," (2), a 1 3/4"-thick door, blends well with Mediterranean and contemporary Western styling. "Carthage," (3), is an elegant deep-carved, eight-panel door inspired by ancient craftsmanship. Nord, Everett, Wash. *Circle 210 on reader service card.*

4. Door veneers, carved of high-density urethane, feature original designs such as "Sunburst" shown. Weather-resistant units feature sandwich construction with a solid wood door as the core. Simulating fine hardwoods, doors are available in four hand-rubbed shades. Entol, Miami, Fla. *Circle 211 on reader service card.*

5. Wood patio door has a thermal barrier sill constructed of aluminum and wood and a dense woven-pile weatherstrip with a center plastic fin that seals out drafts. Doors feature a white factory-applied finish on all exterior surfaces and a natural wood tone inside. Tempered insulating glass is set in a welded vinyl gasket. Cardaco, Scovill, Dubuque, Iowa. *Circle 212 on reader service card.*

6. Sliding patio door has a rigid built-in thermal break that helps eliminate condensation. The patented "Climate Guard" manufacturing process provides a solid plastic insulating barrier integrated between the exterior and interior frame sections. Door features a special security lock with a supplemental slide bolt that locks unit at a 5" open position. Reynolds Metal, Richmond, Va. *Circle 213 on reader service card.*

7. Decorative lockset offers the security of a deadbolt and the ornamental design of a grip-handle unit. The lock is available in three styles: the "Normandy" and "Seville" shown and the "Bedford". Inside knob can be selected from several styles. Schlage Lock, San Francisco. *Circle 214 on reader service card.*

8. Vinyl-finished prehung door is

available in four woodgrain patterns. A vinyl-wrapped split jamb adjusts to walls from 4 1/2" to 5 3/8" thick. Three hinges provide extra stability. Doors, available with hollow or solid cores, have sealed color-matched edges for a finished look. Georgia-Pacific, Portland, Ore. *Circle 215 on reader service card.*

9. Cylinder deadlock offers triple security. Unit features a 1" extra-long solid brass deadbolt with a 3/8" steel rod insert, two solid steel reinforcing rings and an all-steel cylinder guard. The easy-to-install device has a massive heavy-gauge strike with four staggered screws for maximum holding power. Available in antique and etched finishes. Kwikset, Anaheim, Calif. *Circle 216 on reader service card.*

10. Decorative keylock has a five-pin tumbler cylinder deadlatch and a locking pushbutton. Preset screws provide fast, easy installation. The "Galaxy", available in a choice of seven finishes including the antique silver shown, features a snap-on inside rosette and a panic-proof inside knob. Weslock, Los Angeles. *Circle 217 on reader service card.*

11. Designer door with Mayan influence has rows of tiered dimensional panels. Shown in a double door entranceway, unit is styled to blend with Southwestern and Mediterranean decors. Door is supplied prehung and primed to be painted as desired. Weatherproof steel-constructed door has a redesigned astragal that provides trouble-free opening and closing. Therma-Thru, Toledo, Ohio. *Circle 218 on reader service card.*

(For more on doors turn to page 152.)

Kitchens

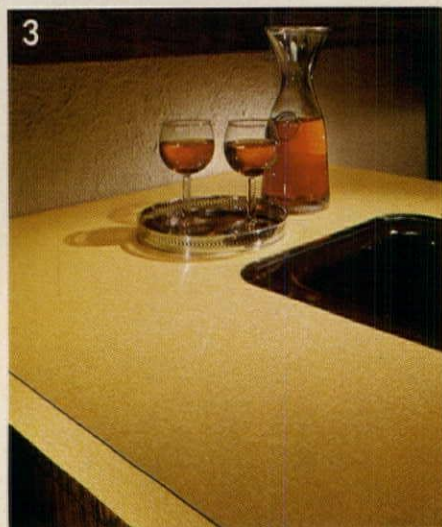



1. Designer range hood provides a custom look for a country kitchen. Removable panels of bark-like bronze, hammered copper or iron, black glass or prime-coated steel offer decorative flexibility. Available in standard lengths of 36", 42" and 48", the hood comes in wall-mount and island models. Unit is equipped with a built-in light. Trade Wind, Thermador, Los Angeles. *Circle 219 on reader service card.*

2. Compact laundry units can be easily converted from portable to permanent appliances. Units are equipped with casters and operate on standard 115V current. Dryer has a detachable window-venting system with five feet of flexible hosing. The washer features a permanent-press cycle, two speed washing and a magic-mix lint filter. Whirlpool, Benton Harbor, Mich. *Circle 220 on reader service card.*

3. Plastic laminate for counter-top use is inspired by ancient wedge-shaped Sumarian writings. "Harvest Gold Scroll", designed to blend with today's appliances, adds a tailored, dimensional effect to kitchen decor. Formica, Cincinnati. *Circle 221 on reader service card.*

4. Double decker range has an automatic self-cleaning lower oven. Removable interior panels in the eye-level oven can be placed in the lower unit during self-clean cycle. Range features a roast guide that can calculate the cooking time of any roast automatically when an indicator dial is set to the type and weight of meat and the degree of doneness desired. Front-mounted, tilted control panel is easy to reach and read. Caloric, Topton, Pa. *Circle 222 on reader service card.*

5. Deluxe range hood is a nonventing, recirculating model with an easy-to-replace charcoal filter. Engineered for use with any self-contained cooktop or range, the hood features square front design to cover more area over the cooking surface. Unit is equipped with two high-speed blowers, a removable grease filter, pushbutton controls and an enclosed incandescent light. Hotpoint, Louisville, Ky. *Circle 223 on reader service card.*

6. Home-laundry equipment is updated for convenience and style. The washer is equipped with a special "Hand-wash Agitator" that slips over the regular agitator during delicate cycles. An "Accessory drying shelf" fits onto the inside of

the dryer door and projects into the drum providing no-tumble drying. Both units feature one-piece front panels and large lettering in the control area. The background is of charcoal-brown brushed aluminum and chrome. Westinghouse, Pittsburgh, Pa. *Circle 224 on reader service card.*

7. Pecan wood cabinets are styled with grooved panels and a graceful arch design. "Shenandoah" is accented with brass-finished hardware. Wall-mounted cabinets have adjustable shelves. Base cabinets have hardwood frames and self-closing drawers. All door hinges are spring-loaded and self-closing. IXL Furniture, Elizabeth, N.C. *Circle 225 on reader service card.*

8. Plastic laminate pattern, "Sliced Avocado", is a solid bright yellow. Suitable for countertop and bar surfaces, the material has a heavily-textured grain finish. Ralph Wilson Plastics, Temple, Tex. *Circle 226 on reader service card.*

9. High-spout faucet has long slim lines and an extra-flat-to-the-sink escutcheon. A special "Swivel-spray-flo" aerator allows the water stream to reach all corners of the sink and aerates or sprays at the turn of the skirt. Unit is available in two handle-sets. Harcraft, Torrance, Calif. *Circle 227 on reader service card.*

10. Pecan-finished cabinets designed for use in any style kitchen, feature solid hardwood frames. The "Edgemont Series" is available in modular sizes 12" to 48" wide. Wall cabinets range from 12" to 30" high. Base cabinets are a uniform 34½" from the floor. Self-closing doors and one-piece molded plastic drawers are standard. Cabinets with low-maintenance interior and exterior finishes are available with many options such as two-way access and lazy-Susan corner units. Long-Bell, Portland, Ore. *Circle 228 on reader service card.*

(For more on kitchens turn to page 132.)

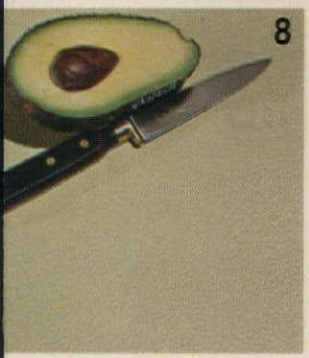

interiors

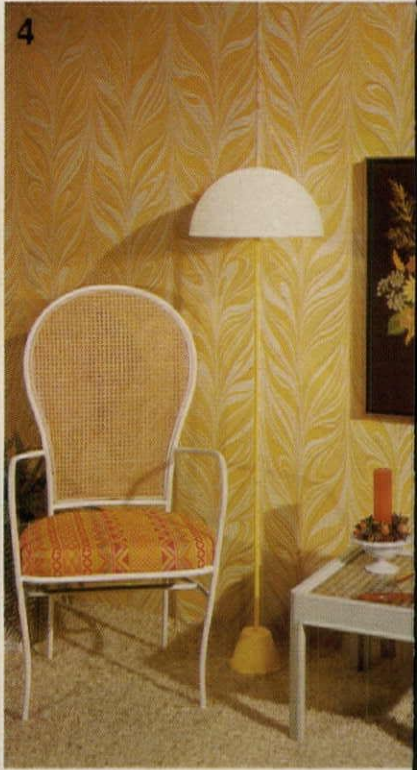



6

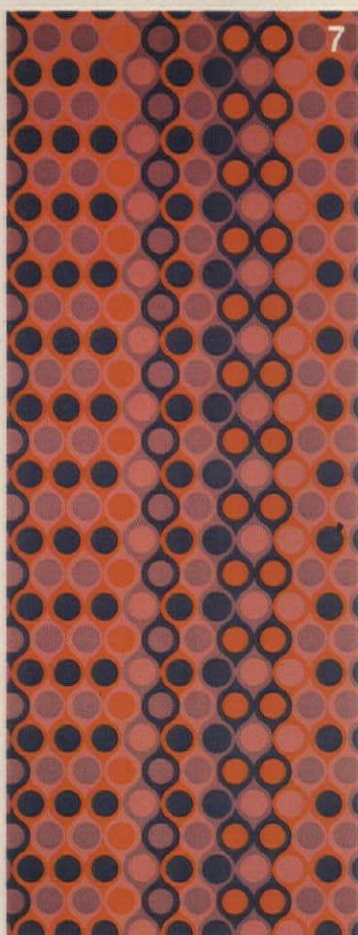

7



8



9



10

1. Decorative polyurethane beams used in a batten-like application, add a rustic look to an early American dining area. The lightweight reproductions of hand-hewn wood beams are easy to install with adhesive or grid clips. Available in dark walnut, medium mahogany or light oak finish, the beams have bold grains and knots to increase the authentic look. Urethane Fabricators, Camden, N.J. *Circle 229 on reader service card.*

2. Bold-patterned wallcoverings are scrubable, strippable and scuff-resistant vinyl. The 24"-wide, pre-trimmed material resists fading, spotting and staining. A contemporary wet-look floral print, "Arcadia", shown in a dining room, is coordinated with "Cordage", a modern stripe, used on walls and cabinets in the kitchen. Imperial Wallcoverings, Collins & Aikman, Cleveland, Ohio. *Circle 230 on reader service card.*

3. Pre-finished hardboard paneling, "Oriental Print" adds warmth to a casual living area. The "Wal-lite" pattern is reproduced from photographs of real grained-wood. Panels are protected by an extra-thick plastic coating that resists peeling, chipping, scratching, cracking, denting or discoloring. Panels can be applied to solid backings, studs or furring. Matching moldings are available. U.S. Gypsum, Chicago. *Circle 231 on reader service card.*

4. Decorative paneling, "Antiqua", is an abstract, contemporary design. The 1/8"-thick, 4'x8' hardboard panels have a plastic satin-finish that resists heat and moisture. Pattern comes in gold, coral, blue and white. Marlite, Dover, Ohio. *Circle 232 on reader service card.*

5. Classical pattern paneling, "Ancient Accent" is offered in bright, lively, contemporary colors such as the warm Corsican red shown. Paneling is vinyl, thermal-fused onto a substrate of three-ply plywood. Color-keyed for perfect match, panels are washable and stain-resistant. Hearin Products, Portland, Ore. *Circle 238 on reader service card.*

6. Glazed ceramic tiles for wall application capture the glow and spirit of the Caribbean. The line has a bright crackle glaze and is available in eight vivid colors: Aruba red, sunset orange, ebony black, Panama yellow, Jamaica green, Montego blue, surf white and

sunrise orange. The 3"x6 7/8" tiles have color-coordinated grouts. American Olean, Lansdale, Pa. *Circle 234 on reader service card.*

7. Geometric wallcovering of small circles in gradations of vivid colors can add height or width to any wall. The gravure-printed design, "Merion", is part of the "London Style 3" collection of wallcoverings. The pattern is offered in two different colorways. The paper-backed vinyl is washable, scrubable, resistant to dirt, grease and stains and will not shrink, stretch or tear. ICI America, Wilmington, Del. *Circle 235 on reader service card.*

8. Oriental-inspired pattern, "Imari", is available as a wallcovering, a fabric and a rug. The design is Adrianna Scalamanire Bitter's interpretation of two Imari presentation dishes brought from Japan. The fabric is a lightly glazed chintz. The hand-tufted, octagonal, all-wool rug can be custom ordered in any colorations. Scalamanire, Long Island City, N.Y. *Circle 236 on reader service card.*

9. Vinyl wallcovering, inspired by recent interest in China, "Dynasty Dragon" is alive with color. Designed by Brenda Falco as part of the "Collection Five" group, the bold, flowing pattern is available in five colorways including the Chinese red, steel grey and white mylar shown. Classic Wallcoverings Connoisseur, New York City. *Circle 379 on reader service card.*

10. Supergraphics in wood are achieved by using variations of panel color and installation techniques. Three shades of "Early Spring" paneling and lipstick-red paint electrify the family room shown. Horizontally installed light fawn and dark bruin are in contrast to the vertically applied otter, a medium-toned panel. All of the pre-finished plywood panels have surfaces of pecan hardwood. U.S. Plywood, Champion International, New York City. *Circle 380 on reader service card.*

(For more on interiors turn to page 196.)

flooring





1. Earth-toned shag in a contemporary patchwork pattern dominates a den/guestroom. The striking multicolor, "Scandrya", tufted of Allied Chemical nylon, is part of the "Showcase Collection". Available in three different color combinations including natural, shown, the printed, 12' wide carpet has a double jute backing. Arcadia Mills, Chamblee, Ga. *Circle 237 on reader service card.*

2. Three-color cut and loop shag in earth tones of brown, black and white is in sharp contrast to the clear, metallic look of the chrome and glass dining furniture pictured. "Good Fortune" is tufted of continuous filament nylon. The deeply embossed pile floorcovering is offered in 13 color combinations. Trend Mills, Champion International, New York City. *Circle 238 on reader service card.*

3. Mediterranean-inspired vinyl, "Bella Vista", is a classic tile-pattern reminiscent of floors in old Spanish villas. The "Shinyl Vinyl" no-wax flooring has a "White Shield" asbestos backing that permits installation on grade level. The "Cushionflor Supreme" pattern, available in 9' and 12' widths, is offered in six colors including the cardinal red shown. Congoleum, Kearny, N.J. *Circle 239 on reader service card.*

4. An abstract pattern of swirling colors highlights "Autumn Winds", a hard-twist, heat-set nylon shag. Carpet offers excellent wear, and the freeform flowing design helps to mask traffic and soil paths. Fabric is available in 12' widths and features an exclusive "Polyloc" backing. Five color combinations are offered. Ozite, Libertyville, Ill. *Circle 240 on reader service card.*

5. Short-shag, "Sun King", brightens the eat-in corner of a country kitchen. Tufted of 100% Du Pont nylon, the carpet has different size yarns intermingled throughout for a unique textured appearance. Available in 13 two- and three-color combinations, the carpet is shown in blue, star sapphire. Lees Carpet, Norristown, Pa. *Circle 241 on reader service card.*

6. Antistatic carpet is a 45/55 blend of Herculon® and nylon. "Parqweave", a tight-pile fabric shown in shades of green, enlivens a rustic kitchen. Three-ply Olefin yarn permits great tone variation and color versatility. The foam-backed textured floorcovering

is available in ten different color combinations. Executive Carpets Mills, Dalton, Ga. *Circle 242 on reader service card.*

7. Geometric print in brilliant red and white accents a contemporary game corner. "Our choice", tufted Enkaloft continuous filament nylon, has a Wilton-type, flat-weave appearance. The polychromatic dyed carpet is available in seven color combinations in 12' widths. Both jute and high density foam backings are offered. Howard Carpets, New York City. *Circle 243 on reader service card.*

8. Rough plush "Spring Garden" is offered in 19 nature-inspired colors including the greentone shown. The ¾" cut-pile carpet is tufted of 100% DuPont heat-set nylon. Magee Carpets, New York City. *Circle 244 on reader service card.*

9. Pure wool, textured-plush "Franklin Square" is a luxurious, moderately priced, pile carpet. Retailing for about \$10.95 a sq. yd., the floorcovering is available in 20 rich shades including the "Cherry Red" shown. Carpet comes in 12' and 15' widths with a double jute backing. Philadelphia Carpet, Cartersville, Ga. *Circle 245 on reader service card.*

10. Six-color shag in deep autumn shades, "Kaleidoscope", is part of the "Debut 73" collection. The textured-nylon floor covering is available in 15 colorations. Bigelow-Sanford, New York City. *Circle 246 on reader service card.*

11. Carved-pattern cut-pile carpet in an electric blue enlivens a contemporary living room. "South Hampton", designed to withstand the wear and tear of every day use, is tufted of Eastman Kodol polyester. Carpet is available in 16 colors in 12' and 15' widths. Barwick Mills, Chamblee, Ga. *Circle 381 on reader service card.*

(For more on flooring turn to page 172.)

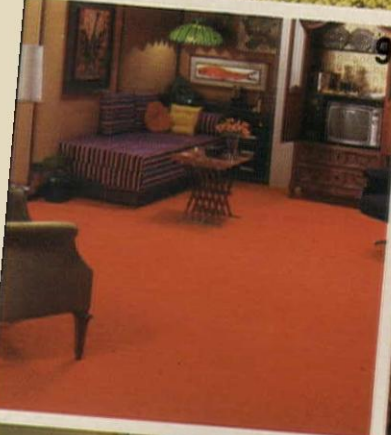

Lighting

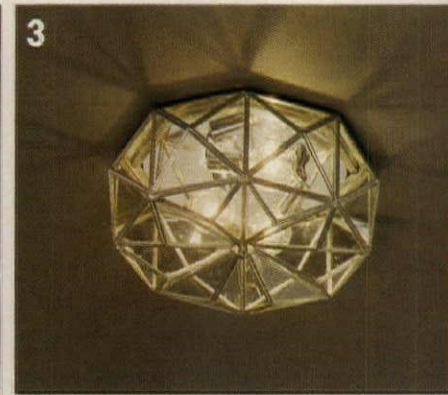
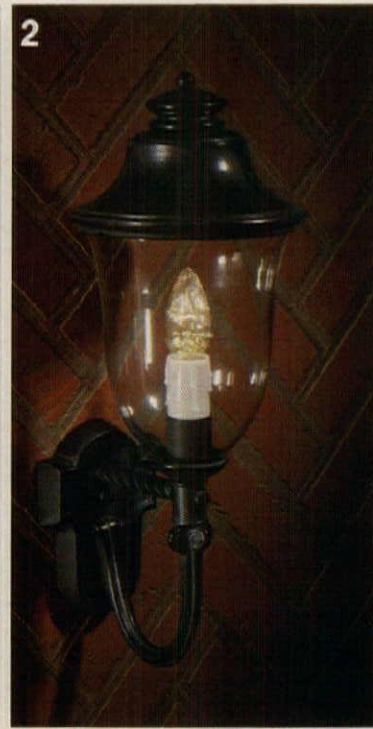
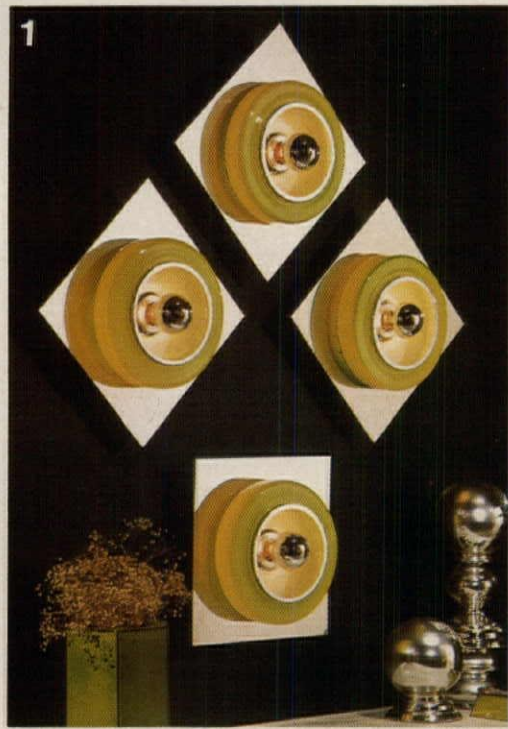



8

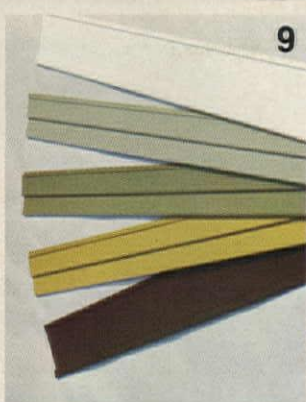

9

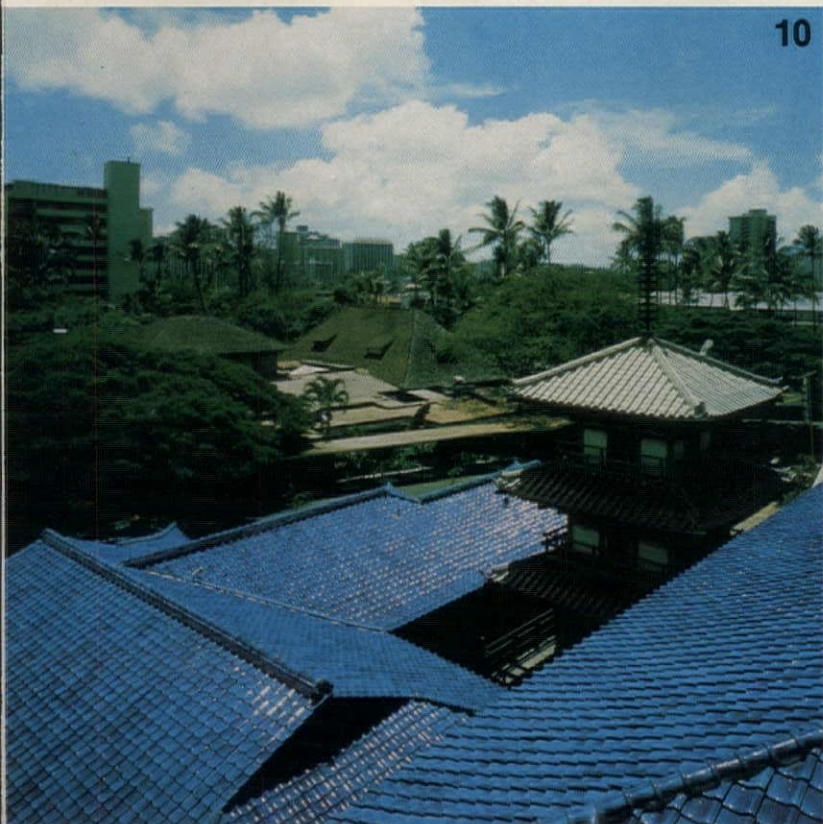

10



1. Wall or ceiling lamp with contemporary styling has a chromed-metal base and colored light diffuser. A grouping of four individual lamps is shown.

Three are angle-mounted, and one is set straight. Diffuser is available in red, green or white. Fixtures have 100 watt silver-capped bulbs. Thomas Industries, Louisville, Ky. *Circle 247 on reader service card.*

2. Traditional lantern is constructed of solid cast aluminum and glass. Part of the "Sheraton Series", the wall-mounted fixture is 22½" long, 9" wide and extends 10½" from the wall. A tough antique-like finish makes the lantern suitable for both indoor and outdoor use. American Lantern, Newport, Ark. *Circle 248 on reader service card.*

3. Ceiling light fixture creates glittering patterns as it reflects off surrounding surfaces. Light seems to jump out of the clear glass panels and crisscrossing metal work in the handcrafted fixture. Available in five sizes, the multi-faceted fixture permits continuity of lighting design throughout a space. Lightolier, Jersey City, N.J. *Circle 249 on reader service card.*

4. Mediterranean-styled lighting is available in chandelier or wall-sconce versions. A five-light chandelier is 21" in diameter and an eight-light unit measures 27". Wall-sconce can be ordered in one- or three-candle configurations. Wilshire, El Segundo, Calif. *Circle 250 on reader service card.*

5. Rustic looking chandelier combines primitive materials and modern styling. Four candelabra lights are set atop squared cones of antique brass. Cones also contain concealed downlights for extra table illumination. A three-way switch on the wood center column controls both downlights and candelights. Progress, Philadelphia, Pa. *Circle 251 on reader service card.*

6. Massive Mediterranean light, part of the "Castille Series", has a fine weathered-oak finish. Cast-metal scroll arms support amber glass cylinders that contain wax-drip candelabra lights. A downlight, concealed in the center of the fixture, is

controlled by a separate three-way switch. Nutone, Scovill, Cincinnati. *Circle 252 on reader service card.*

7. Outdoor luminaire series, "Group Sculptura", features acrylic spheres, cylinders and cubes. Fixtures come in clear bronze, opal white and clear gray finishes. Lights are available up to 100 watt mercury vapor and 150 watt incandescent.

Aluminum and wood pole assemblies are in a choice of finishes that blend with the natural surroundings. Spaulding, Cincinnati. *Circle 253 on reader service card.*

8. Pre-primed hardboard siding is available in plain or channel-grooved panels in 4" widths and 8' or 9' lengths. The factory priming eliminates the need for on-site processing and also gives protection during shipping and construction. Temple Industries, Diboll, Tex. *Circle 254 on reader service card.*

9. Wood-like aluminum siding, "Rustic-cut", looks like rough-sawn lumber. Siding will not crack, chip, peel or blister under normal wear and usage. Material is available in fresh earthy colors that blend with the landscape. A 4"-wide lap-siding for horizontal application or a board-and-batten panel style for vertical use are offered. Both types have interlocking edges and nail holes. Crown Aluminum, Pittsburgh, Pa. *Circle 255 on reader service card.*

10. Glazed roofing tiles imported from Japan are available in a traditional oriental style or a tapered-S tile. Five colors offered are blue, brown, dark green, orange and olive green. San Valle Tile Kilns, Los Angeles. *Circle 256 on reader service card.*

11. Structural siding panels have a uniform prime-coat of white latex paint. Ideal for tudor or board-and-batten style exteriors, the extra rigid, weatherproof insulation board panels are available in 4' x 8', 10' or 12'. Panels are ½" thick. Homasote, West Trenton, N.J. *Circle 257 on reader service card.*

(For more on exteriors turn to page 192.)

exteriors

fireplaces

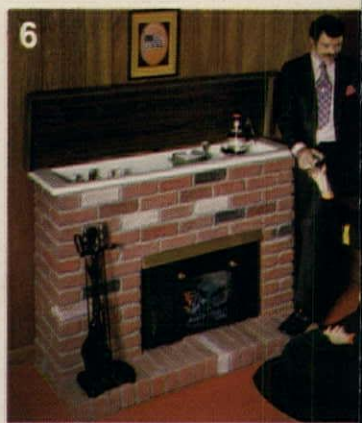



8

1. **Freestanding wood-burning unit**, "Imperial Carousel", has a spinning column of flame. Air-flow rate and direction are controlled by an adjustable door in the glass-enclosed base and baffles in the hood. Fireplace is available with hoods finished in ten different porcelain colors or matte black. Malm Fireplaces, Santa Rosa, Calif. *Circle 258 on reader service card.*

2. **Gas-log fireplace** functions as a heater as well as a decorative element. The wall-mounted unit has a 35,000 BTUH heating capacity. Hood is offered in jet black, burnt orange and white. Temco, Nashville, Tenn. *Circle 259 on reader service card.*

3. **"Chalet"**, a fireplace with a suspended conical hood, comes in 41" to 72" diameters. Heavy-gauge steel unit includes a fire-screen. Ember Box, Oklahoma City, Okla. *Circle 260 on reader service card.*

4. **Modular facing system** also includes hearth units measured to fit most prefabricated fireboxes. A hardwood mantel is optional. Unit is offered in antique brick, cast quarry stone and hand-hewn brick. Ready-Built, Baltimore, Md. *Circle 261 on reader service card.*

5. **Built-in gas fireplace** is designed so that framing can be completed prior to unit installation. Firebox recesses into a wall cavity 30 1/4" wide with a minimum depth of 13". Self-trimming fireplace surround can be covered with any non-combustible material. Heatilator, Mt. Pleasant, Iowa. *Circle 262 on reader service card.*

6. **Electric fireplaces** of lightweight fiber glass simulate colonial brick or gray fieldstone. The model shown has a lift-up mantel that converts the fireplace into a home bar. An ice-bucket, deep bottle storage, two sliding Formica shelves and a work surface are featured. Cavrok, Vernon, Conn. *Circle 263 on reader service card.*

7. **Wallmounted electric unit** has a decorative hood available in charcoal, avocado or off-white. An electric heater is concealed above the log-set and operates independently of it. Superior,

Fullerton, Calif. *Circle 264 on reader service card.*

8. **Modular seating group**, "Tufto", consists of four units, a square seat, an armless back-center, a high arm and a low arm. Components can be arranged in countless ways to suit space and taste. Seat, with a urethane foam filling, has a steel frame encased in Dacron. Ebonized wood bases are made in lengths to accommodate one, two, three or four units. A choice of fabric, vinyl or leather upholstery is available. Harvey Probbler, Fall River, Mass. *Circle 265 on reader service card.*

9. **Circular table** with a smoked glass top is 43 1/2" in diameter. Part of the "Elan-Group Eleven", the table has a base that consists of sculptured polished aluminum legs and brushed aluminum rails. Table has walnut or oak top. Jens Risom, New York City. *Circle 266 on reader service card.*

10. **"Joe" seat**, fashioned after the famous baseball glove, is a two-seater sofa designed by the Italian team of DeBas, D'urbino and Lomazzi. The foam-filled piece is upholstered in tan glove-leather or blue-jean denim. Stendig, New York City. *Circle 267 on reader service card.*

11. **Striking contemporary chair** of molded fiber glass is designed by Eero Aarnio. Part of the "American Contemporary Collection", the "Bird Chair", available in eight bright colors, is 46" wide, 42" deep and 33" tall. Thonet, New York City. *Circle 268 on reader service card.*

12. **Lounge seating group**, "Bonanza", is designed by Afra and Tobia Scarpa for C & B Italia. Units have internal steel reinforcement, a high-density black polyurethane outer skin and polyurethane foam cushioning. Shell is covered in Dacron fiber-fill draped with upholstered material which is inserted into a plastic edge detail and tied into place. Furniture is available in one-, two- and three-seat units upholstered in a wide range of fabrics, vinyls or leathers. Atelier International, New York City. *Circle 269 on reader service card.*

(For more on fireplaces turn to page 200; for furniture, page 130.)

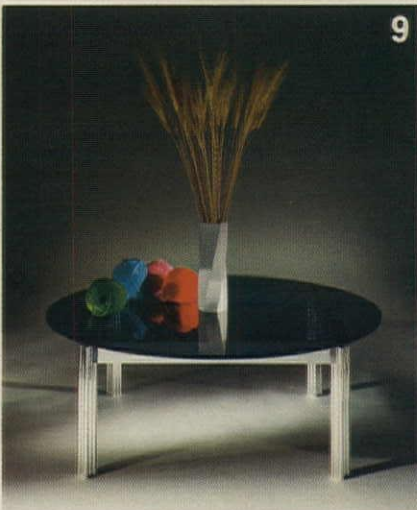

9



10



11



furniture

Structural

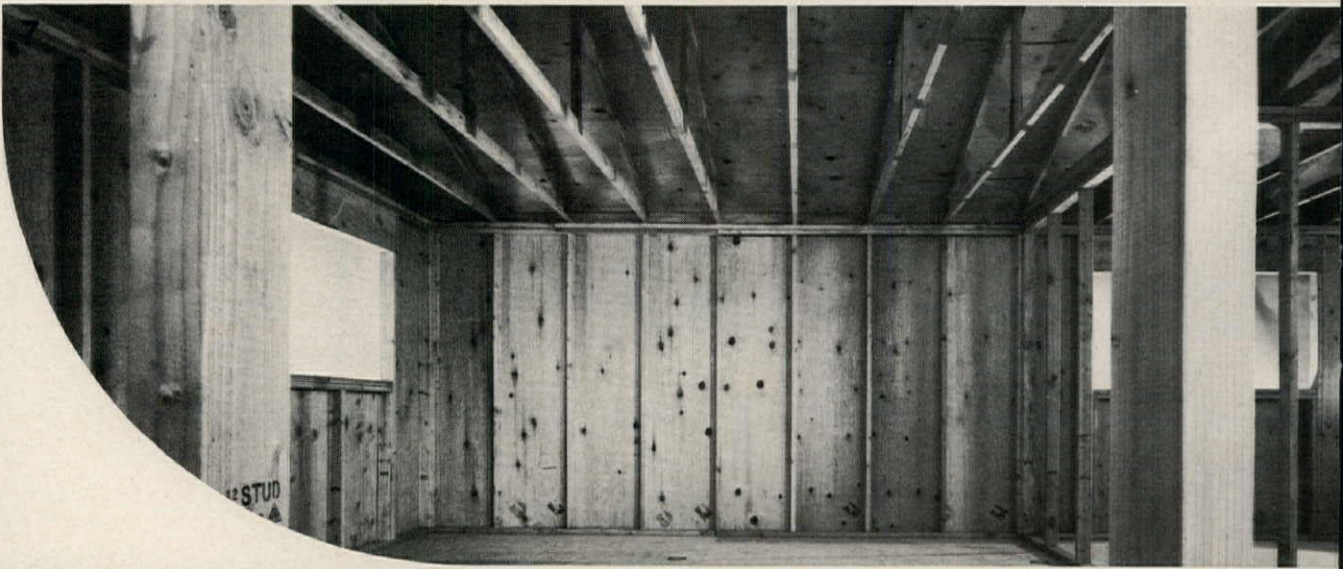
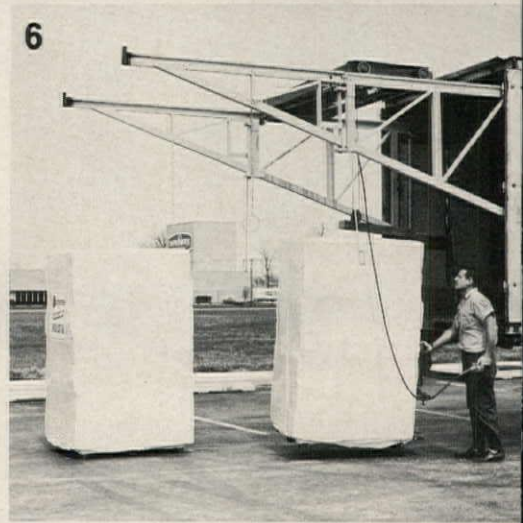
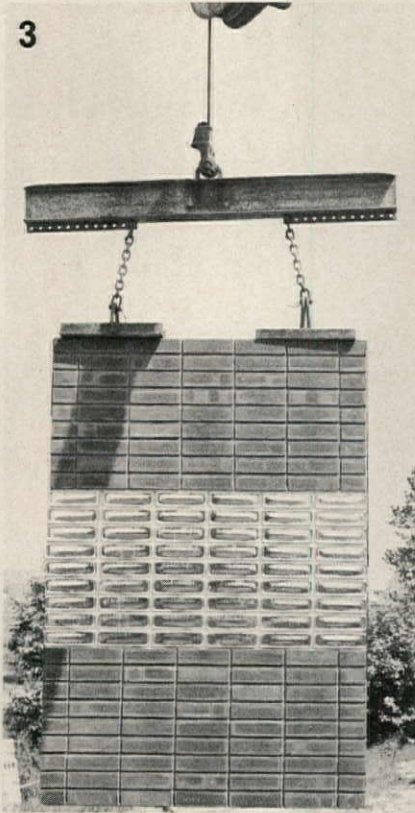
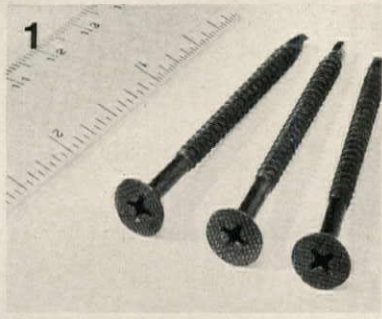

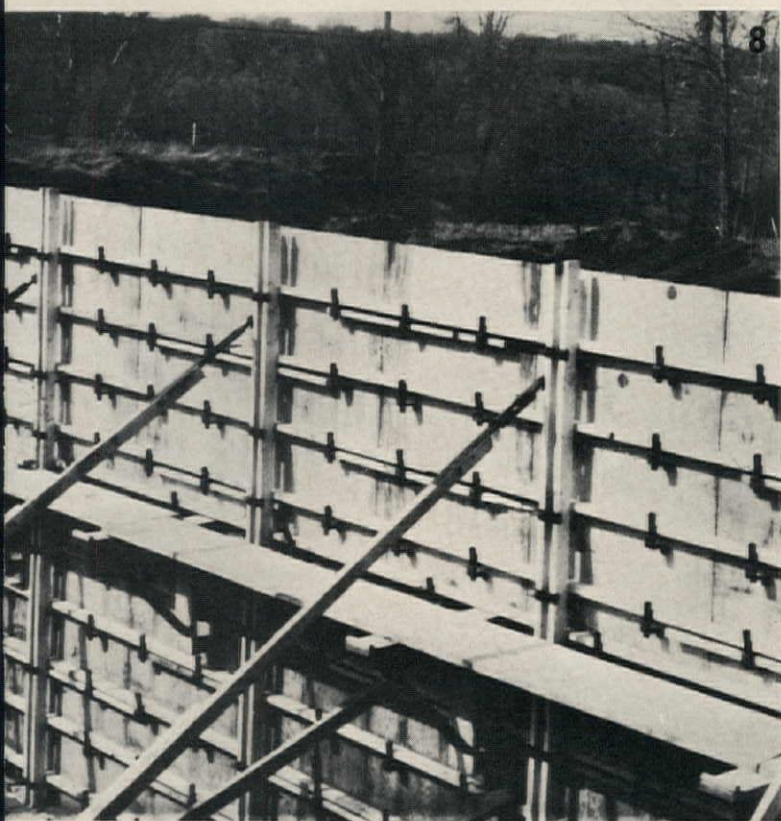

1. Self-drilling wallboard fasteners feature a patented drill twist point which allows them to easily penetrate 16-gauge metal studding. Available in 2 1/4" to 3" lengths "Panel-Kwick II" screws are specifically designed for installing the many layers of drywall in fire-retardant wall systems. Deep cross-hatched head surfaces are designed to hold all types of spackling. USM, Shelton, Conn. *Circle 270 on reader service card.*

2. Steel floor joist system for one- and two-story buildings is designed for easy handling and quick installation. Floor-joist sections are nominal 2"x7 1/4" and may be ordered to precise thickness and length. The Joistee® system of one-piece construction minimizes waste. Prepunched joists are 14-, 16- or 18-gauge special steel coated on both sides for corrosion resistance. Necessary accessories are included with the package. Teledyne Metal Forming, Elkhart, Ind. *Circle 271 on reader service card.*

3. Glass blocks and brick are combined in an architectural panel using mortar as the only bonding agent. Solid glass blocks are shown in an assembled panel available from Royer Masonry Systems. "Vistabrik" glass blocks come in 5"x5", 8"x4" and 8"x8". Pittsburgh Corning, Pittsburgh, Pa. *Circle 272 on reader service card.*

4. Spiral stairs are hand-crafted of clear red oak or other hardwoods. Delivered ready-for-installation, the stairs can be ordered in any specified height in 4', 4 1/2' and 5' diameters. Stair-Pak Products, Union, N.J. *Circle 273 on reader service card.*

5. White roofing sheet is a high-performance, semi-elastomeric plastic, laminated to neoprene-bound asbestos felt. The cut-to-size, single-ply "Sim-Ply" roofing system chemically forms a watertight membrane. Celotex, Tampa, Fla. *Circle 274 on reader service card.*

6. Palletized packaging system for wood-fiber insulation permits on-site delivery regardless of weather and allows outdoor storage for six to eight months. The "600" pallets are unloaded automatically by the truck driver without assistance. Pallets are hermetically sealed to prevent excessive humidity or moisture absorption during storage. Thermtron Products, Fort Wayne, Ind. *Circle 275 on reader service card.*

7. Wood framing system uses plywood over lumber framing spaced on a 24" module. The system can be used for floors, walls and roofs in either single- or double-wall construction wherever codes accept 24" o.c. framing. Western Wood Products Assn., Portland, Ore. *Circle 276 on reader service card.*

8. Hardware system for building plywood concrete forms consists of three basic parts. Heart of the system is "Speed Bracket," a combination tie holder, waler bracket and break-back tool which allows the use of 2"x4", 3"x4" or 4"x4" walers with 3/4" or 5/8" plywood facing. A "Stiff-Back Bracket" permits setting of twin vertical walers and provides a method for attaching braces and scaffolding brackets. "Twist-Cone Tie" consists of plastic cones that are automatically removed or loosened when tie is broken back. Symons, Des Plaines, Ill. *Circle 277 on reader service card.*

9. Glass-fiber bonding material that eliminates the need for mortar in concrete-block construction. "BlocBond," available in 80-lb. bags, is a mixture of Portland cement, hydrated lime, a water-resistant agent and alkali-resistant glass fibers. Final two steps of a four-step application process are shown: (left) Block is dry-stacked; (right) A 1/8" coat of material is trowelled on interior and exterior wall surfaces. Owens/Corning, Toledo, Ohio. *Circle 278 on reader service card.*

10. Roof deck systems, familiar in non-residential construction, now can be used for wood-framed garden apartments. "Pyrofill" or "Thermofill" gypsum concrete slabs satisfy fire codes without above-deck firewall extensions and also allow drainage slopes to be formed. U.S. Gypsum, Chicago. *Circle 279 on reader service card.*

outdoor

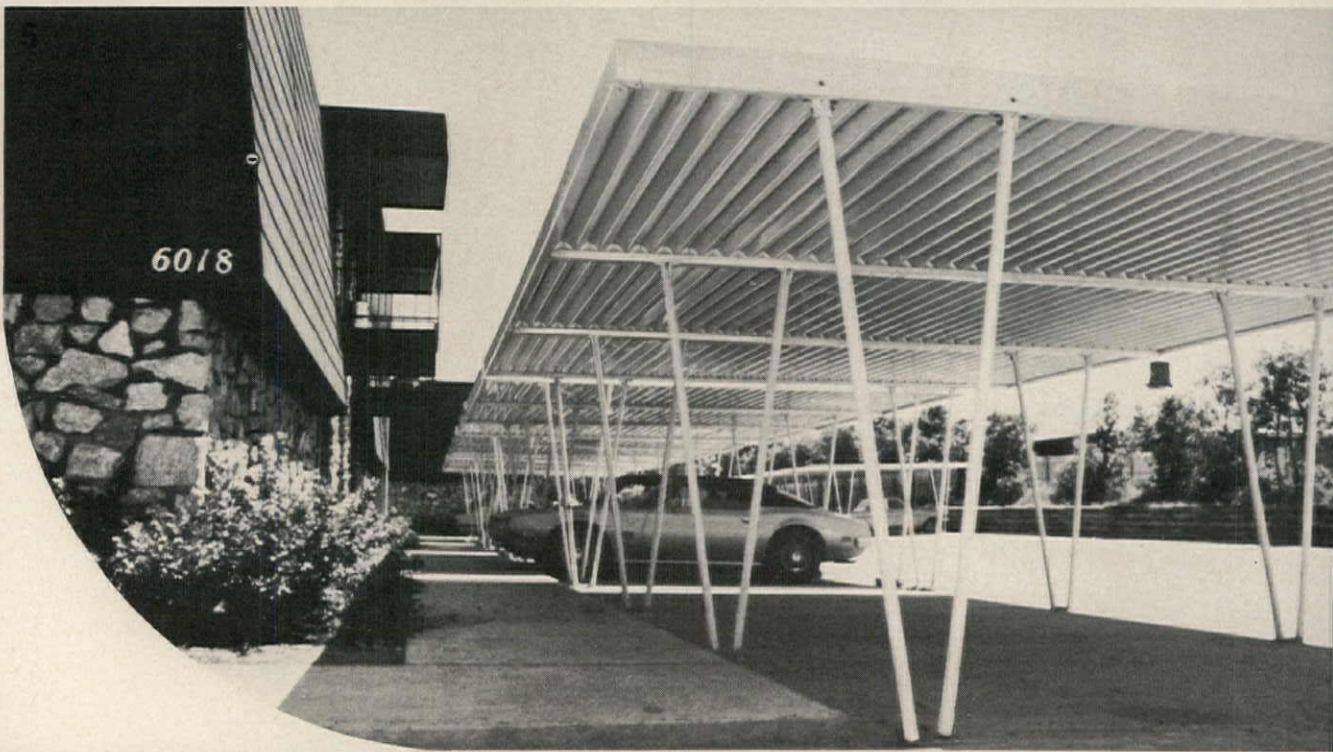
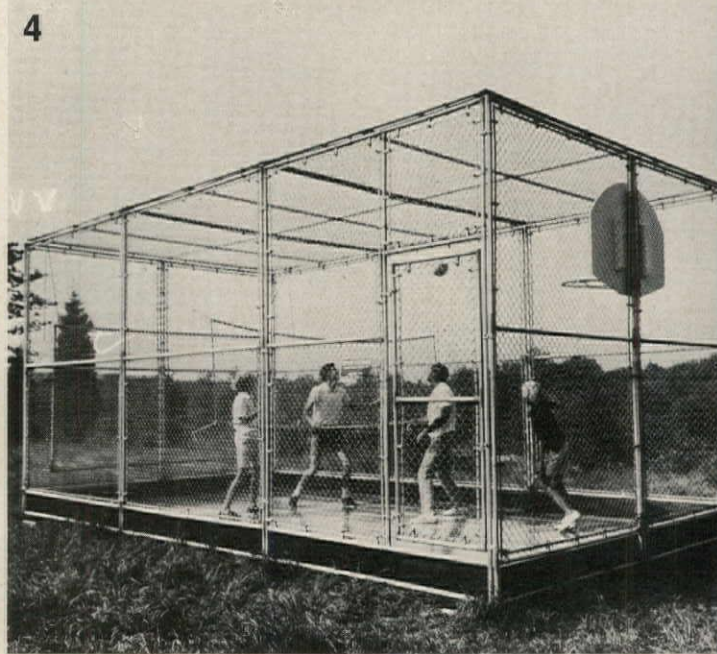



6

1. Casual furniture for outdoor living is comfortable and easy to maintain. "Aimes-Aire" series is constructed of resilient vinyl cord wrapped around enamel-finished tubular steel frames. Series, including seating pieces and glass-topped tables, is available in black frames with white cord, avocado frames and cords or white frames with yellow cords. Leisure Furniture Group, Cincinnati. *Circle 280 on reader service card.*

2. Synthetic turf, "Lawnscape", provides greenery where real grass can't or won't grow. The maintenance-free material, made of Chevron's second generation polypropylene fiber, "Polyloom II", can be used for decorative or hard-wear areas. "Lawnscape" is guaranteed for five years against fading or ultraviolet fiber degradation. Ozite, Libertyville, Ill. *Circle 281 on reader service card.*

3. Lighting standards for outdoor use provide attractive, efficient illumination for new home developments, multifamily complexes and recreation areas. Pressure-treated or curved-wood standards are available in heights from 12' to 40'. Graceful, uncomplicated forms, engineered for use with underground wiring, blend naturally into landscaped settings. Weyerhaeuser, Tacoma, Wash. *Circle 282 on reader service card.*

4. Compact enclosed sports court and specially designed equipment permit a wide variety of vigorous athletic activity in a minimum of space. Nine active games have been devised for the 12'x24'x10½" court. The weatherproof steel tube and link fence enclosure has an adjustable nylon rebound net. Sportatron, Old Lyme, Conn. *Circle 283 on reader service card.*

5. Multiple parking shelters, manufactured of aluminum, provide protection against the elements. The system consists of deep-section aluminum paneling combined with aluminum support beams that serve as fascias and concealed gutters. Panels interlock forming a water-tight roof. Shelters need little maintenance. Roof is supported by aluminum V-posts. Alcan, Warren, Ohio. *Circle 284 on reader service card.*

6. Modularized security system is designed to provide a variety of protective services to apartment dwellers. Individual modules provide fire and burglar alarms and intercom/door opening capabilities. The system can be installed in existing structures or new construction. Alarms are signaled to a main receiving console in an attended area of the building. Closed circuit TV hook-up is also possible. ADT, New York City. *Circle 285 on reader service card.*

7. Automatic garage door opener is easy to assemble and install. The "350-P" has an enclosed lighting fixture that turns on when door opens and operational safety features. Unit can handle all size residential doors. Frantz, Sterling, Ill. *Circle 286 on reader service card.*

8. Pushbutton switches with architectural styling have companion ground receptacles. The "Centura" line is available in nine colors: ivory, white, gray, beige, black, pink, yellow and brown. Different colors can be combined on one unit for interesting effects. Regular and illuminated switches include single-pole and three-way units rated at both 15 and 20 amps. Leviton, Brooklyn, N.Y. *Circle 287 on reader service card.*

9. Electronic garage door opener consists of a portable signal transmitter, a solid state UHF receiver and a motorized operating unit. The "Liftmaster Deluxe" features a built-in light that turns on as the door opens, and shuts off 1½ minutes later. Chamberlain, Elmhurst, Ill. *Circle 288 on reader service card.*

10. Electric raceway with a vinyl surface includes cover and base strips, end caps and corner pieces. The easy-to-install system can be fastened to walls mechanically or with adhesive. Raceway will not support combustion, is impervious to mars and dents and can be painted to complement room decor. Johnsonite, Middlefield, Ohio. *Circle 289 on reader service card.*

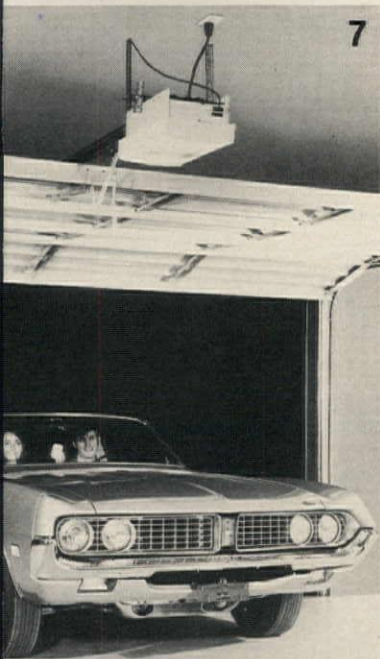

7

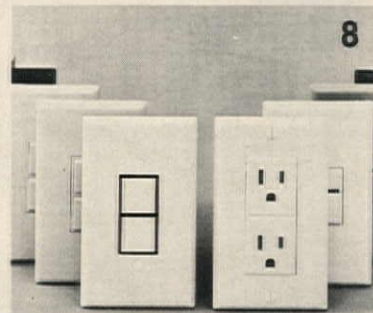

8

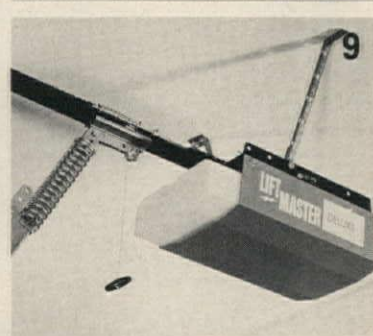

9

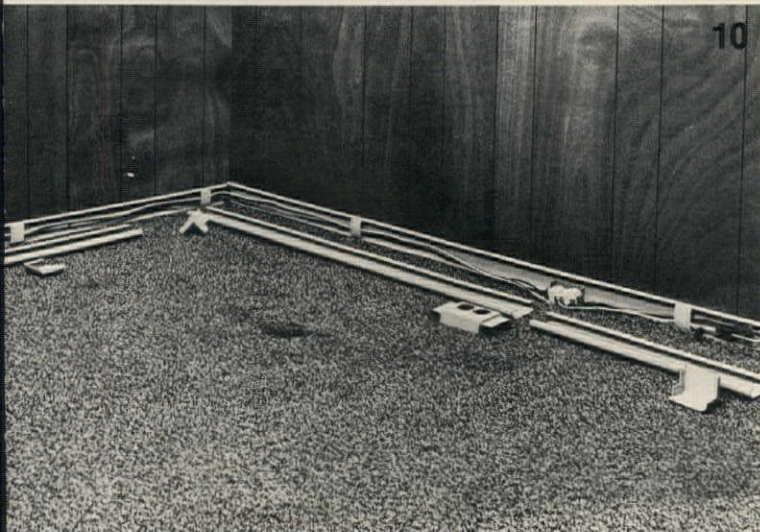

10

electric

the gentle art of

HEAD HUNTING

how to
hire and
keep
the key
executive

"HELP WANTED: Marketing managers, controllers, purchasing managers (heavy negotiating experience), regional/divisional managers, operating executives. Above all, operating executives, from project manager up."

The ad is hypothetical, but it could have been written by almost anyone in the housing industry, judging by the response of builders and executive search consultants contacted by HOUSE & HOME for this article. Certainly most of them find qualified top management people hard to find and seldom easy to keep, despite a wide range of salary and fringe incentives.

Indeed, the most striking fact that emerges is that dissatisfaction with material compensations is rarely the problem with unhappy executives in a generally prosperous industry. The major problems are: 1) failure to keep executives informed on where the company is going and where they can go within it; and 2) failure to give them really free rein in the areas in which nominally they have full authority and responsibility.

In the words of Malcolm Prine, president of Ryan Homes, Inc., of Pittsburgh, Pa., "The employment crisis in this country is a national one, and it won't improve in my lifetime. The major reason is that the home-building business has just come into respectability as a sophisticated business, and there's a short supply of the mid- and lower-management personnel who will be tomorrow's top management.

"And the situation is worsening because of today's expanding geographical penetration and hiring. Everybody's trying to go national, and they're drying up the supply."

How does a builder or developer tap what's left of this supply?

The new trend:

Hire from outside the industry

The growing tendency towards giant, multi-market building companies is creating new demand for staff specialists in areas such as marketing and purchasing that were not so

ING

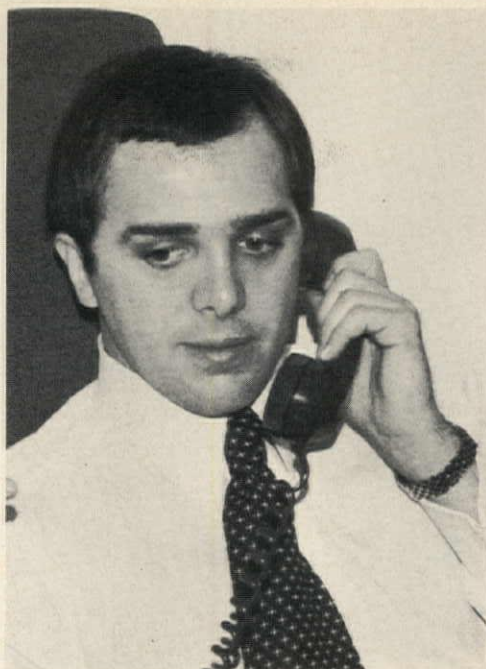

Gerard Sans



George Deffet

important in the typical smaller homebuilding firms of a few years ago. Because there is a quantum leap from the concept of selling a house to that of marketing a product, many builders are reaching outside the industry to fill key marketing positions.

There are three reasons behind this:

One is that today's concepts of marketing and managing are still so new to housing that talent within the industry is relatively scarce.

Second, other industries have a long head start on these kinds of expertise, so there is a considerable pool of experience waiting to be piped into housing.

Finally, the housing industry is only beginning to attract the bright young MBAs who have the book-learning but will need some years to mature on the job.

Jack DeBoer, president of Jack P. DeBoer Associates, Wichita, Kans., for example, hires almost exclusively from outside the industry. His vice president of operations—the number-two spot—is a CPA who has also worked in advertising and insurance.

Two other developers who frequently go outside the industry are George Deffet, president of Deffet Companies, Columbus, Ohio, and Lloyd E. Clarke, president of Alodex Corp., Memphis, Tenn. Deffet's top man for operations and construction management came from the truck-body business. Clarke's chief financial officer, a former controller for a heavy machinery corporation, was experienced in innovative financing and systems management.

Yet another builder got a financial vice president from the aerospace industry, a segment which, in its present depressed state, is ripe for harvesting. And there is even a case of a former department store executive who "brought a raft of ideas" into the business, one builder says.

Winning him over— and keeping him

Chances are the man you want for your company is reasonably happy—or at least so

he thinks—where he is. At least as far as the material aspects are concerned, he's almost sure to be adequately compensated. You will have ascertained his competence by the usual screening process. Now, how to persuade him he'll be even happier with you, and that he'll stay happier? There are several methods, but most have some potential pitfalls.

There are builders who swear by stock options, project participations and other more financially esoteric incentive plans that won't show up on the executive's tax return. For those companies which are not publicly held, project participation often works well. Here's the system used by one Rocky Mountain area builder:

Key employees are given a percentage of the income from a project, the percentage varying with each employee's level. In effect, the individual becomes a joint investor by buying in any time at the book value of his share. Since the aim of the plan is to keep the employee, participation is predicated on his staying for a stated time period, usually from three to eight years. If he leaves before this time he must sell his share back at book value.

A key advantage of this kind of scheme is that it affords the employee's personal taxes the same kind of tax shelters—e.g., double-declining depreciation—as it does the corporate entity. And the income possibilities of even one-half of one percent of a multi-million-dollar shopping center are not to be sneezed at.

But this system also has its critics who point out that the man with a piece of a particular project just has to spend extra time looking after it at the expense of his other responsibilities. Further, some projects are going to be big winners and some are going to bomb out, perhaps through no fault of the project manager. And finally, DeBoer points out the escalation factor: The man who skims off say, \$25,000 in one year is bound to look at it as a sort of base, and it's easy to get spoiled.

Stock options: Yes, but . . .

As long as the stock is going up in value, options are a fine idea and are growing more popular. Some companies—Ryan Homes is one—report that even a recent substantial downturn in stock value has been no problem, since most executives purchased their stock well below its recent low point. And even those who didn't nevertheless see the setback as only a temporary snag in a long-term growth pattern.

Playing devil's advocate, recruiter Gerard Sans, owner of Barton-Sans, a New York City executive search firm, sees executives whose stock has suffered as ripe for plucking by another company. And he's plucked some of them.

"A lot of pipe dreams and hard work sometimes go up in smoke, and the man who has depended on financing his children's education from his stock holdings is going to be very bitter if it doesn't work out that way."

Still another problem with stock options, he says, can occur with diversified companies. If one division is turning in a nice profit and the others are not, it's obvious that the manager of the profitable division is going to get the short end. The same principle applies when one man in even a straight building company is making a profit for his boss, and the others are not. "When that happens, you're guaranteed a hitch in your operations," he says.

Tie it to the man, not the company

Sans feels the only bonus plan that has no disadvantages at all is one which is tied to the man's performance and is independent of how the company is doing. That means an adequate base salary plus a fixed percentage of costs saved by his own efforts. Since the line side of management tends to attract the entrepreneurial type of executive, Sans sees this as the most direct and fitting reward. And even though it's ordinary taxable income, Sans' experience is that it is more welcome than any participation or



Richard M. Ferry



Lloyd E. Clarke



Malcolm Prine

stock option scheme.

One builder, Lloyd Clarke, offers an incentive plan which brings the wife into the action. A site supervisor, for instance, who completes the job on time gets free air-travel for himself and spouse to any point in the U.S. at vacation time. Or an on-schedule completion may mean a new outfit for the wife.

"You'd be surprised at how interested the wife becomes in how the job is progressing," he says.

One emphatic nay-sayer to the whole mish-mash of incentive plans is DeBoer, who has a top reputation for good construction management. He believes these incentives do more harm than good, hence he offers no incentive plans and no commissions at present. In effect, what he's telling his executives is, "Keep up with the rest of us, and when we reach our eventual goal, everyone will share." What his plans for sharing are, he won't reveal.

What about the idea that, since the construction supervisor is the man on the spot if the project bombs, he should be given an extra reward for the extra risk?

"There are many problems that are beyond a superintendent's control," he says. "We take him off the spot with a system of corporate controls that distribute the risk and minimize the chances of failure. In short, we take a corporate, rather than entrepreneurial, approach to the business.

"If a superintendent brings in a job ahead of time, we rarely give him a direct share of the savings as such, but he can be sure that his ability will be rewarded by salary increases and job advancement."

Most important: how you treat them

In most cases of executive dissatisfaction, the compensation and perquisites are not the problems at all. The real problem is that many builders, without realizing it, are simply unable or unwilling to let a key executive do his job. Consider the case history of one

recently—and happily—relocated project manager:

"It wasn't the money at all that made me leave ——— Company. The salary was excellent, I had the use of a company station wagon, and as a condition of my employment the company even paid off several loans I had outstanding.

"But the picture the company had painted for me was a far cry from the job I found when I started to work. Would you believe I spent seven months in a beautiful office—reading *Playboy*?

"What happened was that while the company called me a project manager, they actually used me as a high-priced messenger-boy to carry out the orders of the operations manager.

"The builder was located out of the state, had recently picked up a lot of work in [a major metropolitan area] and was hiring high-priced talent on a strictly one-shot basis.

"My supervisor came in three or four times a week but knew nothing about conditions in this area, such as how to work with and around the union and code restrictions.

"When I complained to my superiors that I couldn't live like this, their reaction was, 'What are you worried about, you get your check every two weeks!' Is it any wonder I quit?

"Now I'm with ——— Company as manager of a \$140 million job, and I feel like a kid with a brand new toy. I swear I'm getting younger every day, even though I'm breaking my neck for the company.

"They've given me complete responsibility—and complete authority. If I get a job in one or two days early the money saved is shared with me. And that makes me want to go out and give 115%."

Companies such as that project manager's former employer are ripe for executive recruiters, Sans points out.

Here's another case from Sans' files that illustrates what can happen when *necessary* controls are not enforced by top manage-

ment.

A construction superintendent had apparently been told by the project manager, his immediate superior, that when he, the project manager, moved up the line, the construction superintendent would get his job.

The alleged conversation—it was the superintendent who said it had taken place—took place between the two men privately. Moreover the project manager had not consulted higher management and, in fact, had no authority to make the promise. Not long thereafter the project manager died, and Sans was called in to find a replacement.

Enter the construction superintendent and his claim for the vacant position. Sans felt that the man was a top-grade superintendent—virtually irreplaceable—but without qualifications for the higher post. It turned out that in order to keep this bitterly disappointed superintendent with the company, the search for a new project manager was immediately narrowed down to a handful of men the superintendent respected enough to be able to work with. The price of the man eventually hired was high—and had to be met largely with a variety of tax-shelter fringes so as not to upset the company's salary levels. In short, a great deal of trouble could have been prevented had the project manager not overstepped his authority in the first place.

Moral: "A man can live with lies, he can live with inadequate compensation, but he cannot live with the loss of his ego," Sans says. "And that super had his ego pulled out from under him when a promise that never should have been made to him in the first place was not kept."

Get 'em young; move 'em up

Obviously, it's better for any number of reasons to promote from within rather than from outside. For one thing you know the individual and his working habits and where his strengths and weaknesses lie. And his loyalty to the company will almost always increase in direct proportion to his length of



Jack P. DeBoer

service.

The problem then becomes how to keep the promotion ladder open, and how to make sure the executive knows it's open.

This can be accomplished either formally or informally, or both. DeBoer, for example, has an extensive training program that includes classroom space, audio-visual equipment and a staff of instructors with education degrees. Alodex Corp. has a personnel executive whose primary duty is upgrading personnel.

Deffet is an advocate of the less structured approach. For example, he schedules frequent two-day sessions in which he and his top men get together at a motel for sessions that are a relaxed blend of sociability and business conferences. In this way a round of golf, a cocktail hour or a poker game are at the same time pleasant ends in themselves and idea and problem-solving sessions.

"You don't necessarily have to be friends, just friendly, to make these get-togethers both fun and helpful," Deffet says.

Transition: from supers to scholars

What could be a growing trend in the development of project managers in the future is the system used by Lloyd Clarke of Alodex Corp. He's going after graduates of such colleges as Florida State, Memphis State and Rice who have degrees in civil or architectural engineering, construction technology, or who have combined technical and management degrees.

Once hired, these men are named assistants to present site superintendents who have come up through the trades. Clarke says the system helps the supervisors even as it gives the young graduates the practical training they need.

—J. MICHAEL STIMSON

Headhunters: Should you use them?

Or are they con artists who will do anything for a fee—such as send you droves of interviewees who are patently unqualified for the job? What are their fees, and are they worth it? Will they find you a man, then promptly, because they now know a lot about your business, steal away another man?

We can't answer all of these questions because we didn't attempt an in-depth look at headhunters. But those we talked to claimed rigid ethical standards, and our talks with builders who have used them—some for several years—backed them up.

What will they cost you?

Figure 20% to 30% of your executive's yearly salary plus expenses—an item that could cost as much as \$20,000, but will probably average something less.

Although Gerard Sans, owner of Barton-Sans executive recruiting agency in New York City, tailors each contract individually, a typical fee is 1% of each \$1,000 of the employee's yearly gross up to a maximum of 25% for a salary of \$25,000 or above. But since the man you'll be seeking will almost surely command more than \$25,000, you can figure at the straight 25% of gross. Sans asks a retainer of \$1,000 a month for the first three months to be used for expenses and credited in the final charge. The fee covers all expenses except travel.

If the executive he finds brings his management team with him, Sans charges a flat 15% of the yearly gross of each team member, up to five members.

Korn-Ferry & Associates, which has offices in Los Angeles, Chicago, New York, Atlanta, Houston, San Francisco and overseas, considers itself primarily a management consultant; as such its fees are structured on a time-and-cost basis. At the outset the company gives an estimate of the time and cost that will be involved; usually it is 20% to 25% of the gross salary. Internally the company regards this as its budget and is reluctant to ask for more if the search proves more time-consuming than anticipated. In this situation the client is alerted and either the fee is renegotiated or the search ended.

What do you get for the money?

From some, Jerry Sans, for example, probably more than you bargained for. He's choosy, and before he takes on a client he subjects him and his company to the same scrutiny as the prospective employee gets.

On the other side, he does guarantee the man's employment for a year and will charge nothing if the man does not work out. Unlike some other companies, he screens out all but the one best man he can find.

What should you look for in a recruiter?

If you're thinking of engaging an outside recruiter, a good move is to check with other

building firms. Although not every recruiter specializes in the housing industry, the better ones have at least one man who knows the industry thoroughly.

Here are some points to check:

Can he keep his mouth shut? Since a top-flight recruiter inevitably is going to learn a good deal about your operation—Sans frequently finds himself sitting in on policy meetings—you want somebody who can keep secrets like a priest.

How does he operate? Where does he look for potential employees? The failures and the chronically disgruntled are easy to find; it takes hard work to locate a man who is successful and happy in his present employment. Yet this is the man you want.

How thoroughly does he check candidates for your position? The good recruiter can find out a lot about a candidate without tipping off the man's present employer. Since a good recruiter will screen many people for one job, it's very important that he not rock the boat for every employee he contacts. And if it becomes known you're pirating, it won't help your relations with your colleagues.

One attribute of a good recruiter that's a little hard to pin down is the kind of attitude he takes toward his client. Sans considers himself part of the company he's working for, to the degree that he sometimes offers a salary a few thousand dollars over the original specification if he sees that he can get an unusually good man.

How many other clients does he have? Somewhat paradoxically, a top man will have few active clients in proportion to his staff—typically a dozen or less. Since every \$40,000-and-up executive he places means a five-figure fee to him, he can make a very comfortable living on relatively few placements.

How well does he know the industry? Some of your questions might include a bit of industry jargon; if he really knows the industry he'll understand the buzz-words. If he obviously doesn't, he may not be the man you want.

Pirating: Will it happen to you?

One thing an ethical recruiter will not do is try to pirate from his own clients—for obvious reasons.

This leads to the question, how long after you've used him does he still consider you a client?

It depends, but both Richard M. Ferry, executive vice president of Korn-Ferry and Sans would say a minimum of a year and a half to two years, and longer if the recruiter has done a lot of business with you. After that, "Let's just say we wouldn't be reckless," Ferry says. "We'd let you know first that we were planning a raid on your company, but of course we wouldn't tell you who it was." Sans says he would never pirate a former client unless the relationship was broken for cause. ■

Subsidy housing; How good design can pay off

It pays off in two ways:

First, it generates a feeling of pride and identity in the project's residents, and that translates directly into lower maintenance costs.

Says architect Stephen G. Oppenheim, who designed the project shown at right: "Good design gives tenants a positive feeling—an attitude of 'I live in as good a place as anyone else'—and they're much less liable to resent the fact that they live in a subsidized project. Take away resentment and you also take away much of the urge to vandalize and destroy."

Second, it pays off in community relations. The resistance which too often arises at the first inkling of a subsidized project can be mitigated and sometimes eliminated if a developer can point to previous projects of high design standards.

The five subsidy projects on the pages that follow differ widely in size and type, but they share an excellence of design and planning that most conventional projects could well emulate.

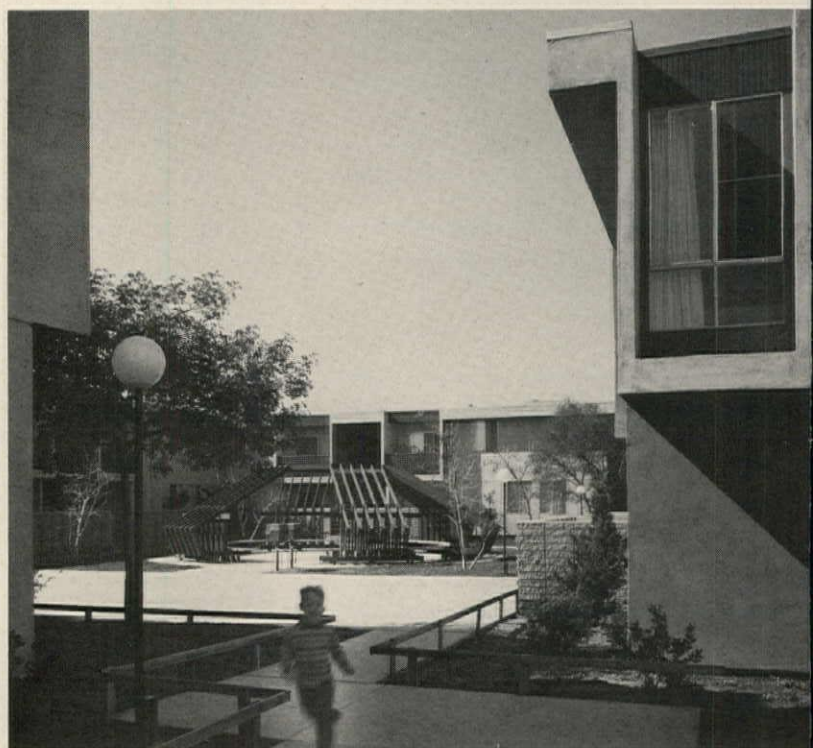
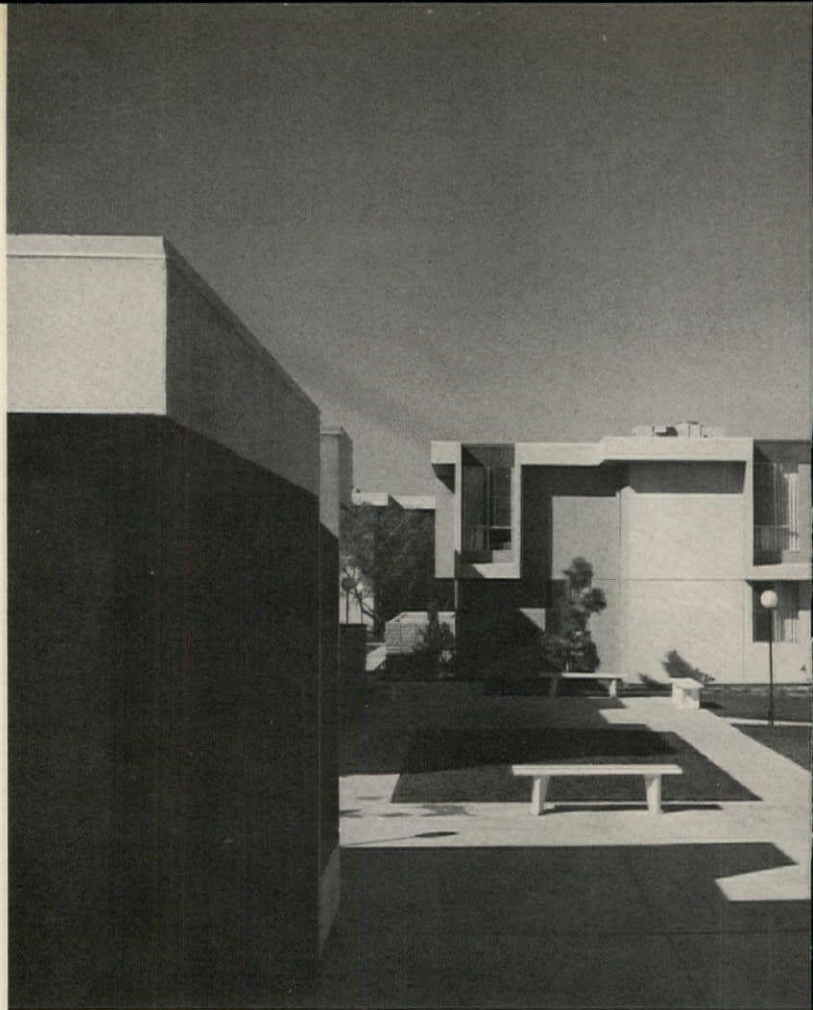

El Cajon, Calif.:

High-density
apartments that avoid
the curse of sameness



Site plan shows how the clustering of three different building types creates a variety of open space. Parking areas accommodate 230 cars. Of the total area, 27% is built up, 53% is paved and 20% is in greenbelts.

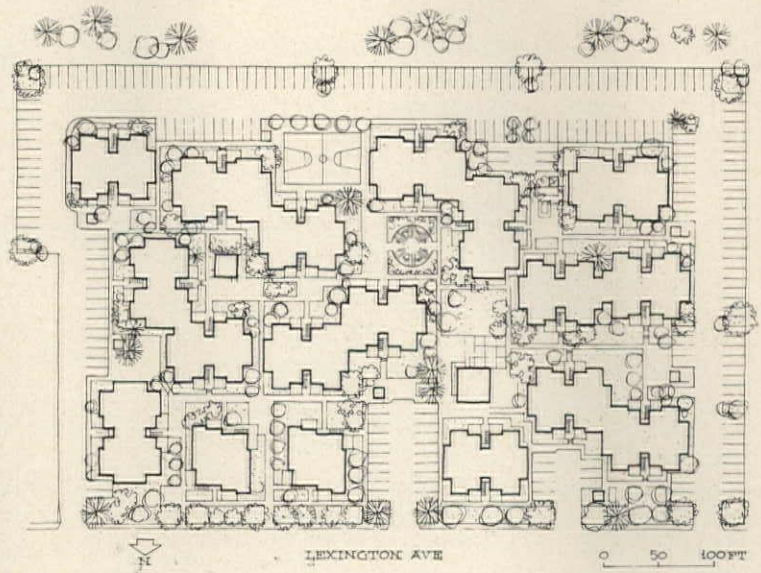

PHOTOS: LARRY FROST

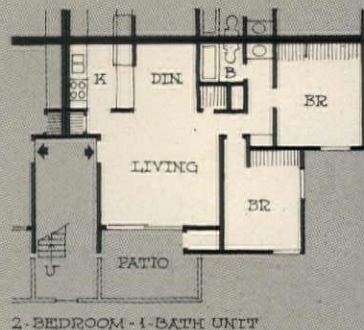

2-BEDROOM - 1-BATH UNIT

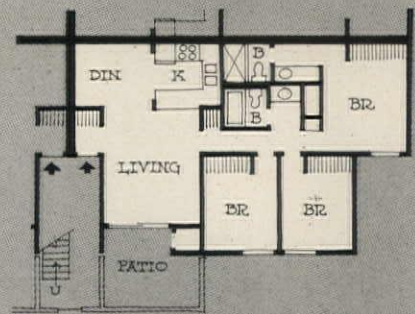

3-BEDROOM - 2-BATH UNIT

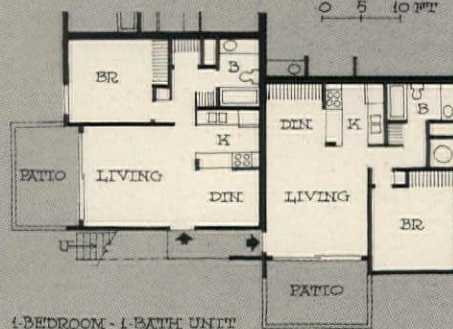

1-BEDROOM - 1-BATH UNIT

Three basic floor plans—for one-, two- and three-bedroom apartments—make up the three types of buildings. The 623-sq.-ft. one-bedroom unit rents for \$100 a month, the 863-sq.-ft. two-bedroom for \$125 and the 1,036-sq.-ft. three-bedroom for \$138. At left is a typical kitchen.

Despite a density of almost 40 units per acre, this FHA 236 project feels neither tightly squeezed nor monotonous.

The two-story buildings were designed to present a variety of facades and arranged in clusters to create a changing pattern of open spaces.

There are three building types—each with four units on the first floor and four on the second. Type A buildings con-

tain one-bedroom apartments; Type B buildings have two-bedroom apartments and Type C have three-bedroom units.

All apartments have outside entrances and private patios or balconies—features that, the architect notes, have given the tenants "a sense of individuality and pride in their housing." Community facilities include a laundry building that's large enough for neighbors to socialize

in while they use the washers and dryers, a large gazebo, eight trash houses, playground equipment and an outdoor basketball court.

The 5.7-acre project, called Lexington Green, has 144 apartments. Designed by Stephen G. Oppenheim, it was built by Apartment Constructors Inc. and is owned by Jerald Katleman.

New Haven, Conn.

22 rental units on a difficult urban site

The site was a problem for two reasons: first, because it is only one acre; second, because it is oddly shaped—narrow on the street side and wide in the rear.

The solution, shown in the plans and isometrics at far right, was to use the front of the site for a small building (*lower photo*), the rear for a large L-shaped building (*upper photo*) and the space between the two buildings for parking and play areas.

In the front building are 6 two-bedroom apartments on the two upper levels and storage, laundry and meeting rooms, plus covered parking for six cars, on the lower level. The L-shaped building contains 4 one-bedroom units (*C and D in drawings*) at the corner of the L and 12 four-bedroom units (*A and B*)—each with three bedrooms on the second floor and one on the third.

The FHA 236 project was designed by Louis Sauer Associates and built by Kapetan Inc. for a non-profit sponsor, Temple Beth Israel of New Haven. Rentals range from \$102 to \$155.



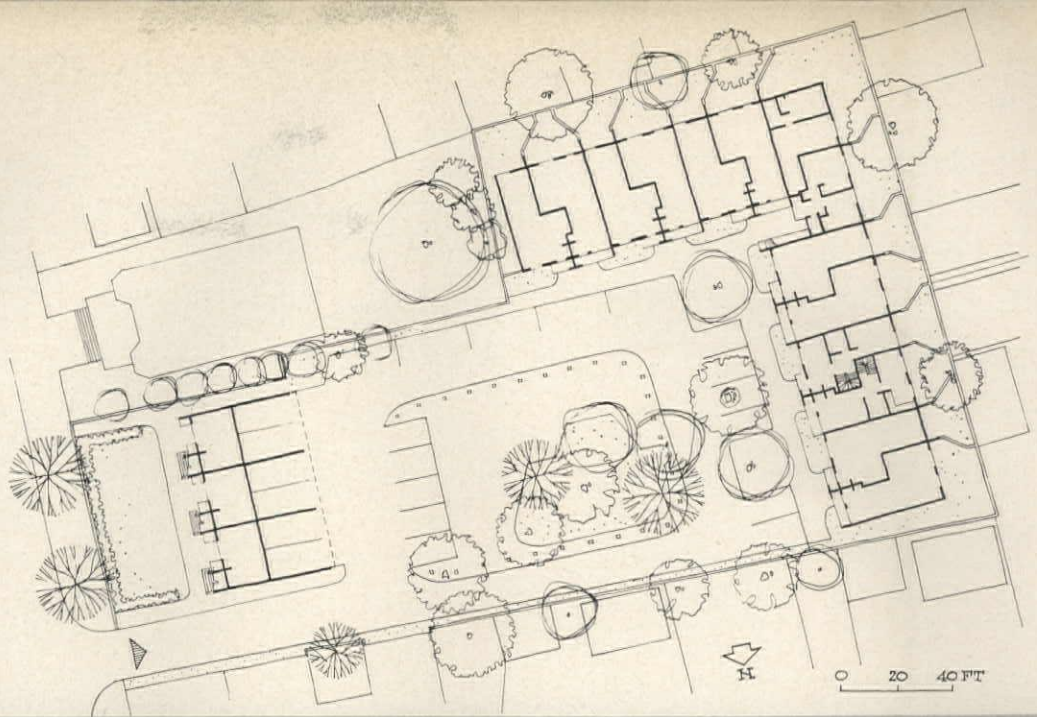

Townhouse units (above) are located at rear of site. In the foreground is a play area and parking. The parking ratio is 1:1. The photo below at left shows the front of the site from the street.

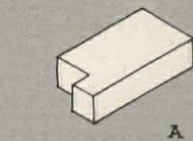
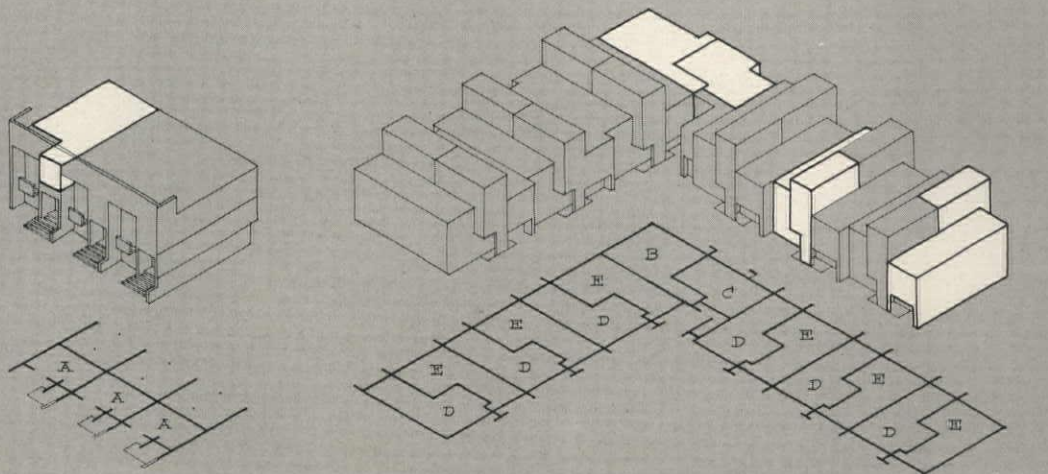

A

A UNITS

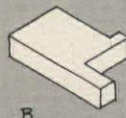

B

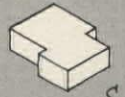

C

B & C UNITS

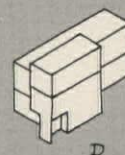

D

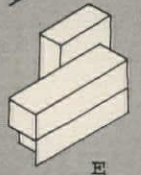

E

D & E UNITS

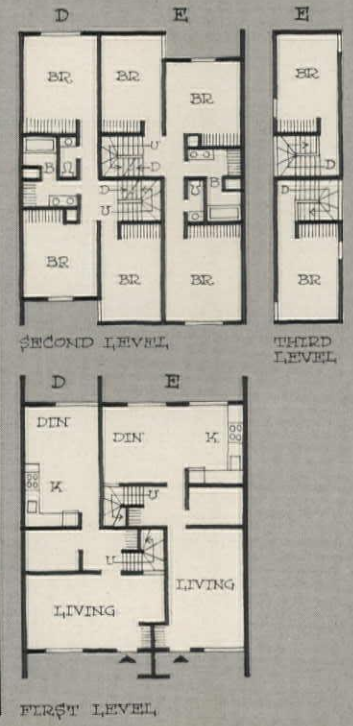
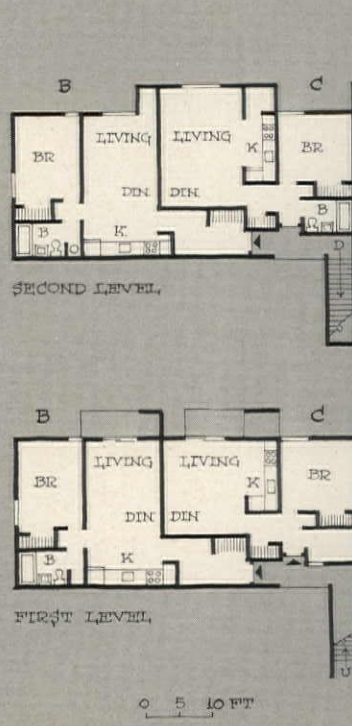
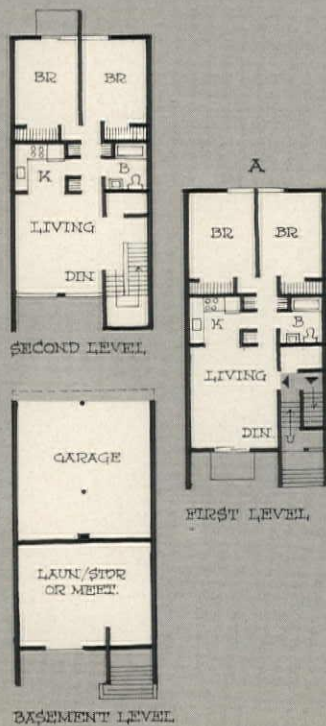

Project plan (upper right) was designed for an oddly-shaped site—narrow in front, wide at rear. Below, the isometric and floor plans are keyed to different apartment types—A, B, C, D and E.

Amherst, Mass.:

Buildings that merge into the meadow and woodland of a sloping site

There are two hundred units for moderate-income university staffers on the 21-acre site.

The two-story buildings are concentrated in open meadows or among trees to maintain the site's rural character. Since the slope averages 10%, each building site is graded as a small terrace to avoid major site re-working.

Two- and three-bedroom units are grouped in duplex townhouses with two apartments per building. The project has 94 two-bedroom and 10 three-bedroom units. These multi-bedroom units have direct access to childrens' play areas and open space. And they are outside the main traffic loop.

There are also 96 one-bedroom apartments—four units per building.

The \$3.7 million FHA 236 project was the first phase of Amherst-area subsidized housing to aid moderate-income university staffers, affluent students and faculty. The market-area includes the University of Massachusetts, Amherst College and several other well-known institutions.

A second phase of 200 identical apartments had been scheduled for an adjacent 21-acre site, but the apartment mix is being redesigned because of the strong demand for three bedroom units.

Architect: John Olson of Stull Associates, Boston. Owners and developers: Interfaith of Amherst and Development Corporation of America, Boston.

Typical views of the project are shown in the photos. Buildings are wood-frame with prefab walls. Cedar T&G siding blends with the rolling meadows and woodlands. At far right, top, buildings are built among trees and below are a typical site profile, site plan and floor plans.



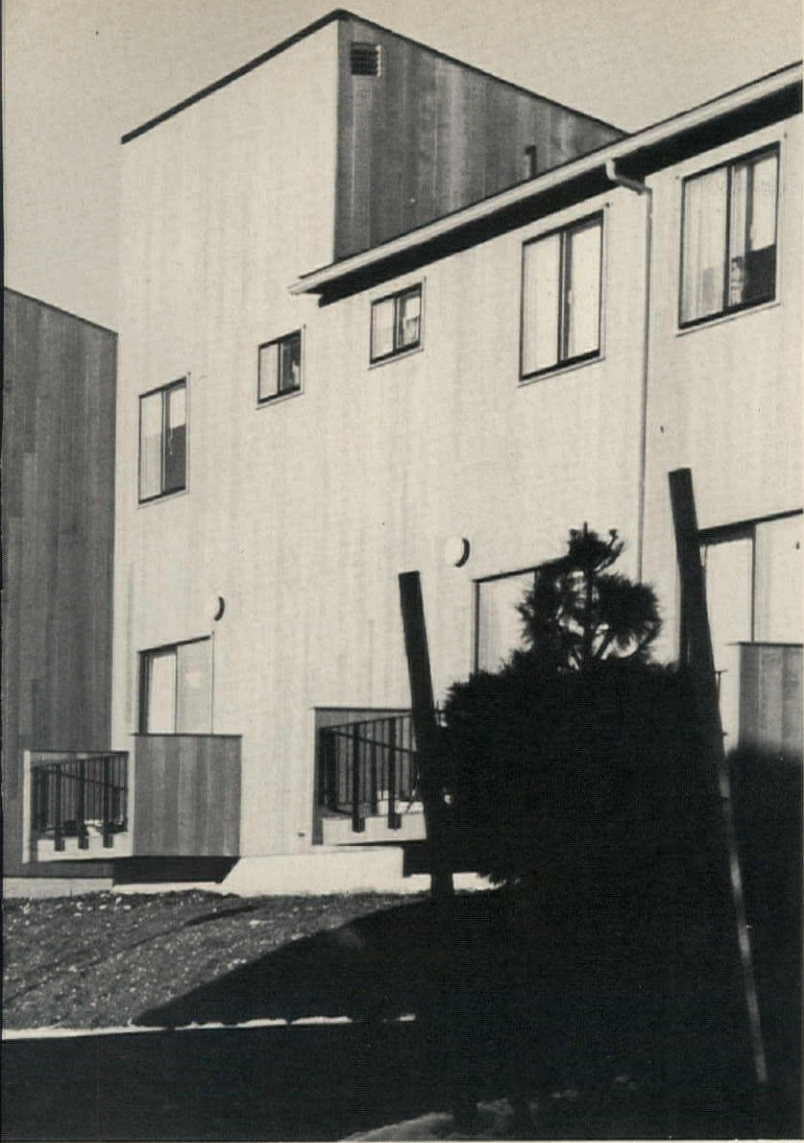

PHOTOS: STEVE ROSENTHAL

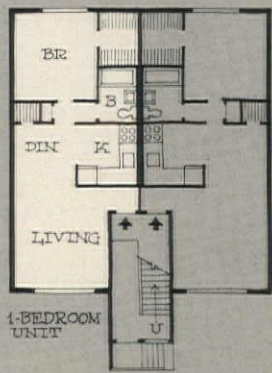
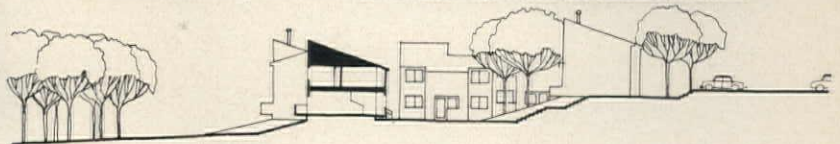

1-BEDROOM UNIT

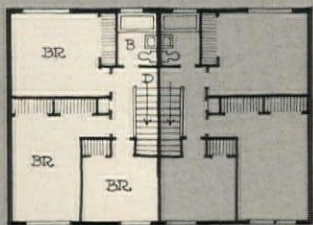

UPPER LEVEL

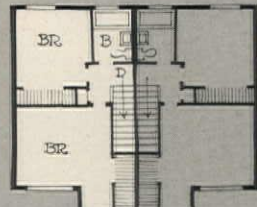

UPPER LEVEL

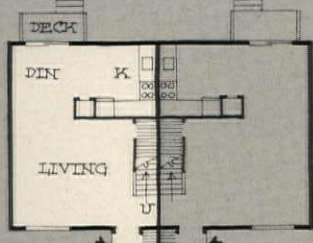

LOWER LEVEL
3-BEDROOM TOWNHOUSE

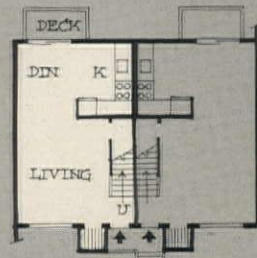

LOWER LEVEL
2-BEDROOM TOWNHOUSE

0 5 10 FT

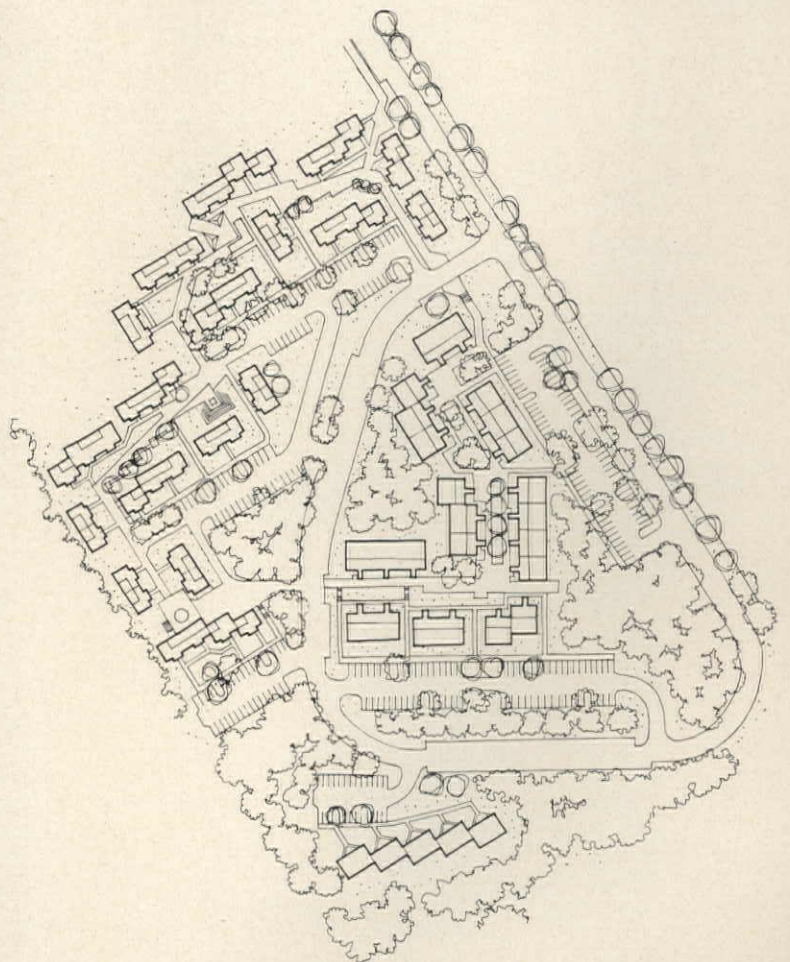

Ramapo, N. Y.:

Suburban apartment buildings designed around two basic modules

The modules are a 12'x28' unit containing living and/or sleeping space and a 12'x16' utility core. As the floor plans at lower right show, four living-sleeping modules are grouped around each utility core (shaded in plans). And this basic arrangement can be adapted to different combinations of apartments ranging in size from efficiencies to three bedrooms.

Despite its modular design, this 78-unit, HUD turnkey project was built conventionally by George Faist. But elsewhere in the same township, identical plans by the same architect, Micha Koepfel, were used for factory-built units turned out by Bon Aire Industries for a 122-apartment turnkey project.

Builder Faist's 4.6-acre project includes both elderly tenants and families with children, but the two groups are separated from each other by a parking area and green space (site plan, left). There are 59 apartments for older people (39 efficiencies and 24 one-bedroom units) and 19 for younger families (2 one-bedroom, 16 three bedroom and 1 three-bedroom units).

"Originally our plans called for a 60-40 ratio of elderly to families," says architect Koepfel, "but local opposition was strong because of the burden on local schools. Finally, a 75-25 compromise was worked out based on regional data rather than just what the town was doing."

The \$1.7 million project is owned by the Town of Ramapo Housing Authority.

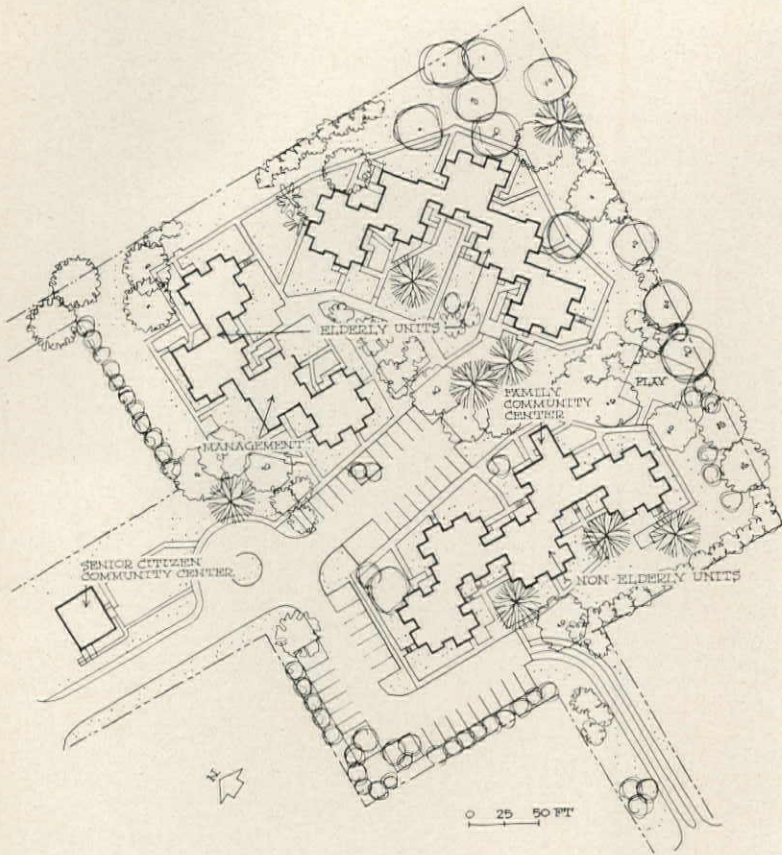

TYPICAL EFFICIENCY & 1-BEDROOM UNITS

0 5 10 FT



UPPER LEVEL, 2-BEDROOM DUPLEX UNITS

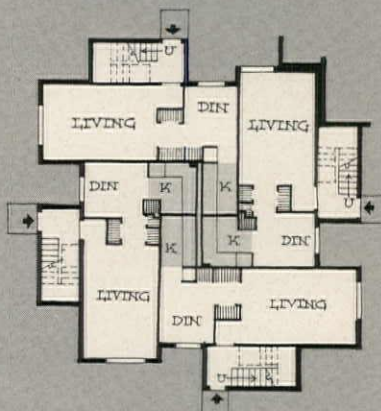

LOWER LEVEL, 2-BEDROOM DUPLEX UNITS

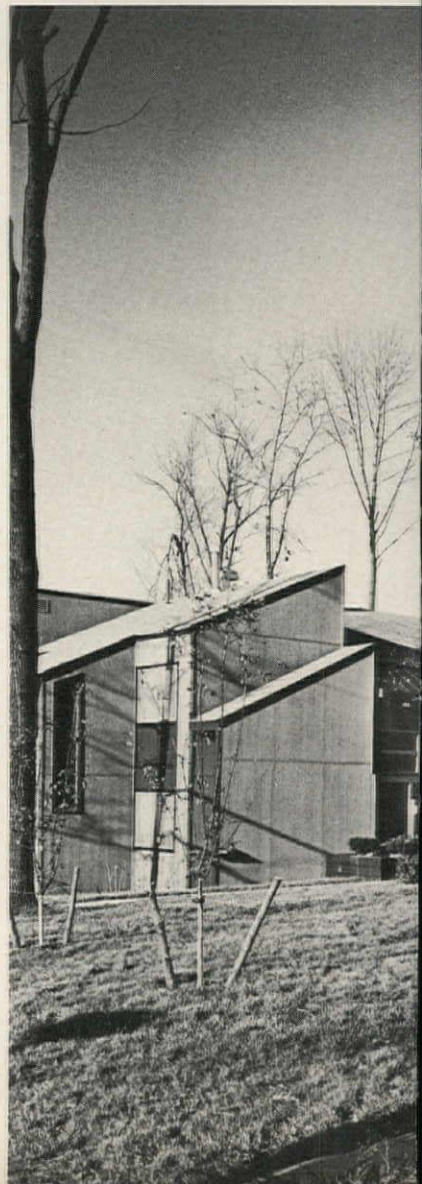



PHOTOS: BILL ROTHSCHILD

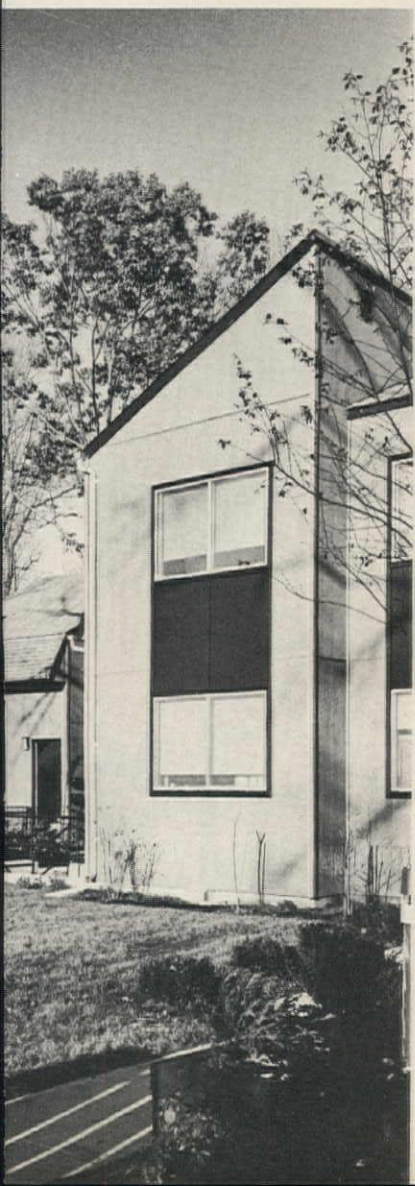

Small-scale buildings, grouped in three clusters, blend into the surrounding neighborhood of single-family homes. HUD ordered the builder to face the lower exterior portion of the family housing with brickwork so as to minimize damage from children.

Brookline, Mass.:

Two high-rises that meet the special needs of the elderly

Those needs are seemingly contradictory. On one hand, elderly tenants, often widowed and lonely, are eager for the opportunity to mix with their neighbors. On the other, they want privacy and quiet within their own apartments—a desire that can cause problems because some older people suffer from poor hearing and thus turn up their TV or radio volume.

Both needs are met in the two apartment towers shown here—one 12 stories and the other nine. Social exchange was encouraged by providing 1) a common lobby, elevator shaft and mailbox area for both buildings; 2) community lounges on the first nine floors; and 3) a rooftop terrace, cafeteria and laundry room. Apartment-to-apartment noise was held to a minimum by using 8"-thick concrete walls between units.

Designed by Stephen Tise of Stull Associates, the towers were built by Sydney Construction Co. with precast and prestressed concrete components. The use of three different exterior wall panels made for a variety of textures and patterns.

Of the 214 apartments 25% are leased by the owner, C.W. Associates, to the local public housing authority—a requirement of the lender, the Massachusetts Housing Finance Agency. The rest rent at market rates.

The apartment mix and rent scale: 68 efficiencies, from \$55 for public housing tenants to \$163; 115 one-bedroom units, \$70 to \$244; 31 two-bedroom units, \$80 to \$269.

Single entry lobby, seen from the outside and inside in the first two photos at right, serves both high-rise buildings. At far right is one of the project's nine community lounges.

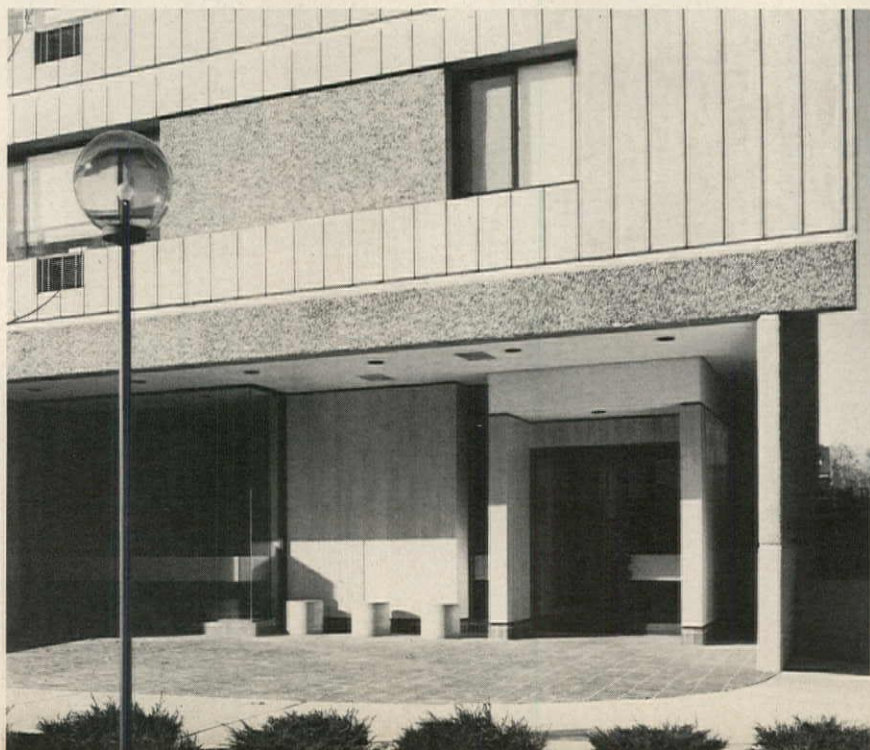

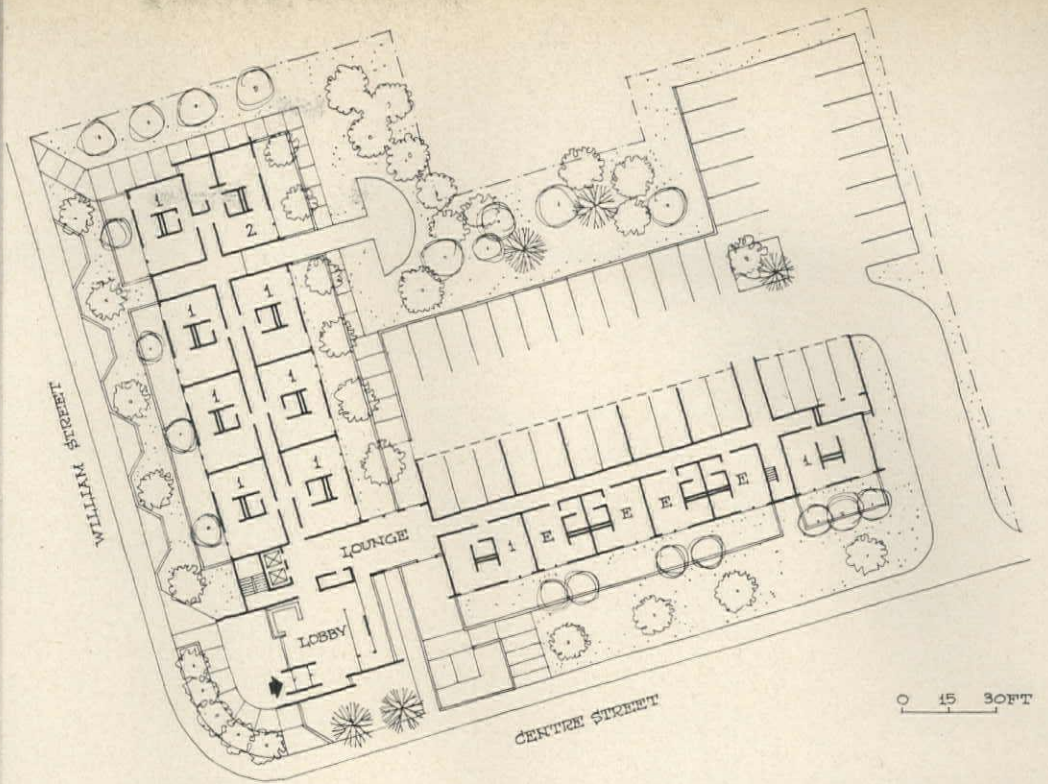

PHOTOS: GEORGE ZIMBERG

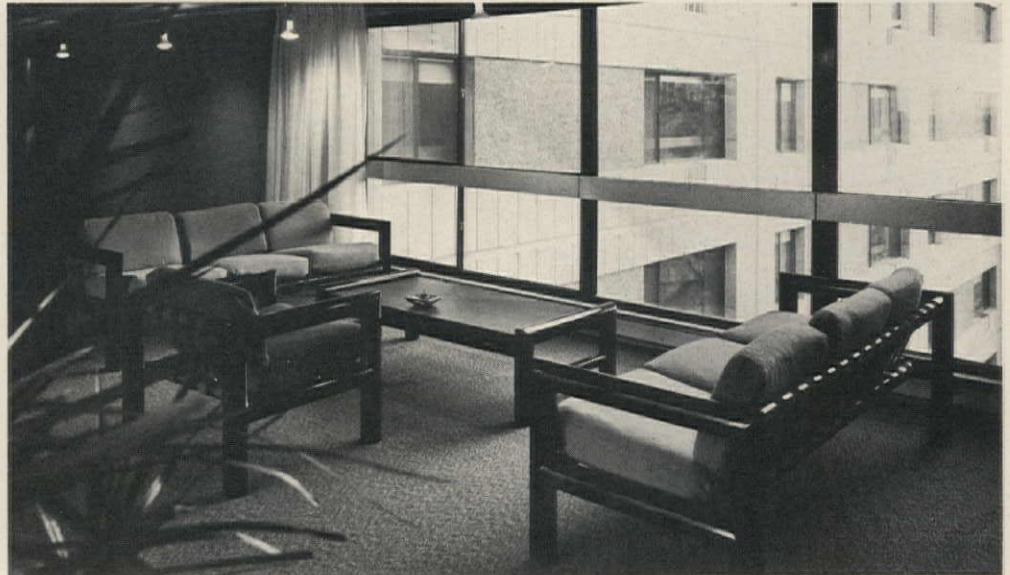
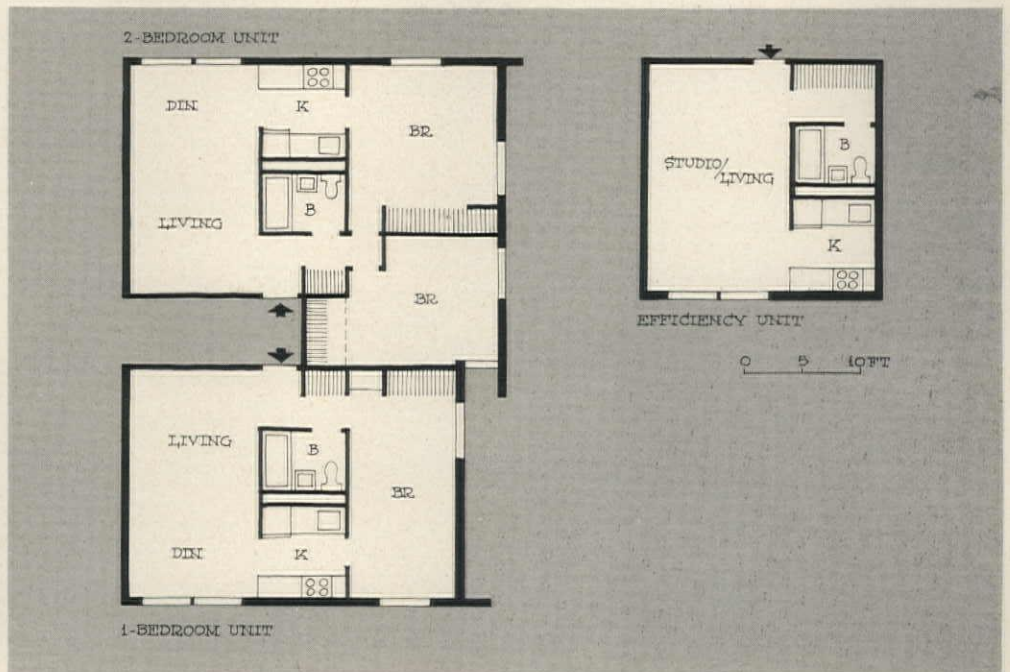



Reliability... building tools that turn out an honest day's work for an honest price. And backing them up with honest, convenient service.

Choice... building a wide line of tools to do a wide variety of jobs. Convenience... building power tools that make the job easier, do it better. The whole idea started with a drill.

Today there are **340 tools**
151 Service Centers
1 quality.....



...the best...from  *Black & De*

**Have you ever made a call
where you got the receptionist
who referred you to sales,
who referred you to accounts,
who referred you to products,
who referred you to shipping,
who referred you to traffic,
who put you on hold?**

**With Del-Mar,
if you ever have a question
about our kitchen cabinets,
just call (404) 696-1469 call
Talk to Pat Wilson.
You'll get an answer.**

Del-Mar

WE SELL SERVICE WITH EVERY CABINET.

Del-Mar, A Division of

CIRCLE 122 ON READER SERVICE CARD

CIRC



How to make a town house a country house.

Introducing Barnwall.™

A new exterior siding from U.S. Plywood that looks and feels like planks of real weathered barnsiding. And gives low-rise residential and commercial buildings that "best-selling" edge.

Barnwall is every bit as rugged as its name. The handy 4' x 8', 9' or 10' panels provide natural insulation, as well as great dimensional stability and rigidity. So they can

be nailed directly to studs. No sheathing, building paper or corner bracing is necessary. Saving you barnloads of time and money.

Barnwall comes in two different grades. Clear (as pictured above) and rustic, with solid and filled knots. Both grades are 5/8" thick. With classic 8" o.c. grooving in a "plank" pattern carefully textured by U.S. Plywood.

Whenever you specify

textured siding, remember: we make the most complete line in the business — vertical panels (both grooved and ungrooved), lap and board-and-batten. A total of 16 different styles, including Barnwall.

For more information, contact your local U.S. Plywood Branch Office.



U.S. Plywood

A Division of Champion International
777 Third Avenue, New York, N.Y. 10017

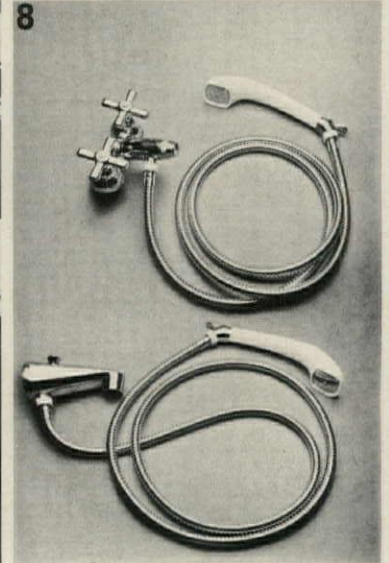
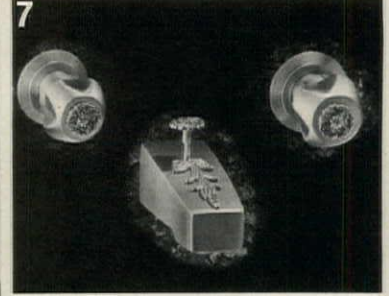
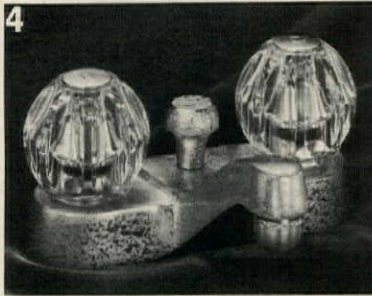
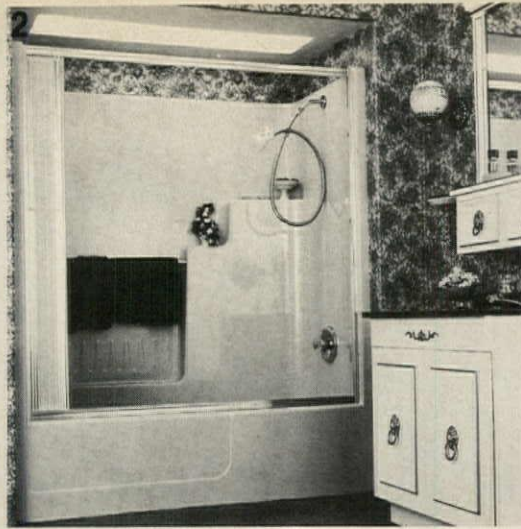

products: bathrooms

1. Knock-down vanity can be easily assembled without using tools. Smoke-white, woodgrain unit with a gold deco strip is available in depths of 20" to 22" and in widths of 24", 30" and 36". Acrylic vanity tops are offered in gray-on-white, avocado and gold. Mouldings, Marion, Va. *Circle 290 on reader service card.*

2. Folding shower door with a panel-hinge design permits wide-open access to a tub or a shower. Doors have shatterproof polystyrene panels and hinges and an anodized-aluminum frame. Hinges are available in a wide range of decorative accent colors. Enclosures are engineered to fit all standard tubs and showers including molded fiber glass units. Tub Master, Orlando, Fla. *Circle 291 on reader service card.*

3. Fiber glass tub, "Helene," translates luxurious Greco-Roman styling into a functional contemporary bath fixture. The leakproof, stain-proof 5'-round tub fits into any maximum 7'x7' setting. One-piece, molded unit is available in white, hot pink, orange, yellow, green and blue. Novaglas, Long Island City, N.Y. *Circle 292 on reader service card.*

4. Elegant "Tiffany" fittings have etched gold finish protected by a high-baked plastic coating. A single quarter turn of one of the crystalline acrylic handles brings the faucet from full-on to positive-off. Chicago Faucet, Des Plaines, Ill. *Circle 293 on reader service card.*

5. Single-control mixing valves for tubs and showers feature "Delex"

pressure balance that protects against sudden water temperature changes due to pressure fluctuation. A built-in pushbutton diverter automatically returns to tub position when unit is turned off eliminating unexpected showers. All valves are equipped with adjustable high temperature stop to prevent scalding. Delta Faucet, Greensburg, Ind. *Circle 294 on reader service card.*

6. Luxury bathroom with a contemporary look features a full range of deluxe fixtures in elegant "Black Black". Center of attraction is the 5½'x7' bathing oval, "The Bath". At the far left is the sculptured "Rochelle" toilet and the "Caravelle" bidet. Also shown are the "Lady's Vanity" and the distinctive "Man's Lav". Faucets and fittings are "Al-

terna". Kohler, Kohler, Wis. *Circle 295 on reader service card.*

7. Brass fittings, "Decora," add a traditional touch to a bathing area. Floral decorations are applied to spouts, handles, corner plates and pop-up controls. Metal or genuine crystal handles are offered. Metal handles snap and lock in place eliminating the need for set screws. Eljer Plumbingware, Pittsburgh, Pa. *Circle 296 on reader service card.*

8. Hand shower, "ShowerAll," is available in three easy-to-install models. Shown are leg & faucet and wall-mounted spout versions. The other model is for shower fittings. Flexible chrome hose controls water direction. Jaclo, Brooklyn, N.Y. *Circle 377 on reader service card.*



Designed by Wm. F. Freeman Associates.

PPG Glass puts all the beauty of the outside on the builder's side.

With PPG's *Herculite*® K tempered safety glass, in sliding glass doors and large glass panels, you can make all the beautiful scenery a part of the room—practically, economically and safely.

And it's this open look that's selling homes today.

Herculite K is many times stronger than ordinary glass. And if it ever does break, it crumbles into small rounded pieces that reduce the chance of serious injury.

Look at PPG Glass as the modern material that will help you build the open life into your homes.

Including the true spaciousness that comes from mirrors made of *High-Fidelity*® float glass.

And consider *Twindow*® Xi,™ PPG's newest insulating glass. *Twindow* Xi is two panes of glass welded together with a special dry gas in between to help keep out the cold and reduce condensation.

Write us now for a free copy of "PPG Open House/USA"—hundreds of ideas from actual merchant-built models. Dept. HDD-4122, PPG Industries, Inc., One Gateway Center, Pittsburgh, Pa. 15222.

Stop by Booth 2151



PPG: a Concern for the Future





products: furniture

1. Fully-stuffed multiple seating, "Mogul", is upholstered in genuine leather. Basic component of the collection, a single seating unit that can have one or two arms added, can be grouped in a multitude of arrangements. Complementary wedge-shaped tables can be placed between the seating units for the graceful curve effect shown. The frame is selected hardwood. Seat and back are filled with feather and down pockets on a deep, soft foam. Arms are Dacron-on-foam mounted on sprung-steel brackets. Tetrad, England, Arthur Gordon, New York City. *Circle 297 on reader service card.*

2. Luxurious leather sling chair is part of a contemporary group imported from Brazil. The Lafer "MP-Series" includes the lounge chair

shown, a high-backed seating piece, a matching ottoman and a full 88"-long sofa. Filling is one-piece molded urethane foam. The reasonably priced chair can be upholstered in white, chocolate, terra-cotta, avocado, black, bronze, or honey leather or maté suede. Square, low-to-the-ground base is a kiln-dried Jatoba hardwood with a rosewood finish. Brazil Industries, New York City. *Circle 298 on reader service card.*

3. Brightly lacquered dining set imported from Finland is available in white, black, red, blue, green or yellow. The casual contemporary group includes an extension table and four sleek straight-back chairs. Comfortable upholstered seats can be covered in fabrics or leathers. Iskun, Finland. *Circle 299 on reader service card.*

4. Maintenance-free furniture has frames with buffed aluminum finish and walnut inlay. The group shown includes a lounge chair and matching ottoman, a full length sofa with six reversible foam cushions and a cocktail table with a glass top. Other casual living and dining pieces are also available. Frames are offered in natural or a selection of colorful finishes. A wide array of floral fabrics and wet-look vinyls is offered. Medallion, Miami, Fla. *Circle 300 on reader service card.*

5. Five-piece dining set of rattan and wicker is available in two heights: the continental 26" and the standard 29". Offered with 42"- or 48"-round Formica tops in a choice of 13 colors and patterns, the group comes in 18 frame finishes. Chairs with mem-

ory-swivels have cushions that can be upholstered in any of 185 fabrics. Vogue-Rattan, Lexington, Ky. *Circle 301 on reader service card.*

6. Rocking swivel chairs, designed by Frenchman Marc Held, are intended to relieve muscular strain due to motionlessness. Design is based on the theory that walking is less tiring than standing still. The collection includes a high-back model, a lounge chair and a matching ottoman. Pieces with latex foam inner fillings rest on tub-like convex bases that are precisely balanced to avoid tipping over. Chair can be upholstered in a choice of fabrics or leathers. Molded polyester and fiber glass shell has a white lacquer finish. Knoll, New York City. *Circle 302 on reader service card.*

FIREPLACES

by



An American-Standard Company

America's Leading Fireplace Manufacturer



the
center
of
things

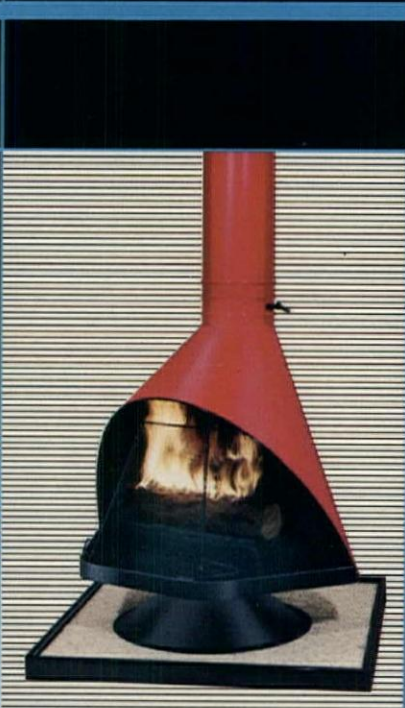

An American-Standard Company



For new construction or remodeling you can now pick a fireplace to match your own architectural style, construction requirements, even fuel preference—almost without limits—from Majestic's most complete line of factory pre-built fireplaces.

When your preference is "in-the-wall" traditional style, choose a Majestic-Thulman, zero clearance, Built-In or a compact gas-fired Gasilator. All Majestic Built-In fireplaces have full measure openings—28", 36" or 42"—and corner open models are available for wood-burning units in 36" and 42" sizes. Majestic designs are especially suited to multiple and unusual installations. The patented triple-wall flue sections and elbows allow on-center stacking to a single termination for the most economical installations possible.

If you prefer a little more modern zest to your style, the Majestic line of Contemporary free-standing, wall-hanging or even suspended fireplaces give you enough variety to satisfy the most discriminate decorator. A choice of wood-burning, gas-fired or electric in a selection of decorator colors, sizes and shapes further "tunes" your Majestic Contemporary selection to the decor of any room in home, apartment, or leisure home. And they're prefabricated by Majestic to not only insure best performance but to be "the center of things" from every view point.

Select Majestic for the center of family living and fireplace excitement. We'll send you colorful literature and the name of our nearest distributor—free for the asking. The Majestic Company, Huntington, Indiana 46750.



products: kitchens

1. Flush-door cabinets provide a smooth unbroken look for a modern kitchen. The fruitwood-finished "Contemporary Series" has frames of 3/4"-thick selected northern hardwood. Wall-mounted cabinets are 12" deep and are available in one- and two-door models. The single-door units have adjustable shelves. Double-door versions feature a center support. Series has concealed antique-copper-finished hinges and magnetic door catches. Felt pads behind the drawers provide whisper-quiet closing. The three-coat baked-on polymer exterior finish is highly resistant to scuffs and stains. Conner Forest, Wausau, Wis. *Circle 310 on reader service card.*

2. Single-door refrigerator, "Cold Spot 63121", packs a 12.4-cu.-ft. ca-

capacity into a compact 24"-wide, 56 1/2"-high cabinet. Formed-in-place insulation creates a solid wall construction that reduces thickness without losing insulating properties. Instructions on starting, adjustment, defrosting, cleaning, power, maintenance and service are permanently affixed on the horizontal surface above the butter compartment. Additional information on specific operations is placed throughout the unit. The model has two 21 qt. crisper drawers, adjustable shelves and a 55-lb. capacity freezer. Refrigerator is available in white, avocado or gold with right- or left-hand door swing. Sears Roebuck, Chicago. *Circle 311 on reader service card.*

3. Contemporary cabinet line, "Overture", is a basic black and

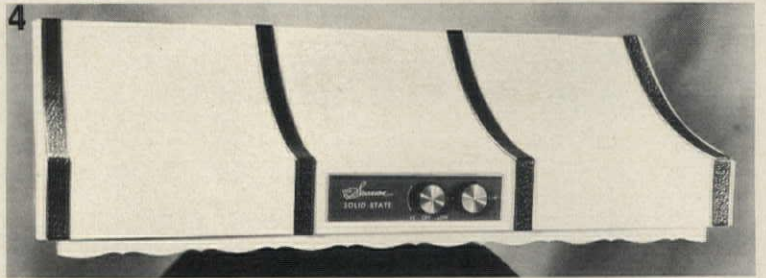
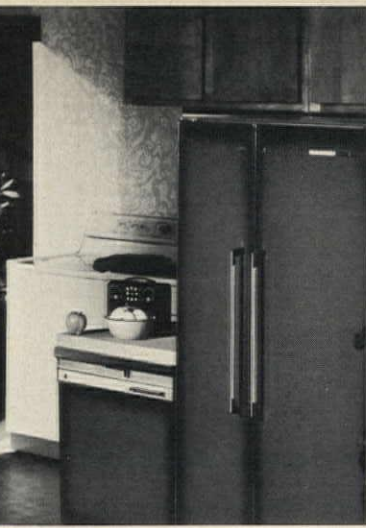

white design. Units have exposed face-frames with a three-coat oven-baked black laquer finish and baked-on white polyester laminate door and drawer fronts. Line features semi-concealed, self-closing hinges and die-cast pulls with black finish. Wall-mounted cabinets in 9" to 30" heights are available with adjustable shelves. Interior surfaces are spray-coated for easy maintenance. Del-Mar, Atlanta, Ga. *Circle 312 on reader service card.*

4. Decorative range hoods are available in vented and recirculating models. Vented versions feature two solid-state blower fans that operate extremely quietly even at full speed. All units feature two control switches—one to regulate fan and one for the built-in incandescent

light. Both models have fully washable grease and air filters. Recirculating units are equipped with special charcoal filters as well. Hoods are offered in mitered and unmitered styles in a wide range of baked-on colors and hammered or smooth metal finishes. Swanson, Owosso, Mich. *Circle 313 on reader service card.*

5. Built-in countertop dishwasher operates on waterline pressure. Only two connections are necessary: one to the hot water line and one to the drain. The powerful compact unit washes and dries a four-place setting in five minutes. The 21"-diameter, 12"-deep small-load unit requires no maintenance. Its only two moving parts rotate on DuPont Teflon bearings. Vulcan, St. Louis, Mo. *Circle 378 on reader service card.*

"Du Pont CORIAN® gives us a highly visible and effective merchandising benefit."

Bayne A. Sparks, Vice President Marketing, Grant Corporation, Newport Beach, California

Interior Designs by Carole Eichen Interiors, Inc., Fullerton, California



DOUBLE VANITY...TWIN VANITIES.

All of CORIAN. In fact, CORIAN is used for all vanity tops in the 320-home development of Westridge, a luxury project being built in the master planned community of Anaheim Hills by Grant Corporation, one of the 25 largest housing producers in the nation. CORIAN offers beauty, durability, and the look of luxury that draws enthusiastic comments from prospective homeowners.

"Prospective buyers comment very favorably on the CORIAN vanity tops in the baths of our model homes in Anaheim Hills," said Mr. Sparks. "We know they're one of the reasons we sold 37 houses in the first two weeks they were open.

"All 320 Westridge homes will have CORIAN vanity tops in each of the two or three bathrooms it has.

"CORIAN costs a little more...but it's one of the key features we feel are making these homes, selling from \$43,000 to \$53,000, the quality home investment that buyers want. Prospect reaction confirms this.

"And we know the durable attractiveness of the material will pay off in continued sales."

Du Pont CORIAN® methacrylate is available in sheet stock for custom surfaces (it can be worked with regular tools), kitchen countertops, wall wainscoting, bathtub and shower surrounds. One-piece molded vanity tops and bowls of CORIAN also available. For more information and the name of the distributor nearest you, write to Du Pont, Room 23194, Nemours Building, Wilmington, DE 19898.

DU PONT CORIAN®
REG. U. S. PAT. OFF. Building Products

Clean Environment Begins at Home



...Banish Dirt from Living Areas with the Built-In Filtex Power-Vac Cleaning System

- Includes convenient dirt outlets to reach every room.
- 30' Lightweight hose reaches every corner.
- Power unit provides up to 4 times the vacuum efficiency of ordinary vacuum cleaners.
- Special metal attachments pick up dirt from floor-to-ceiling.
- Power unit located in garage or utility room assures silent vacuuming in living area.
- Eliminates lifting or dragging an unwieldy tank or upright cleaner.
- Practical for existing as well as new homes.
- Keeps air clean by removing dust and pollen.

...Reduce the Problem of Waste with the Miniature Filtex Trash Compactor

- Measures a convenient 23" high, 15" deep and 12" wide.
- Compacts trash to one-quarter of original bulk.
- Takes bottles, cartons, cans, plastic—all kinds of waste.
- Make only 1 weekly trip to service area for an average family.
- Comes ready to use—no installation necessary.
- Operates on regular 115v current.
- Applies 2000 lbs. of force—just as most oversize compactors.
- Color choice of white, gold, avocado, or coppertone harmonizes with decorative color schemes.

Protect the home environment — send for Free Full-Color Brochure today!

- Filtex Trash Compactor
 Built-In Power-Vac Cleaner



Filtex
division of

Natter Manufacturing Corporation

9440 Gidley Street,
Temple City, California 91780

Visit Booth No. 3247

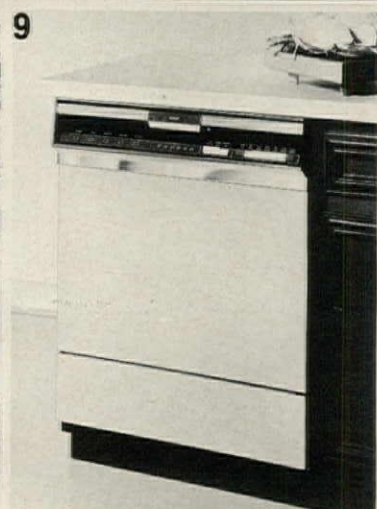
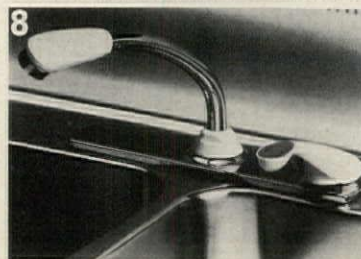

products: kitchens

6. Compact bar, "Image", is equipped with a built-in 5 cu. ft. refrigerator and a 12-bottle wine rack. Available in wet or dry models, system features indirect lighting and glass display shelves backed with laced mirrors. Storage drawers and cabinets are also provided. Wet-bar units have stainless steel sink/faucet assemblies. CCM, Marblehead, Mass. *Circle 314 on reader service card.*

8. Faucet fittings feature single-lever control. The spout turns 360° at the base and the head tilts 45°. Encased in glass-reinforced Celanese Celcon plastic, the swivel head will not rust, spot or stain and is highly resistant to soaps, detergents and chemicals. Unit, with a chrome-plated excutcheon, fits any standard sink. American Standard, New Brunswick, N.J. *Circle 316 on reader service card.*

7. Decorative laminate for countertop application is available in sizes up to 5'x12' and in thicknesses of 1/16" and .032". Melamite pattern, "Tortoise Italia", is a rich brown mottled effect with bright gold highlights. Design is offered in a stonelike finish. Johns-Manville, Melamite Div. Lawrence, Mass. *Circle 315 on reader service card.*

9. Front-loading dishwasher features rapid-advance, solid-state timer controls. Six pushbutton cycles are featured including regular, glass and pots-and-pans washes. Since different water temperatures can be used with some cycles, a total of 13 settings can be programmed into the unit. Tappan, Mansfield, Ohio. *Circle 317 on reader service card.*

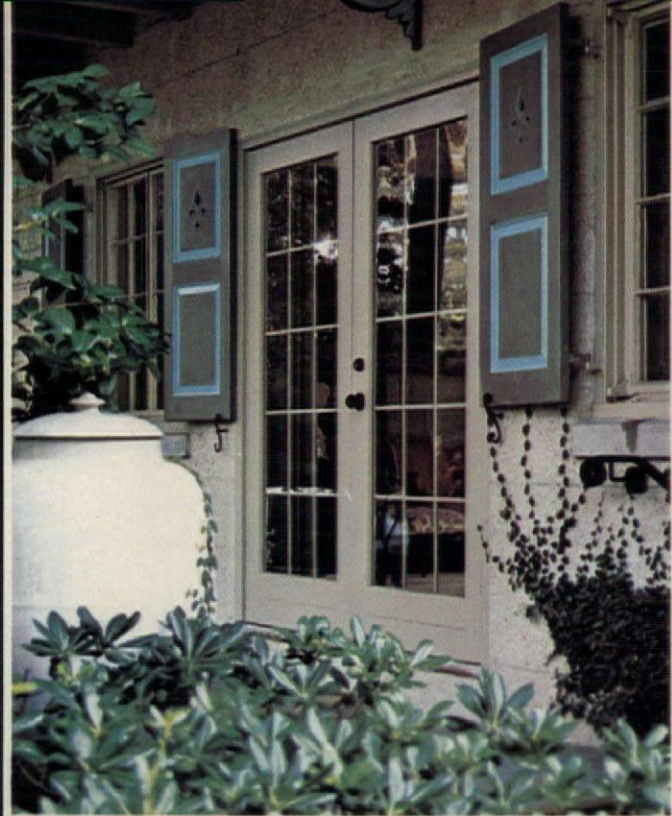

The Chadeau by Peachtree Door... A Tradition in The Making.

One of our traditions at Peachtree Door is new ideas. Like our Chadeau. It doesn't slide... it's a swinging glass patio door. It caused a lot of excitement when we introduced the Chadeau at the show last year. Almost as much as when we introduced our Carvel in 1966. It was the best wood-framed patio door around. Or, when we introduced the lowest-priced wood-framed patio door in 1970. Our Citadel. New ideas is just one of our traditions. Quality and craftsmanship are others. We've grown on the old-fashioned idea of making a quality product and standing behind that product. It's working.

See what's behind a Peachtree Door at Booths 3232 and 3343.

PEACHTREE  DOOR

A Concern For Better Products

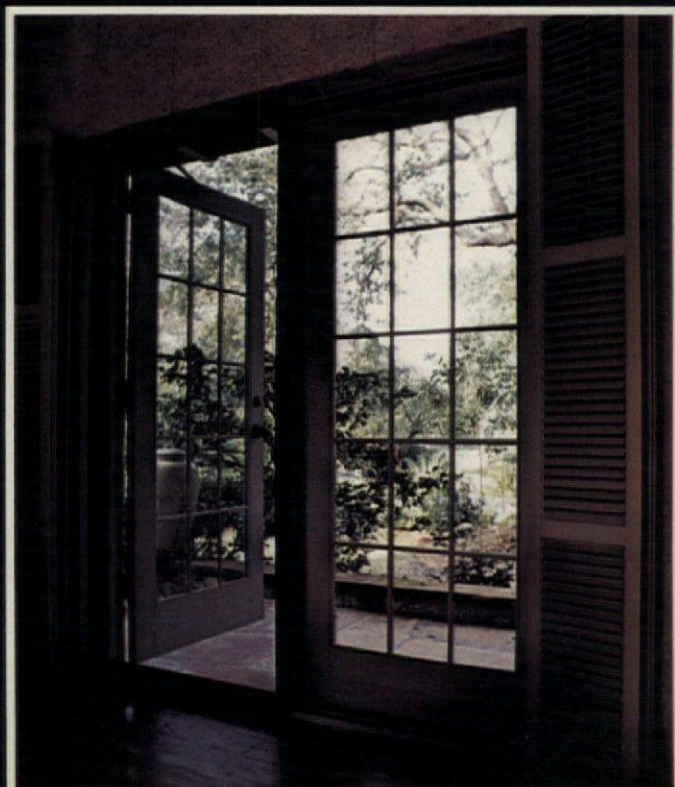

U.S. Home builds the widest product line in the industry. Moen covers their faucet needs beautifully.

US·Home

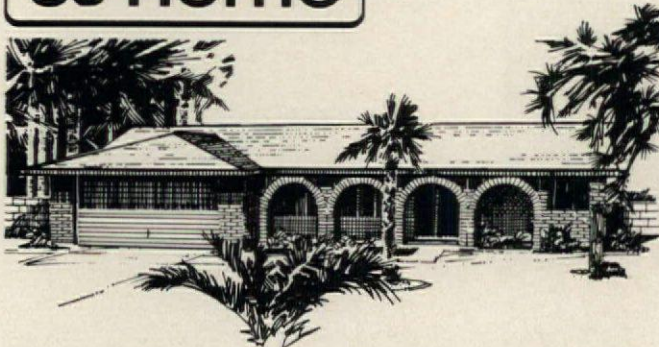

Single family community, Phoenix, Arizona.

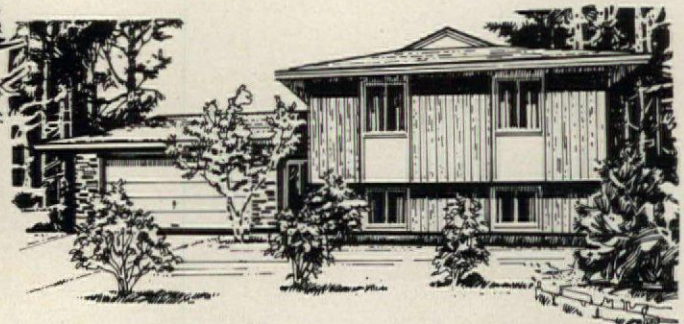

Single family home, Minneapolis, Minnesota.



Rental apartments, Largo, Florida.



Condominium villa, Sarasota, Florida.

Single Family Homes. Condominiums. Rental Apartments. Townhouses. You name it; U.S. Home builds it. Nationwide.

Yet even with their broad range of housing, U.S. Home, one of the nation's very largest builders, finds Moen faucets fit in everywhere. Beautifully.

That's because Moen gives them what they need. Several great lines of faucets. All built around the identical great Moen cartridge. And priced to fit the wide range of U.S. Home housing.

U.S. Home is an increasingly important factor in the national housing picture. So is Moen . . . modern, convenient, reliable. Like U.S. Home, Moen offers the best in livability, the tops in worthwhile housing value.

To find out more about Moen, the line that's as right for you as it is for

U.S. Home, write, Moen, a Division of Stanadyne, Elyria, Ohio 44035.

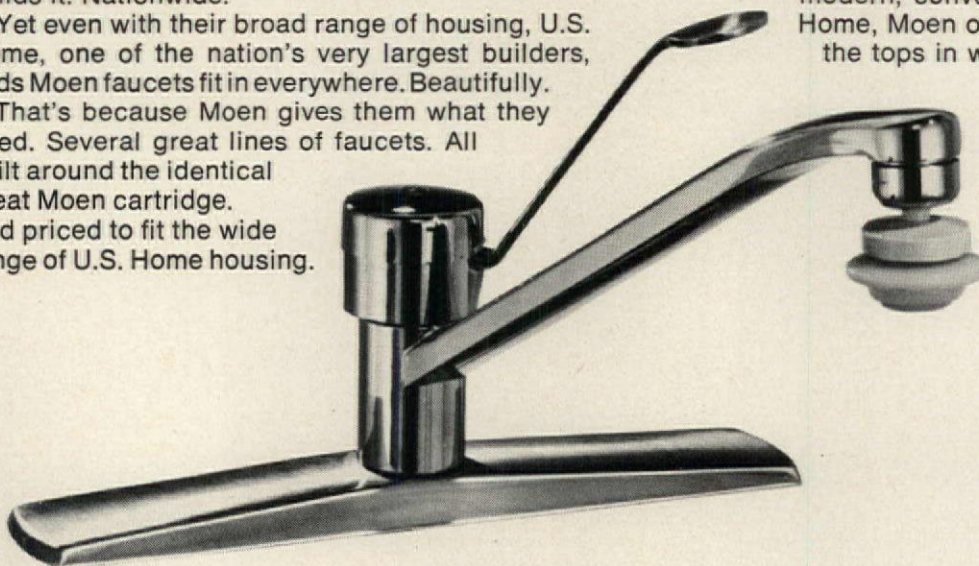

There's
Only
One



MOEN

Is Temple hardboard siding really better?

Judge for yourself.



Temple primed sidings eliminate half the painting job—the prime coat—as well as providing weather protection during construction.

And because Temple hardboard siding is made from 100 percent wood fibers, it can be worked much like wood—in many ways, better than wood.

For instance, Temple hardboard siding panels and lap siding don't split when cut, and there's no splitting during nailing. Nails can be driven flush without damaging the board surface.

Each panel is an identical match, so there's no hunting to match boards. Temple sidings are free from knot holes, are easy and quick to apply, and have no resins to bake out later in the sun.

Judge for yourself—against whatever siding you're using. Then check the prices at your Temple building materials dealer—against whatever siding you're using.



TEMPLE INDUSTRIES
DIBOLL, TEXAS 75941





**Great for
high-rise, low-rise or
no-rise dwellings**

The TILT-TAKE OUT from WABASH

The Wabash Tilt-Take Out Window is a pre-finished, double-hung unit made of only high-grade Western Pine for maximum beauty and insulating efficiency. It has a special Korad® wrapped hardboard sill which shields against weather, scratching, pitting, corrosion and never needs painting. Dri-Vac treatment gives protection against fungus, rot and insect damage. The exterior frame and sash are pre-finished with a weather-proof coating.

The special "tilt-take out" feature of this Wabash unit permits effortless cleaning of outside glass areas by allowing the sash to be tilted inward. Rectangular grooves prevent accidental tilting. The unique 4-balance tilt mechanism is self-lubricating and is not affected by dust or dirt.

This pre-finished Tilt-Take Out unit is completely factory assembled and shipped ready-to-install in car loads or by Wabash truck. Removable colonial wood grids and regular or insulating glass are available.

High-rise, low-rise or no-rise—the Wabash Tilt-Take Out serves your building and remodeling needs with the greatest in window efficiency. See your Wabash dealer or distributor today.

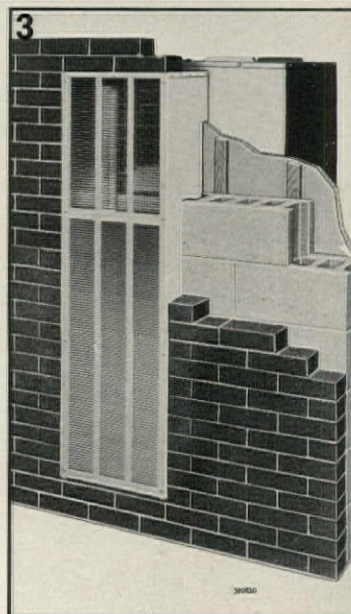
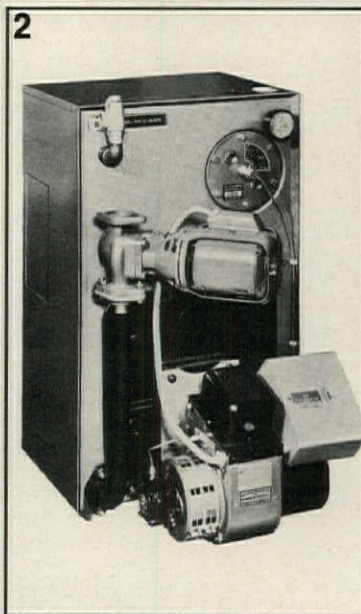

products: heating/cooling

1. Electric heat-pump system offers automatic year-round heating and cooling comfort. The compact all-electric "Weathertron" unit is flameless—producing no fumes, smoke or soot. Only filtered air is circulated through ducts into every room. Indoor section takes up little usable space and can be installed in an attic crawl space or closet. Outdoor equipment is similar in appearance to central air conditioning with a top air-discharge that directs air and sound away from house and shrubs. General Electric, Louisville, Ky. *Circle 303 on reader service card.*

2. Cast iron boiler is suitable for hot water or steam heating. Specifically designed for oil firing, the unit is available in five sizes from 100,000 to 205,000 BTUH hot water to 260

to 725 sq. ft. steam. The compact 35"-high, 20"-wide unit is factory assembled. All controls are mounted on the front of boiler to permit close-to-wall installation. Weil-McLain, Michigan City, Ind. *Circle 304 on reader service card.*

3. Environmental control module provides gas heating/electric cooling in a single through-the-wall unit designed for outside-wall installation. The 16"x56" wall opening for intake and exhaust air can be concealed by architectural bricks or optional grille work. Factory-assembled units are available in three cooling and three heating capacities. A built-in power-vent eliminates the need for chimney vent stacks. Mueller Climatrol, Milwaukee, Wis. *Circle 305 on reader service card.*



**FILL OUT AND MAIL
THIS COUPON TODAY!**

Quality Wood Products Since 1884

1217 FLORIDA ST. • MEMPHIS, TENN. 38106 • PH. 901/946-1671

Please send me the name and address of my nearest Wabash Dealer or Distributor.

I would like more information on ready-to-install Wabash all-wood Window Units, Patio Doors, and quality Louvered Products.

YOUR NAME _____

COMPANY _____

ADDRESS _____

CITY _____ STATE _____ ZIP _____



over 400,000
National Homes

SOLD



MORE FAMILIES LIVE
IN NATIONAL HOMES
THAN ANY OTHER HOMES
IN THE WORLD.



**proof that builders
sell National Homes
easier than any other
homes in the world.**

Why don't you get it all going? The total system that no builder alone can equal. The right homes for your market. The most advanced way to build. New two dimensional modular with more style variations . . . plus crane erection that trims on-site costs to the bone. Total financing—a one-stop service from construction financing through final mortgages. Total marketing—promotions and materials that have put more than 1,250 builders ahead in 38 states. We make it easier for you to do what a good builder should. Build better homes, sell faster, more profitably.

Clip the profit coupon. It'll bring a Man from National to help you make it really big.

Join the Profit-Builders.

National Homes Corporation
P.O. Box 680, Lafayette, Indiana 47902
Attn: Marketing Division

HH-12

YES! I'm interested in becoming a profit builder of National Homes. Send the Man from National.

Name _____

Company _____

Street _____

City _____ State _____ Zip _____

Phone _____ Area Code _____

I have built _____ homes in the last 12 months. I have
_____ lots. My typical selling price is \$ _____.

Appliances by  Hotpoint

The most neglected room in the house.

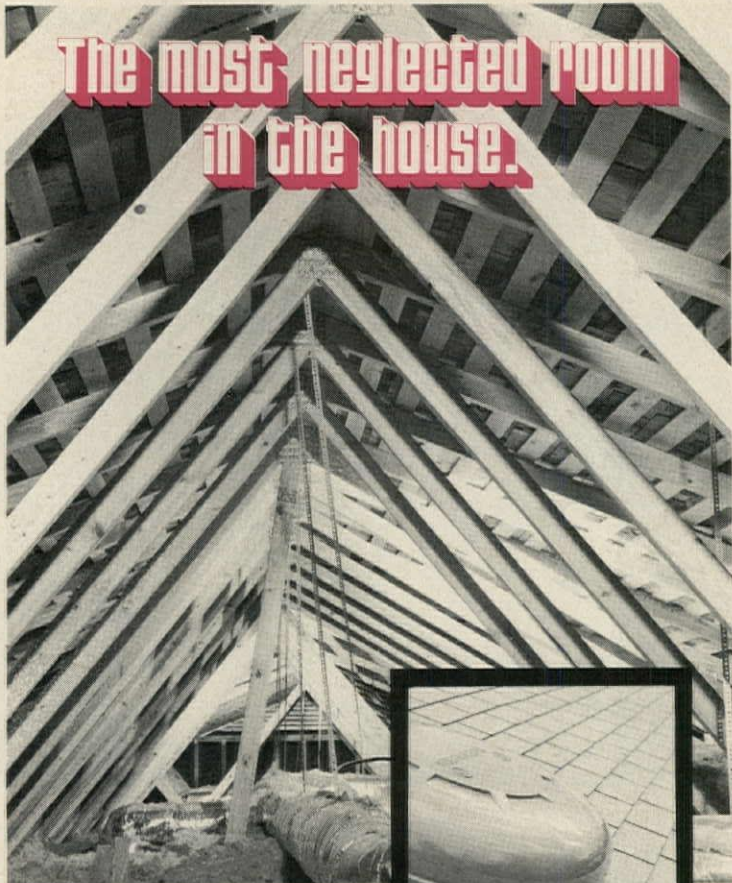

All that room in the attic. Seldom used or cared for. In the summer extreme temperatures build-up in attics substantially reducing the effectiveness of cooling units as attic insulation is only a time deterrent, not a barrier to heat; during the winter moisture build-up freezes in attics resulting in damage to building materials.

The Butler Attic Ventilation System is specifically designed to care for attics and crawl spaces year 'round by regulating climatic conditions within these areas.

The Vent-A-Matic unit, or the new Power Attic Vent, exhausts the superheated air that would otherwise be trapped under the roof.

The new Frost-Free Attic Control Unit is used in conjunction with either one of the power ventilators to remove moisture from attics or crawl spaces before it freezes on cold roof rafters.

To see all these new products on display, visit our booth #3437 at the National Association of Home Builders Show or write for our free brochures.

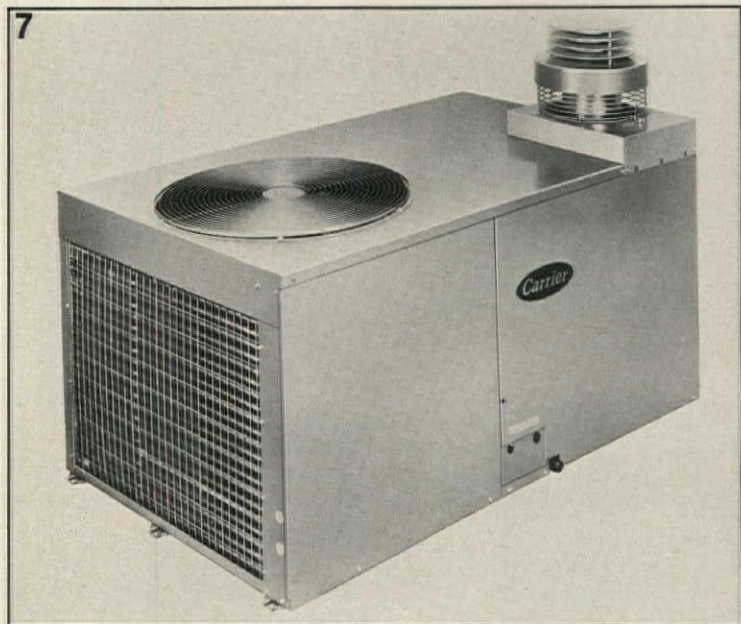
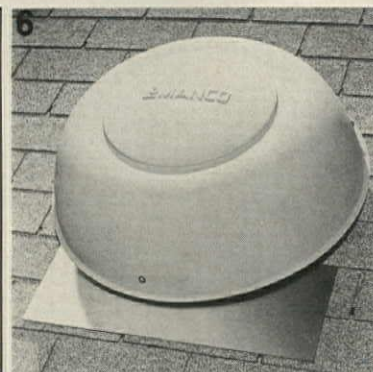
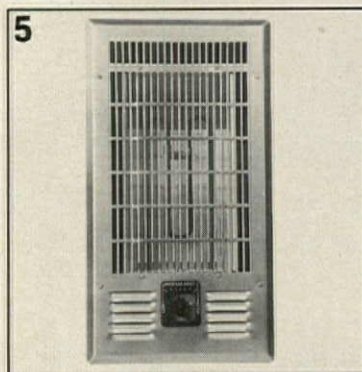
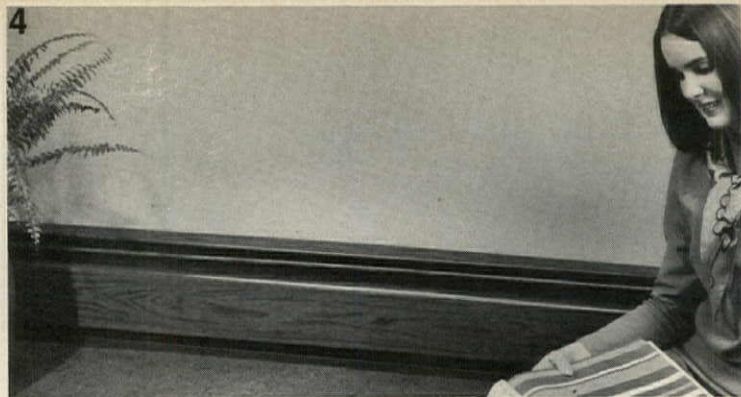
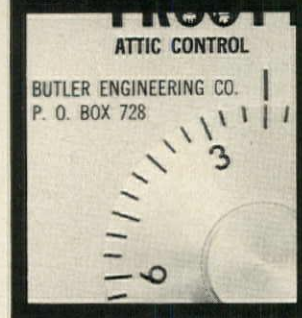
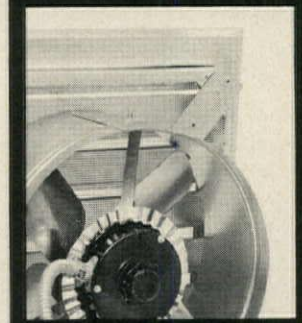

products: heating/cooling

4. Electric baseboard heaters, finished in woodgrained vinyl, complement any decor. Matching accessories include thermostat and corner sections and receptacle outlets. Heaters are fully-assembled and wired with integral end terminals. Snap-off front panels are for easy cleaning. Floorlevel, Baltimore, Md. *Circle 306 on reader service card.*

5. Wall-insert electric heater for hard-to-heat areas has a built-in thermostat with low, medium and high settings. "Calrod" heating element provides instant controlled heat. Unit with chrome-plated, or brushed-aluminum grille can be installed either surface-mounted or recessed in standard stud openings. Raywall, Johnson City, Tenn. *Circle 307 on reader service card.*

6. Power ventilator with thermostatic controls extracts excess attic heat, keeps entire house cooler and reduces air conditioning costs. An exclusive laminar flow design increases ventilating capabilities. Unit with a weather-resistant ABS plastic hood, can be installed in vertical, horizontal or pitched positions. Lomanco, Minneapolis, Minn. *Circle 308 on reader service card.*

7. Gas heating/electric cooling units are for on-the-ground or rooftop installation. System is available in five cooling capacities from 2 to 4 tons and seven heating sizes from 56,000 to 150,000 BTUH. Weather- and corrosion-resistant cabinet is painted soft-green to blend with the landscaping. Carrier, Syracuse, N.Y. *Circle 309 on reader service card.*

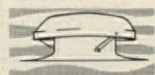

BUTLER ENGINEERING CO.

P.O. Box 728 • Mineral Wells, Texas 76067

CIRCLE 140 ON READER SERVICE CARD

Builders benefit from a strong distributor network.

Here's why:

- Instant service—deliveries as scheduled, on time from local inventory.
- Competitive prices—widest range of cabinets and styles for every housing requirement—with oak or vinyl cabinets in the newest styles and colors available to the industry.
- Simple, quick installation—Raygold cabinets go up fast.
- Clean, uncluttered interiors—uniform appearance on shelves, sides and backs.
- Variety—a wide selection of cabinet styles which fit a variety of budgets, all with a quality assurance which eliminates call-backs.

For all these reasons and more, you too can benefit from Raygold's distributor network. Let us tell you more about the distributors who can help you make kitchens that move houses.



**Boise Cascade
Raygold Division**

Winchester, Virginia 22601



NOT JUST ANOTHER PRETTY FACE

TUB-MASTER folding shower doors ARE beautiful! They enhance the appearance of any bath decor.

BUT, they're also SAFE, made from material that won't shatter . . . ever! AND, they're CONVENIENT, offering complete access to the tub or shower.

These features add many extra sales points to a home. Yet, probably even more important, TUB-MASTER folding shower doors meet ALL BUILDING AND SAFETY CODES.

Plus, they're the fastest installed shower doors in the industry. And saving time on the job means a lot in today's market.

Get the full story. Fill out the coupon below and mail to TUB-MASTER today.



TUB-MASTER Corp.
413 Virginia Drive
Orlando, Florida 32803

Name _____

Company _____

Title _____ Phone _____

Address _____

City _____ State _____ Zip _____

HH-1



products: tools/equipment

9. Rough-terrain forklift features a hydrostatic transmission that eliminates clutches and gear shifting. Vehicle is available in 4,000, 5,000 and 6,000-lb.-capacity models at heights up to 28'. Two control pedals on the left-hand side provide variable transmission speeds and directional change in both forward and reverse. Right-side pedal controls engine speed independent of transmission, providing for retention of full power for all working operations. J.I. Case, Racine, Wis. *Circle 326 on reader service card.*

10. Radial arm saw, with a giant 20" cut-back capacity, offers fast, easy cutting for all wood materials. Features of the "3553" include an automatic brake and low voltage controls with a pushbutton switch. Unit has

a cutting depth of 6-15/16", a ripping capacity of 48 3/4" and a master capacity to 23". Dewalt, Div. Black & Decker, Lancaster, Pa. *Circle 327 on reader service card.*

11. Lawn and garden tractors are available in four engine sizes: 8, 10, 12 and 14 hp, to meet any landscaping need. Units feature over 60 specialized attachments from mowers to golf-ball retrievers including: lawn-care equipment, gardening implements, spreader-seeder attachments, fogging and spraying devices, landscaping tools, maintenance aids and snow removal equipment. Shown is the 14 hp "Cub Cadet 149" with a maximum ground speed of 8 mph in forward, 4 mph in reverse. International Harvester, Chicago. *Circle 328 on reader service card.*

For 28 years, Thermopane has been the household word for insulating glass. It did its job in protecting your customers against the elements. Now comes Thermopane Xi. And LOF makes a good thing even better.

All Thermopane units with the GlasSeal® edge now feature inert gas between the panes instead of dry air. The 3/16" of inert gas gives the same insulating power as 3/8" of dry air.

Thermopane Xi helps give your customers' homes a more consistent level of temperature and

humidity, increasing their comfort . . . no matter how the weather rages outside.

There's less chance of windows fogging. And your customers save on heating bills—another comforting thought.

Thermopane Xi. A little more insulation from the people who started it all in the first place. Available only from Libbey-Owens-Ford Company, Toledo, Ohio 43695.

Making progress
in comfort



CIRCLE 143 ON READER SERVICE CARD

If it were your home, you'd choose Thermopane® Xi.™

Casement sash by Andersen Corp., Bayport, Minn.



The Alcoa Alumiframe building system has major code approvals.

It's official. The Alcoa® Alumiframe® building system has been given code approvals by the Building Officials and Code Administrators International, the International Congress of Building Officials and the Southern Building Code Congress. The Alumiframe system also meets FHA standards. For your convenience, here are the report numbers to check in your area:

BOCA: Report 449.
ICBO: Report 2574.
SBCC: Report 7203.
FHA: Bulletin 717.

The Alcoa Alumiframe building system is one answer to the highly fluctuating costs of conventional framing. It's economic residential framing that adds extra sales advantages to quality homes of any size, design or price range. The system offers: calendar year pricing, materials of uniform quality, on-site or factory fabrication options and flexibility for making on-site adjustments. For more information on the code-approved Alcoa Alumiframe system, write Aluminum Company of America, 1022-M Alcoa Building, Pittsburgh, Pa. 15219.

Alumiframe members are incombustible. They can't harbor or feed a fire.

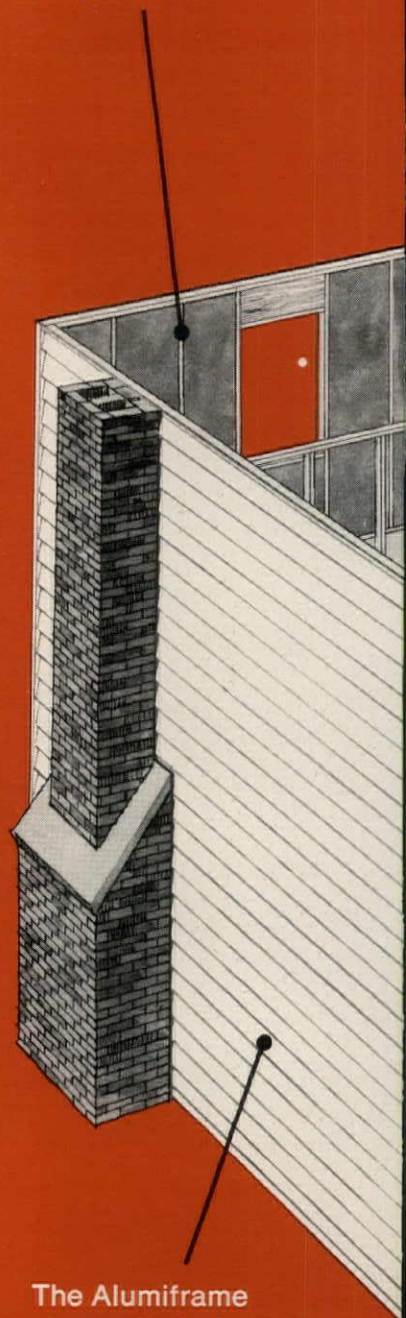

The Alumiframe system is designed to accept all standard interior and exterior finishing materials. It is compatible with all Alcoa building products: siding, soffit and fascia, gutters and downspouts, railing and trim.

Change for the better with
Alcoa Aluminum

 **ALCOA**

Alumiframe components can't be harmed by termites, other destructive insects or rodents. And they don't rot.

Alumiframe studs don't warp. Callbacks on dry wall applications are eliminated. There are no nails to pop and mar finished interiors.



Alumiframe construction requires no changes in building methods, tools or personnel.

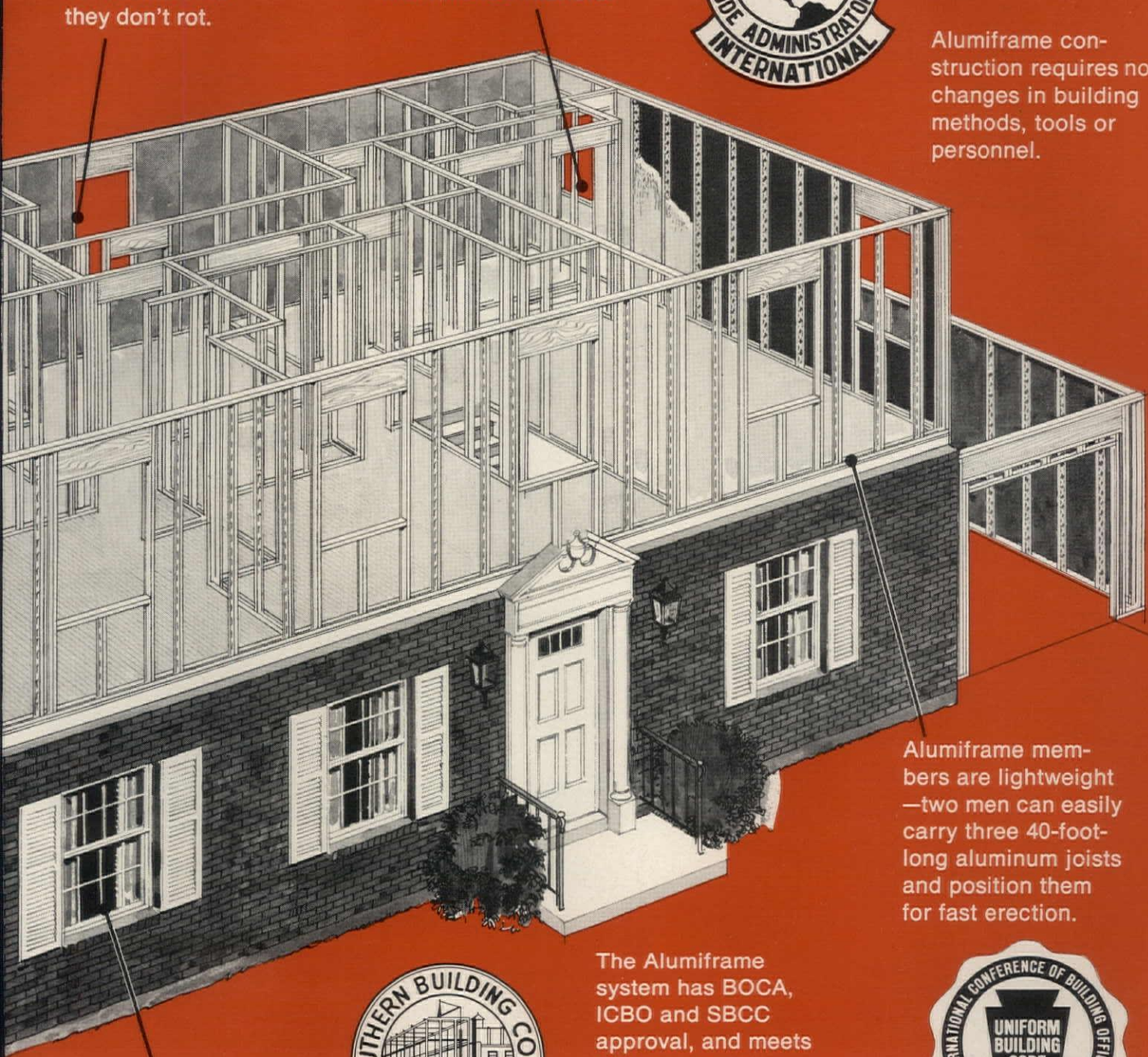

Alumiframe members are lightweight—two men can easily carry three 40-foot-long aluminum joists and position them for fast erection.

The Alumiframe system has BOCA, ICBO and SBCC approval, and meets FHA standards.



Alumiframe construction is dimensionally stable. There is no warping, swelling or shrinking, to cause doors and windows to stick.



The Alumiframe system includes columns, splice-free beams and joists, plates, studs, tee studs, integral windows and all accessories.

New Foam Extrusions

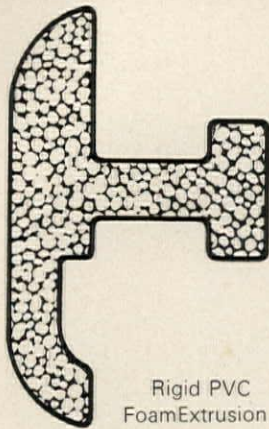

Rigid PVC
FoamExtrusion

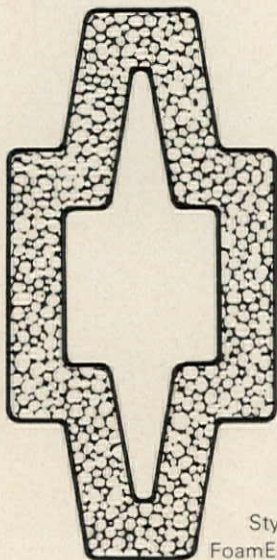

Styrene
FoamExtrusion

Now you can get all the advantages of rigid thermoplastic foams in a plastic profile extrusion. Our new FoamExtrusion capability includes three distinct foam profile systems that will let you add bulk and at the same time reduce material, weight, and costs: Rigid PVC FoamExtrusions, Styrene FoamExtrusions, and an exclusive extrusion-clad cast urethane foam system.

To learn the where, why and how of a FoamExtrusion solution to your application, write Crane Plastics, 2141 Fairwood Avenue, Columbus, Ohio 43216.



CranePlastics

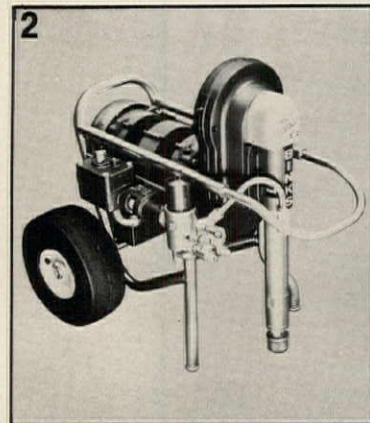

products: tools/equipment

1. Forklift, powered by diesel or gasoline engine, features a hydraulically actuated reversing transmission and hydrostatic power steering. Lifting capacities of the "JD480-A" are 1,000 lbs. at 28' and 6,000 lbs. at 14'. Three available masts—14', 21' and 28'—tilt 19° forward and 9° backward. Deere, Moline, Ill. *Circle 318 on reader service card.*

2. Electric airless pump is capable of feeding two independent sprayguns at pressures to 3,000 psi. Compact wheel-mounted "Hornet" has outlet ball valves which permit independent or simultaneous operation of the two spray-guns. Unit can pump directly from 5 gal. pails or be equipped to siphon from up to 55 gal. tanks. Binks, Franklin Park, Ill. *Circle 319 on reader service card.*

3. Automatic nailer features a tilted fastener-magazine that permits access to hard-to-reach places. The lightweight "SN-II" drives 6d-10d flat-head construction nails of 11-, 11½- and 13-gauge. Special safety-trip minimizes accidents. A snap-open guide-body provides for easy maintenance while eliminating most time losses from jamming. Senco, Cincinnati. *Circle 320 on reader service card.*

4. Compact loader is engineered for rough and soggy terrain. "Scatback 430" features articulated steering with four-way pivot and four-wheel hydrastatic drive with limited slip differential. Park/emergency brake and neutral safety starter are standard. Davis, Wichita, Kan. *Circle 321 on reader service card.*

Bill—
 Have you checked
 on Crawford flush
 garage doors?
 Any advantages? Any savings?
 C.M.

"Ahead of you, C.M.! Talked to Crawford distributor yesterday. Their flush door looks good. It has plenty of advantages -- the price is more than right and it can be easily customized. I've sketched a few ideas we might use on the new Northwood Meadows project. It might be time to switch to a flush door. What do you think?"

Bill

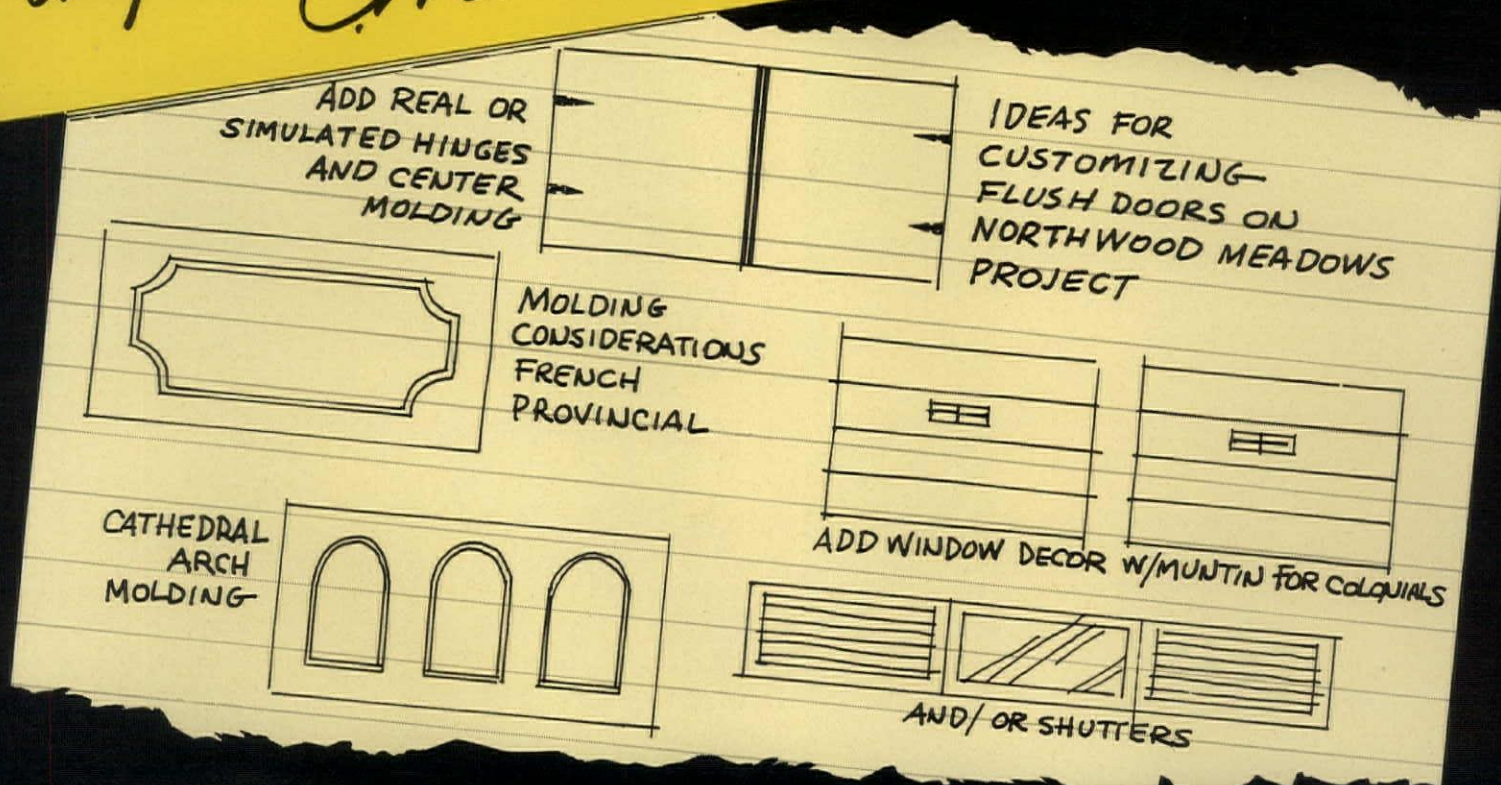

Yes, Bill, you won't go wrong boosting the Crawford Model 466 Flush Garage Door. C.M. will recognize you're on top of things when you and your Crawford distributor show him samples and go into detail about these benefits. . .

- Unitized Construction.
- Blends With Any Architectural Design.
- Easy To Add Inexpensive Customized Decor.
- Flat Surface — Easy To Paint.
- Sound Deadening — Good For Over The Garage Bedrooms.
- Minimum Heat Loss.
- No Warping, Twisting, Crowning, Sagging, Separating, Cracking, Splitting, Checking or Delamination.
- No Water Trapping or Moisture Leaks.
- Unlimited Glass Options and
- Competitively Priced!

100-125 LB. PER SQ. IN. PRESSURE APPLIED UNDER CONTROLLED ENVIRONMENTAL CONDITIONS FOR FULL BONDING PERIOD

TEMPERED MARVEL-LIFE HARDBOARD FACING

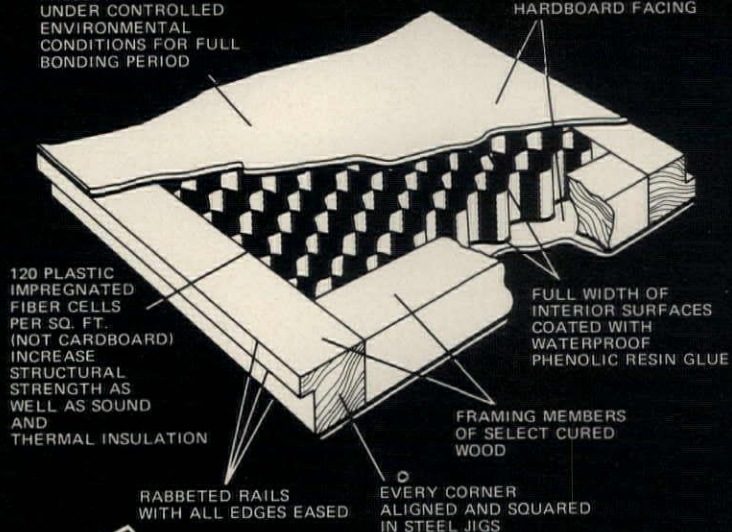

120 PLASTIC IMPREGNATED FIBER CELLS PER SQ. FT. (NOT CARDBOARD) INCREASE STRUCTURAL STRENGTH AS WELL AS SOUND AND THERMAL INSULATION

FULL WIDTH OF INTERIOR SURFACES COATED WITH WATERPROOF PHENOLIC RESIN GLUE

RABBETED RAILS WITH ALL EDGES EASED

EVERY CORNER ALIGNED AND SQUARED IN STEEL JIGS

FRAMING MEMBERS OF SELECT CURED WOOD



CRAWFORD

Division of THE CELOTEX CORPORATION

A subsidiary of **Jim Walter** CORPORATION

Join C.M. and Bill! Contact your local Crawford Door distributor (check your Yellow Pages) and see for yourself how the Crawford Flush Garage Door can fit into your program — a low-priced door with unlimited design possibilities. Or write. Crawford Door • 4270 High Street • Ecorse, Michigan 48228 • Area Code 313/383-5000

Save time & cost on these and many other jobs with Duo-Fast Staplers and Nailers



TOE NAILING studs to plates is fast and accurate with the versatile CN-137 Nailer...the only nailer that drives 6d common thru 16d sinkers. Great for countless nailing tasks on construction of all kinds.



SHEATHING goes on fast and tight with a S-763 Staple Nailer. Ideal for plywood and fibreboard sheathing, plywood subfloor and roof deck. The long, heavy-duty staples used for these jobs are FHA approved.



SOFFITS install easier and faster with the new, light-weight KN-1840 which drives heavy, narrow-crown, galvanized staples. The narrow crowns are inconspicuous and resist pull-thru. Has many applications in building.



FINISHING is the job of the FN-83 Finish Nailer. Interior trim goes on in a hurry. The Brad Nailer is used widely to speed up installation of paneling, using brads with heads colored to match the surface.

ADD the Duo-Fast Gun Tackers, Hammer Tackers and Strike Tackers for insulation, building papers, ceiling tile, underlayment...and watch production climb while costs tumble.

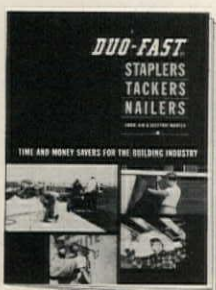

SEND NOW for free copy of Bulletin FT-26 and demonstration of these cost cutters.

DUO-FAST FASTENER CORPORATION,
3702 River Road
Franklin Park, IL 60131

DUO-FAST EVERYTHING FOR STAPLING NAILING



**the grandest
entrance
you'll ever
pass through.
steel...naturally**

PERMA-DOOR steel entrance units are being demanded by home and apartment builders. Perma-Doors are insulated, forever stable in their dimensions, easy to install, and are created with unlimited design variations to meet individual tastes. FHA accepted and UL listed. Phone or write for your details now.

PERMA-DOOR

Division of **Steelcraft** Manufacturing Co.,
An American-Standard Company
9017 Blue Ash Rd.,
Cincinnati, Ohio 45242, Area 513 - 791-8800.

Visit us at Booth #3100

CIRCLE 149 ON READER SERVICE CARD

H&H DECEMBER 1972 149

HELO SAUNA

World's largest selling authentic Finnish Saunas.



Built by the people who discovered sauna 2000 years ago. The hottest item in the building industry is the in-home sauna. HELO offers pre-fabricated models with Helo heaters that can be installed virtually anywhere. Saunas in every size for every need...from small closet or bathroom saunas to large, luxurious cabana models. The widest variety of superb UL listed heaters in the U.S.A. Handrubbed red-wood rooms. Authentic "Konno" rock heating units with the largest rock capacity of all sauna heaters, for controlled, even heat. Automatic control panels. Custom or pre-fab—all at healthy, down-to-earth prices.

SPECIAL! 4' x 4' x 6'6" high pre-wired sauna pre-fab with 110 volt "plug-in" heater. Floor, 2 benches, guard rail around heater, vision window, pre-wired light, and UL listed heater. Now only: \$375.00 to builders. Incredibly priced. Assembles in less than 30 minutes.

HELO MARKETING INC.

27 Westerly Lane, Thornwood, N.Y. 10594 (914) 769-4044 • (212) 892-6805
Saunas from Finland since 1919

CIRCLE 113 ON READER SERVICE CARD

So who says you just can't get Good Help anymore?

Not us. Because Shelter is Good Help.

Shelter Mortgage Corporation can give you good help that you didn't even know existed. For builders, developers and other lenders, we provide land acquisition, development, construction and permanent loans for both conventional and FHA projects. Plus the advantages of experienced advisors, rapid service and quick disbursements.

Government programs are no mystery to SMC, and our experienced people will be glad to discuss the special advantages of HUD programs and how to put them to work for you. SMC will analyze your project, develop your HUD application, process any changes in your project through HUD, and assist in the closing of all financial arrangements.

Put SMC to work for you. Call Shelter Mortgage Corporation or stop at our booth (#2278). We love to answer questions.

You can get Good Help anymore.



shelter mortgage corporation

Home office: 1550 East 78th St., Minneapolis, Minn. 55423
Phone 612/861-7261

Regional office: 1825 K St., NW, Washington, D.C. 20006
Phone 202/785-3811

5

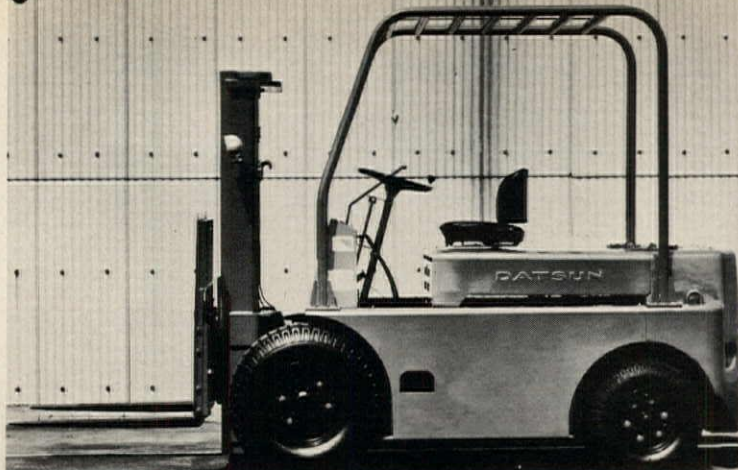

6

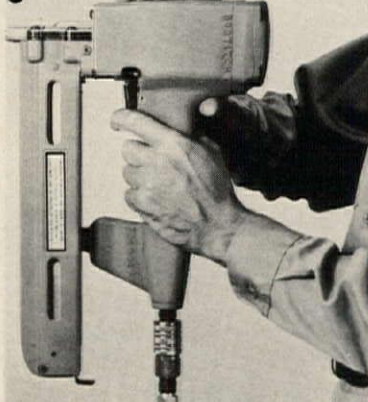

7

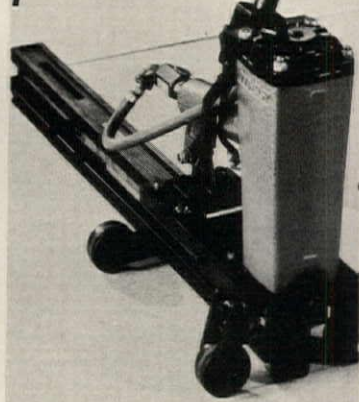

8



products: tools/equipment

5. Pneumatic tire forklift truck has automatic transmission and power steering as standard equipment. Vehicle is available in 4,000-, 6,500- and 8,000-lb.-capacity models. Diesel engines are optional on all units. The two larger trucks feature heavy-duty channel masts for maximum strength. Datsun, Mayfield, Ky. *Circle 322 on reader service card.*

6. Pneumatic staplers and nailers feature quick cycling, simple valving and low air pressure operation. Tool, with narrow nose and good size overhang, has a low profile pistol-grip handle for easy maneuverability. Lightness of weight and superior balance minimize operator fatigue. A high capacity magazine is featured. Bostitch, East Greenwich, R.I. *Circle 323 on reader service card.*

7. Rolling staple nailer permits installation of particleboard and plywood subflooring without operator fatigue. "SP-182" is trigger-actuated from an upright or walking position via a four-position extension handle. Automatic or single-shot firing mechanism drives staples as unit is rolled on predetermined lines. Duo-Fast, Franklin Park, Ill. *Circle 324 on reader service card.*

8. Tractor, backhoe, loader unit is operated by a 50hp diesel engine. The "3550" has an optional heavy-duty backhoe with a maximum digging depth of 15'4" and reach of 21'8". Standard loader with a height of 10½' has a 3,050 lb. lift capacity. Vehicle is also available with a gasoline engine. Ford, Troy, Mich. *Circle 325 on reader service card.*

APPLY FASTER...

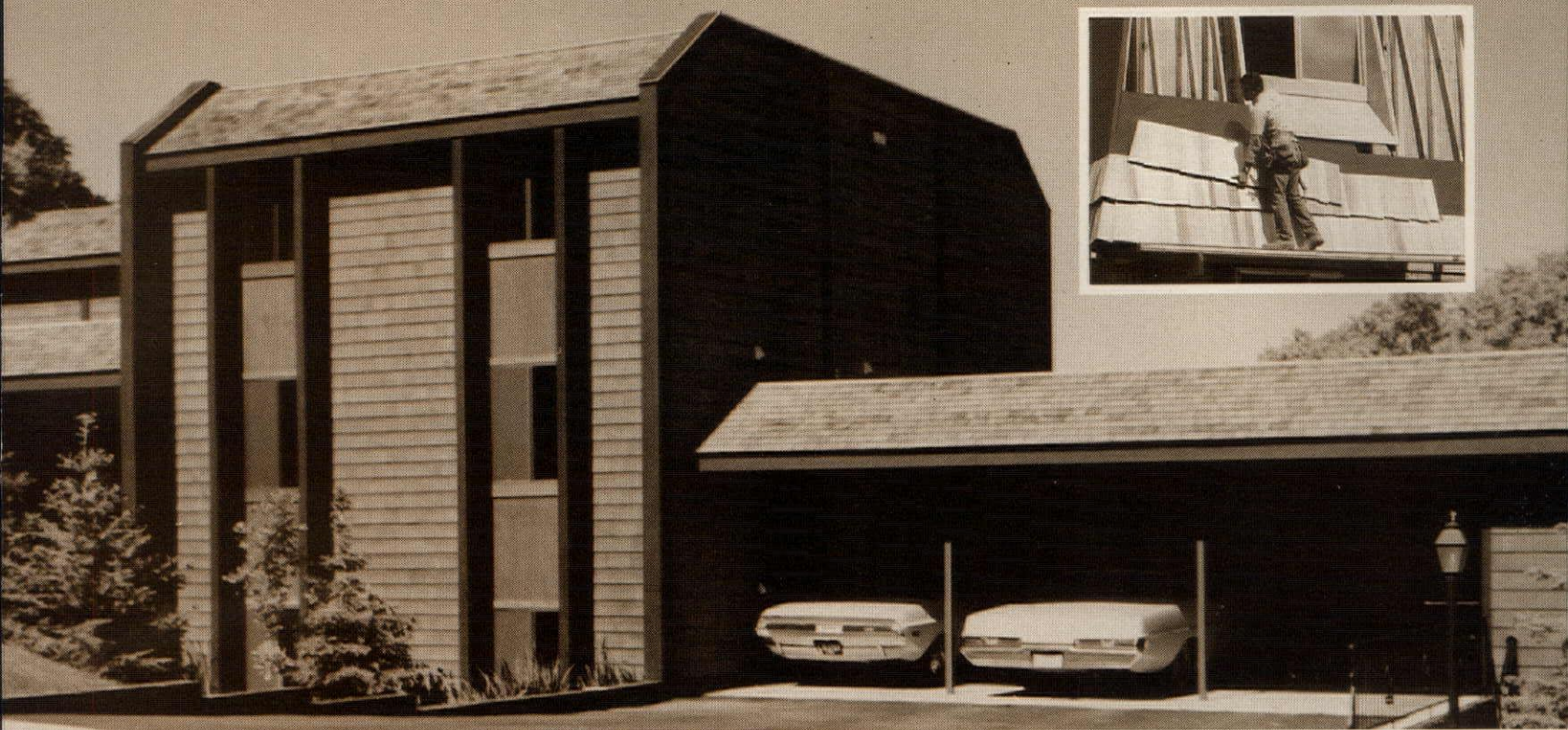

ShakerTown® 8-FOOT SHAKE AND SHINGLE PANELS

LONGER LIFE

(Less Maintenance)

Cedar shakes and shingles are old standbys for effective protection for homes and apartments. Now they have taken on a new appearance both in textures and size. ShakerTown manufactures shakes and shingles into an 8-foot panel that can be applied right over studs for a much faster application without skilled help. Ageless Western Red Cedar is beautiful and now with the Barn, Shake, Shingle and Rough Sawn textures from ShakerTown, you have a choice of a variety of textures to harmonize or complement your building design. ShakerTown manufactures the only complete line of shakes and shingles in panels for sidewalls and roofs.

See Our Booth No. 2569 at the NAHB Show.

ShakerTown®

FIRST NAME IN CEDAR SHAKE PANELS

Write for a detailed brochure...
SHAKERTOWN CORPORATION
DEPT. HH-12
4416 LEE ROAD
CLEVELAND, OHIO 44128

In Canada
BESTWOOD INDUSTRIES, LTD.
P.O. BOX 2042
VANCOUVER 3, B.C.

FOR FURTHER
INFORMATION
SEE OUR
CATALOG IN
SWEET'S
OR WRITE FOR COPY



Specify Alsons ...The All Purpose Shower



The quality shower with the quality look. Better styling with practical convenience. Largest selection of models to choose from ... to fit every need ... every project budget. Write for detailed color brochure from Alsons ... the Personal Shower specialists.

alsons
PRODUCTS CORPORATION

Somerset, Mich. 49281
Covina, Calif. 91723
Canada: Waltec Industries

CIRCLE 114 ON READER SERVICE CARD

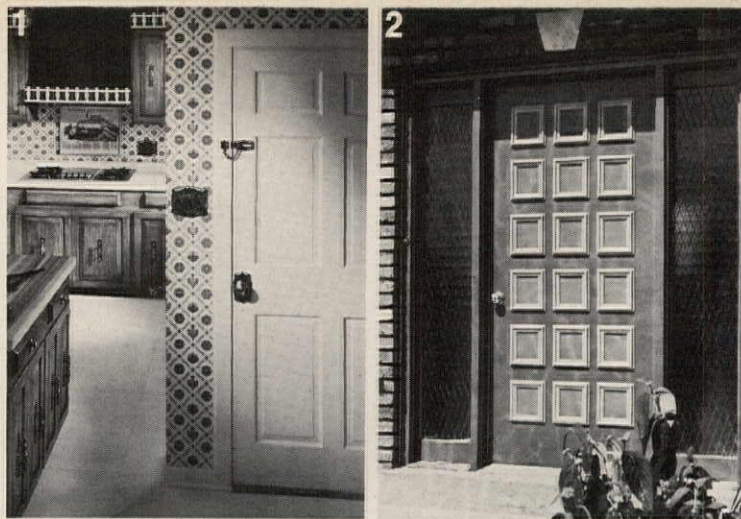

products: doors/windows

1. Matching hardware, in an early New England design, allows a continuous decorating theme to be used throughout the home or apartment. Cabinetware, security guard, passage knobs, switchplates, towel rings and bar are part of the 37-item "Carriage House" collection. Matching bedroom and bath hardware is also included. A similar set, "Monterey", features a Moorish or Mediterranean motif. Both collections are offered in two finishes—antique English or antique silver. Amerock, Rockford, Ill. *Circle 329 on reader service card.*

2. Steel entrance doors keep interiors frost-free without a storm door, even when exposed to -60°. The insulating quality is furnished by a polyurethane foam and honeycomb core. Self-adjusting vinyl door bottom

provides maximum sealing between door and sill. Frame is installed with "Perma-seal" vinyl weatherstripping to prevent leakage. "Perma-Door" comes in: Williamsburg blue, white, sun gold, slate black, olive green and colonial red. Perma-Door, Steelcraft, Cincinnati. *Circle 330 on reader service card.*

3. Bi-fold closet doors of high-impact polystyrene are fitted with virloa-wood stiffer braces at the back of each panel. Authentic woodgrain look is molded into panel faces. Although the low-lustre, off-white finish never needs painting, acrylic or latex paint may be used if color is desired. Panels come hinged together with hardware necessary for installation. M&M Products, Richmond, Ind. *Circle 335 on reader service card.*

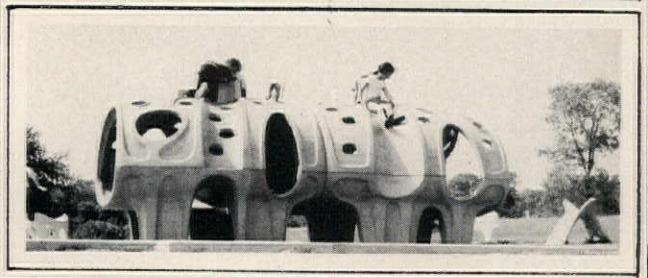

SCULPTURE FOR PLAY
PRECAST REINFORCED CONCRETE PLAY
SCULPTURES AND OUTDOOR FURNITURE
SAFE. LOW MAINTENANCE. WE DELIVER.

FORM INCORPORATED
BOX K, SOUTH LYON, MICH. 48178

CIRCLE 152 ON READER SERVICE CARD

12 NEW FEATURES EQUAL ONE GREAT ELECTRIC BASEBOARD

Snap-off cover, ribbed
for extra strength

plus junction boxes at
both ends

plus knockouts at ends,
back, bottom

plus new baffle for
cool top

plus cool-air slots for
thermostat

plus new all-aluminum
heating element

plus new airflow pattern
for clean walls

plus thermal sensor
safety cut-off

plus floating suspension
for quiet operation

plus installation slots for
screws (no heat waste)

plus new snap-action
thermostat at either end

plus new fast-mount
for thermostat



New Hunter Heatmaster

Obviously, Hunter's new Heatmaster convection baseboard is all-new, inside and out. Yet it still has the features you count on. Dependable performance. The popular goes-with-anything beige finish. The choice of unit or wall thermostat. The rugged heavy-gauge steel construction. The fast warm-up and economical operation. The wide variety of models—42 in seven lengths—single, dual and triple rated. Send coupon for further information. 



Hunter Division, Robbins & Myers, Inc.
2500 Frisco Ave., Memphis, Tenn. 38114

Please send full information on new
Hunter Heatmaster Electric Baseboards.

Name _____

Company _____

Address _____

City _____ State _____ Zip _____

Hunter has the complete line in electric heat

HH



Morgan announces a new horizon

The look, the feel, the beauty
of wood and something more
...the permanence of
Structured Polymer



Imagine a material that offers all the best qualities of wood: the look, the solid feel, the warm appearance. Then imagine a perfect structural material which offers dimensional stability, high material density, and proven time and wear resistance.

Now combine these qualities. The result: Structured Polymer by Morgan.

Structured Polymer is a unique material which offers a variety of advantages to building construction. Exceptional durability. Stability. Rich, warm appearance. Impact resistance.

Sound too good to be true? It has been proven! In products outside the building construction field, Structured Polymer has met, or exceeded, the requirements of a variety of products. This fact prompted Morgan to adapt Structured Polymer to bi-fold doors and shutters. Extensive testing and analysis have proved us right.



in building products

Window and door shutters of Structured Polymer

A dramatic dimension in distinctive beauty and exceptional durability. Each shutter is a solid, one-piece unit . . . no glued or nailed sections to come loose. No reinforcement needed. New, exclusive mounting brackets permit quick, easy installation on all types of exterior surfaces.

Available in nine different window sizes, or as a handsome door shutter. Long lasting solvent welded Acrylic finish in black or white . . . suitable for painting if desired.

Dimensionally stable . . . won't warp, twist or shrink. Structurally strong . . . won't break or splinter under normal usage. Impact resistant . . . won't chip, kink or dent. Low installed costs are just one more reason to add the advantages of Morgan Window and Door Shutters to your next building project.

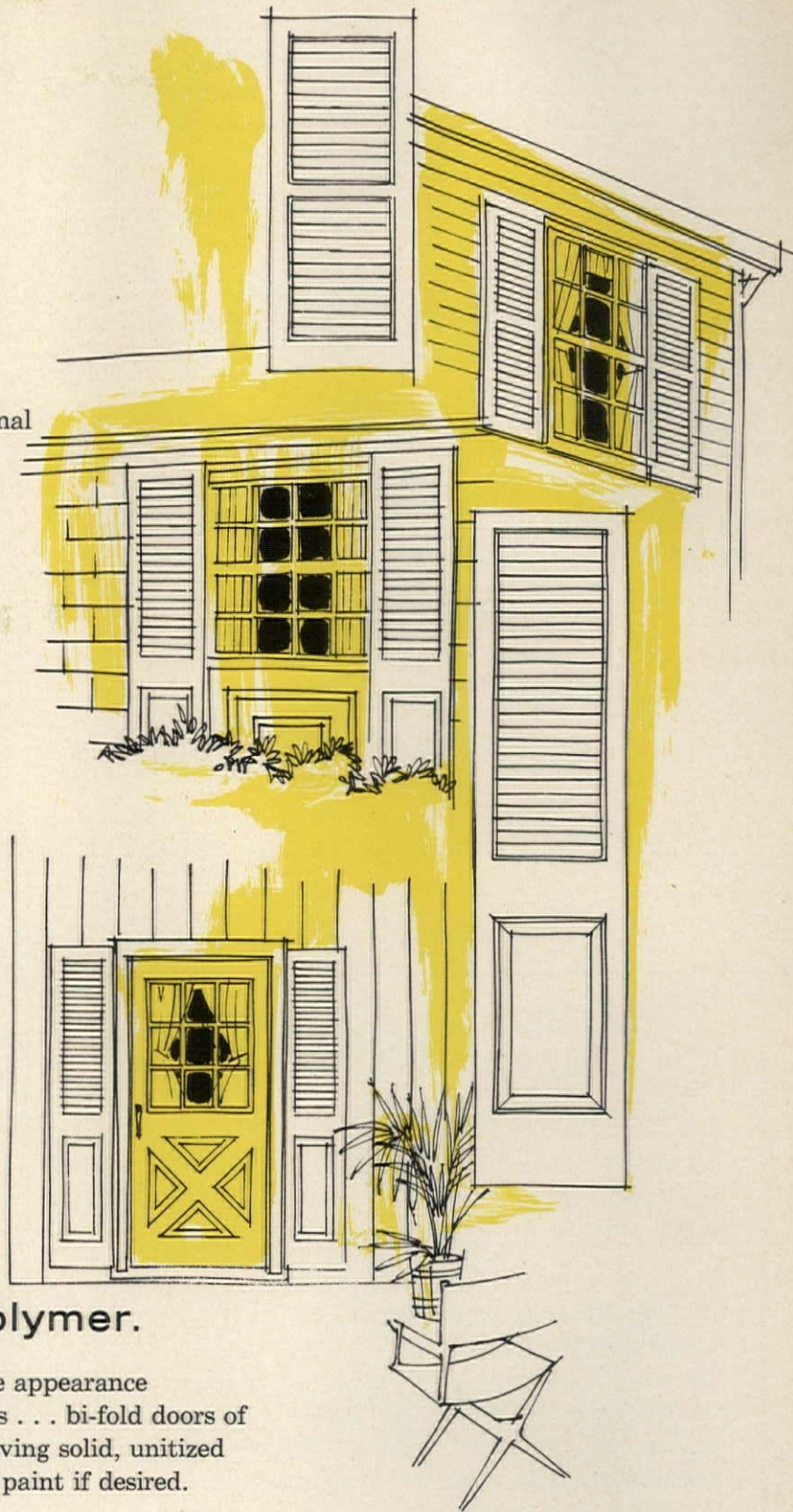

Bi-fold doors of Structured Polymer.

Also available from Morgan . . . with the same attractive appearance and lasting qualities offered by window and door shutters . . . bi-fold doors of Structured Polymer. Your choice of two designs, each having solid, unitized construction. White factory prime finish. Install as is, or paint if desired.



WRITE FOR FREE TECHNICAL LITERATURE ON STRUCTURED POLYMER
OR SEE US IN BOOTH NO. 2478, NAHB SHOW



MORGAN *Company* • Oshkosh, Wisconsin
54901



510 NAILS A MINUTE:

THE KLINCHER GOES AT A FAST CLIP

Panel-Clip's Klincher Truss Press and Clips are the most economical fastening system for trusses on the market today. The lease cost of the Klincher and Jig is less than \$2.00 a day, and that includes our free design service (Klincher and Jig can be leased for only \$40.26 per month or purchased for \$1,184.00).

If you're a growing truss fabricator, you'll appreciate MAXIMUM SPEED—MAXIMUM PROFIT—MINIMUM INVESTMENT.

For complete information, write:

The Panel-Clip Co.

BOX 423, FARMINGTON, MICHIGAN 48024

CIRCLE 115 ON READER SERVICE CARD

THE MOST USEFUL HOIST

LADDER PLATFORM HOIST FOR BUILDING MATERIALS

Plywood, Wallboard, Lumber,
Roofing, Shingles, Brick, Block,
Mortar, Crated Fixtures

Designed for easy portability yet rugged enough to handle tons of material a day to heights up to 44 feet.

Handles 400 lb. loads at 110 ft. per min. on heavy duty sectional ladders with electric or gasoline powered winch.

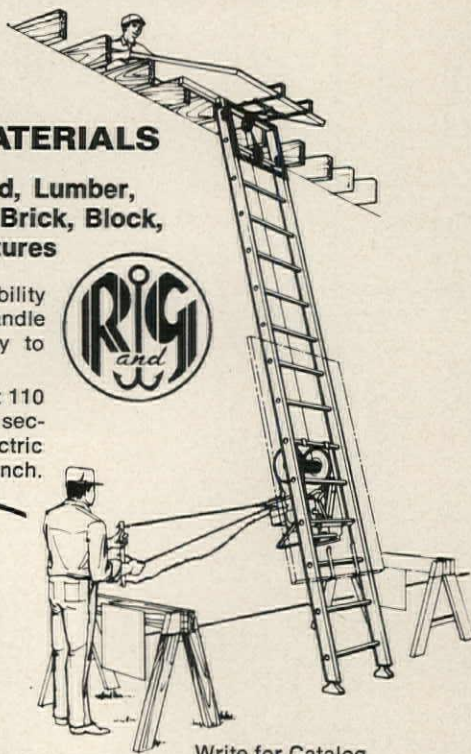

Write for Catalog.

**REIMANN
& GEORGER, INC.**

1853 Harlem Road, P.O. Box 681
Buffalo, New York 14240

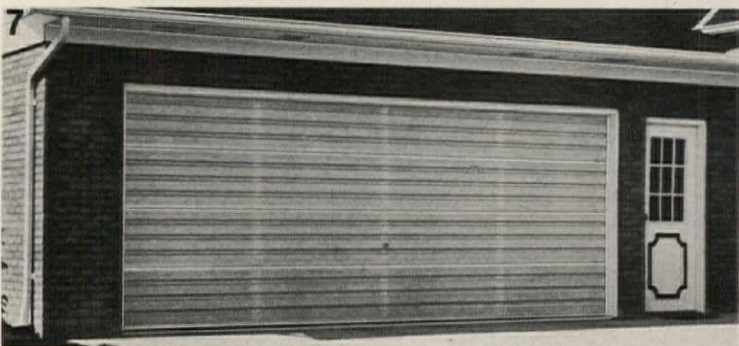
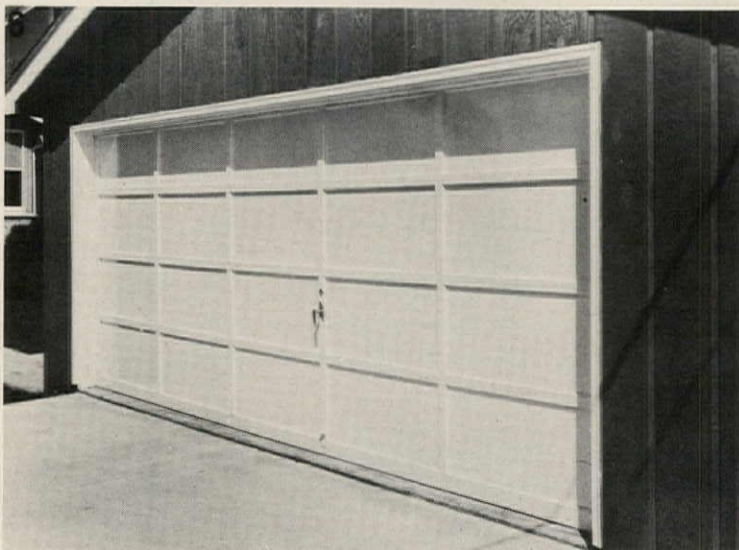
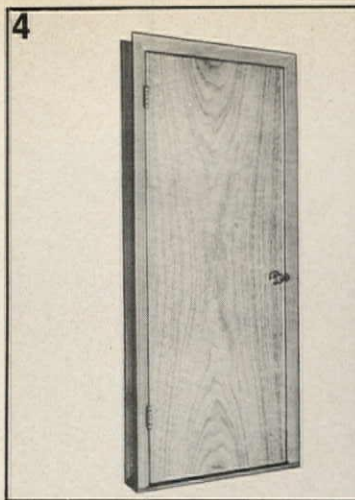

products: doors/windows

4. Pre-hung door, with a walnut finish, eliminates on-the-job painting or staining. Units include lauan door and jamb and casing. The latter can be installed over painted walls, using putty to cover nail holes. Morgan-Wightman Supply, St. Louis, Mo. Circle 333 on reader service card.

eliminates warpage, grain-raise, splitting and dry rot. "Rebel", which features pre-drilled wood stiles and muntins, adjustable bottom rail and factory-installed astragal, comes in standard double and single widths in ranch and colonial styles. Raynor Manufacturing, Dixon, Ill. Circle 331 on reader service card.

5. Solid rosewood entrance door is handcarved on both sides to provide a decorative accent both inside and out. "Westminster", shown, is available with matching side panels. Three other rosewood doors are offered in the "Elegant" line. Elegant Entries Unlimited, Worcester, Mass. Circle 334 on reader service card.

7. Four-section garage door is a combination of lightweight translucent fiber glass and oven-tempered extruded aluminum. The nylon reinforced panels transmit up to 85% of available light. "TufLite" doors come prefinished in pebble-like tan, green or white for either single- or double-width openings and in a full range of sizes. Units have galvanized steel hardware. Clopay, Cincinnati. Circle 332 on reader service card.

6. Residential garage door combines wood paneling with exclusively designed aluminum rails. The latter

BUILD LASTING SATISFACTION



When residential building is "up," most builders keep busy. When the market is down, prospective buyers are much more critical of styling, of components and particularly of builder reputations.

Your reputation, tomorrow, depends on the homes you build today. They will look better and live better with R•O•W trouble-free quality wood windows and patio doors. Owners will be more comfortable, yet they will save on heating and cooling. Satisfied owners talk a lot. So do the unhappy ones.

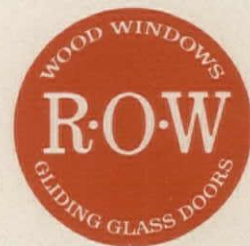

R•O•W SALES CO. 1337 E. Academy, Ferndale, Michigan 48220

See our full line of windows and patio doors at N.A.H.B. Booth #2350

At last! A truly low cost, quality garage door!

- A totally new quality door, not just a "stripped down" version!
- Exclusive new construction concept reduces costs—up to 21%!
- Variety of styles and sizes available without a sacrifice in savings.
- Special construction features reduce installation time, increase your profits in addition to initial low cost.
- Be among the first to offer this great new quality door at a substantially lower price.

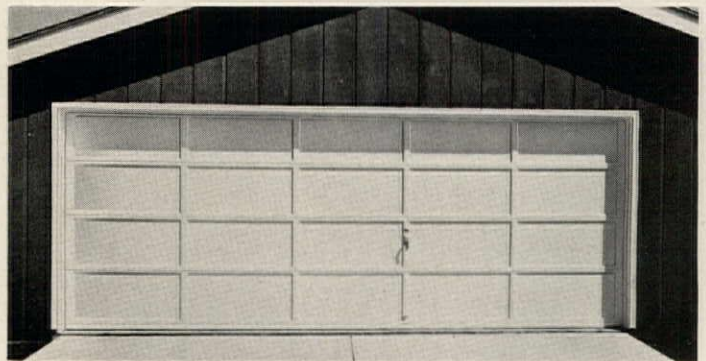

**See why Raynor
calls it the
"Rebel"!**



COUPON ANSWERED WITHIN 48 HOURS

RAYNOR®

To get in on these savings
contact your nearest Raynor distributor or write:
DEPT. HH Raynor Mfg. Co., Dixon, Illinois 61021

Name _____

Firm _____

Address _____

City _____

State _____

Zip _____

Certigroove shakes have a lot of side advantages.



Red cedar Certigroove shakes actually cost less to buy and apply than other commonly used sidewall materials. Yet their value goes far beyond price.

Grooved sidewall shakes are handsome. Their rich texture and appealing shadow line add elegance to any home. And they're available natural, prime-coated, or factory-stained in a wide variety of colors.

Sidewall shakes are practical, too. They're applied double-coursed, promoting superior insulative qualities. Properly maintained, they'll last for decades. They'll even withstand hurricane winds.

Ask your lumber dealer for Certigroove sidewall shakes. For additional details, write: Red Cedar Shingle & Handsplit Shake Bureau, 5510 White Building, Seattle, Wa. 98101.

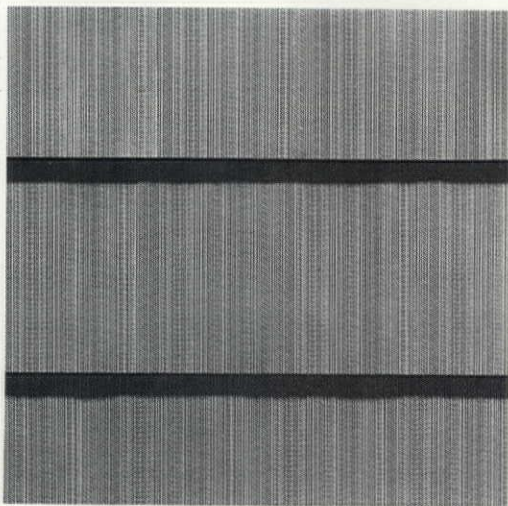

Red Cedar Shingle & Handsplit Shake Bureau

One of a series presented by members of the American Wood Council.

New and important books from McGraw-Hill

MANUAL OF BUILT-UP ROOF SYSTEMS



By **C. W. Griffin** for The American Institute of Architects. The first single-volume source of facts, figures, and basic theories on built-up roof systems, this book discusses in detail all components—structural deck, vapor barrier, thermal insulation, membrane (including the new elastomeric membrane materials), and flashing. It reports the latest views on vapor barriers and examines new roofing specifications using coated base sheets. The author also analyzes the roof as a *system*, exploring the complex interaction among its components.

256 pages, illustrated, \$14.50

LANDSCAPE ARCHITECTURE: An Ecological Approach to Environmental Planning

By **John Ormsbee Simonds**. This comprehensive handbook on environmental planning has established itself as the basic reference for architects, engineers, and planners. Beautifully written and superbly illustrated, it presents an articulate approach to the intelligent development of the landscape that surrounds us. The author, an eminent authority on environmental planning, outlines and analyzes the complete land-planning process, examining all of the factors involved in sound, meaningful planning. Hundreds of photographs and drawings reinforce the thoughtful proposals for achieving a more healthful and sensible living environment.

244 pages, illustrated, \$16.00

BUILDING CONSTRUCTION HANDBOOK, Second Edition



Editor-in-Chief, Frederick S. Merritt. In this one comprehensive handbook covering every major phase of building design and construction, you have reliable facts, figures, and methods always at your fingertips. Composed of 29 sections written by 25 authorities, this revised and expanded edition develops each topic to reflect latest developments in the industry. Several sections have been completely rewritten to reflect the most recent developments in their fields. This key to the many-sided picture of building tells you *all* in understandable terms.

842 pages, illustrated, \$23.75

THE ART OF HOME LANDSCAPING

By **Garrett Eckbo**. Don't make costly mistakes in basic landscaping! This practical book explains how to plan, design, and build your own home landscape, how to substitute pencil work for needless shovel work, and how to do it in easy stages. There are no "pat," stereotyped answers here; instead, you get hundreds of working answers to specific problems—such as how to draw plans, how to use surfacing, how to provide drainage, how *and* what to plant, how to screen small lots, how to build shelters, etc. Written by one of America's foremost landscape architects, this book shows you exactly what to do to achieve beautiful, livable outdoor space around your home.

278 pages, illustrated, \$7.95

SYSTEMS MANAGEMENT TECHNIQUES for Builders and Contractors

By **Paul G. Gill**. Want to apply systems management techniques in your firm? This volume provides builders and contractors with practical, proven guidelines for using the approach in their own companies. Through the use of charts, illustrations, forms, and job descriptions, it shows you how to structure, manage, and control all your operations under one management system. Practical and down to earth, the book shows you how to apply a proven management system previously used only in military and space programs.

210 pages, illustrated, \$15.00

PLAN READING FOR HOME BUILDERS, Second Edition



By **J. Ralph Dalzell**; revised by **Frederick S. Merritt**. This handsomely illustrated book is invaluable to everyone who wants to learn how to read plans for new construction or remodeling. Completely updated, this new edition offers a simple, progressive explanation of elevations, plans, sections, details, and the relationships between views that leads to interpretation of three complete sets of working drawings. While examples in the book apply to home-building, the basic principles are applicable to all types of construction.

172 pages, illustrated, \$8.95

DESIGN AND PRODUCTION OF HOUSES

By **Burnham Kelly**. Here is a penetrating analysis of the critical problems and vast potentials of the housing industry. Leading authorities in every major area of the field today examine the entire process by which single new homes are designed and produced, and suggest courses of action in which modern methods, materials, and designs can work for the house buyer *and* the general public as a whole.

428 pages, illustrated, \$12.50

LEGAL PITFALLS in Architecture, Engineering, and Building Construction



By **Nathan Walker** and **Theodor K. Rohdenburg**. "Ignorance of the law is no excuse"—and yet the practicing architect, engineer, or building contractor cannot possibly be conversant with the entire civil law applicable to his profession. The next best thing is to be aware of the common legal pitfalls that have ensnared others—and to avoid them. The co-authors are an architect and a lawyer, and the book reflects their knowledge and experience in their respective fields.

270 pages, \$14.00

TIMBER DESIGN AND CONSTRUCTION HANDBOOK

Prepared by **Timber Engineering Company**. In this book, 25 leading specialists show you how to obtain maximum efficiency and economy in the design and construction of wood structures. Authoritative in every way, this master handbook provides all essential information needed to develop and construct the best wood structures. It fully covers fundamental characteristics of wood, preliminary design considerations, design details, fabrication, and erection.

662 pages, 360 illustrations, \$17.50

SIMPLIFIED CONCRETE MASONRY PLANNING AND BUILDING, 2nd Ed.



By **J. Ralph Dalzell**; revised by **Frederick S. Merritt**. This updated edition—with new illustrations—of a highly regarded guide for novice masons reflects the changes that have occurred in the construction industry since the original edition was published. The author takes you, step by step, through every type of concrete job in home building—from foundations, walls, and floors to driveways and terraces—describing each so that even readers with no experience can follow directions.

370 pages, illustrated, \$8.95

10 DAYS' FREE EXAMINATION

McGRAW-HILL BOOK COMPANY, Dept. 23-HH-122
1221 Avenue of the Americas, New York, N. Y. 10020

Send me the book(s) checked below for 10 days on approval. In 10 days, I will remit for those I keep, plus local tax, postage, and handling costs, and return the others post-

paid. (Remit in full with coupon, plus any local tax, and McGraw-Hill pays all postage and handling costs. Same return and refund privileges still apply.)

- | | | | |
|---|---------|---|---------|
| <input type="checkbox"/> 014892—Manual of Built-Up Roof Systems | \$14.50 | <input type="checkbox"/> 152217—Plan Reading for Home Builders, 2nd Edition | \$ 8.95 |
| <input type="checkbox"/> 573913—Landscape Architecture .. | 16.00 | <input type="checkbox"/> 338752—Design and Production of Houses | 12.50 |
| <input type="checkbox"/> 415064—Building Construction Handbook, 2nd Edition | 23.75 | <input type="checkbox"/> 678502—Legal Pitfalls | 14.00 |
| <input type="checkbox"/> 188785—The Art of Home Landscaping | 7.95 | <input type="checkbox"/> 646066—Timber Design and Construction Handbook | 17.50 |
| <input type="checkbox"/> 232369—Systems Management Techniques | 15.00 | <input type="checkbox"/> 152233—Simplified Concrete Masonry Planning and Building, 2nd Ed. | 8.95 |

Name _____

Address _____

City _____ State _____ Zip _____

Offer good only in U.S. Order subject to acceptance by McGraw-Hill

23-HH-122



Spanish
Oak 

Living
Kitchen®
function
with
Family
Center
Beauty
by
Brammer

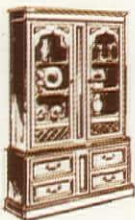

*Wall and base units
harmonize with each
other like a fine
furniture china cabinet.*

• Brammerstyled • Brammercrafted • Brammerstructured

Circle No.
471
on
Reader
Service
Card



BRAMMER®

Living Kitchens® make the whole house smile!

Brammerstyled—Spanish Oak styling breaks with tradition. Now . . . for the first time . . . complete kitchen function and fine furniture style are blended together.

Spanish Oak's beauty comes in many shapes and sizes. Vertically grooved, "touch of rustic" wall units combine with credenza-like base units to produce an unequalled effect of elegance. Delicately toned, carefully hued Spanish Oak complements any motif. Valances are decorator-matched. Wall unit doors can be given custom-panel insets, if desired.

Brammercrafted—Elegance to see . . . to touch . . . and to enjoy day after day . . . that's what Brammercrafted means. Spanish Oak is crafted by masters . . . men who insist on

selected woods . . . absolute production standards . . . and the infinitely painstaking process of finishing cabinets by hand.

Multiple sandings . . . staining, sealing and toning . . . and final finishing assure there has been no compromise with quality. And Spanish Oak cabinetry is set off by color-keyed, custom-cast hardware.

Brammerstructured—Brammer cabinets have mortised and tenoned frames . . . dove-tailed, TRI-GLIDE drawers . . . adjustable shelving in wall and base units . . . nylon roller catches . . . fingertip operation.

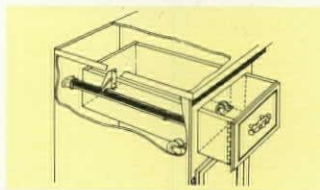

Circle No.
471
on reader
service
card

BRAMMER MANUFACTURING COMPANY • DAVENPORT, IOWA 52808





The best dressed homes wear Bird Architect® 70 shingles.

A luxurious look for a reasonable price makes homes and condominiums more saleable.

The Bird Architect 70 is probably America's most beautiful shingle. It's bold, brawny, beautiful. It combines the beauty of random shake shingles with all the wind, water and fire protection of finest quality asphalt.

These magnificent shingles can help move your homes, apartments, and condominiums in a hurry. They're rich-looking, thick and robust 345 lb. heavyweights. Random-edged for a beautifully sculptured shadow line, they are self-aligning for quick and easy installation resulting in significant savings in material and labor cost.

Lush, warm earth tones impart a look of natural grandeur – ideal for mansard, gambrel and barn style roofs – and delightful on every type of architecture.

With your very next job, look into the Bird Architect 70. You'll know immediately why it'll help you sell your property – fast!

**BIRD
& SON**
INC.
QUALITY PRODUCTS SINCE 1706

BIRD & SON, INC.
E. Walpole, Mass. 02032
House & Home
Dec. 1972

Please send full information on the Bird Architect 70 and your complete roofing shingle line.

Name _____

Company _____

Street _____ City _____

County _____ State _____ Zip _____

**World's best valve in
a medium-priced
single-lever faucet.**

**World's best valve
in a low-priced
single-lever faucet.**



Shown is the ceramic-disc cartridge for the Aquarian faucet. Cartridge for Aquamix has slightly different configuration.

Right. They're both the world's best! Because the ceramic-disc washerless cartridge is the heart of both the Aquarian and Aquamix faucets.

We knew it was good when we introduced it three years ago in the Aquarian. (It survived 50-year use tests without failing.) Plumbing contractors keep telling us it's the best valve in the industry. And there are nearly two million Aquarians in use to back them up.

It helps make the Aquarian the best medium-priced single-lever faucet for bath, shower, and kitchen.

And it helps make Aquamix the best low-priced single-lever kitchen faucet for budget housing.

For the best in single-lever faucets—as in *all* fixtures and fittings—it's American-Standard. American-Standard, P.O. Box 2003, New Brunswick, N.J. 08903.

 **AMERICAN
STANDARD**
PLUMBING / HEATING

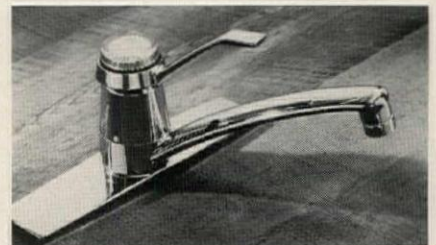

AQUARIAN™



AQUAMIX™



Now merchandise the added value of bottle-quality water from the kitchen tap.

Install a AMF Cuno Aqua-Pure Water Filter beneath the kitchen sink and merchandise bottle-quality water to your prospects.

It will mean all your buyers will enjoy not only spring fresh water, but every cup of coffee, tea or frozen orange juice made with it.

It's a simple addition. It goes under the sink easily. And at low cost!

Replacement filters need only be changed every three to six months and

can be done by the housewife or your maintenance people if you like to maintain access to the premises.

The Aqua-Pure Water Filter is a new customer benefit you can advertise with every new unit you build.

Check with your plumbing supply dealer. Or write: AMF Cuno, Consumer Products Division, Dept. HH, 400 Research Pkwy, Meriden, Connecticut 06450.

AMF
Cuno
Aqua-Pure®
WATER FILTERS

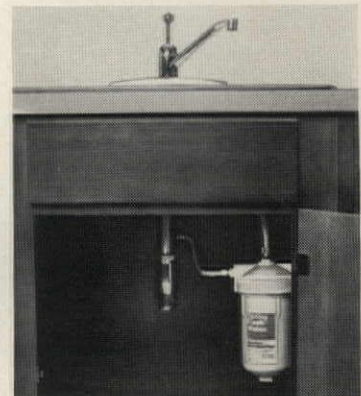

See the Aqua-Pure Filter on display in Booth 2663 at the NAHB Show

We make house calls.



If you have symptoms of a floor covering problem, Congoleum has the cure. Congoleum experts in carpet and sheet vinyl get to you fast when you need special help. The kind of experts who aren't necessary on your staff — until you need them. For installation help. Design consultation. Technical service. Production control.

When Congoleum takes to the floor, these specialists join your team. Don't suffer from floor covering problems when you can get this kind of treatment.

Call collect (201-991-1000) or write Bill Schletzer, home builder sales manager, Congoleum Industries, Inc., Kearny, N. J. 07032.

Congoleum[®] FINE FLOORS **has the answer.**

8



9

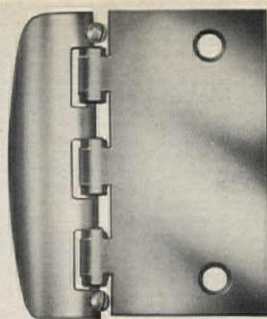

10

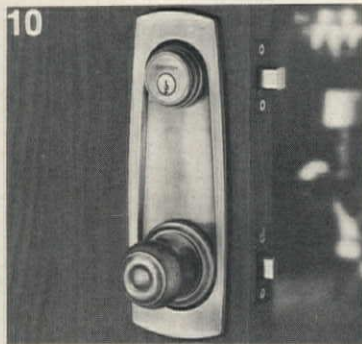

11



products: doors/windows

8. Steel bi-fold doors are designed for 6'8" and 8'-high openings. One-piece construction and 1½" thickness permit the 6'8" model to be installed with only a top track. When bottom tracks are used, a snap-apart feature speeds installation of two- or four-panel widths. "VP" bifolds come in standard widths. General Products, Fredericksburg, Va. *Circle 336 on reader service card.*

9. Pivoting hinge-lock provides added protection against burglaries. Designed for installation on a door jamb, "Pivot Lock" has a pivoting leaf that swings over and locks door into position. To unlock, the leaf pivots in the opposite position over door jamb. The secondary lock device is high-carbon steel with a polished brass finish. Ajax Hardware,

City of Industry, Calif. *Circle 337 on reader service card.*

10. Lockset kit combines safety feature with decorator appeal. "Double Duty plus Beauty" comes in four combinations of auxiliary cylinder deadbolt, decorative escutcheon and passage or keylock knob sets. Complete installation instructions are included in the package. Dexter Lock, Grand Rapids, Mich. *Circle 338 on reader service card.*

11. Sliding window is designed for low-maintenance. Its rigid PVC cladding over preservative-treated wood sash and frame requires no painting and resists weathering and corrosion. Window comes in standard sizes. Andersen, Bayport, Minn. *Circle 339 on reader service card.*

IT'S STRONG . . . IT'S GOOD LOOKING!
IT'S FAST AND EASY TO INSTALL!
IT'S THE LOWEST "IN-PLACE" COST
SHELVING SYSTEM AVAILABLE!

TECO

EXPANDABLE SHELVING

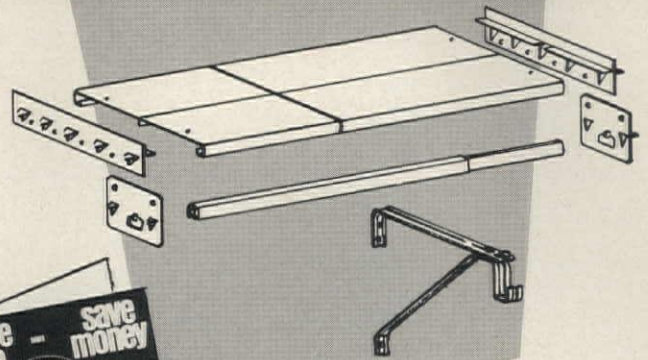

* Lowest "in-place" cost because toggle bolts or screws are eliminated in most installations. And . . . it's prefinished!

SEND FOR FREE BROCHURE.

TECO

5530 Wisconsin Avenue

Washington, D.C. 20015

Phone: (202) 654-8288

CIRCLE 116 ON READER SERVICE CARD

Why pay an answering service when you can own your own?



Dictaphone has a machine to make sure you never lose another cent through a missed phone call or a garbled message. In fact, we have a whole line of them.

They're called Ansafones. You can buy one outright or possibly lease it for about what you're paying your answering service now. And it works for you 24 hours a day. 7 days a week.

For a free brochure describing how much an Ansafone can help you, mail this coupon now.

▶ **Dictaphone**

Box L 12-20 120 Old Post Road, Rye, New York 10580

Please send me full details of the Ansafone line.

Name _____

Company _____ Phone _____

Address _____

City _____ State _____ Zip Code _____

Ansafone and Dictaphone are registered trademarks of Dictaphone Corp.

CIRCLE 163 ON READER SERVICE CARD



I'm worried, Tom Trueblood!
A couple of mighty
lowdown varmints are
trying to ruin my
homebuilding business.

Never you fret,
Sally Homespun.
Me and J-M
Snap/Pak™ insulation
and Rampart™
fiber glass shingles
will come to your
rescue in that
gripping melodrama,
"Sally Saves the Day"
at the NAHB Show
in Houston.



Johns-Manville proudly presents "Sally Saves the Day," a gripping melodrama of homebuilding in the ^{New}~~Old~~ West.

Watch Sally and Tom do battle with Gouger and his odious sidekick, Black Bart, at the NAHB Show in Houston!

Witness incredible deeds of derring-do with the staple gun—a veritable insulation shoot-out!

Gasp as Bart fires flaming arrows into Sally's Class A roofs!

Sigh as Sally (with a little help from J-M building products) finally saves the day!

Filmed in wide screen 35mm panavision by award-winning cinematographer Jeri Sopianen, "Sally" is but one of many good things to see and do at J-M's exhibit—booth 2022.

The JPJ Jazz Quartet will be on hand, too. So will noted TV personality Sid Stone.

Who's invited? You are—if you like drama, action, excitement, pretty girls, good music, comedy, insulation, roofing, ceiling tiles and wall panels!

(If you're a program chairman, you'll be especially interested in seeing "Sally Saves the Day" because J-M is going to make prints available for local homebuilder meetings. Write to Johns-Manville, Box 5705-RP, Denver, Colorado 80217.)

Booth 2022, N.A.H.B. Show.

Johns-Manville 

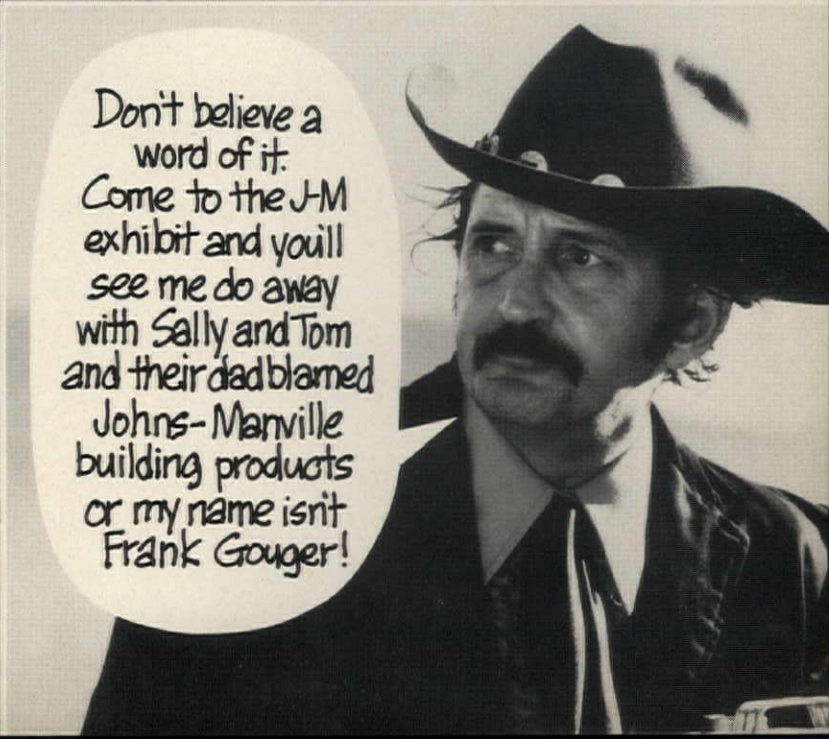

Don't believe a word of it. Come to the J-M exhibit and you'll see me do away with Sally and Tom and their dad blamed Johns-Manville building products or my name isn't Frank Gouger!

A TOTALLY NEW UTILITY COMBO THAT CAN SAVE YOU SPACE, TIME, MONEY, MATERIALS AND MAINTENANCE.

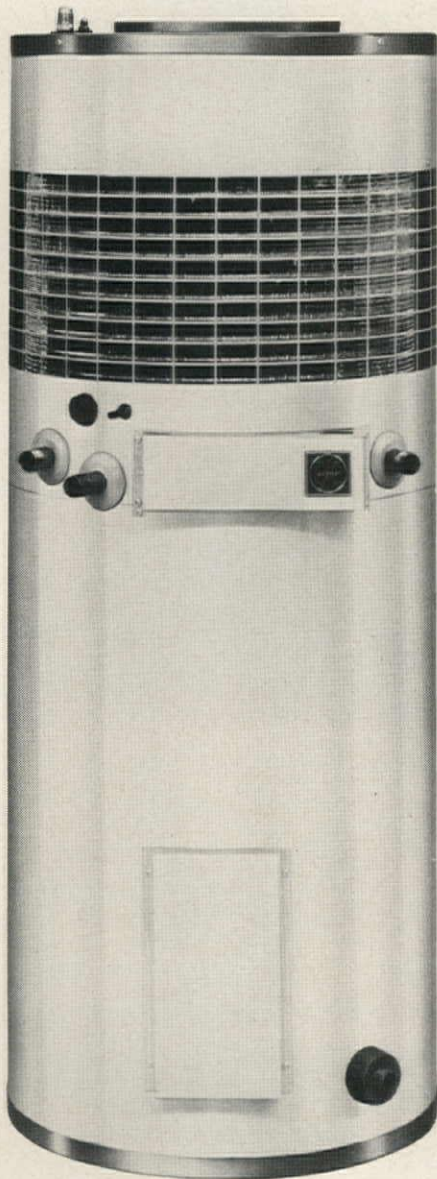

- It's an Electric Direct Expansion Fan Coil for summer cooling...
- an Electric Air Heater for Winter-time Comfort...
- an Electric Water Heater for Year-Round Operation.

THE ELEC-TRI-PAC.

It's a water heater, air heater and an air-conditioning fan coil combination designed especially for multiple-unit apartment complexes, condominiums, office buildings, residences, and other limited-space applications.

IT'S A SPACE SAVER.

The 40-gallon Jetglas water heater, fan coil and 5, 8, 10 or 12KW strip heater will fit neatly into a 24"x28" area — a standard 2-foot closet. Cooling is supplied by a compact, 1½ or 2-ton remote electric air conditioner.

IT'S A TIME SAVER.

The Day & Night Elec-tri-Pac can cut installation time up to 110 minutes per unit, because you're installing one combination unit as compared to installing three separate units individually.

IT'S A MONEY SAVER.

On all Day & Night Elec-tri-Pacs you can use a single circuit breaker and single electric circuit. This is even possible in the models with 8KW air heaters or larger as a result of the Current Limiting Sequence Circuitry furnished as standard equipment. You'll save up to \$600 on a 20-unit building on wiring, circuit breakers, and labor alone.

IT'S A MAINTENANCE SAVER.

All electrical controls and the T&P relief valve are readily accessible through the front. The factory supplied air filter is placed on the outside of the casing for ease of service.

If you've got a building project, now or in the near future, that looks right for our new Elec-tri-Pac, you can get more information by contacting your nearest Day & Night distributor. Air Conditioning, Heating, Water Heating from the Day & Night Company.



La Puente, California, Collierville, Tennessee

DAY & NIGHT ELEC-TRI-PAC

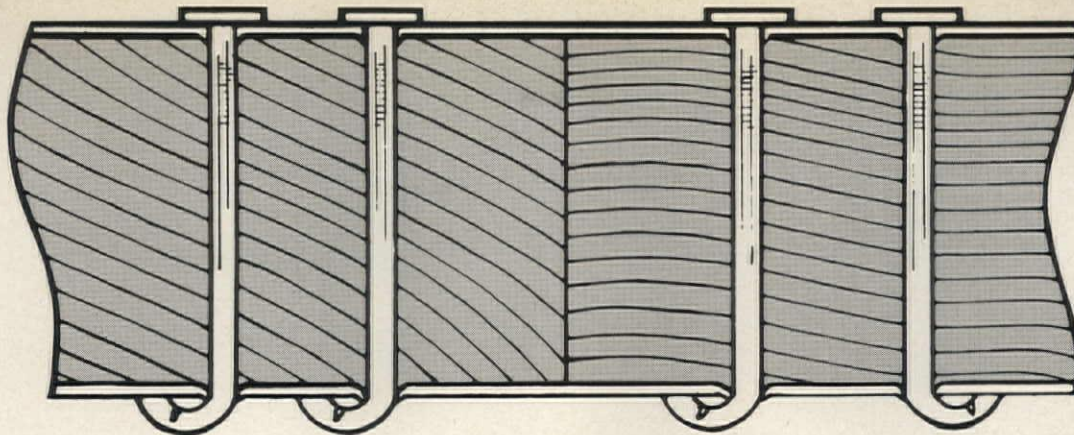

It's the only roof truss joint with rivet-like strength.

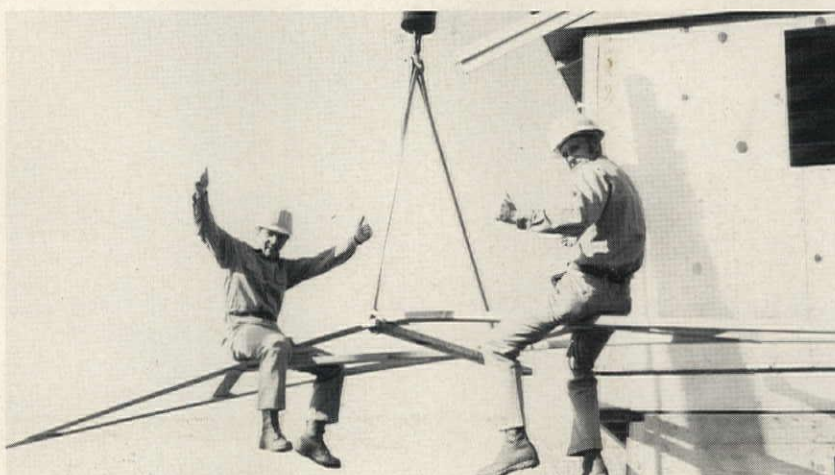

Even with the racking weight of a full-grown man on each side, this Fink truss joint won't give. It's fastened with Bostitch Clinch Nails – the heart of a unique truss system that combines the proven strength and durability of nail-on truss plates with the speed and low cost of simple, compact air guns.

With the Bostitch Clinch Nail System, there's no more flipping of trusses during assembly. *All joints are nailed from one side only.* So now you can make trusses in half the floor space normally needed.

Each Clinch Nail goes completely through both sides of each joint. "Clinching" action locks joints together, rivets the wood between two steel plates.

Two-ply Bostitch clinch plates insure precisely controlled clinching grip.

With the Clinch Nail System, you can handle almost any style truss up to 40-foot span and 7-in-12 pitch.

Everything you'll need including coil-fed nailers, compressor and hoses, truss plates, jigs, clamps and Clinch Nails come with this new Bostitch truss package.

For all the money and time-saving details, send for our *new* construction capabilities brochure. Write Bostitch, 503 Briggs Drive, E. Greenwich, Rhode Island 02818.

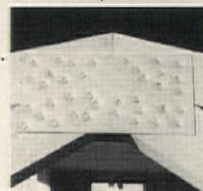

Bostitch fasteners hold fast!

BOSTITCH
FASTENING SYSTEMS
A **textron** COMPANY

'73 Ford pickups
start the better
ideas coming
all over again!



Behind seat is storage space
not gas tank on most models.



Ford box cover looks and fits
right, protects your cargo.



Full-foam seat over 5 in. deep
is standard in every cab.

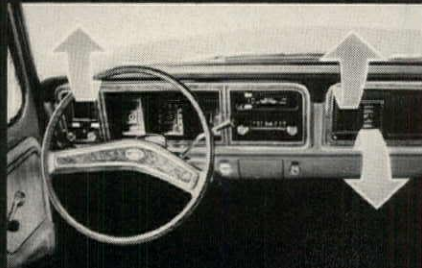

Heater is modern blend-air type;
optional "air" is all built in.

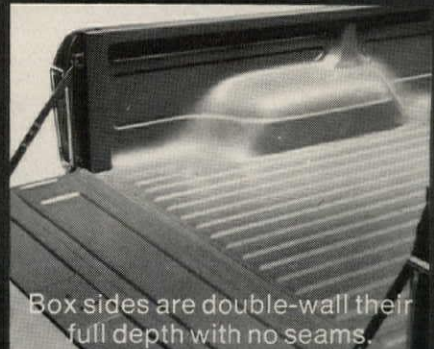

Box sides are double-wall their
full depth with no seams.

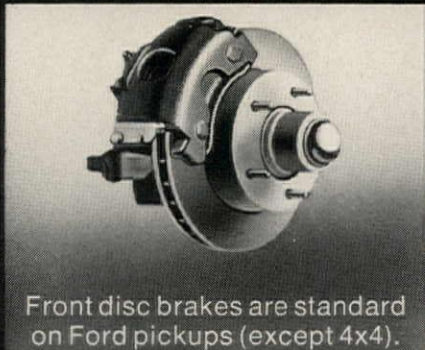

Front disc brakes are standard
on Ford pickups (except 4x4).



Roomiest Ford pickup cab ever
offers unusual quiet, comfort.

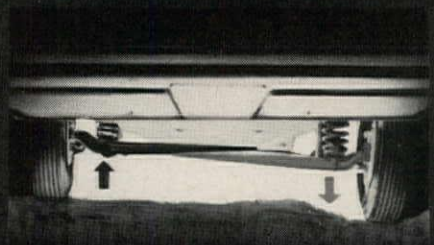

Ford's famous Twin-I-Beam
suspension...smooth, strong.

A better idea for safety:
Buckle up.



FORD PICKUPS

FORD DIVISION



Works like a truck/rides like a car.

Availability may be subject to Environmental Protection Agency certification.

From Gerber. Best single way to

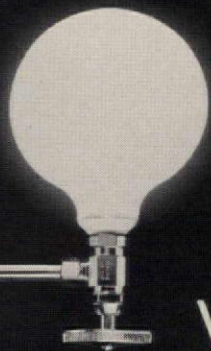

put more pizazz in your plumbing

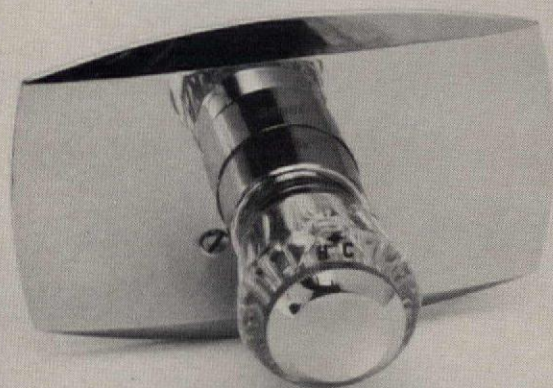

Watch your customers' eyes light up when they see these handsome Gerber singles. A clever combination of bold and delicate lines lets you suit the styling of any home — modern or traditional.

But satisfied buyers aren't made by pizazz alone. It takes solid product quality.

Our new Easy-Mix™ singles are ingeniously uncomplicated. Their patented

lifetime control unit may be the simplest faucet valve ever designed. Smooth and effortless to the touch, it's engineered to stay that way.

These new singles are designed with the plumber and builder in mind: installation is quick, clean, tight. And sensible prices protect your profits.

Get the whole story on these new Super Singles. Gerber Plumbing Fixtures Corp., 4656 W. Touhy Ave., Chicago, Ill. 60646.

The Super Singles —
with the extra value
that profits grow on

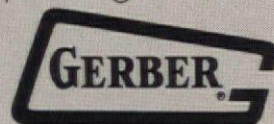

1-211



Outstanding STUDIO STAIRS assure "custom designed" appearance. Each stair is produced to individual job specifications for easy assembly.

Studio Stair.

the stair with a flair

by AMERICAN PANEL PRODUCTS, INC.
1735 Holmes Rd., Ypsilanti, MI. 48197

CIRCLE 117 ON READER SERVICE CARD



... for up to 15 people in
Am-Finn's new "jumbo" Mark 810 Sauna.

- Giving you:
- ▶ 80 square feet of floor space
 - ▶ interior walls, ceiling, floor and benches of beautiful kiln-dried redwood
 - ▶ superior insulation of non-burning polyurethane
 - ▶ vapor-proof interior light
 - ▶ pre-fabricated and pre-wired for easy installation

"Sitting room only" inside the Mark 810 Sauna means "standing room only" outside your rental office.

Call or write for more information about our complete line of original Finnish saunas today.

AM-FINN, INC.

Haddon Ave. & Line Street • Camden, New Jersey 08103



products: flooring

8. Random-sheared Acrilan® carpet is tufted through two man-made backings. Multi-level "Nairobi" indoor-outdoor carpet, part of the "Wildlife" collection, is available in ten colors and in 12' and 15' widths. Retail price is approximately \$8.95 a sq. yd. C. H. Masland & Sons. *Circle 352 on reader service card.*

9. Polyester contract carpet carries a five-year wear guaranty with normal usage. "Pick-up-Sticks", of Celanese Fortrel, comes in 12' and 15' widths and retails in most areas for under \$13 a sq. yd. Sweetwater Carpet, Ringgold, Ga. *Circle 353 on reader service card.*

10. Sheet-vinyl floorcovering simulates a hand-painted ceramic tile design. "Sunglow", a member of the

"Regency" line of wax-free floorings, comes in three color combinations: blue, white and gold; green and gold; and gold and tan. Deep embossing in the tile design enhances the pattern's authentic look. Also added to the cushioned floorcovering line are five colors of "Marlstone", a broken-pebble design. GAF, New York City. *Circle 354 on reader service card.*

11. Polyester bricks provide the authentic look of a real brick floor. Easy two-step installation process involves setting individually molded bricks in mastic mortar base, then squirting squeeze-bottled "Glue & Grout" between them. "Bricover Floor Brick" may also be used outdoors on a solid foundation. Plas-tronics, West Yarmouth, Mass. *Circle 351 on reader service card.*

Carrier changes apartment cooling inside and out.

Carrier's new split system equipment is tailored neatly to apartments. In both size and cooling capacity.

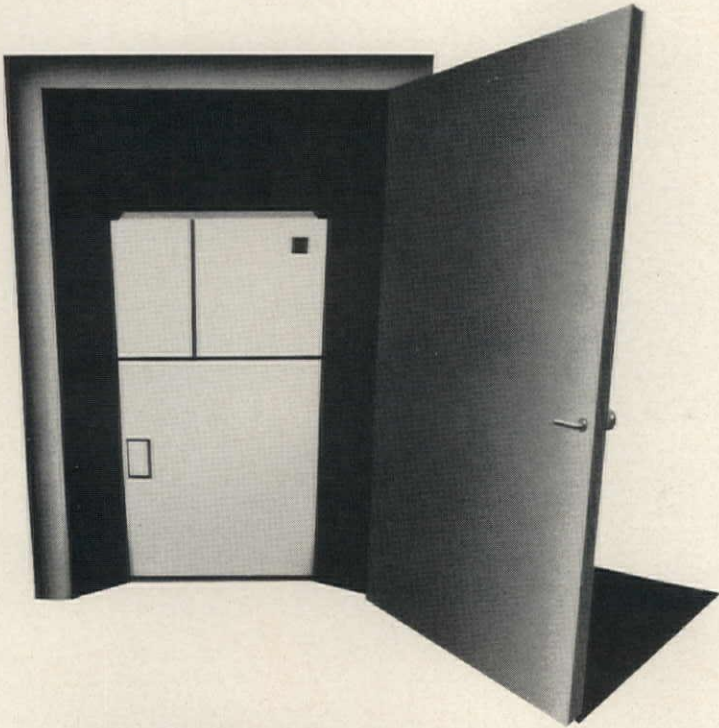

Inside, our 40VU fan coil unit stands out of the way in a closet. And quietly cools an apartment.

Comes in six sizes to match your apartment sizes. And now or later, you can slip in an electric heating coil. We made room for it. Upflow. Or downflow.

On larger models, a solid state circuit even controls the fan speed. Set it. And forget it.

Outside, Carrier's new 38GS Compact condensing unit completes the system. 16" low on the roof. Or behind the bushes on the ground.

Its upflow air exhaust cuts down the sound. So does its unique computer-designed fan.

Like its inside companion, the 38GS comes in the sizes you need to handle tons of cooling in any apartment complex. Simply.

Know, too, that since the 38GS-40VU system carries our name, you'll get the kind of tenant recognition and dealer service that's made our name.

Have a Carrier Dealer quote your next garden apartment. Inside and out. He's in the Yellow Pages. Or write us. Carrier Air Conditioning Company, Syracuse, N.Y. 13201.

Carrier[®]

air conditioning

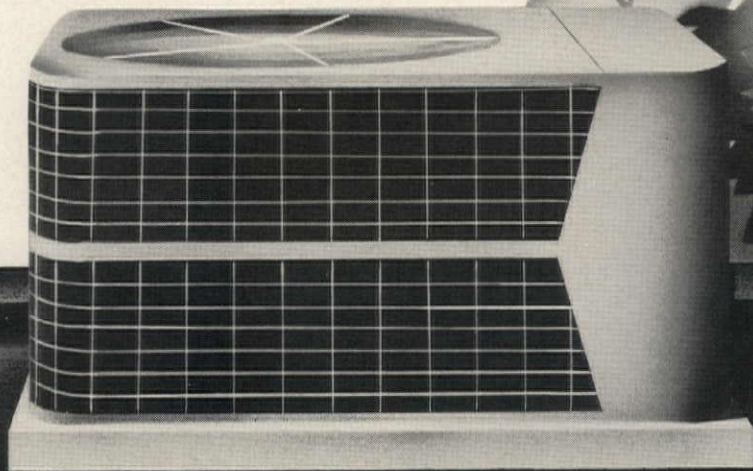

The first modern wood moulding reference book.

Informative, 24-page, full-color book explores the history of architectural moulding uses from early Greece to today. Includes emphasis on Colonial mouldings, the source of most current moulding patterns.

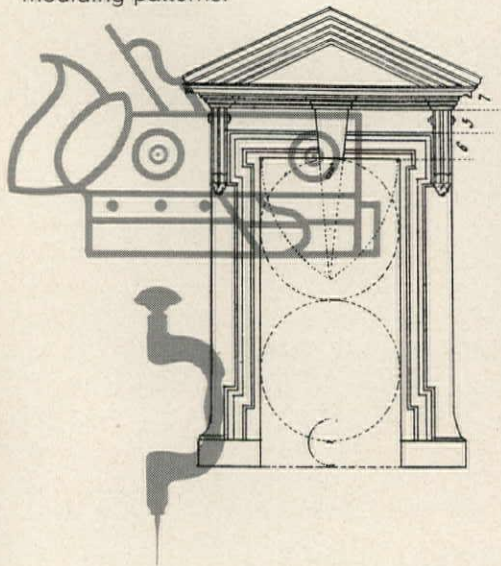

Detailed in the booklet are studies of contemporary moulding uses, plus existing classical American Colonial interiors showing how the same architectural effects can be duplicated with moulding patterns available today.

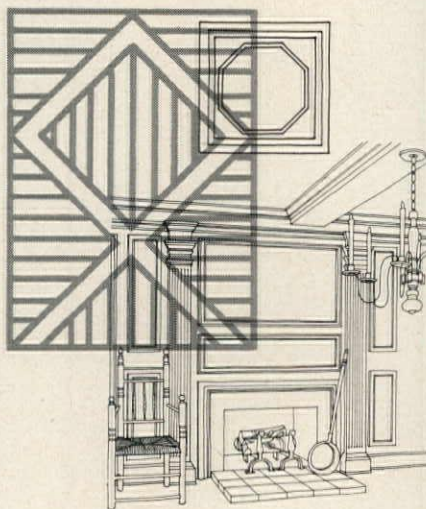

Special pattern section describes moulding uses by name, styles and size. Section shows basic patterns available.

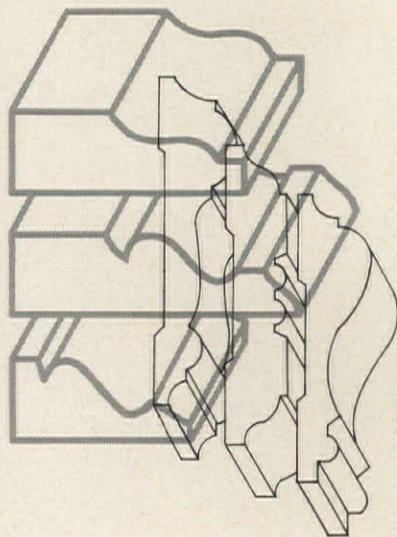

FREE!

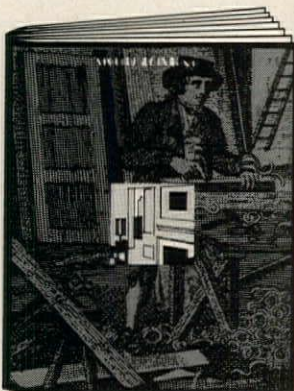

The first modern moulding reference book includes a history of moulding, applications, and a catalog of patterns. Single copies of this beautiful 24-page, full-color booklet are free. Send for your copy today!

Name _____

Firm _____

Address _____

City _____

State _____

Zip _____



WESTERN WOOD MOULDINGS
AND MILLWORK PRODUCERS
Dept. L-H1272, P.O. Box 25278
Portland, Oregon 97225



a star is born

Briggs.

Yes, the Briggs plumbing fixture company known for 83 years. The new star, the new look—and newly expanded into the water heater business through the acquisition of the Republic Heater Company...

They're all part of the new Briggs. But you'll recognize the classic Briggs quality right away.

See what it's all about at the upcoming NAHB Show in Houston, Booth #2218.

Simply look for the new star.



Briggs

6600 East 15 Mile Road
Sterling Heights, Michigan 48077

Division of Celotex Corporation
A Subsidiary of the Jim Walter Corporation

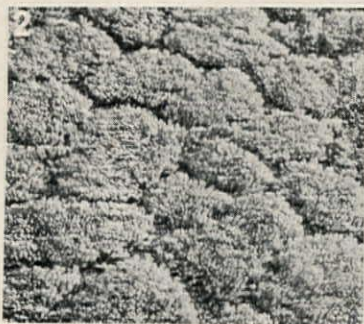

products: flooring

1. Underlayment for contract carpets combines properties for firm support and comfort. "Omalon Carpet Foundation System" is available in three grades of density and thickness. All grades come in 40-sq.-yd. rolls, 6' wide and 60' long. Olin, Stamford, Conn. *Circle 344 on reader service card.*

2. Sculptured shag carpet comes in a wide range of solid colors. Face yarn is heat set staple nylon. Multi-dimensional "Carriage House", with a polypropylene primary backing, retails for approximately \$9.95 a sq. yd. Certain-teed Products, Valley Forge, Pa. *Circle 345 on reader service card.*

3. Red-oak flooring may be installed directly on concrete or plywood. Medium-brown in color, the tiles are 10 $\frac{7}{8}$ " sq., $\frac{5}{16}$ " thick. "BondWood" features a rough-textured face and low-maintenance, deep penetrating finish. Harris Manufacturing, Johnson City, Tenn. *Circle 346 on reader service card.*

4. Ceramic tiles, in intermixed shades and colors, are easy to clean, won't burn and need no waxing. "Franciscan Terra Grande" comes in a wide range of colors in textured or smooth glaze. Tiles come 3"x6" and in four made-to-order sizes. Interpace, Los Angeles. *Circle 350 on reader service card.*

G-P has the answer sound control in

"Why does my fire control system in exterior walls cost so much?"



Fire control doesn't have to be expensive. Not when you use G-P's FIRESTOP®. It gives you a one-hour fire rating in exterior walls. $\frac{5}{8}$ " FIRESTOP® gypsumboard is applied over wood studs with insulation. And then on the outside wall, $\frac{1}{2}$ " FIRESTOP® sheathing is attached and covered with $\frac{3}{8}$ " (or $\frac{5}{8}$ " G-P plywood siding.

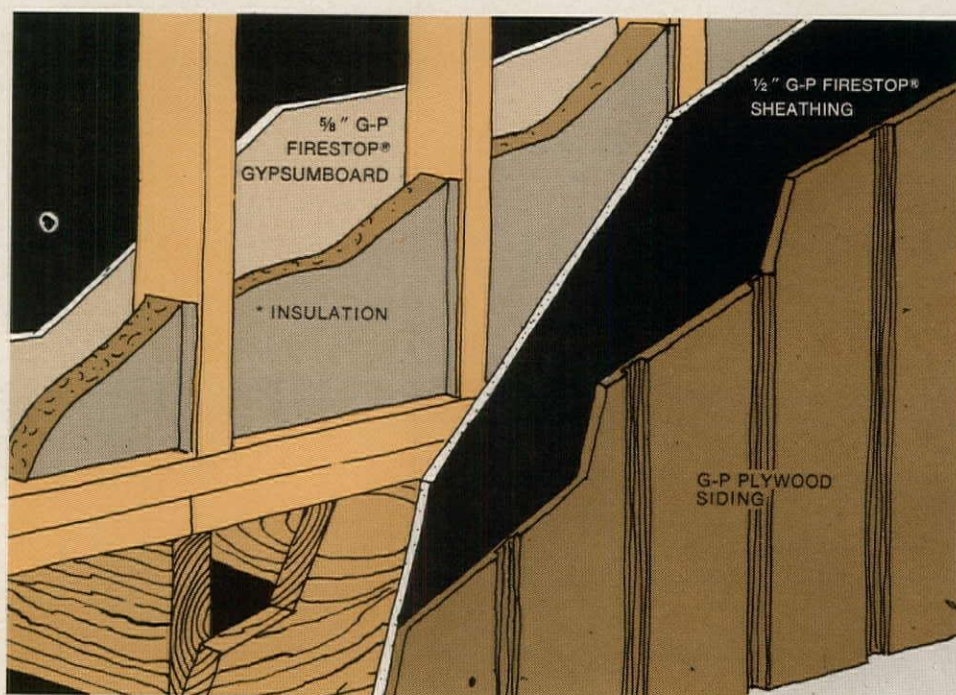

* INSULATION NOT REQUIRED TO MEET FIRE RATINGS



products: flooring

5. **Low-maintenance vinyl floor** features a delicately shaded, ruggedly embossed Mediterranean tile design. "Portifino" comes in five colors: gold, terra cotta, white, avocado and bronze. Available in 6' or 12' widths, the sheet-vinyl can be installed at grade level including on-grade concrete floors and in basement areas.

Armstrong Cork, Lancaster, Pa. Circle 347 on reader service card.

6. **Easy-to-install parquet tiles** are backed with foam to increase sound-control, resiliency and moisture-proofing. Hartco Wood Foam Tile® features "Park-K-Stik"—a system of factory-applied adhesive dots which

eliminates need for mastic or rollers during installation. Instead, a chemically treated peel-away backing is removed, and tiles are pressed into place. Seven finishes are available. Tibbals Flooring, Oneida, Tenn. Circle 348 on reader service card.

7. **Heat set nylon splash**, "Gentle

Touch", combines the best wear and appearance characteristics of a shag and a plush. Shown in "regency red", the fabric adds elegance to a contemporary styled dining area. The easy-to-maintain, tufted carpet retails for approximately \$8.95 a sq. yd. J.P. Stevens, New York City. Circle 349 on reader service card.

to economical fire and low-rise construction.

"Is there a fire control system that really works for roofs?"



Yes! G-P's new Fire Fighter gypsumboard gives you excellent fire protection for roof construction. It's ½" thick gypsumboard with a fire resistant core and special paper that is easily placed over the rafters. Solid plywood or strip sheathing is laid over it. Then put up a wood shake or any other kind of roof you want. And Fire Fighter gypsumboard will prevent flames from burning through the roof structure.

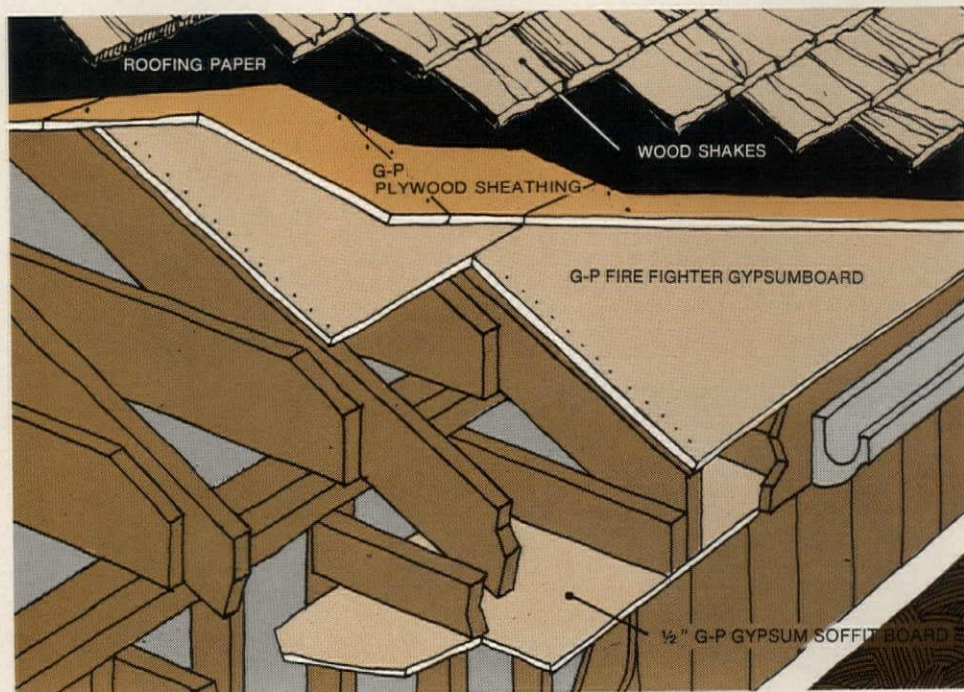

Georgia-Pacific

GYPSUM DIVISION, Portland, Ore. 97204





Mark 123 woodburning fireplace available in variety of styles.



Dramatic wall-hung Mark 5880 gas fireplace.



Mark 2028 gas fireplace combines the charm of wood with the convenience of pushbutton gas.



Sophisticated free-standing woodburning fireplace, Mark 4606.

Heatilator fireplacing... the low-cost way to charm prospects

You've got profitable new reasons to include wood or gas fireplacing in your apartment plans—just as for single homes. Heatilator fireplacing simplified now makes it practical with...

Factory-built components at surprisingly low initial cost—apartment-engineered systems that are fully compatible with standard construction methods, reducing installation costs to the lowest ever. Place a Heatilator wood or gas fireplace anywhere, right on a wooden floor, against combustible wall materials—without using masonry. Woodburning models are complete systems, hearth to roof termination. Gas units use standard B-vent for both single and multi-level venting. And, all models offer unlimited decorative trim options—leave fireplace surround as is, paint as desired, or conceal with brick, marble, etc.

Charms renters into paying premium rent. Heatilator fireplacing not only gives you more competitive rental appeal, it is making renters glad to pay up to \$15 more per month—giving you more profit, more cash flow, more loan and sales value.

Long, dependable service. Mark 123 woodburning fireplaces feature a 20-year written warranty and smoke-free guarantee—U.L. listed! Heatilator gas fireplaces feature realistic Oak logs and flame, convenient pushbutton control—use natural or L.P. gas. A.G.A. design certified and tested.

See your Heatilator Distributor. Or, send for FREE Fireplace Idea Kit. Write Heatilator Fireplace, A Division of Vega Industries, Inc., 18122 W. Saunders St., Mt. Pleasant, Iowa 52641. (Also available in Canada.)

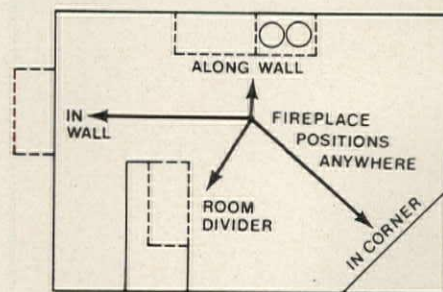

Multi-level venting for wood or gas systems.

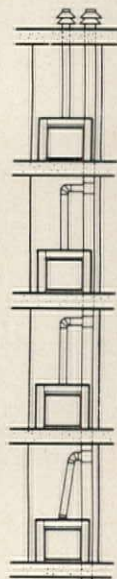

See Catalog in Sweet's Light Construction File

heatilator[®]
AMERICA'S LEADING FIREPLACE SYSTEMS



With steel doors as good as Float-Away, why pay the high price of wood?

Today the wooden closet door has about priced itself out of the market, in both homes and apartments.

Lumber prices have climbed. Wood doors are up drastically. More increases are on the way.

Now is a good time to take a hard look at what you're getting for your money—regardless of what kind of door you have used in the past. Compare Float-Away steel closet doors and shelves for initial price and cost of

installation. Examine the unique new Floata-Plate finishing process, exclusive with Float-Away. Compare for appearance, quality and durability.

Float-Away is the best door you can buy—and today that buy looks better than ever.

Call or write for complete details. Float-Away, Dept. HH-12, 1123 Zonolite Rd., N.E., Atlanta, Georgia 30306, (404) 875-8021.

Space No. 2400, NAHB Exposition, Houston, Texas

K **KINKEAD**
INDUSTRIES
INCORPORATED · SUBSIDIARY OF
UNITED STATES GYPSUM COMPANY
FLOAT-AWAY
DOOR DIVISION

CIRCLE 179 ON READER SERVICE CARD

H&H DECEMBER 1972 179

Now even better with **micro** **lam**[®]

Since its introduction just two years ago the TRUS JOIST I Series, or TJI Joist, has become the fastest selling new structural component in the United States. Millions of lineal feet have gone into floor systems for apartments, town houses, condominiums and single family dwellings. In commercial buildings and apartments alike, it has provided a superior roof system as well. Utilizing 2 x 3 or 2 x 4 flanges of top grade Machine Stress Rated structural lumber it has always outperformed solid sawn joists, but now the TJI is rapidly becoming available nationwide with flanges of MICRO=LAM lumber.

MICRO=LAM is a new TRUS JOIST development wherein sheets of veneer are fed into one end of a 90 foot traveling press in an exact lay-up pattern. Precise amounts of heat and pressure are applied and the veneers exit from the machine in the form of a MICRO=LAM board or billet 80 feet long, 24 inches wide and 1½ inches thick. The billet is then cut to size for use as TJI flange material.

MICRO=LAM is a superior wood product in that every piece is uniform and of known strength. Any defects in the veneers are so widely scattered they do not affect the board itself. There are no problems with warp or shrinkage. MICRO=LAM is straight and it stays straight. It has excellent structural characteristics and an extensive testing program has shown it to be completely reliable. Major code groups and F.H.A. have approved MICRO=LAM flanges for the TJI Series joist as a direct substitute for the high quality structural lumber formerly utilized.

The introduction of MICRO=LAM is probably one of the most significant developments which have taken place in wood utilization in recent years. Because of its strength, versatility and availability in extremely long lengths it is destined to be used in many new applications of which the TJI flange is only the beginning.



Plywood web cuts easily

I SERIES TRUS JOIST

*** LIGHT WEIGHT, FAST ERECTING**
 Builders report the TJI goes in place two to four times faster than solid sawn joists. Saves time. Saves money.

*** LONG SPANS**
 Up to 24 feet at 2 feet O.C. in floor systems, up to 40 feet at 2 feet on center in roof systems. Multiple spans to 60 feet. Available in depths from 10 inches to 24 inches.

*** UNIFORM**
 Every joist is uniform and equal in strength to provide level floors which are far more rigid than those using solid sawn joists.

*** DRILL EASILY**
 The plywood web drills easily and quickly to accommodate wiring, plumbing and even large ductwork. Often makes it possible to eliminate expensive hung ceilings.

*** PROBLEM FREE**
 Will not cause cracked walls, sticking doors or windows because of shrinkage, a common failure of solid sawn lumber.

*** ALWAYS AVAILABLE**
 Delivery within three weeks anywhere in the U.S., any time of year. Often sooner, if needed.

*** REAL ECONOMY**
 In many areas the TJI will compete in price with 2x10's but the really big savings are in labor and faster construction.

*** QUALITY**
 The TJI is precision engineered, manufactured to exact specifications in our own plants and absolutely guaranteed to carry the loads for which it is designed. It provides a floor or roof structure far superior to ordinary dimension lumber.

trus joist
 ®

9777 Chinden Boulevard Boise, Idaho 83702

CIRCLE 181 ON READER SERVICE CARD



A complete I Series file folder containing load tables, bearing details, design information, job photographs and other details was mailed to 30,000 firms this month. If you do not receive one and you are an architect, engineer, builder or developer just fill out and mail this coupon. We'll send your folder immediately.

NAME _____

FIRM _____

ADDRESS _____

STATE _____ ZIP _____

If you're a builder or developer, how many residential or commercial units do you have planned for 1973? _____



accommodate even large duct work.

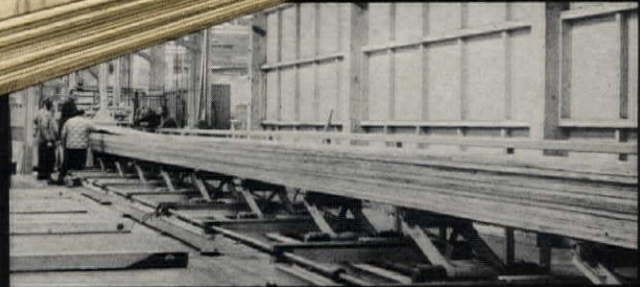

80 foot Micro-Lam billets as they exit from press.



I Series joists go in place 2 to 4 times faster than 2 x 10's.

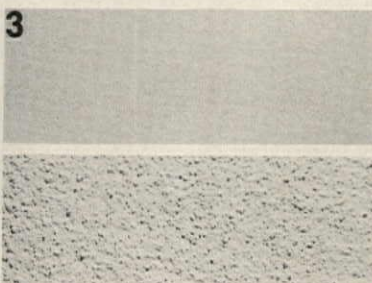

products: coating/adhesives

1. Construction adhesive is non-flammable and non-toxic. "Big Stick" is suitable for use on paneling, polystyrene, urefoam, insulation board, acoustical tiles, fiber glass, most plastics, masonry, metals and wall boards. Weldwood, Champion International, Kalamazoo, Mich. *Circle 368 on reader service card.*

2. Patented latex house paint for exterior application "Busan® 11" has a preservative pigment that keeps finish clean and bright. Substance is guaranteed not to mildew, fade or chalk for eight years. It is fume-resistant, non-yellowing and inhibits rust. Evans Products, Roanoke, Va. *Circle 369 on reader service card.*

3. Acrylic latex "Ultra-hide" minimizes surface irregularities in concrete, plaster, exterior grade plywood and filled concrete block. The thick, flexible, mildew-proof material bridges small cracks and pinholes. It can be applied with an air spray or roller. Glidden, Cleveland, Ohio. *Circle 370 on reader service card.*

4. Heavy-duty latex coating is suitable for application by airless spray or roller to drywall, masonry, plaster or primed metal surfaces. A single-coat of the substance covers irregularities and dry tape joints. Paint has a durable, washable, deep-flat finish. Luminall, Los Angeles. *Circle 371 on reader service card.*

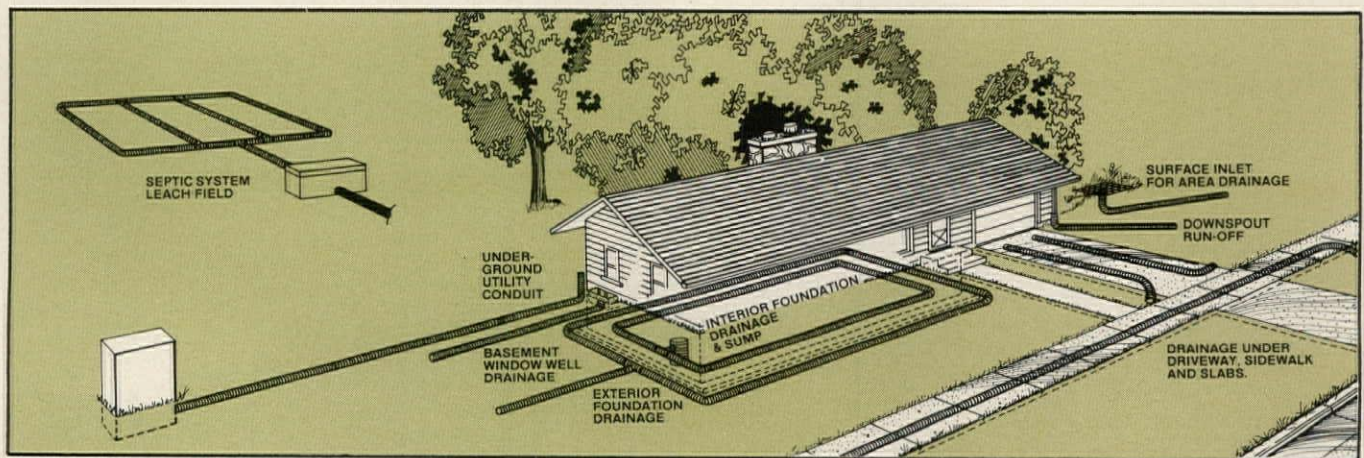

USE A.D.S. TUBING TO SOLVE YOUR SITE DRAINAGE AND WATER HANDLING PROBLEMS IN CONSTRUCTION & LANDSCAPING

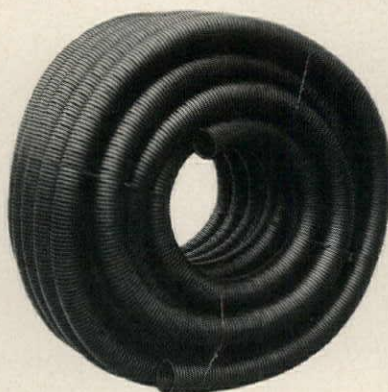

- EASY TO INSTALL — SAVE TIME — AND MONEY
- STRONG — TOUGH — DURABLE
- FLEXIBLE; SHIFTS WITH THE GROUND
- LONG LIFE — WILL NOT DETERIORATE
- UNRESTRICTED WATER INTAKE
- ASSURED EFFLUENT FLOW

Approved by F.H.A. Materials Release 619a — May 26, 1971, and most State, County, and Local Sanitarians. Meets applicable sections of Commercial Standard C.S. 228-61 for strength and chemical resistance.

**See us at Booth 2169
NAHB Convention**



4" — 402
for leach fields.
Full selection of fittings. 4", 5", 6", 8", 10", 12", 15", 18" for Drainage.

ADS advanced drainage systems, inc.

NATIONAL MANUFACTURING, SALES & SERVICE
Corporate Offices: Columbus, Ohio 43220
1880 MacKenzie Drive (614) 457-3051

America's best defense against air attack.

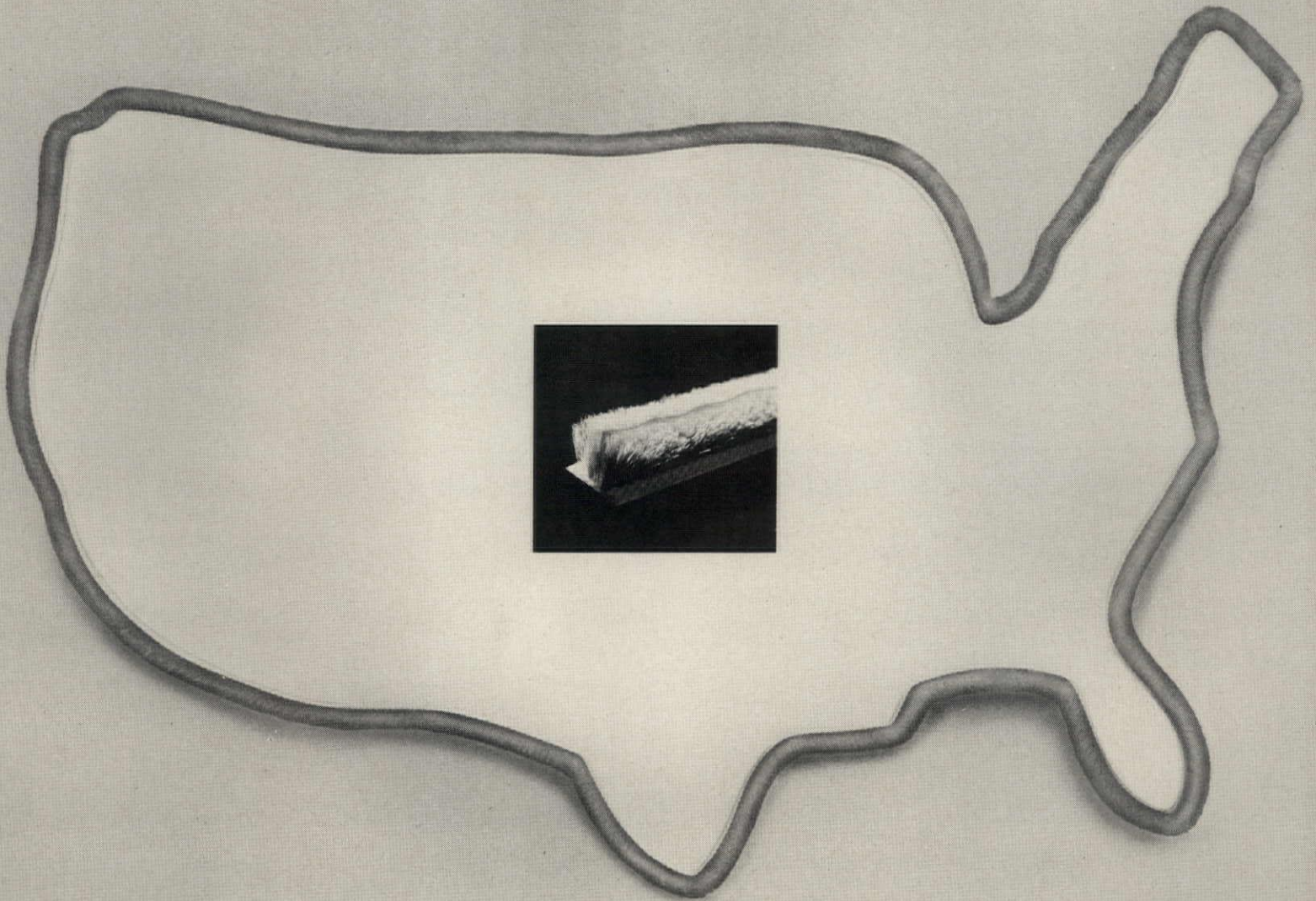

Our Fin-Seal® weatherstripping cuts air and water and dust leaks better than any pile ever made.

So anytime you specify a door or window with Fin-Seal, you're getting the best door or window you can put into your homes.

The "fin" part is a polypropylene barrier to stop leaks. Then we support it with Poly-Pile® on either side. So you have two things working for you.

But the names of the people who use it on their doors and windows will prove our point a lot faster than anything we can tell you here.

Acorn. Alcoa. CE Building Products. Crestline. De Vac. Norandex. Reynolds. Rusco. Season All Industries. Weathershield. Write for a complete customer list and a sample of Fin-Seal.

Then start giving the air to unwanted air.

Schlegel®  Meets AAMA specifications

The Schlegel Manufacturing Company
Industrial Products Division
P.O. Box 197
Rochester, N.Y. 14601

Now... 'built-in' fireplaces from Martin.

Because Martin Fireplaces are designed and engineered for ZERO CLEARANCE, they can be built in anywhere. On any floor. Against any wall, combustible or not!

Installation is quick and easy. After the unit and flue are assembled, there's nothing more to do but trim out the fireplace to suit individual tastes.

Since there's no need for a special foundation or masonry chimney, a Martin "Build-In-Anywhere" Fireplace can be installed for a great deal less than an ordinary masonry fireplace. Which makes a Martin Fireplace a great deal all around!

Discover for yourself the economy, convenience, comfort, and charm of a "Build-In-Anywhere" wood burning fireplace by Martin.

Martin offers a complete line of quality fireplaces, such as: Free-Standing, Built-In, and Wall-Hung in gas, electric, and wood burning models.

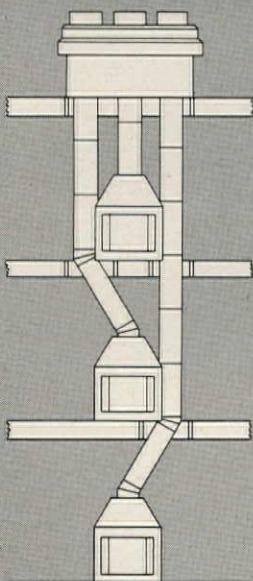
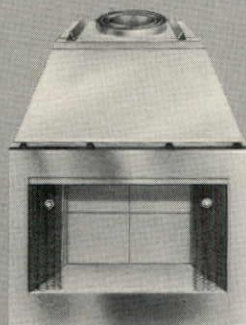
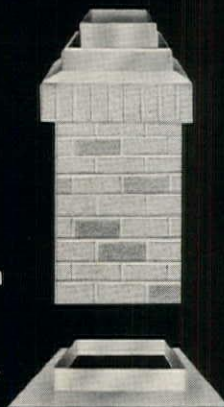

Multi-Story Installations

FEATURES:

1. Flush front design. . .no holes or air intakes
2. Tapered shape for minimum corner installation
3. No special starter sections required as other manufactures. Simplifies stocking.
4. Round 3 wall pipe with 30° offset elbows.
5. Round contemporary or simulated brick roof-top terminations.
6. Simple, fast installation requiring no foundation.
7. Designed for multi-story installation where units may be stacked directly above one another.
8. UL listed.
9. Another builder "Profit Product" from Martin.

Patents Pending

Shouldn't
your
business
get what
it's
paying for,
too?



No matter how much your business uses and depends on mail service, you're not getting your money's worth . . . unless you use ZIP Code.

It doesn't matter whether you're sending out an invoice. Estimate. Announcement. Brochure. Or what.

A ZIP Coded letter requires fewer sorting operations at your local Post Office.

Which means it has a better chance of getting out earlier.

And into your customer's hands sooner. (Even if he lives in the same town.)

Can you think of a better deal for three seconds of your time?

Mail moves the country -
ZIP CODE moves the mail!



advertising contributed for the public good

M MARTIN

FIREPLACE PRODUCTS DIV.
MARTIN STAMPING & STOVE
P.O. BOX 1527
HUNTSVILLE, ALA. 35807

ZIP CODE CAMPAIGN
BUSINESS PRESS AD NO. ZC-1423-70
2 1/4" x 10" (110 Screen)

“COND OMIN IUMS”

SOLVING THE KEY PROBLEMS OF **MARKETING AND MANAGEMENT**

“CONDOMINIUMS,” presented by **amr** and **House&Home**

Many other seminars and meetings have discussed condominiums. This is the one seminar that confronts the key problems and answers your questions. It can lead to greater profits for your organization.

House & Home and AMR have assembled a faculty of outstanding Condominium experts to share their experiences with you in a vital 2-day seminar.

Learn how to research the Condominium marketplace, how to deal with legal and financing problems, how to think like a Condominium developer. Learn how to merchandise and market the Condominium.

Learn why the Condominium, if handled properly can be the key to your success in the 1970's.

For additional information, please complete and return the coupon.

ATLANTA, NOVEMBER 16-17

The Executive Park Motor Inn

DALLAS, DECEMBER 11-12

The Fairmont

LOS ANGELES, JANUARY 18-19

The Sheraton Universal

amr international, inc.
ADVANCED MANAGEMENT RESEARCH
1370 Avenue of the Americas, New York, N.Y. 10019 (212) 765-6400

House & Home—AMR
Condominium Seminar
1221 Avenue of the Americas
New York, New York 10036

Please send information on the Condominium Seminar.

NAME _____

COMPANY _____

STREET _____

STATE _____

ZIP _____

Look for our book...

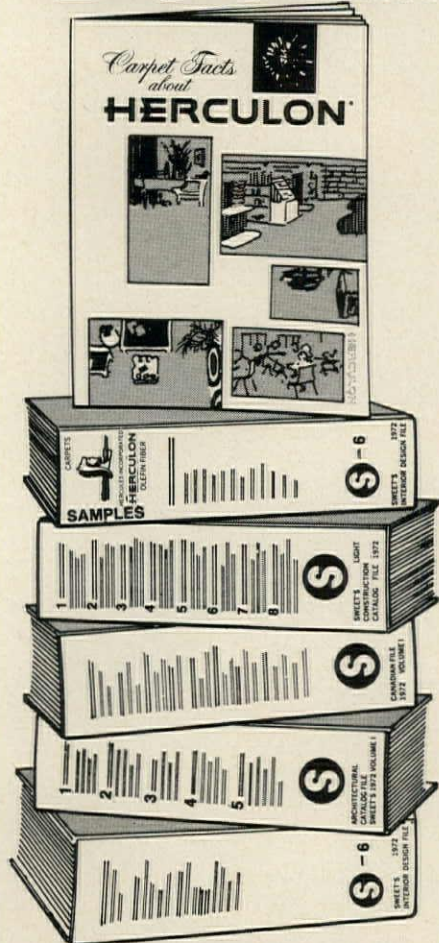

...in your books.

Our book is called Carpet Facts About HERCULON®. A colorful, 24-page booklet detailing the performance, construction, installation, maintenance and specifications of carpets made with pile of HERCULON* olefin fiber. You'll find it in four volumes of the 1972 Sweet's Catalog . . . Architectural, Interior Design, Light Construction and Canadian files.

A special swatched binder in Sweet's Interior Design file features a cross section of carpet constructions in HERCULON. It's a first for Sweet's . . . the first full volume of carpet samples ever assembled by a fiber producer.

We are doing all this for one very simple reason. The more you know about carpets of HERCULON, the more likely you are to specify them.



*Hercules registered tm—Hercules Incorporated

CIRCLE 188 ON READER SERVICE CARD

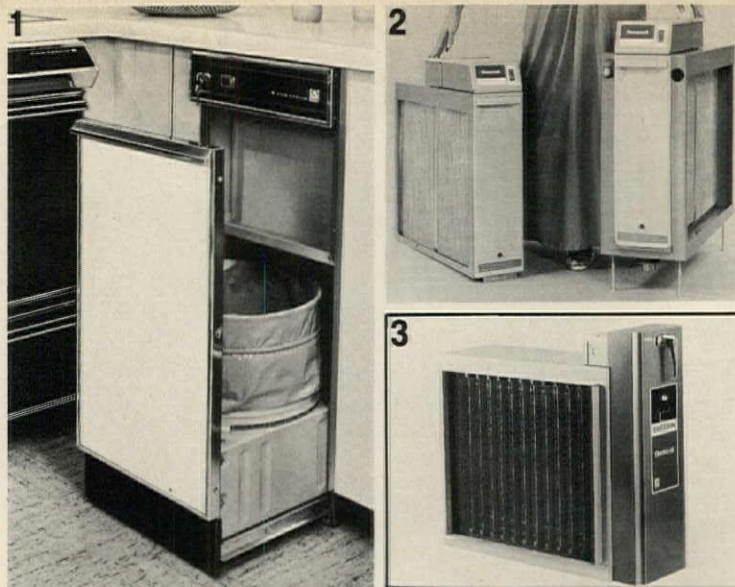

products: environmental

1. Built-in trash compactor comes equipped with four different color decorator-door panels. An optional cutting board top is available for freestanding use. The "XTC 500" reduces a seven-day accumulation of garbage from a family of four to one 25 lb. or 35 lb. bag. Unit is 15" wide, 24" deep and 34 $\frac{3}{8}$ " high. Modern Maid, Chattanooga, Tenn. *Circle 340 on reader service card.*

2. Electronic air cleaners available in manual-or automatic-wash units are designed for installation directly into heating and cooling systems. Devices remove up to 95% of the dirt and 99% of the pollen from the air that passes through them. Both types come in 16"x25" and 20"x25" models. Honeywell, Minneapolis, Minn. *Circle 341 on reader service card.*

3. Electronic air cleaner with slim-line design is suitable for installation into any type of forced-air furnace system. The unit is equipped with 1" duct flanges for tight connections. Solid state circuitry is used in the power pack. Electro-Air, Emerson, McKees Rock, Pa. *Circle 342 on reader service card.*

4. Hand-fed trash compactor is available with a chute attachment for multifamily housing. The heavy-duty "St-1 Masher" has an "Adjust-a-Pak" device that controls the weight and size of the finished trash package by signaling when predetermined limits have been reached. A deodorizer automatically discharges disinfectants into the chamber. Compackager, Washington, D.C. *Circle 343 on reader service card.*



The Caradco Sculptured Door

Elegance.

You get deep-carved panels fashioned from one-piece, wood-grained faces that can't split, check or shrink; a factory prime coat that welcomes paint or toned stain... that lets you suit the final finish to your fancy, be it avantgarde, traditional or in between. Result: it looks like more than it costs. And that's the beauty of it: *it costs less* than conventional panel doors.

We did even more with the door pictured. We

prefinished it with a smooth white factory coating, to bring out the full richness of the wood texture. It's easy to see why this *practical* eye-fel has tremendous buyer appeal. For more facts on Caradco Sculptured Doors, please call us or write.

Caradco Window and Door Division

Scovill

Main Plant, Dubuque, Iowa 52001 Eastern Assembly Plant, Hainesport, New Jersey Ohio Assembly Plant, Columbus, Ohio

CIRCLE 189 ON READER SERVICE CARD

VALLEY

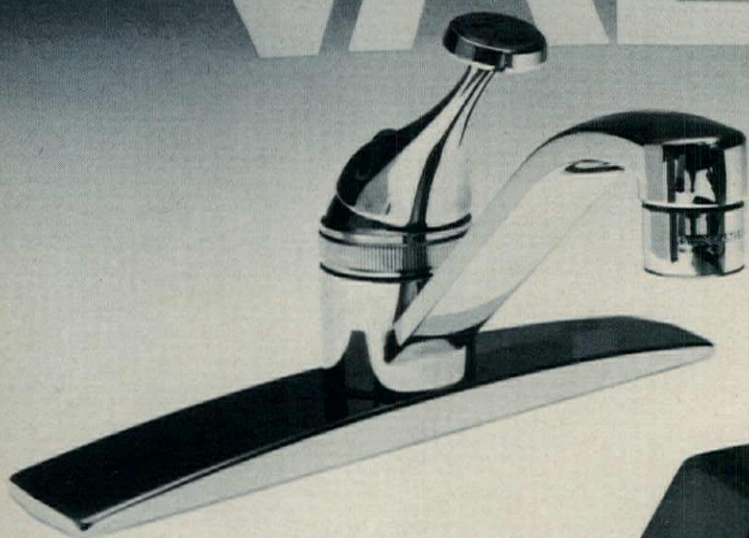

Just the right touch

For the feather-touch control it's Valley's deck model with the exclusive "hydroseal", leak-proof internal design. Many years of protection are yours with the mirror-like "tri-plate" chrome finish.

For the touch of added elegance, in the bathroom, Valley features the Starburst series. The Starburst design is the complete new shape in acrylic handles—a shape that sets both the water flow and temperature with just the right touch.

VALLEY FAUCET

EASTMAN CENTRAL D

a division of

UNITED STATES BRASS CORPORATION



SUBSIDIARY OF HYDROMETALS, INC.
901 TENTH STREET, PLANO, TEXAS 75074



January is NAHB Show month in Houston. Come by our booth #3541 and see the new leaders in single-control faucets and 33 other models with "Just the Right Touch."

We build our cabinets to be forgotten. First, we get them there as scheduled... individually cartoned to protect the "family-proof" finish. We make them simple to install... doors and drawers won't warp. Finally, they're priced to give you more value for the dollar.

Like fine furniture, KK cabinets enhance every decor. Decorating and accessories can change the mood from Mediterranean to Early American.

Yes, we build cabinets you can install and forget. The way we figure it, you'll never forget us for it.

Check the Yellow Pages for the distributor nearest you. Or write, Kitchen Kompact, KK Plaza, Jeffersonville, Indiana, 47130.



Forget
Them!



Rock Concert

Solid · Classic · Modern

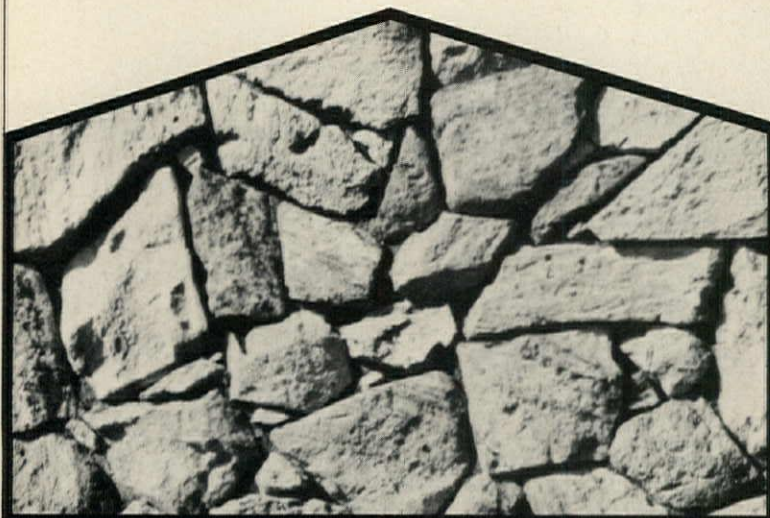

Natural stone says it all to the discriminating client. FEATHEROCK® decorative natural stone veneers make it possible on an unthinkable budget.

FEATHEROCK's no ordinary stone. Light weight and flat back. Works faster, applies to almost any surface. Imagine, no footings, anchors or building ties. Colors and textures. There are combinations for the special effect you want. I.C.B.O. approved. Architects: for complete technical information consult your 1972-1973 Building Stone Institute Catalog and write to us for a copy of our informative A.I.A. File.



Send me specifications _____ A.I.A. file _____ dealer listings _____ for FEATHEROCK® NATURAL STONE VENEERS.

Name _____

Company _____

Address _____

City _____ State _____ Zip _____

featherock® INC. Dept. HH-12

6331 Hollywood Blvd., Los Angeles, CA. 90028

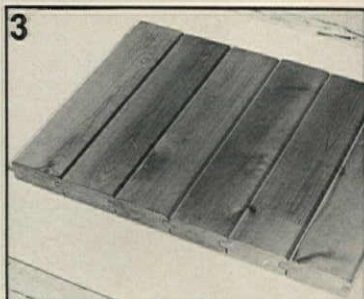
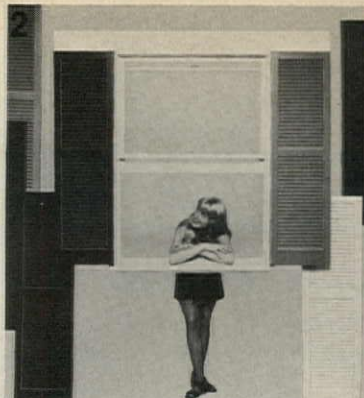

products: exteriors

1. Aluminum shutters with a baked enamel finish retain a fresh painted look for years without special maintenance. Designed to add a colonial touch to the house, the sturdy weather-resistant "Cross Buck" shutters are available in a wide range of colors and sizes. Alcan Aluminum, Warren, Ohio. *Circle 355 on reader service card.*

2. Wood-like shutters are molded from ABS polymer and protected from weather by a Korad acrylic finish. Previously available in black and white only, X-act® shutters are now offered in raven green, cocoa brown, barn red, moss green and island sand. Shutters are 1 1/4" thick for a solid, heavy appearance. Home Comfort Products, Princeville, Ill. *Circle 356 on reader service card.*

3. Laminated decking of alder hardwood is available in a variety of semi-transparent stains. Faces are machine sanded but can be custom cross-sanded or wire brushed. Decking is end-matched so joints need not be made over support members. Weyerhaeuser, Tacoma, Wash. *Circle 357 on reader service card.*

4. Colorful lightweight roofing is manufactured from formed galvanized steel sheets coated with a bituminous emulsion, impregnated with colored ceramic chips and finished with a fungus resistant sealer. Made to simulate clay or ceramic tiles, the material is easy-to-install for full-roof or decorative mansard application. Automated Building Components, Miami, Fla. *Circle 358 on reader service card.*

All the help you can get in multi-family housing: The Kingsberry Man.

CIRCLE 193 ON READER SERVICE CARD



It's forecast that approximately 50% of the housing starts this year will be multi-family. If you haven't moved into this market yet, now's the time to do so! And, nobody knows the multi-family housing market like the Kingsberry Man. He's ready to help you increase your building operation and profits in a number of ways. He'll offer you over 35 multi-family designs including apartments, duplexes, townhouses, and condominiums suited for conventional and FHA financing. He'll assist you with a marketing study to aid in determining if a project is financially feasible. A plot plan for preliminary mortgage submission. And the benefits of manufactured housing...high degree of cost control and 50% reduction in on-site labor. Blue prints too, at no cost, to meet specifications. Just fill out and mail the coupon, and see what it does for you...all the help you can get in multi-family housing...the Kingsberry Man.

KINGSBERRY HOMES

Boise Cascade Manufactured Housing Group

61 Perimeter Park, Atlanta, Georgia 30341

Frank D. Carter, Director-Marketing, Boise Cascade Manufactured Housing Group, Dept. HH-12, 61 Perimeter Park, Atlanta, Georgia 30341, (404) 458-9411

Yes, I would like all the help I can get.

Name _____

Firm _____

I presently have land available for (living units):

None, 1-25, 26-50, Over 50

No. apts. (living units) built in past 12 months:

None, 1-25, 26-50, Over 50

Address _____

City _____ State _____

Zip _____ Phone _____

Kingsberry Homes are distributed throughout a 38 state area of the Mid-West, Mid-Atlantic, Southeast, Southwest and New England states from plants located in Alabama, Iowa, Oklahoma, Pennsylvania and Virginia.



ALL RISING TO A GREAT PLACE
IS BY A SPIRALING STAIR

For more information on spiral stairs, custom
manufactured to your specifications, with choice
of treads, metals and finishes, write:



DUVINAGE CORPORATION
HAGERSTOWN, MD. 21740

CIRCLE 194 ON READER SERVICE CARD

U.S. POSTAL SERVICE

STATEMENT OF OWNERSHIP, MANAGEMENT AND CIRCULATION (Act of August 12, 1970: Section 3685, Title 39, United States Code).

1. Title of publication: **HOUSE & HOME**
2. Date of filing: October 1, 1972
3. Frequency of issue: Monthly
4. Location of known office of publication: 1500 Eckington Pl., N.E., Washington, D.C. 20002
5. Location of the headquarters or general business offices of the publishers: 1221 Avenue of the Americas, New York, New York 10020
6. Names and addresses of publisher, editor, and managing editor.
Publisher: James E. Boddorf, 1221 Avenue of the Americas, New York, N.Y. 10020
Editor: John F. Goldsmith, 1221 Avenue of the Americas, New York, N.Y. 10020
Managing editor: Maxwell C. Huntoon, Jr., 1221 Avenue of the Americas, New York, N.Y. 10020
7. The owner is McGraw-Hill, Inc., 1221 Avenue of the Americas, New York, New York 10020; Stockholders holding 1% or more of stock are: Donald C. McGraw, Elizabeth McGraw Webster, Donald C. McGraw, Jr. & Harold W. McGraw, Jr., Trustees under Indenture of Trust m/b James H. McGraw, dated 1/14/21 as modified; Donald C. McGraw, Trustee under an Indenture of Trust m/b James H. McGraw, dated 7/1/37 as amended; Donald C. McGraw, individually; Donald C. McGraw & Catharine McGraw Rock, as Trustees of the Estate of Mildred W. McGraw, all of 1221 Avenue of the Americas, New York, New York 10020; Firjer & Co. c/o First National Bank of Jersey City, 1 Exchange Place, Jersey City, New Jersey 07302, Harwood & Co. c/o State Street Bank and Trust Company, P.O. Box 5006, Boston, Mass. 02101; Perc & Company c/o Northwestern National Bank of Minneapolis, Minneapolis, Minnesota 55480; Pratt & Co. c/o Boston Safe Deposit and Trust Company, 1 Boston Place, Boston, Mass. 02106; Way & Co. c/o The Bank of New York, 110 Washington Street, New York, New York
8. Known bondholders, mortgagees, and other security holders owning or holding 1 percent or more of total amount of bonds, mortgages or other securities: None
9. Permission requested
10. Not applicable
11. Extent and nature of circulation

	Average No. Copies Each Issue During Preceding 12 Months	Actual Number of Copies of Single Issue Published Nearest to Filing Date
--	--	--

A. Total No. Copies Printed	111,202	110,678
B. Paid Circulation		
1. Sales through dealers and carriers, street vendors and counter sales	—	—
2. Mail subscriptions	104,456	103,300
C. Total Paid Circulation	104,456	103,300
D. Free Distribution by Mail, Carrier or Other Means		
1. Samples, Complimentary, and other free copies	5,653	6,579
2. Copies distributed to news agents, but not sold	—	—
E. Total Distribution	110,109	109,879
F. Office Use, Left-Over, Unaccounted, Spoiled After Printing	1,093	799
G. Total	111,202	110,678

I certify that the statements made by me above are correct and complete.

(Signature of owner)

McGraw-Hill, Inc.
By: JOHN J. COOKE
Senior Vice President & Secretary

changing
your
address?

ATTACH LABEL HERE

Please give five weeks notice before change of address becomes effective. Attach mailing label here and print your new address below. If you have any question about your subscription, include address label with your letter.

MAIL TO

House & Home, P.O. Box 430, Hightstown, N.J. 08520

your name

your mailing address

city

zip code

your firm name

firm address

city

zip code

type of business

your title or position

TO ENTER OR EXTEND YOUR SUBSCRIPTION,
CHECK HERE:

- NEW ONE YEAR \$9.50
 RENEWAL THREE YEARS \$19.00

MAIL REMITTANCE TO

House & Home, P.O. Box 430, Hightstown, N.J.
08520—Rates Apply to U.S. & Canada Only—

want
your
own
subscription?

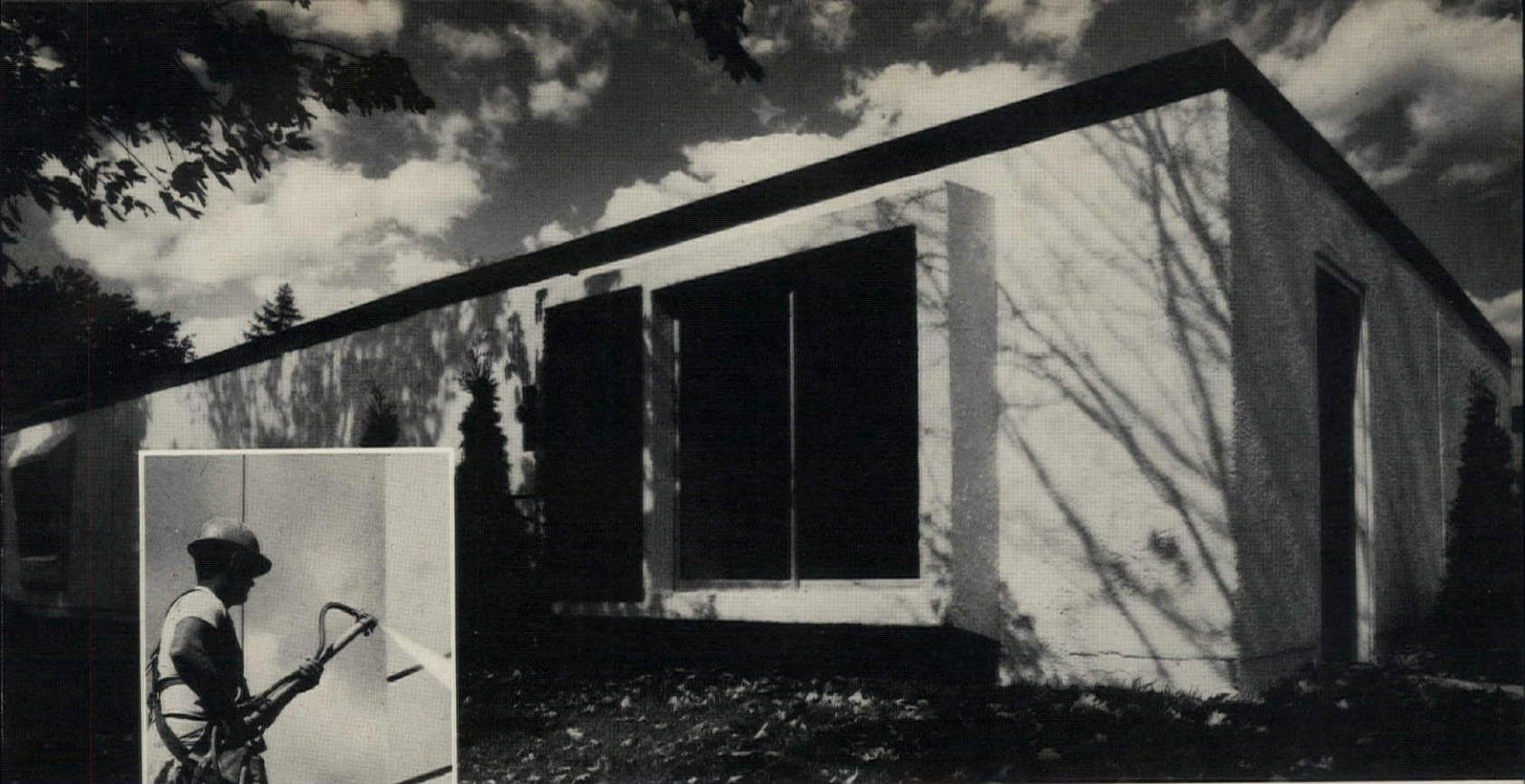

MODULAR HOUSING: Today's trend in modern housing—easily erected modules grouped according to specifications. These attractive units were permanently decorator-finished with cement-base THOROSEAL PLASTER MIX sprayed on with the versatile, dependable Thorogun. It sprays up to a 27" swath for fast, efficient applications. (Photo by R. M. Liselen)

Thoro System Products cover a wide range...finish and waterproof quickly and economically!

To keep up with today's varied construction needs, to help builders keep costs down, quality up, THORO SYSTEM has developed application tools for easy, economical use of THORO PRODUCTS. Thorogun is a specially designed spray gun for THOROSEAL PLASTER MIX and other spray-on products. It is a reliable, fast and efficient piece of equipment with simple operation.



HIGH RISE: Beauty, economy, waterproofing — all these in one remarkable finish, THOROSEAL cement-base coatings. Here THOROSEAL PLASTER MIX was applied to all exterior concrete surfaces, by trowel, and then floated, eliminating costly rubbing while adding years to the attractive look and life of this Texas building.

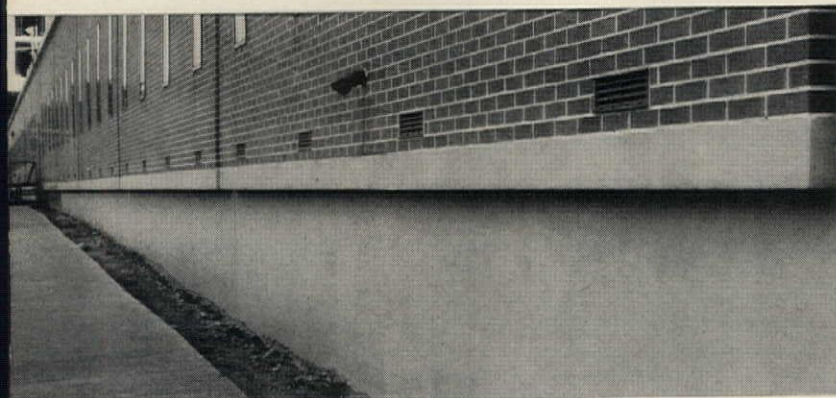

BASEMENTS — EXTERIORS: Based on the time-tested, cement-base THOROSEAL formula, but with coarser aggregates, THOROSEAL FOUNDATION COATING is specifically designed to protect and keep water out of exterior, below-grade surfaces, as well as beautify above-grade foundation areas. Easily applied with standard or special Thoro coarse fiber brush.



SDW 159

STANDARD DRY WALL PRODUCTS, INC.

DEPT. 73-HH-1 • 7800 N.W. 38th ST., MIAMI, FLA. 33166
CIRCLE 195 ON READER SERVICE CARD

H&H DECEMBER 1972 195

The hinge that hides

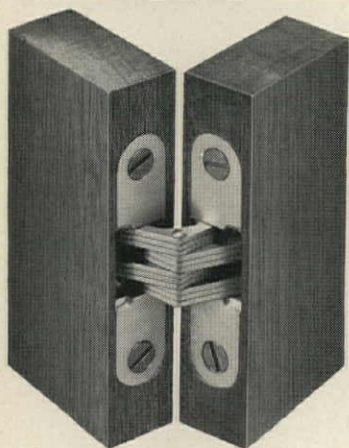

NOW YOU SEE IT

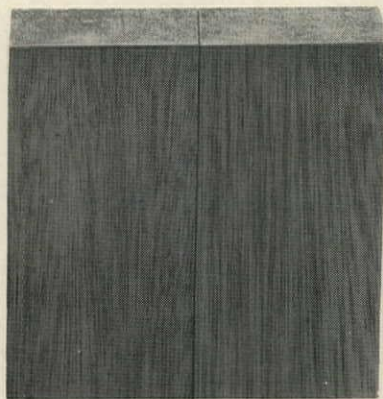

NOW YOU DON'T

The Soss Invisibles—for a custom look for any room! These amazing hinges hide when closed, eliminating unsightly gaps, hinges, and door jambs. They're the perfect hidden touch for doors, doorwalls, storage cabinets, built-in bars, stereos, and TV's. Specify the Soss Invisibles wherever looks matter. See listing in Sweet's or write for catalog: Soss Manufacturing Co., Division of SOS Consolidated, Inc., P.O. Box 8200, Detroit, Mich. 48213.



CIRCLE 118 ON READER SERVICE CARD

NINE REASONS WHY YOU SHOULD CONSIDER DELAWARE FUND

- 1 A diversified portfolio to reduce investment risks
- 2 Full-time professional management since 1937
- 3 An opportunity for your dollars to grow
- 4 As little as \$25 opens an account
- 5 Choice of a voluntary systematic investment plan or lump-sum payments at your convenience
- 6 Automatic reinvestment of any dividends or capital gains without a sales charge
- 7 Plans and services include reduced sales charges for volume purchases, automatic bank-draft investing and systematic withdrawal plans
- 8 Exchange privileges with other funds in the Delaware Group
- 9 Prototype corporate and self-employed investment plans

For a free prospectus, see your local securities dealer or return the coupon below.



Delaware Management Company, Inc. HH 12/72
7 Penn Center, Phila., Pa. 19103
Gentlemen: Please mail me a Delaware Fund Prospectus without obligation.

name _____
address _____
city/state/zip _____

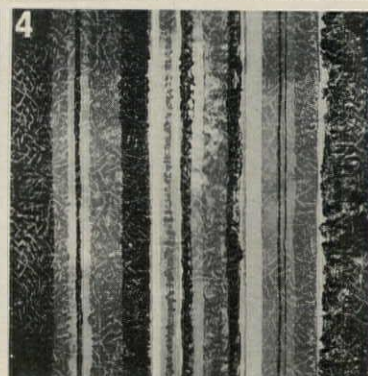

products: interiors

1. Acoustical ceiling tiles carry UL Class I flame-spread rating, permitting commercial as well as residential use. "Hallmark" has a washable finish. T&G detailing provides a virtually monolithic appearance. Tiles are 12" square. Simpson Timber, Seattle, Wash. *Circle 359 on reader service card.*
2. Ceramic wall tiles, in 3"x6" modules, join the "Matte Glaze" line. Fourteen colors are available, including spicy mustard, blue mist, lime green, lemon yellow, fresh avocado, fern and hydrangea. Florida Tile, Lakeland, Fla. *Circle 360 on reader service card.*
3. Prefinished hardboard paneling, with a simulated mismatched rosewood appearance, features narrow grooves, 8" o.c. Dentproof, marproof "Rosado" 4'x8' panels are easily maintained with a damp cloth. Masonite, Chicago. *Circle 361 on reader service card.*
4. Foil wallcovering acquires a three-dimensional look through a diverse blend of stripes. "Tangent", in six colorways, is one of 15 "Facets on Foil" designs. James Seeman Studios, Garden City Park, N.Y. *Circle 362 on reader service card.*
5. Plywood paneling, designed to enhance kitchen decor, is faced in rough-textured, grained cedar. Russet-toned, 5/16"-thick "Smokehouse Cedar" comes 4'x8', 4'x9' and 4'x10'. Core and back ply are Western softwood. Evans, Portland, Ore. *Circle 363 on reader service card.*



"When the architect who designed Sutton Place specified Delta Faucets, he made my job a lot easier!"

As Buildings Manager of Toronto's prestigious Sutton Place Hotel, James Strachan would be the first to know if Delta Faucets weren't all we say they are.

"When you've got as many faucets as we do, they've got to be more than just elegant. And in the six years we've had our Deltas, they've been practically maintenance free. The same goes for the Delta shower heads in our hotel!"

Every one of the 527 single handled Deltas at Sutton Place has dependability designed in. A patented rotating valve eliminates the need for compression washers and all the troubles that go with them.

What Delta has done for Sutton Place, it can do for you. Write Delta Faucet Company, Greensburg, Indiana 47240, Rexdale, Ontario. A Division of Masco Corporation.



James Strachan
Buildings Manager,
The Sutton Place Hotel

**Delta Faucets.
They're washerless.**

McKeon needed reasons. We gave them a drawer full.

McKeon Construction Company, one of the nation's leading builders of multifamily units, needed reasons for specifying Super Drawer. We gave them a drawer full. Here's what Glenn Knisely, Construction Manager of McKeon, Sacramento had to say after installing Super Drawer in hundreds of new kitchen units.

"The Super Drawer is the greatest innovation in kitchen cabinets to come along in years."

"Every unit we produce should have these drawers installed—we feel Super Drawer is an additional selling feature for our kitchens."

What does Robert Davis, President, Valley Cabinet and Manufacturing, Inc. say about following McKeon's specifications for Super Drawer?

"The drawer is just great . . . it's quick and easy to install. And women love the drawer because now they can

clean out a drawer and they don't have to line it."

Want to follow their reasoning further? Write today for a case history and complete specifications literature. Super Drawer. The drawer for all reasons.

Ajax Hardware Corporation

Scovill

825 South Ajax Avenue, City of Industry, California 91749



Glenn Knisely (left) and Robert Davis examine the Ajax Super Drawer.

See us at N.A.H.B.—Booth 1616



**How does
Ruf-Sawn 316
stack up against
raw wood
or composition
siding?**

**As good as both
and better than
either.**

Ruf-Sawn 316 is an entirely new plywood siding product. It has a resin-impregnated fiber surface designed for painting.

You paint it quicker, with less paint.

You will paint it less often.

Ruf-Sawn 316 gives you the superior structural advantages of plywood—higher strength-to-weight ratio, and greater racking strength without sheathing or corner bracing.

And, being 3/8" plywood, one man can easily apply it.

Ruf-Sawn 316 offers the paintability of a smooth overlay, the lightness and strength of plywood, and a natural, saw textured grain developed from real wood patterns.

In actual testing, it has extended paint life up to three times longer than raw wood.

The cost? Only slightly higher than standard paint-grade plywood. Use it once and you'll be a convert on the spot.

Ruf-Sawn 316 is available only from Simpson. If you have a Simpson supplier, ask him about it. If you don't, write us:
Simpson Timber Company
2000 Washington Building
Seattle, Washington 98101.

Simpson
Ruf-Sawn 316



**Give
Her
the Tile
She
Loves...**

It Costs No More with **Compotite**[®]

Shower baths now come in many forms... a mosaic tiled stall, a sunken tiled tub, or a Hawaiian type with garden backwall. These better designs have one thing in common... they feature the beauty and versatility of ceramic tile.

With Compotite waterproofing and the new stain-proof, tile-setting materials, a fully tiled shower bath will keep its lustrous beauty through years of use.

In most cases, the economy of Compotite waterproofing will result in a desirable fully tiled shower at no more than the expense of a plastic tub or receptor.



COMPOTITE SHOWER PAN, P.O. Box 26188,
Los Angeles, Calif. 90026 • Phone: (213) 483-4444

CIRCLE 119 ON READER SERVICE CARD



products: fireplaces

1. Gas-log fireplace set employs a jet burner to produce natural-looking flames with a minimum of contaminants. "Clean-Fire" comes 18", 24" or 30" with artificial oak or birch logs. It can be used with natural or LP gas. Clean-Fire Log, Belleville, Ill. *Circle 364 on reader service card.*

2. Built-in gas fireplace can be installed without masonry foundation. The unit uses standard 5" BW-type wall vent, needs 13" wall-depth and fits between standard stud spacing. Features include simulated-oak clay logs and ashes. Martin Stamping & Stove, Huntsville, Ala. *Circle 365 on reader service card.*

3. Prefab wood-burning fireplace, designed for 7'- to 8'-high rooms, installs without masonry founda-

tion, framing or structural changes. Featuring triple-wall construction for total insulation, the unit has a 32" firebox opening and 49"-wide, 29"-deep hearth. "Tudor" comes with matte black or pewter finished hood, stainless steel hearth and trim, and factory-installed firescreen. Majestic, Huntington, Ind. *Circle 366 on reader service card.*

4. Electric fireplace includes raised slate or brick hearth and flush firescreen. Series "4000" comes with flagstone (shown) or brick exterior. Optional accessories are electric log with or without heat, black or brass screen assembly and slate or Nevermar[®] mantels. Unit is 94" wide, 41" high, 24" deep. Mono-Line Industries, St. Joseph, Mich. *Circle 367 on reader service card.*

If your gas range won't do what Hardwick's will do it's time to replace it.

KEEPS THE SAUCE FROM BURNING.

The Burner-with-a-Brain* controls temperature automatically. Your food won't burn—and you save gas.

HOLDS FOOD AT SERVING TEMPERATURE.

There's a special keep-warm oven setting that holds food at just-right temperature, without drying it out.

CLEANS ITSELF WHILE IT COOKS.

Hardwick's EverKleen® Continuous Cleaning* gas oven has a special finish that cleans itself at ordinary baking temperatures.

*A.G.A. Marks



TELLS TIME THE MODERN WAY. New digital clock has big numbers you can read at a glance.

URNS THE ROAST DOWN AUTOMATICALLY. Even if you're not there, your Hardwick automatic oven watches the roast and turns it down when it's done.



Gas, clean energy for today and tomorrow.



AGA American Gas Association

HARDWICK
 © HARDWICK STOVE COMPANY • CLEVELAND, TENNESSEE 37311

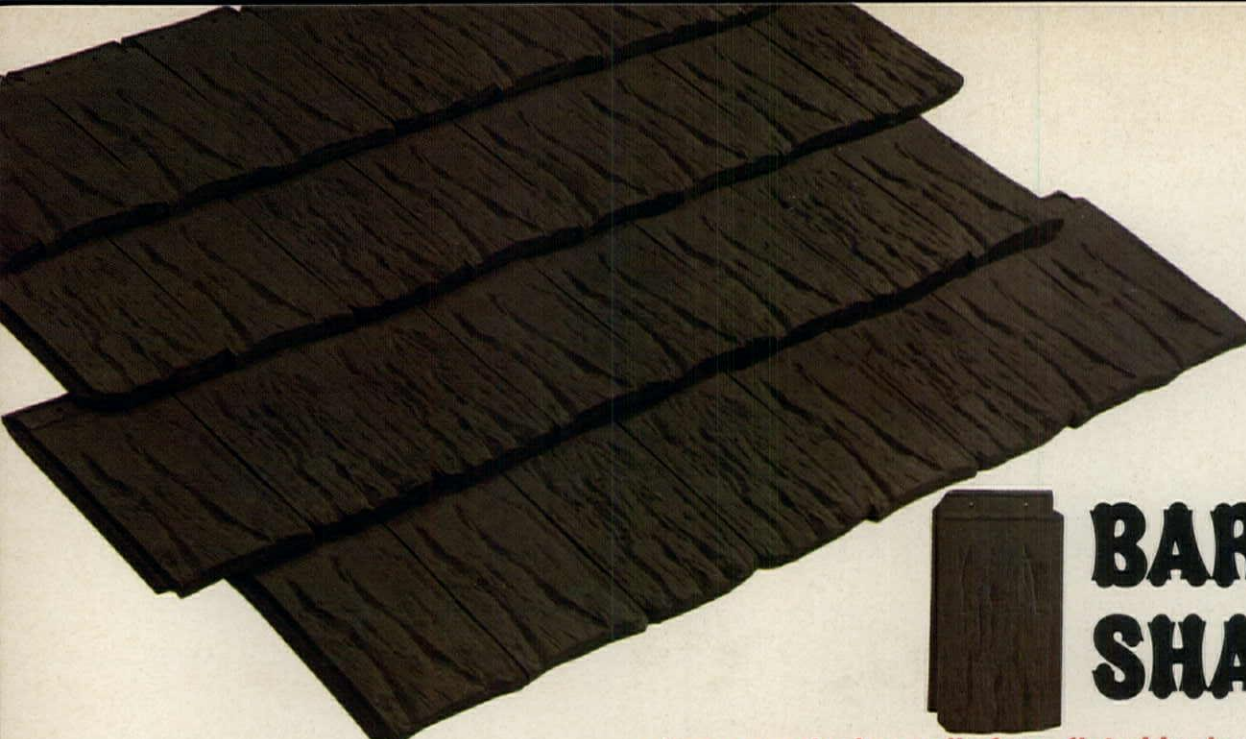

BARK TILE SHAKES

when your design calls for a flat shingle with a bold texture.

Bark Tile Shakes reproduce the look of deeply ridged tree-bark, the mellow color of aged cedar . . . and they are *permanently fire-proof*. Their heavy, irregular butt-line emphasizes the rough-hewn appearance and texture. Interlocking Bark Tile Shakes are weather-proof and decay-proof . . . assuring long years of roof-beauty for all types of structures: homes, churches, schools, institutions, commercial and public buildings.

Ludowici has two outstanding NEW Tiles *for permanent roof-beauty.*

CASA RANCHO One-Piece-Mission



when your design demands a massive roll-pattern tile.

The beauty of Casa Rancho Tile, in natural red or fireflashed Granada Red, is time-defying . . . impervious to fire, weather and decay.

The large size of Casa Rancho Tiles assures substantial savings on labor costs. Only 93* pieces per square means less installation man-hours.

When a building requires a Spanish or Mission type of roof, and cost is a factor, Casa Rancho is the answer.

*West Coast Standard—89 pieces per square
CIRCLE 187 ON READER SERVICE CARD



Consult your local distributor or mail coupon.



LUDOWICI-CELADON COMPANY

111 EAST WACKER DRIVE, CHICAGO, ILL. 60601 • Phone: (312) 329-0630

New Products/New Ideas in Tile

Please send me names of your distributors and more information on

- Bark Tile Shakes Casa Rancho Tile Have salesman call

NAME _____

FIRM _____ PHONE _____

ADDRESS _____ COUNTY _____

CITY _____ STATE & ZIP _____

**Ludowici Roofing Tiles
almost always outlast
the buildings they beautify.**

For additional information about Ludowici Roofing Tiles, see the 1972 Sweet's Catalog #7.6/Lu.

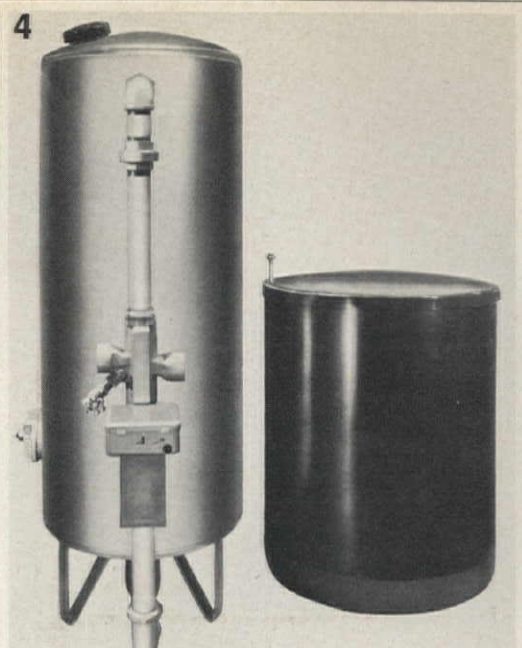
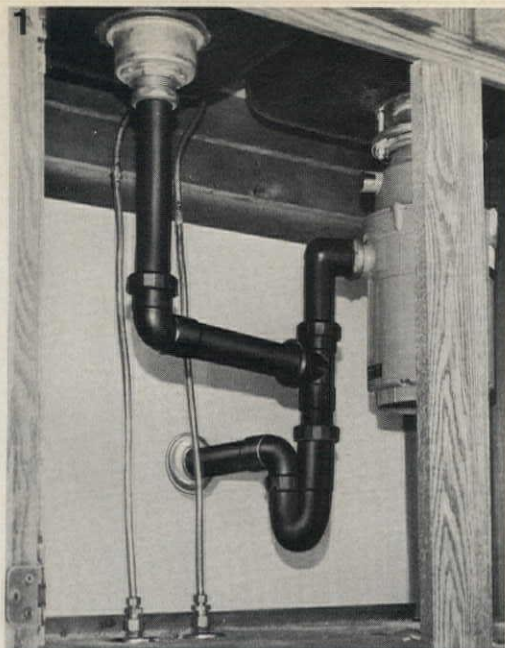

products: plumbing/pipes

1. Three continuous-waste assemblies of ABS thermoplastic corrosion-resistant material are easy-to-install in under-sink spaces. The lightweight units are for center- and end-outlet connections and are available in 1½"x12", 16" and 21". Celanese Plastic, Hilliard, Ohio. *Circle 372 on reader service card.*

2. Easy-to-install sump has a corrugated design that locks into back-fill and concrete floor. The strong, lightweight molded-plastic unit is rot- and rust-resistant and is not affected by acids, alkalis, freezing or thawing. Advanced Drainage Systems, Columbus, Ohio. *Circle 373 on reader service card.*

3. Full-flow bronze gate valve has a patented Teflon stem seal. The valve offers tight sealing and carries a three-year warranty on stem seal. The unit, utilizes two washers—one Teflon and one special rubber—suitable for water up to 250°F. Webstone, Worcester, Mass. *Circle 374 on reader service card.*

4. Water conditioner consists of a steel mineral tank and a fiber glass or polyurethane brine tank. It is available in eight sizes. Positive-action brass control valve, mounted on mineral tank, does not depend on water pressure for activation. Sta-Rite Industries, Delavan, Wis. *Circle 375 on reader service card.*



Benchmark—the Unbeatables.

- Deep-embossed steel elegance • Superior to any other bi-fold today
- Full 1¼" thickness tops everybody • Fast installing cuts labor costs
- New automated production plant—Excellent delivery

Outperforms Them All! Compare Benchmark Bi-Folds with any other door. 100% more rigid than ordinary bi-folds—extra thick, unique channel design, self-aligning hinges. Top quality at every price level!

Exclusive Deep-Molded Design. Tremendous pressure shapes each panel design from a single sheet of the finest 23 gauge steel. The result—a completely smooth surface. No applied trim to rattle, work loose, snag fabrics.



Benchmark Insulated Steel Doors—Deep-Embossed Beauty on Both Sides

Exclusive deep-molding process produces sculptured-steel elegance, coming and going. Prefinished and pre-hung, Benchmark Doors are complete and engineered for fast installing.

All the advantages of trouble-free steel. Special insulating "sandwich" has twice the heat-blocking value of wood door/storm door combinations. Choice of six deep-embossed designs (four with lights) plus flush door.

Fast Installing—just minutes! Engineered to save time. Features like snap-apart tracks for 2-panel or 4-panel widths—no measuring and sawing.

Nylon-Quiet Glide Ride. Nylon guide tips are precision-fitted. Nylon bearings and corner pivots, vinyl door stops, pre-lubed tracks, special sound-proofing designs—the quietest bi-folds available today!

Unlimited Openings, "Wood-looking" Styles. Benchmark lets you choose: Standard 6'8" and 8' heights; widths from 1'6" to 7'0" plus unlimited combinations. The Chateau and The Williamsburg reproduce authentic paneling details; louvered panel, full louver and flush models.

Write Today for details, or call Benchmark Sales Office (703) 373-8877.

GENERAL PRODUCTS COMPANY, INC.

P.O. Box 887, Fredericksburg, Virginia 22401

**Benchmark Steel Doors
Bi-Folds and Entrance Systems**

The big boys go with the leader!



Wood Bros. find U/R fiberglass bath rates A-1 in "public acceptance" test.

From a house-at-a-time start in 1950, brothers Bob and John Wood, Jr. of Denver have become housing giants in Colorado and the Southwest. The Woods attribute this outstanding growth to craftsmanship coupled with sound market research.

That's why they thoroughly pre-tested U/R's fiberglass one-piece tub-shower unit for prospective home-buyer reaction in a new development in Houston before making it a standard feature of their other communities. Report?

"We found the U/R fiberglass bath was very well received and maintenance advantages in particular were readily recognized by our customers."

Since then, Wood Bros. Homes, Inc. is installing U/R fiberglass units in its

new communities in Denver, Phoenix, Houston, Dallas, Oklahoma City, Tulsa and Albuquerque, and notes sizeable savings in installation time over tubs with tile surrounds.

Time saved cuts costs. So go with the leader and save. Look us up in Sweet's File 15.20/UN. And check the Yellow



Pages for your nearest U/R dealer or write Universal-Rundle Corp. New Castle, Pa. 16103.

Universal-Rundle

Paint job, PF-L style.

PF-L® siding from U.S. Plywood. The minimum-maintenance exterior that can turn your buildings into best sellers. Because it's surfaced with Tedlar.® A polyvinyl fluoride film that's just about the most durable exterior finish ever developed.

PF-L comes clean with a simple hosing. Even really difficult staining agents, such as roofing tar, wipe off with soapy water, solvents or detergents.

Thanks to Tedlar, PF-L is unaffected by the usual weatherers like chemicals,

soil, salt air, sandstorms, rain, hail and extreme temperature.

It has great color stability, too. And because PF-L is naturally resilient hardboard, it resists dents, gouges and other damage.

Another advantage of PF-L is that it's a money-saver to install. Finished walls can be put up in any weather, by ordinary workers, with conventional carpentry tools, either direct-to-stud or over sheathing.

PF-L is available in Lap or Board and

Batten. In Shell White, Granite Gray, Doeskin, Georgian Gold and Bayberry, with a full line of Tedlar surfaced accessories to match.

PF-L. A great way to build in minimum maintenance in multi-family and single-family dwellings. For more information, contact your local U.S. Plywood Branch Office.



U.S. Plywood

A Division of Champion International
777 Third Avenue, New York, N.Y. 10017

CIRCLE 125 ON READER SERVICE CARD



New Lines from Andersen

PERMA-SHIELD (R)
GLIDING WINDOW.
WORTHY ADDITION TO
PERMA-SHIELD LINE

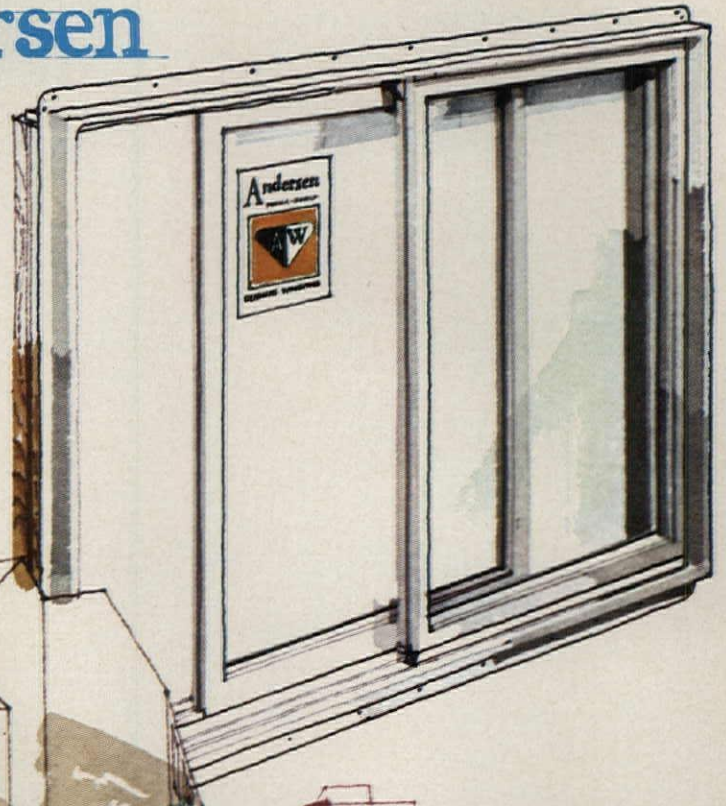

ABSOLUTELY NO PAINTING NEEDED —
FRAME AND SASH BOTH VINYL
SHEATHED. BIG DOLLAR SAVING
ON MAINTENANCE.

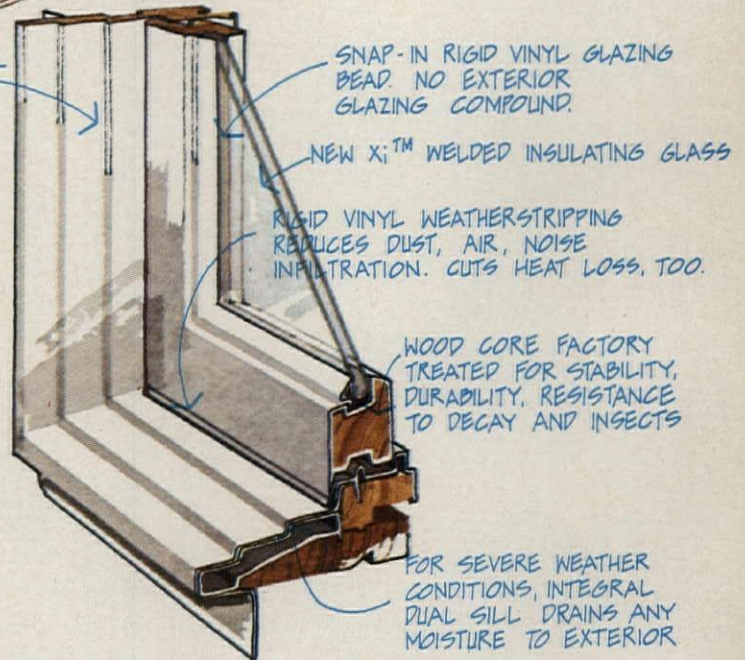

SNAP-IN RIGID VINYL GLAZING
BEAD. NO EXTERIOR
GLAZING COMPOUND.

NEW xi™ WELDED INSULATING GLASS

RIGID VINYL WEATHERSTRIPPING
REDUCES DUST, AIR, NOISE
INFILTRATION. CUTS HEAT LOSS, TOO.

WOOD CORE FACTORY
TREATED FOR STABILITY,
DURABILITY, RESISTANCE
TO DECAY AND INSECTS

FOR SEVERE WEATHER
CONDITIONS, INTEGRAL
DUAL SILL DRAINS ANY
MOISTURE TO EXTERIOR

NEW xi™ WELDED INSULATING GLASS

ALL ANDERSEN WINDOWS AVAILABLE
WITH WELDED INSULATING GLASS
NOW HAVE xi. xi STANDS FOR
EXTRA INSULATION. INERT GAS
INSTEAD OF AIR GIVES INSULATION
VALUE OF 3/8" AIR SPACE IN
A 3/16" AIR SPACE



NOTE:
BOTH SASH EASILY REMOVABLE
FOR CLEANING. SAFETY FEATURE:
CAN'T BE DONE ACCIDENTALLY.



PERMA-SHIELD SHUTTERS

DECORATIVE SHUTTERS BUILT TO ANDERSEN QUALITY STANDARDS. NO PAINTING. TREATED, FACTORY-PAINTED, WOOD FRAME MEANS STURDINESS WITH LIGHTNESS. VACUUM FORMED VINYL SHOWS WOOD GRAIN... HAS LOOK OF PAINTED WOOD.

GOOD RANGE :

- 2 STYLES (PANEL AND LOUVER)
- 2 COLORS (BLACK AND WHITE)
- 2 WIDTHS (14" AND 18")
- 10 HEIGHTS (35" TO 80")

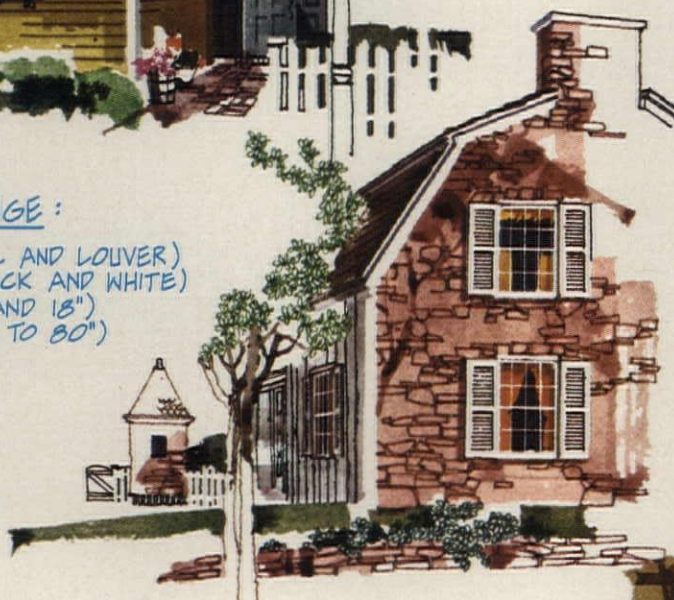

COLONIAL-STYLE SHUTTER DOGS

OPTIONAL - NOT NECESSARY FOR HOLDING SHUTTERS OPEN, BUT NICE TOUCH OF AUTHENTICITY.

TERRATONE

NEW URETHANE-TYPE FACTORY FINISH, ELECTROSTATICALLY APPLIED, AVAILABLE ON FLEX-PAC™ WINDOW LINE.

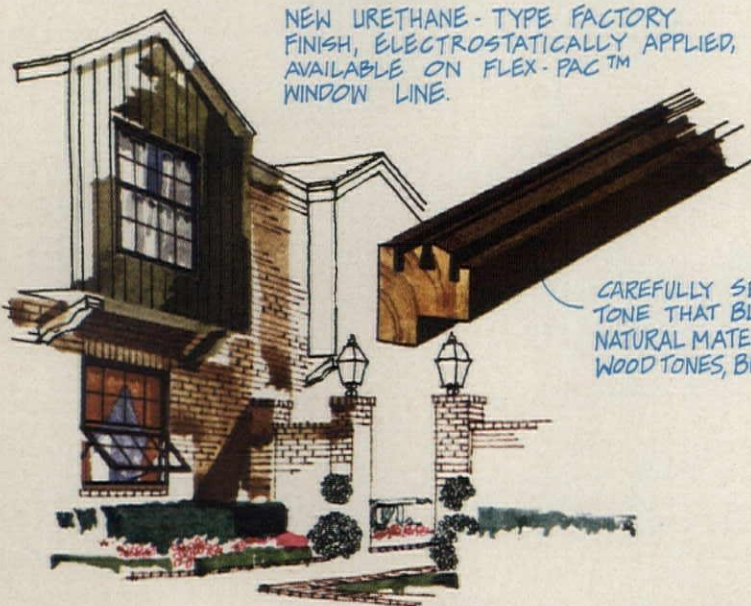

CAREFULLY SELECTED TONE THAT BLENDS WITH NATURAL MATERIALS, WOOD TONES, BRICK, STONE, ETC.

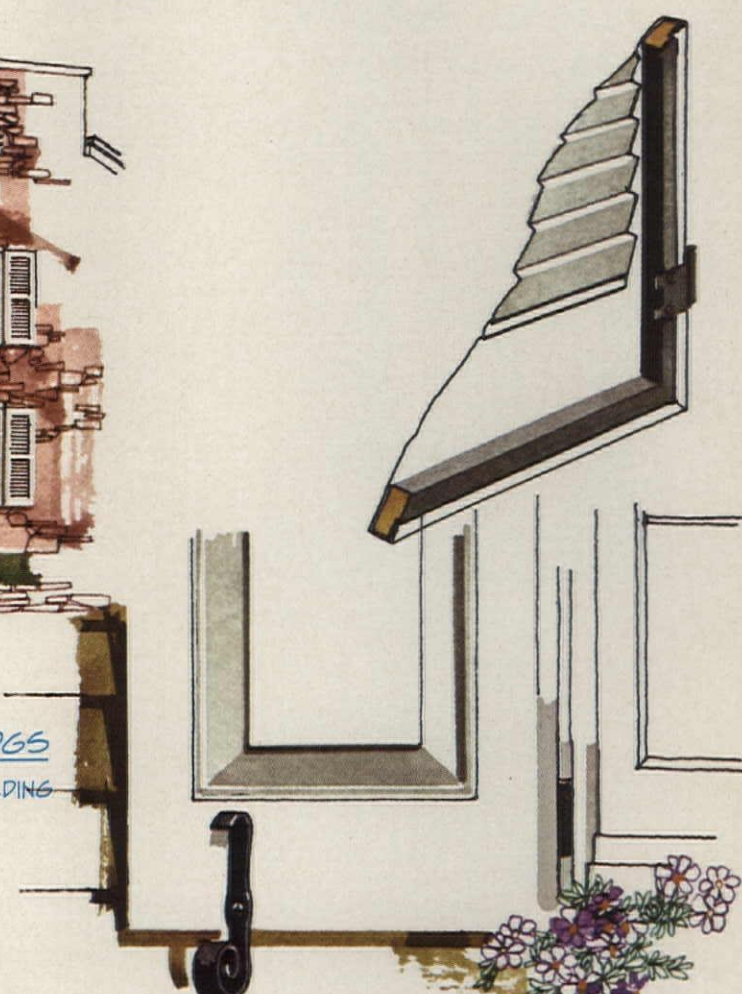

- ANDERSEN LINE KEEPS GROWING
- ABOVE ITEMS ARE IN ADDITION TO:
 - PERMA-SHIELD (R) AND ALL WOOD CASEMENTS
 - PERMA-SHIELD NARROWLINE (R)
 - FLEX-IVENT (R)
 - FLEX-PAC™, ETC.

INFORMATION IN SHEETS (8-16/Am)
OR WRITE: WINDOWALLS
ANDERSEN CORPORATION
BAYPORT, MINNESOTA 55003

Andersen Windowalls 
ANDERSEN CORPORATION BAYPORT, MINNESOTA 55003

Visit us at NAHB. Booth 2410. See all the new Andersen products.

show 'em a better way: raywall baseboard heating

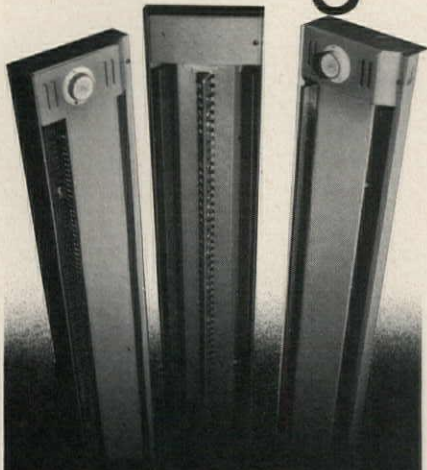

For new construction or remodeling of homes, cottages, motels, apartments, institutions, and offices, Raywall baseboard heaters offer a better way. All models feature attractive straight line design, finned tube element and continuous capillary (fail-safe) thermal cutout.

Raywall baseboard heaters are easily installed. Standard sizes can be combined to fulfill any heating requirement, and all models may be controlled with inbuilt or wall thermostats. Thermostats and accessories are adaptable to wiring compartments at either end.

Baseboard heaters BB Series and BH Series are available in 11 lengths... from 2 feet to 12 feet. The FB Series heater is available in 8 lengths... from 2 feet to 10 feet.

Specify Raywall Baseboard Heaters—a better way to solve heating problems.

We'll show you a better way. Write for our new general products catalog.



**THE
ELECTICOLOGY
COMPANY**

A Division of Tennessee Plastics, Inc.
P.O. Box T, C R S Johnson City, Tn. 37601
Phone 615/928-8101 Telex No. 55-3442

CIRCLE 128 ON READER SERVICE CARD

LITERATURE

Sliding hardware is described and illustrated in an eight-page, four-color pamphlet. Each product in the line including door, drawer, hospital, drapery and shelf hardware, is individually discussed. Applications are examined and pictured. Grant, West Nyack, N.Y.

CIRCLE 404 ON READER SERVICE CARD

Vinyl floors, in Orient-inspired patterns, are shown in ten full-color room settings. Paragraphs describing each design include hints for furniture and accessory selection to complete the look. GAF, New York City.

CIRCLE 405 ON READER SERVICE CARD

Snow guards, pipe-and-baseplate systems to prevent mini-avalanches from toppling off pitched roofs, are cataloged. Roof strainers and hinged leader straps are also described. Specifications for all products are included. David Levow, South Hackensack, N.J.

CIRCLE 406 ON READER SERVICE CARD

Cold weather concreting is discussed in an 8½"x11" bulletin designed to be posted on jobsites. Workable temperatures for concrete and areas to be concreted are provided along with helpful suggestions on how to achieve the control needed. Also listed are minimum time periods needed by various types of concrete for protection against the cold. Master Builders, Cleveland, Ohio.

CIRCLE 407 ON READER SERVICE CARD

Multi-use grille system is described and illustrated in a four-page brochure. Typical applications of the solid-cast aluminum "Integrille"—such as outdoor screening, space dividers and shelter walls—are shown. Detailed specifications on available sizes, physical properties and customizing possibilities are given. Playground Corporation of America, Long Island City, N.Y.

CIRCLE 408 ON READER SERVICE CARD

Buyers manual is a complete guide to plants, products and services available from members of Western Wood Products Assn. The 44-page directory also lists the association's wholesaler associates and members of Western Red Cedar Lumber and Fir & Hemlock Door Assns. Other data: names and locations of WWPA's field service representatives, rail freight costs, dimensional data for lumber and grading classifications. Western Wood Prod., Portland, Ore.

CIRCLE 409 ON READER SERVICE CARD

Steel wall studs, for use in light construction, are featured. Detailed in illustration and short text is the step-by-step installation of the non-load-bearing wall stud system. Advantages of its use are discussed. American Iron and Steel, New York City.

CIRCLE 410 ON READER SERVICE CARD

TO PAGE 214

ADVANTAGES OF LOCK-DECK® LAMINATED DECKING



EXCLUSIVE: Lock-Deck consists of 3 or more kiln-dried boards, offset to form tongue on one side and end, groove on the other, laminated with weatherproof glue. We invented it.

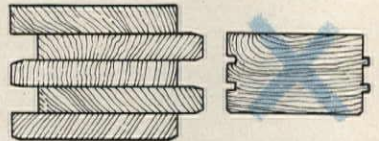

STRENGTH: Lock-Deck offers a range of E factors giving superior load-carrying values in spans to 20' or more in 5" thicknesses.

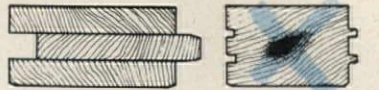

STABILITY: Each board in Lock-Deck is kiln-dried to 10-12% m.c. before lamination. This assures greater stability under all conditions.

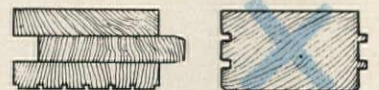

BEAUTY: One or both faces of Lock-Deck can be any desired grade, in a wide choice of species. Solid decking is limited in both grades and species.

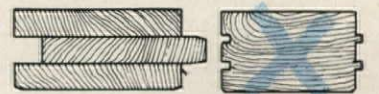

ECONOMY: In-place, finished cost of Lock-Deck is often less than solid decking due to speed of erection, factory-finishing, absence of waste, better coverage.

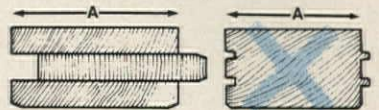

MORE COVERAGE: Offset tongue and groove on Lock-Deck gives more coverage per bd. ft. than machined solid decking.

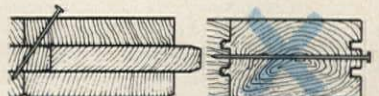

LESS LABOR: Lock-Deck installs quicker, using ordinary nails. Solid decking requires spikes, special fasteners or splines.



LESS WASTE: Offset end match, absence of twisting and few unusable shorts keeps waste well below that of solid decking.

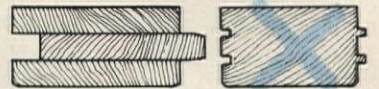

VERSATILITY: Lock-Deck forms excellent load bearing or curtain walls as well as floors and roofs.

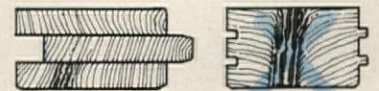

DURABILITY: Unlike solid decking, knots or checks can go through only one ply in Lock-Deck. Weather-proof glue and exclusive process make bond stronger than the wood itself.

Potlatch

WOOD PRODUCTS GROUP
P. O. Box 3591 • San Francisco Calif. 94119

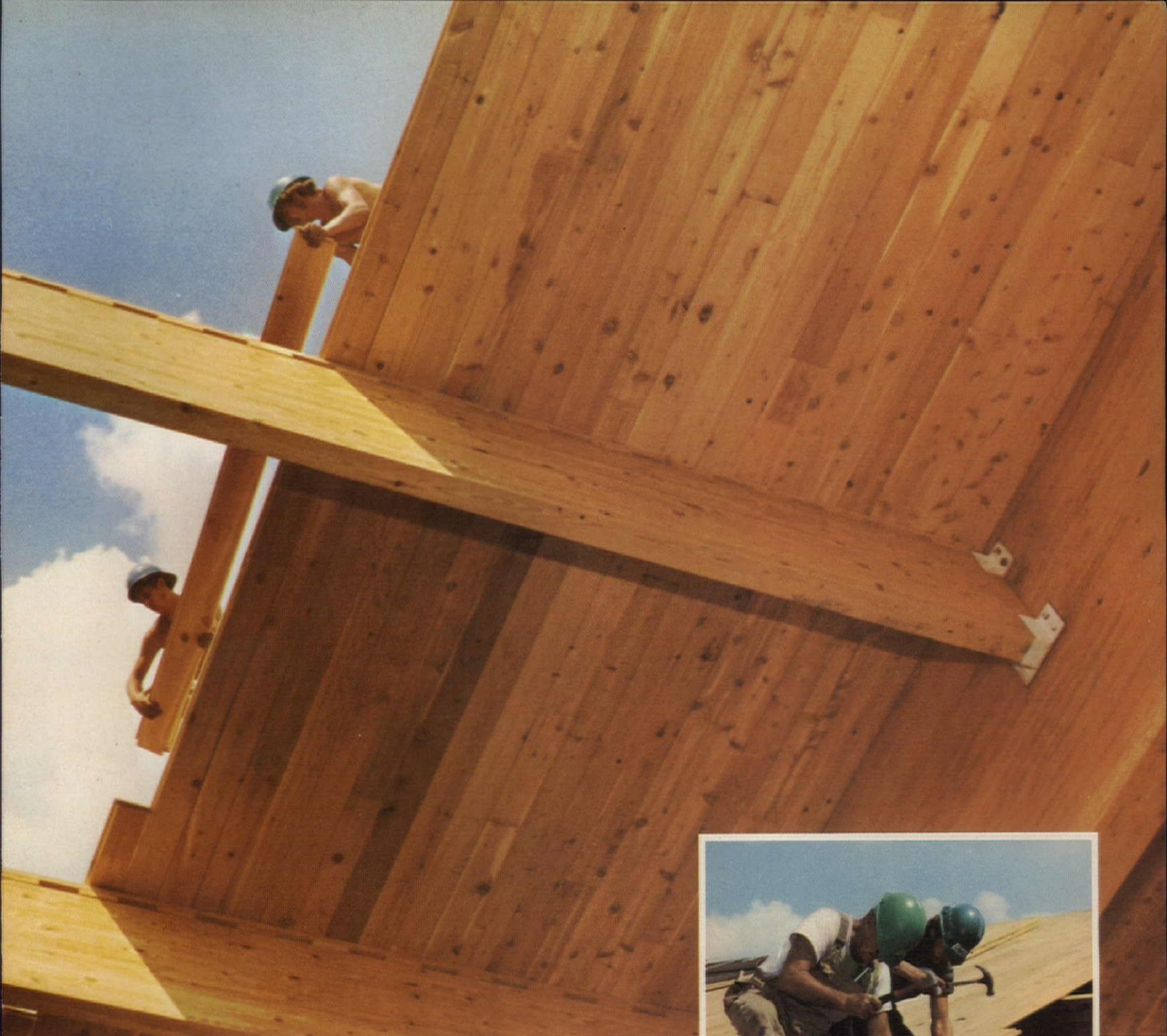

Richmond High Natatorium, Richmond, Indiana. Architects: R. W. Clinton & Assoc.

We invented Lock-Deck[®] the unique laminated building material

Lock-Deck is wood made better than nature could. Laminated of three or more kiln-dried boards under great heat and pressure, Potlatch Lock-Deck is available in four thicknesses from 3" to 5", nominal 6" and 8" width (10" and 12" in some species on inquiry) and lengths from 6' to 16', with 40' and longer available on special inquiry. Faces, in a choice of grades and species, can be

smooth-surfaced, saw-textured or wire-brushed and factory-finished in Colorific acrylic penetrating stains.

This opens a whole new world of architecture and construction. Lock-Deck forms both structural and finished wall and roof surfaces in one imaginative application. It forms superior wood walls, finished on both sides. It forms both structural roof or floor and finished ceil-

ing. It combines the unique warmth and beauty of wood with the superior strength and span capabilities of modern laminated members, and makes possible structural and aesthetic concepts not previously possible. Write for more information, Potlatch Forests, Inc., P.O. Box 3591, San Francisco 94119.

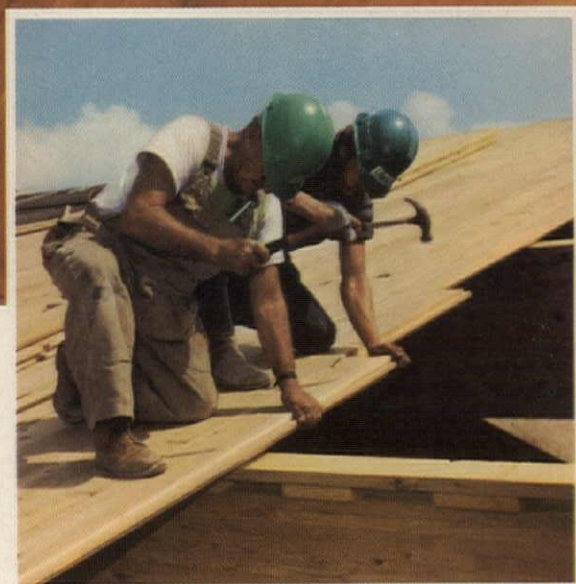

Potlatch

**superior's e-z-set/e-z-trim...
the only complete fireplace system.**

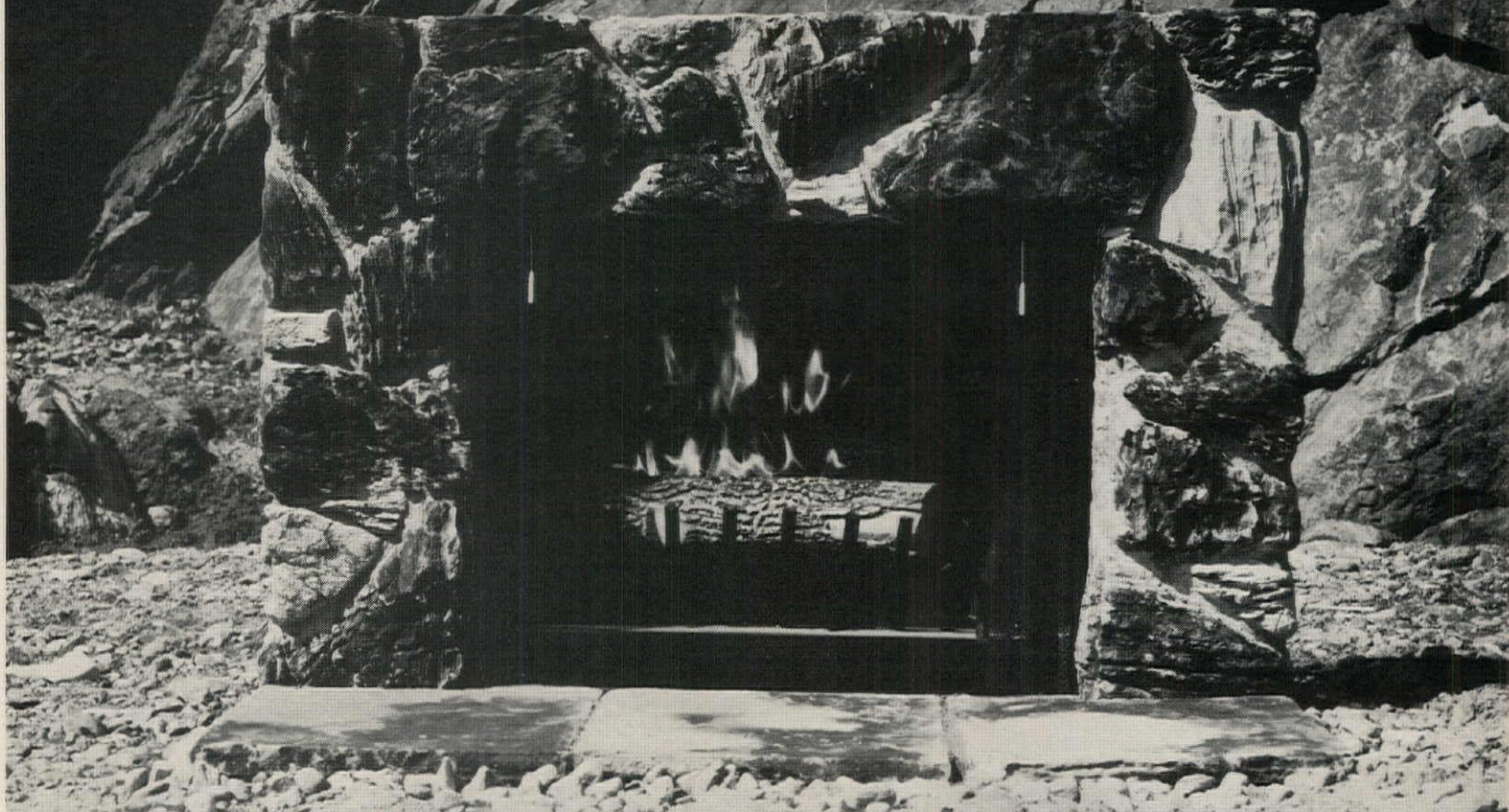

**looks more like the real thing
than the real thing.**

Now, from one source, you can buy Superior zero-clearance fireplace systems with the look and permanence of masonry. Seven E-Z-SET models are rugged as all outdoors... 20 gauge aluminized steel firebox sides and throat... 14 gauge steel bridge-type base... 18 gauge galvanized steel jacket. Solid, strong, lifetime fireplaces that don't take forever to install anywhere. Pre-assembled E-Z-SET fireplace systems go in easily and quickly without the high cost and profit drain of skilled labor. Flue sections snap together quickly without twisting or turning, with only

one inch clearance to combustibles required. Pre-punched nailing tabs insure fast, error-free installation.

Now, save even more labor and money with three realistic patterns of E-Z-TRIM pre-cast brick or stone facings and hearth. Interlocking sections feature simple mountings for fast and permanent installation.

Your Superior fireplace consultant is ready to show you more real cost saving ideas about our line. For immediate information or demonstration, call the closest Superior plant collect... ask for Mr. Mason. Or, send the coupon if you have a few days.



MODEL 036
See complete catalog in Sweets
Light Construction File.

FLAGSTONE



ROUGH
ROCK



USED BRICK

**superior
fireplace company**

Fullerton, Ca. (714) 521-7302 / Baltimore, Md. (301) 485-0001
QUALITY PRODUCTS TO REDUCE CONSTRUCTION COSTS

Superior Fireplace Company **HH-12**
P.O. Box 2066, Fullerton, Ca. 92633

- Send color catalog and technical details.
 Have your fireplace consultant call.

NAME _____
COMPANY _____
ADDRESS _____
CITY _____
STATE _____ ZIP _____
PHONE _____

Let's face it—almost every woman thinks her cooking is a creative art and that the kitchen is her studio. And when you're selling a house, you want to be able to offer the lady of that house exactly the kind of look she wants in her kitchen.

Arist-O-Kraft has the most beautiful faces in the kitchen cabinet industry, and there are many to choose from. But Arist-O-Kraft is not just a pretty face. It has a beautiful body, too. Every Arist-O-Kraft cabinet is constructed in steel frame clamps that guarantee absolute squareness and exact size, and perfect trouble free installations. Four steel corner braces in each base cabinet insure

we've
lots
of pretty
faces

that Arist-O-Kraft cabinets stay square and true—doors won't stick or buckle.

All surfaces are finished inside and out, and the easy-to-clean, removable drawers are so strong you can even stand on them. For a tough beautiful finish that resists stains and scars, Arist-O-Kraft can't be surpassed. United Cabinet created the first complete ultraviolet radiation sensitive curing line in the U. S. kitchen cabinet industry just so you could have more beauty and economy, and a tough finish, than was ever possible before.

Arist-O-Kraft cabinets sell kitchens, and beautiful kitchens help you sell houses.

CIRCLE 145 ON READER SERVICE CARD

and the
body to go
with
the
faces



AristO Kraft[®]

UNITED CABINET CORP.

Jasper, Indiana

47546 Ph: 812-482-2523

The Charmglow[®] Gas Lamp

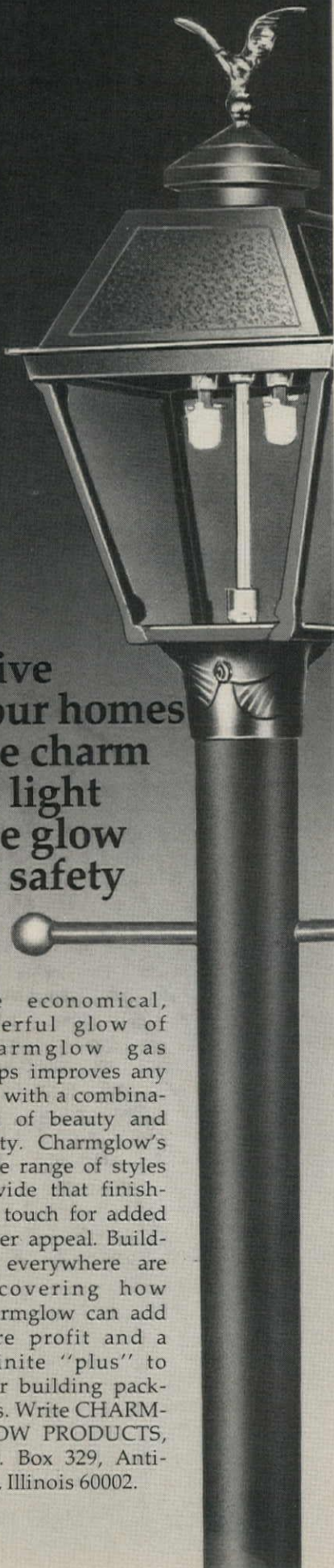

Give your homes the charm of light the glow of safety

The economical, cheerful glow of Charmglow gas lamps improves any site with a combination of beauty and safety. Charmglow's wide range of styles provide that finishing touch for added buyer appeal. Builders everywhere are discovering how Charmglow can add more profit and a definite "plus" to their building packages. Write CHARMGLOW PRODUCTS, P.O. Box 329, Antioch, Illinois 60002.

CIRCLE 147 ON READER SERVICE CARD

FROM PAGE 210

Hardwood flooring is pictured in 14 applications. Text and pattern diagrams supplement the photographs. Specifications and a color selection guide are included. Harris, Johnson City, Tenn.

CIRCLE 401 ON READER SERVICE CARD

Entrance mats, constructed of carpet-covered aluminum rails, are shown in color photos of actual applications. Twelve illustrations of available patterns and colors are included. Mat safety, fire resistance, absorbency and cleaning are discussed. Back page is devoted to descriptions of other protective products: bumper corner and door guards, kick plates, push plates and wall liners. DecoGard, Cranford, N.J.

CIRCLE 402 ON READER SERVICE CARD

Folding doors and room dividers are shown in color photographs. A guide for selection of color, texture and grain is divided into three categories of doors available: natural wood veneer, vinyl woodgrain, vinyl over steel and nylon/wood basketweave. Modernfold, New Castle, Ind.

CIRCLE 403 ON READER SERVICE CARD

Bathroom planning is illustrated in a booklet which discusses how to put the space available to use practically and attractively. Full-color pamphlet shows a variety of floor plans and includes a scaled grid and removable self-adhesive cutouts of fixture models for convenient planning. A one-page section on kitchen sinks is included. To receive "Bathroom Planning Guide", send \$1 in check or money order to Borg-Warner, Plumbing Products Div., Mansfield, Ohio 44902.

Drapery hardware is shown in 140 basic window treatments. Useful for planning hardware of model homes, the five-ring vinyl-covered binder holds full-color, sturdy pages of specification figures, photos of actual applications, complete lists of all drapery hardware needed for windows shown, instructions for figuring finished draperies. Mounting locations for hardware are included. Send \$5 for "Window Treatment Planning Guide" to Kirsch Co., Dept. BW, Sturgis, Mich. 49091.

Planters and waste receptacles of molded fiber glass are featured in an index-tabbed brochure. The entire 40-piece line is illustrated. Drawings of each style and a description of the available colors and finishes are included. Construction features and specifications are also provided. An accompanying four-page folder describes the firm's line of indoor/outdoor fiber glass benches. Seventeen models including several storage benches with removable tops are discussed. American Beautification Products, Bristol, Ind.

CIRCLE 411 ON READER SERVICE CARD



Handy 4' x 8' G & K CEDAR CLOSET PANELS need no finishing . . . go on like wallboard!



You just cut to size and nail or glue into place

Now it's easier than ever to add forest-fresh aroma and extra appeal of real cedar to the closets in your homes—with G & K CEDAR CLOSET PANELS. Made of compressed, large flakes of Tennessee Red Cedar, each panel fits snugly against its neighbor, without noticeable joint lines. Because G & K panels are so easy to install, need no finishing and have a textured pattern that conceals nailheads, you save, save, SAVE on installation costs! For full details, see your dealer or write:

cedar  closet panels

GILES & KENDALL, INC.
P.O. Box 188
Huntsville, Alabama 35804

CIRCLE 164 ON READER SERVICE CARD

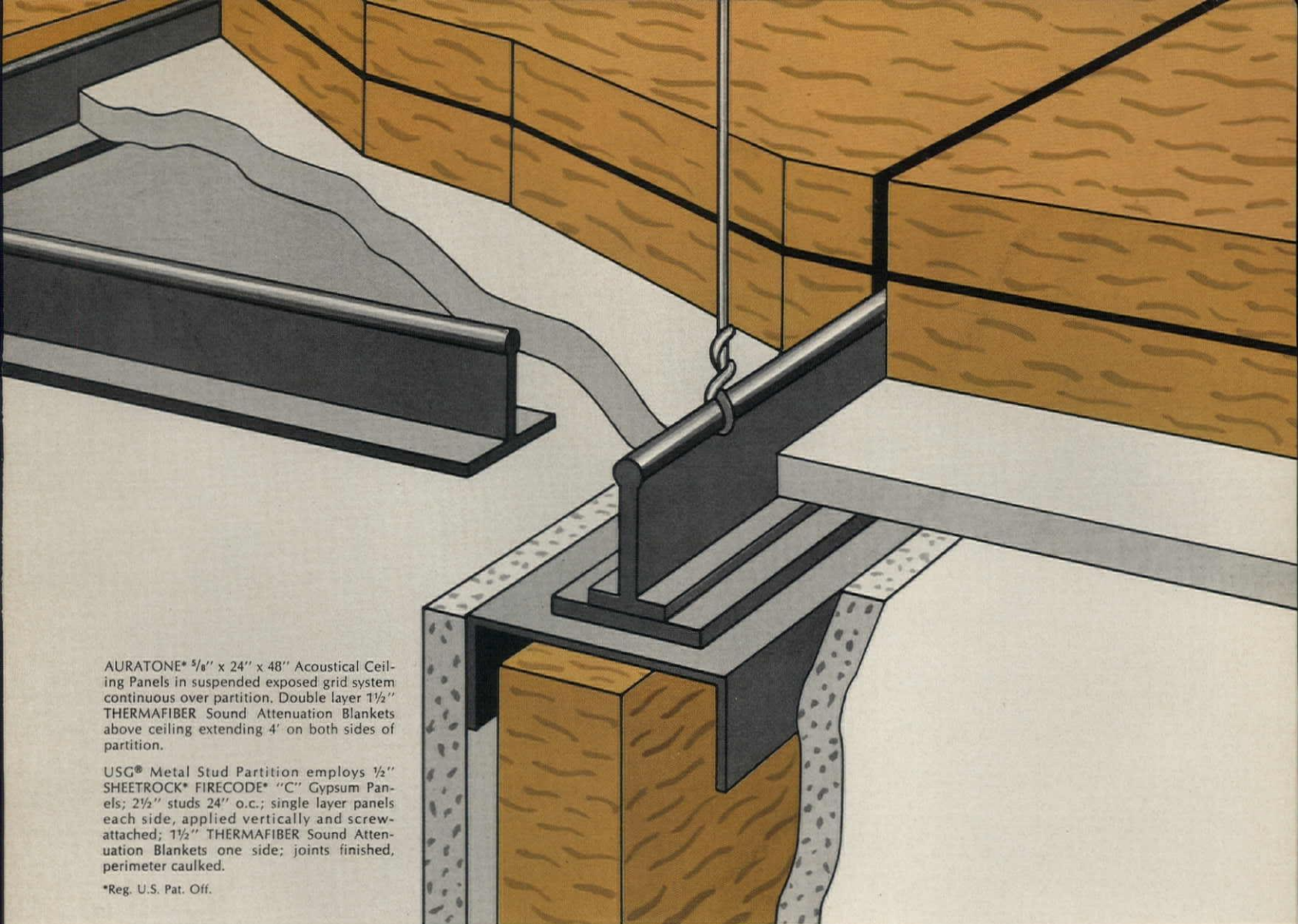

AURATONE* 5/8" x 24" x 48" Acoustical Ceiling Panels in suspended exposed grid system continuous over partition. Double layer 1 1/2" THERMAFIBER Sound Attenuation Blankets above ceiling extending 4' on both sides of partition.

USG® Metal Stud Partition employs 1/2" SHEETROCK® FIRECODE® "C" Gypsum Panels; 2 1/2" studs 24" o.c.; single layer panels each side, applied vertically and screw-attached; 1 1/2" THERMAFIBER Sound Attenuation Blankets one side; joints finished, perimeter caulked.

*Reg. U.S. Pat. Off.

THERMAFIBER® Insulation: the 3-in-1 blanket that has no "or equal" for systems performance

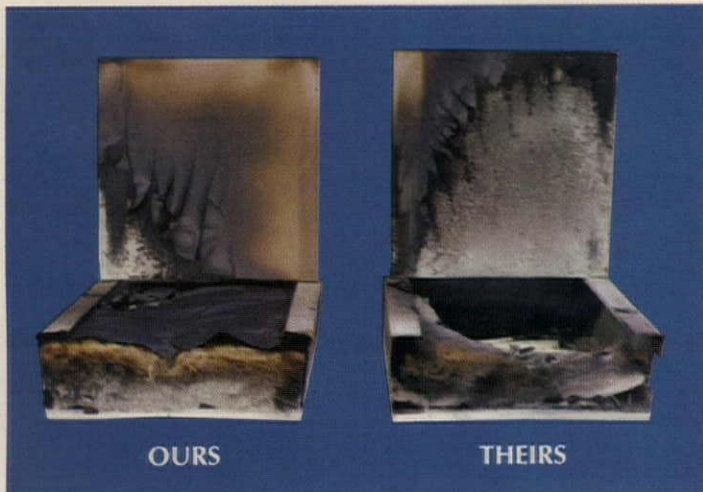

These photographs illustrate results of a recent 1-hour furnace fire test witnessed and certified by independent consulting engineers. Temperatures were controlled to follow the ASTM E-119 standard time-temperature curve. THERMAFIBER (left) and a glass fiber insulation (right) were tested in two identical partition panels for one hour. The result proved that THERMAFIBER adds an extra margin of fire safety to an assembly.

Before you specify, evaluate THERMAFIBER Products for all types of construction on 3 important counts:

- 1. SOUND ATTENUATION.** THERMAFIBER used as shown here achieved 45 to 48 STC ratings in single layer wall partitions, 45 to 49 STC ratings in ceilings.
- 2. THERMAL EFFICIENCY.** THERMAFIBER Insulation is used by leading curtain wall manufacturers in such buildings as the 109-story Sears Tower in Chicago, Diamond Shamrock in Cleveland, Detroit Edison, and 154 Wisconsin Center, Milwaukee.
- 3. FIRE RESISTANCE.** THERMAFIBER offers a 50% greater safety factor than glass fiber insulation which melts and loses flame resistance at about two-thirds the temperature required for THERMAFIBER. (See recent fire test results at left.) THERMAFIBER Insulation won't burn, disintegrate or support combustion under fire conditions as defined in ASTM E-119. Now THERMAFIBER can be used as safing (fire-stop) in all urban high rise construction markets where fire resistance is critical.

Specify THERMAFIBER Products with *all* the features you need in commercial as well as residential assemblies. See your U.S.G. representative. Or write to us at 101 S. Wacker Dr., Chicago, Ill. 60606, Dept. HH-122.

UNITED STATES GYPSUM 
BUILDING AMERICA

we've got you covered...

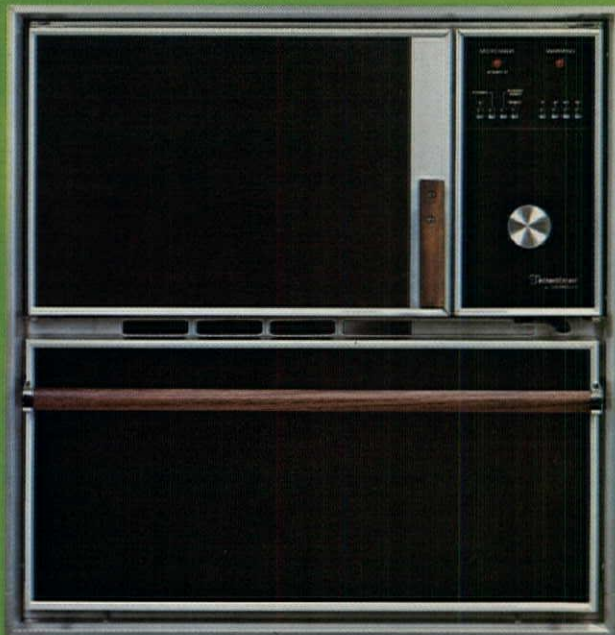

**(1) MTR 10 - BILT-IN COMBINATION
MICROWAVE/HOT FOOD SERVER - 240V***



(2) MTR 11 - BILT-IN - 115V

(3) MTR 12 - BILT-IN - 240V*



**(4) MTR 24 - BILT-IN COMBINATION
MICROWAVE/SELF-CLEANING OVEN - 240V***



**(5) MTR 30 - BILT-IN COMBINATION MICROWAVE/
HOT FOOD SERVER/SELF-CLEANING OVEN - 240V***

Available, January 1973

Complies with safety performance standards, Health, Education, and Welfare Rules 42CFR, Part 78.

*208V AVAILABLE ON SPECIAL ORDER.

...with 1, 2, 3, 4, 5, 6, 7 (COUNT 'EM)

THERMATRONIC RANGE MODELS

for you (and your customers)
to choose from!



(6) MC 11 - PORTABLE - 115V

(7) MCM 11 - PORTABLE "MARINER" - 115V

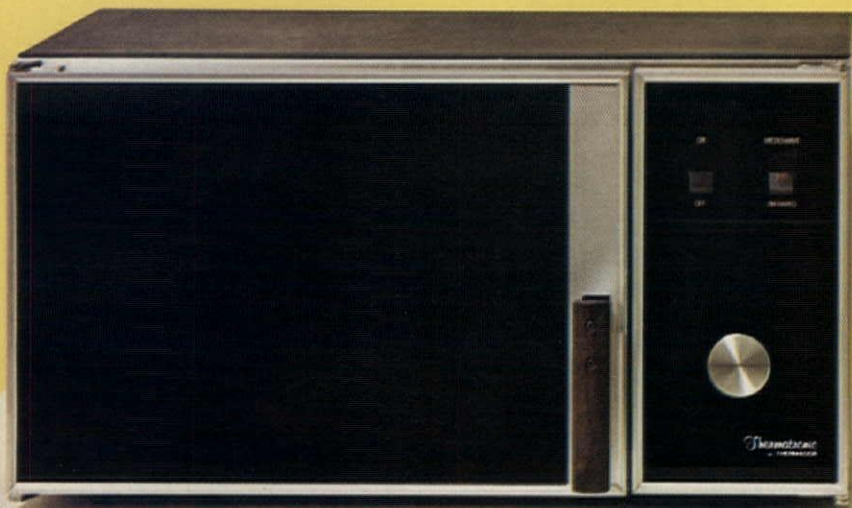

Richard Deacon, star of his own cook show, "Deacon Does It In the Kitchen."

Whatever model of Thermatron Range your customer wants — you've got — with Thermador. Whether she's thinking big — or small we've got you covered. She can build it in — wheel it around — combine it with a self-cleaning oven — or double it up with a Hot Food Server. Whatever combination she wants for the ultimate in microwave cooking, is hers with Thermador — manufacturer of the world's widest selection of quality microwave ranges — EVERY ONE WITH A BROWNING ELEMENT.

And we're covering you in ways to reach these customers, too. Richard Deacon, Star of "Deacon Does It In The Kitchen" will star in our national advertising campaign. He's pre-selling your customers in the pages of HOUSE BEAUTIFUL, HOUSE & GARDEN, BETTER HOMES & GARDENS, PLAYBOY, SPORTS ILLUSTRATED, TIME, SUNSET, and SOUTHERN LIVING.

Come on under — cover yourself with seven easy ways to quicker sales and greater profits. Get all details from

Thermador



The Elegant Difference in Microwave Ranges

5123 DISTRICT BLVD., LOS ANGELES, CALIFORNIA 90040

CIRCLE 168 ON READER SERVICE CARD



Put Pinocchio on your payroll.

What experience has he had? Same as Robinson Crusoe, Cinderella and real people, too, like Jim Thorpe, Martin Luther King, Juarez.

These are characters and people children want to read about. Children who read are not drop-outs. Your company won't spend dollars teaching them to read.

You see the difference every day between the job applicant who breezes through your application and the one who's intimidated by each blank space. The difference has lots to do with their interest in

reading. An interest that widens their world. Their vision. Their abilities. An interest that has to start young.

But millions of children today are growing up in homes where there are no books.

Getting books into their hands is what RIF does.

RIF means Reading is Fundamental. Since it was founded by Mrs. Robert S. McNamara in Washington, D.C., RIF has learned what gets a kid interested in reading: choosing the book he wants. And owning it.

RIF has distributed millions of books to children. The demand is growing.

All kinds of companies are helping.

There are business benefits for you.

RIF needs your support. Badly. We'd like to tell you more about how you can work with RIF and know its rewards.

Write to Mrs. Robert S. McNamara, RIF, Smithsonian Institution, Washington, D.C. 20560.



IF AMERICA IS TO GROW UP THINKING, **READING IS FUN-DAMENTAL**

No ifs, ands or buts.



Weyerhaeuser

Weyerhaeuser® Architectural Doors
PERFORMANCE GUARANTEE

Weyerhaeuser guarantees that its solid core doors which are properly installed by qualified installers will perform as described in the following table.

Door Type	Sound	Impact	Fire
2 1/2" Solid Core, Finished Pine	Good	Good	1 1/2 hours
2 1/2" Solid Core, Unfinished Pine	Good	Good	1 1/2 hours
2 1/2" Solid Core, Particle Board	Good	Good	1 1/2 hours
2 1/2" Solid Core, Mineral Core	Good	Good	1 1/2 hours
2 1/2" Solid Core, X-Ray	Good	Good	1 1/2 hours
2 1/2" Solid Core, Sound Retardant	Good	Good	1 1/2 hours
2 1/2" Solid Core, Mineral Core	Good	Good	1 1/2 hours
2 1/2" Solid Core, X-Ray	Good	Good	1 1/2 hours
2 1/2" Solid Core, Sound Retardant	Good	Good	1 1/2 hours

This guarantee applies to Weyerhaeuser's solid core doors of the type described in the table above. It does not apply to doors of other types or to doors which are not properly installed. The guarantee is void if the door is not properly installed. The guarantee is void if the door is not properly installed. The guarantee is void if the door is not properly installed.

Name _____
Address _____
City _____
State _____ Zip _____

Weyerhaeuser Company • Box 8 • Tacoma, Washington 98401 • 206-251-4100

This door guarantee means exactly what it says.

Weyerhaeuser® introduces a superior guarantee, in plain and simple language, to back up its quality line of architectural doors: staved core, particle core, mineral core, x-ray, and sound retardant. Exclusive dowel inserts provide positive door identification, so you know what you're getting and what to expect from it.

For complete door data and a full-size sample of our understandable door guarantee, mail coupon to Weyerhaeuser Company, Box B-9774, Tacoma, Washington 98401.

Name _____

Firm _____

Address _____

City _____

State _____ Zip _____



Weyerhaeuser

ADVERTISERS INDEX

A		A-I Bostitch (Textron, Inc.)169 <i>Creamer, Trowbridge, Case & Basford, Inc.</i>	A Del-Mar (Div. of U.S. Plywood)122 <i>Burton-Campbell, Inc.</i>
AMF Inc. (Cuno Div.)161 <i>Fuller & Smith & Ross, Inc.</i>	AMR/House & Home187, 158I-L	A-I Bradley Corp.40, 41 <i>Hoffman-York, Inc.</i>	A-L-D Delta Faucet Co.197 <i>Burton Sohigian, Inc.</i>
A-I-L AMSPEC74 <i>Kight Cowman Abram, Inc.</i>	A-L Advanced Drainage Systems182 <i>Art Service</i>	Brammer Mfg. Co. 158A-B, C-D, E-F, I-J <i>L.W. Ramsey Adv.</i>	Dictaphone Corp.163 <i>Scali, McCabe, Sloves, Inc.</i>
Ajax Hardware Corp.198 <i>Cochrane Chase & Co., Inc.</i>	Alliance Mfg. Co.76 <i>Nelson Stern Advertising</i>	Briggs Mfg. Co.175 <i>Lord, Sullivan & Yoder</i>	Duo-Fast Fastner Corp.148 <i>Hoffman-York, Baker & Johnson</i>
Alsar, Inc.74B <i>Stief Cyporyn Adv.</i>	Alsons Products Corp.152 <i>Frost & Shaffer Adv.</i>	A Butler Eng.140 <i>Richard W. Pemberton Adv.</i>	DuPont Co.133 <i>Rumrill-Hoyt, Inc.</i>
Aluminum Company of America 144, 145 <i>Fuller & Smith & Ross Inc.</i>	American Gas Assn.84, 201 <i>J. Walter Thompson</i>	C	A-I-L-D Duvinage Corp.194
A American Olean Tile52, 53 <i>Lewis & Gilman, Inc.</i>	A American Panel Products, Inc.172 <i>Rolfe C. Spinning, Inc.</i>	A-L Cabot, Inc., Samuel81 <i>Donald W. Gardner Adv., Inc.</i>	E
American Standard Inc.78, 79, 160 <i>Keller-Crescent Co.</i>	Amsterdam Corp.32, 33 <i>Alden Adv. Agency Inc.</i>	Cameron-Brown Co.142A <i>Cargill, Wilson & Acree Inc.</i>	E.A. Nord Sales75 <i>Ricks•Ehrig, Inc.</i>
A-L Andersen Corp.22, 23, 208, 209 <i>Campbell-Mithun, Inc.</i>	A-I-L-D Armstrong Cork Co.Cov, III <i>Batten, Barton, Durstine & Osborn, Inc.</i>	Canadian Dept. of Industry, Trade & Commerce51 <i>Ronalds-Reynolds & Co., Ltd.</i>	F
Athens Stove Works, Inc.185, 186 <i>Davis-Newman-Payne</i>	A-I-L Automated Building Components, Inc. 60 <i>Lefeune Adv.</i>	A-L Caradco Div. Scovill158C-E, G-J, 189 <i>Reincke, Meyer & Finn, Inc.</i>	A-L-D F.H. Lawson Co., The73 <i>Schindler, Howard & Raut Adv.</i>
B	Barnett Winston Co.142F <i>McKinney & Silver Inc.</i>	Carrier Air Conditioning Co.173 <i>N.W. Ayer & Son, Inc.</i>	Faultless Div./Bliss & Laughlin Ind. 74E <i>Batz•Hodgson•Neuwoehner, Inc.</i>
Beacon-Morris Corp.74D <i>Darrell Prutzman Assoc.</i>	A-L Bird & Son, Inc.159 <i>Humphrey Browning MacDougall, Inc.</i>	A Celotex Corp.38, 39 <i>Bishopric/Fielden, Inc.</i>	A-I-D Featherock, Inc.192 <i>Sierra Advertising</i>
Black & Decker120, 121 <i>Vansant Dugdale</i>	Bonsal Co.142D <i>United Advertising</i>	Charmglow Products214 <i>Robert L. Cohn Inc.</i>	Fedders Corp.74G <i>Kenyon & Eckhardt Adv.</i>
		Citizens and Southern National Bank, The142E <i>J. Walter Thompson</i>	Filtex Div. (Natter Mfg. Co.)134 <i>Leslie B. Cowell Adv.</i>
		A Comopite ShowerPan200 <i>Albert Frank Gunther Law</i>	First Mortgage Investment Corp. 36, 37 <i>Greeman Associates Inc.</i>
		A-L-D Congoleum Ind., Inc.162 <i>Welsh Bencsics Co.</i>	Float-Away Door Co.179 <i>Liller, Neal, Battle & Lindsey, Inc.</i>
		Copper Development Assn.35 <i>Ross Roy of New York</i>	Ford Motor Co. (Truck Div.)170 <i>J. Walter Thompson</i>
		Crane Plastics, Inc.146 <i>Carr Liggett Adv.</i>	Form, Inc.152 <i>Rossi and Company</i>
		A-I Crawford Door Co.147 <i>Anderson Associates</i>	Franklin Glue Co.70, 71 <i>Lord, Sullivan & Yoder</i>
		Cromaglass Corp.142A	Frigidaire Div.-GMC49 <i>Needham, Harper & Steers, Inc.</i>
		D	G
		Day & Night Mfg. Co.166 <i>N.W. Ayer/Jorgensen/MacDonald, Inc.</i>	A-I-L-D GAF (Bldg. Products)26, 27 <i>Daniel & Charles, Inc.</i>
		Delaware Management Co., Inc.196 <i>Albert Frank Gunther Law</i>	A-L General Electric Co.123-126 <i>Young & Rubicam International</i>

TO NEXT PAGE

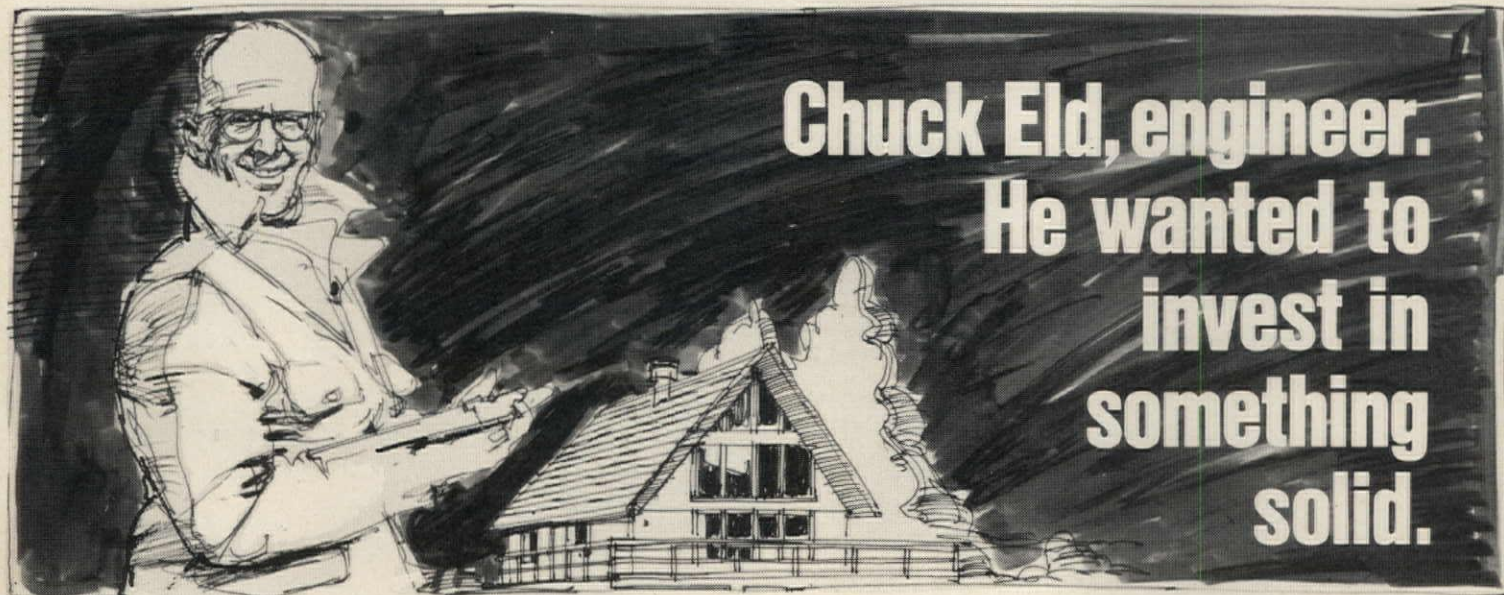

Chuck Eld, engineer.
He wanted to
invest in
something
solid.

At first he liked our post-and-beam, cedar-plank vacation houses for their structural advantages.

Now he likes them for still another reason: They've helped him find "gold" in the Colorado mountains.

A long-time Air Force pilot, as well as a registered civil engineer, Chuck started looking for a solid investment opportunity when he retired from the service six years ago.

Lindal Cedar Homes looked good to him then, and today they look even better. In fact, every year since, his Colorado Springs distributorship has sold an ever-increasing number of these pre-cut leisure homes—80% of them for

building sites at or above the 6,000-foot level.

"It's no place for the ordinary summer place," he says, "but I've never had an unhappy customer."

Which helps explain why total Lindal sales are up another 50% this year—putting us very close to the \$20-million-a-year mark.

And our current distributors haven't even scratched the surface of what's expected to be a \$5-billion market by 1975.

Sound like the sort of solid investment you might like to get into? You don't have to know home sales to do it; you don't even have to know construction.

For more details, write our president, S. Walter Lindal, or simply complete and mail the coupon below.

Mr. S. Walter Lindal, President
LINDAL CEDAR HOMES HH212
10411 Empire Way S.
Seattle, Wa. 98178 Phone (206) 725-0900

I'd like to know more about a Lindal distributorship.
 I'd like to know more about your houses; enclosed is \$1 for your 44-page Planbook.

Name _____
Address _____
City _____
State _____ Zip _____
Area Code _____ Phone _____

Plants in the U.S. and Canada; affiliates in England, Australia and Japan; representatives throughout the world.

ADVERTISERS INDEX

- General Products Co.205
Cabell Eanes, Inc.
- Genova, Inc.56, 57
Dallas C. Dort & Co.
- A-L-D Georgia-Pacific Corp.176, 177
McCann-Erickson, Inc.
- Gerber Plumbing Fixtures Corp.171
Sidney Clayton Assoc., Inc.
- Giles & Kendall Co.214
Tech Comm
- H**
- Hadley Adhesives & Chem. Co. ... 142G-D
Guild Associates Inc.
- A Helo Marketing150
Wellington Adv.
- A-I-L Hercules, Inc.188
W.B. Doner and Co.
- Home Comfort Products Co.167, 168
Hult, Becht & Heinrich, Inc.
- A-L Hotpoint Div./General Electric Co.42
Compton Adv. Inc.
- L Hunter Div. (Robbins & Myers, Inc.) 153
Greenhaw & Rush, Inc.
- J**
- Johns-Manville164, 165
Broyles, Allenbaugh & Davis, Inc.
- K**
- Kingsberry Homes193
Liller, Neal, Battle & Lindsey, Inc.
- KitchenAid Home Dishwasher Div.
 (Hobart Mfg. Co.)44
Griswold-Eshleman Co.
- Kitchen Kompact, Inc.191
Frank-Thomas Adv.
- Kwikset (Div. of Emhart Corp.)29
Coltrane & Co.
- L**
- Leigh Products, Inc.11-18
Diversified Mktg. Services
- A Leslie-Locke Bldg. Prod. Co.741
Akron Advertising Art, Inc.
- A-I-L Libbey-Owens-Ford Co.143
Campbell-Ewald Co.
- Lindal Cedar Homes219
Friendly & Compelling Adv.
- A Ludowici-Celadon Co.202
Scott & Scott Adv.
- M**
- Majestic Co., Inc.131
Wheeler Kight, Gainey, Inc.
- Martin Stamping & Stove Co.184
Eric Ericson & Associates Adv.
- Mayhill Homes Corp.142K-N
Cargill, Wilson & Acree, Inc.
- A-L Miami-Carey Co.25
Lord, Sullivan & Yoder
- A Miracle Recreation Equip. Co.85
Kieffer Associates
- Modular Materials, Inc.43
Marketing et cetera
- A-L Moen Div. (Stanadyne)136
Carr Liggett Adv., Inc.
- A Morgan Co.154, 155
E.R. Hollingsworth & Assoc.
- Multi-Clean Prod. Div./H.B. Fuller ...74H
Peterson-Morris Inc.
- N**
- A-I-L National Floor Products Co., Inc.74C
Jarman Associates, Inc.
- National Gypsum Co.158B-C
Fuller & Smith & Ross Inc.
- National Homes Corp.139
Garfield-Linn & Co.
- Norris Industries
Hardware Engineering Co.
- Artistic Brass5-8
- Price Pfister21
- Thermador216, 217
- Weiser Lock86
- A NuTone Div. of Scovill1-2, Cov. IV
The Media Group Inc.
- P**
- A-D PPG Industries129
Ketchum, MacLeod & Grove, Inc.
- A-L Panel-Clip Co.156
Cyporyn Advertising, Inc.
- Paslode Co.50
Reincke, Meyer & Finn, Inc.
- Payne Co., The158D-E, B-C
N.W. Ayer/Jorgensen/Macdonald, Inc.
- Peachtree Doors, Inc.135
Bound & Associates Inc.
- Peerless Plastics74A
Creative Press, Inc.
- Perma-Door/Steelcraft Mfg. Co.149
Keller-Crescent Co.
- Pincrest, Inc.74F
- Pomona Tile (Div. of American
 Olean Tile)52, 53
Lewis & Gilman, Inc.
- A-D Potlatch Forests, Inc.210, 211
David W. Evans & Associates, Inc.
- Price Pfister A Norris Industries Co. ...21
Enyart & Rose Adv., Inc.
- Products '7366
- Pyrotronics, Inc.67
Keyer, Martin & Co.
- R**
- R.O.W. Sales Co.157
Rolfe C. Spinning, Inc.
- Raygold Div. of Boise Cascade141
Cove & Cooper Inc.
- Raynor Mfg. Co.158
Sperry-Boom, Inc.
- A-L Red Cedar Shingle & Handsplit
 Shake Bureau158A
Ayer-Baker Adv., Inc.
- Reimann & Georger, Inc.156
Gelia Wells & Mohr
- A-L Rohm and Haas Co.61
*Arndt, Preston, Chapin, Lamb & Keen,
 Inc.*
- L Ronson Corp.82, 83
Norman Craig & Kummel, Inc.
- S**
- A-L Scheirich Co., H.J.55
Doe-Anderson Adv.
- Schlegel Mfg. Co., H.J.183
Davin/Jorgensen Adv.
- Scholz Homes, Inc.45
Edward H. Weiss and Co.
- A-L-D Sears, Roebuck & Co.30, 31
Gerson, Howe & Johnson, Inc.
- A Shakertown Corp.151
Pascoe and Starling & Pollock, Inc.
- Shelter Mortgage Corp.150
Padilla & Speer, Inc.
- A-I-L Simpson Timber Co.199
Richardson Seigle Rolfs & McCoy, Inc.
- Slater ElectricCov. II
Kane Light Gladney Inc.
- A Soss Mfg. Co.196
Brewer Associates, Inc.
- Southern California Gas Co.158A
Doyle Dane Bernbach, Inc.
- A Standard DryWall Prod., Inc.195
- L Superior Fireplace Co.212
Casa Adv. Inc.
- A-I-L Symmons Ind., Inc.65
Quinn & Johnson, Inc.
- T**
- TECO (Timber Eng. Co.)163
George Lohr Studios/Agency
- Tappan Co.69
Howard Swink Advertising, Inc.
- Tech-Sales Co.158G-H
Coit/Petzold Inc.
- Temple Industries137
Ritchie Adv. Agency
- Tennessee Plastics, Inc.210
Concepts Inc.
- Thermador A Norris Ind. Co.216, 217
Hardware Engineering Co.
- Triangle Pacific Cabinets62, 63
TPF Adv.
- Trus Joist Corp.180, 181
Cline Advertising
- A TubMaster Corp.142
TM Advertising
- U**
- A-L-D U.S. Plywood207, 127
Young & Rubicam International
- United Cabinet Corp.213
Artguys, The
- A United States Gypsum Co.215
Needham, Harper and Steers, Inc.
- A-L Universal Rundle Corp.206
Lando, Inc.
- A-D Urethane Fabricators (Am-Finn
 Sauna Div.)172
Ernest Wm. Greenfield, Inc.
- V**
- A Valley Faucet Div.
 (U.S. Brass Corp.)190
Carpenters & Associates
- A-L Vega Industries/Heatilator Div.178
Reincke, Meyer & Finn, Inc.
- W**
- Wabash, Inc.138
Merrill Kremer, Inc.
- Weiser Lock A Norris Industries Co. .86
Hardware Engineering Co.
- Weslock Co.59
Reeds and Farris Adv.
- Western Wood Moulding & Millworker
 Producers Assn.174
McCann-Erickson, Inc.
- A-I-L-D Western Wood Products Assn.46, 47
McCann-Erickson, Inc.
- Weyerhaeuser Co.218
Cole & Weber, Inc.
- A-L Whirlpool Corp.80
Netedu Advertising
- Z**
- Zenith Metal Products Co.77
Ed. Letven Associates Inc.

Advertising Sales Staff

Pre-filed catalogs of the manufacturers listed above are available in the 1972 Sweet's Catalog File as follows: A Architectural File (green)
 I Industrial Construction File (blue)
 L Light Construction File (yellow)
 D Interior Design File (black)

ATLANTA 30309 Glen N. Dougherty 1175 Peachtree St. (404) 892-2868	BOSTON 02116 Matthew T. Reseska McGraw Hill Bldg. 607 Boylston St. (617) 262-1160	CHICAGO 60611 Karl Keeler, Jr. Charles E. Durham, Jr. 645 N. Michigan Ave. (312) 751-3700	CLEVELAND 44113 Milton H. Hall, Jr. 55 Public Square Bank Building (216) 781-7000	DALLAS 75201 Charles G. Hubbard 1340 Republic Nat'l. Bank Building (214) 747-9721	DENVER 80202 Harry B. Doyle, Jr. 1700 Broadway (303) 266-3863
DETROIT 48202 John Strong 1400 Fisher Bldg. (313) 873-7410	HOUSTON 77002 Charles G. Hubbard 2270 Humble Bldg. (713) 224-8381	LOS ANGELES 90010 Donald Hanson 3200 Wilshire Blvd. South Tower (213) 487-1160	NEW YORK 10020 Matthew T. Reseska 1221 Avenue of the Americas (212) 997-3686	PHILADELPHIA 19103 Raymond L. Kammer Six Penn Center Plaza (215) 568-6161	SAN FRANCISCO 94111 Stephen D. Blacker 425 Battery Street (415) 362-4600

**You put in a
Solarian® no-wax floor
for the same reasons
you put in
central
air conditioning.**

What does a bright, shiny no-wax floor have in common with a central air-conditioning system?

Both can help you sell your homes. Both are powerful added incentives for your prospects to buy.

Solarian is a major breakthrough in easy-care flooring. Spills, dirt... even black heel marks... come up with only damp-mopping. We've tested Solarian for two years in busy kitchens of actual homes, and these floors are still bright and shining—even though they've never been waxed.

Beautiful Solarian floors will also make your houses look more inviting—an important extra that helps set them apart from all the rest.

We've been telling the Solarian story in national advertising. And women have responded by making it the most successful new Armstrong product in years.

It goes to show that when a woman likes something, there's a good chance a man will buy it. And that's why Solarian should be an important part of your plans.

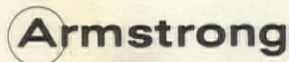
**Armstrong**

CREATORS OF



THE INDOOR WORLD®

CIRCLE 180 ON READER SERVICE CARD

Floor design copyrighted by Armstrong.



The
LIGHTCRAFT
OF CALIFORNIA
Crystal
Collection



GENUINE **STRASS** CRYSTAL

**Genuine Strass Crystal
introduced by
Lightcraft of California
Booth 2326
NAHB**

CIRCLE 4 ON READER SERVICE CARD