

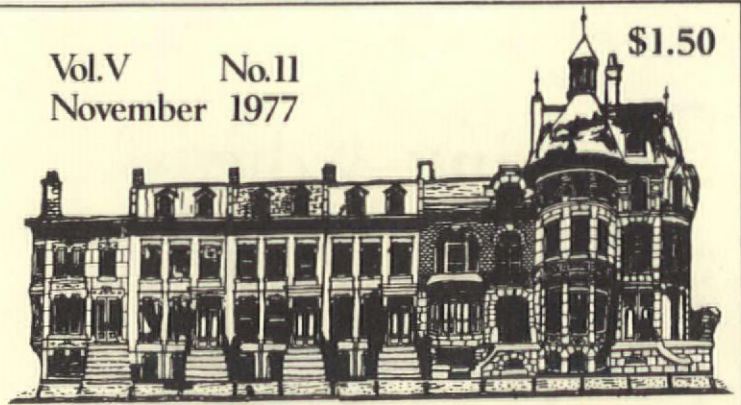

# THE OLD-HOUSE JOURNAL

Vol.V No.11  
November 1977

\$1.50



Restoration And Maintenance Techniques For The Antique House



## A Guide To Reproduction Fabrics

### In This Issue

Adding Storage to the Old House.....	125
A Polyurethane Bullseye.....	132
Glossary of Historic Fabric Terms.....	131
Stenciller's Art in Indiana.....	122
Woodworking Tool Catalog.....	132

### Coming Next Month

THE CO-INSURANCE TRAP

SELECTING FABRIC for curtains, bedspreads and upholstery is an important part of incorporating authentic period details in the furnishing of the old house. There is a wide variety of reproduction 18th and 19th century fabric available today. It is necessary, however, to have an acquaintance with the kinds of fabric used in the United States up to 1900 in order to choose an appropriate reproduction. A very helpful new book, "Fabrics For Historic Buildings" has recently been published by The National Trust For Historic Preservation. With their kind permission, we have excerpted some of the historical information as well as a glossary of old terms. These brief discussions of the kinds of fabric used in various periods will help the old-house owner to select fabric with an eye to quality and appropriateness. Full details on how to order the book will follow this article.--C.F.

### The 18th Century

IMPORTED FABRICS seem to have been preferred for furnishing American buildings in the 18th century. English fabrics, protected by the high taxes that the mother country imposed on goods imported into the colonies from other countries, predominated.

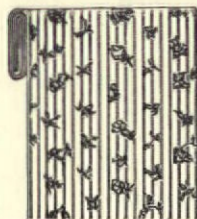

THE 18TH CENTURY saw the beginnings of

industrialization in textile manufacture in England. Throughout the period designs were handprinted from woodblocks, but in the middle of the century the introduction of mechanical processes and engraved copper plates for printing on cotton or linen expanded production and made possible fine linear designs with much larger repeats that were especially well adapted for furnishing use. The colors were primarily deep indigo blues and the rich purples, reds and sepias that are derived from madder. Typical English designs included large-scale flowers and birds, chinoiseries, pastoral landscapes and special commemorative designs.

DOCUMENTARY EVIDENCE makes it clear that few houses were embellished with elaborate window hangings in the colonial period. For those who could afford domestic luxury, the most lavish use of fabrics was in the covering and hanging of the best bed. In many estate inventories, the value of beds with hangings far exceeds that of any other piece of furniture in the entire house. Bed hangings of green harrateen or cheyney were common, with crimson or scarlet the second most popular color.

IF THERE WERE ANY WINDOW HANGINGS at all, they would have been hung in the parlor chamber, the room over the parlor

(Continued on page 129)

# Reviving The Stenciller's Art In Indiana



By Mrs. Richard V. Mikesell, Richmond, Ind.

**T**HE RESTORATION of the Agnes and Abram Gaar home--why, where and how did it start? Unoccupied and neglected after the death of my mother in 1962, the roof developed leaks, the furnishings collected dust, the radiators rusted, an all but forgotten home badly in need of repair or demolition. My husband forced me to make a decision.

I COULDN'T STAND the thought of a hundred-year old Victorian ancestral landmark being torn down. So the first step was new roofing over all the house, done during the summer of 1974. This experience almost caused me to stop before we really got started.

DURING A WORK STOPPAGE over the Fourth of July weekend, the roof only had a felt covering and some very heavy rains caused further damage to the interior, such as half the ceiling of one bedroom falling and water dripping

in the dining room beneath, causing damage to the table and mildewing the carpet. The roofing company's insurance partially paid for the damages.

A TREE HAD BLOWN DOWN NEAR THE front entrance and a limb had broken and bent the aluminum awning over the porch. Repair or remove? Twenty years ago my parents had removed the original front porch and replaced it with a larger, screened one where they could enjoy the view and fresh summer breezes without bugs. Fortunately, they stored some of the old material in one of the barns. Knowing it was there behind the bales of hay, we hauled it out to see if there was enough to reconstruct it.

**H**AVING THE ARCHITECT'S ORIGINAL plans on Hlinen has been invaluable during the restoration. This gave us the exact dimensions to go by in replacing the missing parts. We found the side rails and spindles, the ceiling and top-trim, and the two half-columns that were against the house. We did not find the six columns, three being grouped at each corner toward the front, nor the rails or spindles that formed the balcony over the porch roof. We had enough to go by to have these missing parts reproduced.

IN REMOVING THE NEW PORCH we found side stone foundations of the original, still in place; unfortunately the thick stone steps had been broken up and used for filler under the new. But this didn't stop us. When the Palladium bought property on North A Street for its new building they allowed us to remove some stone slabs and the museum had stored the steps on their property and gave us what we needed, so all but the coping has been restored. Credit must be given to Paul Albert and his assistant, Ed Masters, for reconstructing the front porch, and to Elmer Turner of Acme Patterns for reproducing the caps and trim for the columns and Commons Lumber Company for turning the spindles and other parts.

WHAT TO DO WITH THE INTERIOR? On the third floor there are four bedchambers, as they were noted on the plans, a bathroom, large storage room with cedar-lined closet, and a small room to the front with a winding stairway to the

**THE OLD-HOUSE JOURNAL®**  
Published Monthly For People Who Love Old Houses

Editor .....	R.A. Clem Labine
Decorative Arts Editor .....	Carolyn Flaherty
Circulation Director .....	Paul T. McLoughlin
Circulation Assistants .....	Joan O'Reilly Peggy Scaglione James Graham
Midwest Editor .....	Tom H. Gerhardt
Staff Photography .....	Jim Kalett
Contributing Editors .....	Claire Wood Labine R.A. Labine, Sr. H. Weber Wilson Barbara Schiller

Published by The Old-House Journal Corporation, 199 Berkeley Pl., Brooklyn, N.Y. 11217. Tel. (212) 636-4514. Subscriptions \$12/yr. in U.S. and Canada; \$20/yr. elsewhere. Printed at Royal Offset Co., 34 W. 15th St., NYC 10011. Contents of the Old-House Journal® are fully protected by copyright and must not be reproduced in any manner whatsoever without specific permission in writing from The Editor.

tower which has a lovely view to the south overlooking the farm and the city. There are four bedchambers on the second floor and on the main floor the hallway extends the full length of the house. Off the sitting room is the conservatory added by my parents.

**W**E REMOVED FURNITURE and things not of the period, stored china, glassware, lamps, pictures, etc. so that some painting and cleaning could be done. Our daughters were able to use some of the extra furniture and the Salvation Army took the rest. I almost gave them an original chair. One of the men was carrying it out the back hall when I suddenly realized that the wood trim on the arms and legs was Victorian!

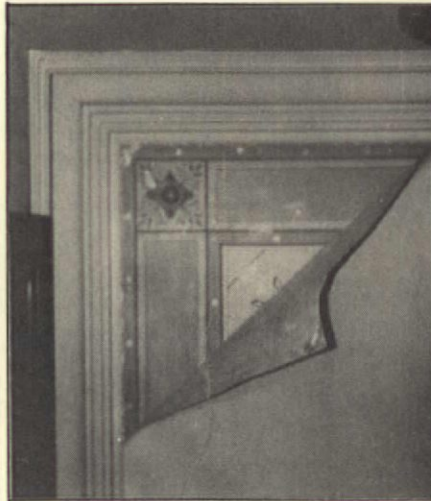

Original stencilling on library ceiling is uncovered.

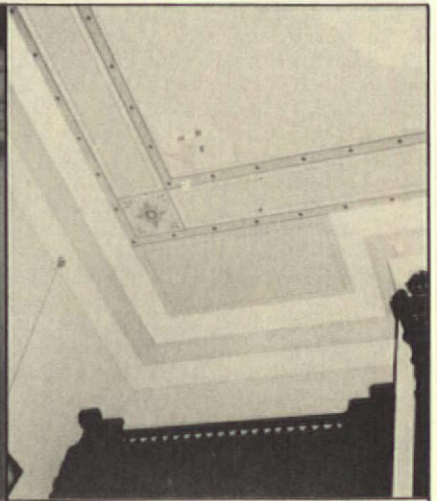

The ceiling now, with its stencil designs restored.

THE DECISION WAS MADE to start on the top floor and work down. Moisture-stained and loose wall paper had to be removed--who would do it! Through the Hohenstein's Suburban Tool Rental we located a steamer and a young man to operate it. During the course of this work he informed me that he had had experience in painting and cleaning and that he and his friend would appreciate the opportunity to continue the work. They are David McConkey and Donald Bridgford, the two men who have done an expert, diligent and excellent job on the restoration of the ceilings, walls, woodwork, hardware and floors of the entire house. In fact, they have formed a partnership known as the 1776 Interiors and Decorators.

THE THIRD FLOOR ROOMS and tower have been plaster-patched and painted, the inside shutters refinished, the painted woodwork hand-grained, and the natural woodwork cleaned and polished, and the floors painted.

**N**OW FOR THE REALLY EXCITING PART--uncovering the original! In the 1950's my parents converted the library and parlor into two bedrooms because of their failing health and fear of not being able to escape in case of fire. In removing a closet and powder room from the parlor we discovered a wide painted band of ceiling design, also the original soft green of the walls and darker green stencilled frieze below the cornice. Incidentally, the cornice had to be remolded and restored in the corners where the closet, etc. were. This was done by one of Ralph Whisenhunt's expert plasterers. After finding the ceiling and wall trim we could hardly wait to remove the wallpaper from the second floor and other areas. Thankfully, wallcovering had been put on instead of paint--or all would have been lost forever!

EVERY ROOM, even the front hall, stairway, and the back hall and stairs are all a different design. The men either made stencils or tracings of all the designs and took color photos to get the correct colors. In order to learn from an expert what kind of paints to use, how to mix and apply them, they made a special trip to Cleveland, Ohio to consult with Mr.

Roman Celleggin who was born in Italy and is now in his eighties. As a young boy of 12 he began painting murals in wet plaster in his home town of Providence di Padova, some of them can still be seen today.



Dining room, showing restored triangular ceiling design in gold leaf. Furniture and accessories are original. Dining room table has 7 leaves and 12 chairs.

WHEN THE PARLOR AND LIBRARY were converted to bedrooms, the lower sashes of the windows were removed and replaced with the crank type. We found the old ones in the basement and other things were uncovered in some of the outbuildings--the fretwork that was in the arched door between the parlor and library, the backsplash for the wash bowl and some of the wooden and brass curtain rods with brass rings and wall holders.

THE THREE-SHELVED DUMB WAITER was at the basement level and used for storage of paint cans, etc. We found a few of the outside shutters. Unfortunately, not enough, but at least a pattern if we decide to replace them.

DAVE AND DON found an article in the library from the April 20, 1877 edition of the Richmond Telegram, telling about the architect, carpenter, and the companies that furnished the lighting and plumbing fixtures and hardware to the Abram Gaar house. The article, which details the heating and water systems, how the nailheads were hidden in the woodwork, and the finish on the basement floor, is one of the most valuable documents we have.

ANOTHER VALUABLE DOCUMENT is the invoice for the furniture, dated May 1877, from the Mitchell and Rammelsberg Company of Cincinnati. It lists the Brussels lace curtains, 3 pairs, \$225, hall rack with inlaid blue tile at \$260, and the walnut Eastlake extension table with 7 leaves at \$75.

SEVERAL OF THE ORIGINAL LIGHT FIXTURES on the first floor are intact, the crystal chandeliers in the front entry, sitting room, parlor and library and the Scottish Knight in burnished armor on the newel post. The crystal chandeliers are a combination of gas for emergency purposes. The fixtures on the second floor I have purchased at sales, antique shops and elsewhere. They have been cleaned, rewired and fitted with interesting bulbs by Donald Hopkins of the Lamplighter Shop.

THE ORIGINAL BATHROOM on the second floor created a real challenge, the old tub and watercloset (toilet) had been discarded for modern equipment, some of the wainscoting behind the tub had been replaced with tile, and of course, linoleum on the floor. Fortunately, the wash basin remained, and there again the backsplash was found in a barn.

THE CARPENTERS thought I had lost my mind when I had them remove the ceramic tile and replace it with wainscoting. Dave and Don nearly lost theirs when they had the horrible task of removing the linoleum and glue from the floor to uncover a beautiful oak floor with inlaid border. Temporarily, we are using a turn-of-the-century toilet seat and wooden tank with lead lining and hope to find one of correct vintage. The tub with claw feet was purchased and the matching foot-tub.

THE HOME AND FARM are now on the National Register of Historic Places and I appreciate very much the bronze plaque on the front door. It reads, "Agnes and Abram Gaar Home, Built 1876, architect John Hasecoster, presented by the Heritage Club, 1976."

HOPEFULLY, I have not failed to give credit where it is due. The restoration is not complete--it has been fascinating, time consuming, costly, very rewarding, and a real labor of love--indeed, a monument to the memory of Agnes and Abram Gaar. ■■



In the parlor only the original border was found. The rest had been newly plastered. The decorators took the design from the original parlor table, (at right) which had been on exhibition at the Philadelphia Centennial in 1876, blew it up to scale and put it on the ceiling. Horses and chariot in center of the table are on the ceiling in the bay window area. Gas and electric chandelier is original.

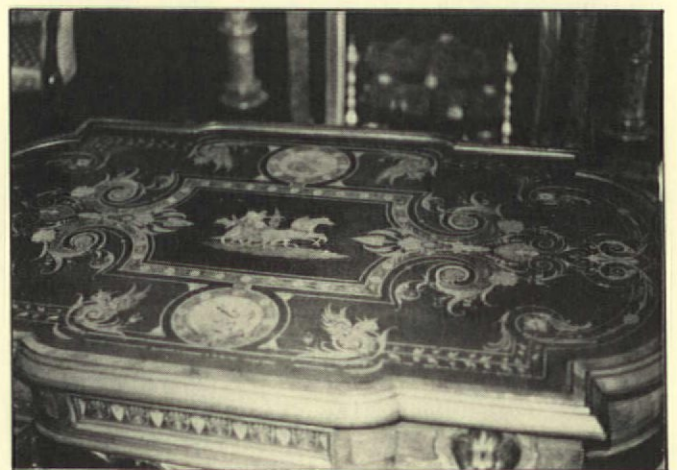

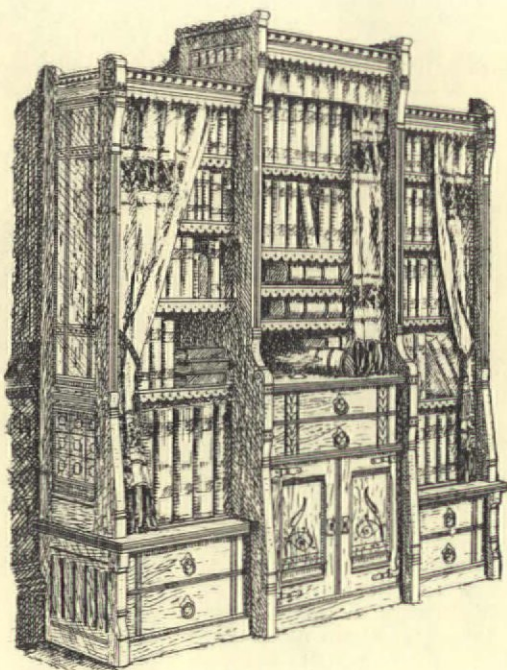

# Adding Storage To The Old House

By Stephen MacDonald

**S**TORAGE IS ONE OF THE MORE vexatious problems besetting the owner of an old house. We have so many possessions these days—many of which hadn't even been invented when the house was built. Even articles that had been invented—like books—weren't owned in the abundance that they are today. This means that today's old-house owner will either have to throw away some of his or her possessions (which might not be a bad idea at that) or add some storage space to the house.

LET'S BEGIN WITH THE UNDERSTANDING that in adding storage facilities to your house you are adding an anachronism—however necessary it may be. If you don't want it to LOOK like an anachronism, the unit will have to be custom-made to suit your particular house. Fortunately, many kinds of storage units are reasonably easy do-it-yourself projects.

SHELVES FOR BOOKS, records and the like are a good place to begin, because they are easy enough to build so that a novice carpenter can have a confidence-building success. And the experience introduces skills that can be expanded into more ambitious cabinet-making projects later on.

## Design Factors

**S**HELF-BUILDING PROJECTS involve two basic steps: (1) Construction of the basic unit, which is pretty much the same for everyone; (2) Adding the finishing touches (mouldings, etc.), which have to be tailored to you specific house. The following instructions will guide you through the carpentry of the basic construction and then give you some ideas on tailoring the result so that it looks as though it were built with the house.

THE FIRST STEP IN DESIGNING the bookcase (we'll call it that, even though the unit

could be used to accommodate other things) is to plan out such functional matters as how much capacity you require and where the unit will stand. Then you have to add aesthetic factors such as what dimensions will give you the desired capacity in a shape that makes sense in the room you have selected. You might want to build tall cases that reach to the ceiling... or door height...or wainscot height. In these considerations you'll do well to consult books that have photos of houses of similar vintage to yours, and visit neighbors who own old houses.

HOW FAR APART should shelves be? It's possible to make them adjustable, of course, and some people think this is the safest course. On the other hand, most people don't adjust their adjustable shelves very often (if ever) after they are in place. And fixed shelves are both stronger and better looking than the adjustable kind. Usually, good advance planning can eliminate the need for adjustable shelves.

FINAL PROCEDURE in this first part of the design is to draw up a detailed plan of the basic structure and include all dimensions.

## Special Trim

**N**EXT STEP IS TO CONSIDER what special touches will make the basic shelf unit look as if it had been in your house forever. Many old bookcases tended to be ornate, with such features as elaborate carvings and bevel-glass doors. If you have the woodworking skill to bring off this kind of thing, by all means go right ahead. But it isn't necessary. A simpler but quite satisfactory effect can be achieved by selecting an architectural detail that's part of the room where the bookcase will be and incorporating it in the design. For example, copy the room baseboard and extend it around the bottom of your unit. Select a crown moulding for the top that is similar to your cornice moulding or framing woodwork in the room. Perhaps you'll also want to add strips of decorative moulding to the fronts of the uprights.

ANY WELL-STOCKED LUMBERYARD carries a variety of ready-made mouldings in softwood that can be stained or grained to match hardwood. It's

almost always possible to combine two or three stock mouldings in a way that comes close to matching old mouldings.

## Selecting Wood

**W**HAT MATERIALS should you use? If the unit is to be painted or grained, possibly even stained, softwood lumber will be the logical choice because it's the cheapest—although lumber prices have gone so high in recent years that nothing can be considered cheap. For the genuine hardwood look you'll have to use either solid hardwood or else a plywood veneer. Solid hardwood is available in some lumber yards in some cities—but it's always expensive. Veneered hardwood plywood is an excellent substitute—and it's somewhat cheaper and easier to find. You can find plywood faced in almost every kind of wood.

**EDGES OF PLYWOOD VENEER** can be covered with a strip of veneer (sold in hardware stores and lumber yards) attached with contact cement. Even better is to face the edges with moulding strips of the appropriate hardwood—if you are fortunate enough to locate some.

**PERHAPS A WORD IS IN ORDER** on lumber grades, which can confuse even an experienced handy-person. Softwood boards are sold in two broad grades—Select and Common—but there are several sub-grades in each category. Few yards stock the full range of grades, so mostly you'll be choosing between the Select and Common that your yard carries. Select costs roughly twice as much as Common, so it's worth considering whether you can make Common do the job. Sometimes you can cut several good pieces out of a Common board; other times you can fill and seal knots. But when you need a long piece of clear wood, you'll have to pay for Select.

**IT IS VITALLY IMPORTANT** that your lumber be dry. Wet wood is hard to cut, it dulls blades, and shrinks and warps as it dries to the humidity level of your house. The best wood is kiln dried.

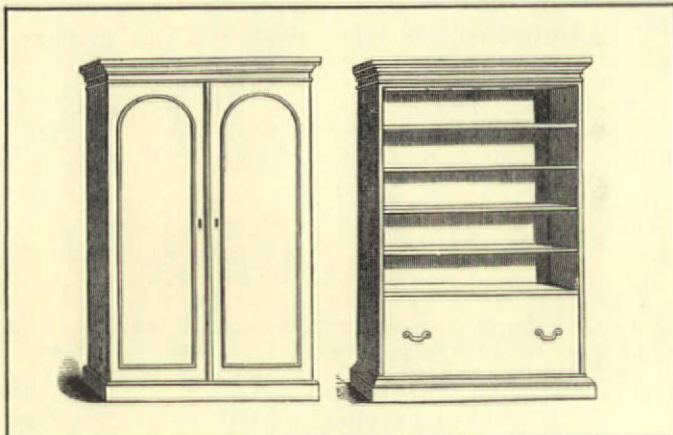

Simple storage unit (which can be used with or without doors) from Downing's 1850 edition of "The Architecture of Country Houses."

**HARDWOOD IS GRADED DIFFERENTLY.** The top quality is known as FAS—meaning Firsts and Seconds—followed by Select and Number 1 Common. FAS has few defects, Select has a few more (especially on the back face), and Common is usually unsuitable for large pieces such as bookshelf units.

**A**S FOR PLYWOOD, the softwood variety is frankly not recommended for quality work—even if the plan calls for painting. Its interior plies are soft and loose. Hardwood plywood is available in several grades. The highest, Premium, is probably not worth the extra expense unless you need matched graining. The grades known as 1 or 2 are adequate. Many yards term their plywood "G2S" (meaning Good on 2 Sides), or "G1S," (Good on 1 Side).

**PLYWOOD IS SOLD IN PANELS,** usually 4 ft. x 8 ft., in 1/8, 1/4, 3/8, 1/2, 5/8, 3/4 and 1 in. thicknesses. Boards are sold in "nominal" dimensions—which means the size before finishing and drying. Thus a board nominally 1 in. thick actually measures about 3/4 in. A nominal 5/4 (called "five quarter") measures a little over an inch thick. These are the two most likely thicknesses for shelves. Board widths are nominally 4 in., 6 in., 8 in. and up, increasing by twos. Board lengths are actual dimensions, beginning at 8 ft. and increasing by 2-ft. increments.

**BACKING FOR SHELVES** can be made of Masonite (if it is to be painted or grained), or else 1/4-in. hardwood plywood.

## Mystique Of The Lumberyard

**W**HAT ALL THIS MEANS is that you must get to know your way around the lumberyard if you expect to do much woodworking. First step is to know exactly what you want. Using your plan of the bookcase, make a rough sketch of each component with its dimensions (you won't be able to do this until you have read the following sections on joinery).

**USE YOUR COMPONENT DRAWINGS** to work out a cutting plan. Try to figure out on paper the minimum amount of lumber you need to buy and how to cut it. Use your cutting plan to derive the lumber list—which is the shopping list you take to the yard. Take along your component sketches and cutting plan, too. You may be planning to buy four pieces of 8 ft. 1x10, but if the yard is out of 8 ft. lengths you'll need to recalculate in a hurry!

**LUMBER YARDS HAVE A MYSTIQUE** for many people, but they're really quite straightforward when you get to know them. The typical operation has an office and a yard. You place your order in the office, and then take your receipt to the yard to get the order filled.

**THE MOST IMPORTANT PERSON** in the place, as far as you're concerned, is the yard man (or the yard foreman in a large yard). He is the one who is going to select your wood—or better yet, allow you to select it. Yards vary in their attitude about do-it-yourself lumber selection. Some insist that if you are buying three boards in a size then you must take the

top three on the pile. Others let you pick through till you find the three you want.

STILL OTHER YARDS fall somewhere in the middle; they'll allow you to reject an occasional board but not grope through an entire pile. Whatever the yard policy, it's important that you be on hand, if for no other reason than to let the yard people know you are concerned about the quality of the lumber. This is especially true if you are trying to build with Common lumber, where there may be great variations in boards that cost the same.

DO NOT—unless your brother is the yard man—phone in an order for delivery. You are likely to get the dregs that everyone else has rejected. If the yard man is helpful, it's not a bad idea to tip him a dollar or two. That way he'll remember you the next time you come in.

### Cutting And Fitting

**B**ACK HOME at your shop, you begin by squaring an end of each board, crosscutting it in the appropriate lengths, following your cutting plan. If you're using plywood, you'll begin by ripping the sheets into boards, then crosscutting to length. In this and in all cabinet work and other ambitious carpentry, it is essential that all cuts be square and accurate to 1/16 in. or better. The way to assure this is by measuring carefully ("Measure twice, cut once," as the saying goes), keeping your blades sharp and being sure that your saw—especially if it is a radial-arm saw—is in perfect alignment. A radial-arm saw is one of the most versatile and useful of home shop tools, but it gets out

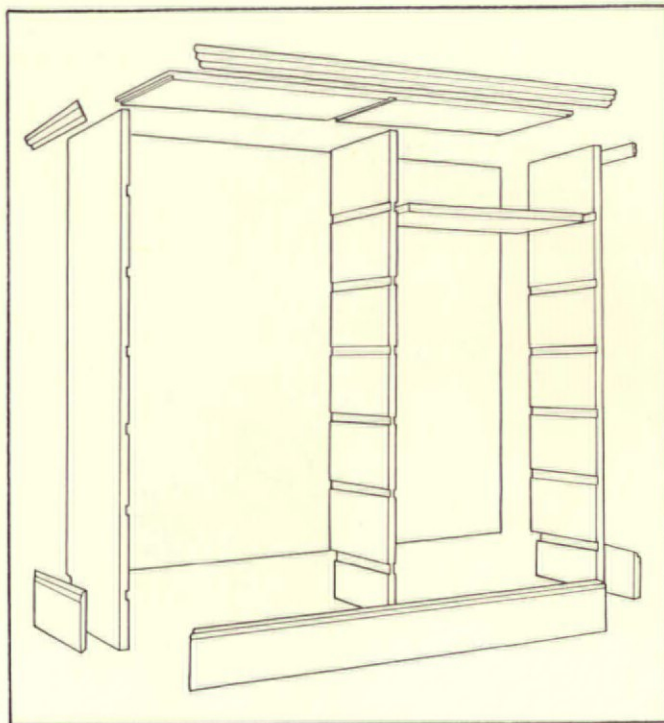

of alignment notoriously easily. A dull blade that drags through the wood will pull it out of adjustment in just a few passes.

NEXT, cut the dados and rabbets. These are basic wood joinery cuts, used in almost all cabinet work. A dado is simply a channel in a piece of wood where another piece joins it (in this case where a shelf fits into the

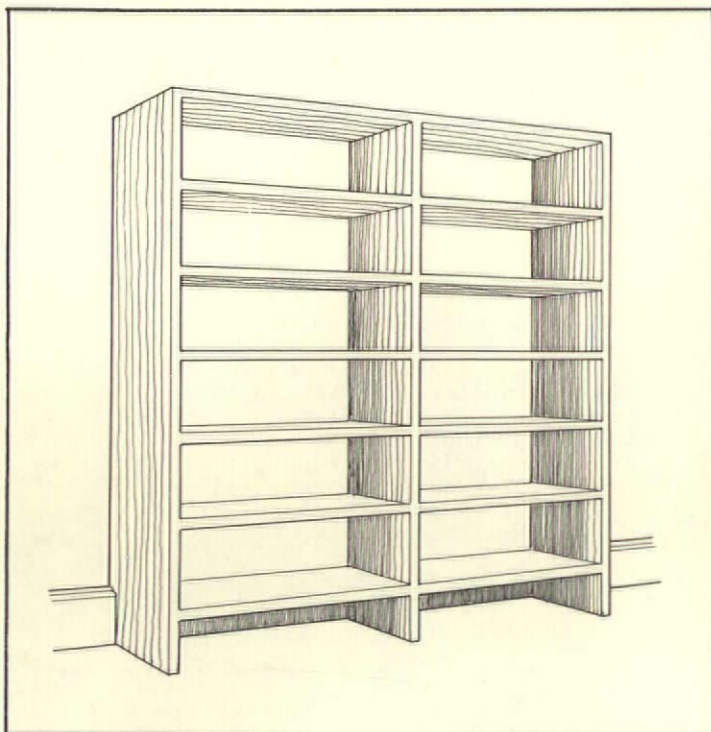

The addition of an appropriate crown moulding and baseboard bring a simple

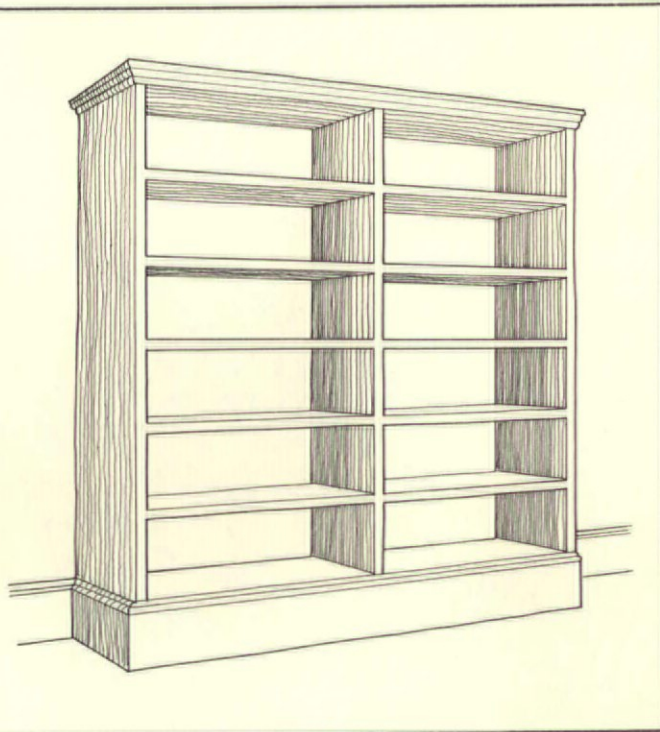

box shelf unit into harmony with the rest of the room.

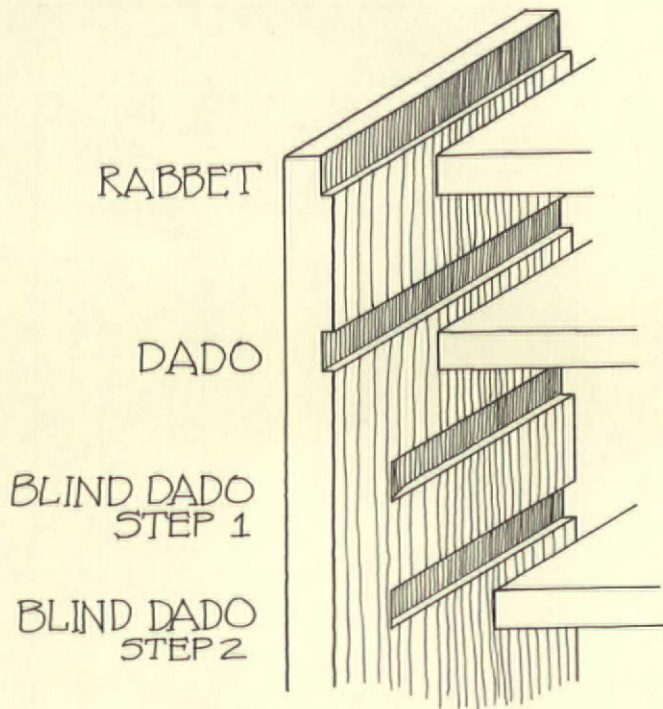

sides). A rabbet is like a dado, but along an edge. Bookcase sides are often rabbeted along the inside back edge to accept the back, and across the inside top to accept the top shelf.

THESE CUTS are easy to make with special blade sets. Dado sets for radial-arm and table saws include two cutters that look much like regular blades, several chippers and some small shims. You make up a sandwich of the cutters, putting as many chippers and shims between them as are needed to make a dado the width you want. Dadoes and rabbets can also be cut with a router or, if you prefer the old-time hand skills, with special planes. In any case, the position, width and depth of the cuts are critical, and great care must be taken.

### Special Cuts

**D**ADOES MUST BE just wide enough for the shelves to fit snugly. Too narrow and the shelf won't fit without an unholy struggle; too wide and it will be sloppy—leaving a gap. It's a good idea to sand the shelves before measuring them for the dadoes, because sanding makes them slightly thinner. Dado depth should be about 1/4 in. for bookcases made of nominal 1-in. stock or 3/4-in. plywood. At the outset, you should make a few trial dadoes in scrap wood before cutting "for real."

SOMETIMES YOU'LL WANT to use a "blind dado," as for instance when the shelves don't extend to the front of the sides. To do this, cut with the dado blade to the point where the shelves will stop, then use a very sharp chisel to square out the channel.

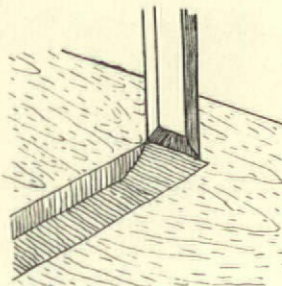

**A**FTER CUTTING AND DADOING, put veneer or moulding strips on any plywood edges that will show, then sand and dust all pieces. If the finished unit will be too large to conveniently carry through a doorway, move the components to the room where the bookcase will stand. If there is a baseboard on the wall, cut out the rear bottoms of the uprights with a sabre saw. If the bottom shelf is at baseboard height, you'll have to make it less deep than the others. And the back must also stop above the baseboard.

LAY OUT AND ASSEMBLE the bookcase according to your design. Use good quality yellow (not white!) cabinetmakers' glue and finishing nails in all joints. (Franklin's "Titebond" glue is a good high-strength, long-lasting adhesive.) Shelves can be face-nailed from the outside of the uprights, but the nail holes will be less obvious if you toenail them from the inside—a more difficult job. The nails should be sunk with a nailset and the holes filled with wood putty. If the wood will be finished naturally, the best filler is linseed-oil glazing putty colored with pigments to match the finished wood. This filler should be added after the natural oil finish has been applied to the wood.

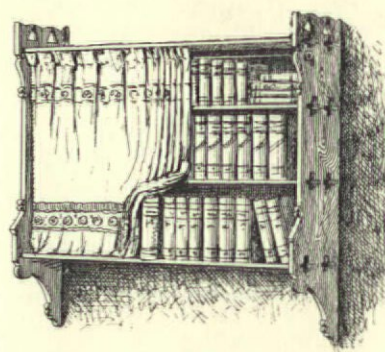

*Hanging Shelves.*

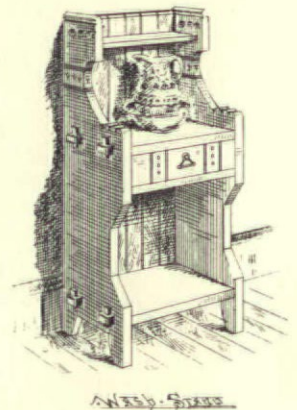

**O**NCE THE SHELVES, sides and tops are in place, attach the back and hoist the unit into position. Then you can install the mouldings and other trim that will give your basic bookcase its special character. You may want to tack small strips of moulding over the front edges to cover the dadoes.

IF THE BOOKCASE is tall, it may be necessary to anchor it to keep it from toppling. The simplest way to do this from the top—if there is room to work between the top shelf and the ceiling. First, find a stud in the wall, then screw an angle bracket to the wall and the top of the bookcase. If there's no room on top, use the top of a high shelf. ■■

NEXT MONTH: Further ideas on using mouldings to dress up your shelving units.

Stephen MacDonald is a product designer by profession—and a finish carpenter by inclination. He's had ample opportunity to hone both skills during the renovation of his Brooklyn brownstone.



where the best bed was located. Usually the fabric and color of the curtains matched that of the bed hangings. Any upholstered furniture or window-seat cushions in the room were usually covered in the same material or in leather of the same color. Slipcovers or cases of printed or checked cotton or linen were frequently used to protect the upholstery. If a family had curtains in more than one room, the second set would be in the parlor.

THERE ARE MANY excellent reproductions of 18th century silks, linens and printed cottons, but limited evidence to support their use in American buildings. Wool, by far the most commonly used material, is scarcely represented among modern reproduction fabrics.

### 1790-1815

TOWARD THE END of the 18th century and in the early years of the 19th century, the mechanized textile production that came with the Industrial Revolution lowered costs and brought furnishing fabrics, especially printed cottons, within the economic reach of many persons for the first time. Inevitably, fashion followed, and furnishing fabrics began to be used more widely and in greater abundance than they had before. Most fabrics were still imported from England, which had the most advanced textile technology, but merchants also imported French, Indian and Chinese fabrics into the United States. The infant American textile industry was not yet a factor in providing fabrics for home furnishings.

ALTHOUGH WOOL bed hangings continued to be used during these years, chintz was now regarded as more stylish and had the added advantage of being easily washable. Bed valances were wider than they had been in the 18th century, ranging up to 20 inches, sometimes with added netting or fringes. The most elaborate designs for bed hangings included many additional pieces--extra valances, short curtains, swags and rosettes. Window hangings also evidenced the growing fashion for fabrics. Chintz was favored in parlors and drawing rooms and wools in dining rooms and libraries. Silk continued to be used in wealthier houses. Windows were hung in the French style with straight curtains under valances or swags and festoons. The parlor replaced the bedroom as the location of the most elaborate drapery treatments.

WOOL, durable haircloth and leather were used for upholstery. It was also fashionable to cover chair cushions separately in silk or chintz to match window curtains, but silks were never used in more than a few best rooms, even in the most wealthy houses.

IN THE MID-20TH CENTURY it was common to regard pale colors as characteristic of this period. More recent research has shown instead a marked preference for dramatic printed designs and strong, almost glaring colors: rich yellow, orange, scarlet and blue, often arranged in bold combinations. The range of reproduction fabrics available for this period is large, reflecting current interest in the early printed designs.

DURING THE YEARS 1815-40, the development of power looms, the perfection of roller printing and improvements in dye technology greatly changed the textile industry in Europe and the United States and influenced textile fashions as well. Colorful, relatively inexpensive cotton prints were everywhere available for use as bed and window coverings and as slipcovers. Because of the quality of design and printing, even the simplest curtain designs with these furniture chintzes could be regarded as stylish. The use of metal cylinders for printing meant that repeats were smaller and details often very finely wrought. Popular designs included monochromatic landscapes, combinations of block and roller printing, floral stripes and elaborately foliated pillar prints.

IN WEALTHIER HOUSES, European designs for draperies and valances in silk, wool and chintz were often adapted from English and French publications. Sheer undercurtains were sometimes added to window treatments as part of a growing taste for layers of contrasting fabrics. In more modest houses, elaborate designs were copied in less expensive fabrics. Curtains continued to be regarded as functional despite the increasing complexity of the designs. They were opened and closed daily to admit or exclude light or air. As late as 1840 the windows of many kitchens and lesser bedrooms were without fabric hangings.

THE USE OF BED HANGINGS during this period was a matter of individual choice that reflected patterns of fashion as well as philosophies of hygiene. Throughout the 1830's and 40s controversy raged over the healthfulness of hangings that enclosed the bed. In 1839 the editor of *Godey's Lady's Book* wrote, "Bed hangings are unhealthy. They confine the air about us while we sleep." At the same time designers and decorators were publishing new designs for hangings and they were being manufactured in large quantities. It was not until the mid-19th century that bed hangings were relegated to strictly decorative display on the posts and tester frame.



"Bromelia" resist, a large-scale cotton print, c. 1765. A faithful reproduction by Brunschwig & Fils, Inc.

## 1840-1870

In the middle years of the 19th century the use of textiles to decorate American houses was lavish, reflecting the great availability of fabrics and the interest women took in the appearance of their domestic environment.

Fashionable fabrics included silk, velvet, damask, plain satin and figured chintz. Women often made their own curtains and bed hangings, although professional upholsterers continued to supply the wealthy. Popular manuals and magazines published designs and patterns and offered suggestions for creating decorative effects inexpensively.

As in the past, designs for window hangings were inspired by historical styles, but during this period different styles were often mixed in the same house. A basic formula for window hangings was sheer undercurtains, heavy side draperies and a valance that might be distinctively Greek, Gothic or Jacobean. Frequently two or three or more fabrics of different color and texture would be combined in a single design with braids, fringe, cords and tassels adding to the rich effects. Similar effects can be achieved today by using silks, wools or velvets in period colors with appropriate braids, fringes and trimmings. Although there are few documentary reproductions available, plain fabrics similar to the originals of the period can be found in the standard textile market.

## 1870-1900

During the years 1870-1900 rich and varied combinations of textures, colors and patterns characterized fabric furnishings. The photographs in William Seale's book The Tasteful Interlude records the lavish use of fabrics that extended to upholstered footstools, pillows, portieres and the draping of pianos, tables and chairs. The prominent display of crocheted doilies and elaborate embroideries evidenced a taste for handwork that was promoted by women's magazines and manuals as well as by the values of the English Arts and Crafts movement. Drapery design was exceedingly complex, often utilizing embroidered or lace undercurtains and elaborate fringes, tassels and tiebacks. Plush, sateen, brocattelle, twilled wool, velvets and silks were among the popular fabrics.

During this period the design and use of furnishing fabrics reflected several new influences. From England came the distinctive flat patterned fabrics and wallpapers designed by William Morris' Arts and Crafts firm, as well as an attention to materials and fine craftsmanship. At the same time, stimulated by the United States centennial, there was a revival of American colonial and Federal period motifs, including early reproductions of 18th-century fabrics. For this reason some of the reproductions of 18th-century fabrics that are available today, especially those of French copperplate prints, are as appropriate for late 19th-century interiors as they are for 18th-century ones. A third

influence on interior decoration and fabric design that should be noted, although currently it is not represented among reproduction fabrics, was the interest in exotic Japanese and Turkish motifs.

(Copyright © 1977 by the Preservation Press, National Trust for Historic Preservation in the United States. Reprinted by permission.)



La Pagode Toile, reproduction by Brunschwig & Fils of a French copperplate print on cotton, c. 1786.

## Book About Fabric

"FABRICS FOR HISTORIC BUILDINGS" is an indispensable guide and catalog reference to reproduction fabrics appropriate for use in either historic buildings or old houses.

AUTHOR JANE C. NYLANDER, curator of textiles and ceramics at Old Sturbridge Village, Mass., has written an excellent general introduction to aid persons with limited fabric experience in selecting and ordering fabric. Discussed in this section are historical and practical considerations, and basic pointers in ordering custom reproduction work.

THE MAJOR FEATURE of the book is a catalog listing 225 commercially available reproductions of fabrics used in the United States between the 18th century and 1900. This information includes: Manufacturer's catalog name for fabric, place, date and method of manufacture of original, content and width-length of one pattern repeat, organization or museum for which the fabric was reproduced, manufacturer's name for the document color.

ALSO IN THIS BOOK is a list of manufacturers and their addresses, a glossary of fabric terms and a bibliography.

"FABRICS FOR HISTORIC BUILDINGS" is a softbound book, 64 pages, with black and white photos. To order, send \$5.00 to: Preservation Bookshop, National Trust for Historic Preservation, 740 Jackson Place, N.W., Washington, D.C. 20006.

# Glossary Of Historic Fabric Terms

**BAIZE.** Woven woolen cloth having a long nap. Frequently used to cover desk and card table surfaces, either glued down or as a loose cover. Green appears to have been the most common color.

**BATISTE.** Fine light cotton or linen, usually cotton; from the French word for cambric.

**BOURETTE.** Silk fabric with a dull finish characterized by random black specks that are actually portions of the silk cocoon.

**BROCADE.** A figured fabric in which the design is woven in wefts that float on the fabric back or are cut away. These threads appear on the surface only in areas required by the design.

**BROCATELLE.** A special form of lampas with a pattern in one weave on a contrasting ground. Often heavy silk or linen is used for the ground wefts, which do not appear on the surface of the fabric.

**CALAMANCO.** A glazed worsted fabric, either plain or woven with a figured design in colors resembling silk brocades.

**CALICO.** Cotton cloth with patterns printed in one or more colors. In the 18th and early 19th centuries referred to printed cloth imported from India; now usually cotton prints with small stylized patterns.

**CAMBRIC.** Fine bleached linen.

**CAMLET.** Unglazed worsted fabric of plain weave. Descriptive of a group of 18th century materials including harrateen, moreen and china (cheyney).

**CHINTZ.** Glazed cotton cloth, in the 18th century always printed. First manufactured in India, but then imitated elsewhere. Printed designs usually have at least five colors and are frequently large-scale floral patterns.

**CRETONNE.** A stout unglazed cotton cloth printed on one or both sides, late 19th century in origin. It was used for window curtains and chair covers. At the present time it is unavailable in the U.S.

**DAMASK.** A reversible woven design of contrasting faces. Can be wool, silk or linen.

**DIMITY.** Cotton cloth with woven ribs forming a pattern of either stripes or checks.

**DOCUMENTARY COLORWAY.** A modern manufacturers' term used to indicate that the colors of the reproduction fabric are those of the original document. A colorway is a particular printed combination of colors.

**DOUBLE WOVEN.** Two ply, or made with two layers that are interwoven at regular intervals.

**DROP REPEAT.** A design that matches motifs in an alternating, zig-zag pattern when joined lengthwise; it requires additional yardage.

**FAILLE.** A ribbed fabric formed with heavier weft than warp yarns.

**FURNITURE.** A term commonly used in the 18th century to denote the full equipment of something. A "bed and furniture" meant the mattress, bolster, pillows, sheets, pillowcases and hangings; a "tea table and furniture" referred to a tea table with its accompanying objects for the service of tea. In the case of "window curtain and furniture," furniture referred to the rods, hooks, etc., as well as the cloth.

**FURNITURE CHECK.** A kind of checked linen or cotton used for slipcovers, window curtains and bed hangings, 18th century to the present.

**GAUFRAGE.** An embossing technique in which a heated metal cylinder having a raised design on it is pressed against the pile of plain fabric, such as velvet, thereby transferring the pattern.

**GLAZED.** Having a smooth and lustrous surface coating on the exposed side only.

**HARRATEEN.** In 18th century England and colonial America, a wool moire.

**HOLLAND.** An 18th and early 19th century term for closely woven linens, first manufactured in Holland but later throughout the British Isles.

**LAMPAS.** A figured fabric using additional wefts and warps to form a design in one texture on the ground of another. These additional fibers are woven into the back of the fabric, but it is not reversible.

**MARSEILLES.** A heavy cotton fabric with a pattern woven in the goods. Usually white, it was primarily used for bed coverings. Marseilles quilts were used from the late 18th century to the early 20th.

**MATELASSE.** A double-woven cloth that simulated quilting by interlocking in some areas to produce a puckered effect.

**MOIRE.** Fabric, often taffeta, having a surface that appears wavy or watery.

**MOREEN.** A stout woolen or cotton-wool blend, often embossed with a figured design. Commonly used for upholstery.

**MUSLIN.** A fine cotton cloth with a downy nap on its surface. Generally plain but sometimes decorated with a downy nap on its surface. Generally plain but sometimes decorated with openwork or embroidery. The finer grades were often called *mull*.

**OSNABURG.** A kind of coarse linen originally made in Osnabruck, Germany, but later imitated in England and elsewhere. Sometimes spelled "Ozenbriggs."

**PALAMPORE.** A cotton bed covering from India, usually printed or painted with beautiful designs.

**PLUSH.** A fabric with an even pile, shorter and less dense than that of velvet. Used for upholstery in the mid to late 19th century.

**REPEAT.** One complete pattern motif.

**RESIST DIE.** A method of indigo printing in the 18th century in which a resist paste inhibited the dye.

**RUSSELL.** Ribbed or corded fabric, usually with a cotton warp and wool weft.

**SATIN.** A shiny fabric created by a special weave leaving floats of numerous warp yarns on the surface. Usually silk, also wool and linen.

**SATEEN.** A smooth satin weave cloth usually in cotton. Used for window hangings, bed covers and occasionally as a ground for embroidery in the 19th and 20th centuries.

**SELVEDGE.** The lengthwise edges of a piece of cloth, often of heavier threads and sometimes a different weave intended to prevent raveling.

**SLUBS.** Lumps on thread, formed by careless spinning. Deliberate use of slubs to give an antique effect to finished cloth is inappropriate for restoration purposes.

**STUFF.** Commonly a thin woolen cloth.

**TAFFETA.** A closely woven, firm fabric of even weight and tension, known by its glossy surface. Usually silk but can be linen.

**TAMBOUR.** Embroidery worked on fine cloth with a small hook forming a chain stitch on the upper surface of the cloth.

**TOBACCO CLOTH.** Unbleached white cotton cloth used for protecting certain tobacco plants from direct sunlight, thus producing "Shadegrown Tobacco." Resembles the texture and weight of pure cotton muslin.

**TOILE.** From *toile imprimee*, meaning printed cotton. Now generally refers to copperplate-printed fabrics, either cotton or linen, more correctly those of French origin.

**VELVET.** A pile fabric created by the use of an extra warp over rods or wires in loops. It can be plain (left as woven) or the loops can be cut. If the pattern is created by alternating areas of cut and uncut loops, the fabric is called *cisele velvet*. If the pattern is woven leaving some areas without pile, it is called *voided velvet*. Usually wool, silk or cotton.

**WARP.** The threads that are stretched lengthwise on the loom, usually spun more tightly than the weft.

**WEFT.** The threads that are interwoven with the warp, thereby running crosswise in the goods, from selvedge to selvedge.

**WORSTED.** Fabric made of long staple wool that has been combed to make the fibers lie parallel to each other when spun.

# Products For The Old House



## Period Furniture

THE CROWN OF FAIRHOPE Company used to be known mainly for their clock kits. But they are now making late Victorian and turn-of-the-century furniture reproductions (along with Early American) that should be quite popular.

ONE OF THE most useful reproductions is an oak sculptured back chair with a cane seat. Probably a kitchen chair originally, it is appropriate for kitchen, dining room or parlor. Like most pieces, it is available finished or unfinished.

MANY REPRODUCTIONS also come in kit form at a considerable saving. There are hall trees, handsome collector's coffee tables (with glass case tops), a pie safe with perforated tin

panels and an oval mirror with oak frame. These come in either oak, mahogany or pine.

THERE ARE ALSO a few tables in black walnut, described as Early American in the catalog, that look very much like East-lake furniture.

AN ILLUSTRATED CATALOG is \$1.00. Write to: Crown of Fairhope, Dept. OHJ, P. O. Drawer G, 759 Nichols Ave., Fairhope, Alabama 36532.

## Woodworking Tool Catalog

ANYONE WHO IS a woodworking enthusiast should have the Woodcraft catalog. They have an extensive array of the finest quality tools that you won't find at the neighborhood hardware store. There are wood moulding planes, every sort of marking gauge, marquetry and veneering tools, and an incredible variety of chisels.

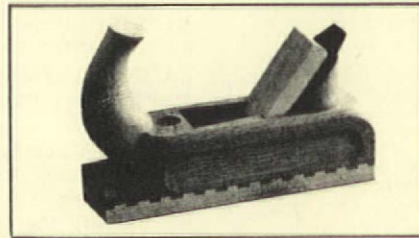

GERMAN GENT'S PLANE

ACCESSORIES include glue pots, glues, brushes, dowels and pegs. The catalog is also an excellent source for cabinet-making books.

ALTHOUGH Woodcraft usually asks 50¢ for their catalog, they will send it free to Old-House Journal readers. Write to: Woodcraft Supply Corp., Dept. OHJ, 313 Montvale Avenue, Woburn, MA 01801.

## A Polyurethane Bullseye

FYPON, makers of high density polyurethane molded millwork, has a new brochure that features several new products.

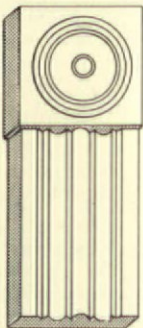

THE BULLSEYE moulding (pictured at right) is motif that was widely used in many styles of old house. Replacements are often needed. Fypon has now added bullseye moulding to its line. It comes in 7 ft. 8 in. lengths.

THE BROCHURE also features a mantel roof, dormer head and a rake moulding. Free from: Fypon, Inc., Dept. OHJ, 108 Hill Street, Stewartstown, Pennsylvania 17363.

### Ring Binders

**Keep Your Journals  
Neat And Organized  
For Handy Reference**

Binders have tough vinyl covers stamped in gold on front cover and spine. The large ring size (1½ in.) easily holds 24 issues and opens flat for easy reading and reference.

Binders are shipped via Parcel Post. Please allow 2-4 weeks for delivery. To order, send \$4.75 to: The Old-House Journal—Reprint Dept., 199 Berkeley Place, Brooklyn, N.Y. 11217.

### New!

### The Old-House Journal 1978 Catalog

● Buyers' Guide Directory to 5,873 hard-to-find items and services for the old house;

● 525 Companies listed;

● 219 of these sources are new—did not appear in the 1977 Buyers' Guide.

Single copies: \$7.00  
(\$4.00 to subscribers)

Order from:

The Old-House Journal

199 BERKELEY PL. • BKLYN, N.Y. 11217

### Subscriptions: The Old-House Journal

Enclosed is my \$12 for a one-year subscription to The Old-House Journal.

Subscription is: Gift  Personal

Name \_\_\_\_\_

Address \_\_\_\_\_

City \_\_\_\_\_

State \_\_\_\_\_ Zip \_\_\_\_\_

Donor's Name \_\_\_\_\_

Mail to: The Old-House Journal, Dept. 7,  
199 Berkeley Place, Brooklyn, N. Y. 11217

# THE OLD-HOUSE

# JOURNAL

Restoration

Vol.V No.11  
November 1977

\$1.50

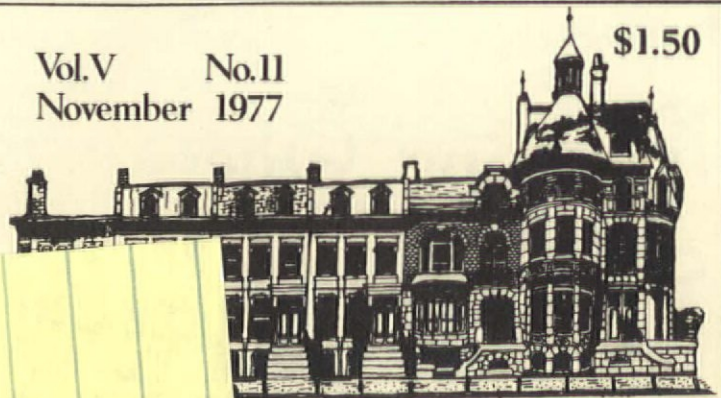

For The Antique House

OUT  
1977-11



## Reproduction Fabrics

Issue

Adding Storage to the Old House.....	125
A Polyurethane Bullseye.....	132
Glossary of Historic Fabric Terms.....	131
Stenciller's Art in Indiana.....	122
Woodworking Tool Catalog.....	132

### Coming Next Month

THE CO-INSURANCE TRAP

SELECTING FABRIC for curtains, bedspreads and upholstery is an important part of incorporating authentic period details in the furnishing of the old house. There is a wide variety of reproduction 18th and 19th century fabric available today. It is necessary, however, to have an acquaintance with the kinds of fabric used in the United States up to 1900 in order to choose an appropriate reproduction. A very helpful new book, "Fabrics For Historic Buildings" has recently been published by The National Trust For Historic Preservation. With their kind permission, we have excerpted some of the historical information as well as a glossary of old terms. These brief discussions of the kinds of fabric used in various periods will help the old-house owner to select fabric with an eye to quality and appropriateness. Full details on how to order the book will follow this article.--C.F.

### The 18th Century

IMPORTED FABRICS seem to have been preferred for furnishing American buildings in the 18th century. English fabrics, protected by the high taxes that the mother country imposed on goods imported into the colonies from other countries, predominated.

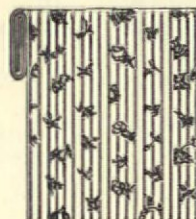

THE 18TH CENTURY saw the beginnings of

industrialization in textile manufacture in England. Throughout the period designs were handprinted from woodblocks, but in the middle of the century the introduction of mechanical processes and engraved copper plates for printing on cotton or linen expanded production and made possible fine linear designs with much larger repeats that were especially well adapted for furnishing use. The colors were primarily deep indigo blues and the rich purples, reds and sepias that are derived from madder. Typical English designs included large-scale flowers and birds, chinoiseries, pastoral landscapes and special commemorative designs.

DOCUMENTARY EVIDENCE makes it clear that few houses were embellished with elaborate window hangings in the colonial period. For those who could afford domestic luxury, the most lavish use of fabrics was in the covering and hanging of the best bed. In many estate inventories, the value of beds with hangings far exceeds that of any other piece of furniture in the entire house. Bed hangings of green harrateen or cheyney were common, with crimson or scarlet the second most popular color.

IF THERE WERE ANY WINDOW HANGINGS at all, they would have been hung in the parlor chamber, the room over the parlor

(Continued on page 129)

# Reviving The Stenciller's Art In Indiana



By Mrs. Richard V. Mikesell, Richmond, Ind.

**T**HE RESTORATION of the Agnes and Abram Gaar home--why, where and how did it start? Unoccupied and neglected after the death of my mother in 1962, the roof developed leaks, the furnishings collected dust, the radiators rusted, an all but forgotten home badly in need of repair or demolition. My husband forced me to make a decision.

I COULDN'T STAND the thought of a hundred-year old Victorian ancestral landmark being torn down. So the first step was new roofing over all the house, done during the summer of 1974. This experience almost caused me to stop before we really got started.

DURING A WORK STOPPAGE over the Fourth of July weekend, the roof only had a felt covering and some very heavy rains caused further damage to the interior, such as half the ceiling of one bedroom falling and water dripping

in the dining room beneath, causing damage to the table and mildewing the carpet. The roofing company's insurance partially paid for the damages.

A TREE HAD BLOWN DOWN NEAR THE front entrance and a limb had broken and bent the aluminum awning over the porch. Repair or remove? Twenty years ago my parents had removed the original front porch and replaced it with a larger, screened one where they could enjoy the view and fresh summer breezes without bugs. Fortunately, they stored some of the old material in one of the barns. Knowing it was there behind the bales of hay, we hauled it out to see if there was enough to reconstruct it.

**H**AVING THE ARCHITECT'S ORIGINAL plans on Hlinen has been invaluable during the restoration. This gave us the exact dimensions to go by in replacing the missing parts. We found the side rails and spindles, the ceiling and top-trim, and the two half-columns that were against the house. We did not find the six columns, three being grouped at each corner toward the front, nor the rails or spindles that formed the balcony over the porch roof. We had enough to go by to have these missing parts reproduced.

IN REMOVING THE NEW PORCH we found side stone foundations of the original, still in place; unfortunately the thick stone steps had been broken up and used for filler under the new. But this didn't stop us. When the Palladium bought property on North A Street for its new building they allowed us to remove some stone slabs and the museum had stored the steps on their property and gave us what we needed, so all but the coping has been restored. Credit must be given to Paul Albert and his assistant, Ed Masters, for reconstructing the front porch, and to Elmer Turner of Acme Patterns for reproducing the caps and trim for the columns and Commons Lumber Company for turning the spindles and other parts.

WHAT TO DO WITH THE INTERIOR? On the third floor there are four bedchambers, as they were noted on the plans, a bathroom, large storage room with cedar-lined closet, and a small room to the front with a winding stairway to the

## THE OLD-HOUSE JOURNAL®

Published Monthly For People Who Love Old Houses

Editor .....	R.A. Clem Labine
Decorative Arts Editor .....	Carolyn Flaherty
Circulation Director .....	Paul T. McLoughlin
Circulation Assistants .....	Joan O'Reilly Peggy Scaglione James Graham
Midwest Editor .....	Tom H. Gerhardt
Staff Photography .....	Jim Kalett
Contributing Editors .....	Claire Wood Labine R.A. Labine, Sr. H. Weber Wilson Barbara Schiller

Published by The Old-House Journal Corporation, 199 Berkeley Pl., Brooklyn, N.Y. 11217. Tel. (212) 636-4514. Subscriptions \$12/yr. in U.S. and Canada; \$20/yr. elsewhere. Printed at Royal Offset Co., 34 W. 15th St., NYC 10011. Contents of the Old-House Journal® are fully protected by copyright and must not be reproduced in any manner whatsoever without specific permission in writing from The Editor.

tower which has a lovely view to the south overlooking the farm and the city. There are four bedchambers on the second floor and on the main floor the hallway extends the full length of the house. Off the sitting room is the conservatory added by my parents.

**WE** REMOVED FURNITURE and things not of the period, stored china, glassware, lamps, pictures, etc. so that some painting and cleaning could be done. Our daughters were able to use some of the extra furniture and the Salvation Army took the rest. I almost gave them an original chair. One of the men was carrying it out the back hall when I suddenly realized that the wood trim on the arms and legs was Victorian!

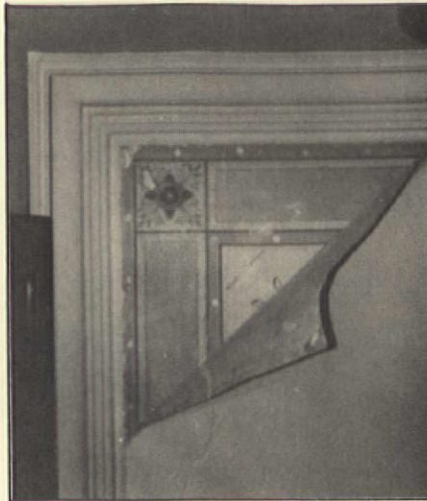

Original stencilling on library ceiling is uncovered.

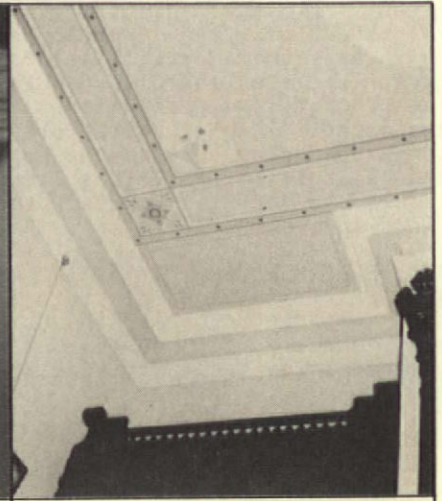

The ceiling now, with its stencil designs restored.

THE DECISION WAS MADE to start on the top floor and work down. Moisture-stained and loose wall paper had to be removed--who would do it! Through the Hohenstein's Suburban Tool Rental we located a steamer and a young man to operate it. During the course of this work he informed me that he had had experience in painting and cleaning and that he and his friend would appreciate the opportunity to continue the work. They are David McConkey and Donald Bridgford, the two men who have done an expert, diligent and excellent job on the restoration of the ceilings, walls, woodwork, hardware and floors of the entire house. In fact, they have formed a partnership known as the 1776 Interiors and Decorators.

THE THIRD FLOOR ROOMS and tower have been plaster-patched and painted, the inside shutters refinished, the painted woodwork hand-grained, and the natural woodwork cleaned and polished, and the floors painted.

**N**OW FOR THE REALLY EXCITING PART--uncovering the original! In the 1950's my parents converted the library and parlor into two bedrooms because of their failing health and fear of not being able to escape in case of fire. In removing a closet and powder room from the parlor we discovered a wide painted band of ceiling design, also the original soft green of the walls and darker green stencilled frieze below the cornice. Incidentally, the cornice had to be remolded and restored in the corners where the closet, etc. were. This was done by one of Ralph Whisenhunt's expert plasterers. After finding the ceiling and wall trim we could hardly wait to remove the wallpaper from the second floor and other areas. Thankfully, wallcovering had been put on instead of paint--or all would have been lost forever!

EVERY ROOM, even the front hall, stairway, and the back hall and stairs are all a different design. The men either made stencils or tracings of all the designs and took color photos to get the correct colors. In order to learn from an expert what kind of paints to use, how to mix and apply them, they made a special trip to Cleveland, Ohio to consult with Mr.

Roman Celleghin who was born in Italy and is now in his eighties. As a young boy of 12 he began painting murals in wet plaster in his home town of Providence di Padova, some of them can still be seen today.

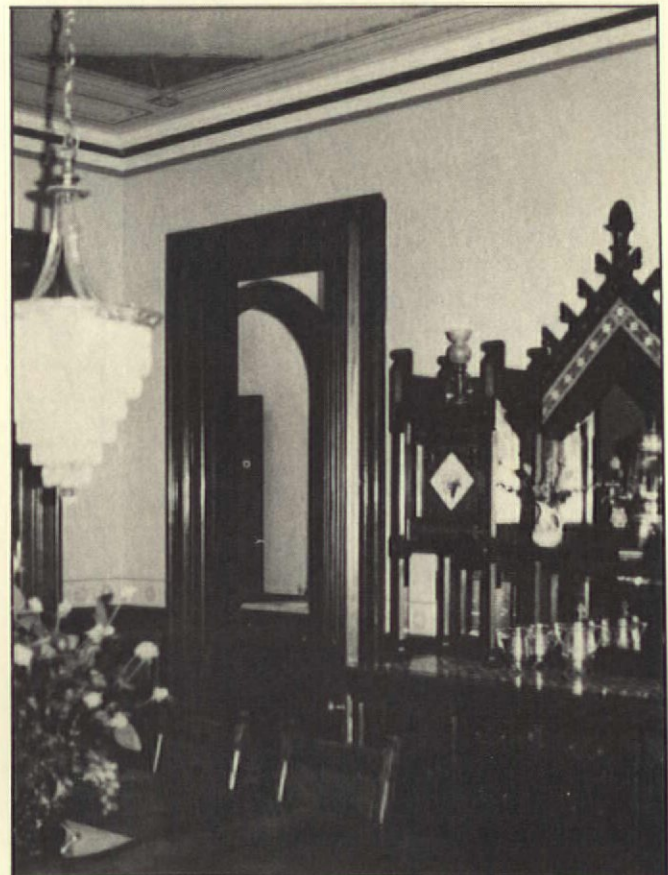

Dining room, showing restored triangular ceiling design in gold leaf. Furniture and accessories are original. Dining room table has 7 leaves and 12 chairs.

**W**HEN THE PARLOR AND LIBRARY were converted to bedrooms, the lower sashes of the windows were removed and replaced with the crank type. We found the old ones in the basement and other things were uncovered in some of the outbuildings--the fretwork that was in the arched door between the parlor and library, the backsplash for the wash bowl and some of the wooden and brass curtain rods with brass rings and wall holders.

THE THREE-SHELVED DUMB WAITER was at the basement level and used for storage of paint cans, etc. We found a few of the outside shutters. Unfortunately, not enough, but at least a pattern if we decide to replace them.

DAVE AND DON found an article in the library from the April 20, 1877 edition of the Richmond Telegram, telling about the architect, carpenter, and the companies that furnished the lighting and plumbing fixtures and hardware to the Abram Gaar house. The article, which details the heating and water systems, how the nailheads were hidden in the woodwork, and the finish on the basement floor, is one of the most valuable documents we have.



In the parlor only the original border was found. The rest had been newly plastered. The decorators took the design from the original parlor table, (at right) which had been on exhibition at the Philadelphia Centennial in 1876, blew it up to scale and put it on the ceiling. Horses and chariot in center of the table are on the ceiling in the bay window area. Gas and electric chandelier is original.

**A**NOTHER VALUABLE DOCUMENT is the invoice for the furniture, dated May 1877, from the Mitchell and Rammelsberg Company of Cincinnati. It lists the Brussels lace curtains, 3 pairs, \$225, hall rack with inlaid blue tile at \$260, and the walnut Eastlake extension table with 7 leaves at \$75.

SEVERAL OF THE ORIGINAL LIGHT FIXTURES on the first floor are intact, the crystal chandeliers in the front entry, sitting room, parlor and library and the Scottish Knight in burnished armor on the newel post. The crystal chandeliers are a combination of gas for emergency purposes. The fixtures on the second floor I have purchased at sales, antique shops and elsewhere. They have been cleaned, rewired and fitted with interesting bulbs by Donald Hopkins of the Lamplighter Shop.

THE ORIGINAL BATHROOM on the second floor created a real challenge, the old tub and watercloset (toilet) had been discarded for modern equipment, some of the wainscoting behind the tub had been replaced with tile, and of course, linoleum on the floor. Fortunately, the wash basin remained and there again the backsplash was found in a barn.

THE CARPENTERS thought I had lost my mind when I had them remove the ceramic tile and replace it with wainscoting. Dave and Don nearly lost theirs when they had the horrible task of removing the linoleum and glue from the floor to uncover a beautiful oak floor with inlaid border. Temporarily, we are using a turn-of-the-century toilet seat and wooden tank with lead lining and hope to find one of correct vintage. The tub with claw feet was purchased and the matching foot-tub.

**T**HE HOME AND FARM are now on the National Register of Historic Places and I appreciate very much the bronze plaque on the front door. It reads, "Agnes and Abram Gaar Home, Built 1876, architect John Hasecoeter, presented by the Heritage Club, 1976."

HOPEFULLY, I have not failed to give credit where it is due. The restoration is not complete--it has been fascinating, time consuming, costly, very rewarding, and a real labor of love--indeed, a monument to the memory of Agnes and Abram Gaar. ■■

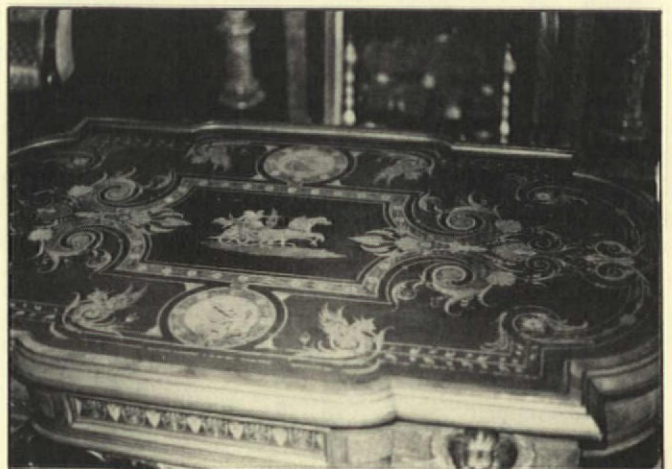



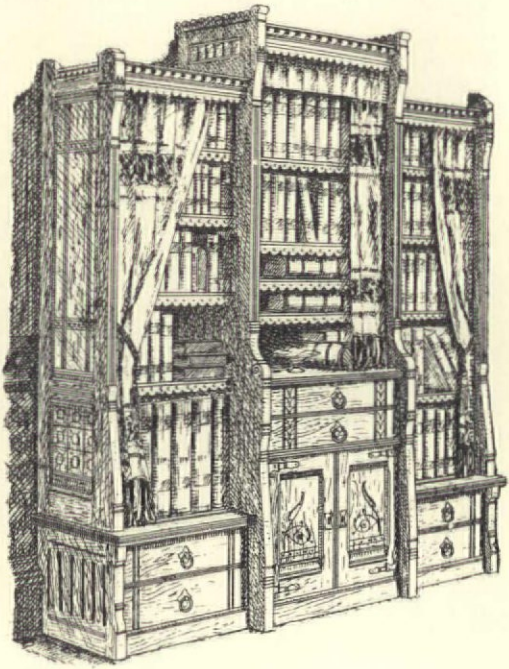

## Adding Storage To The Old House

By Stephen MacDonald

**S**TORAGE IS ONE OF THE MORE vexatious problems besetting the owner of an old house. We have so many possessions these days—many of which hadn't even been invented when the house was built. Even articles that had been invented—like books—weren't owned in the abundance that they are today. This means that today's old-house owner will either have to throw away some of his or her possessions (which might not be a bad idea at that) or add some storage space to the house.

LET'S BEGIN WITH THE UNDERSTANDING that in adding storage facilities to your house you are adding an anachronism—however necessary it may be. If you don't want it to LOOK like an anachronism, the unit will have to be custom-made to suit your particular house. Fortunately, many kinds of storage units are reasonably easy do-it-yourself projects.

SHELVES FOR BOOKS, records and the like are a good place to begin, because they are easy enough to build so that a novice carpenter can have a confidence-building success. And the experience introduces skills that can be expanded into more ambitious cabinet-making projects later on.

### Design Factors

**S**HELF-BUILDING PROJECTS involve two basic steps: (1) Construction of the basic unit, which is pretty much the same for everyone; (2) Adding the finishing touches (mouldings, etc.), which have to be tailored to you specific house. The following instructions will guide you through the carpentry of the basic construction and then give you some ideas on tailoring the result so that it looks as though it were built with the house.

THE FIRST STEP IN DESIGNING the bookcase (we'll call it that, even though the unit

could be used to accommodate other things) is to plan out such functional matters as how much capacity you require and where the unit will stand. Then you have to add aesthetic factors such as what dimensions will give you the desired capacity in a shape that makes sense in the room you have selected. You might want to build tall cases that reach to the ceiling... or door height...or wainscot height. In these considerations you'll do well to consult books that have photos of houses of similar vintage to yours, and visit neighbors who own old houses.

HOW FAR APART should shelves be? It's possible to make them adjustable, of course, and some people think this is the safest course. On the other hand, most people don't adjust their adjustable shelves very often (if ever) after they are in place. And fixed shelves are both stronger and better looking than the adjustable kind. Usually, good advance planning can eliminate the need for adjustable shelves.

FINAL PROCEDURE in this first part of the design is to draw up a detailed plan of the basic structure and include all dimensions.

### Special Trim

**N**EXT STEP IS TO CONSIDER what special touches will make the basic shelf unit look as if it had been in your house forever. Many old bookcases tended to be ornate, with such features as elaborate carvings and bevel-glass doors. If you have the woodworking skill to bring off this kind of thing, by all means go right ahead. But it isn't necessary. A simpler but quite satisfactory effect can be achieved by selecting an architectural detail that's part of the room where the bookcase will be and incorporating it in the design. For example, copy the room baseboard and extend it around the bottom of your unit. Select a crown moulding for the top that is similar to your cornice moulding or framing woodwork in the room. Perhaps you'll also want to add strips of decorative moulding to the fronts of the uprights.

ANY WELL-STOCKED LUMBERYARD carries a variety of ready-made mouldings in softwood that can be stained or grained to match hardwood. It's

almost always possible to combine two or three stock mouldings in a way that comes close to matching old mouldings.

## Selecting Wood

**W**HAT MATERIALS should you use? If the unit is to be painted or grained, possibly even stained, softwood lumber will be the logical choice because it's the cheapest—although lumber prices have gone so high in recent years that nothing can be considered cheap. For the genuine hardwood look you'll have to use either solid hardwood or else a plywood veneer. Solid hardwood is available in some lumber yards in some cities—but it's always expensive. Veneered hardwood plywood is an excellent substitute—and it's somewhat cheaper and easier to find. You can find plywood faced in almost every kind of wood.

EDGES OF PLYWOOD VENEER can be covered with a strip of veneer (sold in hardware stores and lumber yards) attached with contact cement. Even better is to face the edges with moulding strips of the appropriate hardwood—if you are fortunate enough to locate some.

PERHAPS A WORD IS IN ORDER on lumber grades, which can confuse even an experienced handy-person. Softwood boards are sold in two broad grades—Select and Common—but there are several sub-grades in each category. Few yards stock the full range of grades, so mostly you'll be choosing between the Select and Common that your yard carries. Select costs roughly twice as much as Common, so it's worth considering whether you can make Common do the job. Sometimes you can cut several good pieces out of a Common board; other times you can fill and seal knots. But when you need a long piece of clear wood, you'll have to pay for Select.

IT IS VITALLY IMPORTANT that your lumber be dry. Wet wood is hard to cut, it dulls blades, and shrinks and warps as it dries to the humidity level of your house. The best wood is kiln dried.

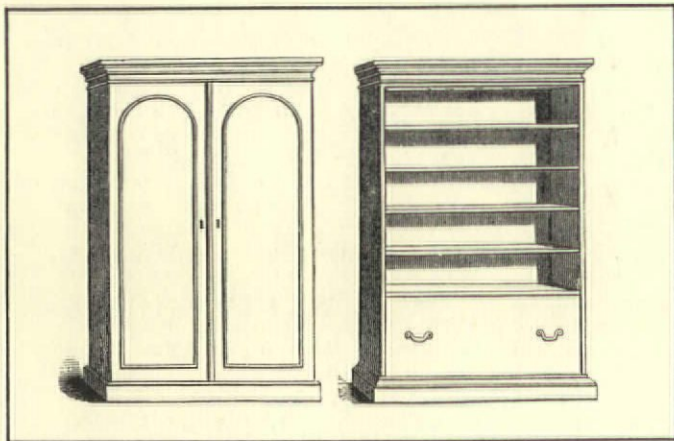

Simple storage unit (which can be used with or without doors) from Downing's 1850 edition of "The Architecture of Country Houses."

HARDWOOD IS GRADED DIFFERENTLY. The top quality is known as FAS—meaning Firsts and Seconds—followed by Select and Number 1 Common. FAS has few defects, Select has a few more (especially on the back face), and Common is usually unsuitable for large pieces such as bookshelf units.

**A**S FOR PLYWOOD, the softwood variety is frankly not recommended for quality work—even if the plan calls for painting. Its interior plys are soft and loose. Hardwood plywood is available in several grades. The highest, Premium, is probably not worth the extra expense unless you need matched graining. The grades known as 1 or 2 are adequate. Many yards term their plywood "G2S" (meaning Good on 2 Sides), or "G1S," (Good on 1 Side).

PLYWOOD IS SOLD IN PANELS, usually 4 ft. x 8 ft., in 1/8, 1/4, 3/8, 1/2, 5/8, 3/4 and 1 in. thicknesses. Boards are sold in "nominal" dimensions—which means the size before finishing and drying. Thus a board nominally 1 in. thick actually measures about 3/4 in. A nominal 5/4 (called "five quarter") measures a little over an inch thick. These are the two most likely thicknesses for shelves. Board widths are nominally 4 in., 6 in., 8 in. and up, increasing by twos. Board lengths are actual dimensions, beginning at 8 ft. and increasing by 2-ft. increments.

BACKING FOR SHELVES can be made of Masonite (if it is to be painted or grained), or else 1/4-in. hardwood plywood.

## Mystique Of The Lumberyard

**W**HAT ALL THIS MEANS is that you must get to know your way around the lumberyard if you expect to do much woodworking.

First step is to know exactly what you want. Using your plan of the bookcase, make a rough sketch of each component with its dimensions (you won't be able to do this until you have read the following sections on joinery).

USE YOUR COMPONENT DRAWINGS to work out a cutting plan. Try to figure out on paper the minimum amount of lumber you need to buy and how to cut it. Use your cutting plan to derive the lumber list—which is the shopping list you take to the yard. Take along your component sketches and cutting plan, too. You may be planning to buy four pieces of 8 ft. 1x10, but if the yard is out of 8 ft. lengths you'll need to recalculate in a hurry!

LUMBER YARDS HAVE A MYSTIQUE for many people, but they're really quite straightforward when you get to know them. The typical operation has an office and a yard. You place your order in the office, and then take your receipt to the yard to get the order filled.

THE MOST IMPORTANT PERSON in the place, as far as you're concerned, is the yard man (or the yard foreman in a large yard). He is the one who is going to select your wood—or better yet, allow you to select it. Yards vary in their attitude about do-it-yourself lumber selection. Some insist that if you are buying three boards in a size then you must take the

top three on the pile. Others let you pick through till you find the three you want.

STILL OTHER YARDS fall somewhere in the middle; they'll allow you to reject an occasional board but not grope through an entire pile. Whatever the yard policy, it's important that you be on hand, if for no other reason than to let the yard people know you are concerned about the quality of the lumber. This is especially true if you are trying to build with Common lumber, where there may be great variations in boards that cost the same.

DO NOT—unless your brother is the yard man—phone in an order for delivery. You are likely to get the dregs that everyone else has rejected. If the yard man is helpful, it's not a bad idea to tip him a dollar or two. That way he'll remember you the next time you come in.

### Cutting And Fitting

**B**ACK HOME at your shop, you begin by squaring an end of each board, crosscutting it in the appropriate lengths, following your cutting plan. If you're using plywood, you'll begin by ripping the sheets into boards, then crosscutting to length. In this and in all cabinet work and other ambitious carpentry, it is essential that all cuts be square and accurate to 1/16 in. or better. The way to assure this is by measuring carefully ("Measure twice, cut once," as the saying goes), keeping your blades sharp and being sure that your saw—especially if it is a radial-arm saw—is in perfect alignment. A radial-arm saw is one of the most versatile and useful of home shop tools, but it gets out

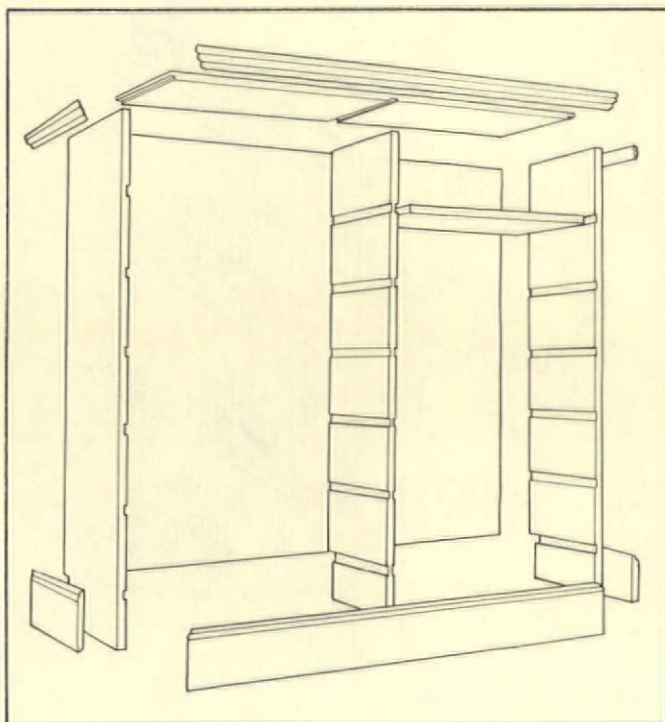

of alignment notoriously easily. A dull blade that drags through the wood will pull it out of adjustment in just a few passes.

NEXT, cut the dados and rabbets. These are basic wood joinery cuts, used in almost all cabinet work. A dado is simply a channel in a piece of wood where another piece joins it (in this case where a shelf fits into the

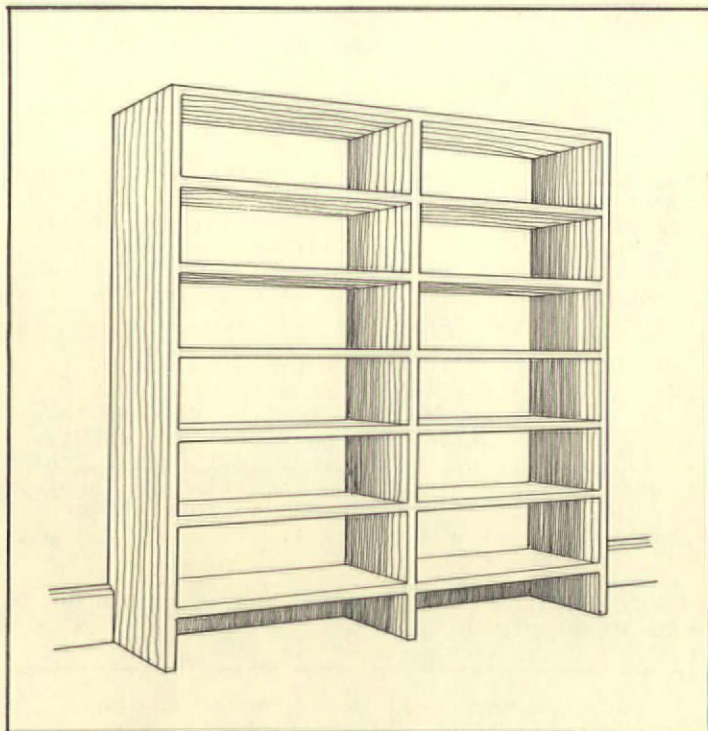

The addition of an appropriate crown moulding and baseboard bring a simple

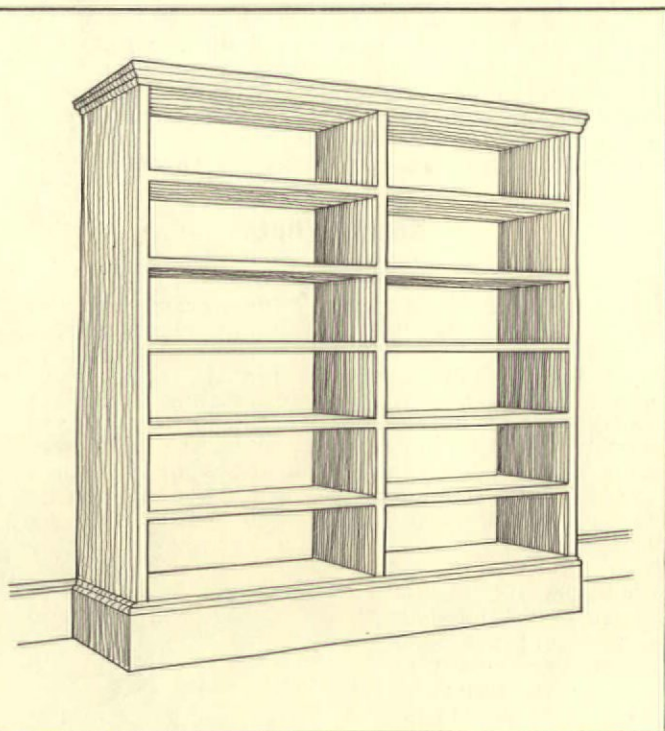

box shelf unit into harmony with the rest of the room.

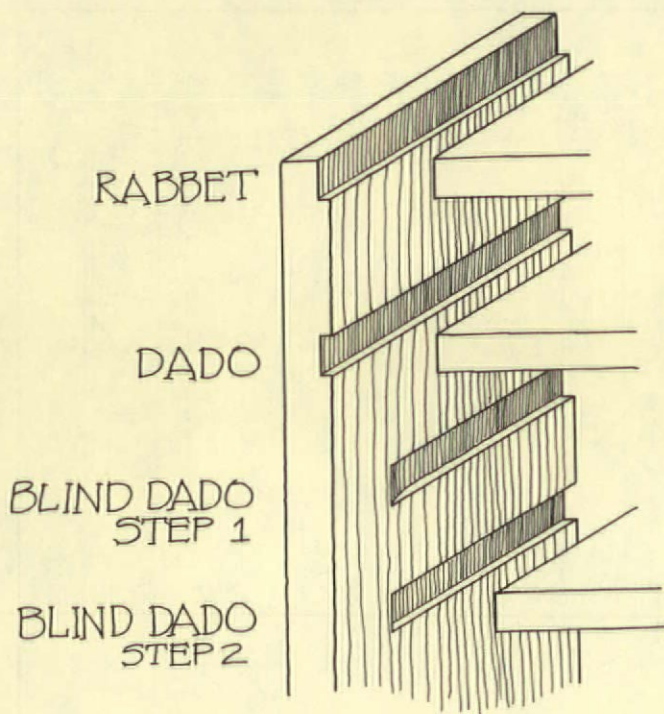

sides). A rabbet is like a dado, but along an edge. Bookcase sides are often rabbeted along the inside back edge to accept the back, and across the inside top to accept the top shelf.

THESE CUTS are easy to make with special blade sets. Dado sets for radial-arm and table saws include two cutters that look much like regular blades, several chippers and some small shims. You make up a sandwich of the cutters, putting as many chippers and shims between them as are needed to make a dado the width you want. Dadoes and rabbets can also be cut with a router or, if you prefer the old-time hand skills, with special planes. In any case, the position, width and depth of the cuts are critical, and great care must be taken.

### Special Cuts

**D**ADOES MUST BE just wide enough for the shelves to fit snugly. Too narrow and the shelf won't fit without an unholy struggle; too wide and it will be sloppy—leaving a gap. It's a good idea to sand the shelves before measuring them for the dadoes, because sanding makes them slightly thinner. Dado depth should be about 1/4 in. for bookcases made of nominal 1-in. stock or 3/4-in. plywood. At the outset, you should make a few trial dadoes in scrap wood before cutting "for real."

SOMETIMES YOU'LL WANT to use a "blind dado," as for instance when the shelves don't extend to the front of the sides. To do this, cut with the dado blade to the point where the shelves will stop, then use a very sharp chisel to square out the channel.

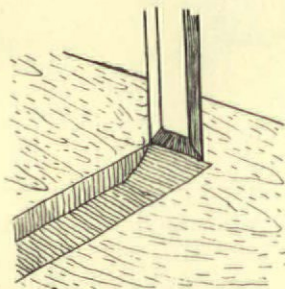

**A**FTER CUTTING AND DADOING, put veneer or moulding strips on any plywood edges that will show, then sand and dust all pieces. If the finished unit will be too large to conveniently carry through a doorway, move the components to the room where the bookcase will stand. If there is a baseboard on the wall, cut out the rear bottoms of the uprights with a sabre saw. If the bottom shelf is at baseboard height, you'll have to make it less deep than the others. And the back must also stop above the baseboard.

LAY OUT AND ASSEMBLE the bookcase according to your design. Use good quality yellow (not white!) cabinetmakers' glue and finishing nails in all joints. (Franklin's "Titebond" glue is a good high-strength, long-lasting adhesive.) Shelves can be face-nailed from the outside of the uprights, but the nail holes will be less obvious if you toenail them from the inside—a more difficult job. The nails should be sunk with a nailset and the holes filled with wood putty. If the wood will be finished naturally, the best filler is linseed-oil glazing putty colored with pigments to match the finished wood. This filler should be added after the natural oil finish has been applied to the wood.

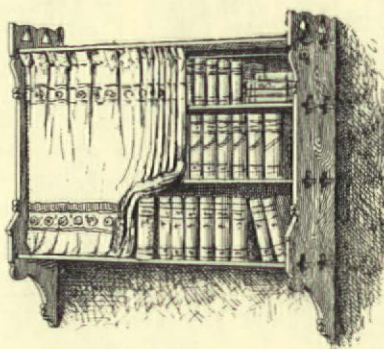

*Hanging Shelves.*

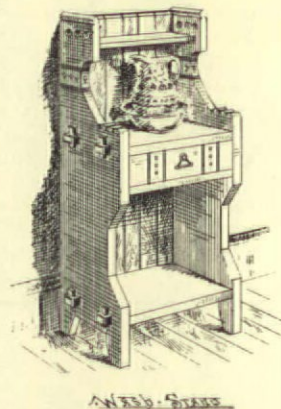

**O**NCE THE SHELVES, sides and tops are in place, attach the back and hoist the unit into position. Then you can install the mouldings and other trim that will give your basic bookcase its special character. You may want to tack small strips of moulding over the front edges to cover the dadoes.

IF THE BOOKCASE is tall, it may be necessary to anchor it to keep it from toppling. The simplest way to do this from the top—if there is room to work between the top shelf and the ceiling. First, find a stud in the wall, then screw an angle bracket to the wall and the top of the bookcase. If there's no room on top, use the top of a high shelf. ■ ■

NEXT MONTH: Further ideas on using mouldings to dress up your shelving units.

Stephen MacDonald is a product designer by profession—and a finish carpenter by inclination. He's had ample opportunity to hone both skills during the renovation of his Brooklyn brownstone.

where the best bed was located. Usually the fabric and color of the curtains matched that of the bed hangings. Any upholstered furniture or window-seat cushions in the room were usually covered in the same material or in leather of the same color. Slipcovers or cases of printed or checked cotton or linen were frequently used to protect the upholstery. If a family had curtains in more than one room, the second set would be in the parlor.

THERE ARE MANY excellent reproductions of 18th century silks, linens and printed cottons, but limited evidence to support their use in American buildings. Wool, by far the most commonly used material, is scarcely represented among modern reproduction fabrics.

### 1790-1815

TOWARD THE END of the 18th century and in the early years of the 19th century, the mechanized textile production that came with the Industrial Revolution lowered costs and brought furnishing fabrics, especially printed cottons, within the economic reach of many persons for the first time. Inevitably, fashion followed, and furnishing fabrics began to be used more widely and in greater abundance than they had before. Most fabrics were still imported from England, which had the most advanced textile technology, but merchants also imported French, Indian and Chinese fabrics into the United States. The infant American textile industry was not yet a factor in providing fabrics for home furnishings.

ALTHOUGH WOOL bed hangings continued to be used during these years, chintz was now regarded as more stylish and had the added advantage of being easily washable. Bed valances were wider than they had been in the 18th century, ranging up to 20 inches, sometimes with added netting or fringes. The most elaborate designs for bed hangings included many additional pieces--extra valances, short curtains, swags and rosettes. Window hangings also evidenced the growing fashion for fabrics. Chintz was favored in parlors and drawing rooms and wools in dining rooms and libraries. Silk continued to be used in wealthier houses. Windows were hung in the French style with straight curtains under valances or swags and festoons. The parlor replaced the bedroom as the location of the most elaborate drapery treatments.

WOOL, durable haircloth and leather were used for upholstery. It was also fashionable to cover chair cushions separately in silk or chintz to match window curtains, but silks were never used in more than a few best rooms, even in the most wealthy houses.

IN THE MID-20TH CENTURY it was common to regard pale colors as characteristic of this period. More recent research has shown instead a marked preference for dramatic printed designs and strong, almost glaring colors: rich yellow, orange, scarlet and blue, often arranged in bold combinations. The range of reproduction fabrics available for this period is large, reflecting current interest in the early printed designs.

DURING THE YEARS 1815-40, the development of power looms, the perfection of roller printing and improvements in dye technology greatly changed the textile industry in Europe and the United States and influenced textile fashions as well. Colorful, relatively inexpensive cotton prints were everywhere available for use as bed and window coverings and as slipcovers. Because of the quality of design and printing, even the simplest curtain designs with these furniture chintzes could be regarded as stylish. The use of metal cylinders for printing meant that repeats were smaller and details often very finely wrought. Popular designs included monochromatic landscapes, combinations of block and roller printing, floral stripes and elaborately foliated pillar prints.

IN WEALTHIER HOUSES, European designs for draperies and valances in silk, wool and chintz were often adapted from English and French publications. Sheer undercurtains were sometimes added to window treatments as part of a growing taste for layers of contrasting fabrics. In more modest houses, elaborate designs were copied in less expensive fabrics. Curtains continued to be regarded as functional despite the increasing complexity of the designs. They were opened and closed daily to admit or exclude light or air. As late as 1840 the windows of many kitchens and lesser bedrooms were without fabric hangings.

THE USE OF BED HANGINGS during this period was a matter of individual choice that reflected patterns of fashion as well as philosophies of hygiene. Throughout the 1830's and 40s controversy raged over the healthfulness of hangings that enclosed the bed. In 1839 the editor of *Godey's Lady's Book* wrote, "Bed hangings are unhealthy. They confine the air about us while we sleep." At the same time designers and decorators were publishing new designs for hangings and they were being manufactured in large quantities. It was not until the mid-19th century that bed hangings were relegated to strictly decorative display on the posts and tester frame.



"Bromelia" resist, a large-scale cotton print, c. 1765. A faithful reproduction by Brunswick & Pils, Inc.

## 1840-1870

In the middle years of the 19th century the use of textiles to decorate American houses was lavish, reflecting the great availability of fabrics and the interest women took in the appearance of their domestic environment.

Fashionable fabrics included silk, velvet, damask, plain satin and figured chintz. Women often made their own curtains and bed hangings, although professional upholsterers continued to supply the wealthy. Popular manuals and magazines published designs and patterns and offered suggestions for creating decorative effects inexpensively.

As in the past, designs for window hangings were inspired by historical styles, but during this period different styles were often mixed in the same house. A basic formula for window hangings was sheer undercurtains, heavy side draperies and a valance that might be distinctively Greek, Gothic or Jacobean. Frequently two or three or more fabrics of different color and texture would be combined in a single design with braids, fringe, cords and tassels adding to the rich effects. Similar effects can be achieved today by using silks, wools or velvets in period colors with appropriate braids, fringes and trimmings. Although there are few documentary reproductions available, plain fabrics similar to the originals of the period can be found in the standard textile market.

## 1870-1900

During the years 1870-1900 rich and varied combinations of textures, colors and patterns characterized fabric furnishings. The photographs in William Seale's book The Tasteful Interlude records the lavish use of fabrics that extended to upholstered footstools, pillows, portieres and the draping of pianos, tables and chairs. The prominent display of crocheted doilies and elaborate embroideries evidenced a taste for handwork that was promoted by women's magazines and manuals as well as by the values of the English Arts and Crafts movement. Drapery design was exceedingly complex, often utilizing embroidered or lace undercurtains and elaborate fringes, tassels and tiebacks. Plush, sateen, brocattelle, twilled wool, velvets and silks were among the popular fabrics.

During this period the design and use of furnishing fabrics reflected several new influences. From England came the distinctive flat patterned fabrics and wallpapers designed by William Morris' Arts and Crafts firm, as well as an attention to materials and fine craftsmanship. At the same time, stimulated by the United States centennial, there was a revival of American colonial and Federal period motifs, including early reproductions of 18th-century fabrics. For this reason some of the reproductions of 18th-century fabrics that are available today, especially those of French copperplate prints, are as appropriate for late 19th-century interiors as they are for 18th-century ones. A third

influence on interior decoration and fabric design that should be noted, although currently it is not represented among reproduction fabrics, was the interest in exotic Japanese and Turkish motifs.

(Copyright © 1977 by the Preservation Press, National Trust for Historic Preservation in the United States. Reprinted by permission.)



La Pagode Toile, reproduction by Brunshwig & Fils of a French copperplate print on cotton, c. 1786.

## Book About Fabric

"FABRICS FOR HISTORIC BUILDINGS" is an indispensable guide and catalog reference to reproduction fabrics appropriate for use in either historic buildings or old houses.

AUTHOR JANE C. NYLANDER, curator of textiles and ceramics at Old Sturbridge Village, Mass., has written an excellent general introduction to aid persons with limited fabric experience in selecting and ordering fabric. Discussed in this section are historical and practical considerations, and basic pointers in ordering custom reproduction work.

THE MAJOR FEATURE of the book is a catalog listing 225 commercially available reproductions of fabrics used in the United States between the 18th century and 1900. This information includes: Manufacturer's catalog name for fabric, place, date and method of manufacture of original, content and width-length of one pattern repeat, organization or museum for which the fabric was reproduced, manufacturer's name for the document color.

ALSO IN THIS BOOK is a list of manufacturers and their addresses, a glossary of fabric terms and a bibliography.

"FABRICS FOR HISTORIC BUILDINGS" is a softbound book, 64 pages, with black and white photos. To order, send \$5.00 to: Preservation Bookshop, National Trust for Historic Preservation, 740 Jackson Place, N.W., Washington, D.C. 20006.

# Glossary Of Historic Fabric Terms

**BAIZE.** Woven woolen cloth having a long nap. Frequently used to cover desk and card table surfaces, either glued down or as a loose cover. Green appears to have been the most common color.

**BATISTE.** Fine light cotton or linen, usually cotton; from the French word for cambric.

**BOURETTE.** Silk fabric with a dull finish characterized by random black specks that are actually portions of the silk cocoon.

**BROCADE.** A figured fabric in which the design is woven in wefts that float on the fabric back or are cut away. These threads appear on the surface only in areas required by the design.

**BROCATELLE.** A special form of lampas with a pattern in one weave on a contrasting ground. Often heavy silk or linen is used for the ground wefts, which do not appear on the surface of the fabric.

**CALAMANCO.** A glazed worsted fabric, either plain or woven with a figured design in colors resembling silk brocades.

**CALICO.** Cotton cloth with patterns printed in one or more colors. In the 18th and early 19th centuries referred to printed cloth imported from India; now usually cotton prints with small stylized patterns.

**CAMBRIC.** Fine bleached linen.

**CAMLET.** Unglazed worsted fabric of plain weave. Descriptive of a group of 18th century materials including harrateen, moreen and china (cheyney).

**CHINTZ.** Glazed cotton cloth, in the 18th century always printed. First manufactured in India, but then imitated elsewhere. Printed designs usually have at least five colors and are frequently large-scale floral patterns.

**CRETONNE.** A stout unglazed cotton cloth printed on one or both sides, late 19th century in origin. It was used for window curtains and chair covers. At the present time it is unavailable in the U.S.

**DAMASK.** A reversible woven design of contrasting faces. Can be wool, silk or linen.

**DIMITY.** Cotton cloth with woven ribs forming a pattern of either stripes or checks.

**DOCUMENTARY COLORWAY.** A modern manufacturers' term used to indicate that the colors of the reproduction fabric are those of the original document. A colorway is a particular printed combination of colors.

**DOUBLE WOVEN.** Two ply, or made with two layers that are interwoven at regular intervals.

**DROP REPEAT.** A design that matches motifs in an alternating, zig-zag pattern when joined lengthwise; it requires additional yardage.

**FAILLE.** A ribbed fabric formed with heavier weft than warp yarns.

**FURNITURE.** A term commonly used in the 18th century to denote the full equipment of something. A "bed and furniture" meant the mattress, bolster, pillows, sheets, pillowcases and hangings; a "tea table and furniture" referred to a tea table with its accompanying objects for the service of tea. In the case of "window curtain and furniture," furniture referred to the rods, hooks, etc., as well as the cloth.

**FURNITURE CHECK.** A kind of checked linen or cotton used for slipcovers, window curtains and bed hangings, 18th century to the present.

**GAUFRAGE.** An embossing technique in which a heated metal cylinder having a raised design on it is pressed against the pile of plain fabric, such as velvet, thereby transferring the pattern.

**GLAZED.** Having a smooth and lustrous surface coating on the exposed side only.

**HARRATEEN.** In 18th century England and colonial America, a wool moire.

**HOLLAND.** An 18th and early 19th century term for closely woven linens, first manufactured in Holland but later throughout the British Isles.

**LAMPAS.** A figured fabric using additional wefts and warps to form a design in one texture on the ground of another. These additional fibers are woven into the back of the fabric, but it is not reversible.

**MARSEILLES.** A heavy cotton fabric with a pattern woven in the goods. Usually white, it was primarily used for bed coverings. Marseilles quilts were used from the late 18th century to the early 20th.

**MATELASSE.** A double-woven cloth that simulated quilting by interlocking in some areas to produce a puckered effect.

**MOIRE.** Fabric, often taffeta, having a surface that appears wavy or watery.

**MOREEN.** A stout woolen or cotton-wool blend, often embossed with a figured design. Commonly used for upholstery.

**MUSLIN.** A fine cotton cloth with a downy nap on its surface. Generally plain but sometimes decorated with a downy nap on its surface. Generally plain but sometimes decorated with openwork or embroidery. The finer grades were often called *mull*.

**OSNABURG.** A kind of coarse linen originally made in Osnabruck, Germany, but later imitated in England and elsewhere. Sometimes spelled "Ozenbriggs."

**PALAMPORE.** A cotton bed covering from India, usually printed or painted with beautiful designs.

**PLUSH.** A fabric with an even pile, shorter and less dense than that of velvet. Used for upholstery in the mid to late 19th century.

**REPEAT.** One complete pattern motif.

**RESIST DYE.** A method of indigo printing in the 18th century in which a resist paste inhibited the dye.

**RUSSELL.** Ribbed or corded fabric, usually with a cotton warp and wool weft.

**SATIN.** A shiny fabric created by a special weave leaving floats of numerous warp yarns on the surface. Usually silk, also wool and linen.

**SATEEN.** A smooth satin weave cloth usually in cotton. Used for window hangings, bed covers and occasionally as a ground for embroidery in the 19th and 20th centuries.

**SELVEDGE.** The lengthwise edges of a piece of cloth, often of heavier threads and sometimes a different weave intended to prevent raveling.

**SLUBS.** Lumps on thread, formed by careless spinning. Deliberate use of slubs to give an antique effect to finished cloth is inappropriate for restoration purposes.

**STUFF.** Commonly a thin woolen cloth.

**TAFFETA.** A closely woven, firm fabric of even weight and tension, known by its glossy surface. Usually silk but can be linen.

**TAMBOUR.** Embroidery worked on fine cloth with a small hook forming a chain stitch on the upper surface of the cloth.

**TOBACCO CLOTH.** Unbleached white cotton cloth used for protecting certain tobacco plants from direct sunlight, thus producing "Shadegrown Tobacco." Resembles the texture and weight of pure cotton muslin.

**TOILE.** From *toile imprimee*, meaning printed cotton. Now generally refers to copperplate-printed fabrics, either cotton or linen, more correctly those of French origin.

**VELVET.** A pile fabric created by the use of an extra warp over rods or wires in loops. It can be plain (left as woven) or the loops can be cut. If the pattern is created by alternating areas of cut and uncut loops, the fabric is called *cisele velvet*. If the pattern is woven leaving some areas without pile, it is called *voided velvet*. Usually wool, silk or cotton.

**WARP.** The threads that are stretched lengthwise on the loom, usually spun more tightly than the weft.

**WEFT.** The threads that are interwoven with the warp, thereby running crosswise in the goods, from selvedge to selvedge.

**WORSTED.** Fabric made of long staple wool that has been combed to make the fibers lie parallel to each other when spun.

# Products For The Old House



## Period Furniture

THE CROWN OF FAIRHOPE Company used to be known mainly for their clock kits. But they are now making late Victorian and turn-of-the-century furniture reproductions (along with Early American) that should be quite popular.

ONE OF THE most useful reproductions is an oak sculptured back chair with a cane seat. Probably a kitchen chair originally, it is appropriate for kitchen, dining room or parlor. Like most pieces, it is available finished or unfinished.

MANY REPRODUCTIONS also come in kit form at a considerable saving. There are hall trees, handsome collector's coffee tables (with glass case tops), a pie safe with perforated tin

panels and an oval mirror with oak frame. These come in either oak, mahogany or pine.

THERE ARE ALSO a few tables in black walnut, described as Early American in the catalog, that look very much like East-lake furniture.

AN ILLUSTRATED CATALOG is \$1.00. Write to: Crown of Fairhope, Dept. OHJ, P. O. Drawer G, 759 Nichols Ave., Fairhope, Alabama 36532.

## Woodworking Tool Catalog

ANYONE WHO IS a woodworking enthusiast should have the Woodcraft catalog. They have an extensive array of the finest quality tools that you won't find at the neighborhood hardware store. There are wood moulding planes, every sort of marking gauge, marquetry and veneering tools, and an incredible variety of chisels.

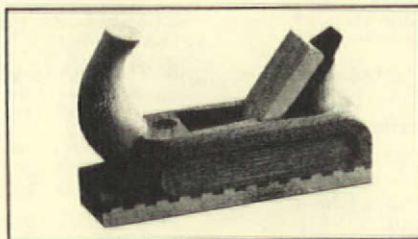

GERMAN GENT'S PLANE

ACCESSORIES include glue pots, glues, brushes, dowels and pegs. The catalog is also an excellent source for cabinet-making books.

ALTHOUGH Woodcraft usually asks 50¢ for their catalog, they will send it free to Old-House Journal readers. Write to: Woodcraft Supply Corp., Dept. OHJ, 313 Montvale Avenue, Woburn, MA 01801.

## A Polyurethane Bullseye

FYPON, makers of high density polyurethane molded millwork, has a new brochure that features several new products.

THE BULLSEYE moulding (pictured at right) is motif that was widely used in many styles of old house. Replacements are often needed. Fypon has now added bullseye moulding to its line. It comes in 7 ft. 8 in. lengths.

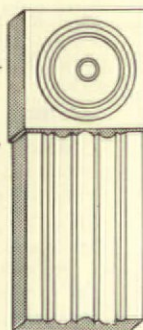

THE BROCHURE also features a mantel roof, dormer head and a rake moulding. Free from: Fypon, Inc., Dept. OHJ, 108 Hill Street, Stewartstown, Pennsylvania 17363.

### Ring Binders

**Keep Your Journals  
Neat And Organized  
For Handy Reference**

Binders have tough vinyl covers stamped in gold on front cover and spine. The large ring size (1½ in.) easily holds 24 issues and opens flat for easy reading and reference.

Binders are shipped via Parcel Post. Please allow 2-4 weeks for delivery. To order, send \$4.75 to: The Old-House Journal—Reprint Dept., 199 Berkeley Place, Brooklyn, N.Y. 11217.

### New!

### The Old-House Journal 1978 Catalog

● Buyers' Guide Directory to 5,873 hard-to-find items and services for the old house;

● 525 Companies listed;

● 219 of these sources are new—did not appear in the 1977 Buyers' Guide.

Single copies: \$7.00  
(\$4.00 to subscribers)

Order from:

The Old-House Journal

199 BERKELEY PL. • BKLYN, N.Y. 11217

### Subscriptions: The Old-House Journal

Enclosed is my \$12 for a one-year subscription to The Old-House Journal.

Subscription is: Gift  Personal

Name \_\_\_\_\_

Address \_\_\_\_\_

City \_\_\_\_\_

State \_\_\_\_\_ Zip \_\_\_\_\_

Donor's Name \_\_\_\_\_

Mail to: The Old-House Journal, Dept. 7,  
199 Berkeley Place, Brooklyn, N. Y. 11217



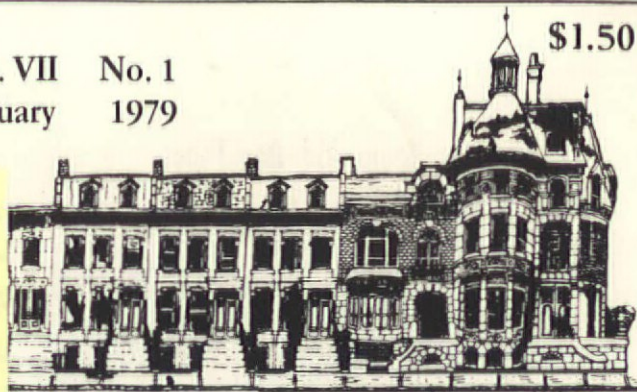

Techniques For The Antique House

OHT  
1979-01



## In This Issue

A Farmhouse In Illinois.....	3
Cleaning Marble Mantels.....	10
The Art Of Graining—II.....	5
Fireplace Safety.....	9
A Chimney Liner.....	12

## Coming Next Month

RESTORING DAMAGED PLASTER

By Rev. Thomas G. Souders, Philadelphia, Pa.

**W**HEN WE FIRST MOVED INTO THIS house in 1969, we realized it was not an ordinary place. One of the first clues came when we asked if an electrical outlet could be put on a certain wall. The answer was an emphatic "No! The last time we tried that we found a 22 in. stone wall to go through." It slowly dawned upon us that this place with its pegged rafters, rippled glass, deep windows, and hand dug wells is an old-timer.

**WE WERE SO HAPPY** to find the enormous fireplace in a central room. The first occasion to use it came when the Youth Fellowship was having a picnic and it was rained out. We brought everything indoors and set up a fire in the fireplace. Being a volunteer fireman for some years, I thought it wise to check the upstairs and the chimney since this was the first use of the fireplace.

**EVERYTHING** looked okay until I lifted the little lid which gives access to the tiny cockloft running the length of the house. Sure enough, it was filled with smoke! When I stuck my head up into the area and checked the chimney, I could see holes in the mortar and a check of these showed

that they extended completely through the chimney wall. Not wanting to damage the fireplace tiles and bricks with water, I put the fire out with a foam extinguisher.

**F**OR SEVERAL YEARS we tried to get someone to put a flue liner in the chimney or in some way make the fireplace functional. It appeared hopeless. The chimney is constructed of fieldstone (in this area mica schist) and only at the top five or six ft. does it narrow down to a rectangular, brick chimney. Upon looking up through the damper, I discovered what I had seen in old, untouched farmhouses: the interior of a walk-in, fieldstone fireplace complete with meat hooks and the soot of generations.

**THIS MEANS THAT** our enormous fireplace was built inside an even larger fireplace! Climbing up on top of the third storey section of the house and peering down confirmed the interior observations--the chimney widened and curved on the way down, with the fireplace set about three ft. in from the chimney. Also, in the cellar directly underneath the original section of the fireplace, is a massive stone arch



(Cont'd. on page 8)

## Leaks From Old Gas Pipes

To The Editor:

THE ARTICLE ON reviving old lighting systems (OHJ, Nov. 1978) reminded me of something that occurred in our home. A few years ago, I thought I smelled gas in our bedroom. This made no sense to me, so I dismissed the thought as we went out for the evening. Returning later that evening, I still smelled it—stronger than before. My wife confirmed my observation.

STILL FEELING LIKE a fool, I called the gas company. They sent a workman over who confirmed that gas was indeed coming into the bedroom. It was coming from the gas pipes in the wall where the old wall sconces had been. The pipes had been capped—but they were still connected to the main gas supply used for the kitchen and the water heater. Some corrosion had taken place in the wall pipes...and now gas was leaking into the bedroom.

IN ORDER TO be able to sleep that night, we had to shut off the main gas valve to the house. Next day, we had our plumber disconnect all the old gas pipes.

I THINK this is a hazard not often recognized in old houses. Fortunately, it's one that is easy to remedy.

Adrien L. Coblentz, M.D.  
Montclair, N.J.

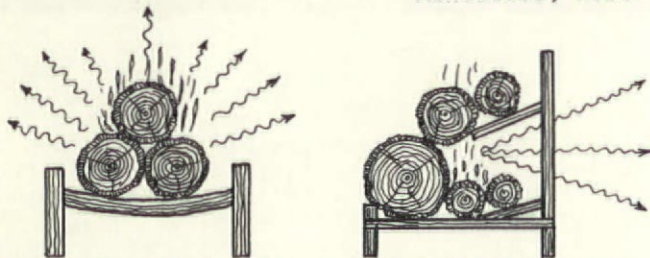

CONVENTIONAL GRATE—Heat radiates in all directions

MODIFIED GRATE—Heat radiates into room

### A High-Heat Fire

To The Editor:

IN THE ARTICLE "How To Build A High-Heat Fire," (OHJ, Jan. 1978) a procedure is described in which the fire is built on a bed of ashes. I use a variation of that technique, which I believe is more effective. The fire is based on the use of a grate called "The Texas Fireframe."

WITH THIS GRATE, a large rear reflecting log is used, as with the system described in the previous Journal article. However, the Texas Fireframe also adds an additional large log over the fire to reflect still more heat into the room.

A FRIEND AND I who use this system have allowed the ashes to build up under the grate, which keeps the fire from moving under the back log—preventing the fire from burning too

## THE OLD-HOUSE JOURNAL®

Published Monthly For People Who Love Old Houses

Editor .....	R.A. Clem Labine
Decorative Arts Editor .....	Carolyn Flaherty
Circulation Director .....	Paul T. McLoughlin
Circulation Assistants .....	Joan O'Reilly
	James Graham
	Shirley Zucker
	Michael Carew
Midwest Editor .....	Tom H. Gerhardt
Contributing Editors .....	Claire Wood Labine
	R.A. Labine, Sr.
	H. Weber Wilson
	Barbara Schiller

Published by The Old-House Journal Corporation, 199 Berkeley Pl., Brooklyn, N.Y. 11217. Tel. (212) 636-4514. Subscriptions \$12/yr. in U.S. and Canada; \$20/yr. elsewhere. Printed at Royal Offset Co., 34 W. 15th St., NYC 10011. Contents of the Old-House Journal® are fully protected by copyright and must not be reproduced in any manner whatsoever without specific permission in writing from The Editor.

vigorously. The amount of heat reflected into the room seems large; a small fire soon has our living room quite warm.

ANOTHER TRICK a friend uses to increase the amount of radiant heat is to build a light metal frame for the back of the fireplace and cover it with heavy aluminum foil. A covering of foil will generally last one heating season. The foil can also be extended to the sides of the firebox. The appearance is not very "old house," as you can visualize, but while the fire is burning the reflected light patterns into the room are fun to watch.

MORE INFORMATION on the grate can be obtained from Texas Fireframe Co., P.O. Box 3435, Austin, Texas 78764.

Paul B. Hinds  
Rochester, N.Y.

### Dangers Of Dipping

To The Editor:

MORE AND MORE owners of old houses are having shutters and other exterior woodwork stripped of paint by having them dipped commercially. But in many cases, wood that has been treated in this fashion will not accept new paint—even though it has first been treated with wood preservative.

IT APPEARS THAT the chemicals keep leaching through to the surface. Any new paint that is applied peels off within six months.

DOES ANYONE KNOW of research that has been done on the use of dip stripping for exterior wood? And is there any remedy for wood that has been so treated that is shedding paint?

Sandra Bergmann  
Richard Bergmann Architects  
New Canaan, Conn.

# A Small Farmhouse In Illinois

By Barbara Schiller

**W**HILE PASSING THROUGH NORTHWESTERN Illinois on August 3, 1974, Norma Vander Meer saw a small advertisement in a realtor's brochure:

Stone house...over 100 years old and built with square nails. No water or electricity but solid and repairable.

Norma drove over to see the house. There was a frame addition built around 1900 and over half an acre of land with a creek running through it. "My heart did a double beat, and my head said you can't do it. My heart won out."

ON JUNE 29, 1976, Norma moved into a charming farmhouse with all the modern conveniences. The almost two years between seeing the advertisement and moving day were, Norma says, the best years of her life. She had never worked so hard or loved it so much.

EVERY FRIDAY NIGHT for 14 months she drove the 102 miles from the Chicago suburb of Elmhurst out to Rock City, Illinois. She worked on the house from sun up to sun down until Sunday night, then drove back to Elmhurst. Norma is able to enjoy the result of her labors from Thursday nights until Monday mornings since she now works a four-day week.



Norma's farmhouse before work began. The stone part was built in 1865 and the frame portion added about 1900.



**H**ER SCHEDULE would have been grueling for anyone. For Norma it was particularly trying since most of the skills necessary for renovating the house had to be learned by doing. Her only previous experience had been watching her parents when they remodeled their own house, and helping them with some of the work.

PLUMBING, ELECTRICAL WORK, well digging and foundation work were too important to be done by amateurs. But Norma did most of the real gut work and all the finishing work with the help of her family and friends.

THE COZY (1200 sq. ft.) house consists of a stone part built in 1865 with walls 18 in. thick. The frame portion added on about 1900 has the decorative bevelled glass and wood trim typical of its period. Every bit of woodwork was refinished. First it was numbered, then removed, finished and re-installed.

**N**ORMA MADE SOME STRUCTURAL CHANGES to bring the house up to modern standards. The upstairs bedroom in the old part lacked storage space, so she built a wall of closets. There were two upstairs bedrooms in the 1900 frame part. One of them became a bathroom, the other a walk-in closet.

ALL THE LATH AND PLASTER was stripped. It was the old-fashioned kind...thick and strong. Norma insulated the house and installed a vapor barrier.

POWDER POST BEETLES had feasted on the floor joists and support beams for the first floor, so these had to be replaced.

NORMA'S BROTHER is in the heating and air conditioning business and he designed the forced air furnace heating system. On a 90 degree day they were up in the attic installing the ducts.

IT WAS JUST AS HOT when Norma did the work she really hated--the messy, boring job of installing, taping and finishing too many square feet of drywall.

NORMA RECALLS what a delightful contrast it was working on the wood trim outside in beautiful spring weather. All the wood was of a



The renovated pantry with the once water-stained and sagging pantry cabinets restored and refinished. Around the window note the thickness of the walls in the stone part of the house.

particularly hard pine that responded beautifully to a scrubbing with trisodium phosphate and a hosing down. She refinished it with Amity stain and varnish, products she could find only in antique stores.



Norma did much of the preliminary work before professionals came on the job. Here she is drilling holes for the power lines through 18-20 in. of the fieldstone. It was a three hour job.

**B**UT BEFORE THE FUN of woodfinishing, there were more basic jobs. Every window in the house had to be puttied. Instead of replacing the old ropes and weights, tracks were installed.

NORMA STAINED the exterior clapboards brown, the wood trim was painted white. The hardwood floors in the living room and dining room were sanded and refinished. Norma and her friends built the cabinet bases for kitchen and bath, but professional labor was used for the countertops.

NORMA ALSO SOUGHT PROFESSIONAL HELP for an unexpected and very expensive job. There were 32 feet of live honeycomb and two large swarms of bees on the walls...honey dripped for days!

ASIDE FROM THE FRUSTRATING DELAYS caused by bad weather, there was one other problem that Norma had to take care of. The stairwell going to the second floor is only wide enough to allow someone carrying hand tools to use it. She had to cut a slot in the living room ceiling and the bedroom floor above it to pass up lumber, sheetrock, the four-piece Corning shower unit and mattresses.

THIS SLOT WAS THE CAUSE of Norma's one near major disaster. She was working alone one weekend taping wallboard ("All friends and family vanished when it was time for that task!") in the bedroom above the living room. An unused 4x8 sheet of drywall was in her way so she started to carry it across the room when much to her surprise she stepped into the slot going down to the living room and crashed through to the living room floor.

LUCKILY, she landed near the telephone and was able to pull it off of the table onto the floor and summon help from a neighbor. A glass of wine and a half-hour later, Norma was back at work! ■ ■



Ceiling in the living room is where the slot was to pass through the lumber, sheetrock, etc. Both the living room and dining room have lovely bevelled and cut glass transom windows.

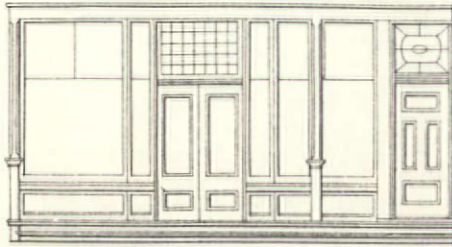

# The Art Of Graining

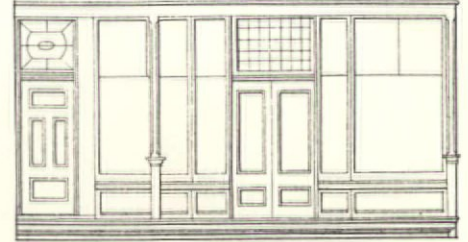

By Nat Weinstein

## Part II

This is the second part of the article by Nat Weinstein on graining. The first part appeared in the December 1978 issue.

NOW WE ARE READY FOR TOPGRAINING. Dip your topgrainer into the glaze. Shake the topgrainer thoroughly to remove excess glaze. (Too much glaze will tend to run and smear, especially when working down on a horizontal surface like a table top.)

NOW TRACE OVER the previously executed heart-grain pattern with the topgrainer. It will superimpose the sharper grain lines usually found in the heart of walnut. (See illus. #10). Now, immediately following topgraining, sweep it lightly with the tips of dry brush, moving from the open end of the grain toward the closed end. (See illus. #12).

ANOTHER OPTIONAL FORM of this sweep blending is to modify the sweep by very lightly dragging the tips of the dry brush in one inch or so jerks in a similar manner to the sliding stipple operation described earlier.

WHEN EXECUTING the latter sweep-blending, a little sidewise wiggle every five or ten in. or so adds a little extra interest. A sharper topgrain will result if the glaze is allowed to set a few minutes before tracing over it with the topgrain.

PRACTICE STIPLING AND TOPGRAINING at longer and shorter intervals after application of the glaze. A variety of subtle patterns are possible through timing control. For sharper topgraining, a little of the glaze may be put in a separate container and darkened. Add a little raw or burnt umber or even lampblack.

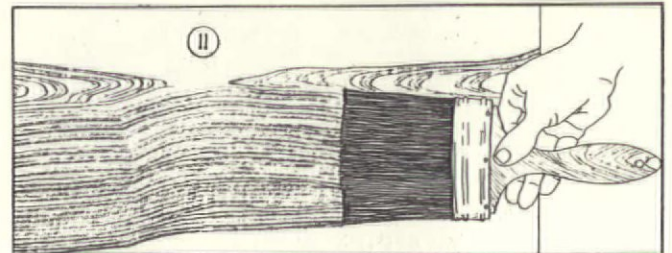

After heart growth has been executed, straight grain is produced by dragging dry brush through the still-wet glaze. Grain is curved to follow outline of the heart growth; grain lines get straighter as you work toward the edge of the board.

## Adjusting The Glaze

AFTER FAMILIARIZING YOURSELF with the action of your glaze, you will most likely need to adjust it: You may want to make the shade deeper or lighter or alter the color.

PERHAPS YOU HAVE already tried to fine-tune your glaze color with little success. Even a competent color mixer of ordinary opaque paints may run into problems with a glaze. Mixing the glaze is more complex since the final effect depends on the interplay between the ground coat and the glaze. In attempting to match your walnut sample you may not have tinted your undercoat exactly right. Whatever the cause, when you reach the point where it seems that you keep passing over your target color--first getting it too dark, then too light or perhaps too rich or too dark--the problem may be solved by adding a small amount (a tablespoonful or so) of white undercoater.

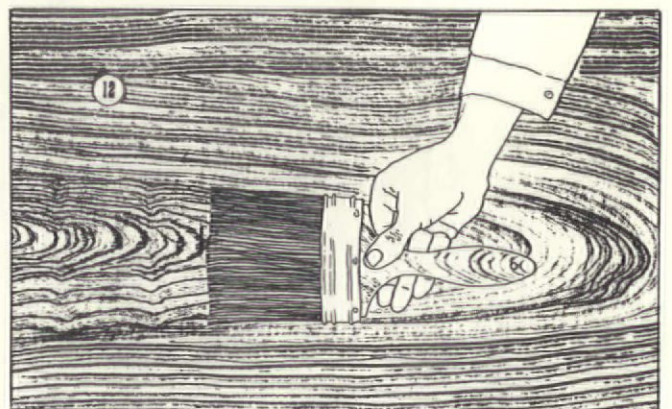
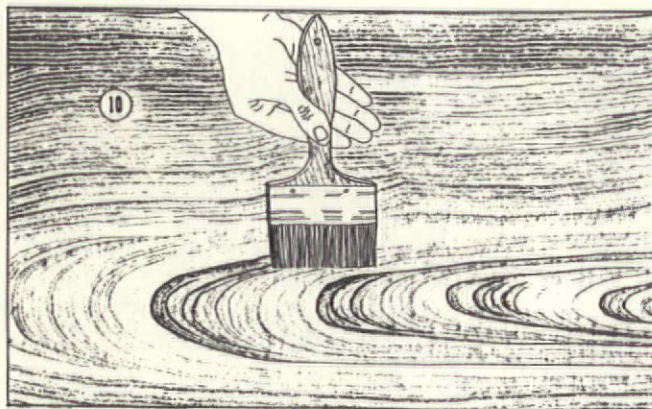

Adding the white pigment makes your glaze greyer and more opaque. This can compensate for a too-intensely colored undercoat.

PERHAPS YOUR GLAZE is setting too quickly. Adding a small amount of oil will slow it down.

ON THE OTHER HAND, when the glaze sets too slowly, thus flowing together and causing the grain effects to blur or even vanish, the addition of a little varnish or thinner or both will counter this unwanted effect. Spreading the glaze further--extending the same amount over a larger surface--also helps to prevent the glaze from flowing back together.

WHEN YOU ARE SATISFIED that the glaze is working right and you have a feel for the techniques and timing, you should wipe off the table top you've been using for practice. Now you are ready to begin graining in earnest.

## Graining Doors

DOORS SHOULD BE LEFT on hinges for easiest handling. Remove obstructions such as door knobs, keyhole plates, etc. When graining panelled doors, do not attempt to coat in the entire door at once. It will set up before you can grain it all. The panels should be coated with glaze and grained first. (If more than one panel, complete them one at a time.) The horizontal boards (rails) are done next and the vertical boards (stiles), last.

THE REASON for this order becomes clearer in the doing. You will see that it is based on the capability of each succeeding application of the glaze "erasing," so to say, the unwanted overglaze left from the immediately preceding operation. You will find it easy to

sharply separate the "boards" neatly from each other at the appropriate places--just as it would be if the door was real natural finish wood. (See illus. #13)

TECHNICALLY, graining the inside of the panels presents a slight difficulty. The glaze sometimes accumulates at the top and bottom where the dry brush must begin the stippling operation. The glaze may appear darker or more opaque at these points because the surrounding molding inhibits an even distribution of the glaze. This problem is usually solved by gently stabbing with the tips of the dry brush up toward the molding. This will pick off some of the piled-up glaze.

THE HEARTGRAINING and topgraining steps present no special problem in doing the panels. After the horizontal pieces--the rails--are grained, an overglaze will be left on the stiles. As previously indicated, this is readily dissolved when the glaze is brushed over the stiles. A sharp straight cut should be made at these junctions. The applicator brush should not contain too much glaze--squeeze the excess out of the brush--otherwise the glaze may bleed over into the finished area. If this should happen do this: Using the tips of the dry brush, gently sweep horizontally from a few inches inside the rail out toward and into the stiles on each end. Then drag and stipple the stile again with the dry brush.

THE DOOR CASING should be done last. Do the pocket (the inside of the casing) first and the facing last. (See illus. #14)

A FINAL NOTE ON GRAINING the panelled door. Watch out for a busy pattern resulting from too many heartgrains. Or a too-symmetrical wallpaper-like pattern. ■ ■

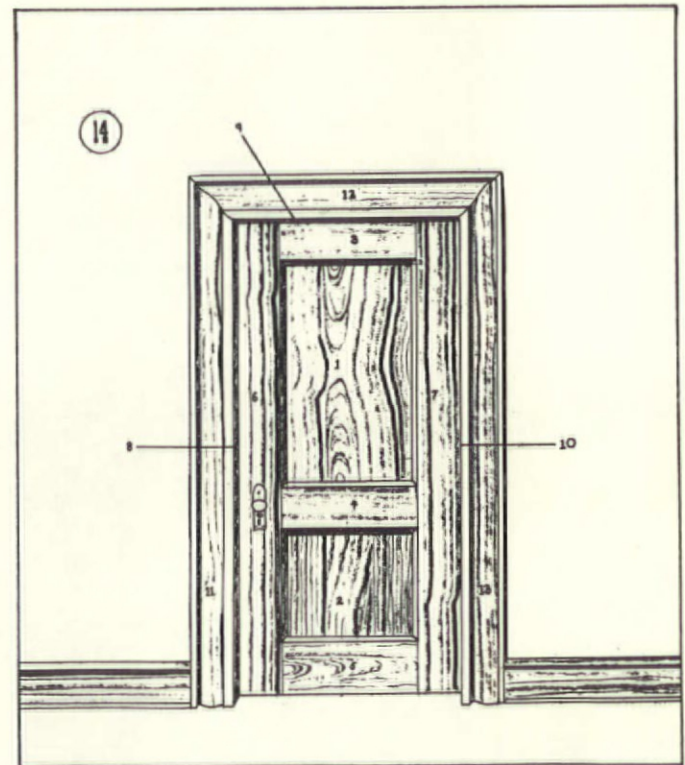
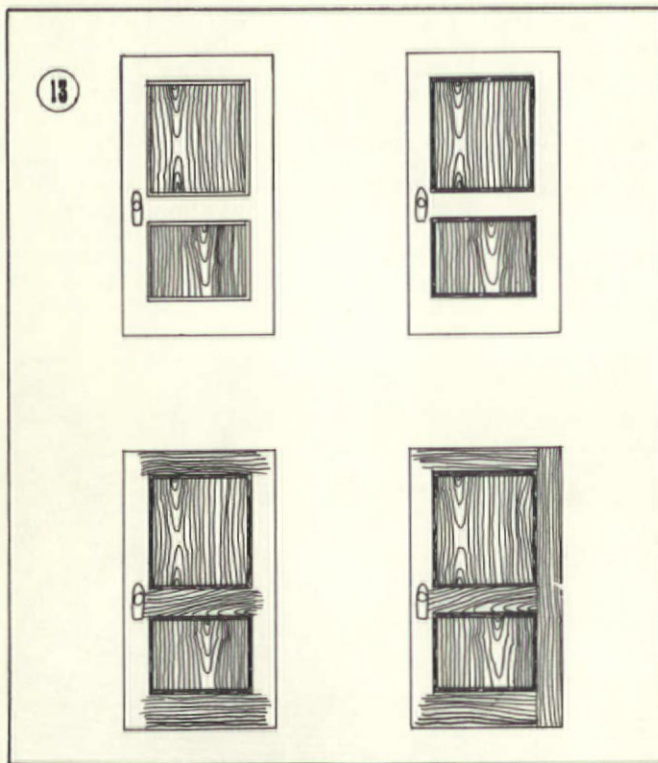

(Stove in Fireplace--Cont'd from pg. 1)

which supports the original fireplace floor, walls and chimney.

ONE DAY we visited a foundry where they were re-casting pot belly stoves from the original patterns. We bought a small one (30 in. high, 14 in. wide, with a 10 in. firebox.) These old stoves operative with a five in. dia. flue pipe that was usually elbowed into a nearby chimney. Sometimes the flue was simply extended through a window pane where it was directed up alongside the house.

## Installing The Stove

WE HOPED that installing the stove would enable us to use the fireplace without changing the existing structure. Our answer, after three winters, has proven workable. We measured the distance between the fireplace floor and the underneath of the slab that rests atop the chimney. From this we figured out how many sections of five in. dia. galvanized flue pipe we would need for the job. At this point, there were several problems.

THERE WAS A CURVE IN THE CHIMNEY; would the installed flue bend enough? How to get it up? How to keep it up! How to get a five-in. pipe through a four-inch damper? I found that the flue pipe could easily be deformed into an elliptical cross-section shape and spring right back. This meant we could probably insert the pipe, section by section, from the fireplace, fastening each piece together as we progressed the pipe up the chimney.

HOWEVER, it seemed quite probable that the longer the pipe got, the greater would be the chance that it would tilt back into the chimney wall and jam, especially because of the forward location of the fireplace and the rough, fieldstone walls. Just in case, I securely fastened a loop to the top (and first in) piece of pipe. Before inserting this piece, I passed a rope down the chimney and secured it to the loop on top of this initial flue-pipe section. I also prepared a clamp with which I planned to secure the flue at the top of the chimney.

WHILE THIS CLAMP is very simple, it is also very important. Using angle iron, I fabricated a shape a little like the tic-tac-toe diagram with little pieces of angle iron bolted on at the right places to keep the thing from moving back and forth and possibly tilting down into the chimney. Then I made a clamp which was simply two hefty pieces of flat strap iron bent to each form a half circle with "ears" bent out and drilled to accept a nut and bolt.

I MADE THESE HALF CIRCLES the same diameter as the flue, but not quite exactly half circles. The reason for this was to be able to obtain a clamping action by drawing the bolts up tight (but not too tight as this would distort the flue pipe). I also arranged for the clamp, while resting on top of the frame, to inter-

lock with this frame and thereby prevent any possibility of things twisting, or otherwise working loose.

OF COURSE, while up on the roof for the first inspections, I exactly measured every part and angle I could think of. This is very necessary due to the uneven methods of construction, and is helpful in any project as it is so nice to have the measurement you want on a piece of paper next to you when you want it. While I was fashioning the frame and clamp, and had the measurements, I also made a two-part cover for the chimney. One had a hole cut in it so I could pass the flue through it and have it located between the frame and the chimney top. The other simply would take care of the other part of the opening of the chimney. It was easier to make this cover in two parts, and they bolt to each other.

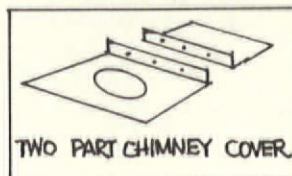

THIS PREVENTS birds and squirrels from getting into the chimney and excess (not needed now) draft from removing air from the room in which the fireplace is located. Please note that in no way did I interfere with the opening of the flue-pipe itself!

IT WAS NOW TIME to put the pipe up the chimney. I went up top and put the rope down. This we fastened to the first piece and then started fastening them together. The flue pipes are arranged to slip together with an overlap of two in. and can be held by friction, however, I decided to secure each one to the other with a steel screw. All went well for about six sections, and then the thing tilted and jammed into the wall. Plan "B."

FROM THIS POINT ON, I would go up top and pull a section-worth up; my wife, who was shoving from below, would prop the whole thing with a pretzel can, and I would come back down to do the drilling and fastening. We repeated this procedure until all sections were up and securely clamped. It was a satisfying sight to see that pipe hang down into the fireplace! The last steps would be to insert a damper, attach the flue to the top of the stove and start a fire.

HOWEVER, as we had such a close clearance and wanted to have the stove as forward in the fireplace as possible, I decided to make a "collector box" for the gases which would have the damper incorporated into it. I brazed together a rectangular box (11 in. deep, 8 in. wide, 2 1/4 in. high) with an elliptical entrance in the lower front and a round exit in the upper back. I made a butterfly valve in the middle. The metal for this box is 1/16 in. iron plate. I brazed it heavily, and tested it to the extent of having such a hot fire that the box got a dull red with no ill effects.

I HAD TROUBLE with the butterfly valve flopping shut when I didn't want it to. This was corrected by fitting a large round washer on one end of the valve's shaft over which hangs a brake. The brake is a length of pipe (for a little weight on a lever arm), which is hung over the washer by means of a narrow piece of

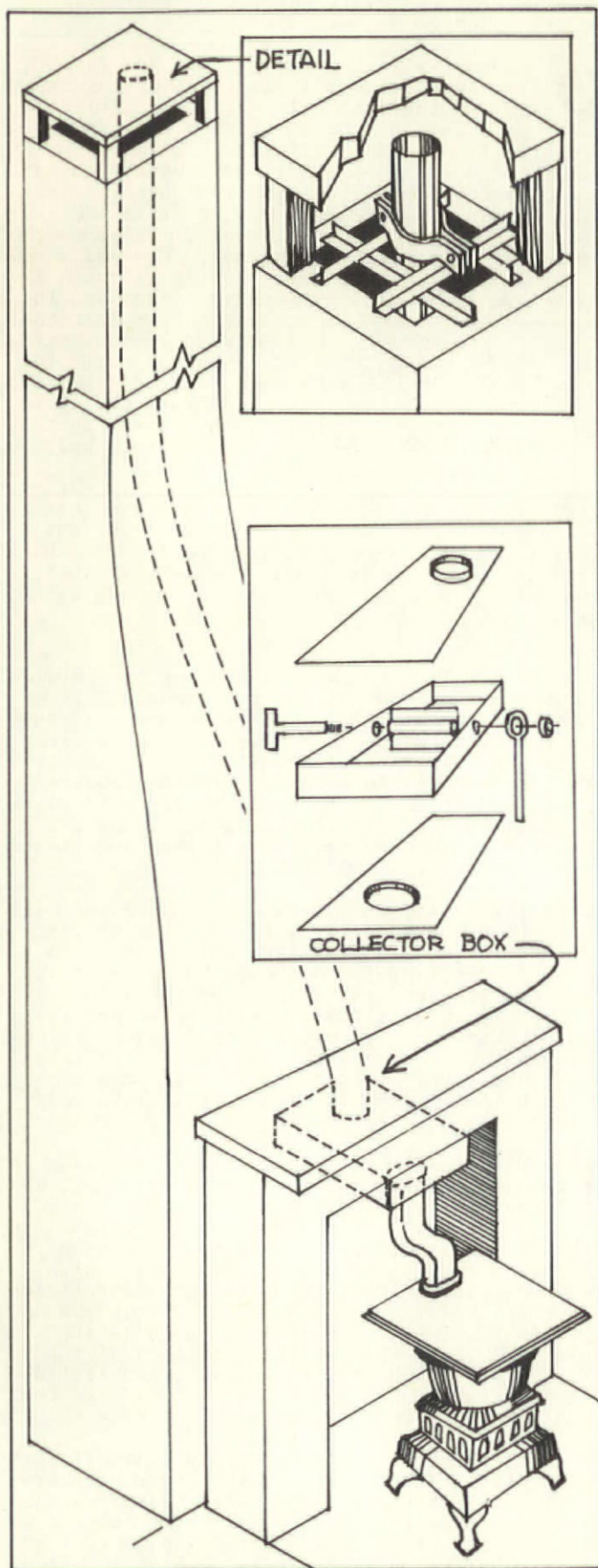

thin flat iron made into a shape just a little larger than the washer.

I CHOSE THIS METHOD over some kind of spring or clamp because it is not affected by heat, expansion, or age. It can't fail. After the first season's use, I began to worry about the possibility of one of the screws breaking off or something going wrong which might cause the flue to come down. To ease these fears, I put a pipe brace from the hearth to the bottom of the collector box. I feel sure the flue will hang in there with no problems, but I still feel better with a back-up brace in case.

### Replacing The Stove Top

AS NOTED ABOVE, we bought a stove of such size as would fit into the fireplace and would not be too close to the mantel. As often happens, the foundry began re-casting more old patterns after we had bought one. One of the patterns redone was a flat top for the firebox instead of the pot belly top. The old-timers were thrifty and made as many parts interchangeable as possible--a far cry from planned obsolescence!

AFTER USING THE POT BELLY set-up for one winter, we found the flat laundry stove top was being made. We bought one and installed it in place of the first top. This set-up we have used for two more winters. It has been a splendid source of heat.

### Fire: Friend Or Foe

IT IS IMPORTANT to realize that if you install this or a similar set-up, you are bringing fire inside your house. It can very quickly and disastrously switch from friend to foe. Any installation should be at least two feet from combustibles. Our installation was perfect in this regard, as it is bounded by the fireplace brick. Another danger is the hot coal which will eventually pop out of the stove when you are tending it. If you have a mitt or a coal shovel and poker handy, it is a short-lived problem.

IF YOU HAVE TO GO and get something, when you come back you may have at the least a nice hole in the floor, and at the most, a nice fire where you don't want one! You should have either a bucket of water or a fire extinguisher, or a preconnected garden hose near. Another problem with this auxiliary source of heat is that it is uneven. To be sure, this room in which I am cozily typing is comfortable. As this room has the thermostat, the rest of the house is chillier the farther from this central room.

HOWEVER, we do not really need a lot of heat in the bedrooms (our grandparents had none.) As for my study on the sunporch, it is possible to do long projects in this room when it gets very cold, just as I am doing now.

THE SAVINGS OF OIL for us have been very great. We also noticed that the other chim-





This is a side view of the Rev. Souders' house in Philadelphia, Pa. A sunporch, and various other additions have been made to the house over the years.



In this close-up photo of the fireplace and stove, you can see the piece of aluminum wedged in place behind the stove to direct warm air into the room.

ney in the house which has been pressed into service for the oil burner used to get so hot that the wall was too hot to touch. The wallpaper cracked one cold night when the oil burner was puffing away continuously. I am happy to report that last year, the coldest I remember, the oil burner did not work as hard as previous, much milder, years. That chimney has been only warm (which is expected) and a whole lot safer.

### Safety Notes

**W**E DID HAVE ONE SCARY EXPERIENCE about which I would warn you. As my design did not provide for a clean-out at the bottom of the flue, the soot which collected on the inside of the pipe through the heating season all fell down during the summer. When I stuffed the stove with paper and wood to light it for the second season, I filled the room with smoke in about ninety seconds.

FORTUNATELY, the fire, having no vent and being contained in a cast iron stove, only produced volumes of smoke, which I was able to remove immediately as the window fan at the top of the stairs was still hooked up and ready to turn on. I did not want to put water on the stove and risk the danger of cracking the iron, but would have done this if the flames had come out into the room. I have since found that it is sufficient to clean out the collector box once a year at the beginning of the heating sea-

son, but for safety's sake, clean it out twice during a season's use.

IT IS ALSO IMPORTANT to make sure that the damper cannot be fully closed so that the heating equipment is properly vented, avoiding the danger of coal gas. Commercial types accomplish this by having a hole about the size of a half-dollar in the center of the butterfly. I accomplished this same result by making the butterfly not quite as wide as the box.

THE TOP OF OUR CHIMNEY has a two-in. thick slab covering it. It serves as a crude spark arrester, prevents downdrafts, and keeps things somewhat dry. I ran the flue pipe up to within 2½ in. of this slab.

**I**T MAY SEEM STRANGE to some to derive satisfaction out of reversing progress, and now having to tend to an old-time heater, when automatic equipment abounds. Our forbears looked to escape the continual drudgery of devices that had to be tended and cared for. But they also had benefits from them which they probably did not know. There is something personal about that little heater and the teapot which whistles atop it all day long, and something comforting about the measure of independence it promises if our modern devices or supplies should fail for a while. And there is something mystical about hearth and home, heat and fire, and the mastery of the same for beneficial purpose. ■■

# Restorer's Notebook

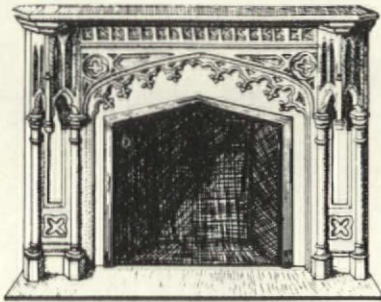

## Cleaning Marble Mantels

**T**HE ONCE WHITE MARBLE MANTELS in the parlors of our late Victorian house showed the results of decades of neglect. One was dirty and yellowish. The other was dirty and greyish. Fortunately, they had not been covered with paint, although one of them was spattered with the results of a sloppy blue paint job.

I TRIED THE METHODS outlined in an article in *The Old-House Journal* in June 1974. The marble did get lighter—but not enough to satisfy our wish that the mantels look as white as they did when the house was built in 1874.

MY IN-LAWS had given us an old pamphlet on cleaning stone using the products of the Vermont Marble Co. in Proctor, Vt. Failing to find a retail source for their products, I called the company and was sent product literature and ordering information.

WHEN I RECEIVED the Vermont Marble Cleaner, Poultrice Powder and Vermarco Detergent, I set about making up batches of poultrice according to the directions. My goal was a poultrice with a plaster-like consistency, but I didn't think there was enough powder—so I went easy on this material and used more of the detergent.

**I** APPLIED MY MIXTURE to the mantels with a putty knife. (Getting the poultrice to stay in place on the slippery vertical surfaces of the mantels took some effort.) Having applied the poultrice to approximately a half-inch thickness, I covered everything in plastic wrap... to keep the poultrice from drying out. The plastic wrap stuck neatly to the surface of the poultrice—and then I covered the entire mantel with a large plastic sheet. During the 48-hour waiting time, it was necessary to re-wet the poultrice a few times with a plastic spray bottle, after carefully lifting up the plastic wrap.

I THEN CAREFULLY removed the poultrice with a putty knife (taking care not to scratch the marble), and washed the marble with water using soft brushes (a toothbrush and an old nail brush) to lift off the dirt. This takes some amount of scrubbing. A firm jet spray from

the plastic spray bottle was particularly successful in getting out the poultrice and dirt from the finely detailed carvings.

THE BEFORE AND AFTER appearance of our mantels is remarkable. But as can be imagined, this is very sloppy work. Do it before the surrounding floor is sanded and finished.

Nancy Kullman  
Cambridge, Mass.

Ed. Note: Vermont Marble Co. is located at 61 Main St., Proctor, Vt. 05765. Tel. (802) 459-3311. They will send a free brochure describing their marble cleaners along with ordering information.

## Removing Paint Residue

**W**HEN USING PAINT REMOVER, there's often a problem of paint residue left down in the pores of the wood. This stuff doesn't seem to come out, no matter how much chemical and steel wool is used. The residue is especially objectionable if the paint is white.

HERE'S A REMEDY that's worked every time I've tried it. Get the wood as clean as possible using paint remover and steel wool. Then coat the wood with orange shellac (just as it comes from the can). Let the shellac dry overnight. Then apply more paint remover to lift the shellac. As the shellac is scrubbed off with the steel wool, the paint residue should come out with it.

I DON'T KNOW why the shellac pulls the paint up out of the pores, but it seems to work—at least the three times I've tried it.

Eleanor James  
St. Louis, Mo.

## Repairing Bathtub Grout

**H**ERE'S A SURE-FIRE METHOD for making a near-permanent repair to a messed-up edge of grout or caulk around the top edge of a bathtub:

- (1) Remove all loose grout, old caulk, etc.
- (2) Clean the surface with a cleanser like Comet and rinse. If a mildew problem exists, use Clorox (1 part to 4 parts water). Let the Clorox sit on the mildewed areas for 5-10 min., then rinse.
- (3) Fill the tub with water to maximum height.
- (4) Use a latex or siliconized tub cement or grout. (General Electric makes such a product; the premixed variety is very good.) Stuff the material into existing cracks and corners. Let it dry partially (about 30 min.), then wipe off excess with a damp sponge and buff the tiles dry with a soft cloth.
- (5) Leave the water in the tub for at least 24 hours. If possible, avoid using the tub for at least 4 days.

**F**ILLING THE TUB with water is one of the secrets of this process. If you re-grout with the tub empty, when it is filled with water for the next bath, it will start to pull away from the new grout. A full tub weighs many hundreds of pounds and will substantially deflect the beams supporting it. By grouting with the tub full, you have opened the crack at the top of the tub to the maximum amount.

Douglas White  
Brandamore, Pa.

## Hard-Water Deposits

**I** HAVE RESTORED several old homes and this one problem always seems to crop up: Finding deposits of lime and other minerals in the bathtub from the hard water.

**SOLUTION:** Scrub the tub with vinegar. It works like a charm. You can use vinegar to remove hardwater deposits from other places, too, such as the inside of water kettles.

Frederick A. Mohler III  
Lancaster, Pa.

## Patching Plaster Holes

**WE FOUND A STRONG,** simple method for repairing missing patches of plaster. Use a piece of brown paper to make a pattern of the hole. Then you can cut a piece of sheetrock to the corresponding size.

**WHEN NAILING THE SHEETROCK** in place, you may need thin strips of wood under it to bring it up to the level of the rest of the plaster. On brick, of course, it would be necessary to use masonry nails.

**TAPE THE EDGES** of the patch with dry wall compound and dry wall tape. When dry, another coat of compound over the area will provide the finish coat.

Gail Niedernhofer  
Nokesville, Va.

## A Safe Nail Puller

**WHEN DOING** finish work, it is common knowledge that you should pull bent nails from wood by placing another block of wood in between the hammer and the wood being worked on.

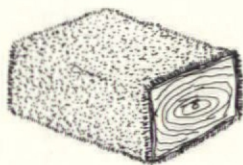

**HOWEVER,** even this method can mar wood with a fine surface unless another precaution is taken. Use a piece of carpet and tack it to the pry block. Better yet, use contact cement to attach the carpet. I keep such a covered pry block in my tool box so it's always handy.

Karl Winneker  
Placerville, Calif.

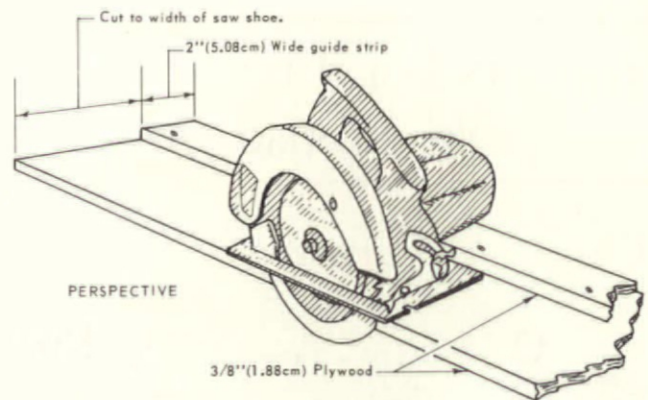

## Saw Guide

**HERE IS A SIMPLE,** inexpensive device for cutting large pieces of plywood in a safe, accurate manner with a portable power saw. Cut two 8-ft. strips of 3/8-in. plywood as accurately as you can on a table saw.

**CUT ONE STRIP** 2 in. wide and attach it securely with glue and nails to the top of the wider piece—making sure both pieces are flush on one side. Place your portable saw on the wide piece, with the left edge of the shoe against the edge of the 2-in. guide strip, and cut the wider bottom piece of plywood to the proper width as shown in the sketch above.

**YOU NOW HAVE** a handy straight edge for making accurate cuts regardless of the angle. Use two "clothes pin" type wood clamps to hold it in place while cutting. It can also be tacked lightly in place for jobs like trimming the edge of a roof.

David R. Milner  
National Park Service  
Umpqua National Forest, Ore.

## Paint Remover Trick

**SOMETIMES,** when removing multiple layers of paint with chemical removers, the volatile components evaporate before the paint layers have softened all the way through. If left on too long, the paint remover merely dries out, leaving a skin that is difficult to scrape off.

**SOLUTION:** Place wax paper over the surface after the remover has been applied. It will continue working for as long as necessary.

John P. Duffy  
Kensington, Md.

## Got Any Tips?

Do you have any hints or short cuts that might help other old-house owners? We'll pay \$15 for any short how-to items that are used in this "Restorer's Notebook" column. Send your hints to: Notebook Editor, The Old-House Journal, 199 Berkeley Pl., Brooklyn, N.Y. 11217.

# Products For The Old House

## Chimney Liner

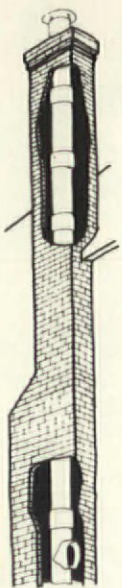

**O**LD HOUSES often have unlined chimneys. Creosote attaches itself to brick and mortar and can cause chimney fires. A chimney liner protects the house in the event of fire. An easy-to-install chimney liner is sold by the Bow & Arrow Stove Co. The Vitroliner is made of heavy gauge metal, coated on both sides with a vitreous enamel. It comes in sections (the largest is 3 ft. long) so it can be easily shipped. Most homeowners will be able to install it themselves or a chimney contractor can be called in. For a free brochure and price list, write to: Bow & Arrow Stove Co., Dept. OHJ, 14 Arrow St., Cambridge, MA 02138. Tel. (617) 492-1411.

and price list, write to: Bow & Arrow Stove Co., Dept. OHJ, 14 Arrow St., Cambridge, MA 02138. Tel. (617) 492-1411.

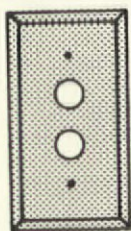

## Brass Switch Plates

**A**RARE ITEM these days is the old-fashioned wall switch plate with round holes for push buttons. Solid brass single (2 holes) and double (4 holes) are available from the Renovator's Supply. They are \$3.70 and \$4.50, with quantity prices also available. Add 8% shipping and handling. For \$1.25 you can also get their 34-pg. catalog that is crammed with hard-to-find hardware and supplies for restorers. Write: The Renovator's Supply, 71 Northfield Rd., Millers Falls, Mass. 01349. Tel. (413) 659-3542.

## Helpful Publications

### Money For Preservation

**I**N A NUMBER of localities throughout the country, the revolving fund has proven to be an effective and indispensable tool in the preservation of historically and architecturally significant properties. The impact of the revolving fund is primarily psychological and catalytic. Rehabilitation and construction in deteriorating areas often encourages further investment and rehabilitation.

THE HERITAGE CONSERVATION and Recreation Service, a branch of the U.S. Government, has published an informative brochure that discusses the Historic Preservation Fund Grants as a potential source for local and statewide revolving funds.

FOR A COPY, write to: Heritage Conservation & Recreation Service, Pension Bldg., 440 G Street, N.W., Washington, D.C. 20243. Ask for Supplement 11593—Vol. 3 No. 3 (October 1978).

### Slide & Tape Presentations

**A**RE YOU PLANNING a restoration workshop, conference, etc., and can't line up an expert speaker who is an authority in the field? The American Association for State and Local History may have a solution for your problem.

THEY HAVE PUT TOGETHER seven kits, each of which includes 78-80 slides—along with an illustrated script and cassette tape. Subjects that are particularly relevant to the homeowner audience are: Victorian House Colors--Exterior; Wallpaper And The Historic House; Reading A Building--Colonial, and Overall Planning For House Restoration. Other titles include: Curatorial Care--Environmental and Furniture.

THE KITS are \$22 each. To order, or for a free brochure, write to: Mary Howse, American Association for State and Local History, 1315 Eighth Ave., So., Nashville, TN 37203. Telephone: (615) 242-5583.

### New and Expanded! 1979 Catalog

- Directory of where to buy 7,282 items and services for the old house;
- 662 Companies listed;
- 203 of these sources are new—they didn't appear in the 1978 Catalog.

Single copies: \$7.75;  
\$4.95 to subscribers  
(Includes Postage and  
Handling)

The Old-House Journal  
199 BERKELEY PL. • BKLYN, N.Y. 11217

### Subscriptions: The Old-House Journal

Enclosed is my \$12 for a one-year subscription to The Old-House Journal.

Subscription is: Gift  Personal

Name \_\_\_\_\_

Address \_\_\_\_\_

City \_\_\_\_\_

State \_\_\_\_\_ Zip \_\_\_\_\_

Donor's Name \_\_\_\_\_

Mail to: The Old-House Journal, Dept. 7,  
199 Berkeley Place, Brooklyn, N. Y. 11217