



# The Old-House Journal

Vol. IX No. 12

\$2.00

December 1981

Remuddled Thinking At OHJ?.....	272
Ten Preservation Principles.....	273
Crack Detective Comeback.....	277
Restorer's Notebook.....	282
Ask OHJ.....	288
OHJ 1981 Index.....	289

NEXT.....Early 20th-Century Houses

Restoration and Maintenance Techniques For The Antique House

OLD-HOUSE

# SECURITY

By Margaret Miner

**A** FEW WELL-PLACED KICKS will spring the majority of doors. A talented burglar with a pry bar, or jimmy, can get through a locked iron gate and a locked door in two or three minutes--in daylight, without attracting attention. In these unfortunate occurrences, it is often not the lock itself that's at fault. The weakness is usually with the strike (the part of the lock that receives the bolt), the frame of the gate or door, or the door itself.

CHECK YOUR DOOR to see how vulnerable you are to a pry-bar attack. Try to push open your exterior doors by placing the heel of your foot on the ground near the door and pushing forward with the ball of your foot. If a gap opens between the door and frame, then a pry bar can be inserted and a burglar can get in.

WHEN IT COMES TO SECURITY, it's impossible to beat a good metal door (at least 16 gauge) in a metal frame, or a solid wood door with a metal covering (such as the widely advertised Kalamein door). These doors have absolutely no charm, but their appearance can be improved by applying a wood veneer. This option is expensive, however: A simple oak veneer costs around \$300. You could try having the door grained; just be sure to select a skilled grainer.

A RESPECTABLY TOUGH RUNNER-UP is a solid-core door of strong wood. Be careful: Some so-called solid-core doors are filled with particle board, and will easily give way. But a good solid-wood door can actually be stronger than certain metal doors. Some old steel doors were made with two panels in which the metal is only 1/8-inch thick. These breakaway panels were meant to be used by firefighters. Naturally, burglars can use them too.

A DRAWBACK to most wood doors is that you cannot see who's at the door. The best solution here is a wide-angle viewer. (Of course, people who have gates usually don't have a problem in this regard.) NEVER rely on a chain to keep anyone out: They don't do the job.

## Doors With Glass

**F**OR HOMES WITH glass-panelled doors, sidelights, transoms, and so on, it's often advisable to substitute safety glass or unbreakable plastic for the original glass (assuming it's plain glass). This measure prevents a burglar from breaking the glass and unlocking the door from the inside, while preserving the appearance of the doorway. It also allows natural light to enter.

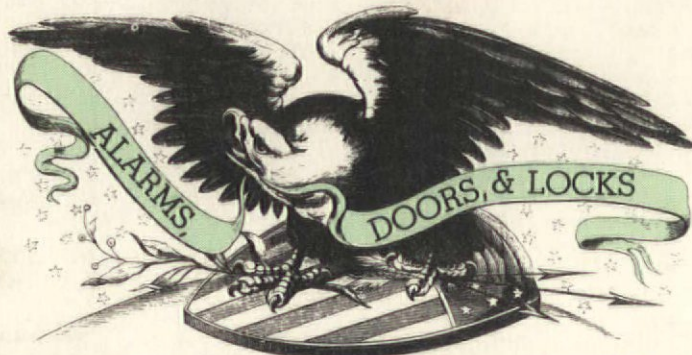

continued on p. 284

# The OHJ: Guilty Of Remuddled Thinking?

... Perspective

The following letter refers to "Twining Vines," which appeared on p. 227 of the October 1981 issue.

To the Remuddling Editor  
Sir/Ms.:

I submit The Old-House Journal as being deserving of the "Remuddling of the Month" designation. An advisory bulletin that claims to present "restoration and maintenance techniques for the antique house" on the cover, yet advocates a destructive practice on the basis that "it would take a generation before there'd be any cause for concern," displays a basic remuddled philosophy. Maybe OHJ should be a little less anxious to ridicule others.

Joseph Lahendro, Architect  
Richmond, Virginia

Dear Mr. Lahendro:

**Y**OUR LETTER didn't make my day. But it lets me share a few thoughts about why we publish The Old-House Journal.

JUST FOR the record: We did not "advocate" any destructive practice. We said brick buildings fare better than wood buildings under direct attachment of vines, and we stated it would be a generation before accelerated damage, if any, would be apparent. In the body of the article, too, we recommended trellissing rather than direct attachment.

AS A PRESERVATION publication, the OHJ is irrefutably as aware as anybody that the current "preservation mind" warns against the use of vines on historic buildings. But have you ever seen documentation of the hazards--real hazards, not merely theoretical ones? Preservation as a discipline is already falling victim to the CYA, follow-the-leader mentality: Some "expert" espouses a dictum, and suddenly you're a bad guy if you venture a different idea.

**W**HAT GOOD ARE WE if we just keep repeating the technical information that's quoted again and again from the same books? Controversy is the only way anyone learns anything new.

DAN MACIEJAK, the author of "Twining Vines," has more than 15 years' practical experience. He's Senior Landscape Architect with the New York State Office of Parks, Recreation, and Historic Preservation. Maciejak has discussed the problems of vines on buildings with other experts--from chemists to Park Service maintenance men--on many occasions. He also lives in an old house and knows The Journal intimately. Sounds pretty credible, doesn't he?

ON THE OTHER HAND, if you have evidence of the destructiveness of vines, even if it's only one example, we'll be happy to print that, too. We're here to help. When I told Dan about your letter, he said, "Just don't write that I'm infallible!" He'd welcome further information as much as we editors would. And that goes for commentary (helpful commentary) on all the articles we print.

**A**S A CURIOUS ASIDE, Maciejak tells us that period photos of Frederick Law Olmsted's house ("Fairsted"), a wood clapboard building, show it draped in vines! Olmsted's cherished sleeping balcony had wooden trellis pilasters built into its bay window. Does this suggest that intelligent judgment plays a role in the use of vines in many circumstances?

THE OHJ STAFF assume our readers have to think for themselves. We edit for people who are faced with real-world problems: Perhaps we should put out a separate publication for those who feel they must parrot the current consensus "line" in their effort to be right all the time.

Regards,

*Patricia Poore*

Managing Editor

## The Old-House Journal®

Editor

Clem Labine

Managing Editor

Patricia Poore

Assistant Editor

Cole Gagne

Editorial Assistants

Joni Monnich

Stephanie Croce

Circulation Supervisor

Joan O'Reilly

Circulation Assistants

Margaret Scaglione

Barbara Bugg

Jean Baldwin

Office Manager

Sally Goodman

Office Assistant

Rafael Madera

Sales Promotion

Joel Alpert

Circulation Director

Paul T. McLoughlin

Technical Consultant

Alan D. Keiser

Architectural Consultant

Jonathan Poore

Contributing Editors

R. A. Labine, Sr.

John Mark Garrison

Barbara Schiller

Published by The Old-House Journal Corporation, 69A Seventh Avenue, Brooklyn, New York 11217, Telephone (212) 636-4514, Subscriptions \$16 per year in U.S. Not available elsewhere. Published monthly. Contents are fully protected by copyright and must not be reproduced in any manner whatsoever without specific permission in writing from the Editor.

We are happy to accept editorial contributions to The Old-House Journal. Query letters which include an outline of the proposed article are preferred. All manuscripts will be reviewed, and returned if unacceptable. However, we cannot be responsible for non-receipt or loss—please keep copies of all materials sent.

Printed at Photo Comp Press,  
New York City

ISSN: 0094-0178

NO PAID ADVERTISING



## The 10 Basic Principles For Sensitive Rehabilitation

**I**N LAST MONTH's installment, we saw that old-house rehabilitation creates many more difficult choices than either a pure restoration or total preservation. That's because there is an infinite range of possibilities during rehabilitation. The only absolute requirement is that a rehabilitation should leave the building functional. After that, the design and aesthetic choices are totally up to you.

TO FOCUS people on SENSITIVE rehabilitation--in which the design and character of the original building is respected--the Secretary of the Interior has issued a set of Standards. The Rehabilitation Standards cover both commercial buildings and domestic dwellings, so they are of necessity somewhat general. But the Standards provide an excellent starting point for the well-intentioned person seeking directions amid the forest of misleading signposts put up by contractors, suppliers of remodelling materials, and decorating magazines.

THE SECRETARY's Standards are divided into two

parts: 10 basic principles followed by 121 specific dos and don'ts. In this installment, we'll look at the 10 basic principles. Anyone wishing to get the complete Standards should consult the box at the end of this article. You can also get a capsule summary from the January 1977 OHJ.

THE 10 PRINCIPLES are written in "legalese." That's necessary because the Standards are part of the administrative apparatus for the Federal Tax Incentive Program, and thus are used and interpreted by lawyers. The legal language may make the 10 principles seem a bit opaque to some of us. But the ideas embodied in the principles are very sound. Thus it's worthwhile plowing through the legal language to make sure we understand the concepts underlying the official language.

IN WHAT FOLLOWS, the official wording of the 10 principles is reproduced in bold face. The photos and commentary in regular text type are comments and interpretation added by the staff of The OHJ.

**1** Every reasonable effort shall be made to provide a compatible use for a property which requires minimal alteration of the building, structure, or site and its environment, or to use a property for its originally intended purpose.

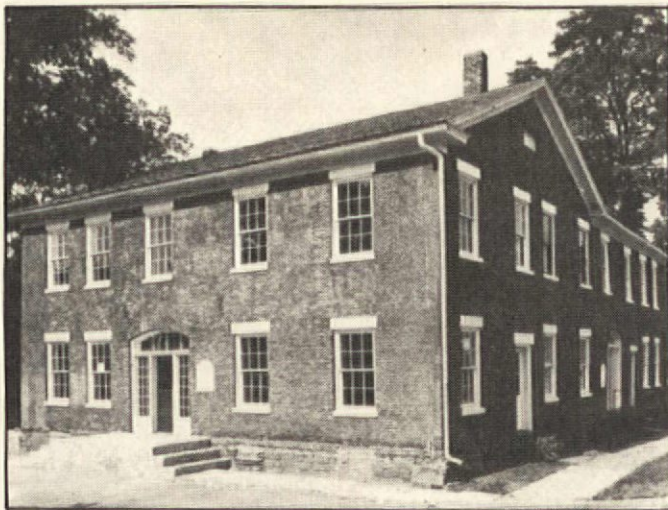

IT'S ALWAYS BEST when an old building can be used for its intended purpose. This building started life in 1835 as an inn. Later, it was converted into a factory, and then into flats.

In 1976 the building changed hands once more--and was converted back into an inn. While extensive reconstruction was required inside, careful restoration of the exterior preserved much of its original look. Thus an important visual anchor has been retained for the community (Marshall, MI).

**2** The distinguishing original qualities or character of a building, structure, or site and its environment shall not be destroyed. The removal or alteration of any historic material or distinctive architectural features should be avoided when possible.

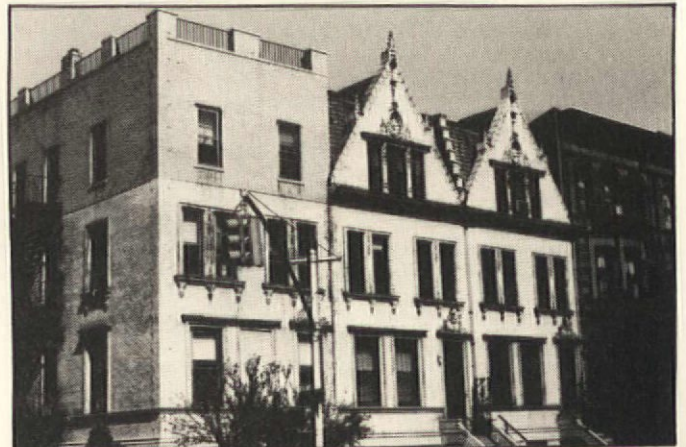

THE THREE TOWNHOUSES on the preceding page were once identical. When the owner of the corner building wanted to add space to the top floor, he did it in a way that destroyed the cornice, gable and distinctive roofing tile. By obliterating the major stylistic features, the owner radically altered the look of the building--and removed some of the beauty and harmony from the streetscape.

**3** All buildings, structures, and sites shall be recognized as products of their own time. Alterations that have no historical basis and which seek to create an earlier appearance shall be discouraged.



WHEN THE ORIGINAL ENTRANCE was removed from this late Victorian brownstone, the owner attempted to "early up" the building by adding a Colonial doorway. While the entrance is of better design and materials than much "phoney coloney," it is nonetheless a discordant element. It's much like a 10-year-old girl dressing in her mother's high heels to affect greater age and sophistication.

**4** Changes which may have taken place in the course of time are evidence of the history and development of a building, structure or site and its environment. These changes may have acquired significance in their own right, and this significance shall be recognized and respected.

THIS RAMBLING FARMHOUSE presents a stern test of Principle #4. Much of the architectural merit is concentrated in the Greek Revival wing on the left. The gabled wing on the right has its own rustic charm. The middle section, how-



ever, cannot be called a triumph of architectural design. Nevertheless, it does have a claim on our sympathy in its role as cultural artifact. Because it embodies the aspirations and workmanship of past generations, it merits thoughtful treatment. And on a purely practical level, the middle addition provides useful living space.

**5** Distinctive stylistic features or examples of skilled craftsmanship which characterize a building, structure, or site shall be treated with sensitivity.



HOUSES WITH elaborate exterior woodwork, for example, often fall prey to "quick fix" contractors. The net result is usually loss of distinctive stylistic features and examples of skilled craftsmanship. In the photo above, for instance, the exterior wood--especially on the porch--is in bad repair. A typical recommendation from many home improvement contractors would be: "Rip off the porch and cover the rest in vinyl siding." Removing the porch would rob the house of much of its visual interest, to say nothing of its historic appearance. When covered in vinyl siding, the facade would lose the distinctive character imparted by the shingles, large cornerboards, and framing elements around windows and doors.



**6** Deteriorated architectural features shall be repaired rather than replaced, whenever possible. In the event replacement is necessary, the new material should match the material being replaced in composition, design, color, texture, and other visual qualities. Repair or replacement of missing architectural features should be based on accurate duplications of features, substantiated by historic, physical, or pictorial evidence rather than on conjectural designs or the availability of different architectural elements from other buildings or structures.

THESE ROTTED WOOD BALUSTERS are the kind of deteriorated architectural feature that often winds up in the junk pile. But if they were scrapped, it's unlikely that they would be replaced with balusters of similar shape and quality. And if this loss occurred, the exterior would suffer a serious visual loss. Thus the wisdom of following Principle #6. In this case, the balusters could be repaired fairly easily simply by replacing the square elements at the base--where most of the rot is concentrated. The baluster on the left is also missing some turned work. If it wasn't possible to turn a small replacement element, it could be built up with epoxy putty (or auto body putty) and carved.

**7** The surface cleaning of structures shall be undertaken with the gentlest means possible. Sandblasting and other cleaning methods that will damage the historic building materials shall not be undertaken.

THIS SECTION OF BRICK WALL was recently cleaned by sandblasting. Fortunately for us, the contractor left a piece of electrical conduit on the wall while blasting. Because the conduit was subsequently removed, we get a very

clear "before" and "after" look at the brick wall. You can see where the bricks were protected by the conduit, they still have their smooth, hard surface and small, neat, concave

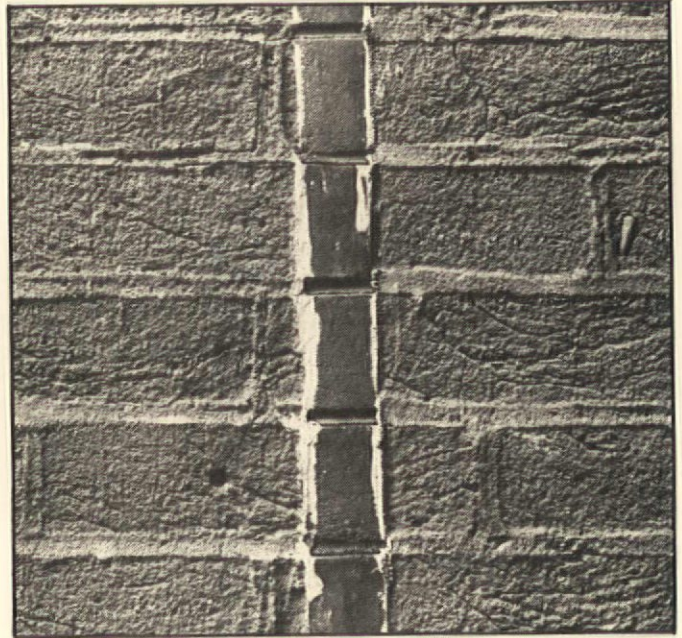

mortar joints. The blasted bricks are badly pitted (having lost about 1/8 in. of their surface) and the mortar joints (after a sloppy repointing job) are about twice the width of the original joints.

**8** Every reasonable effort shall be made to protect and preserve archaeological resources affected by, or adjacent to, any project.



THE GROUND AROUND OLD BUILDINGS is often the resting place for significant historical artifacts. If major excavation (such as for foundation waterproofing) is conducted without professional advice, priceless artifacts may be lost forever, or at the very least their historical

context will be hopelessly jumbled. On the preceding page, an archeologist carefully sifts the ground around Drayton Hall--a National Trust property.

**9** Contemporary design for alterations and additions to existing properties shall not be discouraged when such alterations and additions do not destroy significant historical, architectural or cultural material, and such design is compatible with the size, scale, color, material, and character of the property, neighborhood or environment.



ADDITIONS TO OLD BUILDINGS need not mimic historical styles. New construction can (some would say "should") reflect the design philosophy of its time. The only requirement is that the new construction should blend harmoniously with the older section. In the photo above, the contemporary building relates comfortably to adjacent old buildings, even though it is designed in a frankly modern idiom.

**10** Whenever possible, new additions or alterations to structures shall be done in such a manner that if such additions or alterations were to be removed in the future, the essential form and integrity of the structure would be unimpaired.



IDEALLY, any work that we do on old buildings should be reversible. That is, at some point in the future it should be possible to remove our work and leave the original building intact. In the photo above, the commercial addition added to this old mansion was basically just tacked onto the original building. The addition could be removed and the house restored to its original appearance with some relatively minor patching of the stucco wall.

**Y**OU CAN OBTAIN a complete copy of The Secretary of the Interior's Standards for Rehabilitation by contacting the office of your state historic preservation officer. The office is located in your state capital, and you can locate the telephone number by checking the state government listings in your telephone directory. 

#### REGIONAL OFFICES

##### National Park Service—Archeology & Historic Preservation

The Secretary of the Interior's Standards for Rehabilitation are distributed to the state historic preservation offices through these regional offices of the National Park Service. In addition to the Standards, these regional offices also have copies of the Preservation Briefs issued by the service's Technical Preservation Services section. Because of limited personnel, however, these regional offices are somewhat restricted in the amount of help they can offer to the individual property owner.

Regional Office	States Administered
Southeast Region 75 Spring St., NW Atlanta, GA 30303	AL, FL, GA, KY, MS, NC, SC, TN, Puerto Rico, Virgin Islands
Western Region 450 Golden Gate Ave. San Francisco, CA 94102	AZ, CA, HI, NV
Pacific Northwest Region Federal Building, Rm. 990 915 Second Avenue Seattle, WA 98174	ID, OR, WA
Southwest Region Old Santa Fe Trail P.O. Box 728 Santa Fe, NM 87501	AR, LA, NM, OK, TX
Rocky Mountain Region P.O. Box 25287 Denver Federal Center Denver, CO 80225	CO, MT, ND, SD, UT, WY, IA, KS, MO, NE
Mid-Atlantic Region 143 South Third Street Philadelphia, PA 19106	DE, MD, PA, VA, WV, CT, ME, MA, NH, NJ, NY, RI, VT, DC
Midwest Region 1709 Jackson Street Omaha, NE 68102	IL, IN, MI, MN, OH, WI
Alaska Region 1011 E. Tudor, Suite 297 Anchorage, AK 99503	AK



## Part IV: The Crack Detective

# Planning Structural Repairs

By Wm. Ward Bucher, Architect

*This article outlines the common fixes for structural problems in an old house. You have to know how to read the evidence—be a Crack Detective—to recognize potential structural problems. See the May, July, and August 1981 issues of OHJ for more about what causes old-house cracks.*

**N**OW THAT YOU'VE SOLVED the crack mystery and you know who the criminals are, they have to be rehabilitated so they don't do nasty things again. Sometimes you'll just be fixing what are really the symptoms--falling plaster, and so on; other times the underlying cause has to be addressed before patching. To determine the proper corrective action for what's causing your cracks, you may want to call on other judges for help.

ADVICE WILL COME from designers, and from contractors or craftsmen. Generally the architect or engineer will be most useful at advising you on what to do, while contractors will know most about how to do it. In both cases, try to find someone who has a real enthusiasm for restoration work. People who do new construction may be insensitive and ignorant about old houses.

AT THE START of the project, make it clear to the architect what your philosophy is (stabilize only, or "make it look like new"). Tell your consultants what your cost constraints are: As you might expect, neat, hidden solutions are often the most expensive. And always keep in mind that the contractor who insists there is only one way to attack a problem probably knows only that one answer.

## The Big Fix

**U**NDERPINNING is a major task and should not be rushed into. It basically consists of putting bigger footings under the existing house foundations. And since these foundations are holding up the entire house, it is quite dangerous to dig holes underneath them.

FOR MOST HOUSES, underpinning will mean cutting out alternate three-foot sections under the foundation, putting steel reinforcements in place, and then filling the hole with concrete. After this concrete is hard (usually about seven days), the intermediate sections are dug out and the process is repeated. It is important that underpinning be designed by a professional so that it's the right size and has the correct reinforcing

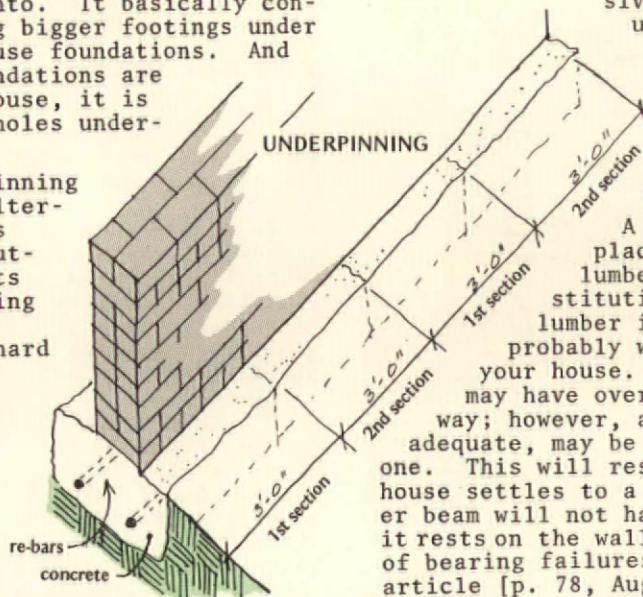

for the soil conditions. It is even more important to have an experienced contractor do the work. If at all possible, have a knowledgeable person watching the workers the whole time they are digging.

BECAUSE OF THE COST and danger inherent in underpinning, it should be a last resort. Where possible, try all of the other repairs first. I recently had a 12 x 18-foot basement room underpinned for \$900. You could expect to pay more for a larger wall or difficult conditions (such as a crawlspace where you can't stand up).

## Sisters In Crime

**I**N SOME SETTLEMENT CONDITIONS, underpinning the foundation can be avoided by stopping underground water flow. Methods for doing this are described in detail in "Bailing Out Of Wet Basements," in the August 1981 issue of OHJ. Water flow is also the cause of wood rot. Rot extensive enough to cause cracks in the structure will have an obvious source of water. Roof leaks, rising damp, unpainted wood, and uncaulked cracks may all have to be fixed to arrest rot.

AT THE SAME TIME, the damaged structural members should be repaired or replaced. There are some relatively "high-tech" epoxy and fiberglass systems available which can be used to repair wood in place. They are generally too expensive to use in major repairs unless it is extremely important to keep the original members in place. Furthermore, do-it-yourselfers should always avoid the use of epoxy reinforcement for load-bearing members.

A BETTER SOLUTION is to replace the damaged wood with new lumber. Be cautious about substituting new for old, since new lumber is of smaller dimension and probably weaker than the original in your house. In some cases the builder may have over-designed the structure anyway; however, a new smaller beam, even if adequate, may be more flexible than the old one. This will result in new cracks as the house settles to a new position. Also, a smaller beam will not have as much bearing area where it rests on the wall. This can cause the kind of bearing failures described in my August article [p. 78, Aug. 1981]. In both cases,

consult an engineer or an architect to size the lumber.

SINCE THE ROT was caused by water it is advisable to use preservative-treated wood for the replacement lumber. The best treatment is a pressure-injected chemical process most often marketed under trade names such as Wolmanized, "Outdoor Wood," or Osiose. Most lumberyards carry or will order pressure-treated lumber.

IN MANY CASES, extensive demolition would be required to replace an entire beam or stud: It is often easier to splice a new member next to the old. (The Restoration Design File in the April 1980 issue of OHJ illustrates different splices.) For repairing the ends of beams or joists, my preference is to "sister" a new member next to the existing one. The overlap must be at least six times the depth of the beam; longer if possible. The sistered beams must be bolted (NOT nailed) together with the bolts alternating between the top and bottom of the beam. A professional should design the spacing, size, and number of bolts.

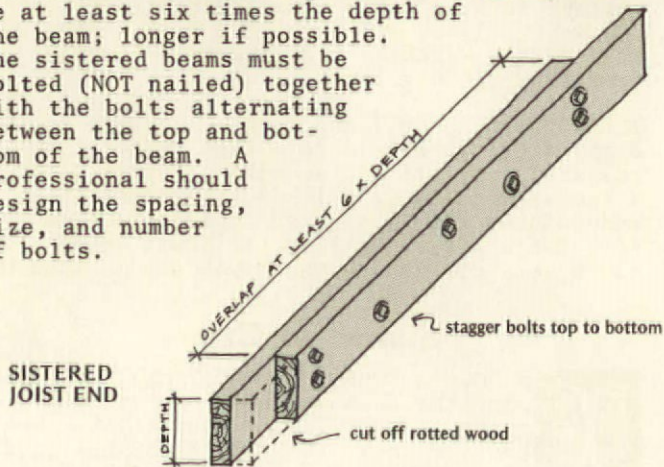

Where twisting is likely, new lumber should be sistered on both sides of the damaged end of the existing wood.

IN A MASONRY BUILDING, it may be difficult to install new joists in existing beam pockets. An easy answer is to install two new joists which are sistered together. Each joist will be at a slight angle to the originals, but their combined thickness will give plenty of nailing surface in the right place. Be sure to fire-cut the ends of the new joists at a 15° angle. Resist the impulse to fill in that beam pocket around the new wood in a brick or stone wall. Mortar--which attracts and holds moisture--in contact with the sides of the wood will rapidly cause rot.

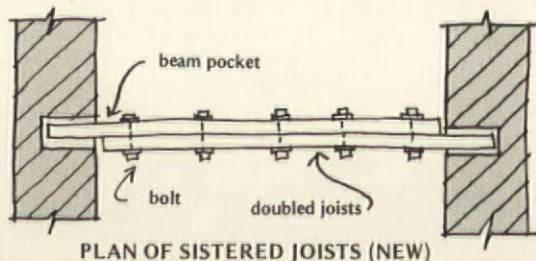

**V**ILLAINOUS WATER must also be kept away from iron and steel. Regular painting of exposed iron is a must, but it won't help iron which is underground or encased in stone. After cleaning away the rust, pack lead wool into the joint between a railing post and the masonry.

MORE SERIOUS iron-oxide (rust) cracking occurs in reinforced concrete, such as precast lintels. If iron or steel is buried too close to the masonry surface, the metal will eventually get wet. Metal expands to twice its original size as it rusts; this will crack the lintel. The same forces are at work when iron cramps, anchoring terra-cotta or a masonry veneer, rust. Analyzing and designing for such complex and potentially hazardous problems should always be done by an engineer.



FOR ARCH PROBLEMS, your first step is to stop movement at the ends of the arch. If the movement is a horizontal spreading one, then tie-rods can sometimes be used to relieve the force pushing on the wall. A new tie-rod will consist of two steel rods which are threaded on both ends, a turnbuckle connecting them in the middle, and cast-iron stars or square steel plates on both ends.

#### TIE-ROD REINFORCEMENT

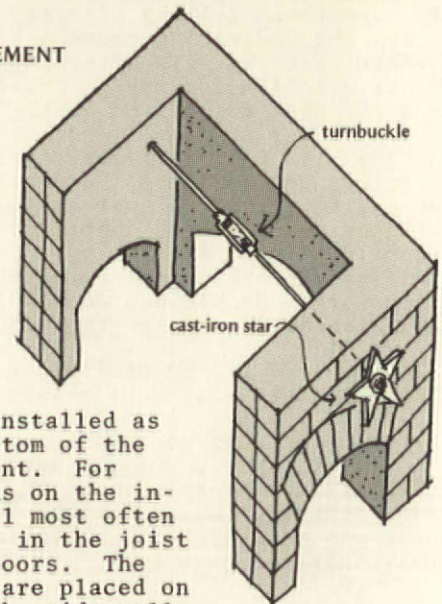

THE TIE-ROD is installed as close to the bottom of the arch as convenient. For aesthetic reasons on the interior, this will most often mean sticking it in the joist space between floors. The plates or stars are placed on the outside of the side walls, and the turnbuckle at the center is tightened. In most cases you just want to stop further movement--so the turnbuckle is turned only to hand-tight. The assembly pictured here would cost three to five hundred dollars to have a contractor install.

IF THE FAILURE of the arch is due to ground settlement, deal with it as described earlier for foundation problems--stop water and underpin if necessary.

WHERE THE PROBLEM is a wood lintel on the interior, it can be replaced with a reinforced concrete lintel. You may find a precast concrete lintel at a masonry supply house which will fit. Another approach is to install a steel angle and fill the space where the wood was with brick. Again, check with an architect.

ONCE ARCH MOVEMENT has been arrested, the arch can be rebuilt. First remove the bricks or stones in the "triangle" above the arch. Old mortar should make this job easy--just lift them out. With pieces of wood, temporarily shore up under the arch and remove the keystone. Watch out: The rest of the pieces will fall onto the shoring.





REPLACING THE ARCH may be more difficult. There are few masons around today who can, or will, produce the thin mortar joints often found on an old house. However, it is important that the joints be duplicated, as a bad patch can ruin the appearance of a masonry building forever. It's also very important that the mason build a true arch, not just fill in the space with bricks. I've seen arches replaced with horizontal brickwork that was just resting on the wood frame of the window below. This will only cause more cracks in the future. If the original arch was a jack arch (flat on the bottom), it is a good idea to use steel angles for support. Expect to pay around two or three hundred dollars per arch for rebuilding, plus the cost of scaffolding.

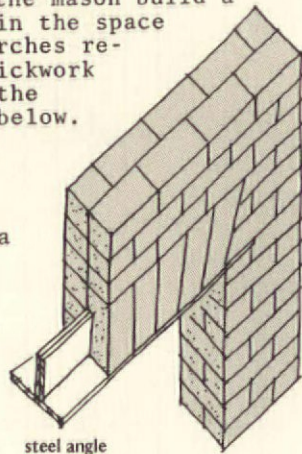

steel angle placed in jack arch

CONSIDER WHETHER the arch really needs to be rebuilt before undertaking all that work. An arch can be quite distorted without actually failing. Once its movement has been arrested, a bit of repointing to keep the water out may be all that's required.

### Joist Hangers



FAILED CONNECTIONS in the house should be reconstructed. Invention and ingenuity play a bit part in redesigning and integrating structural connections in an old house. A common connection failure is that of joists to girder. The easiest repair will often utilize a metal joist hanger. (Since the ones available today aren't sized for yesterday's lumber, you'll have to have one made up by an ironworker or welder. Or you can try wedging between the hanger and the wood joist.\*) Connections for heavier loads, such as a girder which carries several joists or a bearing wall, should be designed by an engineer. Bolt, don't nail, the hanger.

METAL CONNECTORS can also be used to tie a bowed or leaning wall into the rest of the structure. A combination of tie-rods, connecting plates, and even reframing the building may be involved. Your aim should be to make the whole house act as one structure rather than a bunch of individual elements. For example, bowing walls on opposite sides of a house can be arrested by connecting them with tie-rods that run all the way through the house. If the walls were merely tied to the joists nearest them, the wall would just move the joists sideways. This is where a creative architect can be a great help.

IN BEARING FAILURES, the weight must be spread over a larger area. If the wood beam is being crushed, sistering the end can double the area bearing on the wall. If the brick in the wall below the beam is being crushed, a metal plate, wider than the beam, can spread the weight over more of the wall. The area you need for bearing can be easily calculated by an engineer.

### Clues To Reinforcement



WHEN THE PARTS of the building cannot take the existing load on them, you can reinforce them or move the load somewhere else by providing additional support. Overloaded beams and columns both can be reinforced by bolting wood or steel to the existing member. A steel channel section can be bolted to wood beams and columns to reinforce them. A steel plate, called a flitch plate, can be sandwiched between two wood beams. Beams with notches in the bottom side can be reinforced with steel angles bolted to the bottom half of the beam. Notches in the top of the beam can be filled with wood and wedged tight. Holes in masonry walls can be bridged over with a steel plate or angle... and so on.

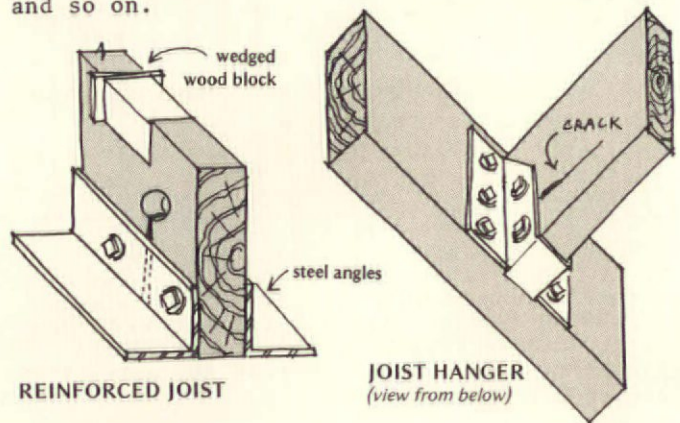

REINFORCED JOIST

JOIST HANGER (view from below)

THE COST OF STEEL AND WOOD for reinforcing is usually minor compared to the cost of installation and finish work. A recent repair job that involved removing a two-foot by twenty-foot

\*See August 1981 OHJ, p. 192: Cleveland Steel Specialties Co., for custom-sized joist hangers.

Repair	Design		Construction	
	Consult Architect or Engineer	Do It Yourself	Do It Yourself	Use a Contractor
Underpin	always	not advised	not advised	use specialist
Stop Water Flow	as a last resort	most work	most work	special trades only
Tie-Rods	to design size & location	not advised	not advised	experienced contractor!
Replace Materials	to determine extent of damage	for carpentry	for carpentry	for masonry
Connection or Bearing	always for bearing	not advised	not advised	yes
Reinforce Structure	always	for carpentry	for carpentry	steel, masonry, concrete
Install Add'l Support	always	not advised	not advised	yes
Relevel by Jacking	to decide need & impact	not usually advised	not usually advised	use specialist
Expansion Joint	to determine need & location	yes	yes	masonry contractor
Patch Plaster	no	yes	yes	not necessary
Caulk	no	yes	yes	not necessary
Repoint Masonry	no	small jobs	small jobs	large jobs
Plane Doors & Windows	no	yes	yes	not necessary
Live With It	if you're not sure	-	-	-

THIS CHART outlines the situations where I recommend you ask an engineer or an architect, and a contractor, for help. Construction work listed as "not advised" for do-it-yourselfers is work that carries high risk—work that could cause serious problems if not done right by a skilled person.

## CRACK REHABILITATION

REPAIR	SUSPECT	Differential Settlement	Undersized Footings	Underground Erosion	Expansive Clays	Concentrated Loads	Shallow Foundations	Bowed Wall	Leaning Wall	Wood Rot	Insects	Fire	Salt Decay	Acid Rain	Freeze-Thaw	Rust	Connection Failure	Bearing Failure	Overloaded Beam	Overloaded Column	Arch Failure	Holes in Beams and Walls	Enlarged Openings	Bearing Wall Removed	Footings Cut Off	Increased Weight	Geometry Changes	Thermal Expansion	
Underpin Foundation		•	•	•	•	•	•														•			•					
Stop Water Flow			•	•									•	•	•	•													
Install Tie-Rods																													
Replace Damaged Material																													
New Connection or Bearing																													
Reinforce Existing Structure																													
Install Additional Support																													
Relevel by Jacking	•		•	•																									
Install Expansion Joint																													
Patch Plaster	•																												
Caulk Cracks	•																												
Repoint Masonry	•		•	•																									
Plane Doors and Windows	•																												
Live With It	•																												

section of ceiling and bolting two 3" x 6" angles to a cracked joist cost \$1000. The contractor said only \$100 of this was for steel. It is often cheaper just to provide additional support instead of reinforcing the existing structure. The drawback is that the extra support is often visible.

### Further Support

**B**EAMS WILL SUPPORT more weight if they're made shorter between bearing points. This can be done by putting a column between the two ends (not necessarily in the middle). Similarly, joists can be effectively shortened by installing a beam or bearing wall perpendicular to them. Overloaded columns can be relieved by installing additional columns to take over some of the load. A new column might be right next to the existing one or someplace else along a main girder. The easiest type to install are the adjustable pipe columns sold at lumberyards. A telescoping jacking post doesn't hold as much weight as a solid pipe column with an adjustable screw jack at the head. In either case, be sure to buy a column which will support the new load you want to put on it. Columns can also be made of a 4 x 4 or larger (no 2 x 4s, please) with a house jack on top, or a wood column wedged in place, or a solid masonry pier (8" x 8" or larger).

WHEN COLUMNS ARE INSTALLED above the basement level, they must have solid support all the way to the ground. For example, a new column on the second floor has to have support under it at both the first floor and basement levels. If the load isn't transferred to the ground, you'll have new cracks and worse. Likewise,

support must be given in the under-floor spaces; that is, solid blocking will probably be required in the joist space between floor and the ceiling below.

WHERE A BEARING WALL has been removed or weight has been increased, a combination of beams and columns may be required to bring the load down to the ground. In most cases this will require installing new beams below the original ceiling level. The columns can often be hidden inside existing walls. Use wood beams for short spans and lighter loads, steel beams for longer spans and heavier loads. Since prefabricated pipe columns are relatively short, they will be used mostly in the basement level of older homes. Wood columns will be sufficient for most loads in residential situations. Both beams and columns must be custom-designed for the particular situation in your house: Consult your friendly local architect or engineer.

### Further Stress



CRACK REHABILITATION technique which is many times unnecessary structurally--yet carries a good deal of risk--is jacking to relevel your house. When the movement of the house has been limited to a small area, jacking can be performed fairly easily. If the whole house has moved, however, jacking can cause massive cracking as the house is relevelled. Seriously consider accepting those sloped floors and walls as part of the charm of an old house.

IF YOU MUST RELEVEL THINGS, try to move all the affected parts together. If a floor is to be levelled, for example, place a beam under all

the joists and then jack the beam, rather than jacking individual joists. Move the house ex-cruciatingly slowly; once the jack is in place, a quarter turn every three days is quite fast enough.

## Solving The Case

**S**OME CRACKS are caused by thermal expansion or changes of geometry in the structure--conditions that will remain. Since the reasons for these cracks are inherent in the design of your house, you'll have to settle for stopping further damage rather than a permanent rehabilitation back to the original. Making the cracks themselves permanent is one good approach. This procedure in effect creates an expansion joint.

THE SIMPLEST expansion joint is made by filling an existing crack with a flexible sealant. The caulking must not be the type which hardens up, or it will crack as the building moves again. (The sealant keeps moisture and debris out.) I recommend butyl rubber caulk for the interior, and a one-part polyurethane (e.g., Vulkem #116) for the exterior. Polysulfides also have good elastic properties, but won't bond well if there is any moisture present.

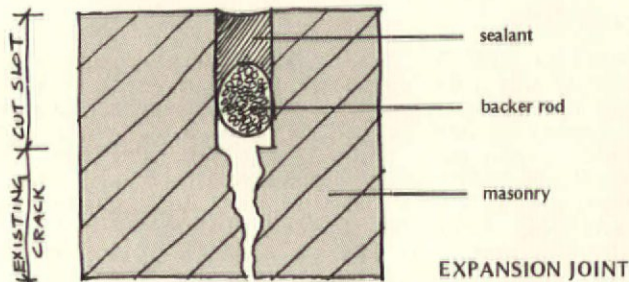

THERE MUST BE a sufficient amount of sealant in the joint to absorb continued movement. A sealant can move about 25% of its width: If the crack is going to move 1/8 inch, then the joint must be at least 1/2 inch wide. If it's necessary to widen the crack, use a carborundum blade in a circular saw to cut a slot.

THE MINIMUM EFFECTIVE SIZE is 1/4 x 1/4 inch, but a 1/2-inch width is better. The depth of the sealant must be at least 50% of the joint width. For joints 3/8 inch or wider, use a closed-cell polyurethane backer rod (available at builder's supply houses or concrete materials suppliers). The backer rod is pushed into the joint to fill up the space behind the sealant; then the sealant is applied with a caulking gun until it is flush with the surface.

## Meanwhile...

**I**N THE TIME between realizing a crack situation is potentially hazardous and knowing just what to do about it, you should shore up certain situations temporarily so that they don't get worse. The size of the crack is a good indicator of the severity of the crime. Use your common sense; if you're not sure about something, install protection anyway, and get expert counsel.

FAILING ARCHES AND LINTELS should be shored up inside the window opening. The support should be designed so the arch is supported all along its length. Plaster and masonry cracked enough that it may fall should be removed or well shored. A four-foot square piece of plaster--weighing over a hundred and twenty-five pounds--dropping from the ceiling could seriously injure someone. The plaster can be temporarily held up with plywood.

IN EXTREME CASES, raked or flying shores may be needed to support the walls. This kind of shoring is like a smaller version of the flying buttresses on Gothic cathedrals. The shoring transfers the horizontal load on the wall down to the ground.

RAKED SHORES

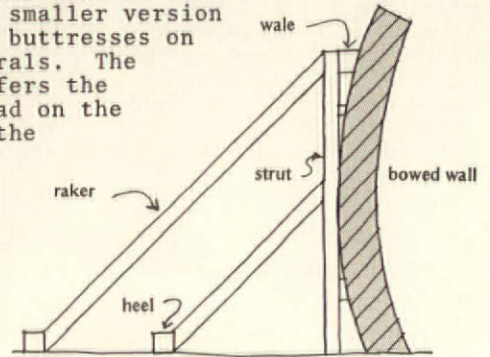

HARDWOOD WEDGES can be driven into horizontal cracks. This procedure will both fill the space and re-establish bearing on the wall below the crack. Be careful: Over-driving the wedge may accelerate the movement that's causing the cracking. If the wedges loosen up over time, you'll have evidence that the movement is continuing.

**W**HEN MOVEMENT has stopped of its own accord, or been arrested by repairs, crack damage can be treated. Now is the time for plaster patching or replacement, caulking, repointing, and planing doors and windows. Is old-house living not all it's cracked up to be? (Or more cracked than you expected?) Remember that in many cases, rehabilitation is either unnecessary or not crucial.

A COMMON FINAL VERDICT is to live with symptoms of movement and age-cracks and all. More problems have been created by quickie crack repairs than by benign neglect. As a crack detective, you can continue to gather information over the next few years, until you are certain about the cause, and until you have the money and knowledge to make the right repair. Happy sleuthing!

## The Architect & A Book

WARD BUCHER is an architect in Washington, DC, and a good friend of *The Old-House Journal*. He says that the best book in print on this subject is *Diagnosing & Repairing House Structure Problems* by Edgar O. Seaquist (1980, McGraw-Hill). It concentrates primarily on houses built after World War II, but old-house owners will find it very useful. The book is available for \$14.95 plus \$2.00 postage from McGraw-Hill Bookstore, Mail-Order Department, 1221 Avenue of the Americas, New York, NY 10020. (212) 997-1221 (ask for the 'Bookstore').

# Restorer's Notebook

## Hidden Gate

**M**Y HUSBAND AND I tried to figure out how to finish off the last section of our 3-plank fence. We wanted access in and out of the yard, but we didn't want a permanent, "store-bought" gate, which seemed both expensive and ugly to us. While walking through a neighbor's pasture my husband ran across a simple, inexpensive, and aesthetically pleasing way to solve our problem. Instead of a gate that opened and closed, we built the last section of our fence so that it could be opened or closed.

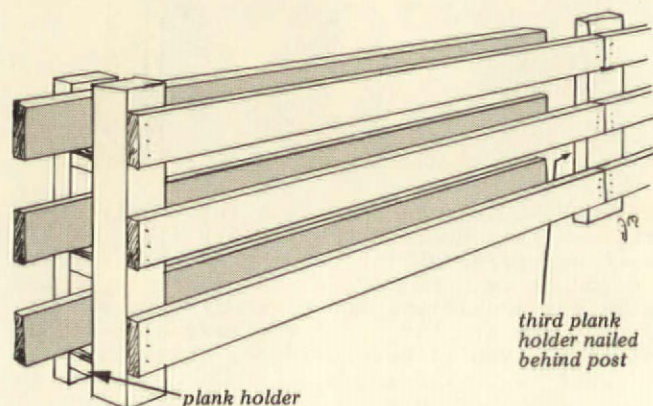

ON THE BACK SIDE of the two posts at the fence opening (the side opposite to where the fence planks are nailed), my husband nailed three pieces of wood, 1½ in. deep x 3 in. high x the width of the posts. He then nailed onto each post a 1-in.-thick board over the three 1½ in. x 3 in. pieces. This 1-in.-thick board was the same width and height of the posts. This created three slots or grooves to hold the three planks (what we now call a "plank holder"). Now when we need access in or out of the yard, we just slide the planks open and reclose them when finished. From the road the plank holders cannot be seen, so the fence presents an unbroken line to passersby. One more thing: A third plank holder should be built on the back of the next closest post--it will help hold the fence planking more securely while the section is open.

Kathryn Coiner Denney  
Waynesboro, VA

## Restoring Stencilling

**W**E HAVE SOME ORIGINAL STENCILLING in our 1873 Italianate house. The stencilling itself was in pretty good shape but the varnish that had been used to protect it had become quite dark and dirty. After consulting an art conservator we used a method she suggested. First we did a test patch; it was a considerable success, so we went on and used it on all the stencilling.

TO DISSOLVE THE OLD VARNISH, we used a mixture of 2/3 acetone and 1/3 paint thinner by volume. This mixture was applied with cotton wads and a light scrubbing action to dissolve and remove the darkened varnish. The paint was somewhat chalky and bleached after this treatment, but we restored the color by applying a fresh coat of varnish. We used an artist's acrylic varnish--Solvar--diluted to 50% with paint thinner, but any varnish designed to be used over oil paintings will do. (Consult your local art supply store.) These varnishes are designed to be removed from time to time, so if anyone ever has to re-do our varnishing, it shouldn't be too difficult.

Patricia Wales  
Boston, MA

## New Blind Cords

**B**LINDS SHOULD BE RESTRUNG before they break, so look over all of them and see if you can find any worn spots that could give at any time. On the bottom right-hand corner of the blind under a protective plate is the beginning of the cord. It is probably tied in a knot. Cut off this knot and attach the end of the old cord onto the end of the new cord that you've purchased.

TO ATTACH THE TWO CORDS, you cannot overlap them or tie them together. You have to place them end to end and then wrap them with masking or transparent tape until they're securely fastened. Then pull the old cord out (at the left-hand side) as you pull the new cord in. Keep pulling until the new cord has reached the lower left-hand side of the blind. Once through, just knot the cord at the right-hand side, pull the cord to the correct tension, and knot it on the left side.

Sharon Hooper  
Boise, ID

## Replacing Your Gaskets

**I**N OUR LOCAL architectural salvage store we found two Crane pedestal lavatories. No porcelain here; these were solid china, made in the Trenton, New Jersey, works of the Lennox China Company. They had solid brass faucets and valve assemblies with a mixing chamber and spout cast in the china.

EACH MIXING CHAMBER had two holes for receiving a half-inch pipe from the valve assembly. Each pipe had a large gasket around it, and these gaskets needed to be replaced: When we turned on the water for the first time it sprayed all over the new bathroom.

THE OWNER of the local Crane distributorship looked all over the country for what he called "spud washers," but had no success. A local rubber-fabricating shop said that they would reproduce the four gaskets--at a minimum cost of \$200!

I DESCRIBED MY DILEMMA to a friend, who asked me what the gaskets looked like. I replied that they resembled ... test tube stoppers.

Eureka! I made a beeline to a chemistry supply store and bought No. 5 test tube stoppers, the kind with a hole in the center. I made the hole larger with a half-inch drill bit, holding the stopper in a pair of pliers (using a vise to hold it would have been easier and safer, however). The new gaskets worked like a charm, and our two pedestal lavatories are now installed in all their glory.

E.J. Holland, Jr.  
Kansas City, MO

### A Bang-Up Method

**G**UN STOCK OIL is a special oil made for finishing gun stocks. But I have discovered that it makes an excellent finish for my pine countertops. It's readily available in sporting goods stores and in the sporting goods departments of hardware and discount stores. It comes in small, 2-oz. bottles at \$1.50 to \$2 per bottle, but a little goes a long way. I have a lot of counter space, and I used only nine or ten bottles. (Birchwood Casey Tru-Oil Gun Stock Finish is one brand that I liked.)

THE ONLY SURFACE PREPARATION is to sand to a smooth surface, fill any holes with wood filler, and stain. (I used a fruitwood oil-based wiping stain.) The gun stock oil is applied with a small folded rag or just the palm of your hand. Rub in as much as the wood will absorb, being sure not to leave any excess on the surface. Let dry thoroughly (for two or three hours) and rub down with fine steel wool. Repeat this process until you have built up the finish you desire, ending with the steel wool rub. The wood will absorb less and less oil as you progress. I used five or six coats.

I PLAN TO STEEL-WOOL my countertop and apply another coat from time to time as it gets worn, but so far I have not needed to do this. The finish is super hard and extremely water resistant, yet has a low luster gloss. I have been very pleased with it.

Judith A. McDonald  
Palestine, TX

### More Nail Pulling

**R**EADERS MIGHT APPRECIATE an alternative to the vise grips/claw hammer process of nail removal suggested by Dan Miller in the July 1981 "Restorer's Notebook." Most hardware stores sell a tool that is a sort of pliers much like a wire nipper with blunt, offset jaws. One version of this tool that I have been particularly impressed with is called the Nail Outener. It has a pivot arrangement that gives great mechanical advantage for grabbing a nailhead or stub, and its broad, flat, oval shape enables you to "rock" out the nails without damage to anything harder than basswood.

THE NAIL OUTENER is especially useful in tight corners, for single-hand operation (from a ladder, for instance), and for pulling old or soft aluminum nails that have had their heads sheared off. It's also efficient for stripping a roof deck of shingle nails, for wire staples

used with acoustic tiles, and for cleaning up salvageable millwork.

YOU CAN ORDER the Nail Outener through the mail from Brookstone, 127 Vose Farm Road, Peterborough, NH 03458, for \$14.50.

Kurt Kucsma  
Brooklyn, NY

### Window Security

**P**RACTICALLY ALL OF THE NUMEROUS locking devices for double-hung sash windows (Victorian gadgets or modern) can be easily defeated by anyone equipped with a long, thin knife or a hacksaw blade. But there is a simply-made locking device that can't be defeated: a piece of wood standing up behind the sash cord, cut to such a height that it permits the lower sash to be opened only about six inches.

NAIL OR CAULK the upper sash in place. Then cut a slot in the top of the piece of wood, to allow the cord to pass over its roller unhindered. Paint or stain the stick to match the surrounding woodwork, and it will be undetectable. The stick can be easily removed by someone inside the house, so there's no problem if you want to raise the lower sash all the way. But an intruder who is outside won't be able to dislodge the stick when it's in place. This will foil most burglars, who are reluctant to break and enter (there's a legal reason) and are looking for an easy way in.

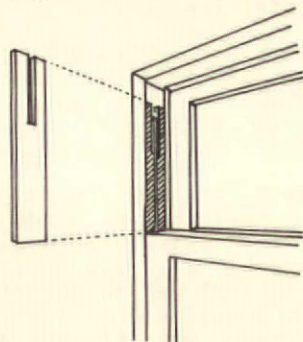

James B. Tyler  
San Francisco, CA

### Net Results

**T**HE COARSE KIND OF NYLON NET can give you a lighter abrasion between coats of paint than you can get with sandpaper. Don't use the same piece of net over and over again, however, because it will lose its abrasive quality. The used net can also be helpful for scouring off any water-based paint that may have dried on your hands and arms. Just rinse out the net before scrubbing with it. Nylon net is commonly available at many houseware outlets and drug stores.

Sally Hunter  
Alexandria, VA

### Got Any Tips?

Do you have any hints or short cuts that might help other old-house owners? We'll pay \$15 for any short how-to items that are used in this "Restorer's Notebook" column. Send your hints to: Notebook Editor, The Old-House Journal, 69A Seventh Avenue, Brooklyn, N.Y. 11217.

MANY HOMEOWNERS PREFER A PLASTIC, such as Lexan, because it will not shatter if kicked or hammered. However, it will scratch and become dull eventually, just under normal use. Safety glass of the type used in car windshields is about half the price of Lexan, and will remain bright. It can be cracked or punctured, but usually will not give way. (Putting safety glass in the parlor-floor windows isn't a good idea: It's very expensive, and you'd be unable to break out if there was a fire.)

GLASS PANELS IN AN OUTSIDE DOOR enable anyone on the street to see what is happening in the vestibule between the doors. This feature is a deterrent to crime. Nevertheless, many people do a curious thing that undermines their one good security feature: They put up fancy curtains and shades on the outer door to ensure absolute privacy while they're being mugged or worse. An opaque outer door is an invitation to a criminal to join you as you enter your home.

TO MAKE MATTERS WORSE, outer doors are frequently left unlocked. If they're also opaque, then a burglar can work unseen for however long it takes to break through the inner door. Outer doors should always be well locked.

NO MATTER HOW STRONG a door is, if it is improperly hinged, then it can be pried loose or lifted out. Unless you have a steel door jamb, the hinge screws on a door should extend into the stud behind the jamb. If the hinge pins on a door are on the outside, then there are several ways of temporarily foiling those patient criminals who are prepared to unhinge a door altogether (which is sometimes done right out on the street). You can buy and install pin caps as a deterrent. It's also possible to pin a hinge by replacing a pair of opposing screws in a hinge with a 20d nail. Leave 1/2 inch of the nail protruding from the frame and cut off the head with a hacksaw.

**Old locks are easily opened with picks or skeleton keys and must be supplemented by a modern auxiliary lock.**

MANY CITY HOMEOWNERS feel that gates are necessary on their exterior doors, and gates generally do give superior protection--as long as they're well built. An iron gate must have a secure frame. There should be a good overlap between door and frame, preferably one extending up to the lock. (A narrow frame can be built up by welding on another piece.) A guard plate should be used, both around the lock and over the joint between frame and gate. And make sure that no one can reach through the bars or grille and unscrew the lock. If the grillework is not close enough, then use a protective plate.

### Locks...

**O**LD LOCKS DO NOT PROVIDE sound security. Many are inherently weak or have become worn with time and use. There are many handsome locks dating back to the turn of the century and even earlier, and it would be

a shame to displace these. Nevertheless, they are easily opened with picks or skeleton keys, and must be supplemented by a modern auxiliary lock. (It is possible--usually for a price--to combine the old and the new pleasingly.)

THE GLOSSARY ON PAGE 285 offers an overview of several recent lock types, good and bad. When you select either a primary or an auxiliary lock for your exterior door, always get a good deadbolt lock. The bolt must be at least 1 inch long; it must extend 3/4 of an inch into the strike. This lock should have a cylinder made to resist an attack by screwdriver, pinners, pick, hammer, or the like.

YOU PROBABLY ALREADY HAVE a vertical deadbolt rim lock on your door. This is a good, common lock, but its value is undermined whenever it is sold and installed with short wood screws. You should use instead machine screws with flat washers under screw hex heads. When finished, round off the corners of the bolt hex heads to make them hard to grip. Good vertical deadbolt rim locks include the Ideal Super Guard Lock II, the Ilco-Union, and models by Yale, Segal, and several other manufacturers.

A PROBLEM ARISES with these locks if you they are set on panelled doors (whether panelled with glass or thin wood) or on doors with sidelights. A burglar can easily break the panel, reach in, and open the lock. Short of replacing the door, the best thing to do is replace the lock with a dual-cylinder model. (Dual-cylinder locks are also advantageous because they make trouble for someone who has broken in some other way, such as through a fire-escape window: How can a crook get out quickly with your large television set or stereo?)

DUAL-CYLINDER LOCKS, however, are very unpopular with fire departments, and may even be illegal in your locality, especially if you have tenants. Nevertheless, they are widely used by people who see no other effective, reasonably-priced alternative. If you do have such a lock, then you must always keep a key somewhere near the door. (Some people leave the key in the lock when someone is home and remove it only when the house is being left empty.)

### ...& More Locks

**A**MONG QUALITY AUXILIARY LOCKS, the most popular is the tubular deadbolt lock. But be careful: Some of the cheaper models are not sound. Make sure that the lock you purchase is well constructed from high-quality steel. Another caution: Consumer Reports believes that installing a standard tubular deadbolt lock may weaken the door as a result of the mortising. It recommends the Medeco Ultra 700, which clamps on the door in such a way as to strengthen it. Schlage, Weiser, and several other manufacturers also make good tubular deadbolt locks. (Dual-cylinder models of these locks are also available.) But with all of these locks, you must reinforce the strike.

A LOCK IS ONLY AS GOOD AS ITS STRIKE. Strikes are usually sold with 1-inch screws, and these are inadequate if you don't have a metal door

## Glossary of Lock Types

*This glossary provides brief descriptions of common locks. Most of these locks are dealt with in more detail in the article. (Comments are offered on the quality of the locks that aren't mentioned in the text.)*

Deadbolt locks have a flat or cylindrical metal bolt that slides into the strike.

Dual-cylinder locks have keyholes on both sides of the door, and so cannot be opened from inside without a key.

Latch locks use a latch on a spring instead of a deadbolt; the opening mechanism is in the doorknob. These locks offer virtually no security. They can be pulled out of the door by hand, knob and all, and the latch itself can be easily pushed back with a piece of plastic.

Mortise locks are set into a space cut into the door; the strike is set into the door frame.

Tubular deadbolt locks are fixed into the door itself. A hole is cut in the face of the door, and the lock sections are bolted through it. Another hole is then cut in the edge of the door to allow the bolt to slide into the strike.

Tubular-key locks utilize a short, tubular-shaped key instead of the usual flat key. These locks have proven to be all too easy to pick.

Vertical deadbolt rim locks have a keyhole on the outside and a small oval knob on the inside. The bolt moves vertically into the eyes of the strike (which is attached to the surface of the door frame).

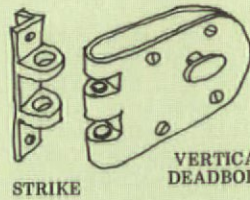

STRIKE

VERTICAL DEADBOLT

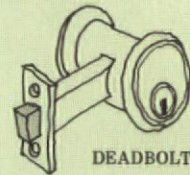

DEADBOLT

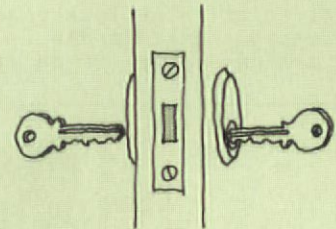

DUAL-CYLINDER

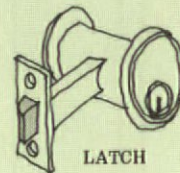

LATCH

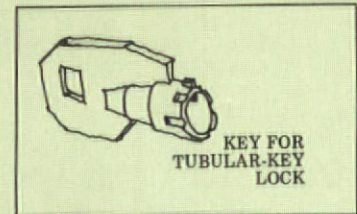

KEY FOR TUBULAR-KEY LOCK

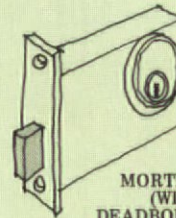

MORTISE (WITH DEADBOLT)

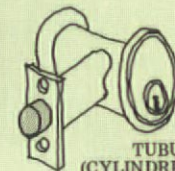

TUBULAR (CYLINDRICAL) DEADBOLT

frame. If you have a wood door frame, then you'll have to take measures to strengthen the strike. It must be anchored to the stud behind the frame.

A STRIKE REINFORCER is a small plate that comes with 3-inch screws that reach into the stud. It is available from Schlage for \$3 or \$4; it is the least you should do for your lock. Two high-security strikes are the M.A.G. Strike 3747 and the Meister 2000. As much as I dislike guard plates, those of you who have a softwood door may also need a plate around the lock as well as a plate or metal channel at the edge of the door by the strike. This area is the first target of a pry-bar assault. Burglars rarely use a saw or hammer in conjunction with a pry bar on a bolt. But if you're nervous about this, there are locks with high-security bolts that are designed to rotate under the action of a saw.

### Double-Door Protection

**D**DOUBLE DOORS, common in many old houses, are especially vulnerable to being kicked in. One of the two doors should be firmly anchored, preferably by flush locks at top and bottom--that is, bolts set into the rim of the door as opposed to surface-mounted bolts. If you can readily jiggle the door, then it's not adequately fixed.

MOST HOUSEHOLDERS who feel the need for ultra-security at double entrance doors put up an iron gate in front of the doors. Iron gates do delay and deter break-ins, and are preferable to mutilating a door with several locks and various plates of armor. But if you have good, solid, well-anchored doors, you may be able to get away with one good lock. (The Segal 466, for example, is considered tough and relatively jimmy-proof.)

THE NEXT STEP is some sort of bar lock, such as are manufactured by Fox. They're famous and very good, but also rather ugly. If you have truly beautiful doors and want to show them off, then you should consider the Rolls Royce of bar locks: Fichet<sup>1</sup>. For the maximum in security, they offer the Multi-point bar lock for single or double doors. It is a vertical bar lock with five deadbolts (including one that runs into the floor and one into the head of the door). It also has two dog bolts for the hinge side of each door. The simplest Multi-point for double doors costs about \$750, uninstalled.

DAMAGE TO THE DOOR is kept to a minimum relative to the security obtained. Only one hole is drilled, for the cylinder. From the outside, all that is visible is the keyway and scar plate (to cover old lock holes). The

<sup>1</sup>The Fichet Company, Box 92, Halesite, NY 11743. (516) 673-1818.

latter is 4 in. x 10 in., but can be cut down. From the inside, the lock is more obtrusive. It also requires 54 screws, which of course do some damage to the door; but the harm is limited to a 6-inch strip at the edge of the door.

A MORE HANDSOME LOOK comes with Fichet's Verti-bar, in which the entire lock is encased in a uniform housing. It's available in several finishes, and costs about \$140 more than the Multi-point. The lock comes with or without a panic-proof exit handle, and Fichet's unique key system appears to be truly pick-proof.

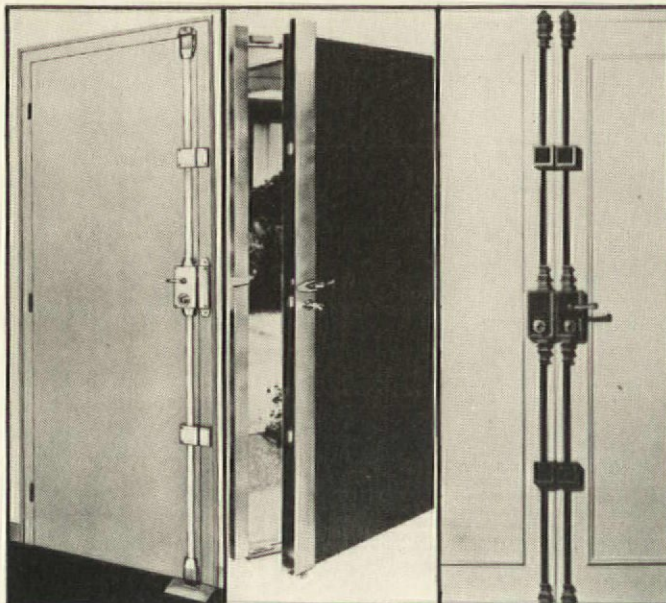

These three bar locks are all made by the Fichet Company. The Multi-point is at left and the Verti-bar is center. At right is the Marly, their most elegant incarnation of the bar lock.

A FINAL WORD ABOUT LOCKS. You can save money and extend the life of your locks by learning to install them and doing the minor repairs and maintenance yourself. Locks should be lubricated with graphite and cleaned once a year. You should also check for changes that may affect the proper fit of the lock: Screws may have worked loose; a door may have warped; if you have a gate installed under a stoop, then the settling of the house may affect the alignment; and so on. (Mortise work on doors should not be done by beginners, however, because a mistake can ruin the door.)

### Alarms...

**T**HE TECHNOLOGY OF ALARM SYSTEMS is improving but still fallible. In every large city, life goes on to a background accompaniment of alarm bells, horns, and sirens, all ringing interminably and all ignored. False alarms and lack of response are the two major problems with home alarm systems. The third is the actual failure of the system when it is needed. An alarm, therefore, cannot be relied upon as a primary defense. As back-up protection, however, it can be significantly useful.

A house that advertises itself as alarmed will discourage some (not all) interested burglars.

MOST PEOPLE WANT AN ALARM to do two things: scare away intruders and summon help. To fulfill the first function, most alarm systems employ some sort of loud noise and/or bright light. But in many localities, the time an alarm is permitted to sound is limited to only a few minutes, so it may elicit no response at all. Thieves know this and will wait to see if there's any response to an alarm. If there isn't any, they come back.

AS FOR THE SECOND FUNCTION, many alarm systems include dialers that will call one or more numbers to summon help. Because of the great number of false alarms, however, many police departments do not want or by law do not allow such calls to come in on their emergency lines. In rural areas, police may not be prepared to respond to a taped message (often of poor acoustic quality) from someone they don't know who lives ten miles out of town. Before buying a system with a dialer, be sure your police department will do something about the message. If they won't, then you need a friend who is always home and will rush to help you (a rare friend indeed). A good--but expensive--alternative is central station guard service, such as the kind provided by Manhattan's Holmes Protection, Inc<sup>2</sup>.

THE MOST RELIABLE ALARM SYSTEMS are based on or include a hard-wired perimeter system. (This system calls for running wires through the walls, so try to decide on it before finishing work on the house.) A hard-wired system typically includes magnetic circuit switches on windows and doors, a central control box and system monitor, a dialer, and an alarm horn (usually placed in a protective steel box under the eaves). It costs between \$1500 and \$2000, so be sure to use a well-established company with a good record in your area. (Check with local police.) You can save half the cost if you do the wiring yourself, although this job is not simple. Hard wiring your house can also reduce your insurance premiums, perhaps up to 15% for a system that includes a central station answering service or guard service.

**In every large city, life goes on to a background accompaniment of alarm bells, horns, and sirens, all ringing interminably and all ignored.**

HARD WIRING YOUR HOUSE is a major investment, and one that you can't take with you if you move. Moreover, there are ways of defeating any alarm system. For example, a burglar can avoid disturbing magnetic switches by making a hole in the middle of the door or window--or even roof--and entering that way. For this reason, alarms are connected to metal foil tape on the window. The idea is that once the glass is broken, the tearing of the tape will

<sup>2</sup>Holmes Protection, Inc., 370 Seventh Avenue, New York, NY 10001. (212) 736-8100.



break a circuit and set off the alarm. But it is possible to cut a glass pane without tearing the foil (albeit most burglars don't go in for such delicacy). The real problem with the foil is that it's relatively frail and prone to cause false alarms in the course of normal wear.

### ...& More Alarms

**I**N A LOWER PRICE RANGE than hard-wired systems are interior space alarms, which do not require special wiring. These include ultrasonic motion detectors, infrared sensors for motion, microwave motion detectors, and infrared sensors for heat. The disadvantage of these systems is that they can be set off accidentally in a myriad of ways.

PETS CAN SET OFF ultrasonic detectors. Microwave detectors go through walls, and so can be activated by innocent neighbors. Infrared sensors have problems with radiators, hot panes of glass in sunny windows, and so on. The best of the infrared monitors can distinguish between gradual and sudden differences in heat and so will not be set off by a radiator--but they may give a false alarm if a hot air system is used. In general, even though devices that monitor interior space may be effectively integrated into a wider security system, the homeowner who buys one in the hope of getting good, affordable security often gets more problems than protection.

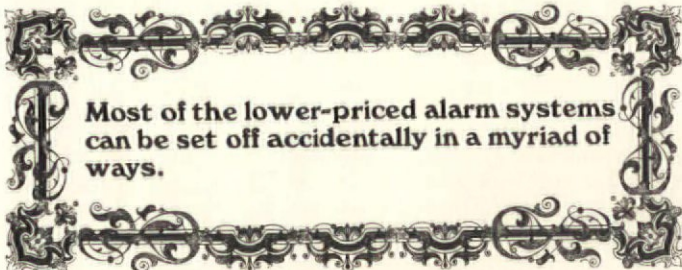

**Most of the lower-priced alarm systems can be set off accidentally in a myriad of ways.**

THERE ARE ALSO SYSTEMS that offer perimeter security without elaborate wiring. One of these is Perim-A-Tron. It includes, for windows and doors, magnetic sensors with radio-wave transmitters, a central control unit and monitor, and an alarm horn. The price is reasonable: less than \$300 for the average home. At one company that offers this system, Restoration Works, Inc.,<sup>3</sup> in Buffalo, New York, the president of the company has installed it in her own home. It has also been widely advertised by the Shelburne Company<sup>4</sup> in Owings Mills, Maryland. (The product representative there said that a garage-door activator might cause a problem for the system. Run it in test mode for a week or so when you're at home--any problem can be solved by re-encoding the signal.)

IF YOU FEEL THAT YOU MUST HAVE comprehensive alarm protection, then one company to look at

<sup>3</sup>Restoration Works, Inc., 412½ Virginia Street, Buffalo, NY 14201. (716) 881-1159.

<sup>4</sup>The Shelburne Company, 110 Painters Mill Road, Owings Mills, MD 21117. (301) 363-4304.

is the American District Telegraph Company<sup>5</sup>. The largest electronic-protection enterprise in the country, it works not only with homeowners but with institutions such as the U.S. Mint. A.D.T. has introduced a new system called the 75-80, which combines anti-crime and anti-fire protection. In some communities it offers manned response as well as a central station answering-and-relay service. (The A.D.T. men who come to your home will try to re-secure it if a burglary has taken place and will try to locate you or a friend. The cost for this extra service is about \$200 per year plus a fee for each response.)

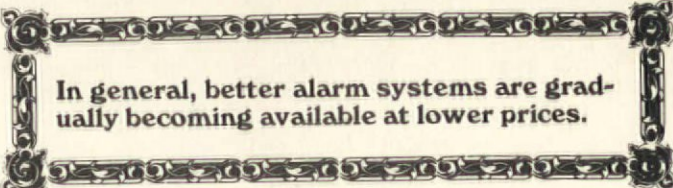

**In general, better alarm systems are gradually becoming available at lower prices.**

THE PRICE OF THE 75-80 SYSTEM varies widely, depending upon the needs of the individual homeowner, but it usually comes out to about 1 to 2 percent of the market value of the house. This cost, believe it or not, represents a slight reduction in price, which raises the point that in general better alarm systems are gradually becoming available at lower prices. So if you don't absolutely need an alarm system at this moment, it would be wise to postpone getting one.

MANY SECURITY EXPERTS do not give high marks to most alarms, except to some of the highest-priced systems. An alarm with prominently-posted decals is certainly a deterrent to a degree, and may well be indicated in some situations (such as fire-escape windows or certain parlor-floor windows where you don't want to put up bars). An alarm system can also give you peace of mind, which is priceless. But do not rely on an alarm to take the place of basic security features--good locks, sound doors, bars where necessary, etc. Keep the bad guys out in the first place. 

MARGARET MINER is a free-lance writer, an editor, the author of a book on interior design, and an old-house owner in Brooklyn. She claims that in writing this article she learned a lot--particularly about all the things that are wrong with her own house and the houses of her neighbors.

Ms. Miner extends her thanks to the following people: Joseph Fiebigler, Victor Kimmelman, Frank Mahon, Jennifer Pelapat, Pedro Rosario, and Chas. Weich & Sons.

<sup>5</sup>American District Telegraph Company, 1 World Trade Center, New York, NY 10048. (212) 558-1100.

# Ask OHJ

## Cracked Chimney

**T**HE CHIMNEY in my 1888 Victorian home is full of cracks. In the attic I can see that it tilts slightly and has been smeared with cement there and above the roof line. I'm sure that the entire chimney and fireplace have to be rebuilt, but I don't know where to start. Any leads?

--Leonora Thomas Los Angeles, CA

**A**LICENSED chimney sweep or the local fire marshal would be the first person to contact for a safety inspection. A professional sweep will also assess the structural condition of your chimney. (Look in the Yellow Pages under "Chimney Cleaning.")

IF THE CHIMNEY is structurally sound, all that may be needed is a flue liner. There are several varieties on the market, either clay or metal. In the meantime DON'T USE your fireplace until you're sure your chimney is clean and safe. A chimney fire is the last thing you need.

## Stain On Plaster

**I** UNDERSTAND that Frank Lloyd Wright used stain on plaster walls. What would be the advantages or disadvantages of putting stain instead of paint on plaster?

--Helen Dietz Oak Park, IL

**P**LASTER IS A POROUS MATERIAL. Stain alone, without a protective coat of varnish or sealer, will certainly soil faster and be harder to clean than a painted wall; an oil-based stain will accumulate even more dirt. Still, when properly protected with a washable coating, stain might produce a pleasant effect, although never having tried it, we would imagine that it could be hard to achieve an even tone. Of course, having once stained the wall, your only options, should you want to change the color, are to tint it darker or paint over.

## Salvaging Floorboards

**H**AVE YOU ANY TIPS on how to remove tongue-and-groove floorboards so as to salvage as many as possible for reuse?

--G. M. Lambson Hoboken, NJ

**O**UR MARCH 1981 issue has an article on the removal and repair of damaged floorboards. To remove an entire area of floor, first carefully remove the baseboards around the edges of the room. Then it should be possible to start at one wall and remove the boards in the opposite order that they were laid in, prying gently on the tongue side, where they are nailed. If it's impossible to start at the wall in this way, you will have to cut the tongue of one board. Use either a regular chisel or a thinner "flooring" chisel (to avoid damaging the edges of the board) for oak floors, a good stiff putty knife for pine boards. Then proceed as before with the rest of the boards.

## Banned Insulation

**O**UR 1911 STUCCO HOUSE was insulated by the previous owners with the urea-formaldehyde foam, which is now banned in our state. We are concerned about the possible adverse health effects and are investigating methods of removing the substance. Do you have any suggestions or recommendations?

--M. Faith & V. Curtis Pittsfield, MA

**F**IRST DECIDE if the urea-formaldehyde foam insulation cured properly. If there is no smell and no leaching, then probably no health hazard exists and you'd be wise to leave it alone. If you're not sure whether the foam cured properly, take samples from various walls and have them tested at a chemical laboratory.

IF YOU LEAVE the foam insulation in the wall cavities, be sure the INTERIOR wall is well sealed. Use caulk, foam gaskets behind the wall plates, and perhaps a vapor-barrier paint. This will cut down on moisture migrating into the wall cavity, where it can cause serious condensation problems. If improperly cured, the foam has to come out. Sometimes a contractor can remove it with suction--otherwise the interior or exterior wall must be removed to take the foam out. Because your house is stucco, you would remove the interior wall. You can also install vents at the top and bottom--outside--of insulated walls to ventilate the cavity.

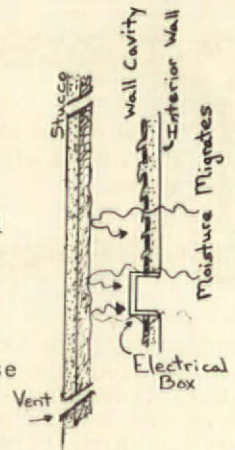

## Do You Have Questions for OHJ?

Send your questions with pictures or drawings, if possible. (We prefer black & white photographs.) We cannot promise to answer all questions personally, although we will try to answer all questions from current subscriber/members. Questions of general interest will be answered in print. Write: Questions Editor, Old-House Journal, 69A Seventh Avenue, Brooklyn, NY 11217.