



The Old-House Journal

Lattice Work

by Larry Jones

PAIINTED wood lattice is most familiar as the screen under an old porch. It's also found under exterior stairways, and as privacy screening and shading for sleeping porches. Most romantically, perhaps, lattice work is associated with gazebos and other ornamental structures.

BENEATH a porch, it has a very practical value: Lattice allows air to circulate while it provides a visual screen. Extending nearly to the ground, lattice is admittedly fragile and decay-prone. Periodic painting is a necessity -- and still it won't last forever. But whether it's plain or fancy, there's no denying its decorative appeal. Lattice can even mask unsightly intrusions such as garbage cans and air conditioning equipment. And it's not hard to make.

continued on next page



A RESTORATION LOVE AFFAIR.....	197
RESCUING OLD PLASTER.....	200
ASK OHJ.....	202
THE STORY OF ANGLO-JAPANESE MANIA.....	203
RESTORER'S NOTEBOOK.....	207

WHAT TO DO WITH A CISTERN.....	208
RESTORATION PRODUCTS.....	212
DEATH BY REMUDDLING.....	214

In the next issue...
GLAZING PLASTER WALLS

Editor

Patricia Poore

Assistant Editor

Cole Gagne

Assistant Editor/Products

Joni Monnich

Contributing Editors

Larry Jones

John Mark Garrison

Roland A. Labine Sr.

Architectural Consultant

Jonathan Poore

Technical Consultant

Alan D. Keiser

Circulation Supervisor

Joan O'Reilly

Circulation Assistants

Peggy Scaglione

Barbara Bugg

Jeanne Baldwin

Office Assistant

Rafael Madera

Production Secretary

Deborah Litt

Publishing Consultant

Paul T. McLoughlin

Publisher

Clem Labine

Published by The Old-House Journal Corporation, 69A Seventh Avenue, Brooklyn, New York 11217. Telephone (212) 636-4514. Subscriptions \$16 per year in U.S., \$20 per year in Canada (payable in U.S. funds). Published ten times per year. Contents are fully protected by copyright and must not be reproduced in any manner whatsoever without specific permission in writing from the Editor.

We are happy to accept editorial contributions to The Old-House Journal. Query letters that include an outline of the proposed article are preferred. All manuscripts will be reviewed, and returned if unacceptable. However, we cannot be responsible for non-receipt or loss — please keep copies of all materials sent.

Printed at Photo Comp Press,
New York City

ISSN: 0094-0178

NO PAID ADVERTISING

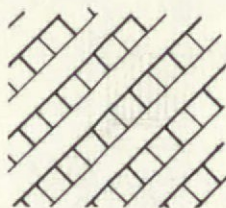

45-Degree Lattice

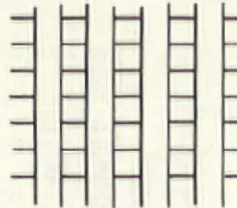

90-Degree Lattice

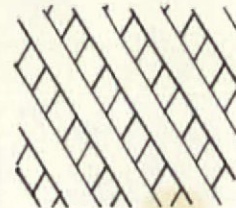

60-Degree Lattice

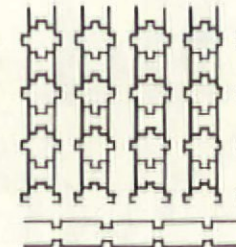
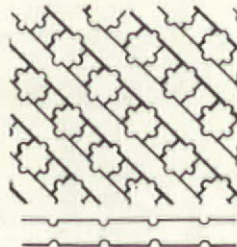
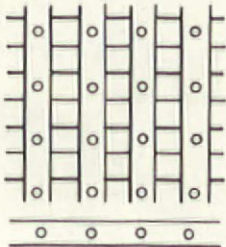

IF YOURS IS MISSING or deteriorated, you'll be happy to learn that making wood lattice is easy and inexpensive, if you do it yourself. On these pages, not only will you learn how to make good-looking lattice that will last a while, but you'll also see some examples of unusual decorative lattice designs.

Detective Work Closely examine areas you think might have been enclosed with lattice. Look for remnants of old lattice work and evidence of mounting locations.

AN OLD PHOTO of your house or others like it in your area will help you determine what lattice work you might have had, its design, and probable location.

Pick A Design -- a design that's appropriate or original to the period and style of your house. Avoid designs that are too ornate for the house.

CHANGES IN GRADE along the run of the lattice will affect the design and must be planned for.

PLAN FOR an inconspicuous access door in the lattice to allow for inspection of the enclosed space.

MOST LATTICE runs diagonally at a 45-degree angle, less commonly at 60- and 90-degrees.

SKETCHES--better yet, measured drawings--are the best way to see what the lattice will look like before you build. Measure off the existing openings and their surroundings, and make drawings at a convenient scale, say, one inch equals one foot.

Choosing The Timber Lattice, like lath, was made from pine (yellow or white), spruce, fir, redwood, or other soft knot-free wood. The standard size is 5/16-in.x1½-in.x4-ft., packed in bundles. Longer strips can be made by ripping 2x4s of the desired lengths. Plaster lath is available at most lumber yards...and is cheap.

FRAMING LUMBER TO RESIST DECAY should be Wolmanized, pressure treated, or redwood. Trim pieces should be clear pine, preservative treated for long life. Non-toxic preservative or waterproofer should be used on all non-factory treated lumber.

The Site Soil builds up around porches over the years, altering the original grade. You may wish to lower and recontour the area before designing lattice.

POOR DRAINAGE can be improved with good guttering and proper sloping of the soil. Avoid letting water splash onto lattice.

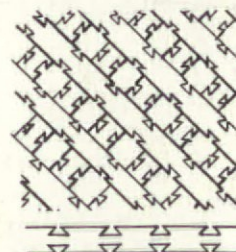
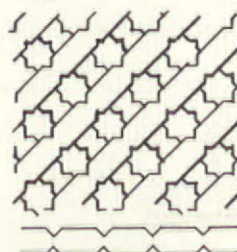
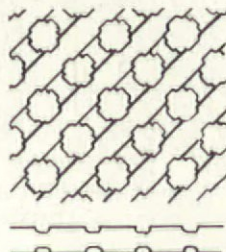

Framing The Enclosure Follow the original framing design, if part of it remains.

NO WOOD should be within 3 in. of the soil. Gravel laid over plastic film forms a good underlayment and moisture barrier under porches and lattice.

TO ENSURE A STURDY bottom rail, support it every 3 or 4 ft., or diagonally brace it from behind.

LATTICE doesn't have to be nailed to the face of the framing. It can be screwed into place. This allows for easy removal of damaged lattice from the frame, repairs, and any future repainting.

FRAMING JOINTS can be sealed tightly with exterior construction adhesive or polysulfide caulk.

A STURDY, HINGED access door should swing out on heavy, outdoor hardware. Mortise and tenon joints are best for the door.

The Lattice Work CAUTION: The ready-made lattice panels available at local lumber yards are much too thin and fragile, and are the wrong size for use on Victorian houses.

LATTICE STRIPS up to 2-in. wide are occasionally seen on larger buildings, but the 1½-in. width is the most common size.

DESIGNS CAN BE CUT INTO a number of lattice strips at once by clamping them together, marking and making repeated cuts.

A TABLE SAW, radial arm saw, hand saw, back saw, or even a router can be used to cut the desired design into the strips.

SAND LATTICE STRIPS to the desired smoothness and cut to the appropriate length. Sand edges of the strips while they are still clamped together.

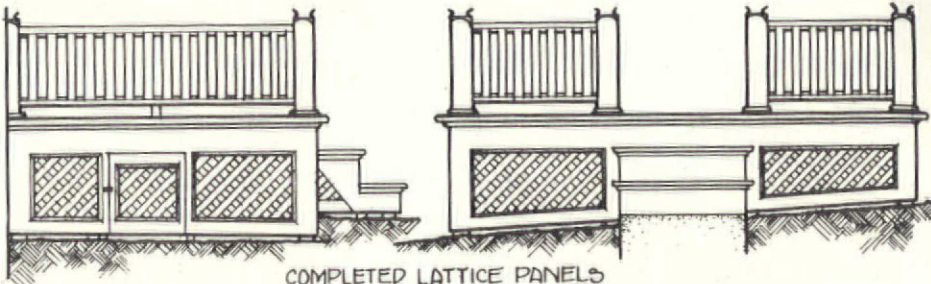

COMPLETED LATTICE PANELS

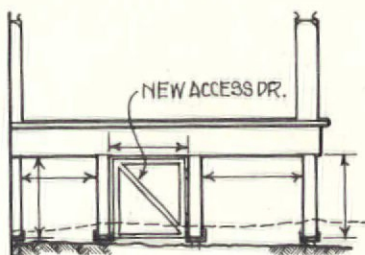

SIDE ELEVATION

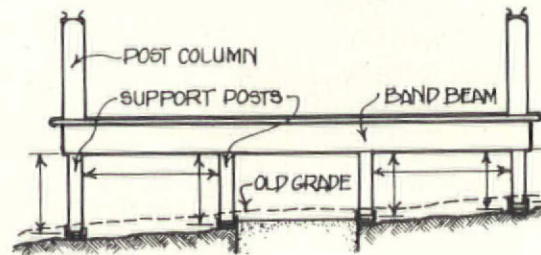

FRONT ELEVATION

MEASURE EXISTING OPENINGS

WOODEN, ROUND-HEAD PLUGS can be added to lattice intersections for decoration. Rust-resistant screws, attached from the back side to every third intersection of the lattice, will considerably strengthen the panel.

FOR LONGEST PAINT LIFE and best protection, apply two top coats of paint to the lattice strips before nailing them onto the frame. (Lattice is murder to paint when it's in place.)

TRIM PIECES are best cut to size, treated, primed, and given a top coat of paint prior to assembly. Once in place, fill all the joints, sand, and apply the final top coat of paint.

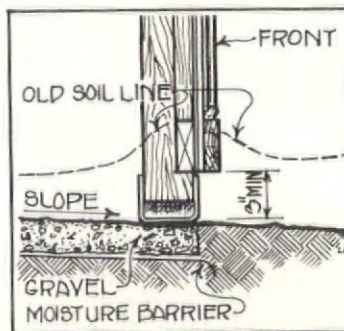

Preservative & Painting Dip-treat all lattice pieces in non-toxic preservative or water-proofer for 3 to 10 min. and allow to dry 24 hours. (Old guttering with capped ends makes a good dip trough.)

PRIME ALL SIDES of the lattice. Use a brush; don't spray paint.

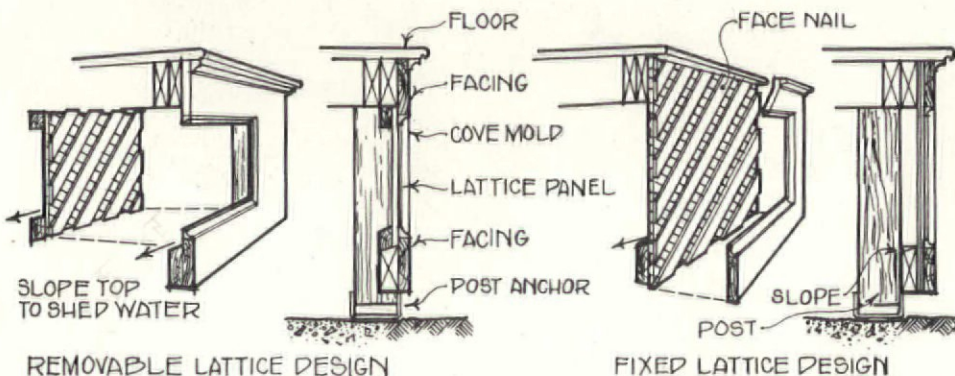
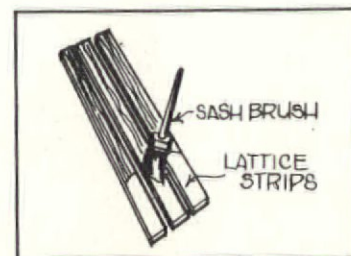
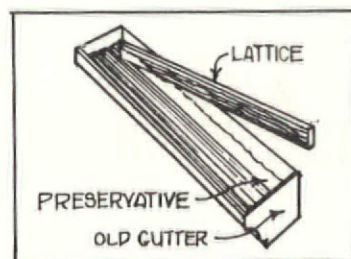

LATTICE IS OFTEN set off from the facing and trim by being painted a different color or shade of the same color. To accentuate the void and downplay the lattice screen, dark reds, greens, and black were commonly used. More ornate designs of lattice were usually painted light colors or white in order to make the decoration more readily visible.

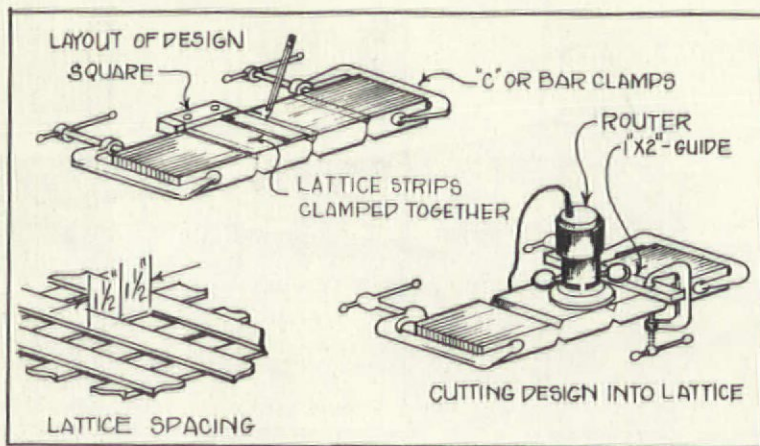

Installing Lattice Lattice is often hand nailed with galvanized nails. Care must be taken to avoid splitting the thin lattice when nailing.

THE TWO METHODS OF attachment are shown on page 195. Begin by attaching one strip at the right angle, then use a second one as a spacer to help accurately position the rest of the strips.

AN ADJUSTABLE BEVEL or triangle is handy for setting the first strip at the proper angle. Re-check the angle of the strips often as they are being nailed up. The angle is best set from a level surface, perhaps the porch floor or floor joist, or by using a long level.

LATTICE CONSISTS OF two layers, which must be properly spaced and aligned, especially with more decoratively cut lattice.

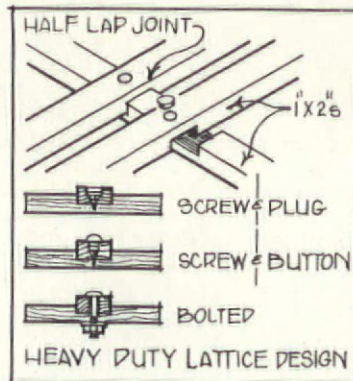

Maintenance Once all pieces are in place, make sure all joints are tightly sealed. Touch up any scratched or damaged paint.

DON'T FORGET MAINTENANCE: Wood can be expected to expand and contract, leaving joints open and in need of filling. Correct any moisture and paint-peeling problems as they occur. Twice a year set time aside for making thorough inspections of porches and lattice work, making sure to clean away dirt and debris.

LAST, avoid letting soil or shrubbery come in contact with the wood. If you maintain it, lattice work will last a very long time.

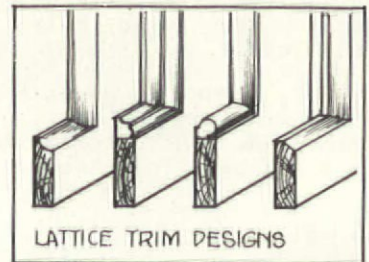

Front page photo is of the Best/Cannon House in Salt Lake City, Utah, owned by Mrs. Phyllis Stringfellow. It was a recent rehabilitation project assisted by The Neighborhood Housing Services of Salt Lake City. Photo is courtesy of The Utah State Historical Society.



Severe structural problems, not to mention the missing lattice work, had befallen the Best/Cannon House prior to its rehabilitation. Note the newly installed concrete foundation that replaced a collapsing brick one.



Here is the same porch after rehabilitation; the new lattice is installed back in its original position below porch and steps. Note how the concrete foundation has been clad with brick to resemble its original appearance.



The verandah on this house in Logan, Utah, shows how lattice could be curved to suit the building's requirements. Wood screws were used at the lattice intersections to join the front layer with the back one.



A Love Affair With Restoration

Old-House Living In Sherborn, Massachusetts

By Patricia & Richard Bates

THROUGHOUT our married life, we have continually "upgraded" to an older house. We began with a new home, then a seven-year-old town-house and a 1940 Cape Cod, all in the Midwest; a 1935 "Colonial" in New York; and finally an 1848 Greek Revival and an 1810 expanded farm cottage, both in Massachusetts. Each succeeding home was also an improvement to our lifestyle. In 1982, a friend bought a 56-acre estate and offered to sell us a 4½-acre portion. We jumped at the chance, bought the land, and commenced planning our "new" home.

THE ONLY THINGS we never cared for in old-house living were the poor locations; poor wiring, insulation, heating, etc.; and poor basement and foundations. We toyed with the idea of moving a house--this had been done recently in our town. But this approach wouldn't solve the insulation and wiring problems, and was too restrictive in our choice of houses. But disassembled houses can come from almost anywhere, and wiring and insulation could easily be attended to during reassembly. This way, we could achieve the best of both worlds: an antique house with the benefits of a new one.

WE SETTLED ON an 1830, nine-room, center-hall Cape Cod, originally built in Connecticut as the home of the owner of one of the town mills. This elegant house had been dismantled and was slated for a nearby museum village. Their project, a mill village, was cancelled, thus enabling us to buy the house. Much documentation accompanied it, including a study linking the house to the noted Providence architect-builder, John Holden Greene.

MEANWHILE, in January of 1983, we came upon another house: a two-storey, 12-room, center-chimney Georgian farmhouse. We later learned that it was built around 1790 by the Mendon, Mass., selectman, Moses Daniels. It remained in his family for a hundred years, and had been neglected for only the last ten years. Asphalt siding now covered the entire house, and the roof and all systems needed much attention. It had been abandoned for two years and was besieged by vagrants, vandals, and the weather. It was now or never for this once-magnificent house: It would soon be vandalized to death if no one stepped in to save it.

WE QUICKLY EVALUATED whether we could save the house by working it into our project. Its greater size and farmhouse design actually fitted our land better than our first house did. The museum house's pedigree and documentation would facilitate its resale, so we decided to change houses in mid-stream.



In the upper left corner of this page, you see the house the same way Patricia and Richard saw it in January of 1983. The upper right shows the same house some nine months later -- not yet completed, but definitely well on the way. The photo above shows the house in May of '83, just after it was reassembled on the Bates' property.

DISMANTLING our new house was an interesting phase of the project, as it involved opening walls that hadn't been disturbed since the house was built. Few artifacts were found, but many interesting structural surprises were uncovered. Remuddlings had eliminated the side door and hall to make a bedroom. Also, the front door pediment had been discarded to make way for a screened porch.

REPLACING the discarded items was difficult but rewarding. After seeing a 1905 photo of the house, we decided to reproduce the front door pediment. A replacement for the side door

frame was retrieved from a long-abandoned house in northern Vermont. Its acquisition is a story all by itself.

YOU'D THINK that a frame with triangular pediment and five-pane rectangular transom would be easily located, but calls and visits to all the normal (and even abnormal) sources turned up nothing. In March, while returning early from a day at the ski slopes, we chose a seldom-traveled back road. Suddenly, some 500 yards from the road, we spied a very old abandoned house. Curiosity got the best of us, and when we got to the front side of this caving-in pile of wood, we discovered our exact door frame--perhaps the only salvageable item in the whole structure. With some difficulty we found the owner, and after many conversations purchased the door. We traveled 400 miles and brought it back in our trailer.



That's a Vermont door frame on the side of this Massachusetts house. Pictured at right is Patricia Bates, posing with the frame prior to its installation.

FOR THE MOST PART, our house was complete. Many non-essentials were destroyed or removed, but all the exquisite interior woodwork was intact. In fact, we estimate that at least 90% of the original wood was used in our reconstruction. The house greatly exceeded our original estimates in both its complexity of construction and the sheer volume of material that it had.

THE WALLS separating the front half of the house from the rear, as well as all exterior walls, used 3x3 studs (3x5 at doors and windows) on 13-in. centers. Bracing of posts (with 3x3 braces) was enclosed in all of these studded walls. Second-floor joists were finished and pegged into their girts at both ends, presumably to insure that exterior walls would never bow outward. The house was so overbuilt that two corner posts completely deteriorated over the years, but created no discernible sags!

A CREW of about six men took some six weeks to number and remove, via semi-trailer, every piece of wood in the structure. The house slowly melted away until all that remained was a cellar hole, a center chimney mass going up 1½ storeys, and a pile of debris.



Photo: Ted Dully

NEXT, WE BEGAN our most daring operation: moving the five fireplaces without disassembly. The two second-floor fireplaces were carefully, individually wrapped, as was the entire first-floor assembly of three fireplaces (one with "beehive" bake oven). Two I-beams were placed beneath the bed of 8x8s on which the chimney structure had originally been built. A 45-ton crane (we'd requested an 80-ton) moved next to the chimney brace and individually removed the upper fireboxes and placed them into trucks. The I-beams were then lifted by their ends, and slowly, with some cracking noises, the first-floor chimney mass rose from its 190-year resting place. It was placed on a flat-bed truck, and the fireplaces were all safely transported to the new site.



HOWEVER, when the crane attempted to move into position at the new location, it had to come so close to the foundation that there would be a danger to the wall. And the flat-bed now blocked the crane and couldn't be moved back up the hill and out of the way until its load was removed. This meant an extra handling of the chimney mass. A larger crane arrived the next day, located itself safely, and moved its load into position (within an inch) without loss of another brick. The chimney is now built up completely through the roof--flue liners and top dampers were used for safety and convenience. It now looks as if the chimney and fireplaces have been there for 190 years.



Upper Left: This photo, taken in 1905, shows the house in its original location in Mendon, Mass. Note the front door pediment; the contemporary reproduction was based on this picture.

Upper Right: This photo was taken even earlier, circa 1890. You can see the original side door frame, complete with five-pane, rectangular transom and triangular pediment. The salvaged door seen on the opposite page makes a perfect replacement, doesn't it?

Left: This is the house — now disassembled — which the Bates initially bought. But when they discovered the house pictured above, they purchased it and put this 1830 Cape Cod back on the market. Built for an important Connecticut businessman, the house was intended for a prominent street location, whereas the Massachusetts farmhouse was just right for the Bates' 4½-acre property. (Anyone interested in this disassembled house can find it in *The Emporium*, page 213B, first column.)

IN AN 1850 REMODELING, the fireplaces original to both ell rooms were removed. We had them reconstructed, using the floor framing and the original second-floor mantel as guides. Another fireplace was installed in the ell basement, at the base of the chimney structure. A new roof of red cedar shingles was also installed, and new sash were fabricated as required. A DuPont air-infiltration barrier, "Tyvek," was installed between sheathing and clapboards, and all clapboards have been back-primed for longer paint life. Insulation depths are controlled by joist and stud thickness, and will be six inches in the second-floor ceiling, and 3½ inches in outside walls.

WE INTEND to do more of this work. We love the houses constructed by our forefathers. Some are now disguised and forgotten. Yet many of these houses have retained enough original characteristics to be worthy of restoration, and can allow families to enjoy the charm and grace of the old with modern convenience and comfort. We will search out and match them with the enthusiastic owners they so desperately need. Our commitment is to preserve the heritage of New England's built environment. 🏠

WE LEARNED QUITE A BIT from this project. Surprisingly, 190-year-old oak that has always been kept dry isn't immune to warping. Our carpenter didn't realize this and allowed many structural parts to remain wet for an unnecessarily long time. Adequately protecting the wood would have been cheaper and simpler than coping with the line-up problems that we had during reassembly.

THE USE OF CAPSTONES on the top of a poured-concrete foundation apparently so confused our foundation man that his first pour was 1½ feet low; we had to put a second pour on top to get the desired level. We were able to save enough clapboards to completely resurface the front of the house. This will make the house look older, but it's certainly not cost-effective against the use of all new clapboards. Lastly, because of the high costs involved once woodwork is back in place, we're convinced that paint should be stripped between disassembly and reassembly.



Seen from the back, the Bates' house has gracefully adapted to its new location. Here, the ground slopes from front to back, so the basement was expanded to conform to the terrain.

WAIT! Don't tear out old plaster just because of a few holes and cracks.

There are all sorts of ways to save old ceilings and walls. Without hiring an old-world plasterer, you can avoid redoing your rooms in gypsum wallboard. All it takes is knowing what tricks other preservationists use. This introductory article outlines the secrets of economical plaster repair. Methods here pertain to flat plaster only, not to cast or moulded ornamental plasterwork.

What Can You Save And Why Bother?

ASK MOST CONTRACTORS and remodellers, and you will be counselled to rip out less-than-perfect plaster to install gypsum wallboard. (Gypsum wallboard is a prefabricated, paper-faced plasterboard. It's also called drywall, wallboard, gyp-rock, gyp-board; in the East and elsewhere, its most common name is Sheetrock -- U.S. Gypsum's trade name.)

A MUCH BETTER IDEA is to save as much old plaster as possible, for very practical reasons. Patching is much cheaper than wholesale demolition and replacement with drywall. Also, real plaster walls are stronger and more soundproof than wallboard. And old plaster has a handmade, slightly wavy, slightly textured surface which contributes to the character of an old house. Drywall is perfectly flat and angular.

WITH THE PROCEDURES introduced here, you can save all the sound plaster. But no miracle product or process can rescue plaster that was poorly formulated, crumbling, or damaged by a water leak. Fortunately, bad plaster seldom covers an entire room, or even an entire wall: Patching is the answer. It's possible to get rid of bad areas and still keep most of the old surface intact.

Common Problems Have Common Solutions

PROOF THAT most plaster problems have simple solutions: Outlined below are proven techniques for common problems that homeowners often tackle themselves. In upcoming articles, we'll offer step-by-step instructions for some of these jobs.

HAIRLINE CRACKS are often cyclical: They'll come back to haunt you with the changing of the seasons. Rather than digging them out and filling with a rigid plaster, it's better to tape them, feathering with joint compound. A fiberglass mesh tape is available; it "moves" more than the paper tape can.

LARGER CRACKS are often stable in old buildings. You can tape them if they're straight. Long, spidery cracks should probably be dug out and filled with patching plaster. (If the crack is new or growing, find out what's causing it before you patch. Get help from an architect or structural engineer.)

Old-House Basics...

What's Possible In

HOLES LESS THAN 4 INCHES in diameter can be filled with patching plaster, or StructoLite with finish coats of joint compound.

MISSING PLASTER (and holes over 4 inches): Square up the damaged section so you can cut a close-fitting patch from Sheetrock. Tape as you would a Sheetrock seam.

CRUMBLING OR WET PLASTER will never "re-cure." Remove damaged plaster only, back to sound material at a stud or joist. Secure surrounding sound plaster with washers if necessary; make a Sheetrock patch.

IF PREVIOUS PATCHES were done poorly (or if you're stuck with a bad taping job), you can sometimes just add joint compound and feather the edges more carefully. (This works to fix depressions or a messy tape edge.) Otherwise, you'll have to pull the bad work apart and repatch or retape the area.

FOR A ROUGH SURFACE: If the plaster is sound and the finish coat is bonded to the brown coat of plaster beneath it, you might get away with skim-coating the rough surface with a thin layer of joint compound. Alternately, consider canvassing the plaster before papering or painting.

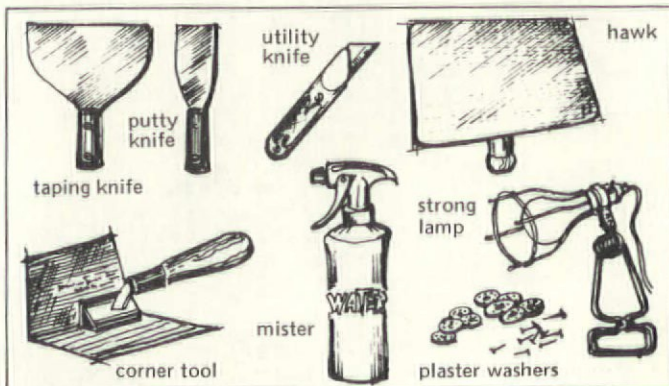

ALLIGATORING PAINT LAYERS comprise, unfortunately, an unsound substrate. It's tempting to try to fill the "alligator skin" with joint compound. But experience shows that this technique is good for about six months. You have only two choices: Strip the paint down to bare plaster, or -- if the paint layers are well stuck -- canvas the walls or ceiling.

IS THE FINISH COAT FALLING OFF the brown coat? (The finish coat is the fine, white, thin top coat of plaster.) Small missing sections can sometimes be patched in with joint compound. Finish plastering over an old brown coat occasionally fails because the new plaster doesn't bond to the dry old substrate, even if you wet it down. If such a patch fails on you, you'll have to take the plaster down to lath. Then patch with plaster or Sheetrock.

Plaster Restoration

BOWED PLASTER is the toughest problem. But even bowed plaster can be salvaged as long as the plaster itself has integrity. Plaster washers are the answer. If plaster and lath have together separated from the structure, long wood screws will go through lath into studs or joists.

Three Plaster Restoration Secrets

THE SOMEWHAT ad-hoc techniques of plaster restoration are not the usual domain of drywallers, nor are they a regular part of the plastering trade. But these techniques could hardly be labelled "fudging it," because the three basic methods below are established, appropriate, and unobtrusive. They're also inexpensive and they work.

Plaster Washers

ONCE COMMON and now nearly extinct, these unassuming little discs have saved countless ceilings for OHJ subscribers since we first wrote about them in October, 1980. We learned about them from John O. Curtis, curator at Old Sturbridge Village, where an effort is made to save as much original plaster as possible. Used with a wood screw, the plaster washer assembly pulls bowed plaster back up tight to the lath or structural framing.

PLASTER WASHERS are handy in these circumstances: (1) Essentially sound plaster has lost its keys and is floating away from the lath. (2) A sound plaster-and-lath section is no longer attached to studs or joists. (Bowed plaster will give when you press on it.) (3) The remaining plaster around a hole needs extra support and anchorage before you patch the hole. (4) Washers can be used across a crack to draw the broken plaster back up tight to the stud or joist.

PLASTER WASHERS are easy to install. The hardest part is finding them. (If you have trouble locally, order from Charles Street Supply Co., 54 Charles St., Dept OHJ, Boston, MA 02114. 617-367-9046. Min. order 3 doz.; \$1.25/doz. ppd.)

Drywall & Tape

AT STURBRIDGE, missing areas are patch plastered. But for non-plasterers, an easier alternative is to make a Sheetrock patch. Bad

plaster is removed. Then the hole is squared up so that a neat patch can be cut from Sheetrock to fit the hole. If you take your time cutting the patch, shimming it level, and taping the edges, the patch is invisible.

USE A SHEETROCK PATCH in a plaster ceiling or wall: (1) When the diameter of the hole

is more than 4 inches. (2) When you can cut the plaster back to studs or joists, to give yourself something to which you can nail or screw the patch. Smaller holes are best patched with a commercial patching plaster.

PAPER JOINT TAPE is readily available. You can also buy joint tape made of fiberglass mesh. The fiberglass tape costs more, but this difference doesn't matter much because you'll be using so little of it. The advantage of fiberglass tape is that it's more flexible; if a crack recurs, use fiberglass tape. Its disadvantage is that it's about twice as thick as paper, so it requires greater finesse to make unnoticeable feathered edges.

JOINT TAPE -- used to tape joints between sections of Sheetrock -- can also be used to mend cracks. Taping a crack allows some movement without the crack reopening. Treat the crack the way you would a seam in drywalling.

Canvas

COVERING PLASTER with canvas is not a "cover-up." Actually, it's a centuries-old practice designed to protect fancy finishes from inevitable hairline cracking. Besides protecting your wall finish from future cracking, canvas will also hide cracks from the past.

WALL CANVAS is applied to sound, fairly smooth, patched plaster. Use it: (1) Over slightly rough,

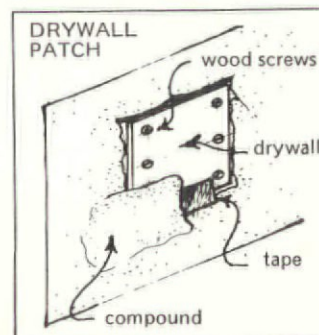
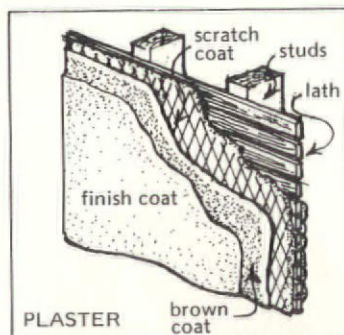

pebbly, or poorly patched surfaces. (2) Over walls with many paint layers or alligating. Canvas won't cover dents, holes, or grossly uneven patches, however, so you still have to do some stabilizing, patching, and feathering before you apply the canvas.

CANVAS COMES IN extra-wide rolls for fewer seams (and for expert hangers), or 27-inch rolls for smaller rooms (and novice hangers). It is available through most wallpaper stores and it's hung like heavy wallpaper.

NEXT MONTH
Step by step to the perfect drywall patch



Stripping A Tub

RECENTLY, I ACQUIRED a porcelain tub. The inside porcelain is in excellent condition. Outside, however, the tub has been painted a pale yellow, all the way down to its claw feet and balls. What is the easiest way to remove this old paint from the tub? After the paint is removed, would I need to protect the iron from rusting?

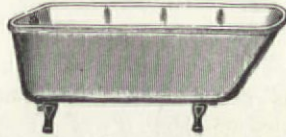

--Mary Jo Mette Montrose, Ill.

STRIPPING THE PAINT from the outside of your tub will be easy. A heat gun, chemical strippers, even a rotary stripper will all work efficiently. You'll have exposed the cast iron once you've finished, so you should immediately coat the exposed metal with a primer. The longer you delay priming, the longer oxygen and moisture can eat away at the metal. The next step is to repaint. Any good hardware store will sell you the right kind of paint for this job.

Paint On Paint

ISIGNED A CONTRACT for two coats of oil paint to be applied to the interior plaster and woodwork of an 1840 house. Someone goofed, and after the prime coat of oil paint was applied to the plaster walls, a second and probably a third coat of latex paint was put on. I'm told by both an architect at the Historic House division of the National Trust and a spokesperson at the Park Service that these two different paint systems are incompatible. They say the paint coats will be unstable and that streaking or pulling away will occur in a matter of time. Is there a remedy for this situation? What can we do to avoid disaster?

--Lee L. Prina Washington, D.C.

PLEASE DON'T WORRY about your paint job. You have been getting some very theoretical (as opposed to practical) advice, and it applies more to exterior painting than to interior.

THEORETICALLY SPEAKING, it's best to use the same kind of paint that's already on the substrate, especially outdoors where temperature differences are great and weathering occurs. But even outside, latex can be successfully applied over oil paint if the surface preparation prior to painting is well done, and if an oil or alkyd primer is used to create a bond between the old and new paints.

INDOORS, virtually all painters use latex on large surfaces such as plaster walls. It dries faster, releasing fewer harmful vapors into the house. (Pretty soon, it may be the only thing commonly available for house painting.) If the surface preparation before painting was good on your job--and especially because the prime coat was indeed oil--you should experience no

instability or streaking. In the future, problems with too many coats of paint (any kind of paint) will likely surface before problems with incompatible layers.

OUR RECOMMENDATION is to use oil or oil/alkyd paints on woodwork, because they impart a better gloss and are more durable than latex. But even if the painters used latex on your woodwork too, it's still not a disaster. The next time you repaint, go back to oil by first sanding all the woodwork well and then applying an alkyd primer coat.

Ventilating A Crawl Space

MY HOUSE has a cement-block foundation with some holes for ventilation, as well as some broken blocks and holes where pipes had been run through into the crawl space. Is it absolutely necessary to ventilate the crawl space with one or two open spaces?

--L. Stegbauer Decatur, Ind.

VENTILATION is unnecessary only when the crawl space is heated and the foundation walls are insulated. With an unheated crawl space, some ventilation is always required, but the amount can be greatly reduced by installing a polyethylene vapor barrier over the dirt floor. Without a vapor barrier, there should be at least four openings with a total area of 1/150th of the total floor area. With a vapor barrier, this can be reduced to a ratio of 1 to 1500, and the number of openings can be cut to two. You might also want to consider one of the number of available basement ventilators that are the size of a standard concrete block and have louvers and screening to keep out water and animals.

Calcimine Concerns

IT'S RUMORED that the ceilings of my 1930 house are calcimine. How can I know for sure, and what are the considerations for painting over calcimine?

--Suzanne Basalik Plymouth, Mass.

CALCIMINE PAINT is water soluble, so if the paint on your ceiling starts to come off just by scrubbing it with water, it's calcimine. If it is, you'll have to remove it should you want to repaint, because neither paint nor primer will really adhere to it. If it's old, and going at it with water is too slow, try adding some ammonia to speed things up. The October 1980 OHJ has more information on dealing with calcimine paint.

General interest questions from subscribers will be answered in print. The Editors can't promise to reply to all questions personally—but we try. Send your questions with sketches or photos to Questions Editor, The Old-House Journal, 69A Seventh Avenue, Brooklyn, NY 11217.

What Great International Style Was The Result Of American Gunboat Diplomacy?

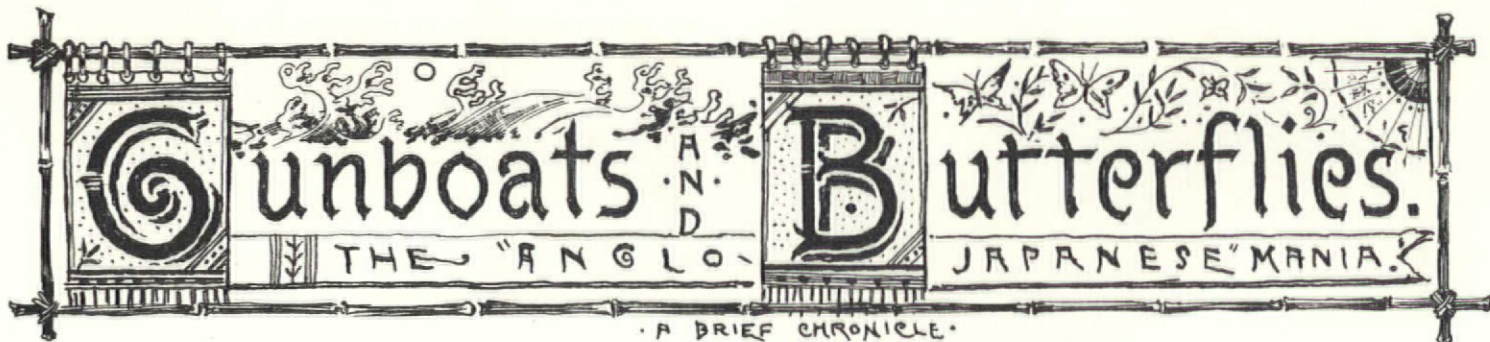

by Bruce Bradbury

IN 1853 U.S. ADMIRAL PERRY succeeded where Columbus had failed: Sailing westward, he reached the mysterious and impenetrable "Japans," and at the metaphorical barrel of a gun invited a recalcitrant Shogun to open the islands to world trade. America's initial trade advantage evaporated in the 1860s as the nation plunged into Civil War, and the first stirrings of a coming design revolution happened not in New York or Philadelphia, but in the fashionable drawing rooms of London.

Cradle Of Liberty's

JAPANESE PORCELAINS were displayed in London in 1862; a small but ardent group of cognoscenti began collecting Japanese ceramics. A story, perhaps apocryphal, tells how these porcelains arrived carefully wrapped in discarded woodblock prints by the great Japanese print masters Hokusai, Hiroshige, and Utamaro. The delicately tinted prints captivated the Europeans and created a secondary market -- not only for the prints themselves, but also for the fabrics and objects of daily use pictured in them. The famous London shop of Liberty's opened in 1875 to provide a wide selection of Japanese goods to an ever-widening circle of admirers. Articles of English manufacture "in the Anglo-Japanese style" became fashionable. The style was so named by one of its most brilliant practitioners, E.W. Godwin, to accurately describe the application of Japanese design to such Victorian necessities as bedsteads, armoires, dining-room sets, etc., which had no precedent in Japan. From the outset, the style was as much Anglo as it was Japanese: a Western fantasy of what Japan was like, or should be like.

Chemical Aftertaste

THE SEEDS OF THE JAPANESE STYLE fell on fertile ground, as England in the 1860s was in the formative stages of a major design revolution. Earlier in the century, the creation of bril-

liant new chemical dyes had set Europeans on an unrestrained color bash. The outrageously gaudy colors of mid-century are the result of the public reveling in a new technology. But by the 1860s, reaction was leading to renewed interest in natural dyes, re-created from medieval formularies by ardent anti-technologists such as William Morris. The soft natural tints in Japanese art meshed perfectly with this new English fascination with muted organic colors.

Geisha Gothic

AT THE SAME TIME, the lavish overwrought ornamentation of mid-century was giving way to the flat stylized ornament championed by Charles Eastlake and proponents of the Gothic Revival. The flat, stylized motifs of Japanese ornament combined in a curiously attractive way with their Gothic counterparts. The combination resulted in an exciting new style highlighted by daring asymmetrical arrangements of pattern -- a Japanese convention that amazed and delighted the Western eye. While the English were giving birth to a new art movement, Americans were still preoccupied by the Civil War and its aftermath; yet, in a strange way, they were being psychologically prepared for the craze to come.

Son Of Manifest Destiny

IT WAS A POPULARLY held Victorian view that Civilization moved inexorably Westward. Particularly attractive to 19th-century Americans who saw themselves as next in line when the torch was passed by Britannia. An American corollary had it that here, Civilization, which began its long march in Asia, would attain its final fulfillment with the combined genius of Europe flowing to our Atlantic shores and the ancient genius of Asia rekindled through our Pacific portals. Few proponents of this theory would have guessed that young America was to meet her Oriental Destiny at a birthday party.

Fun In Philadelphia

AMERICA CELEBRATED her centennial with a magnificent bash in Philadelphia, to which the world was invited. The Japanese arrived, for the first time not as personal representatives of the Emperor, but under the guidance of the ministry in charge of foreign trade and promotion. Their exhibit, which required 50 railway cars to carry it across country, included a bazaar where excited visitors bought up quantities of original Japanese articles. These exotic wares became status symbols of the late seventies, and a nationwide demand for similar objects was created among status-conscious Americans.

ACROSS THE FAIRGROUNDS, the crowds were also being wowed at the English pavilion. The aforementioned artistic revolution of the '60s had picked up steam throughout the '70s; by '76 the quality of English design and manufacture was second to none. Of course, the exhibit included avant-garde designs heavily influenced by the Japanese. American manufacturers' representatives, who swarmed over the fair, could pick up the raw ingredients of the new style at the Japanese pavilion, and sophisticated recipes for its use at the English pavilion. The result was an almost instantaneous appearance of the Anglo-Japanese style in America.

THE EFFECTS OF THE FAIR on American design were dramatic and permanent. The craze for anything Japanese grew in intensity. The easy combination of Japanese ornament with the newly popular "American Eastlake" style gave American manufacturers a bold new design vocabulary. Soon the classic Japanese motifs of butterflies, cranes, cherry blossoms, rushes, chrysanthemums began to appear on silver, glassware, hardware, lighting, tiles, fabrics ... practically every item of daily use. Furnishings of faux bamboo and ebonized wood were enthusiastically received by the public. There was Anglo-Japanese food (sukiyaki) and Anglo-Japanese musical entertainment (Gilbert & Sullivan's *Mikado*: later,

Puccini's *Madam Butterfly*). Typography was particularly influenced, and asymmetrical layouts became popular in American publications.

BY THE 1880S an appreciation of things Japanese became, in America, the universally accepted symbol of Taste and Refinement. Few homes with any pretension to culture could be found that didn't contain some prominent display of Japan wares. Cost was no barrier here, as a simple paper fan on the wall of a miner's shack carried the same unspoken connotation of good taste as did the elaborate Japanese parlors on Fifth Avenue.



Prairie Pavilions

AMERICAN understanding of Japanese architecture and art broadened with continued exposure. The exquisite Phoenix Villa, erected at the Chicago World's Fair in 1893,

stood in stark contrast to its Beaux Arts surroundings, and left a lasting impression on both Louis Sullivan and Frank Lloyd Wright. The bold horizontal elements of Japanese architecture were a catalyst in the transition of style from the late Queen Anne to the Prairie School. The clear stamp of Japan could be seen on the West Coast in the idealized California Bungalows of Greene and Greene; ultimate examples of a building style that soon spread across the country. In the brief span of forty years, the Japanese influence had become an intrinsic, inseparable element of the American way of life.



Adding Your Own Touch Of Anglo-Japanese

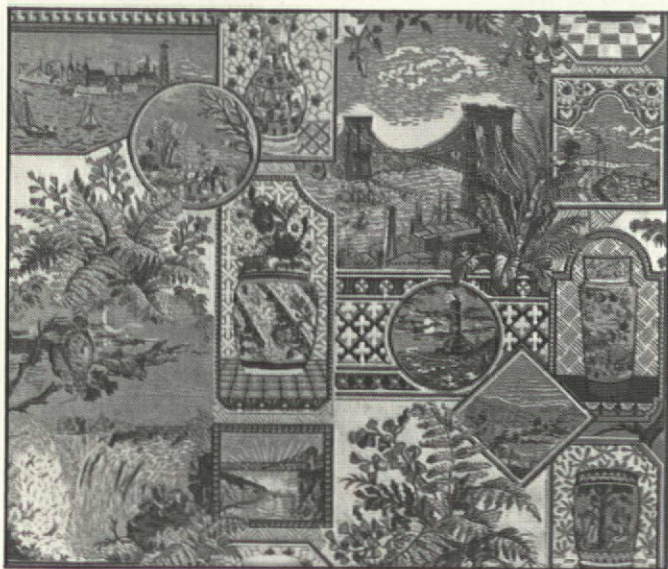

Japanese motifs and Western images, such as the Brooklyn Bridge and Niagara Falls, were often combined in Anglo-Japanese wallpapers.



RECREATING AN ANGLO-JAPANESE room is a liberating experience, for here at last is a historical style where fantasy triumphs over purism...and you don't need to spend a fortune to create a great effect!

I WENT DOWN to a local California import emporium, Cost Plus, and found a collection of bamboo furniture, rush matting, lacquerware, blue & white china, lanterns, fans, parasols that would have sent an 1880s American into aesthetic hyperspace. All this at prices to match any budget.

THERE WERE NO "SET" ROLES for rooms in the Anglo-Japanese style back in the 1880s. But you can use this simple checklist to help you create a room that's fun to live in as well as truly evocative of the style:

Walls & Ceilings Garish colors were out; muted shades of ochre, olive, and russet predominated, often in combination with metallic gold, umber, vellum-like shades of cream and

grey, and deep burgundy accents. Wallpaper was widely used in the popular dado/filling/frieze combination, sometimes combined with daring asymmetrical ceiling patterns. The ubiquitous wallpaper filling of the period featured small framed vignettes of Japanese or "oriental" objects, asymmetrically arranged, colored invariably in shades of dull olive often highlighted with gold. Embossed and gilded Japanese "leather" papers could also be found in upper-class homes. Woodwork was sometimes painted and then pinstriped; doors could be picked out in several shades of color, with the panels stencilled with bamboo or other Japanese motifs.

Floors Rush matting in imitation of tatami mats was popular, especially in the summer months. Eclecticism reigned however; "Oriental" rugs, real or imitation, were used to heighten the exoticism of a room.

Furniture Bamboo or ebonized furniture, often highlighted with gilt Eastlake incising, was most popular for the stylish Anglo-Japanese parlor. If you don't happen to have a room of such furniture sitting around, don't feel left out: Most practical Victorians made do with the furniture they already had, concentrating their efforts on other parts of the room.

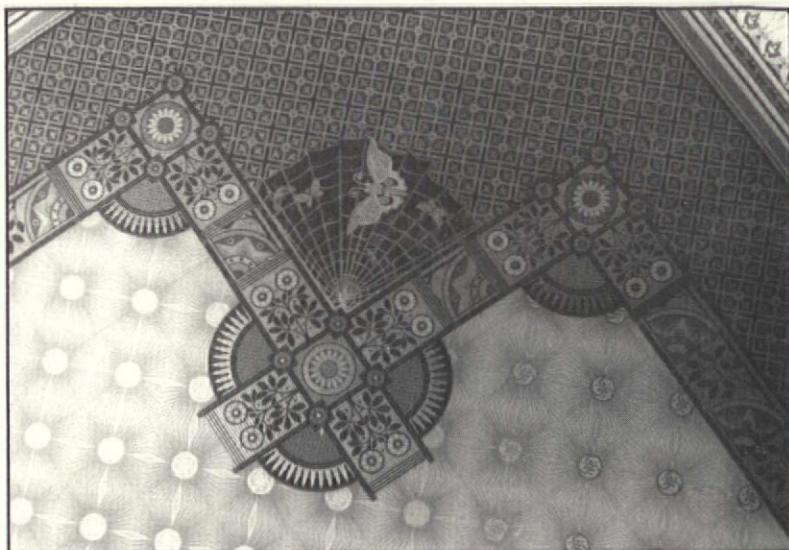

Photos on this and the following page were taken from the Anglo-Japanese parlor created by Tommi Veirs, an Interior Design Restoration Consultant in Alameda, Calif. (above) To emphasize the asymmetry of the five-sided parlor, Tommi 'pulled back' one corner and embellished it with decoupage wallpaper and a Japanese fantasy — this handpainted and gilded spider web. (below) Doorways were decorated with decoupage wallpaper.

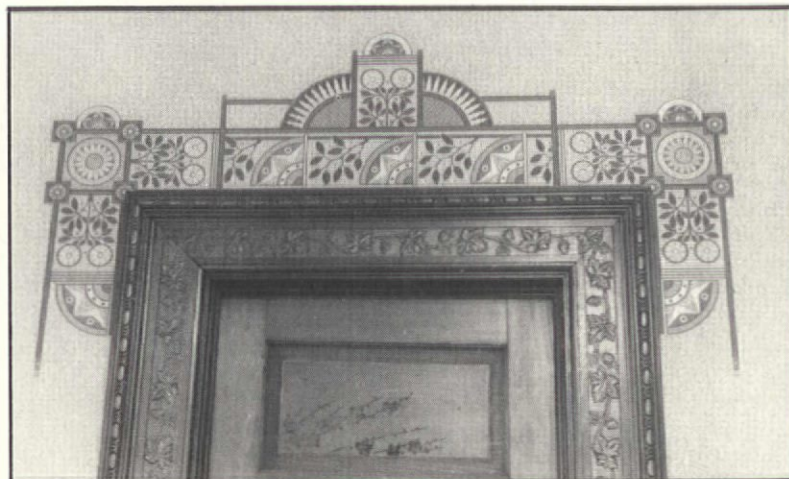

Inspired by Oriental blue and white china patterns, Tommi handpainted these designs on the doors.

Window Treatments This is the Anglo part of Anglo-Japanese. Shoji panels never seemed to have caught on, and the standard combination of roller shade (sometimes stencilled with Japanese motifs), lace curtains, overdrapes, and lambrequins predominated. Lambrequins were often "orientalized" for heightened effect. Many beautiful Anglo-Japanese designs were produced in both stained and etched glass.

Art No mere mania could separate the average American household from its cherished print collection of wide-eyed children, puppy dogs, and fluffy kittens, but these tended to peer out of ebonized frames with incised decoration. Of course a wide variety of prints of "oriental" subjects came onto the market in the '80s. The upper class proudly displayed their Japanese woodblock prints, scrolls, and screens. A folding screen was something of an ultimate object for the Anglo-Japanese parlor, and many Americanized versions were available.

Accoutrements Blue and white porcelain, which started the craze, often appeared on plate rails in dining rooms or arranged on shelves in parlors. Ornamental Japanese tiles appeared in fireplace fronts.



Hinges, doorknobs, and doorplates were scattered with bamboo and birds. Lacquerware was commonly on display in the parlor, along with cloisonne. A tasteful wall arrangement of paper fans is one of the most common decorations seen in 1880s interiors. Paper parasols were commonly used as fireplace screens during the summer months. And stuffed herons and cranes were silent sentinels of taste.

Lighting Immediately following the Centennial, gas and oil lamps complete with glass shades often etched with sparrows and bamboo. The traditional Japanese lantern was also used, but typically as a decorative accessory. Towards the end of the century, a more sophisticated lighting style emerged, as typified by Tiffany's Dragonfly and Wisteria lamps.

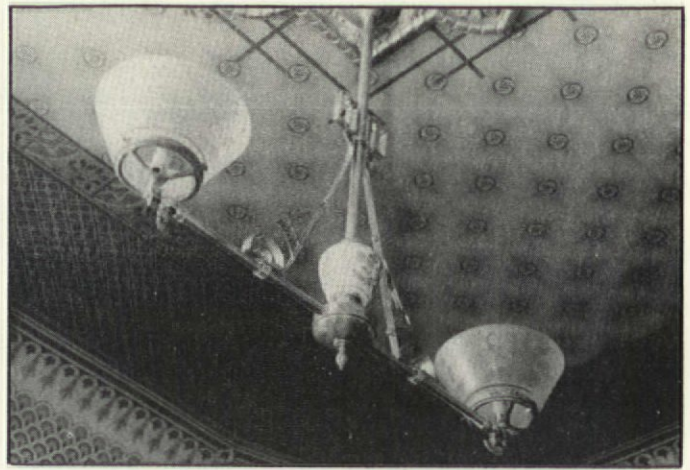

Glass shades were frequently etched with popular Anglo-Japanese motifs — cranes, cherry blossoms, etc.

The Author's fascination with Anglo-Japanese objects has, of course, manifested itself in his work: Recently added to his collection of late Victorian papers are several Anglo-Japanese wallpapers. Contact Bruce Bradbury at Bradbury and Bradbury Wallpapers, PO Box 155, Benicia, CA 94510. (707) 746-1900.

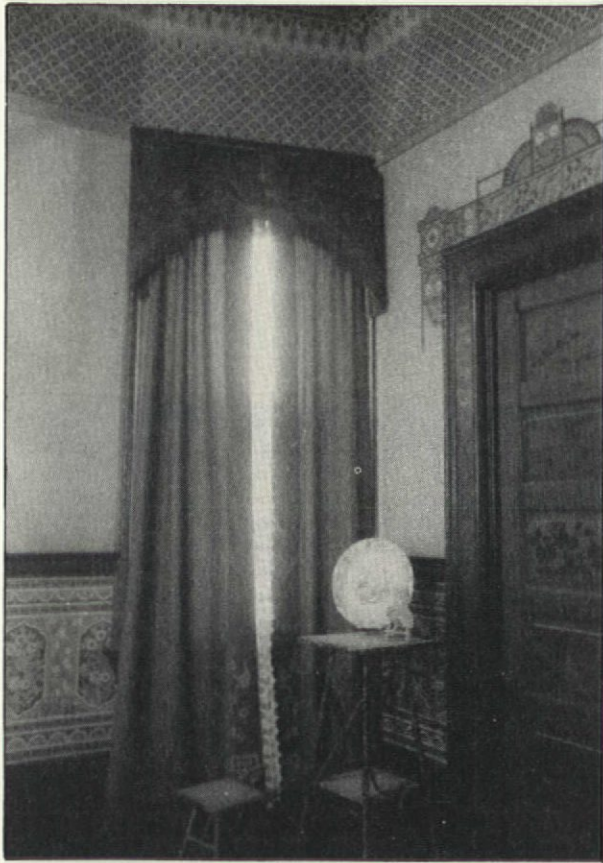

(left) This Anglo-Japanese parlor has a papered dado, wall fill, and frieze, and a band of hand-stencilling at the cornice. The designs on the lambrequin and drapes, inspired by the dado pattern, were hand painted by Tommi Veirs. (right) You can show your 'good



taste' by creating an inexpensive Anglo-Japanese touch in your house, i.e., displaying a blue and white china plate or a paper fan on a simple bamboo table. These items, and many others with an Oriental feeling, can be readily purchased from import outlets.



Dangers In Protective Devices



I WONDER if other readers realize that a defective lightning rod system is more dangerous than having no lightning rod at all? I just learned this after I had an expert examine my lightning rods. He explained that a defective system can actually attract a lightning bolt and leave it with no place to go but into your house.

IF YOU HAVE A NEW SYSTEM installed, make sure that the equipment carries the Underwriters Laboratories label. But even the best equipment is no better than the grounding system that the installer puts in place. So deal only with a reputable company.

- Daniel Taylor
Barre, Vermont

(P.S. Period lightning rod systems are available through Victorian Reproduction Enterprises, Inc., 1601 Park Avenue South, Dept. OHJ, Minneapolis, MN 55404, (612) 338-3636--Ed.)

Proper Paint Brushes

A PAINT STORE CLERK gave me good advice the other day. He told me not to use pure bristle brushes in latex paint. The constant immersion in the water-based latex paint makes natural bristles swell as they absorb water. The brush can eventually come apart from this. Instead use nylon or polyester brushes in latex paint.

- Tom Cole
Reno, Nevada

Stripping Hardware

I'VE HAD GREAT SUCCESS stripping brass hardware simply using wood ashes mixed with water. Just take a pound or two of clean ashes and mix with three or four gallons of water in a plastic pail. Stir briskly to release the sodium and potassium hydroxides (most of the ash is insoluble and will sink to the bottom, however.) Soaking the items overnight will usually loosen at least one layer of paint. Carefully remove them and scrub with a toothbrush under running water. I recommend wearing rubber gloves and eye protection for this purpose. To me, it is far superior to breathing paint fumes or even the odor of the various petroleum distillates available.

- David R. Sherk
Almond, N.Y.

Caulking Made Easy

I'M TOLD that pros can get caulking to come out of a tube in a nice even bead and in its proper place. I can't. The best tool I've found for smoothing out and clearing away the excess is my pointer finger. Typically though it gets so stuck up that its usefulness is diminished as the dry caulking on your finger sticks to the fresh caulking and makes an even bigger mess.



THIS IS MY TECHNIQUE: Take a small can and fill it with warm water for latex caulk or linseed oil for an oil-based caulk. Put the caulking on as usual but before smoothing, dip your finger into water or oil. Your finger will glide over the caulking without sticking and leave a smooth glossy finish. Keep a rag handy and periodically wipe any excess off your finger.

- Dan Miller
Elgin, Ill.

Gold Leaf And Onions

I'D LIKE TO PASS ALONG a cleaning tip I learned from my mother. To clean grime off delicate gold leaf picture frames, rub the gold leaf gently with a soft cloth that has been dipped in the juice of a chopped onion.

- Elise Winter
Elmira, N.Y.

Substitute Shutters



I WAS REMINDED that solid panel inside shutters are very expensive by the information and illustration from an article on historic windows in the OHJ. They are hard to find and have to be custom made unless old ones can be located, but these are also expensive. I solved the problem by using stock bifold doors with the small top panels cut off, making the shutters the 64-in. length my window openings required. I used regular door hinges to attach the shutters to the window frames.

- Sally Hunter
Alexandria, Va.

Tips To Share? Do you have any hints or short cuts that might help other old-house owners? We'll pay \$15 for any short how-to items that are used in this "Restorer's Notebook" column. Write to Notebook Editor, The Old-House Journal, 69A Seventh Avenue, Brooklyn, NY 11217.

CISTERNS

If your house is more than 75 years old, chances are you may run across the remnants of a cistern. An old cistern can be a troublesome hole in the ground that you'll want to fill in. Or it can be a fascinating piece of history you'll want to restore to working order. This article tells how to do both.

THERE'S SOMETHING about a cistern that fascinates. Perhaps that mysterious hole in the ground conjures up fantasies of buried treasure, or activates some dormant archeological instinct. Or maybe it's a fascination with a household technology that everyone once knew, but we've forgotten. Whatever the cause, when someone says: "I've just discovered an old cistern," it stirs great excitement.

CISTERNS haven't been gone from the American scene for all that long, however. As recently as the turn of the century, cisterns were

featured in most homes. True, municipal water had arrived in most towns by then. But people continued to believe that no well-run household could exist without good, soft rainwater.

A CISTERN is a tank for storing rainwater for household use. The rainwater collected in the roof gutters is led to the cistern through connections to the downspouts. There were three basic types of cisterns: (1) Wooden or metal tanks located in the house or outside; (2) Masonry containment vessels in the basement built into the foundation wall; (3) Masonry lined pits located a few feet away from the house. In-ground cisterns provided the best protection against freezing, kept water at a constant cool temperature, and minimized damage from leaks. However, the in-ground cisterns were also the most expensive to build.

CISTERNS were made from many different materials: bricks, stones, or other masonry units laid in mortar and plastered on the inside with a waterproof stucco. For in-ground cisterns, there was a manhole that served as a port for routine maintenance and for getting water out by bucket.* Basement cisterns usually had a wooden cover with a trapdoor for access.

Sectional View of Jug-Shaped Cistern

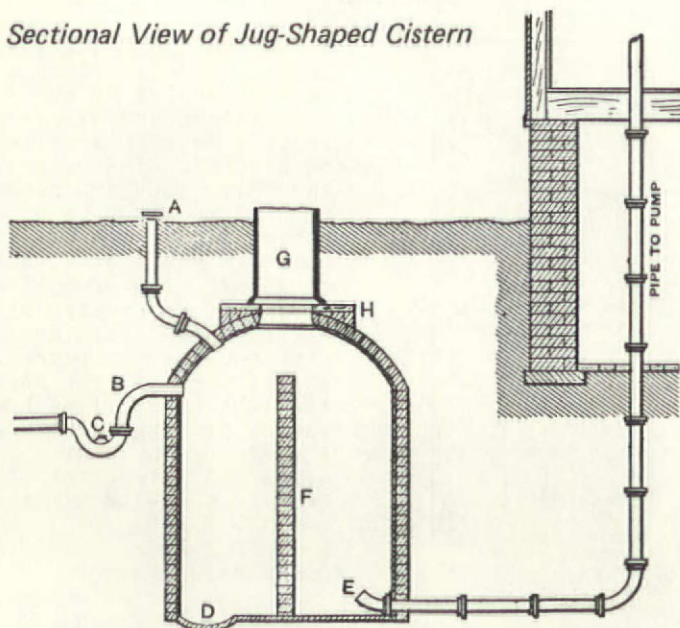

Here's a plan for a typical in-ground cistern as it appeared in the December 1894 issue of *Carpentry and Building* magazine. The details: A. Rainwater inlet; B. Overflow pipe; C. Trap; D. Sediment basin; E. Pump intake pipe; F. Brick wall (unparged) to serve as filter; G. Manhole; H. Flagstone cap. It's preferable to have pump intake pipe come through crown of cistern to minimize possibility of leaks.

*A contemporary handbook advised that the cover on the manhole should have holes for ventilation. But the holes should be small "so as not to admit toads."

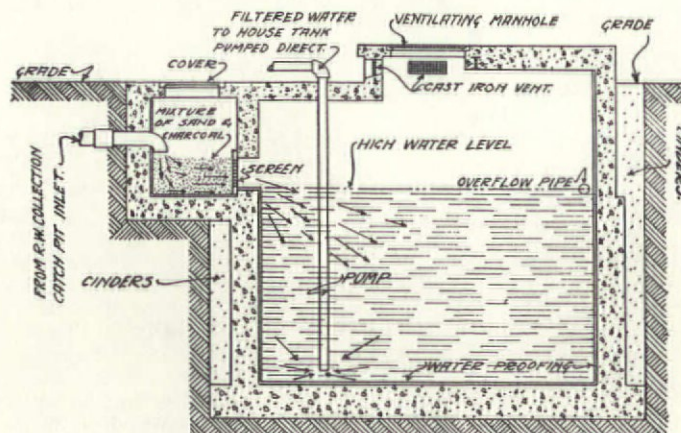

Cisterns continued to be widely used well into the 20th century. This plan for a poured concrete cistern appeared in Radford's *Details of Building Construction* published in 1911. Water from this cistern was intended for drinking. The filter compartment at the top left contained alternating layers of sand and charcoal. A hatch cover was provided so the filtering material could be replaced at regular intervals.



This extremely rare cross-section view of an in-ground cistern was taken by subscriber Craig Wolf. The cistern, built c. 1876 in Beacon, N.Y., was originally located a few feet from the house. However, an addition to the house resulted in the cistern being half inside the new

cellar. Solution: deactivate the cistern, cut it in half, and use it as a coal bin. Shown in the photo: (1) Rainwater inlet pipe; (2) Manhole in the crown; (3) Overflow pipe; (4) A later hole cut in the crown to serve as a coal chute.

TRUE, not many people use cisterns today. But there are a few households that have never stopped using them. And a few old-house owners have begun to re-activate old cisterns--especially to eliminate washing problems caused by a mineral-laden water supply.

OTHER CISTERN OWNERS find rainwater preferable for gardening. It's cheap--and isn't spiked with chemicals. If you live far from hydrants, a full cistern can add fire-fighting safety. Most fire trucks carry a dunking hose (to draw water from ponds) that will also draw water from your cistern.

A CISTERN could even be used as the heat sink in a closed-loop water-to-air heat pump system. This depends on the size of your cistern and the size of your heat pump system; an engineer would have to evaluate each case.

BEFORE REACTIVATING a cistern, however, you'd better find out which bureaucrat is in charge of stopping you. You'll find cistern regula-

Special thanks to these readers for their contributions: Rozella Erbstein, Viola, Ill.; Pam Weber, Woodstock, Ill.; Craig Wolf, Beacon, N.Y.; and Barbara Gentile, New York, N.Y. Much of the material was collated and edited by Charley McWha, Locust Valley, N.Y.

tions under one or more of these areas: building codes, water ordinances, health regulations, public works regulations, wells, diffused water, or cisterns. Because cisterns are unusual today, don't expect any official to encourage you.

IT IS NOT SAFE to use a cistern for drinking water. In cases of dire necessity, it is possible to add chlorine to cistern water to make it potable. Consult local health authorities regarding safety and legal factors.

THE FOLLOWING SECTION is a case history of one old-house owner who has reactivated a cistern. She wants to remain anonymous, for reasons that will become clear.

Me And My Cistern

WHEN MY HUSBAND AND I purchased our 1904 house, we found an old cistern in the basement--disconnected but intact. We originally had no intention of reactivating it, but decided to give it a try after discovering some of the other unappreciated amenities of old houses. I don't wish to be identified because our city building department said we couldn't do it. But we did it--and we're glad!

CONSTRUCTED of the same limestone as the foundation, our cistern occupies one corner of the basement. It's about 9 ft. square on the outside, and its walls come within 2 ft. of the cellar ceiling. The cistern is divided into two chambers by a curved brick wall, which functions as a filter. Rainwater flows into the larger chamber; the pump intake pipe extends into the smaller chamber. It holds 2,700 gallons, and with our annual rainfall of 30-36 inches we figured the cistern would be adequate for washing purposes.

TO SUPPLY RAINWATER, we fitted both of the existing cistern inlets with 6-in. tile elbows that we got from a plumbing supply store. Two of our gutter downspouts were connected directly to these elbows. For the cistern pump, we selected a Montgomery Ward ½-h.p. shallow well jet pump with a pressure-pack system. We were not totally happy with this setup, however, and when the pressure-pack ruptured two years ago, we replaced it with a Sears 19-gal. captive air tank.

OUR PIPING is arranged so that we can connect either the cistern or municipal water to our washing fixtures. A set of valves and piping unions assures total separation of the two water systems; the municipal water supply can never be contaminated with cistern water.

THE BENEFITS from our labors? Virtually any stain can be soaked out using only gentle soap and cistern water. Less detergent is needed in the washer. Dishes and windows dry spot-free, hair is softer, humidifiers and steam irons don't clog with minerals, and misting vaporizers don't leave a layer of mineral dust all over the furniture. I love my cistern!



The gutter downspout appears to be feeding into a house sewer connection, but the clay tile elbow is actually one of two inlets for the basement cistern. When the cistern was first reactivated, leaves washed down into the cistern and caused an odor as they decayed. Putting a nylon net strainer over the downspout where it enters the tile elbow solved the problem.

How To Fix (Or Fill In) In-Ground Cisterns

by James M. Smith, Anna, Illinois

IN-GROUND CISTERNS are still used in our rural area to supply water for washing and other household needs. In my years of running a building supply center, I've picked up quite a few tips on cistern repair, which I'll summarize in this short article.

FIRST, some important safety tips. Don't go down into an old cistern for a day or so after pumping out. Cisterns have been known to cave in soon after being emptied due to decreased pressure on the side walls. And when you do go down inside, ALWAYS leave a helper on top who can go for help in case of trouble. Also, there is a remote possibility that noxious gases could have built up at the bottom of the cistern. As the bottom sludge (sometimes up to 4 ft.) decomposes, it can give off carbon dioxide and other gases that can suffocate a person. The helper on top should keep up a steady conversation with the person in the hole. If there's any sign of slurred speech or disorientation, get the person out fast. If the person on the bottom should be overcome,

the helper should NOT go down into the hole, but rather should summon help immediately from an ambulance or fire department with breathing apparatus.

TO START, remove the cover from the manhole and pump out as much water and sludge as your pump will handle. Any sludge that you can't pump will have to be hauled out with buckets. Hose down the sides of the cistern with a stream of high-pressure water to knock off any debris and loose plaster. Then pump out the wash water.

WITH HAMMER IN HAND, tap for hollow spots that signal loose plaster. Pull away all loose material. Inspect the crown for spalling and weakness. Often, the crown is damaged by overflowing that holds water against it. If the crown is in bad shape, exit promptly--and start to disassemble the crown for rebuilding. Observe, as you are tearing it apart, how the old crown was built. Build formwork inside the cistern to hold materials in place as the new crown is being laid up.

IF THE CROWN IS STABLE, continue your cleanup, scrubbing the walls with a stiff brush. Then you're ready to start patching. If the floor needs patching, fill small holes with a 2:1 sand:portland cement mix. If much of the floor is bad, you're best off pouring a new 4-in. concrete floor (more than 4-in. will be needed if you're also laying up new walls).

SMALL PATCHES in the walls can also be made with the 2:1 mix. Larger holes should be filled with bricks or stones, held with the 2:1 mortar. Cracks should be chiseled out to 3/4 in. depth, then patched with 2:1 mix.

IF A FINAL WATERPROOF COATING is deemed necessary, you can use a commercial sealer such as Dryloc or Thoroseal. A cheaper alternative is two thin coats of a thick 2:2:1 slurry of portland cement:lime:sand.

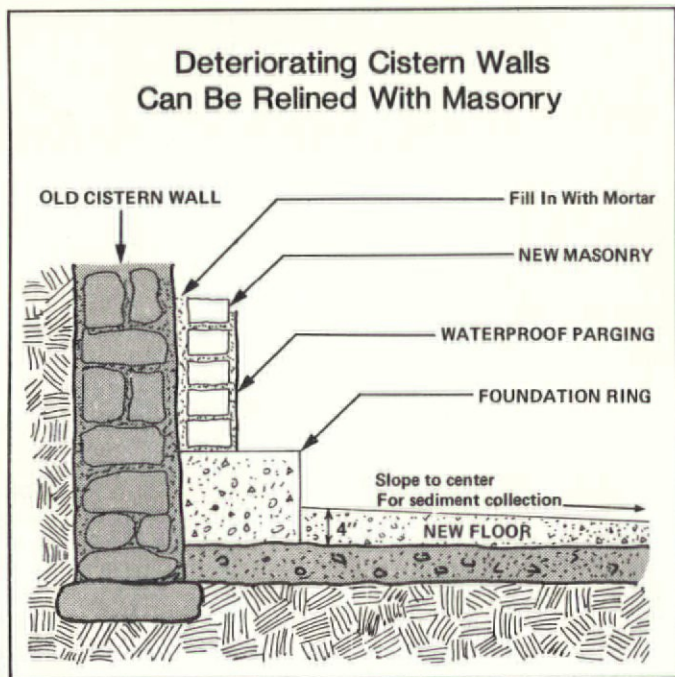

IF THE CISTERN WALLS are crumbling, and won't hold a patch, you can construct a new masonry liner inside the old walls. The new wall can be stone, brick, concrete block, or other masonry material. Plaster the inside of the new wall with two coats of a stiff 2:2:1 slurry of portland cement:lime:sand. Continue the new wall up to crown height and stop there if the crown is in good shape. If it's not, you'll have to re-build the crown as described before.

Proper Piping

THE INLET PIPE for the cistern pump should be at least two feet above the cistern floor. This allows a sedimentation basin, which is very important for water collected from a roof. Ideally, the inlet, outlet, and overflow pipes should pierce the cistern at the junction of the crown and wall, or through the crown. The overflow pipe prevents water from reaching the crown and causing masonry deterioration. The overflow should be connected to a dry well. Water inlet filters can be easily constructed to help keep gutter trash out of the cistern (see diagram).

IT'S A GOOD IDEA to install a diverter so that you can direct rainwater from the gutters into, or away from, the cistern at will. This device allows you to divert the first 10-15 minutes of a good rain away from the cistern--as the rainwater sweeps the gutters clean.

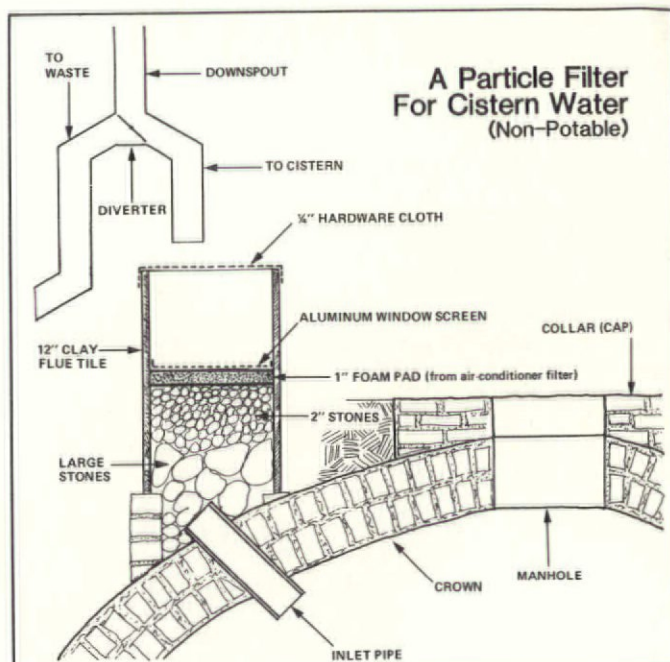

The rainwater diverter (also called a "cutoff") shown in the diagram above is a hard-to-find specialty item. It's still made by a few sheet-metal manufacturers that fabricate gutters and other rainwater products. Two producers are: Galvan Manufacturing Co., New Albany, Ind., and The Billy Penn Corp., Philadelphia, Pa. These companies don't sell direct to consumers, but you should be able to order their products through your local building supply dealer.

Fill 'er Up!

AS FOR OLD CISTERNS that are causing problems and are unwanted, there is only one solution: Fill them in. If there has been trouble caused by water collecting in the cistern, fill it with subsoil with a high clay content. Do not use aggregate; water will fill in between the spaces. Needless to say, pump out the water before filling. The fill will settle for 3-4 years, so you should have more fill on hand. You can reduce slump by vigorous tamping as each six feet of fill is added. Don't fill the cistern with trash containing organic material. As the organics decompose, the fill will slump for many years.

IF THE CISTERN stands by itself, the crown may be broken into pieces and used for fill. The remaining void can be filled with clay-rich subsoil as above. When settlement has ceased, add topsoil to finish out the yard.

IF THE CISTERN WALLS form part of the foundation for a porch or other structure, then the crown should remain intact. Fill with soil as above. Keep checking and adding fill as required. When fill has stabilized, cast a permanent concrete plug for the manhole.

JAMES M. (Mike) SMITH is proprietor of the Anna Building Center in Anna, Ill. In addition to stocking cistern parts and pumps, Mike has accumulated a lot of cistern repair know-how. He can be reached at: The Anna Building Center, 201 East Vienna, Anna, Ill. 62906. Phone (618) 833-4221.



A Period Christmas

The Museum of the City of New York is selling Victorian Christmas cards that are truly enchanting. Their assortment of 25 different reproduction Christmas cards in various sizes and shapes cost \$7.95, plus \$1.60 for shipping. Their ornament selection includes 5-inch high, papier-mache Santas reproduced from 1850, 1890, and 1925 figurines (\$8.40 ppd. each). These and other products that mostly focus on the Edwardian era are shown in their catalog (\$1 for two years). The Museum of the City of New York, Fifth Ave. at 103rd St., Dept. OHJ, New York, NY 10029. (212) 534-1672.



Christmas tree ornaments that are reproductions of 1850, 1890, & 1925 designs.

Traditional tree ornaments that look handcrafted rather than glitzy and mass-produced are still hard to come by. The candleholder pictured here really has that old-fashioned quality. Reproduced from an 1867 New Jersey design it is a fluted tin candle holder that hangs on a tree branch. The wire is counterbalanced by a clay ball, finished in flat red, mustard, blue, white, or shiny silver or gold. A box of six, postpaid, costs \$23.50. You should allow four weeks for delivery. Please note that these are strictly ornaments: Don't light the candles. Order from McLeach, Box 575, Dept. OHJ, Fitchburg, MA 01420. (617) 386-5323.



Flue Liner News

We thought we'd about covered flue liners in our September 1982 article. But subscriber Martin Wawrla's arguments for the Ventinox system persuaded us to add to the discussion.



Not only has he installed the liner in his own house, but he's also become the American representative for the Swiss system. He discovered this insulated, flexible metal flue liner — already well established in Switzerland — while trying to find a suitable liner for several chimneys in his own old house.

Without implying an endorsement, we would like to describe the new Boa-Ventinox liner.

Material is type 321 stainless steel. A continuous (spiral) weld avoids mechanical connections between sections that can come apart during fires or repeated cleaning. The liner was tested at R.P.I.; then, in stringent chimney fire tests, by Boa themselves; finally the system was classified by Underwriters Laboratories in February, 1983.

The metal liner is insulated with a poured vermiculite fill; in old chimneys, the vermiculite is held in an insulating refractory slurry that also stabilizes the old masonry.

The service arrangement is noteworthy. Dealer-installers nationwide are sold a complete system, including technical training. Part of the contract is a free inspection after two months of operation. A non-obligatory recommendation is made for a cleaning schedule, which both dealer and customer must sign to assure mutual understanding. Ventinox headquarters gets a copy of the contract. So if the local dealer disappears, the original inspection report, installation details, and cleaning schedule are still on file with the company. And the 10-year warranty still stands.

The liner can be used with coal-, gas-, wood-, or oil-burning appliances and fireplaces. The company also offers a stove connector for safe installation of fireplace-insert stoves. For more information, contact Martin Wawrla at American Boa — Ventinox, PO Box 1743, Dept. OHJ, Albany, NY 12201. (518) 463-7284.

We now know of a West Coast supply for linoleum. A long-time supplier of props to the film industry, Linoleum City carries a wide array of out-moded flooring, including 9 x 9 asphalt tiles, 9 x 9 black and white tiles (which are especially made for them), Dutch battleship linoleum, and *Marmoleum*, a marbled linoleum. They've also got an inventory of old linoleum and vinyl patterns, many of which are over twenty years old. Already, several historic sites have taken the Hollywood cue. They don't offer literature, but you can take advantage of this great floorcovering source by writing with your specific needs. Linoleum City, Fred Stiffter, 5657 Santa Monica Blvd., Dept. OHJ, Hollywood, CA 90038. (213) 463-1729.

Stair Repair

Missing a newel post or baluster? Not all parts of old staircases can be replaced with standard parts. But Renovation Products can probably help — they have the largest selection of stair parts available from a single source. And they've just introduced an installation instruction manual. Complete with detailed line drawings, the manual explains in uncomplicated language how to replace a stair part. The manual is free with a purchase from the company.

Newel posts are offered in 22 different designs including Victorian and turn-of-the-century styles. Newels begin at \$33 for a 3½ in. diameter; an impressive 12-in. newel costs \$418. They also carry 17 handrail styles, and 18 balusters in a variety of sizes. Most parts are stocked in hemlock. Other woods and custom designs are available, but you must allow additional time for delivery.

A new supplement to their annual catalog features their complete selection of stair replacement parts. You can order a copy along with their full millwork catalog for \$2. (If you've already got the company's catalog, you'll probably get a complimentary supplement in the mail.) Renovation Products, 5302 Junius, Dept. OHJ, Dallas, TX 75214. (214) 827-5111.



right hand volute

Unique Brushes

Technical editor Larry Jones came back from a boat show this fall touting the virtues of these exceptional — and unusual — paint brushes. Imported from Italy, these high-quality brushes are round and oval rather than rectangular. They're *not* stenciling brushes, however; actually, they are a throwback to fine finishing brushes common at the turn of the century and earlier. The round shape allows the brush to hold a large volume of paint. And by lightly and evenly rolling the brushes as they are drawn, a clean-edged swath of paint can be applied to moulded surfaces. (The brushes work great on window sash and muntins, for example.)

Made of pure china bristle embedded in epoxy, brushes range from a no. 10 (10 mil. in diameter) to a no. 50 round or oval (about 50 mil. in diameter). And prices range from \$8.45 to \$33.70; discounts are offered to the trade. The importer will sell direct to anybody and offers free literature. Coastal Trade, 601 South Andrews Ave., Dept. OHJ, Fort Lauderdale, FL 33301. (305) 467-8325.

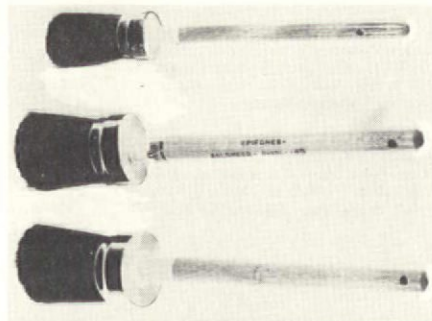

English-made Hamilton brushes are a favorite of many craftspeople. Larry Jones also found the name of an American importer of these brushes. The *Perfection* brush, with pure china bristles set in durable vulcanized rubber, will do an excellent job with almost any finish for years and years. Sizes range from ½-inch wide (\$4) to 4-inch wide (\$30). Besides stippling brushes, wall brushes, and graining brushes, they carry unique angled brushes (one of which is pictured here) designed for cleaning and painting radiators — about \$16 each. For a free catalog featuring their complete line of 'finishing tools,' write Hamilton & Company, Ltd., PO Box 13212, Dept. OHJ, Roanoke, VA 24032. (703) 344-6400.

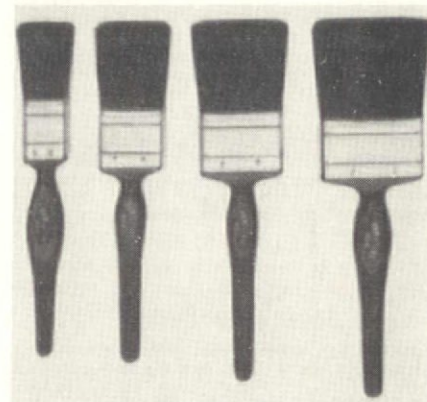

(left) Round brushes from Coastal Trade. (above) A 'Perfection' brush sampling.

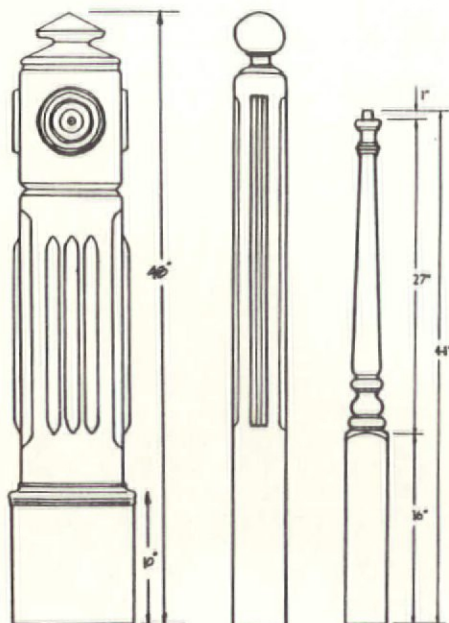

(left) A heavy, Victorian-style newel post; (center) A slender turn-of-the-century-style newel post; (right) one of numerous baluster styles — all offered by Renovation Products.

Now You Can Hang Your Ceiling Fan Between Joists

You've just purchased a ceiling fan, then discovered the nearest joist is six inches off from where you'd like to hang it! The *Fan-Fast* steel support is the answer. It can be expanded until its ½-inch steel points pierce nearby joists to provide permanent positioning. Inserted through a 4½-inch opening, the support is for joists on either 16- or 24-inch cen-

ters. The unit also includes a UL-approved electrical box and a sturdy hook for a suggested retail price of \$19.95. Free information is offered and *Fan-Fast* units can be purchased direct or through distributors. Lance Austin Enterprises, Inc., 3143 W. Tharpe St., Dept. OHJ, Tallahassee, FL 32303. (904) 575-0176.

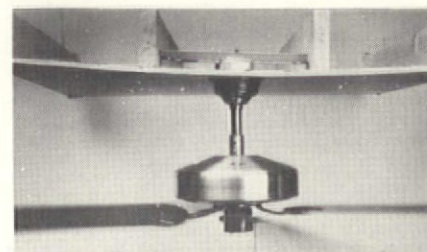

The 'Fan-Fast' support is installed with the aid of a hammer through a ceiling opening.



BOOKS & PUBLICATIONS

"THE MAINTENANCE & Repair of Architectural Sandstone," an illustrated, 8-page leaflet based on the results of a study on sandstone repair techniques. 4 main sections: looking at sandstone; decay of sandstone; protection & maintenance; repair. \$1.50. NY Landmarks Conservancy, 330 W. 42 St., New York, NY 10036.

BOOKS useful to anyone involved in the restoration & maintenance of old buildings. Many offered. Technical data such as ICCROM publications. Free book list. PRG, 5619 Southampton Drive, Springfield, VA 22151. (703) 323-1407.

TRY BED & BREAKFAST, the interesting old way to see America. For a list of B&B guides and directories, send SASE and \$1. E.P. Tobin, RD 2, Box 64, Rhinebeck, NY 12572.

INN REVIEW — the newsletter for people who prefer to stay in country inns and small hotels. Published monthly. Subscriptions \$12/12 issues. Inn Review, PO Box 1345-A, Lafayette, IN 47902.

CLEAN & POLISH copper, aluminum, brass, & silver like a pro. Make your own metal cleaners & polishes (including an instant dip silver polish) at far below commercial prices. Each set of formulas & instructions, \$2. Naturals, PO Box 403595, Miami Beach, FL 33140.

VICTORIANS & farmhouses — if you love old houses, these are the house plans you've waited for. Authentic exteriors with practical floor plans for modern living. Designed for economical construction. Working blueprints. \$10. Historical Replications, Inc., Dept. OJ, Box 31198, Jackson, MS 39206.

PROFIT GUIDE To Renovation: "Restore Your Future" by M.L. Jones, et al., is a financial guide to home restoration. 3 experts share the secret of their profits from 50 home renovation jobs. \$5.95. Prentice-Hall, Englewood Cliffs, NJ 07632. Attn.: Addison Tredd.

RESTORATION SERVICES

WOODEN WINDOWS: Custom restoration & reproduction to meet federal standards & conserve energy. Brochure available. The History Store, 418 North Union Street, Wilmington, DE 19805. (302) 654-1727.

M.J. MAY: Antique Building Restoration. A large variety of old-building services — fretwork and trim repair; paint stripping; installation of structural antiques; sash repair; carpentry; painting & refinishing; etc. Free estimates, insured, low rates; will travel for free. 505 Storle Avenue, Burlington, WI 53105. (414) 763-8822.

WOOD WINDOW sash made to order, many stock sizes available. Double-hung set for rope and pulleys, solid wood muntins. Info & price list, \$2.50. Moulding, trim, casings duplicated. Send sample & \$3 /profile for quote. DVH/co, Suite 950, 4040 Newberry Road, Gainesville, FL 32607.

BUILDING RESTORATION: Contractor specializing in historic preservation. Charles Dahlenburg, 610 Garrard Street, Covington, KY 41011. (606) 291-2479.

EXPERT HELP for old-house owners & owners-to-be: Our professional architectural & preservation services can help you deal successfully with your old house — restoration & remodeling design, research, technical & historical advice, & more. Allen Charles Hill, AIA, Historic Preservation & Architecture, 25 Englewood Road, Winchester, MA 01890. (617) 729-0748.

GARDEN DESIGN. Specialist in period landscape architecture. Technical expertise in drainage, soil, construction, & horticulture. 12 yrs. professional experience. P. A. Messenger, Landscape Architect, 1263 Lombard St., San Francisco, CA 94109. (415) 885-1648.

BREWER INC. — Quality painting, specialize in special coatings. Also, rustic redwood signs custom made, any size & shape. Harold Brewer, Hutchinson, KS (316) 663-1654.

HISTORIC preservationist will document your house for reasonable fees. Rundown on builder, owners, history, original floor plans, etc. Prepare materials for his. registration, tax abatements & credits. Ms. Connington (212) 768-8848, NYC.

MEETINGS & EVENTS

WINTERTHUR, DE. Yuletide Seminar: Lectures, 18th-century luncheon, decoration demonstrations, dessert, and a popular Yuletide tour. Wed., Nov. 30 & Dec. 7, 9 to 4:15. Winterthur Museum & Gardens, Winterthur, DE 19735. (302) 656-8591.

PITTSBURGH: "An Old Allegheny Xmas." Victorian candlelight tour presents 7 restored homes & the magnificent Calvary Church. Period interiors & lavish turn-of-the-century holiday decor, food, & customs. Dec. 10 & 11, from 4 to 10 PM. Tickets (\$7) are limited; reservations are requested. Phone the Allegheny West Civic Council at (412) 323-8884.

THE FINISHING SCHOOL: A complete schedule of classes in Graining, Gilding, Casting, and other faux finishes. For further details write 1 Elm Street, Great Neck, NY 11021. (516) 466-4759 or 487-2270.

INNS & HISTORIC HOUSES

BROOKSIDE MANOR — B&B in an 1860 Georgian-Victorian mansion w/ pool, on 60 acres in historic Lebanon Springs, NY. 15 min. from skiing, 16 miles from Tanglewood, & in the heart of antique country. (518) 794-9620 or (212) 369-1450.

BED & BREAKFAST in restored 1880s beach house near historic Ft. Moultrie and 20 min. from Charleston. Immaculately furnished, expanded continental breakfast, flowers. The Palmettos, PO Box 706, Sullivan's Island, SC 29482. (803) 883-3389.

HEARTHSTONE INN: 25-room country inn, furnished in Victorian antiques. Some rooms have fireplaces, some have balconies overlooking the mountains. All have private baths. Gourmet breakfast included. Near the Pikes Peak region activities. Free brochure. 506 N. Cascade Avenue, Colorado Springs, CO 80903. (303) 473-4413.

BEECHWOOD: A Victorian guest house on Cape Cod. 5 rooms with private baths, period furnishings, ocean views, continental breakfast. In historic district, close to beaches, restaurants, and antique shops. 2839 Main Street, Barnstable Village, MA 02630. (617) 362-6618.

FOR SALE

PARLOR STOVE, "Magnificent Windsor," porcelain woodgrain enamel outer shell & an ornamental temperature gauge top piece. Best offer over \$900. Old Emerson ceiling fan w/ wooden blades, & old porcelain light switches (never used). Jim Stoker, 14 Roberts Street, Adams, NY 13605. (315) 232-4020.

STAINED GLASS windows, 2-section, double-hung, from 90-year-old church. Each section 47 in. H x 41 1/2 in. W. Assorted turn-of-century hardware. Listing available. A.H. Roberts, 15 Harrington Avenue, Westwood, NJ 07675. (201) 666-4842.

STOVE — Waterman, gas, 4-burner, bi-oven, exterior temperature control. Cream & green color. Very good condition. \$200. Brooklyn, (212) 859-3367 evenings.

VINTAGE RADIOS: 1922 to 1952, priced from \$25 to \$250. Free brochure. James Fred, Cutler, IN 46920.

ROLL-TOP DESKS. Original, stacking, 6-tier mahogany bookcase, complete (7 1/2 ft. x 34 in. x 12 ft.). 25 stained glass windows; excellent original condition; 1890-1910; non-religious, clear, etched, etc.; 4 ft. x 3 ft. & smaller. Beveled mirrors. Chairs, rockers. William Barton, PO Box 628, Ipswich, MA 01938. (617) 356-5323.

GIGANTIC ELK HEAD with historic past. A real bargain at \$125. Perfect for your restaurant or bar. (314) 524-1820.

IRON FENCING: 6 sections, 5 ft. 4 in. L x 2 ft. 11 in. H. 8 cast-iron spear points per section with matching corner posts & walk gate. Very ornate. \$85 per section, plus shipping. Henry C. Thompson, 610 E. Third Street, Neligh, NE 68756.

5-PIECE PARLOR SET, Eastlake Victorian, made of walnut, rose velvet, beige brocade. In real good condition. \$525. (618) 662-4866 after 6 PM.

1910 CLAWFOOT BATHTUB, 4 ft. x 25 in. Good condition. \$150. E.G. Allwood, 17 Frances Street, Woburn, MA 01801. (617) 933-4636.

LUMBER reclaimed with care & respect from the original Rheingold Brewery in Brooklyn, NY, where it was used in fermentation tanks. 125,000 board feet, clear heart, vertical grain redwood & cypress. Redwood: 9 ft. x 2-5/8 in. x (4 to 10 in.); 10 to 15 ft. x 2-5/8 in. x (4 to 18 in.). Cypress: 14 ft. x 2-5/8 in. x (4 to 12 in.); 14 to 18 ft. x 3 3/4 in. x (4 to 22 in.). Redwood: \$1.75 / bf. Cypress: \$2.50 / bf. Minimum order, \$2500. Prices negotiable over \$10,000 purchase. William Barton, Many Board Feet, Inc., Box 628, Ipswich, MA 01938. (617) 356-5323.

FILE CABINET, walnut veneer, 5-drawer, brass handles, refinished, excellent condition. \$125. Porch balusters, 1 1/2 in. L, turned, approx. 45. \$75 for all. New Jersey, (201) 439-3529 EST evenings.

BED: Intricately carved, serpent motif, c. 1890, excellent original condition. Approx. overall dimensions: 5 ft. 2 in. H, 8 ft. 5 in. L, 5 ft. 8 in. W. \$10,000. James Sandro, 25 Myrtle Avenue, Buffalo, NY 14204. (716) 855-1931.

ANTIQUÉ KHORRASAN CARPET — per Sotheby, Parke Bernet sale of 11/22/75. Soft, shimmering reds & light blues. Fine hand weaving. Have retired and don't have a room large enough for it. We've tried! 11 ft. 8 in. by 21 ft. 6 in. \$1900. Wheeler, 147 S. Interlachen Avenue, Winter Park, FL 32789. (305) 644-2130.

SLIDING POCKET DOORS, one pair, walnut, from an old manse in Boston's Back Bay area. Panelled, no glass or hardware. Approx. 42 1/2 in. W x 96 in. H; better than 2 in. thick. Very decent condition. Asking \$650 or best offer. Also a little heavier pair w/ arched top, each door forming one side of arch. These need repairs and plate glass. \$125 /the pair. Local delivery can be arranged. Eugene L. Felch, PO Box 666, Astor Station, Boston, MA 02123. (617) 282-1662.

DOOR HARDWARE for sliding doors; complete set includes recessed door pulls & locks complete with key. "Norwalk Lock Co." pat. 1885. Best offer. Joan Knox, 3100 Backmeyer Road, Richmond, IN 47374.

REAL ESTATE

1888 QUEEN ANNE, newly painted w/ historically accurate 6-color scheme. Completely restored, insulated, & researched for authenticity. Stained glass windows, French doors, original woodwork, 3 f/p, 5000-sq-ft. living area. Affordable taxes & utilities. In town, 1/4-acre lot. \$125,000. L.W. Morrey, 1135 No. Lincoln, Hastings, NE 68901. (402) 463-4938.

MUST SACRIFICE — Family liquidating a rehabber's dream: state level candidate for the National Register. 16,000+ sqft. building, zoned commercial. Retail level now has full occupancy; blacktop parking. Suburban location but close to major expressways. (314) 524-1820.

ST. LOUIS, MO: Lafayette Square Hist. District. 1879 3-storey townhouse, facing park. 95% restored, 11 rms, rehabbed carriage house rental unit. 6 marble f/p, modern kitchen w/ custom walnut & marble cabinetry. 2 1/2 baths. 5 minutes to arch downtown. Owner (314) 771-1014 / 771-9214.



BUFFALO, NY: 1893 stone house. Leaded glass, hardwood floors, modern kitchen and baths. 3-car stone garage with modern apt. above. Treed, 129 ft. x 190 ft. corner lot in area of similar vintage homes. \$145,000. (716) 833-6015, evenings. Owner.



DISASSEMBLED CAPE COD, c. 1831. Museum quality, historically documented. All decorative elements are complete & restorable, as are the interior fireplace mantel pieces, which are embellished w/ nicely turned columns. Call Patricia Anne Bates, (617) 655-0732.

INDIANAPOLIS, IN — Architect-designed, 1893 Victorian in turn-of-the-century community on National Register. 14 rooms, carved staircase, crown mouldings, pocket doors, bevelled & stained glass, metal ceiling in kitchen, built-in oak bookcases w/ leaded-glass doors, more. (317) 632-3711.

SUBURBAN PITTSBURGH — 1910, 2½-storey, brick and cedar-shake home. 5 BR, 4-car garage, half-acre lot in quiet neighborhood. Stained glass windows, 4 f/p, oak woodwork, original specifications/architect's drawings, new oak kitchen. \$94,900. (412) 262-2508.

80-YEAR-OLD frame farmhouse w/ wrap-around porch, 5 rms & bath, barn, granary, & smokehouse on 50 acres. Paved road frontage 2000 feet, will divide into 10 A tracts. 30 min. from Charlotte, NC. \$115,000. Emmy L. Pharr, 1642 Old Charlotte Rd., Concord, NC 28025. (704) 782-8331.

NEAR HISTORIC OWOSSO, MI: A preservationist's dream! 1850s Italianate. 10-rm. (5-BR) country home on 12 acres. Approx. 3000 sqft. Sitting room up, parlor down, 3 full baths. Needs refurbishing. Opportunity for inn or B&B. Between I-75 and US-27. \$89,900. Lois Bottomley. (517) 589-9035 or 321-6750.

1730 SANDSTONE Colonial on 3 acres adjoining state land. Restored by historian/craftsman. 7 rms, 2 baths, 2 f/p (original mantels), wide floorboards. Patio overlooking brook. Excellent schools. 5 min. to express bus to New York City. \$195,000. Freda Buchanan, Realtor. (914) 358-1025.

PRE-1900 VICTORIAN 2-storey home in downtown historical section of Columbia, Tenn. 22 rooms, 6 f/p, 6 bathrooms. Owner terms at 10% fixed-rate interest. \$85,000. Rita Hamilton, Church Realty and Auction Sales, (615) 388-8075 days; 388-7231 evenings.

OZARK MOUNTAINS — 100-year-old, structurally restored home. 22 miles SE of Univ. of Arkansas in Fayetteville. 2 storeys, 4 BR, 1 bath. 2 front porches overlook White River headwaters. Full basement, natural gas with wood furnace. 2½ fenced acres, creek, 4 outbuildings. \$44,000. (904) 421-2887.

BREWER, ME: on Penobscot River, Cape w/ att. 2-car garage on 2 lg. lots within city limits. 6 rms, 2 baths. All new oak kitchen, living room w/ fireplace, natural wood floors. Lovely views from screened rear porch. Quiet & privacy. \$65,000. (207) 989-4254.



SOUTHERN OHIO near historic Lebanon. Country properties protected by covenants for historic preservation. Victorian farmhouse, 1880, 10 rooms, 1½ baths w/ 4 acres & pond. Also, 2 smaller homes. Acreage to 10 acres w/ restored old barn. Good financing available. Mrs. Clayton W. Wright, 8489 Rossburg Road, Morrow, OH 45152. (513) 877-2212.



1859 GOTHIC, Whithers design, 5 bedrooms, dual staircases, terrace, tastefully landscaped 1.2-acre lot in the Balmville section of Newburgh. 60 min. from Manhattan. Brochure available. \$165,000. Kahn Better Homes & Gardens, (914) 562-4800.

ALEXANDRIA, VA: Two 100+-year-old buildings in old and historic district. Convert 1 to maximum 6 residential units. Rehab the other and build an additional house. Tom David, 2300 Mount Vernon Avenue, Suite 240, Alexandria, VA 22301. (703) 838-4622.

BRICK GREEK REVIVAL, built in 1846 on 7/8 acre. In historic district. Will accommodate 2 families or 1 large family. Price negotiable. Robert Lyon, 208 W. Pearl Street, Coldwater, MI 49036.

WANTED

XMAS ornaments & figurals, old Victorian. Janet Hunt, 474 Woodside Terrace, Madison, WI 53711.

SPANISH-COLONIAL or Old Mexican furniture. Send descriptions, prices, & photo if possible to Jack Hardy, 715 W. Nettie, Kingsville, TX 78363.

VIRGINAL, harpsichord, or clavichord: pre-20th century. Antique wooden pool table, pre-1935. Rolls Royce 25/30, Wraith or Silver Wraith; Sedanco, coupe, or roadster. Parts for 1940 Lincoln Continental. Jim Chisman, PO Box 1111, Clemson, SC 29633. (803) 639-2939 PM.

Special Discount For OHJ Subscribers: Save \$10 when you join the Historic House Association of America.

Have you ever wished that the concerns of old-house owners could be represented in the halls of government? If so, then you should become a member of the Historic House Association of America. Founded in 1978 with the assistance and support of the National Trust for Historic Preservation, HHAA is the only national preservation organization dedicated solely to the preservation of historic houses in the private sector.

Through its network of historic-house state representatives, the Historic House Association of America keeps its members informed of current preservation issues and assists them in finding solutions to their old-house problems. HHAA also represents the legal and financial interests of its membership before Congress and governmental agencies, encouraging the restoration and preservation of historic houses in the private sector.

As a member of the Historic House Association of America, you shall receive:

- An annual subscription to the bimonthly journal, *Historic Houses*, with articles of special interest to historic-house owners nationwide;
- Copies of Historic House Association publications, such as *Easements and Other Legal Techniques to Protect Historic Houses in Private Ownership* by Thomas Coughlin;
- An invitation to attend HHAA's annual preservation conference with a reduced registration fee for members. Each year house owners from across the country gather with noted preservationists in an architecturally rich area of the nation to talk about their interests and problems. This conference presents an opportunity for members to share house restoration experiences with other house owners. Highlights of past conferences include tours of private historic houses usually not open to the public;

- Discounts on Association-endorsed restoration products;
- Daily expert advice on your historic-house problems. Just write or telephone HHAA's Washington office and your questions will receive individual attention and will be answered promptly;
- Access to current information concerning taxes, legislation, and national preservation issues affecting historic-house owners in the United States;
- And, an opportunity to attend HHAA's regional workshops/lectures on house preservation.

Through a special arrangement with *The Old-House Journal*, you can get an annual membership to the Historic House Association of America for only \$15. That's a 40% discount off their normal price of \$25 — you save \$10. Clip or copy the Order Form below, fill it out, and place it in the mail today. Add your voice to the preservation organization that serves your needs and concerns.

Yes, I want to join the Historic House Association of America and support the preservation of America's houses. Enclosed is my check for \$15 for an individual annual membership.

Name _____

Address _____

City _____ State _____ Zip _____

Please make your check payable to *The Old-House Journal*, 69A Seventh Avenue, Brooklyn, NY 11217.



Northport Historical Society

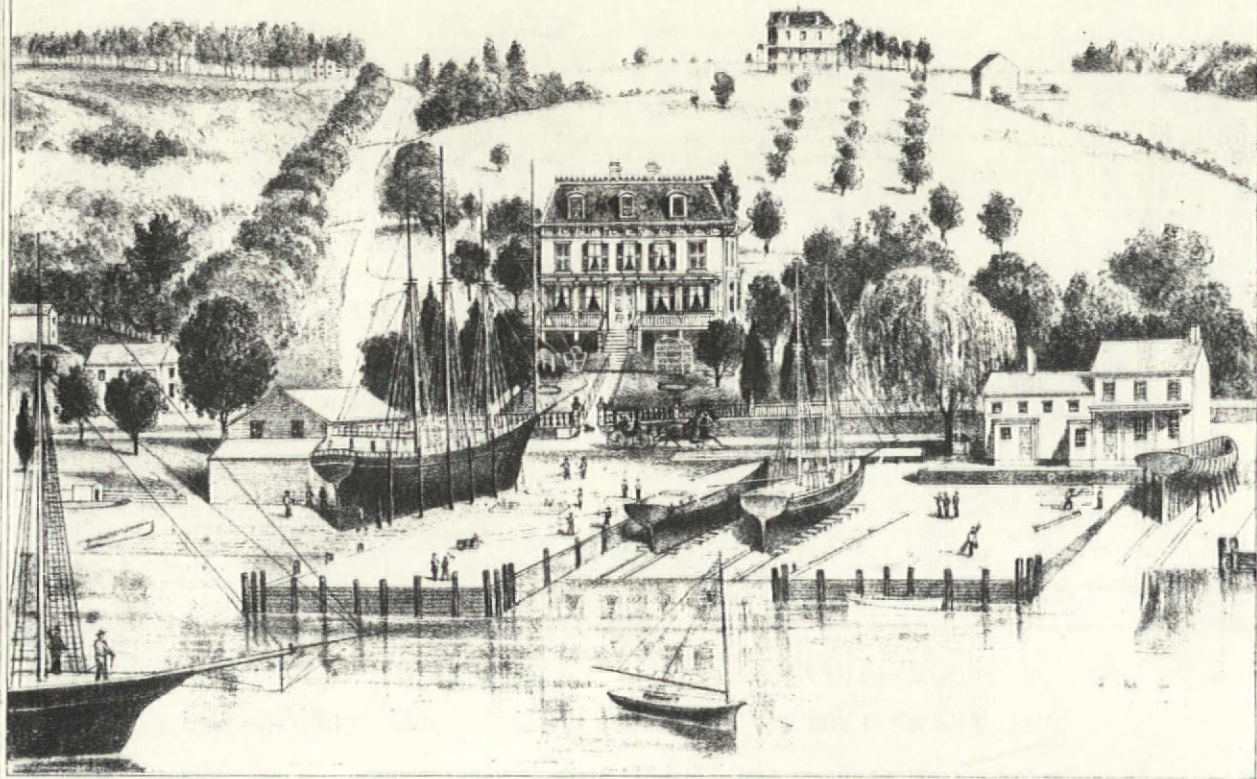

RESIDENCE & SHIPYARDS OF JESSE CARLL, NORTHPORT HARBOR, L. I.

THIS MONTH'S Remuddling "winner" is a real heart-breaker. Believe it or not, the apartment house pictured at right was originally the lovely mansard-roofed mansion seen in the drawing above. That drawing was made around 1860 by well-known New York artist Edward Lange. The house belonged to Jesse Carll, a famous ship-builder from Northport, Long Island; those are his shipyards in the sketch.

AN ALMOST-COMPLETED SHIP is seen in the sketch, just below the mansion. The photograph was taken from where the front of that ship once stood. At first we couldn't believe the photo and sketch were the same house. The apartment-house facade has four window bays where the mansion had five. But if you were to walk around to the north or south side of the building, you'd see the original round-headed dormers. Same building, all right. But from this angle, there isn't even a ghost of its former elegant life.

THE REMODELING CONTRACTOR and owner undoubtedly had rationalizations for the "adaptive reuse." But the two representations of the scene speak for themselves. Northport was robbed. 🏠

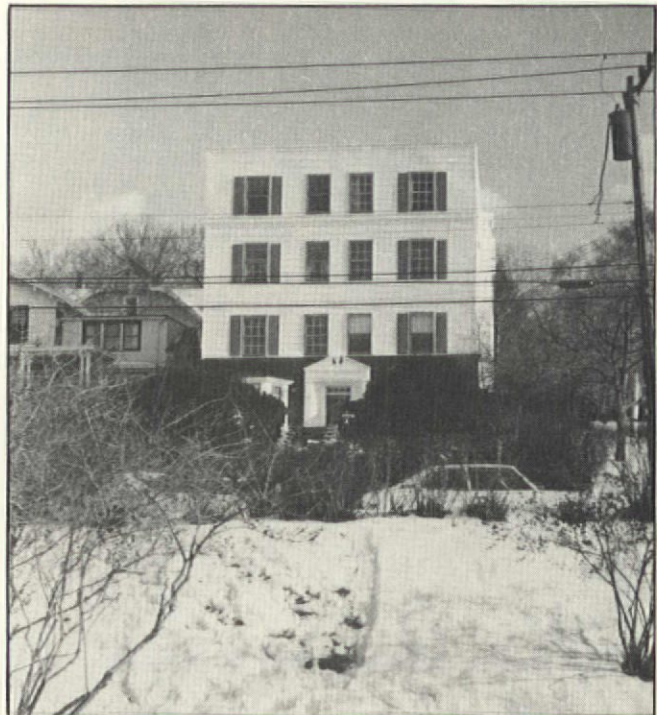

Thanks to Tim O'Brien for sending the sketch and taking the photo.

HOLIDAY SUPPLEMENT

Special Gifts For Old-House Lovers!

SPECIAL BONUS!
A \$10.95 OHJ Work Apron is yours FREE with
an order of \$35 or more!

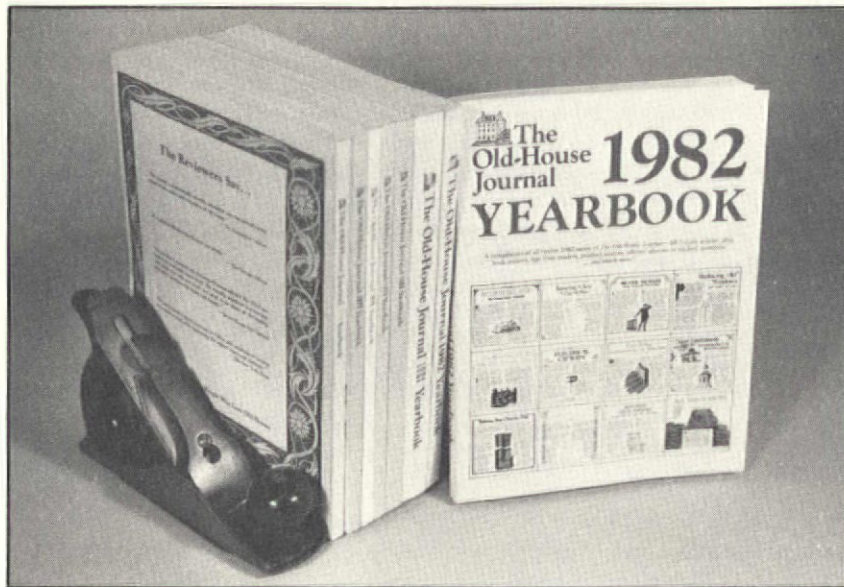

The Restoration Encyclopedia

**The
Ultimate
Gift
For
Someone ...**



Save money on the seven-volume set of OHJ Yearbooks . . . the only definitive how-to reference for sensitive rehabilitation.

- * 7 STURDY BOUND VOLUMES
- * 1,396 PAGES
- * 513 ARTICLES
- * METICULOUS INDEXING

The seven-volume Yearbook set — an OHJ Restoration Encyclopedia — gives you every article, every tip, every source published in the pages of The Old-House Journal from January 1976 through December 1982.

From designing a gazebo to repairing cast iron . . . relining chimneys to rescuing Lincrusta . . . moving a house to stripping woodwork — it's all here. This is the biggest, most complete, most authoritative reference on old-house restoration you can find anywhere.

Know someone who just bought an old house? Have a friend who could use our help? There's no more thoughtful a gift than the Restoration Encyclopedia. (And it's absolutely indispensable for anyone who works on old buildings for a living.)

Purchased individually, the volumes would total \$88. But you can order the entire set of seven volumes for only \$59.95 — a saving of \$28. To receive the Restoration Encyclopedia, check the appropriate box on the Order Form in this Supplement.

Buy a set for your old house, too!

**... Who
Loves
An
Old
House!**



Special Holiday Supplement

NEW BOOKS FOR OLD-HOUSE PEOPLE

Salvaged Treasures by Michael Litchfield and Rosmarie Hausherr

This is a hefty book filled with lovely photos, but you won't just leave it lying on your coffee table. The useful text and drawings show you how to buy, restore, and make the best use of architectural salvage. Combining imagination with common sense, the author explains how to use salvage items for every feature of your house: woodwork, windows, doors, & hardware; plumbing; lighting fixtures; exterior & interior metalwork; masonry; structural elements. The chapters include specific safety tips and lists of the necessary tools for each project under consideration. There's even a special section on how to salvage and move an entire house. 253 pages, hardbound.

Order No. 41

\$37.50 postpaid



Building Your Own Kitchen Cabinets by Jere Cary

We all know that prefab kitchen cabinets are often unattractive, and that semi-custom cabinets can be terribly expensive. That leaves building your own cabinets — and this job is well within the capabilities of a do-it-yourselfer with basic carpentry skills. If you fit that description, here's the book you've been waiting for. Straightforward instructions and over 150 illustrations see you through every step of the job — from basic kitchen organization to constructing and installing the cabinets. This excellent book — from the publishers of *Fine Woodworking* — also has information on estimating costs, buying hardware, selecting different woods, and much more. 144 pages, softbound.

Order No. 42

\$13.95 postpaid

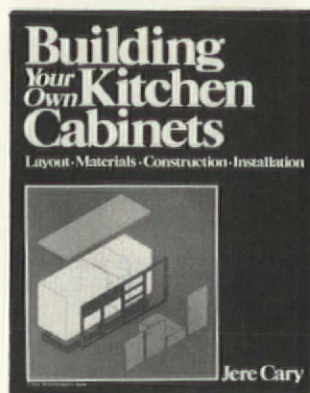

Wallpapers by Richard C. Nylander

Fabrics by Jane C. Nylander

These newly published books hold carefully screened, usable information for those who are ready to start decorating their old homes. The wallpaper book covers the years 1700 to 1910, with major emphasis on 1870 to 1910. The fabrics book (extensively updated and redesigned for this edition) covers the years 1790 through 1900. Both books provide you with current information on sources: You'll find out which manufacturers are producing materials for the period of your house. All the fabrics and wallpapers listed in these handsome, illustrated books were chosen for their appropriateness, so much of the hard work has been done for you. Total 287 pages, softbound.

Order No. 43

Two Volumes \$21.90 postpaid



The Kovels' Collectors' Sourcebook by Ralph & Terry Kovel

We've finally found the book that's perfect for collectors of every interest. In this amazing book, you'll find price guides, sources of supplies, books and newsletters on your subject, clubs of like-minded enthusiasts, and more. The Kovels have neatly organized a tremendous amount of information into an easy-to-follow format. Part I tells you all the goings-on in 87 different collectible categories, from beer cans to ivory and from pewter to barber poles. Part II has information about appraisals, auction houses, booksellers, conservators, matching services, professional associations — even about how to decode advertising copy. 374 pages, softbound.

Order No. 44

\$15.95 postpaid

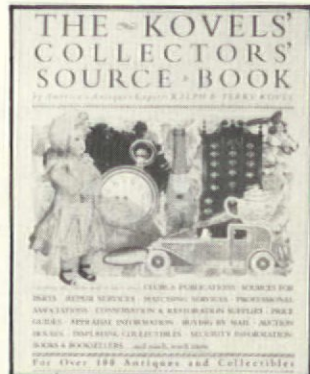

The Naughty Nineties

This book first came to our attention when someone gave it to us as a gift. We've had so much fun with it since then that we decided to offer it to other members of the OHJ Family! It's not easy to describe this book. Perhaps its subtitle says it best: "A Saucy Pop-Up Book For Adults Only." It's the sort of gift most likely to get passed around. This book is loads of fun — sort of a comic relief from the hard work of house restoration. And while it certainly is naughty, it's not at all tasteless or offensive. We think you'll agree: It's the perfect present for all vibrant Victorians! Hardbound.

Order No. 45

\$11.95 postpaid



ALL-TIME FAVORITES

Paint Magic by Jocasta Innes

All the traditional decorative painting techniques are spelled out, with step-by-step instructions on how to adapt them for contemporary tastes and needs. Dragging, sponging, rag-rolling, color-washing, glazing, stenciling, stippling, japanning, gilding, graining, tortoise-shelling, spattering — if you don't know what each of these is and how to do it, here's the book for you. 120 full color photographs, plus dozens of explanatory drawings. 237 pages, hardbound.

Order No. 24

\$31.95 postpaid

Old House Woodwork by Ed Johnson

This is the first book we've found that deals exclusively with restoring architectural woodwork. The author is a skilled restorationist, and his book combines a sensitive attitude toward preservation with practical advice and step-by-step instructions. It has the best information of any book we know on stripping paint from wood and then selecting a finish. If you have to get to work on your doors, trim, siding, staircases, floors, etc., this book is just what you need. 184 pages, softbound.

Order No. 23

\$14.95 postpaid

Century Of Color by Roger Moss

This book is the most comprehensive and practical guide available to authentic, historically accurate, exterior paint colors. It features 100 color plates — from "plain" Victorian and vernacular Classic houses to showcase homes. There are also Affinity Charts, with 200 color combinations diverse enough to stimulate everyone's aesthetic taste. As a special bonus, the book comes with a large color chip card displaying the 40 colors of the Sherwin-Williams authentic paint line, Heritage Colors. 108 pages, softbound.

Order No. 20

\$15.00 postpaid

The Art Of Decorative Stenciling by Adele Bishop and Cile Lord

This beautiful volume isn't a history book or a pattern book — there are plenty of those. What these stenciling experts have written is the best book we've ever seen on how to stencil. There are clear, easy-to-follow chapters on making stencils, choosing brushes, tools, and paint, and on application methods. They explain all the details, including layout — even how to build up complex patterns from multiple stencils. 198 pages, softbound.

Order No. 36

\$16.95 postpaid

The Tasteful Interlude by William Seale

256 rare photographs picture the furnishing and decorating styles of primarily middle-class American homes and provide the fascination of this handsome book. The photos have been retrieved by Seale from historical archives and private sources and are a visual chronicle of changing American taste from the Civil War to World War One. A helpful guide to anyone interested in interior decorating of period homes. 284 pages, softbound.

Order No. 13

\$14.95 postpaid

Victorian Architecture

1-volume facsimile of the 1873 & 1881 editions

This comprehensive guide to Queen Anne, Eastlake, Gothic Revival, and Italianate houses of the 1870s and 1880s contains thousands of architectural pattern drawings: cornices, brackets, windows and window caps, bays and dormers, doors, scrolls, sawn ornaments, stairs, newels, mantels, porches, architraves, fences, ironwork. Floor plans, elevations, and perspective drawings are included. 178 pages, softbound.

Order No. 16

\$15.95 postpaid

FOR INTERIOR STRIPPING

And Small Exterior Jobs

Nearly 10,000 OHJ subscribers have bought the Master Heavy-Duty Heat Gun, and discovered the best tool for stripping paint from interior woodwork. This electric-powered heat gun softens paint in a uniform way, so it can be scraped off with a knife. A small amount of chemical cleaner is suggested for tight crevices and clean-up, but the Heat Gun does most of the work. It reduces the hazard of inhaling methylene chloride vapors present in paint removers.

Another major safety feature is the Heat Gun's operating temperature, which is lower than a propane torch or blowtorch. Thus, the danger of vaporizing lead is minimized.

The Master HG-501 Heat Gun is an industrial-grade tool. It operates at 500-750°F, draws 15 amps at 120 volts, and has a rugged, die-cast aluminum body — no plastics! It isn't cheaply made or cheaply priced. But paint remover is going for \$15-20 per gallon ... so if you use the Heat Gun just a few times, it pays for itself.

The Heat Gun comes with complete operating and safety instructions, and is backed by The Old-House Journal Guarantee: If your unit should malfunction for any reason within two months of purchase, return it to us and we'll replace it.

You may order your Master HG-501 Heat Gun by filling out the Order Form in this Supplement, or by sending \$72.95 (includes fast UPS shipping) to The Old-House Journal, 69A Seventh Avenue, Brooklyn, NY 11217.

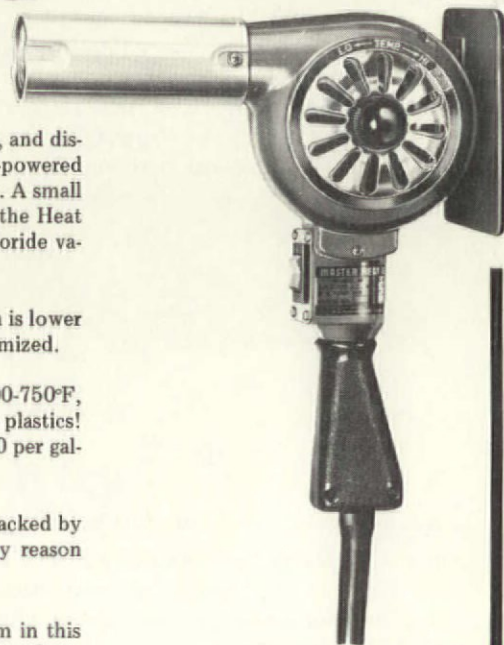

The Two Best Heat Tools For Stripping Paint

The Heat Gun has been a lifesaver for the 10,000 OHJ subscribers who have to strip paint from ornamental woodwork, shutters, window frames, and similar surfaces. But we're often asked if there's a comparable tool for larger jobs such as exterior clapboards (a task that takes forever with the Heat Gun). After testing all the available tools, the editors of The Old-House Journal are ready to recommend the best tool for the job: the HYDElectric Heat Plate.

Drawing 7 amps at 120 volts, the Heat Plate's electric resistance heating coil heats the surface to be stripped to a temperature of 550-800°F. A nickel-plated steel shield reflects the maximum amount of heat from the coil to the surface. And among the Heat Plate's safety features is a wire frame that supports the unit, so you can set it down without having to turn it off.

Gripping the Heat Plate by its cool plastic handle, you hold it close to the paint surface and soften the paint. Then you move

the plate along and scrape away the loosened paint with a scraping tool. It's that simple! With a little practice, you can remove paint rapidly in one continuous motion. This procedure may remind you of using the Heat Gun, but that's where the similarity ends. The Heat Plate isn't efficient for the small fussy work that's so simple with the Heat Gun: mouldings, corners, recesses, turned wood such as balusters. What the Heat Plate is designed for — and does better than anything else — are the big jobs: clapboards, shingles, flush doors, large panels, and any flat surface.

The Heat Plate comes complete with operating and safety instructions, and is backed by The Old-House Journal Guarantee: If your unit should malfunction for any reason within two months of purchase, return it to us and we'll replace it.

For the HYDElectric Heat Plate, fill out the Order Form in this Supplement, or send \$39.95 (includes UPS shipping) to The Old-House Journal, 69A Seventh Ave., Brooklyn, NY 11217.



FOR EXTERIOR STRIPPING

And Any Large Flat Surface

Special Holiday Supplement

Clip-And-Mail

Holiday Order Form



Just check the boxes
on the other side to conveniently get quality
mail order merchandise for the old-house
lover . . . for your home, or as terrific gifts!



① Cut Along Dotted Line

④ Fold Flap Over And Tape Shut

NO POSTAGE
NECESSARY
IF MAILED
IN THE
UNITED STATES

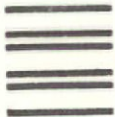
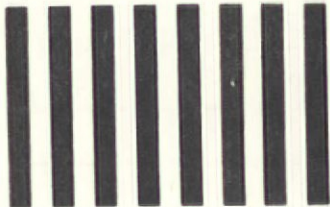

BUSINESS REPLY MAIL
FIRST CLASS PERMIT NO. 31609 BROOKLYN, N.Y.

POSTAGE WILL BE PAID BY ADDRESSEE

**The
Old-House
Journal**
69A Seventh Avenue
Brooklyn, NY 11217

③ Fold Up Along This Line

Important

Before sealing your order:

1. Be sure that your name, address and zip code are printed clearly or typed.
2. Check to see that you have given a **STREET ADDRESS** — not a P.O. Box — if your order includes a Catalog, Back issues or a Heat Gun. We ship via United Parcel Service, and they cannot deliver to a P.O. Box.
3. Verify that your check or VISA credit card information is enclosed.

② Fold In End Flaps

THIS PAGE FOLDS INTO A SELF-MAILER ENVELOPE!

Mail this postage-paid envelope with your check for prompt service.

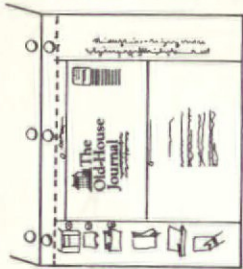

(1) Cut Along Dotted Line



(2) Fold In End Flaps



(3) Fold Along Center Line



Don't Forget Your Check . . .



(4) Fold Over Flap & Tape Shut



Drop In The Mail!

Holiday Order Form

Order No.	Item	Quantity	Price	Total
90	The Restoration Encyclopedia		\$59.95	
41	Salvaged Treasures		\$37.50	
42	Building Your Own Kitchen Cabinets		\$13.95	
43	Wallpapers and Fabrics (2 books)		\$21.90	
44	The Kovels' Collectors' Sourcebook		\$15.95	
45	The Naughty Nineties		\$11.95	
24	Paint Magic		\$31.95	
20	Century Of Color		\$15.00	
13	The Tasteful Interlude		\$14.95	
23	Old House Woodwork Restoration		\$14.95	
36	The Art Of Decorative Stenciling		\$16.95	
16	Victorian Architecture		\$15.95	
11	Master Heavy-Duty Heat Gun		\$72.95	
10	HYDElectric Heat Plate		\$39.95	
12	The New 1984 OHJ Catalog		\$9.95	

Merchandise Total _____

NY State Sales Tax _____

Total Enclosed _____

My order totals \$35 or more. Please send me a *FREE* OHJ Work Apron.
(This total can include Gift Subscriptions.)

NAME _____

ADDRESS _____

CITY _____ STATE _____ ZIP _____

 **The
Old-House
Journal** NOV83

All prices postpaid,
and include
fast UPS shipping.

NOTE: If your order includes books or merchandise, you must give us a STREET ADDRESS — not a P.O. Box number. We ship via United Parcel Service (UPS), and they will not deliver to a P.O. Box.

Please clip this page and mail together with a check payable to The Old-House Journal to THE OLD-HOUSE JOURNAL, 69A Seventh Avenue, Brooklyn, NY 11217.

Save Up To \$18 On Gift Subscriptions!

Because The Old-House Journal doesn't carry paid advertising, gift subscriptions are a very important source of revenue for us. So we'd like to offer you a deal that will benefit us both. Give gift subscriptions to your friends, and we'll give you a very attractive holiday discount.

Here's how it works: Buy the first subscription at full rate. If you like, it can be an extension of your own subscription. (If it is your own renewal, please enclose your current mailing label.)

Your second gift subscription costs only \$13. Your third — \$10. And your fourth gift is only \$7.

You can save up to \$18 if you get all four. But order now — these holiday discounts expire December 31, 1983.

<i>First One-Year Subscription \$16</i>	Enter Amount Here \$ _____	<i>Send Gift Subscription (Or Your Renewal) To:</i> Name _____ Address _____ City _____ State _____ Zip _____	Check If This Is A Renewal <input type="checkbox"/>
<i>Second One-Year Subscription \$13</i>	Enter Amount Here \$ _____	<i>Send Gift Subscription To:</i> Name _____ Address _____ City _____ State _____ Zip _____	Check If This Is A Renewal <input type="checkbox"/>
<i>Third One-Year Subscription \$10</i>	Enter Amount Here \$ _____	<i>Send Gift Subscription To:</i> Name _____ Address _____ City _____ State _____ Zip _____	Check If This Is A Renewal <input type="checkbox"/>
<i>Fourth One-Year Subscription \$7</i>	Enter Amount Here \$ _____	<i>Send Gift Subscription To:</i> Name _____ Address _____ City _____ State _____ Zip _____	Check If This Is A Renewal <input type="checkbox"/>
Total Amount Enclosed \$ _____	<i>Your Name and Address Here:</i> Your Name _____ Address _____ City _____ State _____ Zip _____		

With every Holiday Gift Subscription, we will send a handsome Greeting Card with your name hand-lettered as gift donor.

To make sure the gift card arrives in time for Christmas, return this form and your check before December 10, 1983.

Your name as you want it to appear on Gift Card:

From _____

NOTE:
This offer
expires on
December 31,
1983



**The
Old-House
Journal**

69A Seventh Avenue Brooklyn, New York 11217 212-636-4514

XMNOV

NEW!



THE OHJ CATALOG

1 The Old-House Journal Catalog is the "Yellow Pages" for pre-1939 houses. In this comprehensive buyer's guide are listed hundreds of hard-to-find old-house products . . . the kind that hardware store clerks will assure you "just aren't made anymore."

2 The Catalog is the most complete & authoritative directory of the field. 1,251 companies are listed. There are almost 10,000 individual items and services offered for sale. Every listing is carefully screened for appropriateness by the editors of The Old-House Journal. In the Catalog, you won't find vinyl siding, or the phoney "olde time" gadgets that litter the advertising pages of the home magazines.

3 The Catalog is crammed with NEW information: there are 259 NEW companies that didn't appear in the previous edition. Also, 773 of the other listings contain NEW information — new products, new prices, new literature, new addresses, new phone numbers. But that's not all. This Catalog also has a brand new feature: A State Index that groups Catalog companies by city and state. This allows you to quickly locate the old-house suppliers that are nearest you.

4 And for companies that aren't near you, the Catalog gives all the information you need to do business by mail or phone. The Company Directory tells you the full address, phone number, & what literature is available — and the price, if any.

5 The Catalog Index is meticulously cross-referenced. For example, if you're trying to find "ceiling rosettes," the Index tells you that the item will be found under "ceiling medallions." That Index is your guide through the biggest Catalog ever: 208 pages, full 8½ x 11 pages, soft-cover. But even though it's bigger than ever, the price is still the same as last year's.

6 Save \$2.00 as a subscriber to The Old-House Journal. Normally, the Catalog costs \$11.95 postpaid, but as a member of the OHJ Network, you can order a Catalog for only \$9.95, including fast shipping via United Parcel Service. To get your Catalog, just check the box on the Order Form in this Supplement. (And if you're shopping for any of your old-house friends, the OHJ Catalog makes a great Christmas gift, too!)

 **The
Old-House
Journal®**

69A Seventh Avenue,
Brooklyn, New York 11217

NO PAID ADVERTISING

Postmaster: Address Correction Requested

BULK RATE
U.S. Postage
PAID
New York, N.Y.
Permit No. 6964

G3-WEBER-54 14P

8 M
MAY84

KEITH WEBER
14 S ELDORADO ST
SAN MATEO

CA 94401**

Special Holiday Supplement