

Restoration and Maintenance Techniques
For The Pre-1939 House

July 1985 / Vol. XIII No. 6 / \$2.

The Old-House Journal

Return To Awnings

by J. Randall Cotton

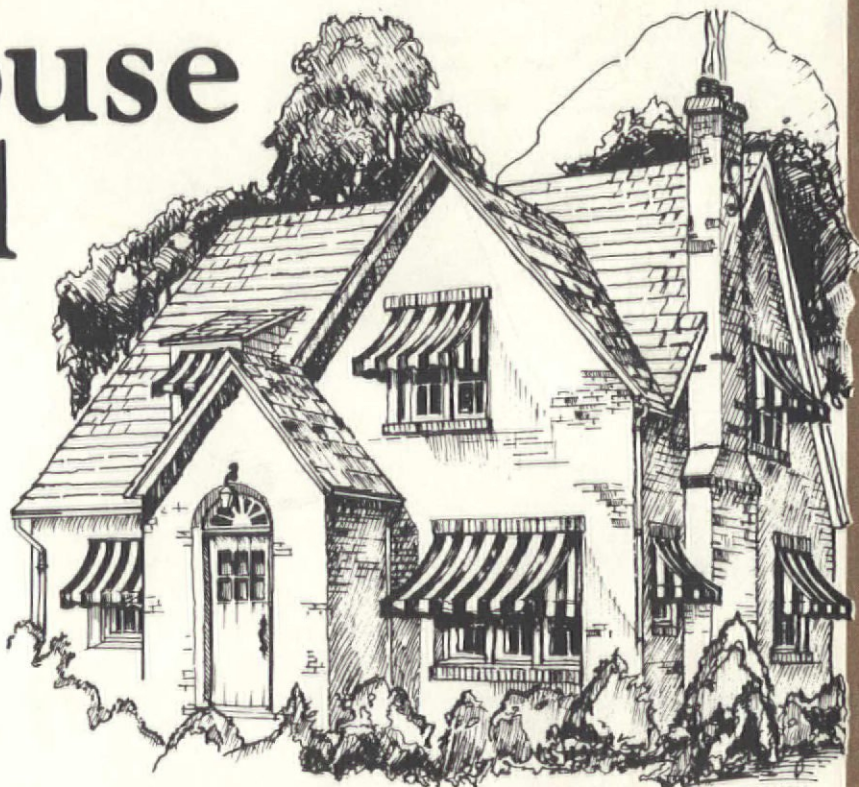

AH, THE ADVANTAGES OF AWNINGS -- protection from the sun, energy savings, architectural interest. The best payback, though, is intangible. Picture in your mind a typical street in an older neighborhood: Awnings just naturally ought to be an integral part of the scene, adding bright splashes of color to the rows of porches, shading the people who seek respite on a hot summer afternoon.

UNFORTUNATELY, modern conveniences such as air-conditioning have made awnings less common along the streetscape. But more and more old-house owners are deciding that awnings are just what they need to complete their restoration -- and cool off their homes, too! We're happy to say that awnings are still readily available in traditional styles, colors, and materials. In fact, thanks to an array of modern but compatible fabrics, they now come in a greater range of colors, and will last longer than ever before.

cont'd on p. 126

YOU'VE GOT AN OLD HOUSE WHEN..... 116
A SCAFFOLDING PRIMER..... 117
ASK OHJ..... 124
AWNING SOURCES..... 129

RESTORATION PRODUCTS..... 131
REMUDDLING OF THE MONTH..... 134

In the next issue...
WOOD CORNICE REPAIRS

You Know You've Got An Old House When...

by Patrick Kee, Ida Grove, Iowa

... the living room light dims whenever you run the Dust Buster.

... you get personal Christmas cards from natural gas company executives you don't even know.

... everyone in town insists "that isn't the color the house used to be" -- but no one remembers for sure what color it was.

... a 4-ft. step ladder is useless to you.

... a 6-ft. Christmas tree is 'just too small.'

... the only man who knew where your city water shut-off is died in 1919.

... your change dish includes plaster washers, finish nails, and a radiator key.

... the local lumber yard can supply only one out of every ten items you want.

... once or twice a year, when you're walking down that long upstairs hall, you feel like someone is behind you -- but you never, ever turn around to look.

... you get more evening phone calls from siding salesmen than from your mother.



... you walk four blocks in the dead of winter because you refuse to use the parking lot 'they' tore down the old courthouse to build.

... you'd rather read a paint-chip chart than the sports section.

... you think one of these days a loose attic floorboard will yield Old Man Smith's unbanked hoard of gold coins AND the original blueprint of the house.

... you start writing notes to future owners and hiding them behind the wainscoting and mop boards.

... the terms 'warmth' and 'patina' replace 'worn out' and 'dirty.'

... you're willing to ruin your vision needlepointing upholstery for a footstool you could crush with one good squeeze.

... you feel there's nothing amusing or quaint about the wardrobe of Sherlock Holmes and Dr. Watson.

... people are talking about 'tennis elbow' or 'Army arches,' and you want to tell them about 'scraper knuckle' and 'rung foot.'

... you drop someone from your guest list for referring to your Bungalow as a Victorian.



The Old-House Journal®

Editor

Patricia Poore

Production Editor

Cole Gagne

Senior Technical Advisor

Larry Jones

Assistant Editor

Sarah J. McNamara

Contributing Editors

Walter Jowers

John Mark Garrison

Roland A. Labine Sr.

Architectural Consultant

Jonathan Poore

Circulation Supervisor

Barbara Bugg

Circulation Assistant

Jeanne Baldwin

Special Sales

Joan O'Reilly

Office Manager

Tricia A. Martin

Catalog Editor

Sarah J. McNamara

Publishing Consultant

Paul T. McLoughlin

Publisher

Clem Labine

Published by The Old-House Journal Corporation, 69A Seventh Avenue, Brooklyn, NY 11217. Telephone (718) 636-4514. Subscriptions \$18 per year in U.S., \$36 per year in Canada (payable in Canadian funds). Published ten times per year. Contents are fully protected by copyright and must not be reproduced in any manner whatsoever without specific permission in writing from the Editor.

We are happy to accept editorial contributions to The Old-House Journal. Query letters that include an outline of the proposed article are preferred. All manuscripts will be reviewed, and returned if unacceptable. However, we cannot be responsible for non-receipt or loss -- please keep copies of all materials sent.

Printed at Photo Comp Press,
New York City

ISSN: 0094-0178

NO PAID ADVERTISING

OHJ's next issue will be the August-September double issue.
Look for it in early September.

A Scaffolding Primer

With Basic Guidelines On The Use Of Welded Tubular-Frame Scaffolds

by The Old-House Journal Technical Staff
Illustrations by Larry Jones

THIS IS AN ARTICLE for people who know nothing about scaffolds. Our intention is to familiarize you with scaffolding so you'll know when to use it (it can be safer than an extension ladder) and what options you have. No magazine article can make you a skilled scaffold erector, however. Only you know whether you've got enough experience and information to erect safe scaffolding for your particular needs.

SOMETIMES you have to tackle a job that you can't do from the ground and shouldn't do from a ladder. Cornice restoration is an example: It requires access to the whole cornice; tools and materials have to be handy; workers need both hands free to do the work. Scaffolding fits the bill. Other old-house jobs that often require scaffolding include masonry repointing, major repairs to gutters and soffits, residing and reshingling, whole-house paint stripping and repainting, and building a porch or addition.

Scaffolding Types

YOU MAY HAVE SEEN some of these kinds of scaffolding being used around the neighborhood. Each type is right for some jobs, inappropriate or dangerous for others.

- Built-up scaffolding -- A temporary elevated platform, built from the ground up, used to support workers and materials. There are several types of built-up scaffolding.

- Welded tubular-frame scaffolding -- Built-up scaffolding consisting of metal frames with braces and various accessories. This is the most common type of scaffolding, used by contractors as well as homeowners.

- Tube-and-coupler scaffolding -- Built-up scaffolding consisting of tubing that serves as posts and beams, with special couplers that

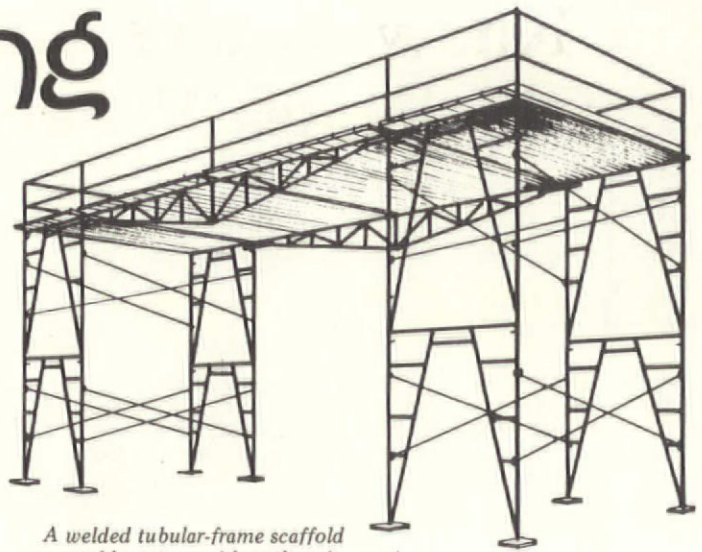

A welded tubular-frame scaffold assembly, set up with putlogs (trusses) to bridge large obstructions on the ground.

join the various members. This type of scaffolding is quite popular in Europe. It has to be erected by experienced crews.

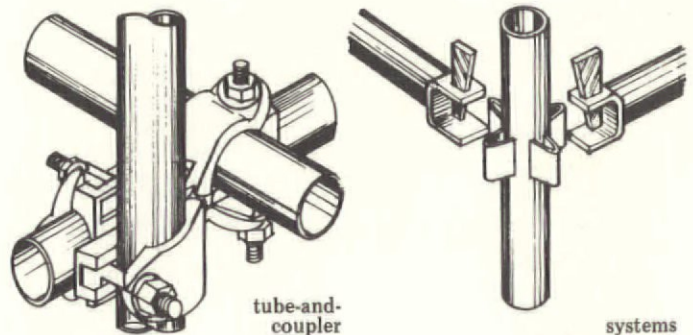

- Systems scaffolding -- An American hybrid similar to tube-and-coupler scaffolding. Parts are field-assembled by the use of proprietary pipes, wedges, etc. It's useful on complicated jobs, where it can be built to conform to odd shapes. Easier to erect than tube-and-coupler, but should still be erected by an experienced crew.

- Shoring -- A common type is similar to welded tubular-frame scaffolding. It's not really scaffolding, but rather temporary support and bracing that holds up structural members (instead of workers and materials) during construction or repair.

SPECIAL THANKS to the following for their help:

Joe Budd, Scaffolding & Shoring Institute, Cleveland, Ohio.
Kenneth J. Buettner, Vice-President of Your Scaffold Equipment Corp., Long Island City, N.Y.
Warren Duncan, Waco International Corp., Houston, Texas.
Alan Keiser, Havertown, Penn.
Victor D. Saleeby, Executive Vice-President of Scaffold Industry Association, Van Nuys, Cal.

Drawings adapted from *A Guide To Waco Scaffolding* and *SIA Membership Directory & Handbook*.



shoring

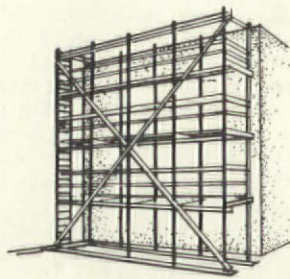

pole

● **Pole scaffolding** -- Built-up scaffolding made of wood; the "original" scaffolding before welded-tube types came along. Still used today by contractors whose experienced carpentry crews understand how to put it up. Can be used for carpentry, painting, or masonry work.

● **Rolling scaffolding** -- Built-up scaffolding with wheels, usually used indoors. It can be used outdoors on, say, a fully paved flat perimeter for work at low heights.

● **Built-out scaffolding** -- Scaffolding that is built out from the wall instead of up from the ground or suspended from above. It can be economical in some circumstances as it saves the renting and erection of very large scaffolds. It is used more in new construction than in repair work, and usually at greater heights than we come up against working on our houses. For old-house applications, it should be built by an experienced crew.

● **Swing staging** -- Also known as suspended scaffolding, this is a scaffold platform suspended by wire or ropes from an overhead support system. It's useful for repair work that requires a short stay in a location before moving to another (e.g., window washing, painting a cornice or window trim, minor masonry work). Most cities and towns require users of swing staging to have a rigger's license, because it's dangerous for inexperienced workers and, sometimes, for people below.

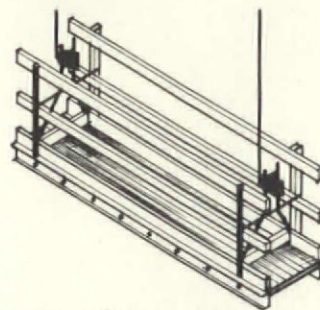

swing staging

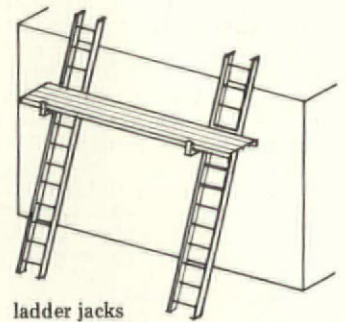

ladder jacks

● **Ladder jacks** -- Made up of metal jacks that attach to the rungs or side rails of an extension ladder to hold a work platform. **Must** be tied into the building. Not to be used for heavy (masonry or carpentry) work or for heights above one storey, but they're fine for light work such as painting and window repair at heights around 10 feet or so.

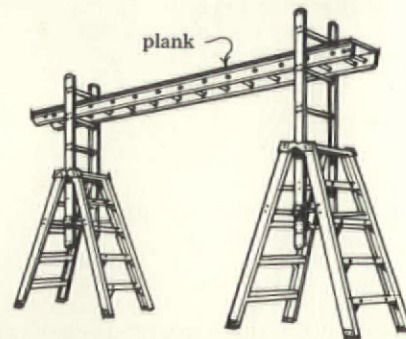

trestle-ladder

● **Trestle-ladder scaffold** -- Specially designed step-ladders that extend to hold a platform. Used for the same kinds of jobs as the ladder jack, but is self-supporting. Useful and safe for jobs such as work on a porch ceiling.

● **Pump jacks** -- A popular form of scaffolding that uses spiked 2x4s, foot-operated jacks, and planks. Often used by masons and other workers who need to move up and down a wall surface at short intervals, and who load building materials onto the platform. Okay for use at low heights, but must be braced or

The Worst Can Happen

by Alan D. Keiser

WHEN MY FRIENDS at The Old-House Journal asked me to comment on an article about the basics of erecting and dismantling exterior scaffolding, my first reaction was "don't publish it." The reason for this is simple: Erecting and dismantling scaffolds is extremely dangerous work. I know this from tragic first-hand experience. I was lucky — I survived a 40-foot fall from a scaffold that collapsed while I was dismantling it. I had earned a reputation for being cautious and for being safety conscious. Nonetheless, the worst happened. It's important for every non-professional (and professional as well) who sets up and takes down scaffolding to never forget that the unexpected can happen in this very dangerous work.

Because our readers must deal with scaffolds at times, despite the danger, I think The Old-House Journal should lay out the basics. However, my advice is, quite frankly, don't set up and dismantle scaffolding yourself. If you're working at a height greater than 10 feet, hire a professional to do it. The risks are too great and the results of a misstep can be catastrophic. This is work best left for the professional.

If you can't find a professional to do it or if you insist that you do know enough to do it safely, then be sure to do all your homework. Be sure you do in fact know what you are doing. Follow *all* safety rules and guidelines. Above all, do not ignore them because someone says, "Oh, nobody bothers with that, it's okay." It's imperative that you do everything possible to even the odds.

This article provides basic advice. Read the article critically, then go find out as much additional information as you possibly can. At the bare minimum, when you are erecting and dismantling a scaffold, follow these four rules:

1. Have a step-by-step plan of action before you begin the work, so you'll be able to predict what *could* go wrong.
2. Be aware of your environment and changes in the environment (weather, people, weight of materials, the scaffolding itself). Change your plans if conditions change.
3. Never hurry.
4. Never "fly tired."

Alan D. Keiser is former Director of the National Trust's Restoration Workshop at Tarrytown, N.Y.

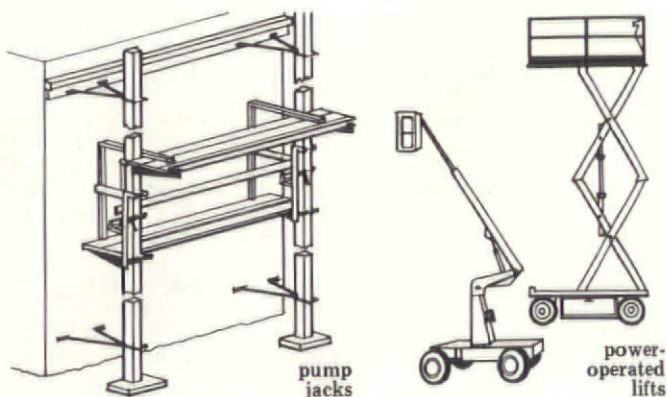

anchored to the building or may buckle even as low as 20 feet. Safety features such as guard rails are often omitted, so we recommend that only experienced workers use them.

- Power-operated lifts -- Scissor lifts, cherry pickers, hydraulic personnel lifts ... these motor-driven lifting devices are designed for specific tasks such as working on electrical lines. Sort of expensive because you're hiring an operator along with the machinery. But because of their speed and flexibility you might consider renting one for inspections or a quick job like putting a cupola or tower roof in place.

WELDED-TUBE SCAFFOLDING is the most common and available type of scaffolding, useful for most residential projects, and relatively simple to understand, assemble, and work from safely. The system's modular form, though, makes it inflexible when used around highly complex buildings (such as Queen Anne houses, with their projecting bays, oriel windows, turrets and balconies). If your scaffolding has to reach around tricky projections, you may have to use more versatile "systems" scaffolding. Ask your supplier.

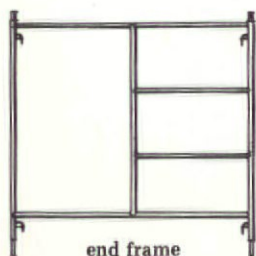

end frame

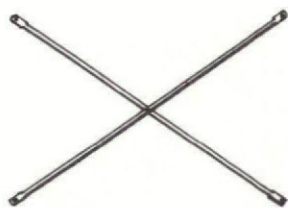

cross brace

BUILT-UP SCAFFOLDING has to be put up much like a building: It needs a proper foundation, structural members must be straight and plumb, and the whole construction has to withstand loads and stresses. If it's poorly erected, it is extremely unsafe, and may tip, move, or buckle.

SOME OLD-HOUSE OWNERS think nothing of renting and erecting scaffolding themselves. If the equipment is in good condition, written instructions provided, and safety accessories used, they may be perfectly safe doing so. An intelligent and cautious handyperson should have no trouble erecting scaffolding up to 20 feet or so on firm, level ground.

WHEN THE JOB is at all complicated, however, we recommend that a professional crew erect, move, and disassemble the scaffold. If you're a novice, consider all of the following to be "complications": scaffolding to higher than the second storey; sloping ground; sunken or clay soil; difficult setups such as over a porch or around a projecting bay. Working from safely erected scaffolding is much less dangerous than erecting and dismantling it.

BEFORE PLUNGING AHEAD, take into account these sobering thoughts:

- Mistakes or oversights aren't merely inconvenient or expensive; they can kill you.
- Each scaffolding setup is different; there are lots of considerations and only experience can tell which require special adaptations, accessories, safety equipment, etc.
- There are many types of scaffolding and within each type, different brands are non-generic. You can't interchange parts because fastening devices and accessories vary from brand to brand. So obviously, we can't give you all the "how-to" here.

FINISH READING this article even if you've decided to hire the scaffolding setup done. (And if you've decided to hire out the whole job, it still falls to the owner to do regular inspections -- you may have to climb the scaffold for a look now and then.) You'll want to know something about what a safe scaffold looks like before you go up.

Renting A Scaffold

TRY THE **YELLOW PAGES** under "Scaffolding Equipment -- Rental." In some cases, there will be companies specializing in scaffold rental. The person behind the counter may even know what he's talking about and may be able to supply a professional crew to erect and disassemble for you.

BUT DON'T COUNT ON IT. This is a "renter beware" situation. If you do find a serious scaffold-rental place, you're not going to be an important customer. (They'll be used to dealing with contractors who rent often and in large quantities.) If you're forced to deal with an all-purpose rental company (the kind that also has baby carriages and garden tillers), you may find poorly maintained equipment and little advice. In either case, you'd better know as much as you can about what you want before you walk in the door.

YOU CAN ALSO CALL the Scaffolding Industry Association (SIA) in Van Nuys, Calif., at 818-782-2012. They may be able to give you the name of a member (a scaffold dealer) in your area.

KEEP IN MIND that you should not mix scaffold brands. Because you want to find a company that has a large enough inventory to supply all the parts you need from one manufacturer, it pays to go out of your way (even many miles to another town) to find a serious scaffold rental company.

IF YOU CAN'T FIND what you need, and the written instructions to use it safely, and a crew to erect and dismantle the scaffold,

Welded Tube Scaffolding Parts

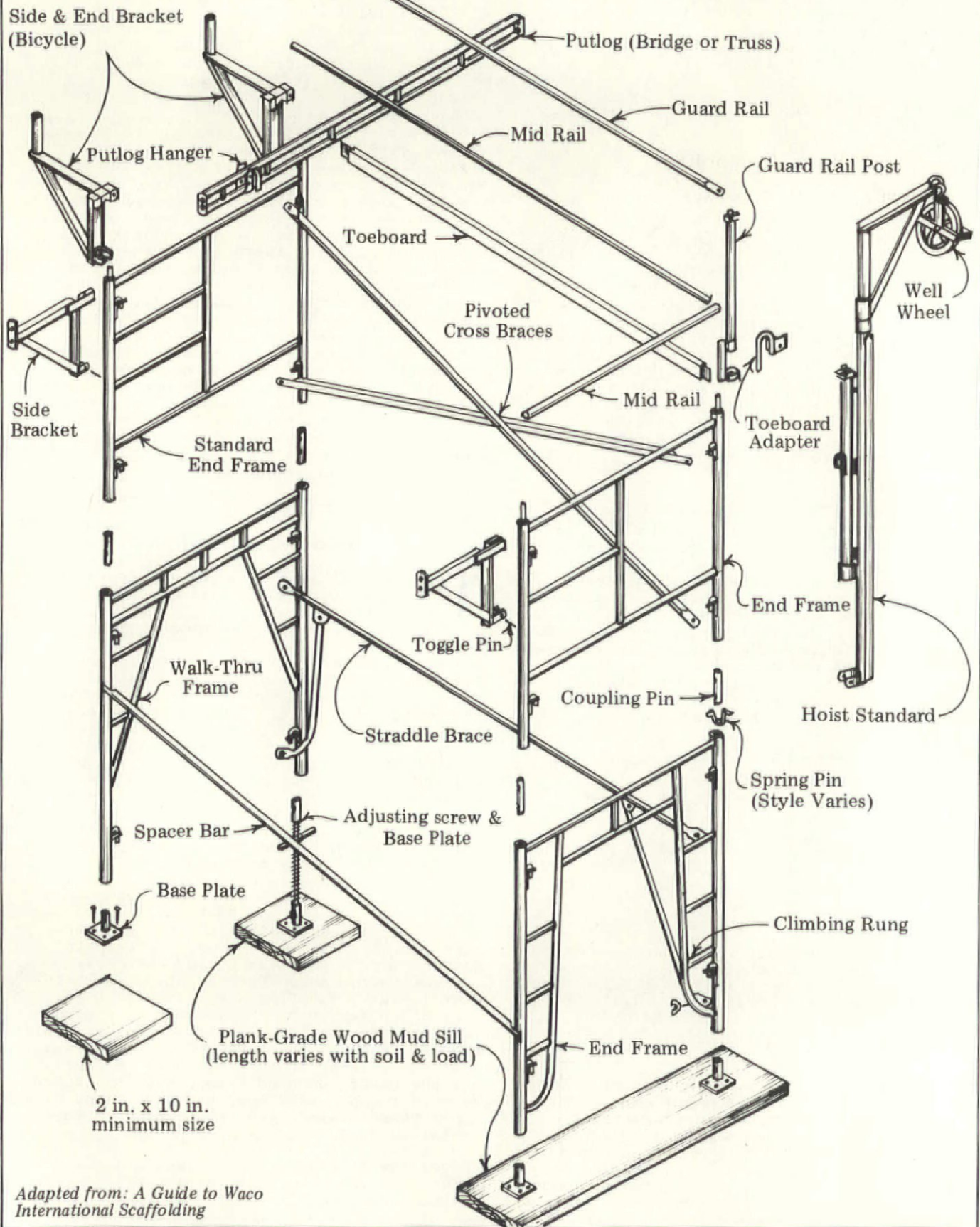

Adapted from: *A Guide to Waco International Scaffolding*

seriously consider hiring the work done -- the contractor's crew will come with their own scaffolding.

BY THE WAY, if the job will take longer than eight to twelve months, look into buying rather than renting scaffolding. It may be cheaper. And when you rent, come prepared to pay a BIG (refundable) deposit -- maybe as much as the cost of the scaffolding.

Basic Components

WELED TUBULAR-FRAME scaffolding is modular, as shown in these illustrations. Length of a section is determined by the diagonal brace that spans between the two end frames. Narrower sections are stronger, and so used for heavier loads such as bricks. Section lengths around 8' are for medium-duty loads such as lumber. Ten-foot spacing is light-duty -- for jobs that don't require significant loading beyond the weight of the workers. (The industry booklet noted at the end of the article explains exactly what setup you need for various loads.)

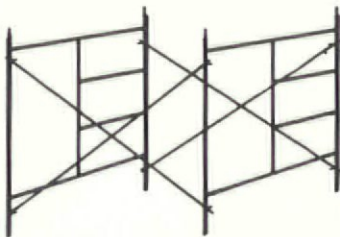

THE FRAME SECTIONS can be tied together to make any run length. A greater run means renting more scaffolding -- but don't fall into the trap of not renting enough. You'll waste time and money moving the scaffold from place to place. Every time a scaffold is moved, it has to be largely disassembled.



METAL FRAMES come in varying heights to allow fine-tuning the height of the towers. Taller frames are usually used at the bottom of the tower (they're easier to walk under); shorter ones usually used at the top. (The opposite is true if the terrain is extreme in slope.) Generally, it's better to build a scaffold a little short than a little tall: Stretching is less tiring than stooping. (Stretching up, that is -- stretching out is dangerous.)

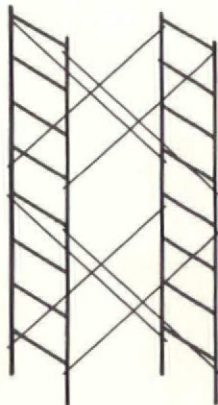

standard, narrow, and walk-through end frames

SOME NEWER scaffolding frames have an integral ladder -- convenient, but hard to climb because it's plumb vertical. You can rent an access ladder to tie to the scaffolding. Most people find a ladder easier and safer to climb than the widely-spaced rungs of the scaffold itself.

Parts & Accessories

INSPECT ALL THE COMPONENTS carefully when the crew arrives with the scaffolding. Make sure all locking devices work properly. Inspect the welds for failure. Reject badly rusted or bent metal parts. Also reject planks with warps, splits, or unsound knots.

WHETHER YOU'RE experienced enough to set up your own scaffold or just checking the crew's work, here are some important flags:

- Wooden 'mud' sills are used to support scaffolding on soft ground. The scaffold legs should have base plates which must be securely fastened to the sills. DO NOT allow the use of swivel bases to correct major out-of-level conditions. Don't allow support "sandwiches" of concrete block, boards, and shims.

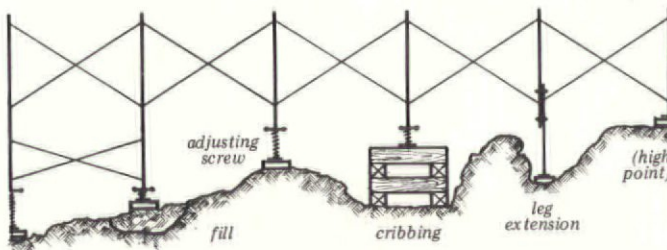

Ways To Level Scaffolding

- Each leg also has an adjustable screw jack, necessary for keeping the whole scaffold plumb and level. After each tier of scaffolding is assembled, the crew should check the assembly for plumb (in both directions) and level, and correct discrepancies before moving on to the next tier. Out-of-plumb or out-of-level scaffolding is subject to uneven loading and instability -- the higher the scaffold, the more dangerous this is.

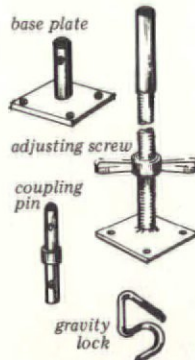

- Although many codes don't require that the scaffolding frames be locked together vertically, and the rental company may tell you "nobody uses uplift pins," THEY ARE NOT OPTIONAL. ALWAYS INSIST THAT UPLIFT PINS (locking pins) BE USED. You never know when or why you might have an unexpected need for protection against uplift: uneven loading on the platform, wind

- Guard rails, midrails, toeboards, screening, and all other safety features required by local codes or useful on your job must be installed on every work platform. They are not optional. You may be told that some accessories aren't used. Take it upon yourself to find out what the accessories are for, then insist on them.

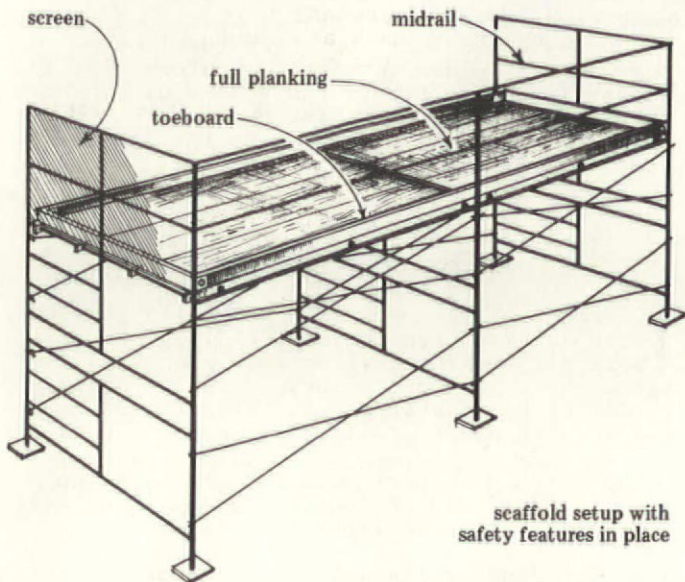

● Some setups require additional parts. Side or end brackets (called "bicycles") extend the work platforms; novices shouldn't work on extended scaffolding more than ten feet high. Hoists safely lift materials to the platform; working with a hoist from heights is tricky and requires experience. Bridges (called "putlogs") are used for reaching over obstructions or projections; experienced crews should set these up.

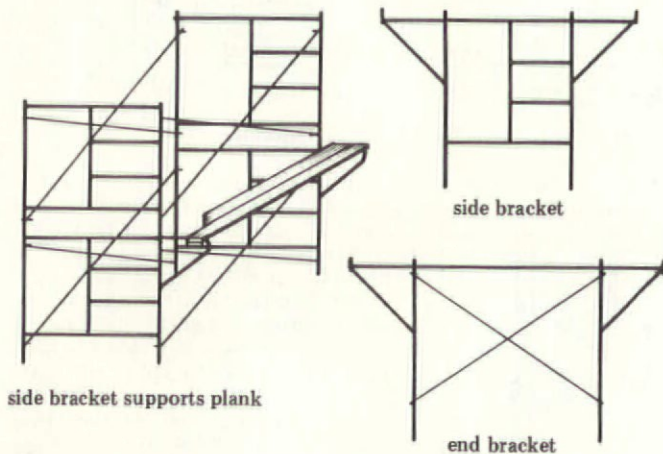

● Be sure each working platform is fully "floored" without gaps in the planking. If you'll need to work at several levels simultaneously, you would find cross-bracing would be in the way. For cases like this, use straddle braces.

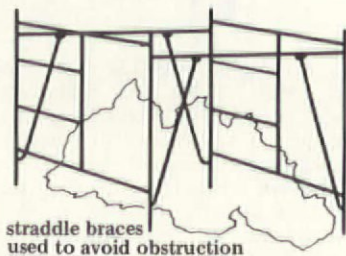

ABOUT PLANKING: It's not as easy as it used to be to get good scaffolding planks. According to the Scaffold Industry Association Newsletter: "Lumber grading authorities project a declining supply of lumber...for scaffold grade planks. This means (you) must be more vigilant in culling out bad planks."

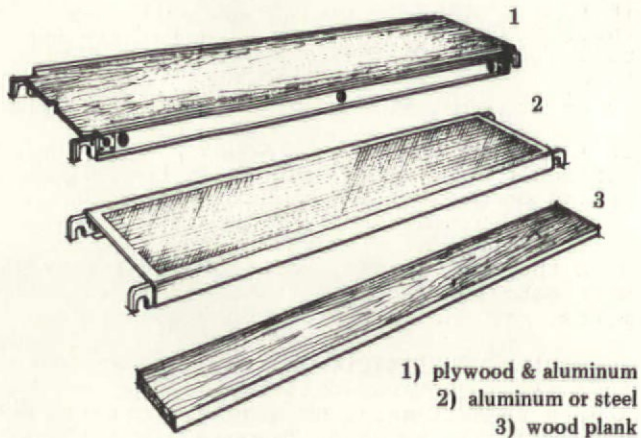

WE RECOMMEND the use of prefabricated flooring made especially for scaffolding. There are many types -- some wood, some metal, some combinations of the two -- all of which have locking devices that fasten securely to the scaffolding frames. Prefabricated flooring systems are generally stronger, lighter, and easier to walk on than are plain wood planks. Use flooring made by the same manufacturer as the scaffolding.

IF YOU CAN'T GET prefabricated flooring, be sure your scaffold is floored with only scaffold-grade planks, lapped and secured to the scaffold with #9 wire. (See OSHA specs.)

Anchoring To An Old Building

WHEN THE SCAFFOLD reaches a height four times its minimum base dimension (20 ft. if you're using standard 5-ft. deep scaffolding), the scaffolding must be anchored to the building or braced to the ground. If you're going forty feet up or more, the scaffold must be secured to the building again at the 40-ft. level, and at 20-ft. increments thereafter. (These numbers are just guidelines; refer to local codes or the OSHA standards.) Again: Novices should not work at heights above 20 or 25 feet.

SOME COMMON ANCHORING METHODS are hard on old buildings; some downright destructive. Old-house owners should be aware of alternatives that can avoid damage to the building.

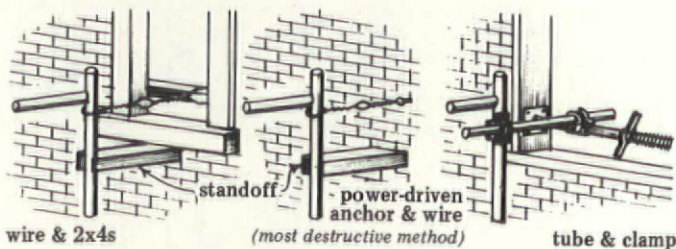

THE EASIEST and least destructive way to tie scaffolding to the house is through window openings, with the tube-and-clamp technique or with wire and 2x4s. But the house may not have enough conveniently located windows to allow enough anchor points.

IF IT'S A FRAME HOUSE, the crew can drill through the siding and anchor the scaffolding to wooden framing members with screw eyes. Later, holes can be filled with dowels (glued in place with waterproof glue) and painted.

IF IT'S A BRICK OR STONE HOUSE, though, it's difficult to make invisible patches in the bricks or stones. So drill holes in the mortar joints, install stainless steel sinkers, and use the sinkers as anchor points. When the job is over, point over the sinkers with matching mortar. (Beware that soft lime mortar may not adequately hold anchors.)

IF YOU'RE DEALING with a stucco house (where installing sinkers would cause great chunks of stucco to fall off), or a museum house (where even minimal damage is taboo), you won't be

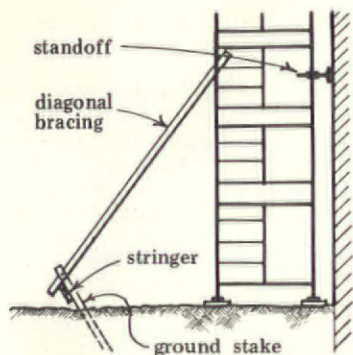

able to anchor scaffolding to the house at all. In such cases, the scaffold can be braced. YOU CAN'T build scaffolding more than four times as high as it is wide without anchoring it, and here you can't anchor the scaffolding to the building, so your only choice is to make the base wider. The surest way to brace is to sink multiple stakes into the ground, tying them together with wood stringers and anchoring the scaffold to the stringers.

IF THE SCAFFOLD is secured using any of these slightly unusual methods, pay very close attention to the condition of the anchoring system when you make your daily check.

A Daily Checklist

NOW THE SCAFFOLD has been erected -- either by you, because you're much more experienced than this article could have made you, or by a scaffold crew. Every day, check the following things before you climb:

- The sill under each scaffolding leg must be in place and level. Washouts from overnight rain, or overloading, can cause sills to become unstable.
- All base plates and adjustment screws must be in firm contact with their supports, and the whole assembly must be snug.
- Frames must be plumb in both directions.
- If there is a gap between the lower end of one frame and the upper end of another frame, adjust the leveling feet to bring the frames in contact. If that doesn't cure the misalignment, the frame is out of square and should be replaced.
- All cross-braces frame-to-frame along the run must be secure.
- All locking devices must be secure, including clamps or wire ties for planks.
- All ties between the scaffolding and the building (or all angle braces between the

scaffolding and the ground) must be secure.

- Safety equipment such as guard rails, midrails, and toeboards must be in place.
- Access ladders must be securely fastened to the scaffolding frames. Check out the locking devices before you climb.

Working Safely From A Scaffold

CLIMB ONLY on the integral ladder or securely fastened access ladders. Don't climb on the braces, which were not designed to bear a person's weight. (Besides, it's easy to fall off them.) Don't hang outside the scaffolding frames. Wear a hard hat -- not just to protect you from falling objects, but even more to keep you from bumping your head on the unfamiliar protuberances of a scaffold.

PAY SPECIAL ATTENTION to housekeeping on the work platform. Accidents happen when people slip or stumble. Common offenders are tools laid on the scaffolding floor, spills, and electrical cords. Keep the platforms clear at all times. At the end of every day, clear debris away from the scaffold base.

HAVE A WORKBENCH on the platform to keep tools off the floor. Tools belong on the bench, in your hands, or in a tool apron. If you spill something, wipe it up immediately and cover the residue with a non-slip surface if need be. Keep electrical cords out of the way by duct-taping them to the midrails or, if absolutely necessary, to the flooring.

DON'T USE THE SCAFFOLDING when wet or icy conditions exist. Rain, dew, and ice make ladders and planks slippery. At all times, wear non-skid shoes.

NEVER SET planks, ladders, or any kind of extension on the guard rails to use them for greater reach. This is just plain stupid, but we've seen it done.

BURGLARS MAY BE delighted by the easy access to windows you've provided. And don't forget that a metal scaffold looks like a big jungle gym to kids. Make the scaffold less attractive by removing lower floor planks at the end of the day.

If you plan to erect or work from scaffolding, we urge you to read the following publications first:

Guide To Scaffolding Erection & Dismantling Procedures (S101), \$.50
Recommended Steel-Frame Shoring Erection Procedure (SH 304), \$.50
Scaffolding Safety Rules (S 100), \$.25
Steel-Frame Shoring Safety Rules (SH 300), \$.25
Slide shows also available; free publications brochure.
Scaffolding, Shoring, & Forming Institute, Inc., 1230 Keith Building, Cleveland, OH 44115. (216) 241-7333.

A Guide To Waco Scaffolding, \$1.00 (an excellent 23-page booklet that describes this firm's equipment but applies to others as well).
Waco International, Inc., 7575 Dillon Street, Houston, TX 77061.
(713) 641-6558.

Membership Directory & Handbook, \$55.00 (includes just about everything on scaffolding, including standards, definitions, illustrations, OSHA standards, etc. -- for \$85.00, you can join the Association and receive the SIA Newsletter).
Scaffold Industry Association, 14039 Sherman Way, Van Nuys, CA 91405. (818) 782-2012.



First: Commit Mildew Murder

IHAVE A PROBLEM with a bathroom in my 1905 house: The paint on the ceiling is starting to crack terribly and mildew is all over. I've tried to remove the mildew, but nothing works -- it keeps coming back. I tried to paint and wallpaper, but they both peel right off. Nothing stays up!

WHAT can I do about the peeling paint and the mildew, and what coverings can I use on the walls and ceilings?

--Sondra Babcock Oak Park, Ill.

THE PROBLEMS you describe are sure signs that there is too much water vapor in the bathroom.

EXCESSIVE water vapor (mostly from showers, which weren't common in 1905) allows mildew to grow, and causes paint and wallpaper to peel. The simplest solution: Crack a window during and after showers. The best solution: Install an exhaust fan sized for the room.

YOU CAN KILL the mildew with Clorox, or a commercial mildewcide. You have to kill mildew before you repaint or hang wallpaper; if you don't, the mildew will continue to grow through the new paint or paper. Re-paint with a high-gloss mildew-resistant paint, or re-paper with mildew-resistant wallpaper.

Gutters For A Circular Roof

MY QUEEN ANNE house has a circular front porch. If the porch roof ever had gutters, they are gone now. Water from the roof collects at the base of the porch and is causing the lattice to rot. I'm having trouble finding a contractor to install new gutters. Can't anybody install gutters on a circular roof anymore?

--Tony Restino Springfield, Mass.

A GOOD sheet-metal contractor -- not a "roof-and-gutter man" who works only with pre-fab vinyl and aluminum -- will be able to make a new gutter system for your porch. Insist on gutters formed out of copper, terne-coated stainless steel (TCS), or galvanized steel, with soldered (not caulked) joints.

MAKE SURE the perimeter of the porch roof (soffit, fascia, rafter ends) is free from rot and properly painted before the new gutters are installed.

Removing Sap From A Terne Roof

MY HOUSE has a terne roof that has been stained black in places by sap from overhanging pecan trees. I need to repaint the roof, and I've tried to clean the sap off with TSP and other soap-type cleaners, to no avail. Any ideas on how to get the sap off?

--P.J. Breitling Trenton, Ill.

FIRST, try scrubbing the sap off using turpentine or mineral spirits as a solvent. They're flammable, so don't use steel wool or a wire brush (or anything that could make sparks) for a scrubber -- use old towels.

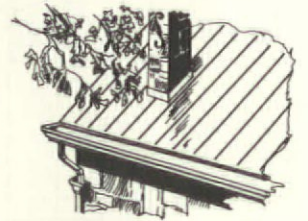

IF THAT doesn't work, try a strong alkaline cleaner like those used to clean masonry buildings. ProSoCo's T-534 and T-547 (available through ProSoCo distributors) are two such cleaners.

IF THE SAP stands up to all this, you'll have to use a chemical paint stripper. (This will, of course, attack the existing paint.) Thoroughly rinse off the paint remover residue, dry the metal roof surface, and prime bare areas immediately. If you leave bare terne exposed overnight, it could rust.

Where's The Linoleum?

DOES ANYONE still make linoleum rugs -- not wall-to-wall vinyl, but real enough linoleum rugs which were common in the '30s?

--Anne Kenney Wichita, Kansas

YOU'RE IN LUCK. You can still get linoleum rugs from (where else?) Linoleum City, 5657 Santa Monica Blvd., Hollywood, California, 90038.

THIS COMPANY and over 1300 companies that offer hard-to-find products and services for old houses is listed (where else?) in the OHJ Catalog. (See the facing page -- please -- for further enlightenment.)

General interest questions from subscribers will be answered in print. The Editors can't promise to reply to all questions personally—but we try. Send your questions with sketches or photos to Questions Editor, The Old-House Journal, 69A Seventh Avenue, Brooklyn, NY 11217.

If Only I'd Read Those Pages...

by Walter Jowers

LONG BEFORE I became a contributing editor, I was a loyal OHJ subscriber. Each issue would wind up a dog-eared wreck, because I'd always refer to it in all my own restoration work. I'd read The Old-House Journal from cover to cover ... sort of. I'd just skip those last few pages in the back (and go right to "Remuddling"!). After all, there was work to do. Life's too short to read ad pages.

THEN LAST YEAR, when I left Nashville and came to work at OHJ, I walked into a lot of office hubbub I didn't understand. There was a special telephone marked "Catalog Hot Line," and it rang all the time. Only certain people (Catalog Editors) were allowed to answer that phone, and one of them had to be near the phone at all times. Company rule.

EVERY NOW AND THEN, a Catalog Editor would jump up and yell something like, "Somebody still makes busybodies!" Or, "A new company is making Arts and Crafts furniture!" After witnessing a few of these outbursts, I decided to get to the bottom of this Catalog business. I asked the Chief Catalog Editor, "Are you thinking about publishing some sort of directory of arcane old-house goods and services?"

THIS put the Chief Catalog Editor into a snit that she's not over yet. "We've been publishing The Catalog for TEN YEARS! Where have you been, Mister How-to from Tennessee? Where-to-find-it is just as important as how-to-do-it." "Well, pardon me all to pieces," I said. "Why don't you ever advertise the thing?"

THAT put the Production Editor into a snit that he's not over yet. "We advertise it in every issue. Big ads. In the back of the Journal. Didn't you even see the one with the elephants? I designed that one myself." He produced a Catalog ad and read: "Whether your house was built in 1730 or 1930, you've undoubtedly encountered sales clerks who insist, 'they don't make that anymore.'" Then the Chief Catalog Editor and the Production Editor spoke in unison, like a Greek Chorus: "Well, they DO still make thousands of authentic products and services for the sensitive rehabilitation of old houses."

THEY WENT ON to tell me the salient facts: The Catalog has grown from a listing of fewer than 50 restoration-oriented companies into a 200-plus-page book, listing over 1300 companies -- companies that provide products and services to a demanding restoration market. Our Catalog includes sources from all across the country. Its Company Directory tells you the full address, phone number, and what literature is available at what price.

SO I LOOKED at a copy of the Catalog. And the more I looked, the more I found in it:

- A meticulously crafted index (so you can find anything, whether you know the right name for it or not)

- Good-looking product displays from listed companies (some in full color!)
- Listings for small and large companies (some of which have been around long enough to have made original old-house parts) -- not only sources for reproductions, but also antique warehouses and old-house services.

EACH COMPANY gets listed by product or service; by company name; and by city and state. And they're high-quality companies -- not importers of tacky brass hardware and colonial paper-towel holders. No aluminum siding either. Good stuff! People who make full-size porch posts (saving you from the scourge of modern wrought iron). People who'll put a bent-shingle roof on your house....

"I COULD HAVE USED THIS BOOK when I was restoring my Bungalow," I said. "I must have spent a few hundred dollars on phone calls searching for just the right this or that." "We did our part," the Chief Catalog Editor said. "We've spent thousands of hours and dollars tracking down all these companies and checking to make sure their products and services are of the highest quality."

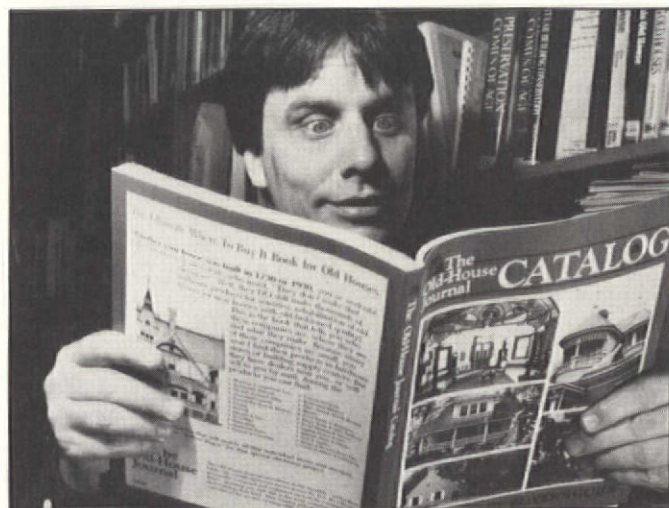

A historic moment: Walter Jowers discovers the OHJ Catalog.

AS MY PUNISHMENT for not knowing about the Catalog, I was assigned to answer all the mail from OHJ readers who want to know where to buy hard-to-find things. I'm tied to my desk, telling people where to find fancy faucets, library ladders, hoosier hardware.... The volume of mail is tremendous, and that's because an awful lot of you don't know about the Catalog, either. I can't answer the same where-to questions day in and day out, meet deadlines, and learn to live in New York. I could crack under the strain.

IF YOU NEED SOMETHING for your old house, from adzes to wrought iron, look in the Catalog. Everything we know about where-to-find-it is in there. If you don't have a Catalog, buy one. It's cheap -- only \$10.95 to subscribers (\$13.95 to Outsiders -- still a bargain). Just check the box on the Order Form, or send a check to The Old-House Journal Catalog, 69A Seventh Avenue, Brooklyn, NY 11217. And be sure to read our ad pages in future issues. Don't make my sad mistake, and discover an invaluable resource after it's (sob) too late.

Awnings *cont'd from p. 115*

FABRIC SHELTER was common as far back as ancient Rome; awnings probably evolved from Mediterranean and Middle-Eastern countries, where tents and canopies were traditionally used for shelter from the hot, sunny climate. (To this day, awnings enjoy a greater popularity in southern European countries than they do here.)

THE AMERICAN ROMANCE with awnings began in earnest during the 1890s. Soon there was hardly a town of any size without at least one local awning fabricator. The awning-maker worked with traditional canvas, which is a heavy, woven material usually made of cotton. The early canvas awnings were most often painted, in either solid bright colors or stripes. Occasionally the undersides would be painted with a floral pattern, to add visual interest for anyone looking out the window.

AWNINGS ARE MOST APPROPRIATE for late- and post-Victorian house styles -- especially Queen Anne, Colonial Revival, Bungalow, Spanish, and the many Period-Revival styles. They were most commonly featured on porches, but a house with all its windows and doors sheltered by awnings was certainly no rarity. And as any old photograph demonstrates, the quintessential American downtown "Main Street" had both sidewalks covered by a nearly continuous canopy of storefront awnings. They served not only as shelter for window shoppers, but also as a natural place for advertising. Seaside resorts, shuttered-up ghost towns in the off-season, sprang to life in the summer; one of the first signs of activity was the putting up of the porch awnings that added to the colorful and festive atmosphere of the resorts.



In this glimpse of 1917 Chicago, storefront awnings are a natural part of the streetscape.

AFTER WORLD WAR TWO, fabric awnings fell from favor, replaced by aluminum awnings. These were more permanent and featured movable louvers that allowed the summer breezes to pass through the house. Metal awnings can imitate fabric awnings in shape and color, but they can't provide the romantic appeal of canvas awnings; they're also inappropriate for anything other than post-war homes.

BOTH CANVAS AND METAL AWnings have largely disappeared from houses during the past 30 years, due to the popularity of air-conditioning and the corresponding decline in the use of porches as living spaces. Of course, awnings are still widely used on commercial buildings, where their sheltering and advertising functions are as important as ever. And there are still pockets of resistance where awnings remain common, particularly in sunny Florida and California.

The Advantages Of Awnings

- **COOLING** -- Window and porch awnings shade the sun's rays, and keep the house from getting uncomfortably hot in the summer. Effectively placed awnings allow you to keep the windows open while reducing, by up to 75%, the heat gain from direct sunlight. Awnings are seven times more effective at reducing heat gain than window shades or other inside devices.
- **ENERGY-SAVINGS** -- According to the National Bureau of Standards, even if you air-condition your home, awnings can give a 10- to 15-degree cooling effect. And that can reduce up to 25% the cost of running your air-conditioner. You can increase the efficiency of window-mounted air-conditioners by keeping them in the cooling shade of awnings. (Warning: Keep awnings at least 10 inches from window units.)
- **WEATHER PROTECTION** -- Awnings mounted over entries provide shelter from the rain.
- **REDUCTION OF GLARE AND SUNLIGHT** -- Awnings protect interior fabrics, paintings, carpets, and drapes from fading.
- **COVER-UPS** -- Some unsympathetic alterations to old houses, especially modern window replacements, can be partially disguised or subdued by a sheltering awning.
- **AESTHETICS** -- Colorful awnings can add to or complement the architectural character of an old house. They add character to even plain, unstylish older homes. A dark, drab house can be brought to life by bright striped awnings. The many interesting awning shapes available can soften severe wall planes.

Awning Types

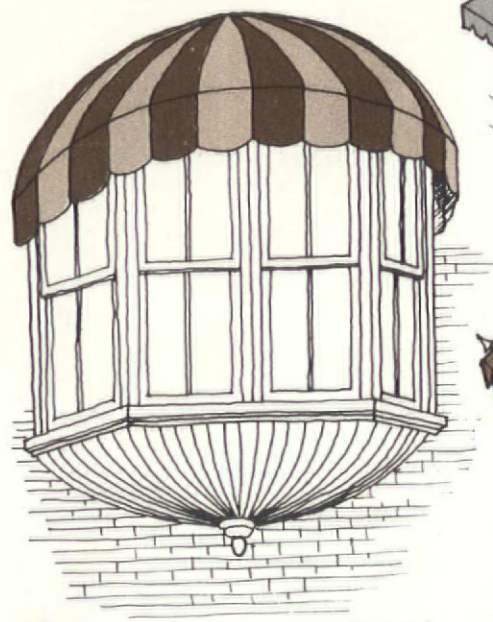

OVAL
(OVER BAY WINDOW)

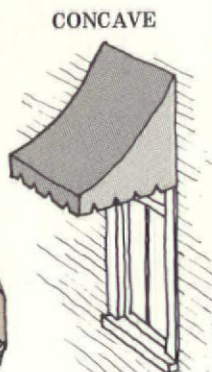

CONCAVE

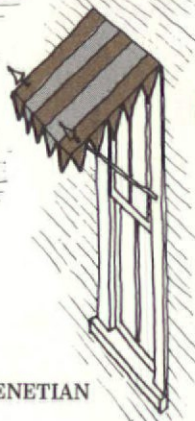

VENETIAN



STANDARD

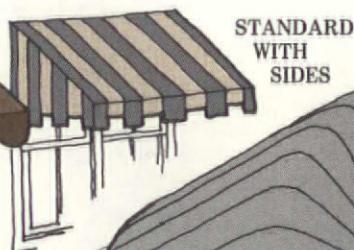

STANDARD
WITH
SIDES

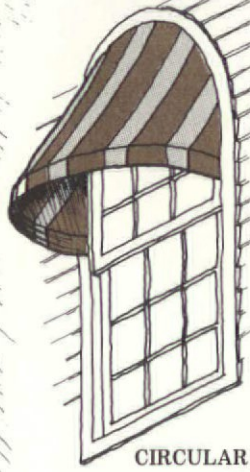

CIRCULAR



ACCORDIAN

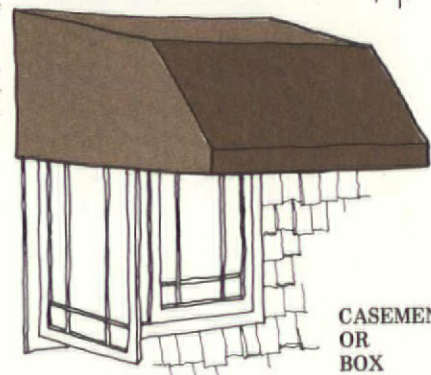

CASEMENT
OR
BOX

BUT THERE ARE DISADVANTAGES to awnings. They aren't particularly inexpensive, and you'll have to put in some maintenance to protect your investment. Furthermore, all awning fabrics will eventually deteriorate, and their colors fade. Modern fabrics last longer, but expect to replace them every six to twelve years.

What's Available

IF YOU KNOW AWNINGS only from earlier times, you'll be pleasantly surprised by the array of fabrics, finishes, and hardware available today. These advances often come out of Europe, where they remain years ahead of America in "awning technology." Many fabrics are only for specialized commercial applications. For homes, there are really only three to consider (although they go by many trade names):

- 1) CANVAS -- This, the traditional material, is the least expensive. It's also the shortest-lived, generally surviving about three to seven years. It's available with a painted surface in a wide variety of colors and stripes. (The paint colors will fade in a number of years.)
- 2) VINYL-COATED CANVAS -- It costs 10 to 20% more than painted canvas, but should last from seven to ten years. In addition, the vinyl coating comes in many colors, is easily washable, and has better sun-darkening properties. However, the vinyl gives a hard, shiny finish, and so is used mostly for commercial purposes.

3) ACRYLIC -- This is probably the best bet for old-house owners. Acrylic awnings are about as expensive as vinyl-coated canvas, but they last from seven to twelve years. Because the threads are dyed before the fabric is woven, acrylic is highly fade-resistant. It's available in many colors and striped patterns, and has a non-shiny, natural-looking finish that's equally attractive on both sides of the fabric. These materials often go by their trade names, such as Sunbrella, Sunflair, or Argonaut (see list of suppliers, page 129). Because acrylics are generally not painted or coated, they 'breathe' easily and last longer.

Shapes & Types

AWNINGS are available in many shapes; the most traditional ones are shown in the illustrations. The standard, straight-topped type can be used for most window and porch applications. You might want to add side panels (also called "drops"), which shield against angled sunlight. Other options include the various decorative-edged valances, which were common in early awnings and add architectural interest.

A CASEMENT OR "BOX" AWNING will be necessary if you have casement windows; the Venetian type is particularly appropriate for Spanish- and Mediterranean-style houses of the 1920s and '30s. If you have arched windows or an arcaded porch, consider using circular-headed awnings. It's possible to put a straight-topped awning over arched openings, but that would destroy the original intent of the



Circular awnings emphasize the arched porch on this 1930s Spanish Bungalow.

house's architecture. Accordion awnings, popular in Europe, can add an elegant look, particularly over doors, but they're more expensive. So are the other complex shapes such as convex, concave, and oval.

THE OLD-FASHIONED AWNING MECHANISM has the side bars of the awning hinged near where they are attached to the structure. By pulling on a cord connected to the front transverse bar, you can raise the awning up against the house. The cord is tied off on a cleat that's mounted near the window. This is the simplest mechanism, and still the most popular. Its one drawback is that it requires more maintenance, because the raised awning may hang in unsightly folds that collect rainwater and debris.

THE EUROPEAN-TYPE retractable awning is fairly new to this country. The two arms supporting the awning are hinged at the middle, like elbows, and can retract flat against the house as the awning itself rolls up. It operates by a hand crank or electric motor, which can even be controlled by automatic photo-electric and wind-sensitive devices. The retractable awning has no need for side braces, and therefore has a very 'clean' appearance, which may be too modern and streamlined for old houses. It can also be very expensive, running over \$1,000 for large patio or porch awnings.

Traditional Valance Designs



GREEK KEY



SCALLOPED



SAWTOOTH



WAVE

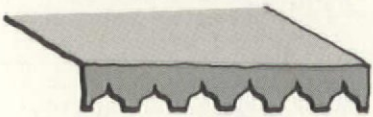

OGEE



FRINGE & APPLIQUED BORDER

applied on) along the valance edges are also historically correct and still available today.

Where To Get Them

DO-IT-YOURSELF KITS are available (see sources list, page 129). They can save you considerable cost, but have a major drawback: They're available only in certain incremental width and depth sizes. Awning should generally be mounted within the window opening,

SOME AWNINGS are fixed; that is, they don't fold up. Fixed awnings include the Venetian, circular, and accordion types, as well as large patio canopies.

Colors & Designs

MOST AWNING FABRICS are available in a large range of colors. It's best to choose a color that complements your house, rather than one that exactly matches it. Blues, reds, browns, greens, and tan were common awning colors. Consider your selection in the same way you'd consider a trim color.

HISTORICALLY, striped awnings were usually white alternated with primary colors. This was very popular, and still is: A red-&-white-striped awning looks great on a brick house with white trim. As a general rule, striped awnings are best on more informal houses, like Bungalows, Queen Annes, or Spanish Revivals; for Colonial Revivals, solid colors are preferred because they don't 'complicate' the more formal and restrained lines. Fringe or decorative borders (which are painted or



Simple, solid-color porch awnings work well with the restrained lines of this Florida Post-Victorian house.

Awning Sources

European-type Retractable Awnings by Brand Name (available from local awning dealers):

Solair — available in four projection sizes in 8- to 20-ft. widths. Astrup, Dept. OHJ, 2937 W. 25 St., Cleveland, OH 44113.

Sunesta — five projection sizes; widths 7 ft. and up. Canvas Products, Dept. OHJ, P.O. Box 3235, Jacksonville, FL 32206.

Sun-Tamer — widths 6 to 40 ft., prices \$600 to \$1300. Levolor Lorentzen, Dept. OHJ, 1280 Wall Street, Lyndhurst, NJ 07071.

Sunvisor — a do-it-yourself retractable, available in 3 widths. Architectural Concepts, Dept. OHJ, 3 Westchester Plaza, Elmsford, NY 10523.

Do-It-Yourself Patio Canopy Kits:

Fiesta Patio Canopy — choice of 56 colors and stripes; up to 25 ft. wide and 12-ft. projections. Anchor Industries, Dept. OHJ, 1100 Burch Dr., P.O. Box 3477, Evansville, IN 47733.

Awning Dealers:

All American Awning Company, Dept. OHJ, 89 E. Lancaster Avenue, Paoli, PA 19301.

Astrup (see above listing; they also have many regional dealers). Atlas Awning Company, Dept. OHJ, 38 12th St., Ronkonkoma, NY 11779.

Bronx Window Shade & Awning Company, Dept. OHJ, 372 E. 162 Street, Bronx, NY 10451.

Major Acrylic Fabric Tradenames:

Cabana Cloth — by Graniteville Mills, through Astrup dealers.

Sunbrella — by Glen Raven Mills, through Anchor Industries dealers.

Sunflair — through Canvas Products of Jacksonville.

Awning Supplies:

An automatic stitching awl (with self-feeding thread in the handle), perfect for awning repairs, is available for about \$5 from U.S. General Supply Corporation, Dept. OHJ, 100 Commercial Street, Plainview, NY 11803.

For temporary repairs of rips, use nylon adhesive ripstop spinaker tape from E & B Discount Marine, Dept. OHJ, 980 Gladys Court, Edison, NJ 08818.

For cleaning synthetic fabrics, use Sailbath, a liquid concentrate used with warm water; also available from E & B Marine.

directly on the frame; it can be hard to find a ready-made awning for the sometimes odd sizes of old windows and doors.

MOST AWNINGS are still custom made by local awning dealers, who fabricate them from fabrics and hardware manufactured by major suppliers. Most local awning-makers do mainly commercial work, but should accommodate your needs as an old-home owner. Ask to see swatch samples of the fabric, and check the warranties of both the fabric manufacturer and local installers.



Traditional red-and-white-striped awnings look great on both wood houses and brick houses.

WHERE DO YOU PUT THE AWNINGS? The most common place is on porches and sunrooms. Fixed patio canopies (ranging from \$1,200 to \$1,700) are also popular. Even though this is a less traditional use for old homes, a patio canopy can be quite compatible.

IF YOU CAN AFFORD IT (a standard window awning should run \$60 to \$120), awnings on all the major window openings will look more appropriate than just a few. If expense is a consideration, the south, sun-facing elevation is the logical choice for selective placement.

THE AWNING FRAMEWORK should be attached just inside the window opening, on the window frame. If this isn't possible, attach it just outside the opening. On brick houses, always make attachments in the mortar joints, not in the brick itself. Set screws in silicone caulk to prevent moisture infiltration.

Maintenance

YOU'LL HAVE considerable investment in your awnings, so it makes sense to give them routine, year-to-year preventive maintenance.

● **CLEANING:** Follow the fabric manufacturer's directions. A hosing down or a gentle scrubbing with a soft-bristle brush will usually do the trick. Do not use harsh detergents;

common soap can be used if necessary. Bird droppings, soot, industrial contaminants, and organic "droppings" (like mulberries) should be cleaned off regularly.

● **DRYING:** Moisture can cause mildew, so don't let rainwater or snow stand in the folds of furred awnings; lower them so they can dry out after wind and hail storms. Chronic standing-water problems can be corrected by installing strategically placed grommets for drainage.

● **STORAGE:** You'll greatly prolong the life of your awnings by removing and storing them in the off-season. Keep them in a dry, well-ventilated place, away from sunlight. If the awnings are retractable but not removable, they should retract into protective, shedlike housings designed to repel water and snow.

● **HARDWARE & FRAMES:** Rust causes fabric to deteriorate rapidly, so inspect the hardware for corrosion at the beginning of each season. (Most modern frames are made of aluminum or anodized steel, which eliminates this problem.) Clean out any winter debris from the mechanisms, and lubricate according to the manufacturer's directions.

● **ORGANIC MATTER:** Keep trees and shrubbery away from awnings -- sap, berries, and bird droppings can be especially damaging. Organic stains can sometimes be cleaned with benzene, but spot-test first.

● **REPAIRS:** Small rips or tears can be fixed by gluing or sewing small patches over the damage on both sides of the awning. Allow three to four inches overlap around larger tears. (It's a good idea to purchase a yard or more

Awning Mechanisms

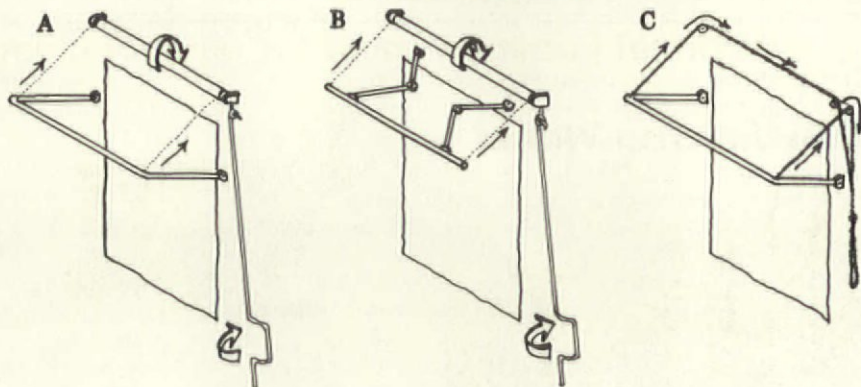

Awning A is rolled up by a hand crank; awning B, with retractable hinged arms, is also operated by a crank. Awning C is raised by a cord attached to the front transverse bar.



On this Florida Spanish Colonial Revival, the awnings have appliqued borders that emphasize their Greek-key valance design.

of extra fabric when you buy the awnings.) Sewing repairs can be done with heavy canvas-upholstery needles, either straight or curved; thread from your canvas dealer; and a protective leather sewing palm. 

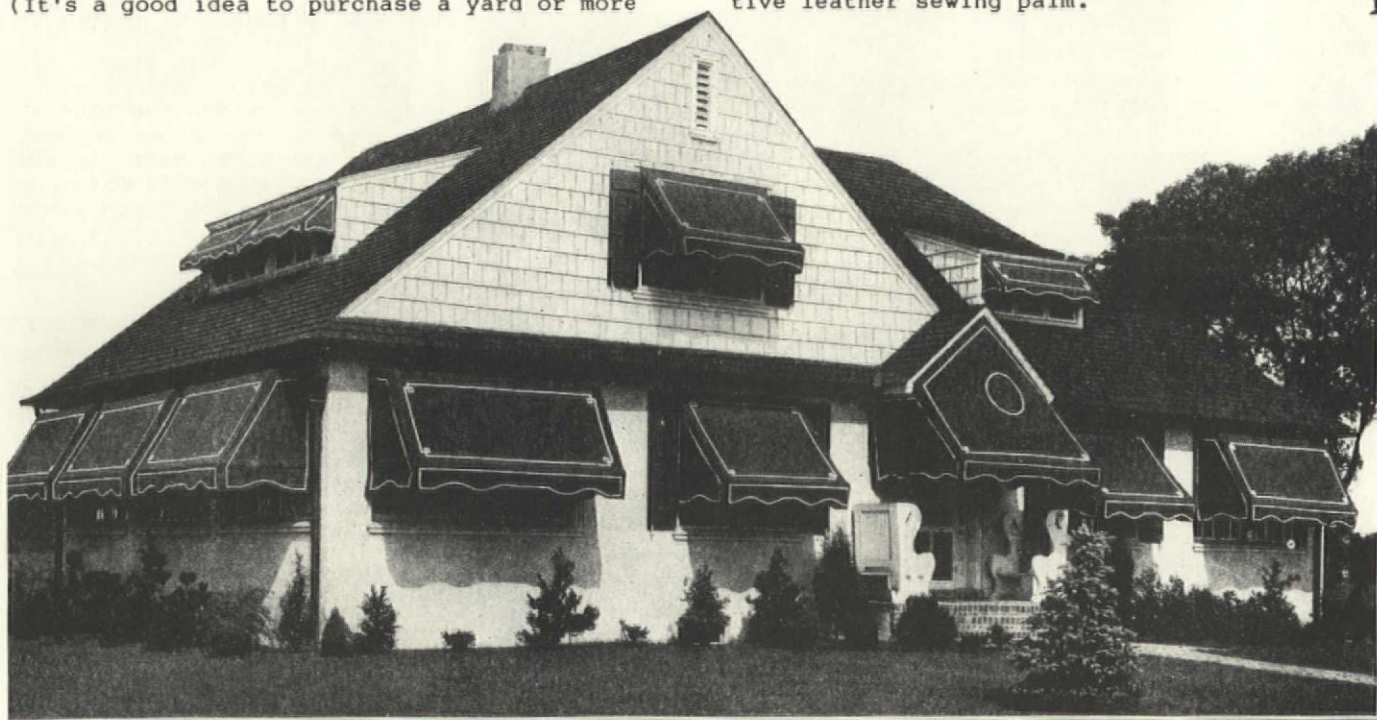



Informal Furniture—most for outdoors, some appropriate inside

High Victorian Wicker

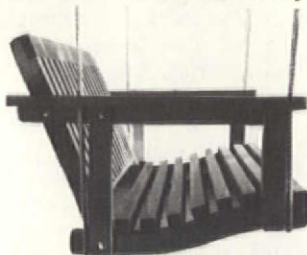

Redwood Porch Swing

Here's a Craftsman-inspired porch swing that really looks comfortable. Constructed out of heavy redwood, the Alfresco has a deeply contoured seat & a generously sloping back. Finished with oil, the swing has level arms and is suspended from four points with 80 feet of sisal rope. It has bronze fasteners and can be assembled in ten minutes (the seat & back come fastened with dowels). The swing sells for \$199 ppd. Alfresco also offers an Adirondack rustic chair for \$89 ppd. For brochures call or write Alfresco, Dept. OHJ, P.O. Box 1336, Durango, CO 81301. (303) 259-5743.

We're proud to announce that really high-quality, high-style Victorian wicker furniture is once again being made in this country. Dissatisfied with the quality & styles of wicker furniture available from abroad, Classic Wicker of Los Angeles, California, decided to make their own. Currently with a crew of 20 craftspeople, Classic Wicker is turning out an elegant array of intricately woven and beautifully styled wicker rockers, plant stands, settees, lounges, chairs, tables, and more. This furniture would turn any porch into an elegant outdoor living room (in fact, it's elegant enough for the parlor).

Our favorite pieces are the Granada rocker (\$460) & Comfort chaise lounge (\$925), which are dead ringers for turn-of-century originals. The prices aren't cheap — but neither is the quality and craftsmanship. (The rocker requires up to 28 hours to construct.) You can expect wicker furniture of this quality to last and become a family heirloom. All of the furniture is made with solid wood frames and tightly woven wicker, finished in polyurethane. Available finishes include natural, antique brown, & white (designer colors cost an additional 5%). Prices are FOB Los Angeles. OHJ Scoop: Although not in their product line yet, Classic Wicker will make a turn-of-century porch swing — all they need is an order. Send \$2.50 for a brochure and price list to Classic Wicker, Dept. OHJ, 8532 Melrose Avenue, Los Angeles, CA 90069. (213) 659-1121.



Victorian Swing in Pine

Classic Architectural Specialties produces a porch swing with Victorian-style ornamentation, which might be just what your front porch needs. Made from white pine, the 4-ft.-long swing comes with chains and hardware, unfinished & unassembled (in four sections). It sells for \$210 plus shipping. A 5-ft.-long version is available by special order; write for details. Send \$2 for catalog to Classic Architectural Specialties, Dept. OHJ, 5302 Junius St., Dallas, TX 75214. (214) 827-5111.

Rustic Willow Furniture



For almost a century one Georgia family has practiced the craft of bending & carving willow branches into beautiful rustic furniture for gardens, porches, or indoors. The individual character of the shaped wood makes every piece a unique work of folk art. Held together mainly by the tension of bent branches, all the furniture is handmade — they even take measurements using the width of a hand. The only tools are a hammer, tree saw, and machete.

The furniture is available in two styles: the butterfly style, with a flat seat designed to use fitted cushions; the classic style, with a rounded seat that's comfortable with or without cushions. Our favorite pieces are the rocker (\$275 plus shipping) & the 54-in.-long porch swing (\$375 plus shipping). There's a wide variety of other pieces, including chairs, a fern stand, tables, children's furniture, a loveseat, wall basket, hutch, headboards, & even a bird house. Send \$2 for a catalog to American Folk Art, Dept. OHJ, 354 Kennesaw Avenue, Marietta, GA 30060. (404) 344-5985.





The Brumby Rocker

The famous Brumby Jumbo Rocker, produced from 1875 until World War II in Marietta, Ga., is available once again as an exact reproduction. Using old Brumby equipment, each rocker is carefully formed from Appalachian red oak and "Blue Tie" cane. The rocker's large size, curved back, wide arms, and good balance all add to its comfort. They come in a natural lacquered finish or two stain colors for \$455; white is \$475 (shipping extra). A matching caned footstool is also available in rocking or stationary styles, priced from \$265 to \$275 plus shipping. Brumby rockers accompanied President Carter to the White House.

Also produced from prime aged oak is the Melson Swing, a sturdy porch swing, that comes in 4-, 5-, and 6-ft. lengths. Mortise-and-tenon joints and posturized seats and backs provide a strong yet comfortable swing. The swings are complete with chains and hardware, and come in antique oak finish, white enamel, or unfinished. They range in price from \$295 to \$430 (shipping extra).

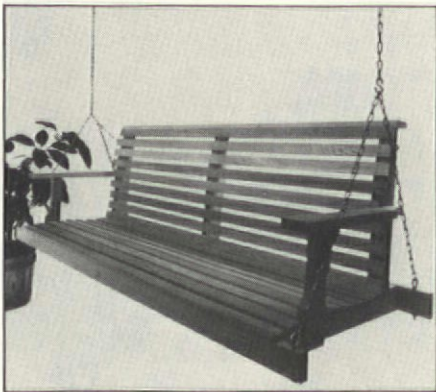

Send for a free brochure of these and other chairs & rockers from The Rocker Shop of Marietta, Georgia, Dept. OHJ, 1421 White Circle, N.W., P.O. Box 12, Marietta, GA 30061. (404) 427-2618.

Victorian Porch Swing

Green Enterprises produces a beautifully detailed oak porch swing with a cane seat. In fact, it looks almost too nice to leave out on the porch! It comes complete with scrollwork, turned pendants, and other Victorian decoration, in either white or hand-finished oak. The 4-ft. size sells for \$275; 5-ft. size, \$325 plus \$15 shipping. For further information contact Green Enterprises, Dept. OHJ, 43 South Rogers Street, Hamilton, VA 22068. (703) 338-3606.

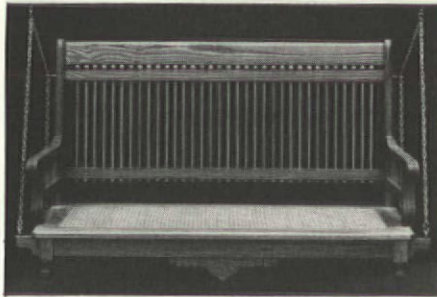

Classic Rope Hammock

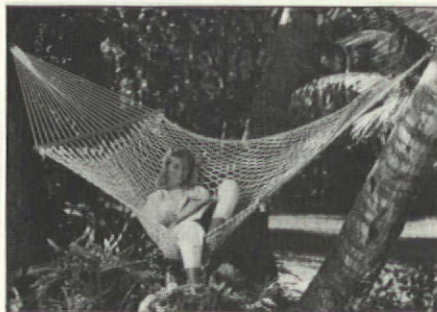

The 'Original Pawleys Island Rope Hammock' was invented in the late 1800s on Pawleys Island, S.C., by Captain Josh Ward, a river boat pilot. For nearly a century the cool and comfortable cotton rope hammocks have been handknitted exactly the same way. Three sizes of hammocks are available. We suggest you get the large deluxe size; it holds two people comfortably and sells for about \$114.95.

The hammocks come complete with hanging hardware and instructions. If there isn't enough space between trees or on your porch, a sturdy tubular steel stand is available. You should also consider purchasing one of their two hammock pillow designs, which snap into place. For the dealer nearest you, contact Pawleys Island Hammock Co., Dept. OHJ, P.O. Box 308, Pawleys Island, SC 29585. (800) 845-0311.

For information on 1300 OTHER companies, see the new edition of *The Old-House Journal Catalog*.



The Presidential Rocker

The Presidential Rocker sold by L.L. Bean is supposedly the only piece of furniture President Kennedy took with him from his Senate office to the White House. The angled, steam-bent back posts and the Malaysian rattan seat and back are designed to provide firm support and good posture, with natural "spring." The 4-in.-wide arm rests are set low and won't interfere with handwork or reading. The oak rocker comes assembled, finished in light walnut stain, and sells for \$169 (call to verify), plus \$16 shipping. For a free catalog contact L.L. Bean, Dept. OHJ, 3210 Birch St., Freeport, ME 04033. (207) 865-3111.

Courting Swing



William Fisher and a crew of local boat builders in Maine produce this high-quality porch swing of Honduras mahogany. The 4-ft.-wide swing is finished with no less than seven coats of white polyurethane marine paint; the mortise-&-tenon joints are shellacked for weatherability. Bronze fasteners are used throughout, and the swing is supported by Dacron line spliced in the best marine tradition. Part of the Estate line of garden furniture produced for Smith & Hawken, the swing sells for \$680 plus \$8 shipping, and comes assembled. For a free catalog write Smith & Hawken, Dept. OHJ, 25 Corte Madera, Mill Valley, CA 94941. (415) 383-4050.



FOR SALE

WALNUT DOORS, c. 1900, veneer over solid core. Nicely panelled around perimeter. Various sizes: 30 in. x 79 in. through 34 in. x 84 in. \$25 each. RR 1, Box 597, Hamburg, NJ 07419. (201) 827-4547, after 6 PM.

SLATE VICTORIAN FP, c. 1900. Mantel 60 in. x 12 1/4 in. x 1 1/4 in. Opening of fire box, 20 1/2 in. x 27 1/4 in. Must be 15 in. D. Complete: grate, metal box surround with door. Nickel-plated trim. \$250 or best offer. Larned, KS. (316) 285-6109.

3 WOODEN STORM DOORS. One: 37 in. x 81 in., inset has 8 panes, measures 27 in. x 56 in. Two: 37 in. x 80 1/4 in., inset has 8 panes, measures 27 1/2 x 56 in. Three: 36 in. x 79 1/4, inset has 6 panes, measures 27 in. x 37 in. All in exc. cond. Best offer. Montclair, NJ. (201) 746-6386.

PIANO, 1923 Kurtzmann upright. Total restoration by professional technician just completed. Beautiful red mahogany. Appraised at \$2000. Offers around \$1500 considered. Delivery possible. Robert Sadowski, 1038 W. 9th, Erie, PA 16502. (814) 454-8019.

BRONZE CHURCH BELL, cast-iron yoke, trunions, etc. Mounted, ready to ring. Cast in 1875 by Menely Bell Foundry, W. Troy, NY. 42-in. diameter, estimated weight of bell alone is 1500 lbs. \$5000. Robert Haynes, PO Box 5235, Clinton, NJ 08809. (201) 735-9282.

DETROIT JEWEL GAS RANGE on 10-in. cabriole legs. 4 burners w/lids. Black w/white porcelain oven door & knobs. 32 in. H x 29 in. W x 22 in. D. Best offer, or will trade for complete pull chain toilet or ? C. Taft, 514 S. Quincy, Sedalia, MO 65301. (816) 827-1385.

3 CLAWFOOT BATHTUBS in good cond. 4 ft., 5 ft., & 5 1/2 ft. \$200 each. Pedestal sink. \$175. 4-panelled doors, 1 1/4 in. thick, from 1830s plantation home. 95 in. x 41 in. with some hardware. \$250. 31 3/4 in. x 95 in. \$195. Can deliver, love to travel. Dan Kelley, S.R.B., Box 397, Franklin, LA 70538. (318) 867-4405.

SERVANTS' CALL BOX. Victorian annunciator with falling flags summoned servants to masters electrically. 19 in. x 12 in. Delightful kitchen accessory for any Victorian home. Very good cond. \$150. Thomas Thompson, 4023 A Palm Bay Circle, W. Palm Beach, FL 33406. (305) 684-7735.

STEINWAY UPRIGHT PIANO, burlied Circassian walnut. 1872, honey brown coloring. \$1000. E.L. Burns, Albany, NY. (518) 462-6980.

SOLID CEDAR PORCH COLUMNS, 4, c. 1910, turned. 87 in., 6-in. top, 8-in. base, with 1 1/2-in. baseplate plus 1 3/4 in. x 9 1/4 in. diameter top cap. Exc. cond. \$125 plus shipping for all. T. Trantow, PO Box 287, Bingen, WA 98605. (509) 493-3111, leave message.

CLAWFOOT TUBS & pedestal sinks. Late 1800s through 1900s, in fine to exc. cond. Also, old & reproduction plumbing fixtures: faucets, over-the-tub shower curtain holders, etc. Renovator's Hardware, 422 Fore St., Portland, ME 04101. (207) 775-3346.

EASTLAKE PIER GLASS, 36 in. W x 125 in. H, with marble shelf at base & matching valances, 36 in. W, plus 2 marble FP fronts and mantels, 61 in. x 12 in. x 52 in. want to go back home to Brooklyn. Complete with fire boxes, screens, fenders. Original to 1860s Brownstone. Best offer. Viewable in Mt. Kisco, NY. (914) 666-3252.



DETAILED GRAPHICS: Illustrations of your home, Victorian B&B, historic landmarks, barns, etc. Black & white, colored. Various sizes, various prices. For a special treat or stationery. Victoria May, 2951 Sonoma Ave., Santa Rosa, CA 95405. (707) 578-5661.

PULL-CHAIN TOILET with seat, water reservoir, bowl, & pipes. Wood parts are maple. \$200. Exterior storm door, 67 in. x 112 in. x 1 1/4 in., originally mounted on barn door slides. Multiple raised panels, sound. \$100. 1879 4-panel interior doors, mahogany grained finish. 14 doors are 35 -3/8 in. x 88 1/4 in., 2 are 33 in. x 107 1/2 in. \$15 each. Will trade any of these for earlier 6-panel doors, random width ash flooring, Federal mantels, or carpenter rim locks. Gus Bynum. (502) 863-0148, evcs.

PEDESTAL SINK, c. 1901. Large, 2-piece standard sink, faceted base, separate hot & cold faucets. v. good cond. \$250 or best offer. Photo upon request. E. Moye, 3710 California Ave., Pittsburgh, PA 15212. (412) 734-4443.

AUTHENTIC 18TH-CENTURY SASH. Muntins 1 in. W, all joints mortise & tenon, new white pine. Ready to peg together. For 8 x 10 glass, 1 in. thick, 29 1/2 in. W (trimmable). 22 6-light, 24 1/2 in. H. 6 9-light, 34 1/2 in. H. All 28 sash & lots of spare parts. \$1200. Charles Thayer, RD 1, Parkesburg, PA 19365. (215) 857-9851.

PANELLING, approx. 130 linear ft. of magnificent Art Deco pecan panelling from famous Chicago building, 13 ft. L, 4 ft. W, 1-3/8 in. thick. Includes hand-carved feather pattern cornices with fluted columns to cover seams. J. Williams, 1243 N. State, Chicago, IL 60610.

200+ OAK SPINDLES, 3 in. x 34 in. 80 ft. of hand-rail with 3 curved sections & 4 newel posts, 5 1/2 in. x 5 1/2 in. All over 100 years. \$1975 or best offer. Bill, 6387 Woodbine Ave., Philadelphia, PA 19151. (215) 879-1581.

CHEST OF DRAWERS, 28 in. x 32 in. x 19 in., 1880s Victorian, solid oak with serpentine top & drawer with tiger-eye veneer, carving on base, original pulls, panelled on all sides, mint cond. \$350. Evelyn Baker, 52 Richmond St., Latrobe, PA 15650. (412) 539-2171.



1880s VICTORIAN ARMOIRE with extensive carvings & bookmatched walnut panels & cabinetry. Carved heads & bevelled mirror & marble. 14 ft. 2 in. W x 10 ft. 3 in. H. (2 center finials are not shown.) Magnificent, in mint condition. Asking \$22,000. (215) 569-8989.

PARLOR SET, 4-piece, c. 1870, with original velvet upholstery: ivory panels on red ground, gold borders, acanthus scrolls, large white, pink, & red roses. Needs minor restoration. \$3500. Mimi Findlay Antiques, 1556 Third Ave., New York, NY 10128. (212) 534-6705.

OLD HICKORY FURNITURE, sometimes called twig or Adirondack. Rocker, love seat, arm chair. Needs new wicker seats. (218) 736-7392.

STAIRCASE, oak with hand-carved decoration, for left side of hall. Raised matched oak panelling for side of staircase. In knocked-down condition carefully stored away. Paid \$3000 for it 3 years ago. Will take best offer. SASE for picture of decoration & newel post. Watral, 206 E. Iroquois, Kentland, IN 47951. (219) 474-6153.

BOOKS & PUBLICATIONS

LONDON ANTIQUE MARKETS: Up-to-date details on 10 biggest London, England antique markets: where, when, what, and how to get there. All recently visited by an OHJ fan. Send SASE & \$2. Stahl, Box 452, Grand Island, NY 14072.

"SAN FRANCISCO Bay Area Historic House Museums: A Guide." 18 homes open to public. From Octagon to Queen Anne. Maps, histories, photos, hours, etc. 24 pages, paperback. \$2.50 ppd. Hayward Area Historical Society, 22701 Main St., Hayward, CA 94541.



Annual Meeting Of THE ASSOCIATION FOR PRESERVATION TECHNOLOGY

SAN FRANCISCO, Sept. 5-8. Architects, restoration contractors, all those interested in preservation technology: We don't have room to adequately describe the APT meeting, but urge you to get more information. It is worth your time to hear the presentations, meet with your fellows, & partake of the unique technical tours.

Sessions on concrete, adobe, terra cotta; mechanical, electrical, transportation, roofing systems; metals; substitute materials; interior finishes.

Tours to study concrete stabilization at Alcatraz; masonry, terra cotta, ironworks; landscape; Victorian interiors; Art Deco Oakland; restored State Capitol; factory tour of Bradbury & Bradbury Art Wallpapers.

Training courses (Sept. 2-4). Famous faculty, intensive study. Pick one: 1. Analysis & Preservation of Paints. 2. Seismic Retrofit. 3. Maritime Preservation. 4. Stabilization of Architectural Concrete. \$585 includes tuition, room & meals 3 days & nights, tours, materials.

Post-Conference Tours - Sign up early for either Calif. Missions (adobe study) or the insiders' tour of Hearst Castle at San Simeon.

APT members - Don't miss this one! Registration is open to the public. General registration \$110 - call for student, member rates. If building preservation is your business, how can you pass up San Francisco? Contact

Bruce D. Judd, AIA
Pier 9, The Embarcadero
San Francisco, CA 94111
(415) 421-1680



WANTED

1910 CALENDAR, either poster or pages, fairly good condition, for my new/old 1910 kitchen. Snapshot & price? A. Thomsen, 2950 Magnolia, Berkeley, CA 94705.

QUILTS, pre-1935, clean, no stains, no major repairs. Send photos & description or send quilts UPS or Post Insured. Will mail check or return quilt insured the day I receive it & pay your shipping charges. Harlan Koch, 1974 Union, San Francisco, CA 94123. (415) 346-0346.

QUALITY GAS RANGE, No. 522 ICET or similar 6-burner gas range. Send photo & price. Roger Anderson, RR 3, Box 126, Marengo, IA 52301.

GRAINERS, marblers, trompe l'oeil artists, etc., willing to share their knowledge & learn secrets from others. Forming a newsletter by the trade for the trade. Anyone interested contact Ed Micca, 312 Bayport Ave., Bayport, NY 11705.

CLEAR GLOBE for outdoor lamp post. 8-1/8 in. H, top diameter 7-7/8 in., bottom diameter 2 in. Send price to Schachter, 90 Peconic Dr., Massapequa, NY 11758.

PFALTZGRAFF POTTERY. Accessory items made in Yorktowns pattern pre-1977. Stoneware, Touchmark, Buenilum, & Pewter. Also information on earlier lines such as Nordic, Museum, Mugs and After Six dinnerware. D. Mott, 1638 W. State Rt. 571, Tipp City, OH 45371.

BUILT-IN BUFFET for Colonial Revival home, c. 1905. Would like columns. Prefer mirror in back, upper doors w/glass, leaded or bevelled. Need to fit 7 ft. x 8 ft. opening. Send photo & asking price. P. Kessler, Landmark Restoration, 1846 Carroll Ave., St. Paul, MN 55104. (612) 647-1708.

HARDWARE for top-hung pocket doors. Single roller type needed. Pictured in OHJ 7/83 on page 128. Gary Ledak, 729 N. Grove, Oak Park, IL 60302.

GREEN GLAZED ROOF TILE, French Ludowici, Type II. For repair of 1905 house. Steve Mitchell, Suite 2600, 2345 Grand, Kansas City, MO 64108. (816) 842-0820, 9 to 5.

LIGHT SWITCHES with porcelain base, metal cap, & turn or toggle control. 2- & 3-way switches needed, in working order. For use in historic wiring restoration of Fonthill Museum, Penn. Call Linda Dyke, Assistant Curator, (215) 348-9461.

REAL ESTATE

ST. AUGUSTINE, FL — Historical house dating prior to 1763, sensitively restored & completely updated, 3 BR, 2½ baths, original beams in parlor, formal DR, FP, additional building with hobbyroom & 2-car garage, much more. View of bay from balcony, walk to shops, church, & restored historical area. \$260,000; with extra lot, \$295,000. (904) 824-6303.

JEFFERSONVILLE, NY — 2 hrs. from NYC in farm & year-round resort area. Restored historical Victorian Gingerbread farmhouse. 12 rooms, 2 baths, attic, cellar, wrap-around porch. Approx. 23 acres wood & fields. Used as summer home, suitable for B&B. \$95,000. (718) 448-5570.

HIGHLAND, NY — Lovely Colonial built in early 1920s. Cherry woodwork, 2 stone FP. Mountain view, 88 rolling acres. L-shaped barn built 1884, income fruit trees. On good road 90 min. NYC, 15 min. college town. Low taxes, Ulster County. \$350,000. (914) 883-7130.



HINSDALE, IL — 1866 Designated Centennial Italianate on ¼-acre wooded lot. Beautifully restored. Free-form heated inground pool. 5 BR, 2½ baths, detached garage. 2 blocks from downtown. Separate entrance to 2 side rooms suitable for office. \$282,000. Kay Mitchell. (312) 986-8332; 325-4343.

ESOPUS, NY — Charming, secluded, historical house built by Benjamin & Maria DuBois, c. 1700. 3+ acres. Windows have old-fashioned glass. Interior cosmetic repairs needed. Has new furnace & roof. 1½ hours NYC, 10 min. to New Paltz State Teachers College. \$85,000. Gladys Rigoulot, PO Box 1, Esopus, NY 12429.

KATONAH, NY — Completely restored 1780 farmhouse on 1/3 acre on private road in quiet town. Walk to train station, 1 hour NYC. 2 baths, 4 BR, superinsulated, sunroom, chestnut & pine floors, oak & chestnut beams. \$199,000 firm. Steve Miller, Frog Hollow, Waccabuc, NY 10597. (914) 763-3078.

BATH, ME — Gracious 1802 Federal in Historic District. Restored in past 10 years. 6 FP, double LR, new kitchen, library, panelled DR, large pantry, 6 BR, 2½ baths, sunporch, 3-story barn/garage. 40 min. north of Portland on coast. \$155,000. D. Shipley, CHR Realty. (207) 443-3333.

PHILADELPHIA AREA — Camden, NJ. 2 Victorian houses. First in Historic District: 3-story stone & brick twin semi-shell. \$21,000. Second in Rutgers area near waterfront: 3-story brick, 6 BR, presently occupied. New roof, gas heat. Original cond. \$19,000. Financing available. (609) 365-2517; 964-5210.

SPENCER, IN — 100-year-old Victorian, beautifully restored. Structurally sound, 4500 sq.ft. All new furnace, a/c, plumbing, wiring, roof, insulation, water softener, water heater, baths, kitchen appliances. 4-5 BR, 2 baths. Flexible terms: \$94,900. Jayne Granger, Owens, Bryan, & Reed Realtors. (812) 336-6888; 332-9947, eves.

GEORGIA — Beautiful Queen Anne, 45 min. from Atlanta airport. 9 large rooms, 3 full modern baths, 2-story construction with balcony & wrap-around porch with turret. 2 large dens, modern country kitchen, parlor, DR, LR, 3 BR. \$55,000, will finance. Jim Gill. (404) 796-7592.

BATAVIA, IL — 1840s post-and-beam, plain Greek Revival. Nominated to Nat'l Register. Original features include FP with crane & oven. Recent roof, insulation, gas furnace, wiring, & plumbing. On nearly ½ acre, close to Chicago commuter lines. \$55,000. (409) 775-7985, (312) 879-8982, or (312) 584-4034.

PEMBROKE, ME — 1840s Greek Revival, birthplace of discoverer of insulin, Nat'l Register. Much rehabilitation completed including new well, septic, plumbing, wiring, roof, chimneys. 9 rooms plus attached carriage house & barn on unspoiled Cobscook Bay. \$62,500, partial owner financing. Barnett, PO Box 58, Pembroke, ME 04666. (207) 726-5151.



NEAR OCALA, FL — High Victorian Gothic Revival waterfront on St. Johns River. Impressive deepwater boathouse & ornate dock. Exc. cond. 21 rooms, 1½ landscaped acres. 6 BR, 2½ baths, updated kitchen, 8 FP, central a/c & heat. \$365,000. "The Palmettos." (513) 221-8811, (904) 685-3131, (904) 685-2126.

WORCESTER, NY — 1790 mill house property partially restored on 1 acre. 4 BR, 15 x 15 LR, DR, kitchen, large halls, wide board floors. Kitchen & baths are all new, oil & wood heat. Beautiful view of valley & hills. Barn included. \$45,000. Barry Jeschke, RD 2, Box 291, Worcester, NY 12197. (607) 397-9348.

BONIFAY, FL — Lovely Old South "Gone With The Wind" mansion. 7500 sq.ft., 6 BR, 7 FP, open staircase. \$350,000. L. Strayer, 930 Chia Rd., Palm Springs, CA 92262.

CINCINNATI, OH — 1855 Georgian. Completely restored 1984. 20 rooms. Parlor, w/FP, LR w/twin FP, DR w/FP, country kitchen, cherry cabinets, full bath. 9 rooms, 2 baths on 2nd floor, 6 rooms on 3rd floor. Nat'l Register. 2 acres. Brochure on request. T. Austing, Coldwell Banker Realtors. (513) 761-4725; 771-9180.

LEESBURG, VA — 1910 restoration in historic village, 30 miles commute to Washington. High ceilings, original pediment & cornice woodwork. 32-ft. LR w/FP. Updated kitchen, 3 BR, 2½ baths, expandable attic. Separate studio/office w/FP. Landscaped 1.2 acres. 8-ft-high boxwood alley. Space for n/s tennis court. \$199,500. (703) 777-6757.

RUSHVILLE, OH — Brick 2-story c. 1841 w/frame addition c. 1900. Nat'l Register. 6200 sq.ft. Storeroom, sleeping quarters, community room w/kitchen, & restroom facility, established ceramic workshop, small studio, & detached 1-story frame w/ R. RM. 90% restored. 45 min. from Columbus. \$85,000. Mark Griffith, Gorsuch Realty, 603 W. Wheeling St., Lancaster, OH 43130. (614) 743-1556.



PAW PAW, MI — Restored Carpenter Gothic, c. 1873. Original millwork, 2100 sq.ft. 3 BR, 2 baths, LR, DR, fam. room, kitchen, laundry/mud room, basement, attached garage. New furnaces, roof, wiring, plumbing, & insulation. 20 min. to Kalamazoo. Expandable. \$62,900. M. Smith, Cain Realtors. (616) 382-5563; 382-1527.

MURFREESBORO, TN — C. 1878 Second Empire. 7600 sq.ft., original fixtures, Italian marble hearths & mantels, incredibly ornate woodwork in exc. cond. In one family since construction. 30 min. from Nashville. Matt Ward, Bob Parks Realty. (615) 896-4040.

HAMBURG, NJ — Restored Victorian "Dreamhouse" used for location in TV movie of same name. Slate roof in exc. cond. White picket play yard, carriage barn, wrap-around gingerbread porch. Lots of appeal in charming town. \$89,900. Crystal Paling, Telridge Assoc. Realtors, PO Box 188, Hamburg, NJ 07419. (201) 827-6500.

NORTHWEST PA — 1831 Federal w/1870 addition, wide plank floors, original built-in zinc-lined tub, many historic details, historic area. 1870: 120 x 60. 2-bank barn/office/apt. w/separate utilities. Park Real Estate, 1059 Park Ave., Meadville, PA 16335. (814) 724-8233.

BOZEMAN, MT — Gallatin Gateway Inn, Nat'l Register. In Rocky Mountains, SW Montana. 24,000 sq.ft., built by Milwaukee Railroad on main route to Yellowstone. Open year-round. Hunting & fishing paradise. Brochure & inventory. Bob Roen, ERA Landmark Real Estate, 1612 W. Main, Bozeman, MT 59715. (406) 586-1321.

MEETINGS & EVENTS

"WALL STENCILLING in Western New York, 1800 to 1840." The first major museum exhibition surveying popular 19th-century interior decorating technique. Video-taped stencilling demonstration. Philip Parr, Curator. April through October. Rochester Museum & Science Center. 657 East Ave., Rochester, NY 14603. (716) 271-4320.

INNS & HISTORIC HOUSES

1877 VICTORIAN B&B settled among stately oaks near Orlando & Disney World. 2-BR suite with bath, private sunporch, period antiques. Take long walks in adjacent orange groves. Brochure. Meadow Marsh, Rt. 2, Box 423, Winter Garden, FL 32787. (305) 656-2064.

JESSE MOUNT HOUSE, 1854. Spacious 3-BR suites for 1 to 6 people. Air conditioned, FP, kitchen, walled garden. Brochure. 209 West Jones St., Savannah, GA 31401. (912) 236-1774.

HARRY PACKER MANSION, Victorian B&B. Restored in an elegant but comfortable style. Guest rooms have high-back beds & FP. Near Pocono recreation, Old Mauch Chunk Nat'l Historic District. Brochure. Packer Hill, Jim Thorpe, PA 18229. (717) 325-8566.

RESTORED VICTORIAN B&B. 2 BR with shared bath. 10 blocks from downtown Seattle, bordering historic Broadway district. Mingle memories of the past with present-day luxury of our hot tub & fine food. 1118 13th Ave., Seattle, WA 98122. (206) 323-5418.

MANCHESTER HIGHLANDS INN, Romantic Victorian inn, quiet location, spectacular view. Near summer theater, antiques. Short walk to town. Private baths, pool, bar, lounge, game room. Full country breakfast, dinners available. Box 1754HJ, Manchester, VT 05255. (802) 362-4565.

RESTORATION SERVICES

NO HISTORIC HOUSE is a home without a garden. Our staff will design an authentic period garden plan from a plot plan & photographs of your property. We provide plant sources, construction, installation, & maintenance tips. Brochure. Gardens Historic, PO Box 5934, Birmingham, AL 35259.

WOOD FLOORS, custom-made, domestic & imported hardwoods and heart pine. Period or contemporary designs. Wood, metal, tile, or marble inlays. Old-style herringbone parquet, heart pine parquet. Manufacture, install, restore, & finish to your specs. Alf Sjoberg, PO Box 157, Carrboro, NC 27510. (919) 967-0388.

RICHARD A. SCHUTT Investments, Notarized evaluation, insurance protection validation, estate valuation, etc. All areas of antiques & collectibles. Nat'l Assoc. of Antique Appraisers. Send \$10 per item plus short description & photo for fast response. Richard A. Schutt Investments, 4146 Marlaine Dr., Toledo, OH 43606.

HOME INSPECTOR willing to accept challenges of older house. Consultation, advice, written report on all systems & components: structural, electrical, septic, heating, plumbing, wells, termites, etc. Licensed professional. NY/NJ/CT. Edward Fitzgerald, Lawrence St., Tappan, NY 10983. (914) 359-0200.

MILLWRIGHTING services for restoration & repair of grist mills. Water wheels & water turbines installed & repaired. Mill equipment from stock or built to order. Manitou Machine Works, 14 Morris Ave., Cold Spring, NY 10516.

BLINDS & SHUTTERS from Smart's Mill, est. 1856. Any size, louvered or panelled, interior or exterior. Made from clear pine or hardwood using traditional mortise & tenon joinery & original water-powered machinery. Louvered doors & dividers also available. Beech River Mill Co., Old Rt. 16, Center Ossipee, NH 03814. (603) 539-2636.

VICTORIAN RESTORATION, interiors & exteriors. Painting, carpentry, general repairs, gutters, porches, doors, windows, locks, etc. Repairs that last. References. Gene, (617) 282-1662. Leave message please.

REHABILITATION of older buildings. Millwork, carpentry, painting, wallpapering, slate restoration, design & consultation services. Will travel New England area. Brookside Restorations & Remodeling, 109 Front St., Ballston Spa, NY 12020. (518) 885-6381.

**THE BEST
Plastering
Book
Is Back!**



Here's the book for anyone interested in the "lost art" of wet plastering, whether you just want to re-create 10 feet of missing plaster cornice, or need to replaster an entire wall. *Plastering Skills* is a textbook for apprentice plasterers. It's been out of print for 10 years, but is now available in this special limited edition published by American Technical Publishers exclusively for The Old-House Journal. The book explains how to make flat plaster walls & ceilings; special finishes, including various stucco textures. There's a chapter on ornamental plaster that tells in detail how to make run-in-place plaster cornices. All the steps are covered: making a cornice-running mould, dotting and screeding, running the cornices, mitering. This chapter also explains how to make coves, hang coffers, and run circular and elliptical centerpieces.

To get your copy of *Plastering Skills*, just check the box on the Order Form, or send \$24.45 (includes UPS shipping) to The Old-House Bookshop, 69A Seventh Avenue, Brooklyn, NY 11217.

The American Bungalow

THE AMERICAN BUNGALOW is a new book devoted to America's most popular house style. It's one of the most thorough — and readable! — architectural-style books we have ever seen. The lively, engaging text is complemented by hundreds of period photographs, line drawings, and diagrams. Author Clay Lancaster traces the Bungalow from its prototypes in India, but concentrates on its full flowering all across the United States. You'll discover the rich variety of this deceptively simple house style, in its incarnations from California to Brooklyn, Florida to New England: Bungalows in Rustic and Colonial styles; Bungalows influenced by Swiss and Japanese architecture, or by the Spanish and Dutch Colonial Revivals; even Adobe and Log Bungalows!

Here's a list of topics covered in *The American Bungalow*

1. Origin and Meaning of the Term 'Bungalow' and the Indian Imprint upon English Architecture
 2. Native Antecedents to the American Bungalow
 3. Early Eastern Bungalows
 4. Prairie Houses and Bungalows
 5. The California Bungalow
 6. Specialized Type Bungalows
 7. The Bungalow Box
 8. Bungalow Plans, Interiors, Furnishings
 9. Bungalow Site Planning & Gardening
 10. A Summing Up and an Evaluation of the American Bungalow
- Appendix: My Father's Bungalow

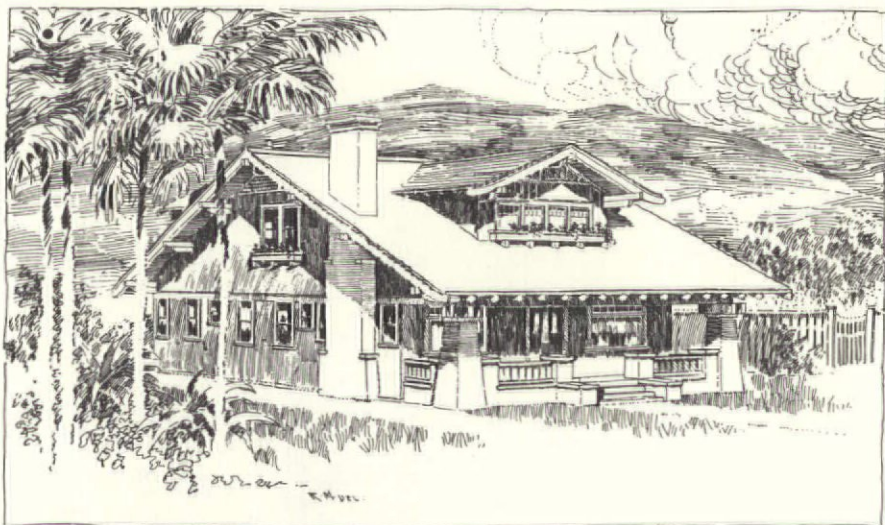

**How
To**

Restore Woodwork

Old House Woodwork Restoration tells you all the facts about how to rescue your staircases, doors, siding, floors, trim, etc. — all the wooden elements of your house. It has the best information of any book we've seen on stripping paint & then selecting a finish. The first book to focus strictly on restoring architectural woodwork, it's also a fine how-to text, with a sensitive attitude toward preservation, practical do-it-yourself advice, & step-by-step instructions.

To receive **Old House Woodwork Restoration**, check the box on the Order Form, or send \$15.45 to The Old-House Bookshop, 69A Seventh Avenue, Brooklyn, NY 11217.

CLAY LANCASTER is a respected architectural historian, the author of numerous articles and books. He also has another, very special qualification for writing *The American Bungalow*: He grew up in a Kentucky Bungalow, which is the focus of a charming reminiscence at the conclusion of his book. His affection and enthusiasm make the book more than an architectural survey. Reading *The American Bungalow* takes you into an earlier era, one of simplicity and comfort, taste and restraint; a time when houses were designed to harmonize with the environment. He brings to life all these virtues that have inspired today's Bungalowmania.

IF YOU own a Bungalow, you'll be thrilled to discover the chapter that thoroughly describes authentic Bungalow interiors. Homeowners are constantly writing us for information on Bungalow and Craftsman colors, furnishings, and wall and ceiling treatments. Now they can learn the facts directly from Clay Lancaster. He devotes a major, fully illustrated chapter to Bungalow interiors — in-

cluding kitchens and bathrooms, the rooms perennially ignored by most architectural histories. There's also, of course, a chapter on appropriate site planning & gardens. After all, the whole Bungalow design philosophy centered on the relationship of the house to its natural surroundings.

THE AMERICAN BUNGALOW is a must for all Bungalowers & Bungalowlovers. But Clay Lancaster explains the spirit behind the style, making his book a practical help for anyone whose house was built between 1900 and 1930. Don't forget, the Bungalow was more than just a house style; it was also a design movement that affected the majority of American houses built in the first quarter of the 20th century.

TO RECEIVE your copy of *The American Bungalow*, just check the box on the Order Form, or send \$32.45 (includes UPS shipping) to The Old-House Bookshop, 69A Seventh Avenue, Brooklyn, NY 11217.



The Old-House Bookshop



Century Of Color

20 This book is the most comprehensive and practical guide available to authentic, historically accurate, exterior paint colors. It features 100 color plates of 'plain' Victorian & vernacular Classic houses, as well as the expected showpiece homes, covering the years 1820 through 1920. All the color combinations emphasize the rich character of the architects' designs. There are also Affinity Charts with 200 color combinations sufficiently diverse to stimulate everyone's taste.

Softcover, 108 pages, 8½ x 11
\$15.00, includes UPS shipping and handling

47 MODERN CARPENTRY — An outstanding textbook that clearly explains building materials, tools, & construction methods, and the planning and sequencing of major home repairs. 592 pages. Hardcover, \$20.45.

23 OLD HOUSE WOODWORK RESTORATION — This book deals exclusively with restoring architectural woodwork. It's filled with practical do-it-yourself advice and step-by-step instructions. It has the best information of any book we know on stripping paint from wood and then selecting an appropriate finish. Generously illustrated with instructive photos. 200 pages. Softbound, \$15.45.

13 TASTEFUL INTERLUDE — Rare photos of original interiors from the Civil War to World War One. Of great value to anyone decorating in a period style. Written by William Seale. 284 pages. Softbound, \$15.45.

48 GAZEBOES — With this book, you can order plans for 7 pergola-arbors, 13 strombrellas, 18 birdhouses & feeders, and 55 gazebos. It has dozens of design styles, from Victorian to Rustic, Asian to European to Americana. A treasure trove for all do-it-yourselfers! 96 pages. Softbound, \$10.45.

55 PLASTERING SKILLS — This outstanding, long-unavailable book was designed as a textbook for vocational schools. Its no-nonsense writing & wealth of illustrations explain all the basics of plastering, and take you up to running decorative cornices, making special finishes, & hanging coffers. 543 pages. Softbound, \$24.45.

57 THE AMERICAN BUNGALOW — Hundreds of period photos trace America's most popular house style, from its roots in India to its blossoming in California. This book is brilliantly researched — and a pleasure to read! 256 pages. Hardcover, \$32.45.

42 BUILDING KITCHEN CABINETS — Basic, straightforward instructions and over 150 illustrations make this complicated job a snap for any do-it-yourselfer with carpentry skills. Every step of the job is covered: buying hardware; estimating costs; constructing & installing cabinets. 144 pages. Softbound, \$14.45.

49 THE MOTION-MINDED KITCHEN — This book surveys how to design, plan, and construct a kitchen that's both efficient and appropriate to your old house (without costing a fortune). 146 pages. Softbound, \$12.45.

38 THREE BASIC HOW-TO BOOKS — This set of books gives you a wealth of information on wiring, plumbing, and roofing. Total 464 pages. Softbound, \$22.45.

Reprinted Pattern Books

16 VICTORIAN ARCHITECTURE — A reprint edition of two classic architectural pattern books: A.J. Bicknell's of 1873 & W.T. Comstock's of 1881. Hundreds of illustrations of houses & ornamental details in the Mansard, Queen Anne, & Eastlake styles. 192 pages. Jumbo 10 x 13 size. Softbound, \$16.45.

33 THE COTTAGE SOUVENIR — The splendor of the Queen Anne style is captured in this reprint edition of George F. Barber's 1891 portfolio of mail-order houses. Over 350 elevations, floor plans, and architectural details, including large, striking photos. 200 pages. Softbound, \$17.50.

56 VICTORIAN INTERIOR DETAILS — Facsimile edition of a lavishly illustrated 1882 book, with hundreds of patterns for interior woodwork: mantels, mouldings, door & window trim, panelled ceilings, bookcases, wainscoting, and more. 96 pages. Jumbo 10 x 13 size. Softbound, \$12.45.

54 THE GARDEN BOOK — This quality, oversized book overflows with gorgeous, full-color photos & drawings. It's also the best and most thorough book in its field, covering the entire range of garden styles; how to plan, construct, & maintain a garden; choosing & using plants — from flowers to trees to grass to vegetables. 288 pages. Hardcover, \$24.95.

53 CURTAINS & WINDOW TREATMENTS — All the practical, appropriate curtain choices for your old windows. You'll learn all about specific types of curtains and techniques for making them; window styles; tracks and fittings; color, design, fabrics; tools; stitches & seams; linings. 120 pages. Hardcover, \$18.95.

The 1985 OHJ Buyer's Guide Catalog

12 This book is the 'Yellow Pages' for pre-1939 houses: a comprehensive buyer's guide listing 1,348 companies. That's almost 10,000 hard-to-find, old-house products & services at your fingertips. From hand-printed wallpapers to marble mantels, wooden porch ornament to brass lighting fixtures — all meticulously indexed and cross-referenced. All listings have also been carefully screened by the OHJ editors.

Softbound, 216 pages, 8½ x 11
\$10.95 to current OHJ subscribers
\$13.95 to non-subscribers

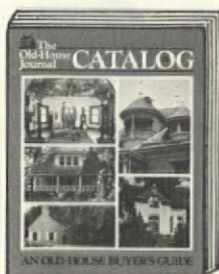

Subscription To The Old-House Journal

- New Subscription Renewal (Enclose Current Mailing Label)
- 1 Year — \$18 2 Years — \$32 3 Years — \$39

Old-House Journal Yearbooks: The Restoration Encyclopedia

Each Yearbook is a compilation of a full year's worth of OHJ issues.

- 76 1976 — \$14 80 1980 — \$18 700 The 1970s Set — \$39.00
1976-1979 at 77% the price.
You save \$17!
- 77 1977 — \$14 81 1981 — \$18
- 78 1978 — \$14 82 1982 — \$18 800 The 1980s Set — \$59.00
1980-1984 at 64% the price.
You save \$31!
- 79 1979 — \$14 83 1983 — \$18
- 84 1984 — \$18 700-800 The Full Set — \$98.00
All 9 Yearbooks at 67% the price.
You save \$48!

Send My Order To:

Name _____

Address _____

City _____ State _____ Zip _____

Amount enclosed: \$ _____

NY State residents please add applicable sales tax.

NOTE: If your order includes books or merchandise, you must give us a STREET ADDRESS — not a P.O. Box number. We ship via United Parcel Service (UPS), and they will not deliver to a P.O. Box.

Please clip this page and mail together with check payable to The Old-House Journal to THE OLD-HOUSE JOURNAL, 69A Seventh Avenue, Brooklyn, NY 11217.

The Old-House Journal

JUL85

All prices postpaid
Please allow 4 to 6 weeks
for delivery.
We regret that we cannot ship
books or merchandise overseas.

OHJ Binders

22 BINDERS — Brown vinyl binders embossed in gold with the OHJ logo. Holds a year of issues, \$6.75 each.

OHJ Tool Shop

The OHJ editors have tested every paint-stripping heat tool on the market. And in our opinion, these two industrial grade, all-metal heat tools take off the most paint in the shortest time.

- 11 MASTER HG-501 HEAT GUN — \$77.95
For stripping moulded and turned woodwork
- 10 HYDELECTRIC HEAT PLATE — \$39.95
For exterior stripping and large flat surfaces

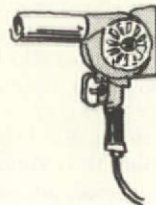

TV HEAT GUNS AREN'T SO HOT...

...figuratively or literally. We've tried every paint stripping heat gun on the market. And in the opinion of the OHJ editors, the Original Red Metal Master HG-501 takes off the most paint in the shortest time. It's the tool we reach for when stripping paint in our own houses.

In unbiased, get-to-the-bottom-of-it testing for our upcoming Paint Stripping Manual, the Old-House Journal editors tested every heat gun around — including the new mass-market heat guns that are advertised on TV.

Based on this research, we found that the original red, all-metal Master HG-501 is still the best-performing heat gun. This same conclusion was reached by *Family Handyman* magazine in test results published in their April 1985 issue.

After testing all available heat guns, here's what Family Handyman magazine said about the HG-501:

"It did the best job for me."

Mark Bittman, Family Handyman, April 1985

Although The Old-House Journal has been selling the Master HG-501 for several years, we have no ties to Master. (We are free to sell *any* heat gun — or no heat gun at all.) We offer the Master HG-501 because it is an industrial tool that is not generally available to homeowners. For our readers who want the best, we'll continue to make available the all-metal HG-501 by mail.

THE HG-501 vs. TV HEAT GUNS

In our tests, we found three major differences between the Master HG-501 and the mass-market TV heat guns: (1) the phrase "high-impact corrosion resistant material" means "plastic." The HG-501, on the other hand, has an industrial-quality cast-aluminum body that will stand a lot of rugged use. (2) With cheaper heat guns, heat output drops off after a while — which means slower paint stripping. The HG-501 runs at a steady efficient temperature, hour after hour. (3) When a cheaper heat gun is dead, it's dead. By contrast, the long-lasting ceramic heating element in the HG-501 is *replaceable*. When it eventually burns out, you can put a new

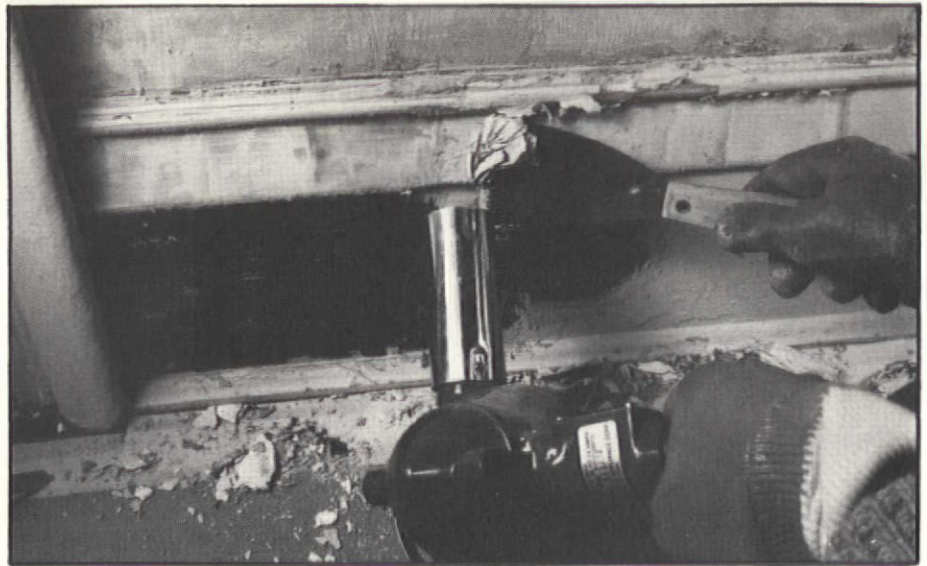

During tests for the OHJ Paint Stripping Manual, the professional-quality HG-501 stayed hotter longer than other heat guns — giving it more paint stripping power.

one in yourself for \$8. (OHJ maintains a stock of replacement elements.)

Also, with the HG-501 you get two helpful flyers prepared by our editors: one gives hints and tips for stripping with heat; the other explains lead poisoning and fire hazards. OHJ is the *only* heat gun supplier to give full details on the dangers posed by lead-based paint.

ABOUT "HOMEOWNER" TOOLS

Tools fit into two categories: serious dependable tools used by professionals, and "homeowner quality" — which are less durable. Manufacturers don't sell professional-quality tools in hardware stores, believing that homeowners can't tell the difference in tool quality. The makers assume that *price* is the primary consideration in the do-it-yourself market. . .and that since most homeowner tools don't get hard use, the lower quality isn't important.

However, if you've ever stripped paint, you know that any stripping tool gets *heavy* use under dirty, dusty conditions. The all-metal HG-501 is the *only* industrial-grade, heavy-duty heat gun.

HOW WE CAME TO SELL THE MASTER HG-501

The Old-House Journal created the market for paint stripping heat guns. Back in 1976, Patricia & Wilkie Talbert of Oakland, Calif., told us about a remarkable way they'd discovered to strip paint in their home: using an industrial tool called a heat gun. We published

their letter. . .then were deluged with phone calls and letters from people who couldn't find this wonder tool, the HG-501.

Further investigation revealed that it was a tool meant for shrink-wrapping plastic packaging. The HG-501 was made by a Wisconsin manufacturer who wasn't interested in the retail market. So, as a reader service, The Old-House Journal became a mail-order distributor. Since then, more than 10,000 OHJ subscribers have bought the HG-501. . .and revolutionized the way America strips paint.

Specifications for the HG-501:

- Fastest, cleanest way to strip paint. Heat guns are NOT recommended for varnish, shellac, or milk paint.
 - UL approved.
 - Adjustable air intake varies temperature between 500 F. and 750 F.
 - Draws 14 amps at 115 volts.
 - Rugged die-cast aluminum body — no plastics.
 - Handy built-in tool stand.
 - 6-month manufacturer's warranty.
 - Guaranteed by The Old-House Journal: If a gun malfunctions within 60 days of purchase, return it to OHJ and we'll replace it free.
 - Price: \$77.95 — including UPS shipping. Use Order Form in this issue.
-

opinion...
Remuddling of the month



SUBSCRIBERS Jackie and Steve Scarbrough sent us these photographs: "This house is in an old neighborhood in Knoxville, Tennessee. Most of the old Victorian homes are experiencing beautiful revivals. (My husband and I own a Victorian that we take great pride in.) My stomach turned when I came across this poor house, stripped of all its embellishment and character. Besides the obvious gross replacement of windows, and the substitute siding, where's the front porch? Where's the front door? Steps leading to a blank house." 

**The
Old-House
Journal**[®]

69A Seventh Avenue,
Brooklyn, New York 11217

NO PAID ADVERTISING

Postmaster: Address Correction Requested

BULK RATE
U.S. Postage
PAID
Pittston, PA
Permit No. 210

45-28494-56 11P
010864411

8 MAY 86 M

KEITH WEBER
14 S ELDORADO ST
SAN MATEO

CA 94401**