

The Professional's Resource for Public & Residential Architecture

JUNE 2019

# TRADITIONAL BUILDING

## *Heirloom Outdoor Living*

ORSON WELLES CALIFORNIA HOUSE

Henry Ford's Lighting Restoration

Q&A WITH THOMAS A. KLIGERMAN

PRSR STD  
U.S. Postage  
PAID  
Long Prairie, MN  
Permit No. 67

Traditional Building  
5720 Flatiron Parkway  
Boulder, CO 80301  
Change service requested.



# TIMBERLANE

Because every "Welcome Home" moment should be extraordinary



## CONTINUING TRADITION WITH HANDCRAFTED, QUALITY SHUTTERS

Historically Accurate | Handcrafted Details | High Quality Shutters

Find Inspiration For Your Timberlane Shutters  
**1-800-250-2221 • [Timberlane.com/Traditional](https://www.timberlane.com/Traditional)**





Grandberg & Associates Architects; Photograph Courtesy of Coastal Point Construction

# CHADSWORTH INCORPORATED

COLUMNS BALUSTRADES PERGOLAS MILLWORK SHUTTERS

[WWW.COLUMNS.COM](http://WWW.COLUMNS.COM)

1-800-COLUMNS

277 North Front Street, Historic Wilmington, NC 28401 Tel: 800.486.2118 [Sales@Columns.com](mailto:Sales@Columns.com)



SAME DAY SHIPPING FROM LOS ANGELES, DALLAS, ATLANTA & BALTIMORE



# Gates, fences and railings just got a re-boot!

King Metals' new line of contemporary forgings gives a simpler choice to your gate, banister or railing projects. The clean lines & shapes are a perfect fit to any home projects or renovations. Call King Metals today to get started!

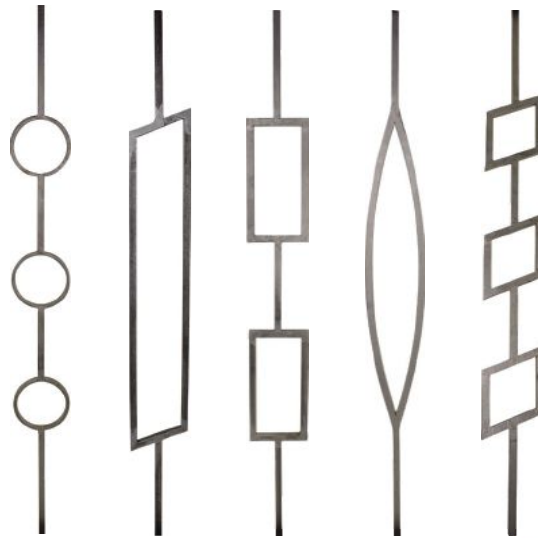

TAKE **10%** Off  
Catalog Prices thru June!

Just use promo code:

**TB10**

when you checkout!

Offer excludes commodity steel and custom plasma. Can not be combined with any other offer. Sale ends 06/30/19.



**SAME DAY SHIPPING**  
to all 50 states from a facility near you!

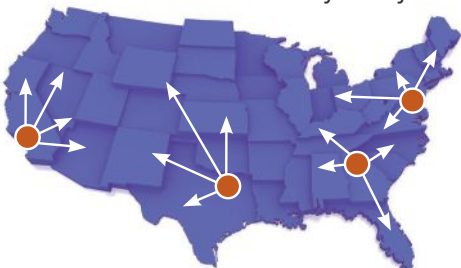

FASTER • CHEAPER • BETTER

800.542.2379 | KINGMETALS.COM | FACEBOOK | PINTEREST | YOUTUBE

**KINGMETALS** LOS ANGELES  
DALLAS  
ATLANTA  
BALTIMORE





Your great-great-great-great  
grandchildren “may” have to replace them.



10 South Inman Avenue • Avenel, NJ 07001  
(800) 278-3667 • [ArtisticDoorsAndWindows.com](http://ArtisticDoorsAndWindows.com)



INNOVATION OR REPLICATION  
FOR ARCHITECTS • DESIGNERS • CONTRACTORS

LIGHTING SOLUTIONS



**IDAHO STATE CAPITOL**

LIGHTING RESTORATION AND REPLICATION BY

***SAINT LOUIS ANTIQUE LIGHTING CO.***

801 North Skinker Boulevard, St. Louis, MO 63130

Phone:(314)863-1414 FAX: (314)863-6702 Email: slalco@slalco.com



WINDOWS TO THE PAST, PRESENT, AND FUTURE.



For more than a century, Hope's has crafted the world's finest solid steel and bronze windows and doors. Hope's exclusive hot-rolled steel profiles maintain the traditional aesthetic of historic buildings while upgrading performance and efficiency to modern standards. These profiles, along with unique glazing beads and muntin bars, are specially designed to replicate early steel window elements such as putty glazing and slim historic sightlines for beautifully enduring views to the past, present, and future.

**HOPE'S**<sup>®</sup>

[hopeswindows.com](http://hopeswindows.com)

ARCHITECT: Peyton Boyd Architect  
PHOTOGRAPHER: Fresh Air Photo



# CONTENTS

JUNE 2019

34



## 34 Quiet & Grace

With woodlands to the east and an open meadow to the west, this landscape is classically designed to be in harmony with its history and surroundings.

42



## 42 Staying in Character

A prominent Los Angeles architecture firm breathes new life into a storied estate formerly owned by Hollywood icon Orson Welles for a couple and their daughter.

48



## 48 Landmark Restoration

A French Renaissance-style building in New York is carefully restored.

54

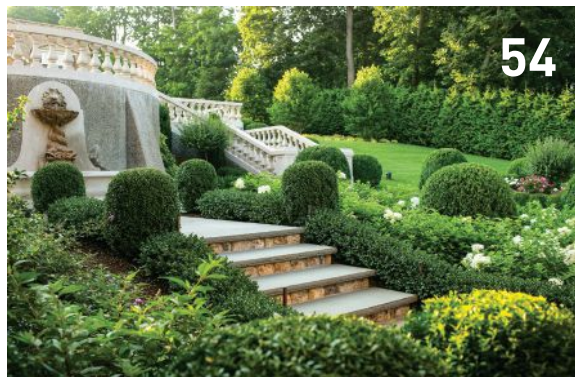

## 54 Protecting an American Classic

Janice Parker's thoughtful revival of an Ellen Biddle Shipman landscape in Connecticut.

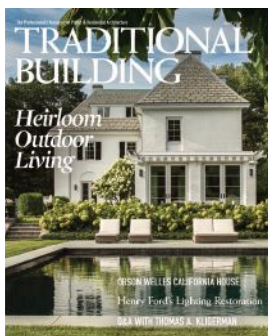

### ON THE COVER

Dan Gordon Landscape Architects wins a Bulfinch Award for a stunning project.

See more on page 34.

Photo by Neil Landino

## BUYING GUIDES

Historical Products Showcase .....	64
Greenhouses, Gazebos & Outbuildings. ....	68
Professional Services .....	70
Epoxies & Finishes. ....	71
Landscape & Garden Specialties .....	72
Window Restoration & Repair .....	74
Exterior Lighting & Gas Lighting .....	75
Masonry Restoration, Cleaning & Waterproofing ..	78

## FREE INFORMATION GUIDE . . . .60

## ARCHITECTURAL ANTIQUES & SALVAGED MATERIALS RESOURCE GUIDE . . . . .62

### INDUSTRY NEWS

## 10 Traditional Building Conference Series and Palladio Awards

### INTERVIEW

## 12 Pushing History

Architect Thomas A. Kligerman is a champion of traditional design presented in a modern way.

### THE TRADES

## 18 Lighting up History

Heritage Metalworks creates chandeliers and sconces to bring Ford's Fair Lane Estate back to its 1919 grandeur.

### HISTORIC MATERIALS

## 22 Bronze Age

Bronze has been used as ornament for centuries in our built environment.

### TECHNIQUES

## 26 The George Peabody Library Skylight

A light approach to reinforcing heavy metal.

### PRODUCTS IN-DEPTH

## 30 Treasure Hunt

Architectural salvage continues to provide patina in new projects.

### OPINION

## 80 What's the Rush?

Resurrecting this iconic building should not be done in haste.







2018 Palladio Awards: Restoration/Renovation  
Project: Cunningham  
Winner: T.S. Adams Studio, Architects  
Masonry: Aztec Stone Empire, Norcross, GA

**We Specialize in Architectural Accents and All Natural Stone**



Back Of Residence



-  Aztecstoneempire
-  Aztecstoneempire
-  Aztecstoneempire

**770-368-9337**

**5055 Buford Highway Norcross, GA 30071**





Clara Barton Missing Soldiers Office | Washington D. C



**EVERGREENNE**  
Architectural Arts

CONSERVATION. RESTORATION. SPECIALTY CONSTRUCTION.

212.244.2800 | [www.evergreenne.com](http://www.evergreenne.com)



Visit us online at  
**TraditionalBuilding.com** to

- learn about our free educational series offering AIA credits
- read our bloggers latest posts
- browse our book reviews and story archives
- and much more

# TRADITIONAL BUILDING

FOUNDER, EDITOR EMERITUS **Clem Labine**

EDITOR **Nancy Berry**

MANAGING EDITOR **Emily O'Brien**

CONTRIBUTING EDITORS  
**Gordon Bock**  
**Judy L. Hayward**  
**Nancy A. Ruhling**

CREATIVE DIRECTOR **Edie Mann**

ART DIRECTOR **Mark Sorenson**

ADVERTISING COORDINATOR **Kim Hoff**

PREPRESS SPECIALIST **Idania Mentana**

ASSOCIATE PUBLISHER **Jennifer Baldwin**

MANAGING DIRECTOR - CLIENT SOLUTIONS **Dean Horowitz**

INFORMATION SERVICES MANAGER **Dorian Henao**



PRESIDENT, PUBLISHER **Peter H. Miller, Hon. AIA**

SALES DIRECTOR **Heather Glynn Gniazdowsk**

EDITORIAL DIRECTOR **Patricia Poore**

DIRECTOR OF DIGITAL MARKETING **LJ Lindhurst**

STRATEGIC CAMPAIGN MANAGER **Taylor Jackson**

MARKETING MANAGER **Griffin Suber**

FACILITIES MANAGER **Tony Wilhelms**

#### TRADITIONAL BUILDING CONFERENCE SERIES

EDUCATION DIRECTOR **Judy L. Hayward**

DIRECTOR OF OPERATIONS **Carolyn Walsh**



ACTIVE INTEREST MEDIA

PRESIDENT & CEO **Andrew W. Clurman**

SENIOR VP, CFO, COO & TREASURER **Michael Henry**

CHIEF INNOVATION OFFICER **Jonathan Dorn**

VP OF AUDIENCE DEVELOPMENT **Tom Masterson**

VP, PRODUCTION & MANUFACTURING **Barbara Van Sickle**

VP, PEOPLE & PLACES **JoAnn Thomas**

VP, DIGITAL PRODUCTS & PLATFORMS **Katie Herrell**

VP, IT **Nelson Saenz**

AIM BOARD CHAIR **Efrem Zimbalist III**

Subscriptions & Subscriber Service: 800-548-0193;  
Traditional Building, P.O. Box 3000, Denville, NJ 07834-9965

Traditional Building (ISSN # 0898-0284) is published February, April, May, June, August, September, October and December by Active Interest Media, 5720 Flatiron Parkway, Boulder, CO 80301.

Subscription rate to professionals in architecture, interior design, construction and landscape design in the U.S. and possessions: \$48/yr. (8 issues). Not available outside the U.S. postal system.

Contents of *Traditional Building* are fully protected by copyright and must not be reproduced in any manner whatsoever without written permission from the publisher.

Copyright 2019 by Active Interest Media, 5720 Flatiron Parkway, Boulder, CO 80301;  
800-826-3893; Fax: 303-440-1618; Subscription inquiries: 800-548-0193

LIST RENTAL: THE INFORMATION REFINERY 201-529-2600

Logo Licensing, Reprints and Permissions Contact  
Brett Petillo, Wright's Media 1-877-652-5295 [aim@wrightsmedia.com](mailto:aim@wrightsmedia.com)





# Endless Possibilities with Allied Window



Millicent Library - Fairhaven, MA

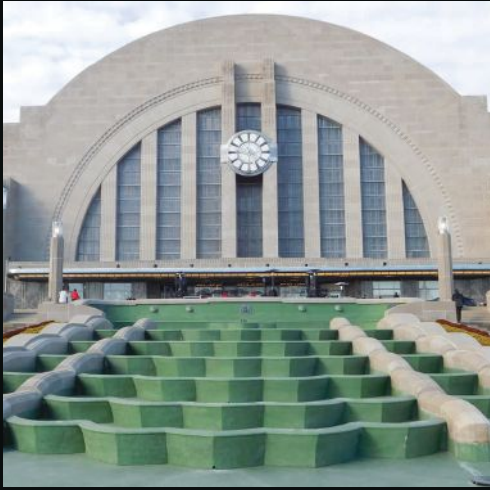

Cincinnati Union Terminal - Cincinnati, OH



TARC Union Station - Louisville, KY



University of Arkansas - Faulkner Performing Arts Center - Fayetteville, AR



Landmark Lofts - New Braunfels, TX



Moody Mansion - Galveston, TX



The Motherhouse of Baxter Woods - Portland, ME



Allied Window, Inc.

1111 Canal Rd., Cincinnati, OH 45241

www.alliedwindow.com 800-445-5411

- Interior & Exterior Storm Windows
- Custom Colors
- Custom Screens & Special Shapes
- Historic, Residential & Commercial Buildings
- Energy Savings Approx. 50% - Sound Reduction up to 80%





BOSCOBEL MANSION, GARRISON, N.Y



We will present the 2019 Palladio Awards at the Boscobel Conference.



## Palladio Awards Presentation

The 18th annual Palladio Awards competition recognizes 16 firms for outstanding work in traditional design, seven in the commercial, institutional, and public architecture category and nine for residential work. This competition is the *only national* design awards program honoring achievement in traditional architectural design. Awards will be presented on Tuesday evening during the conference. For more information, visit [traditionalbuildingshow.com](http://traditionalbuildingshow.com).

## Traditional Building Conference Series

Join us this summer in the Hudson Valley **July 16-17, 2019!** Courses, for AIA learning units, will include:

- **Restoration**
- **Sustainability**
- **Masonry**
- **Jefferson's Rotunda**
- **And more!**

Attendees will enjoy architectural walk-

ing tours and behind the scenes access to Boscobel. In the nighttime hours following the conference, the Hudson Valley Shakespeare Festival while be joining us on Boscobel's grounds. Meet the editors of *Traditional Building*, *Old House Journal*, and *New Old House*. Network with industry peers, clients, and the technical representatives from restoration/renovation product suppliers.



SPECIALISTS IN ROOFING AND ARCHITECTURAL SHEET METAL WITH IN-HOUSE FABRICATION, WE ENSURE THE HIGHEST DEGREE OF QUALITY CONTROL AND COST EFFECTIVENESS.

**INSTITUTIONAL • COMMERCIAL  
HIGH-END RESIDENTIAL**



3434 PARKVIEW AVE • PITTSBURGH, PA 15213  
412-687-1517 • [INFO@NIKOCONTRACTING.COM](mailto:INFO@NIKOCONTRACTING.COM)  
[WWW.NIKOCONTRACTING.COM](http://WWW.NIKOCONTRACTING.COM)

*Quality Craftsmanship Since 1974*



*Traditional by Design*



Join Our Professional Trade Partner Program  
Everyday Savings • Dedicated Support • Free Shipping

[www.HouseofAntiqueHardware.com](http://www.HouseofAntiqueHardware.com)



RESTORATION / REPLICATION / CUSTOM CASTING

# Robinson Iron

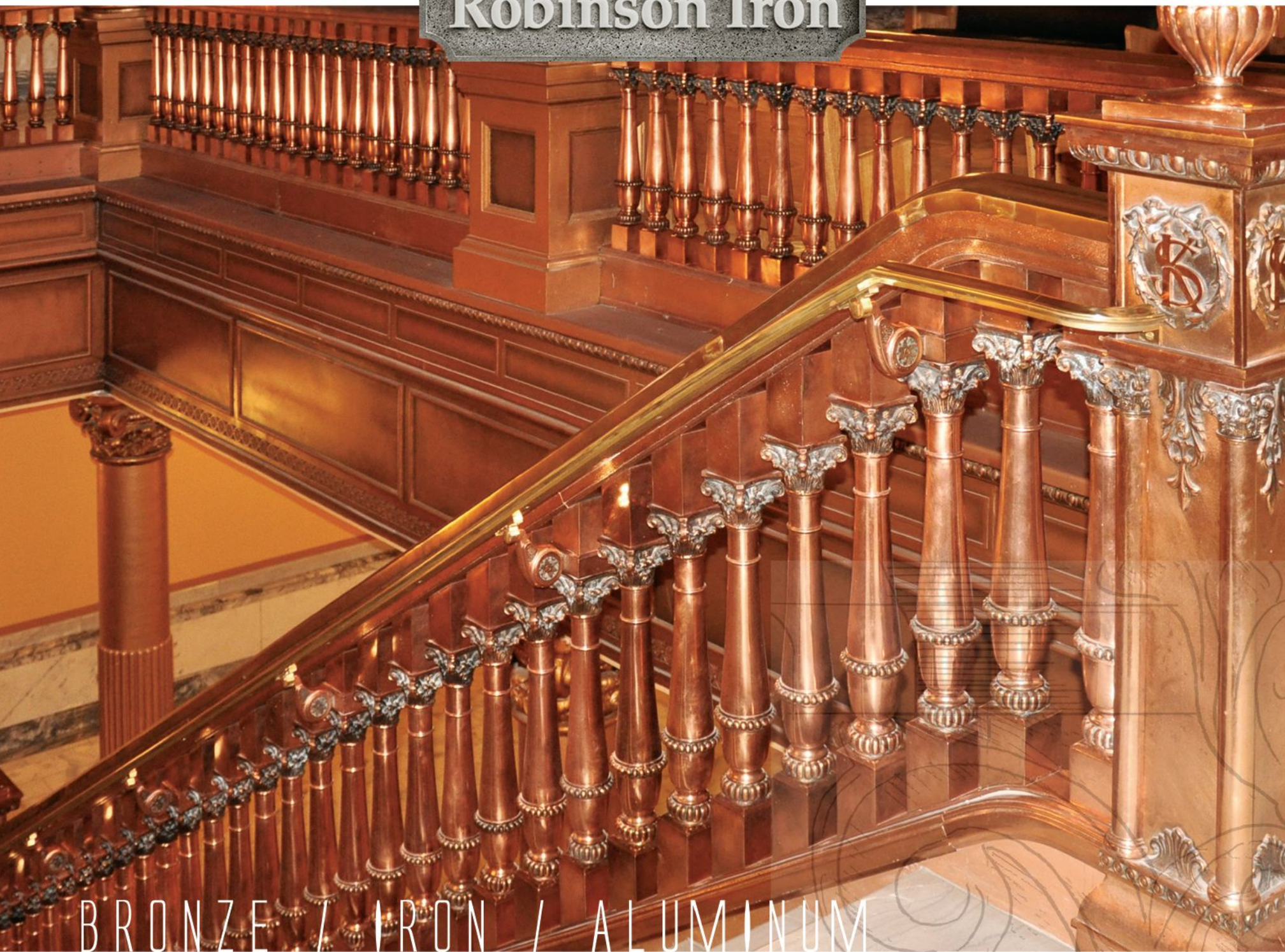

BRONZE / IRON / ALUMINUM

Artisans of cast metal since 1946.

800.824.2157

256.329.8486

[robinsoniron.com](http://robinsoniron.com)





# Pushing History

Architect Thomas A. Kligerman is a champion of traditional design presented in a modern way.

**BELOW** The master bedroom overlooking Little Narragansett Bay in Watch Hill, Rhode Island.

**BOTTOM LEFT** Oceanfront house in Sagaponack, New York — traditional exterior, contemporary interior.



Photos courtesy of Thomas A. Kligerman



**Thomas A. Kligerman is not just an architect.** He's a designer, adventurer, and cultural philosopher who loves pushing tradition and history forward. "If I wasn't an architect, I would be designing cars," he says, adding that he's a "modernist at heart with a deep love for architectural history." He likes finding the intersections of architecture in all forms, genres, and eras and the historical overlaps. For him, travel is fundamental, and his journeys around the world include a recent

stint at the American Academy in Rome as a Visiting Scholar. Kligerman's adventures in architecture began at Columbia University studying with Robert A. M. Stern, followed by a Master of Architecture from Yale School of Architecture. Returning to New York, he spent seven years working with Stern and today is a partner at renowned firm Ike Kligerman Barkley, all the while pushing his passion for architectural history into a visual conversation about historical modernism and perspective.



# WHAT IS SUSTAIN KRETE?



## PROTECT YOUR CONCRETE... AND THE ENVIRONMENT!

**Sustain Krete™** Sustain Krete is a soy-based penetrant that is revolutionizing how builders and homeowners extend the lifespan of their concrete. This ingenious new product penetrates deep into the pores of the concrete, creating a hydrophobic barrier which blocks water and salt.

As the result of a partnership between Purdue University and the Indiana Soybean Alliance, Sustain Krete is backed by a legendary reputation for scientific excellence and was used on US Highway 231 in Lafayette, IN. This amazing penetrant was born and manufactured in the Midwest, provides superior protection against the harsh weather conditions found across the country, and is poised to be the next big thing in concrete.



This product is **Green**,  
**Soybean Oil-based**, **Odor-free**,  
and **100% Sustainable!**

### What does it do?

- Penetrates up to 15mm
- Creates a hydrophobic barrier, filling all pores and remaining in liquid state
- Protects concrete surface and subsurface
- Prolongs concrete life for 7-10 years

### Where do I use it?

- Driveways
- Patios
- Sidewalks
- Swimming Pools
- Porches
- any concrete surface!
- Garages



**SUSTAIN**  
KRETE™



**QUESTIONS? CONTACT US!**

 (800) 882-0009

 [www.cshardware.com](http://www.cshardware.com)

 1170 N. Wauwatosa Rd.  
Cedarburg, WI 53012





A clerestory to the second floor passageways, and skylight, brings daylight into this house in the mountains of South Carolina.

**1 You are a “modernist at heart” who “loves history, doesn’t want to ape, and wants to push tradition in a modern direction.” Can you elaborate?** At Columbia, Robert A. M. Stern had us really delve into architectural history, which I loved and still do. That’s what I typically post on my Instagram page. But it is also 2019, and there is a history of modernism that makes today different from the 1900s, 1800s, and other eras of architecture. Ignoring this would mean turning your back on a huge side of cultural development and history. For me, it’s important to create a building that lives in today—form, shade, and shadow that, yes, are rooted in more traditional styles. It behooves all of us to move the needle on architectural history. And it is not enough to re-create. I like a little more mystery and the idea of trying to come up with a new way of looking at things.

**2 You spent a significant amount of time in Rome (as a visiting scholar at the American Academy). What is it about the city that, as you say, opens up perspective?** I have been fascinated with Rome since my first visit when I was 17. I love the ruins—their scale, how they are an armature for something else, and how they rip through the side of a building or cut through the city. And most importantly, I love their incomplete nature. Not really unfinished but “de-finished,” so to speak, and the beginning of something else. Those leftovers are incredibly suggestive and everyone interprets them differently, depending on your walk of life—architect, painter, historian. I look at them as great sculptural forms that emphasize shadows and the movement of the sun. I try and bring that into my architecture. Something that is not so complete that it sets the design in a way that leaves no room for imagination. When I was in graduate school, I realized that the unfinished drawing brings more to the conversation, to the project. Rome is like that—an armature for discussion asking, “What do these things suggest to you?”

**3 We talked about your passion for design—cars, industrial, and architecture, and you said that your path is creating “art form that has to function,” and how you love those “in-between zones that blend together yet have tension.”** I love bringing disparate ideas together to see what happens when creating a new building. Building is both art and function, and I like that buildings function as art. For example, I love when a client comes to me with an idea for, say, a Shingle Style house and they really like Mies van der Rohe. That [the conversation] produces really interesting





# HEARTWOOD

FINE WINDOWS AND DOORS™

Imagination  
is the  
Only Limit

*Dalgliesh Gilpin Paxton Architects*

Custom Architectural Wood Windows & Doors • Hand Crafted • Period Accuracy

[www.heartwoodwindowsanddoors.com](http://www.heartwoodwindowsanddoors.com)





**ABOVE** Study in a tower— Cherokee red windows, black and tan millwork and a raw white oak ceiling.

**TOP LEFT** A house in Costa Rica rendered in watercolor for a client presentation.

**TOP RIGHT** A second design for a house in Costa Rica rendered in watercolor for a client presentation.

work. And it makes it harder to ape an older building style. It's that conversation of seemingly separate disparate ideas that really drives me lately. For example, I love two inherent American architectural styles—Shingle Style and ruins of native Puebloan architecture of the American Southwest. What would a building look like if you brought them together? Combining these two indigenous architectural styles results in a third style, something “in between.” No matter what, I want to be respectful of the surrounding architecture and cultural tradition, so it [my work] doesn't stand out like a sore thumb and is respectful to the people who live there. You have to create with humility; you don't want to make the giant statement. Instead, you are treading that fine line between doing something new/original/what the client wants and something that doesn't end up being the bad kid at the table. You build a house and it remains there, done and very public.

**4 What is inspiring you right now and what can we expect in the near future?**

I am exploring the notion of combining masonry buildings with framed houses. In my buildings I am trying to incorporate these ideas while bringing something modern to them. I like pushing traditional houses in a more modern, spare direction. Lately, I have been looking at origami and the idea of creating volume through folded planes and angles, in particular, folded planes of cedar shingle. I am fascinated with creating sculpture that walks the line between folded origami paper and something that suggests weight and mass.



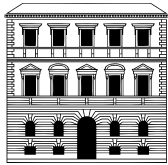

# TRADITIONAL BUILDING CONFERENCE SERIES



We will present the  
2019 Palladio Awards  
at the Boscobel  
Conference.



## MATERIALS & METHODS

### Boscobel House & Gardens Hudson Valley, NY • July 16–17, 2019

Network with award-winning architects & traditionally trained craftspeople

Earn 10+ AIA LUs | Take our walking tours | Eat and Drink Behind the Scenes at Boscobel Mansion

**B**oscobel Mansion stands as a testament to the power and importance of traditional building philosophy and practices. Completed in 1808 as the dream house of wealthy Loyalists, the Neoclassical mansion fell into disrepair in the 1950s and was demolished. Preservationists saved as many architectural fragments as possible and reassembled them fifteen miles north where the structure was restored beyond its original grandeur. Boscobel's interiors display one of the finest collections of New York furniture from the Federal period, including documented examples by America's most celebrated cabinetmaker, Duncan Phyfe. Boscobel's grounds offer spectacular views of the tranquil Hudson Valley.

#### THEMES

- Sustainability
- Resilience
- Project Planning,
- Jefferson's Rotunda
- Masonry

#### Registration Inquiries:

Carolyn Walsh  
cwalsh@aimmedia.com

#### Sponsorship Inquiries:

Jen Baldwin 718.619.7645  
jenbaldwin1@msn.com

#### Education Inquiries:

Judy Hayward 802.674.6752  
jhayward@aimmedia.com

#### Partnership Inquiries:

Griffin Suber 202.262.3401  
GSuber@aimmedia.com

Becky Bernie 978.879.4045

bbernie@aimmedia.com



INSTITUTE OF CLASSICAL  
ARCHITECTURE & ART

AIA  
Continuing  
Education  
Provider

For more information, please visit [traditionalbuildingshow.com](http://traditionalbuildingshow.com)



# Lighting up History

Heritage Metalworks creates chandeliers and sconces to bring Ford's Fair Lane Estate back to its 1919 grandeur.



LEFT The team at Heritage Metalworks used vintage black and white photos, such as this one of the library, to replicate the lighting fixtures at Fair Lane, the Ford estate in Dearborn, Michigan.



ABOVE A replicated wall sconce for the library.

LEFT The replicated library chandelier is solid brass coated with zinc and antiqued.

FAR LEFT The restored library with its chandelier and sconces by Heritage Metalworks.

Photos by John F. Martin Photography

Recreating period lighting fixtures is often part art, part detective work, even when there's a wealth of original information available.

Since 2001, brothers Matt and Jon White, co-owners of Heritage Metalworks, have been honing their sleuthing skills on a variety of high-profile lighting and metalwork projects for the likes of Winterthur, the Smithsonian Institution, and the Chrysler Museum of Art.

Their work for Fair Lane, the Dearborn, Michigan, estate of Ford Motor Co. founder Henry Ford and his wife, Clara, presented new challenges and creative opportunities.

The Henry Ford Estate, the nonprofit in charge of the iconic 1915 property that has been converted into a house museum, commissioned them to recreate chandeliers, sconces, and metal smoke stands as part of an extensive restoration that will return the property to its 1919 grandeur.

The 31,000-square-foot limestone mansion, which is a blend of Midwestern Prairie School and English country manor styles, was one of the first sites to be designated a National Historic Landmark. Designed by architects William H. Van Tine and Joseph Nathaniel French and landscaped by Jens Jensen, it presides over 1,300 wooded acres on

the River Rogue.

The property, named after an area in Cork, Ireland, that was significant to Ford, originally contained an electrical power plant, a greenhouse, a boathouse, riding stables, a children's playhouse, and a treehouse.

Through the decades, the house had deteriorated, and some of the important lighting fixtures in the music room, the library, and the billiard room had gone missing. Their images remained only in a series of professional black-and-white photos that the Fords commissioned to show off the estate when it was new.

"The photos were high-resolution," Matt says, "but these fixtures have a lot

of refined details sculpted into them that could not be seen with clarity. And because of the perspective the photos were taken at, it made it a challenge to figure out the scale. We made an educated guess with the assistance of the photos and actual site measurements, overlaying them to try and zero in on actual scale." Jon added, "Nor could we tell the color of the finishes or whether the patina was polished."

Using the photos, as well as detailed sales receipts, period lighting catalogs, letters, and other correspondence between the Fords and the makers, the artisans at Heritage Metalworks were able to put the pieces



Honest craftsmanship that will  
"WOW" your clients.



Lighting | Hardware  
Gates & Railings | Custom | Restoration

610.518.3999  
hmwpa.com

Proud Licensee of  
WINTERTHUR  



CAST IRON LIGHT POST AND BALUSTRADE, FAIRMOUNT WATERWORKS, PHILADELPHIA, PENNSYLVANIA

**HISTORICAL ARTS & CASTING, INC.**

*Award-winning architectural and ornamental metalwork since 1973*

www.historicalarts.com • 1(800)225-1414

*Gaby's Shoppe*

Manufacturer of Fine Wrought Iron



Our extensive collection ranges from fine hand-finished wrought iron to richly grained stainless steel. Because we manufacture our products right here in the U.S., we are able to offer custom items such as curved bay windows or brackets sized specifically for your application.



View the complete Gaby's Shoppe catalog online: [www.gabys.com](http://www.gabys.com)

1311 Dragon St. • Dallas, Texas 75207 • 1-800-299-4229





**LEFT FROM TOP** In the music room, Heritage Metalworks used the existing chandelier as a guide for the design of the wall sconces

The music room's original chandelier, adorned with red tassels, served as a design guide for the wall sconces reproduced by Heritage Metalworks.

To determine the profile of the wall sconces in the music room, the team at Heritage Metalworks had some of the layers of paint removed from the woodwork, which also was being restored.



**ABOVE** Heritage Metalworks created replica smoke stands for the Field Room and the sun porch.

**LEFT** Heritage Metalworks' new smoke stands feature art-glass ashtrays.



together like a jigsaw puzzle.

"We also comprehensively researched metal finishes and studied fabrication processes from other lighting manufacturers of that period," Matt says. "The rooms were scaled, referencing millwork, molding, plasterwork, and other key elements."

The team, which did the work in its 12,000-square-foot plant in Downingtown, Pennsylvania, then made concept sketches, CAD drawings, 2D cutouts, and printed patterns. 3D mockups recreated the size of the fixtures as well as their refined details.

"We visited the house twice," Matt says. "The second time, we took hand-sketched 2D models and held them up in the middle of the room at the same angle they were in the old photos to make sure

they were the correct size and scale."

The library, where Heritage Metalworks reproduced a pair of two-armed wall sconces and a chandelier, was the more challenging part of the project. It required a lot more guesswork because the fine sculpted details were not clear in the old photos.

Replicating the finish on the fixtures was just as difficult. "From the photos, it looked like shiny satin nickel or pewter, but we'll never know for sure," Jon says.

Pieces of the chandelier, which is 29-inches high and nearly 34-inches wide, and matching wall sconces were cast in brass using the "lost-wax" process to pick up the refined period details. The brass was then plated with zinc and antiqued.

The eight, three-armed scones in the music room were the most straightforward part of the project, simply because there were existing chandeliers to copy.

"It took us 80 to 90 hours just to figure out the size," Matt says. "And production took about four months."

Each sconce Heritage Metalworks designed was 26-inches high, 15-inches deep, and 25-inches wide. The back plate was hand-sculpted for a pattern and molded. The arm, bobèche, and candle cup were molded from the original chandelier, with changes to the arm pattern to fit the size of the sconces. The parts were cold cast in resin and faux painted with several layers by hand, with different techniques, to look like mahogany with 24-karat gold-leaf accents.

"We used resin instead of hand-carved wood to keep costs down," Matt says. "But the resin still allowed us to pick up the details of the wood texture to maintain the authenticity of appearance."

"We asked the conservators working on the woodwork in the room of the estate to carefully scrape off some of the top layers of the old paint to help reveal the shadow created by the back plate of the original sconce," Matt says. "That really helped us get the size and shape accurate."

Heritage Metalworks also replicated three 32-inch-high, hand-forged smoke stands for the Field Room and sun

porch. "They were formed using metal spinning then shaped to create a scalloped look," Matt says. "They were fabricated to scale and finished with dark wax, a finish common to the period."

The team is also creating lighting for the billiard room, floor lamps for the library, and wall lighting for the interior room that used to house an in-ground swimming pool.

"The chandelier in the billiard room is by far the most challenging, with very complex details," Matt says. "We have four photos taken at different angles, and we always see something that's not jiving with one photo to the other. It's like a dance of one or the other. The fixture looks to be more than twice as long as the width, so we're constantly seeing conflicts when determining the scale."

Jon says Fair Lane is a "unique project because of the depth of what we have to accomplish with so little information."

The Whites are eager to see the completed rooms gloriously and fully illuminated as they were when the Fords called Fair Lane home.

The fate of the original fixtures has been buried by time, but Matt and Jon hope the publicity surrounding the public reopening of the estate next year brings them to light again.

"They are not the kind of fixtures that would have been thrown away," Matt says. "If an original pops up, we'd like to see it to see how close we were to getting it right."





[www.phelpscompany.com](http://www.phelpscompany.com)



# PACIFIC REGISTER COMPANY

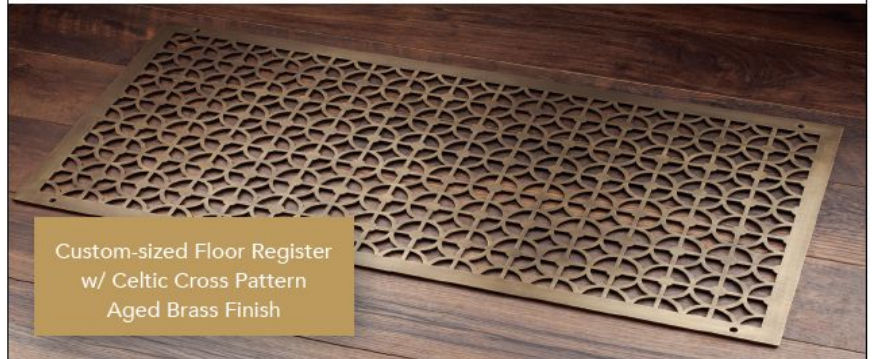

Custom-sized Floor Register  
w/ Celtic Cross Pattern  
Aged Brass Finish

The leading manufacturer of decorative registers, grilles and vent covers.

*Our uniquely crafted products are designed to give a home or commercial space the style, beauty and character you are looking for.*

Low in price and high in quality • All Proudly made in the USA  
Sold direct to the end user. We are NOT a reseller and do not sell to resellers.



BRASS REGISTERS, POLISHED FINISH

[www.pacificregisterco.com](http://www.pacificregisterco.com)

(844) 487-7500 info@pacificregisterco.com

## Vintage Hardware & Lighting



2000 West Sims Way, Port Townsend  
WA., 98368 360-379-9030  
[www.vintagehardware.com](http://www.vintagehardware.com)



# Bronze Age

Bronze has been used as ornament for centuries in our built environment.



The Father Time clock, circa 1926. Originally gilded, it was a gift from the Elgin Watch Company, which had offices in the Jeweler's Building.

Chris Stansfield photo

The Bronze Age (C. 5000 to 1100 BC) was defined by the production of bronze by smelting, which combined copper with tin. Bronze was much harder than earlier metals, and its durability is evident in the multitude of bronze artifacts that have endured. While other metal tools were fabricated prior to bronze, they were formed of single metals. Bronze required not only the mining of copper but also trade for tin, which was not available in the same geographic region. It also required separate smelting, and craftsmen who could combine the materials in the right way, at the right temperatures, and form the tools.

Today, bronze is popularly used in sculptures for its excellent casting qualities. In architecture, it can be regularly found in hardware, doors, entrances, fountains, handrails, column

cladding, and architectural details such as plaques, medallions, and panels.

## HISTORY

Bronze artifacts dating back to 5 millennia BC are termed “Alpha Bronze,” since they were produced with ore that naturally contained copper and tin together. Where tin and copper did not naturally occur, bronze was first made by mixing copper with arsenic to get its hardness, but this process created a toxic off-gas. Tin replaced arsenic around 3500 BC, in the height of the Bronze Age, with the transportation and trading of tin in regions without naturally occurring combination ore, making the bronze stronger and easier to cast. The Iron Age followed when iron was combined with carbon to make steel, which was stronger and could hold an edge better. Bronze continued to be used for cast ob-

jects and was prized for objects which were exposed to moisture due to its resistance to corrosion, especially salt water, such as propellers, cannons for ships, and public sculptures.

## BRASS VERSUS BRONZE

There are many alloys that are termed bronze, depending on its combination of metals. In rough terms, bronze typically contains 95% copper and 5% tin, while brass is a mixture of 65-85% copper and 15-35% zinc. Visual observation is not definitive as to whether an object is brass or bronze.

Bell Bronze is a type that has an ideal balance of strength for striking, while having the softness to provide a melodious tone, and ease of casting. For example, the Liberty Bell has a recipe of 70% copper and 25-30% tin.

Statuary bronze consists of 97% cop-

per, 2% tin, and 1% zinc, giving it good casting qualities and fine grain.

Phosphor bronzes are formulated for low brittleness and high strength, ductility, and resistance to wear. They are typically used for gears, pistons, propellers, shafts, and the like.

Silicon bronzes are about 98% copper and 2% silicon, which gives good corrosion resistance while providing good casting, rolling, spinning, and pressing capabilities.

Technically, what is known as architectural bronze with 57% copper, 40% zinc, and 3% lead constitutes a brass.

Nickel silver is sometimes considered a bronze but is not. Its name is a misnomer since it contains no silver at all, consisting of a mix of 70% copper and 30% nickel. This provides excellent corrosion resistance, is used extensively for marine tubing and condensers, architectural decoration and ornamental grilles, and smaller castings.

Lastly, a “bronze” named Monel is a mix of about 70% nickel and 30% copper, resembling stainless steel. Over time, it is possible that the copper will oxidize somewhat, rendering a greenish cast.

## CAUSES OF FAILURE

**Corrosion:** Bronze will corrode when exposed to acid rain and air pollution. This corrosion from the exposure to oxygen and sulfur in the atmosphere forms a patina on the surface that partially prevents further corrosion. This patina starts with brown copper oxide, evolves to a blackish color as it forms copper sulfide, and finally takes on the familiar blue-green of copper carbonate. This is an aesthetic symptom that does not require action.

Where ongoing acid rain dissolves part of the copper carbonate, it can result in green staining on surfaces below the patina from solubilized copper depositing. Where acid rain is persistent, or a large amount of bird droppings accumulate, it may remove the surface of the bronze. Unpatinated areas can develop carbon-rich black deposits, creating protected cathodes, while areas of green



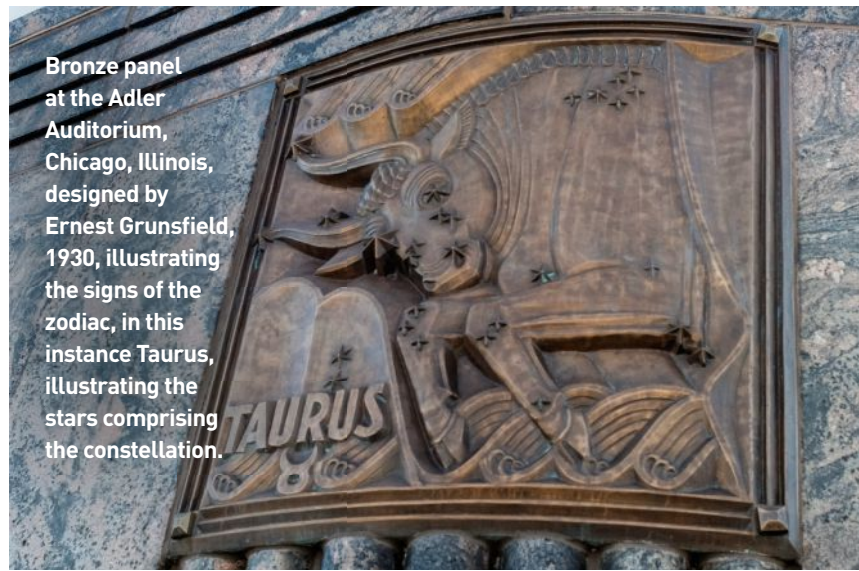

Bronze panel at the Adler Auditorium, Chicago, Illinois, designed by Ernest Grunsfeld, 1930, illustrating the signs of the zodiac, in this instance Taurus, illustrating the stars comprising the constellation.



Crane Girl, one of four fountains by Leonard Crunelle cast in 1910 of statuary bronze, located in Grant Park, Chicago, Illinois.

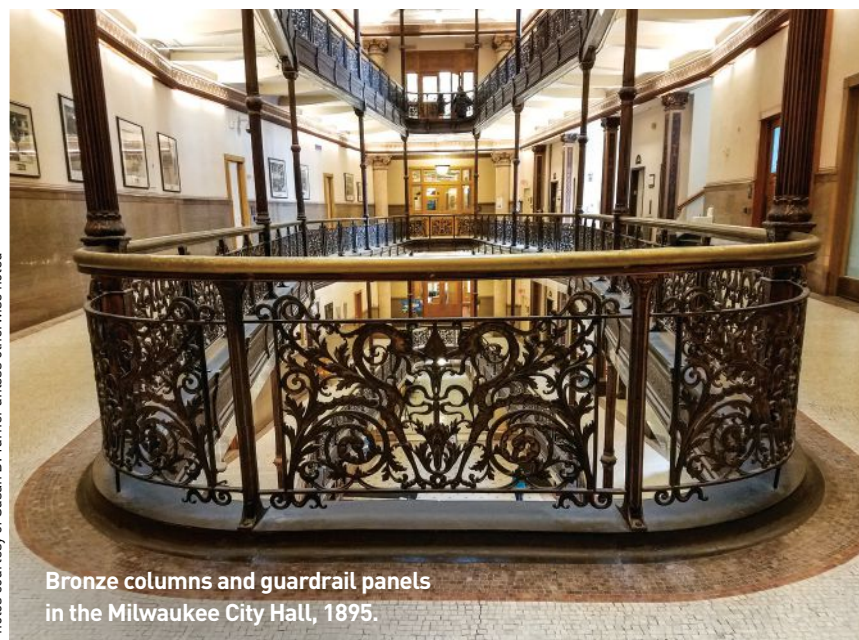

Bronze columns and guardrail panels in the Milwaukee City Hall, 1895.

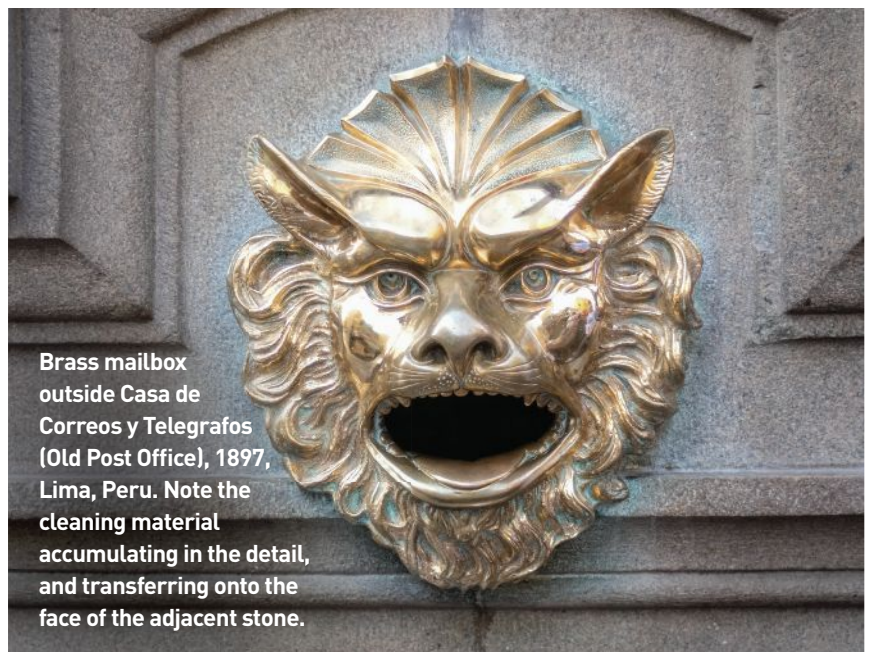

Brass mailbox outside Casa de Correos y Telegrafos (Old Post Office), 1897, Lima, Peru. Note the cleaning material accumulating in the detail, and transferring onto the face of the adjacent stone.

Photos courtesy of Susan D. Turner unless otherwise noted

copper carbonate act as anodes. This sets up an electrochemical condition in which deep pitting can occur. These pits further retain deposits of chlorides, which cyclically increases corrosion without the intervention of thorough cleaning.

**Abrasion:** As hard as they are, bronzes can wear away through handling, such as parts of this statue, where people handle it or sit on it.

**Cracking:** Bronze castings can include inherent flaws due to inconsistencies in the mold material, the molten bronze being too hot or including air pockets, or flaws in the crystal structure developed in the cooling process. These weak spots permit fractures to occur with the stresses of movement and temperature.

Where statues are reinforced with an armature of a dissimilar metal, or pinned with dissimilar materials, galvanic action occurs, caused by moisture transmission of electrons from the more noble metal to the less noble metal. Further, if liquid water is present, a gray-white sulfate crust could form on the surface. If

fastening pins are ferrous, when they are exposed to moisture and corrode, they expand and minimally will cause rust staining on the surface, if not crack the bronze in that location.

With such constructions, sometimes the armature is insufficiently designed to support its own weight, or to resist wind and snow loads, resulting in sagging or cracking.

Sometimes bronze fabrications are not designed to shed water. When water is trapped in cold climates, it freezes, expands, and pushes apart the bronze, sometimes cracking it.

Lastly, the piece may not have been designed to accommodate the expansion and contraction of the bronze with the climate in which it was placed, resulting in cracking.

## REPAIRS

**Cleaning corrosion:** Cleaning bronze requires the mildest methods possible. Before commencing, determine if cleaning is absolutely necessary. Assess whether not cleaning the bronze will cause further damage. Identify any cor-

rosion products on the surface, and what causes them. Remove the source of corrosion before commencing any cleaning. Determine what the original finish was: was it intended to have patina? Was it originally coated?

Sandblasting, steel wire brushes, or steel wool are inappropriately strong to clean bronze and will leave it pocked and scratched, with irreparable damage to the finish. Further, steel can leave micro deposits of iron, which will cause rust staining over time.

If cleaning is the course of action decided upon, begin with clean water, or de-ionized water, and a soft natural-

bristle brush. If a greasy crust has deposited from exhaust and wind-blown dirt, use a non-ionic detergent, possibly combined with the use of an organic detergent.

Where localized areas of chlorides remain, targeted applications of low-pressure micro-abrasive cleaning can be used, or poultices. Where such means are beyond the budget, bronze wool may be used by hand, using water or oil as a lubricant.

Once cleaned, protective coatings of wax, lacquer, or oil can be used. Where the sculpture has ongoing exposure to the elements, oil is not recommended



Overall view of La Guerra Del Pacifico memorial (War of the Pacific) in Iquitos in statuary bronze.

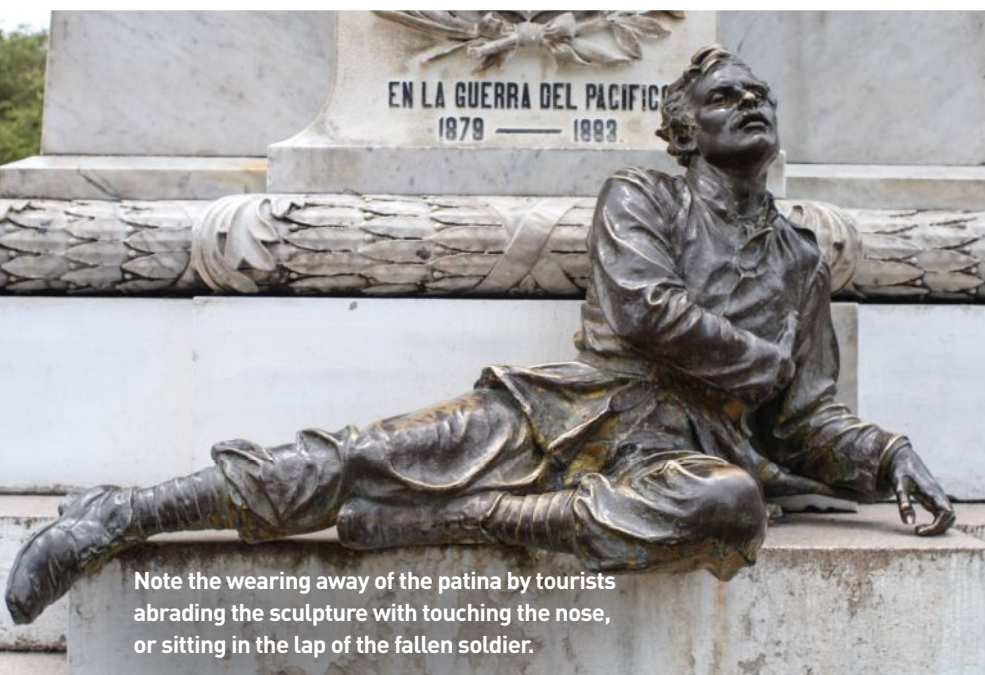

Note the wearing away of the patina by tourists abrading the sculpture with touching the nose, or sitting in the lap of the fallen soldier.

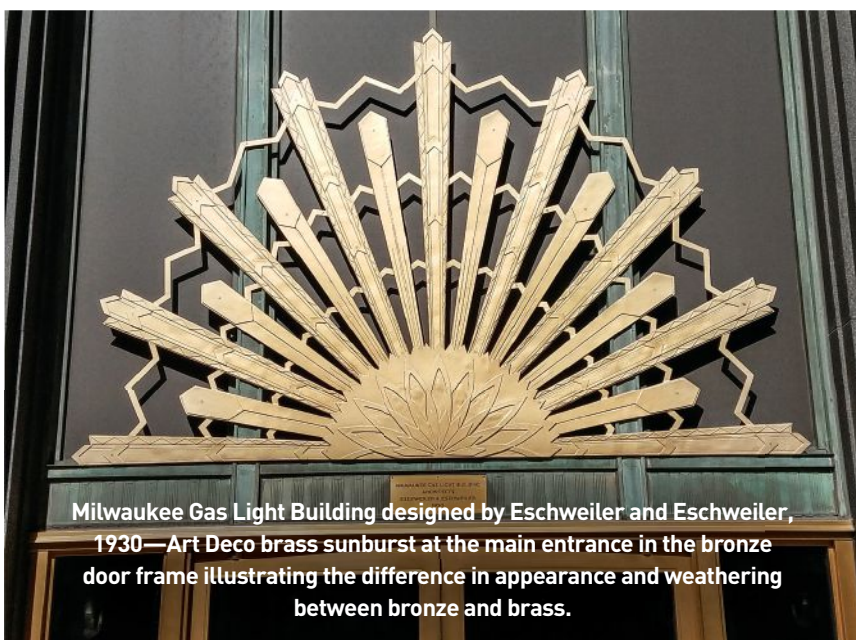

Milwaukee Gas Light Building designed by Eschweiler and Eschweiler, 1930—Art Deco brass sunburst at the main entrance in the bronze door frame illustrating the difference in appearance and weathering between bronze and brass.

as it will attract further dirt. Bronzes that experience high handling can be protected with a mixture of 5 ounces of lemon or lemongrass oil mixed with a gallon of high flash point (> 350 degrees) paraffin oil, reapplied on a weekly basis. Alternately, the British recipe is 40% lanolin, 7% paraffin wax, and 51% “white spirit” (turpentine) wherein the turpentine acts to remove the previous coat, and the oil installs a clean wear coat with corrosion resistance. Depending on the level of handling, this can be reapplied, monthly, tri-monthly, but never less than annually. Oil coatings should not be used if appropriately timed ongoing maintenance is not implemented.

Waxes are used for areas where handling can cause localized removal of the patina. When applied directly to bronze, Carnuba wax mixed with synthetic microcrystalline wax creates a higher melting point. This point is important to prevent waxes melting in hot weather; the same wax must be able to perform well at low temperatures without crazing. Cold wax is applied to a heated bronze with a bristle brush with a stippling motion. Waxes can be locally re-applied in areas with localized abrasion, without the removal of the entire coating. Only Carnuba and Brazil wax should be used in their straight formulas since other types can cause acidic reactions on the bronze.

If a stronger protective coating is required, a lacquer called Inctalac, formulated by the International Copper Association, can be used, but it is very odorous in its application, and requires several coats. Inctalac only lasts one to four years, depending on the level of pollution to which it is exposed. To improve the longevity of the lacquer, a coating of cold wax is applied cold with a stiff-bristle brush.

**Repairing cracking:** When bronze castings are hollow or permitting water to collect, proper drainage should be provided by the drilling of small holes in discreet locations. If the formation of ice by this collected water has caused splits in the bronze, they can be cold patched by the use of cored holes and threaded bronze rod. Once installed, the rod is cut off, and the exposed end finished to match the adjacent surface. Where an extensive split occurs, it should be enlarged to a regular shape to take a coupon, with the edges dressed to permit peening of the perimeter for a mechanical keying of the patch.

If the cause of the split is an issue with materials, such as dirt or plaster, which have collected internally and require removal, a hole can be drilled to permit the use of a bent hook on a drill

inserted into a split or a hole, to rout out the extraneous material. If, however, the split is caused by corrosion or expansion of the armature, then the armature must be removed. This can mean major surgery, involving the disassembly or cutting of the bronze, repair or replacement of the armature with non-corroding material, and reinstallation of the bronze using brazing of the joints.

## CAUTIONS

Epoxy resins or acrylics should never be used to coat bronze. Over time, they will be damaged by environmental conditions and thermal movement, resulting in fissures that trap acid rain. These pockets will expand, causing an unacceptable appearance. The gentlest means to remove these coatings is a micro-abrasive treatment, such as the use of crushed walnut shells, but this will still remove historic material.

When repairing bronzes with new material, it is essential to determine the exact alloy composition, to ensure that no galvanic action can occur between old and new. (To further the surgery analogy, think of it like tissue matching.) Even when the exact composition is noted on historical records, an SEM test (Scanning Electron Microscope) should be used to confirm the exact composition that was actually used.

None of this work should be undertaken by anyone other than craftspeople who have suitable training and experience to effect repairs without damage. Bronze is actually quite soft, and damage to it is permanent. Even if damage is buffed out, or a bad coating removed, it still involves the loss of historic material.

## References:

*Metals in America's Historic Buildings*, US Department of the Interior, National Park Service, Cultural Resources Preservation Assistance, Washington D.C. © 1980 Margo Gayle and John White

*Conserving Buildings Guide to Techniques and Materials* by Martin E. Weaver with F.G.Matero © 1993 John Wiley and Sons

*The Beginnings of Bronze* ©2019 Copper Development Association (Available online)

*How to Repair Antique Bronze Statue* by Lakeside Pottery Restoration Studio (Available online)

**SUSAN TURNER** is a Canadian architect specializing in historic preservation of national registered buildings. She is the Director of Architecture for The Tradesmen Group, a restoration contractor specializing in the repair and preservation of historic buildings. She can be reached at [sturner@tradesmengroup.com](mailto:sturner@tradesmengroup.com)



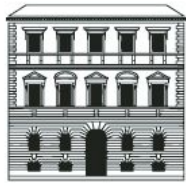

# TRADITIONAL BUILDING CONFERENCE SERIES

## 2019 PLATINUM SPONSORS

ALLIED WINDOW, INC.

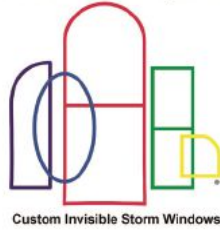

Custom Invisible Storm Windows



## SILVER SPONSOR CRITTALL WINDOWS

### BRONZE SPONSORS

HADDONSTONE  
OLD WORLD STONE  
INNERGLASS

VINTAGE MILLWORK AND RESTORATION  
MON RAY

HERITAGE METALWORKS  
CONNOR MILL BUILT HOMES  
KUIKEN BROTHERS COMPANY INC.  
D.C. MITCHELL

### YOUR PARTNERS IN EDUCATION

*The technical representatives of our sponsors provide unique knowledge and expert solutions. These suppliers are dedicated to serving the historic restoration, renovation, and traditional building industry. Earn AIA continuing education credits, as well as credits for NARI, AIBD, and some NAHB certifications.*

wikimedia.com/Zeete photo

BOSCOBEL  
HOUSE &  
GARDENS

To become a  
Traditional Building  
Conference sponsor,  
contact  
Jennifer Baldwin at  
jenbaldwin1@msn.com  
or 718-619-7645



# The George Peabody Library Skylight

A light approach to reinforcing heavy metal.

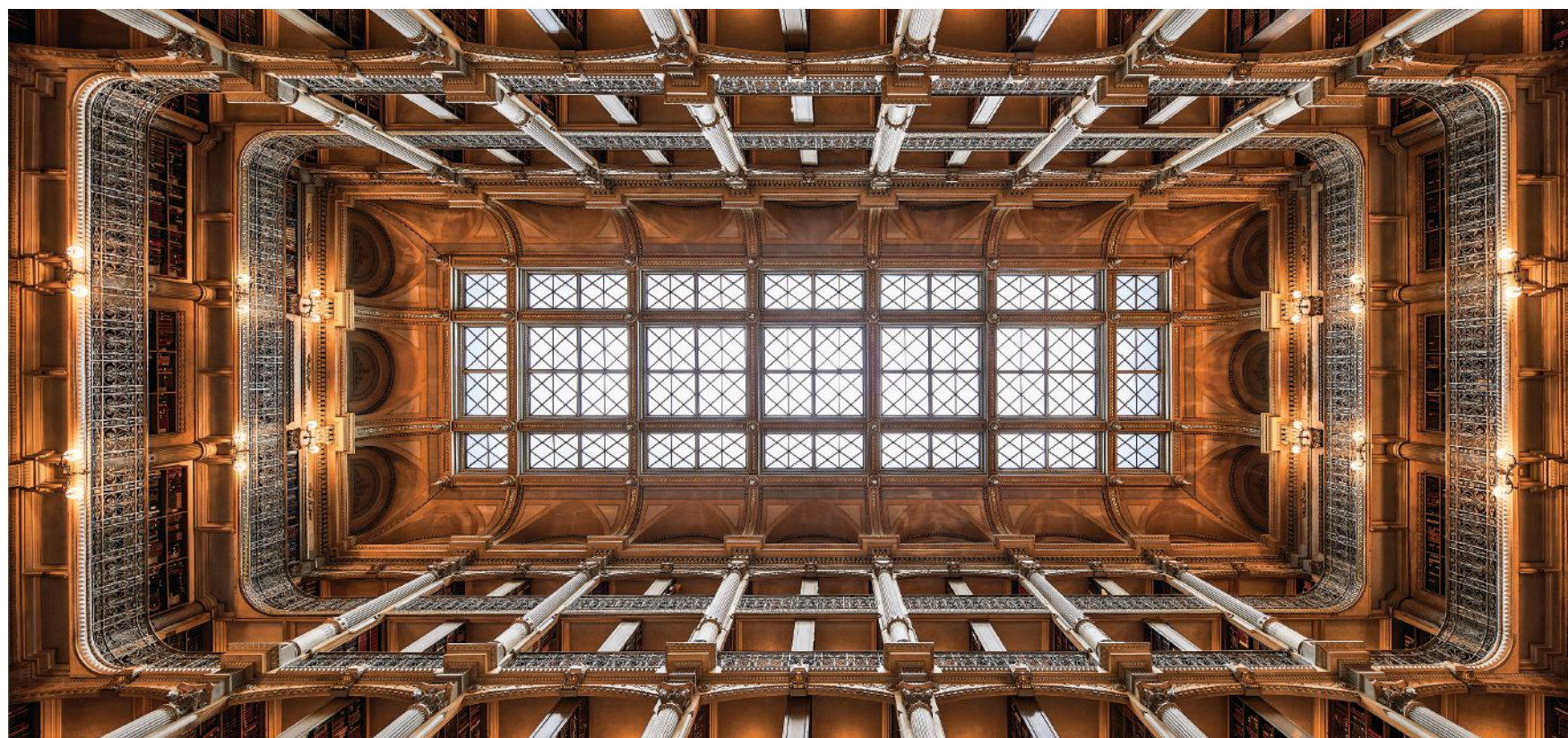

Photo by Ulf Wallin

Considered to be one of the most beautiful libraries in the world, the George Peabody Library at Johns Hopkins University in Baltimore houses 300,000 rare and historic volumes. The structure, fittingly described as a “cathedral of books,” features five stories of ornamental cast-iron balconies surrounding a 61-foot-high atrium flooded with natural light. Rising from its black-and-white marble floor to a massive glass laylight and decorative ceiling, the library is stunning to behold. Behind the scenes, writes Jessica Adler in *JHU Engineering* magazine, a complex network of iron trusses above the laylight—virtually invisible to visitors below—spans the library space and supports a massive skylight above.”

When it was built in 1878 under the direction of architect Edmund G. Lind

(1829-1909), this then state-of-the-art building relied on regionally made, pre-fabricated cast iron for architectural ornament and columns and on wrought-iron trusses for structural fortitude and fire resistance. Bartlett-Robbins and Company fabricated the Neo-classical designs in cast iron, while the original iron trusses were made at the Phoenix Iron Works. Its original glass skylight had been replaced at some point with plastic (polycarbonate) panels that later failed.

## ASSESSING THE STRUCTURE AND CONSTRUCTION CHALLENGES

The polycarbonate panels began to lift in high wind. To protect one of the world’s most important collections of 19th-century volumes, a permanent fix was needed. Johns Hopkins sug-

gested replacing the failed panels with insulated glass as a long-term solution for use on the skylight and to improve its thermal efficiency. It was imperative to safeguard the building’s historic fabric as well as the rare books. There were concerns about the structural safety of using insulated glass, which would potentially weigh more than the cast- and wrought-iron structure could support. Further, the size of a structural reinforcement had to be considered, as a larger frame risked diminishing the quality and amount of light admitted by the skylight and laylight. The skylight measures 25 x 75 feet for a total of 1,875 square feet.

Johns Hopkins commissioned 1200 Architectural Engineers, a firm based in Alexandria, Virginia, to perform a structural analysis and feasibility study. Ac-

cording to company partner John Matteo, PE, FAAR, during their investigation it became apparent that the building was well-built and efficient when it was constructed in the 19th century, and it had an engineering system of trusses that was worth protecting. As such, they did not want to weld or drill into the historic iron frame. Designing the construction sequence would be just as important as finding the right solution for strengthening the trusses.

With these concerns in mind, Johns Hopkins turned to Ziger|Snead Architects, in Baltimore, noted historic preservationists. Firm principal, Steve Ziger, FAIA, and project architect Dan Carter understood the importance of keeping the rehabilitation “light handed.” Architect, engineer, and contractor partnered together to devise a means of



Drawing: MCC 1200 Architectural Engineers, PLLC

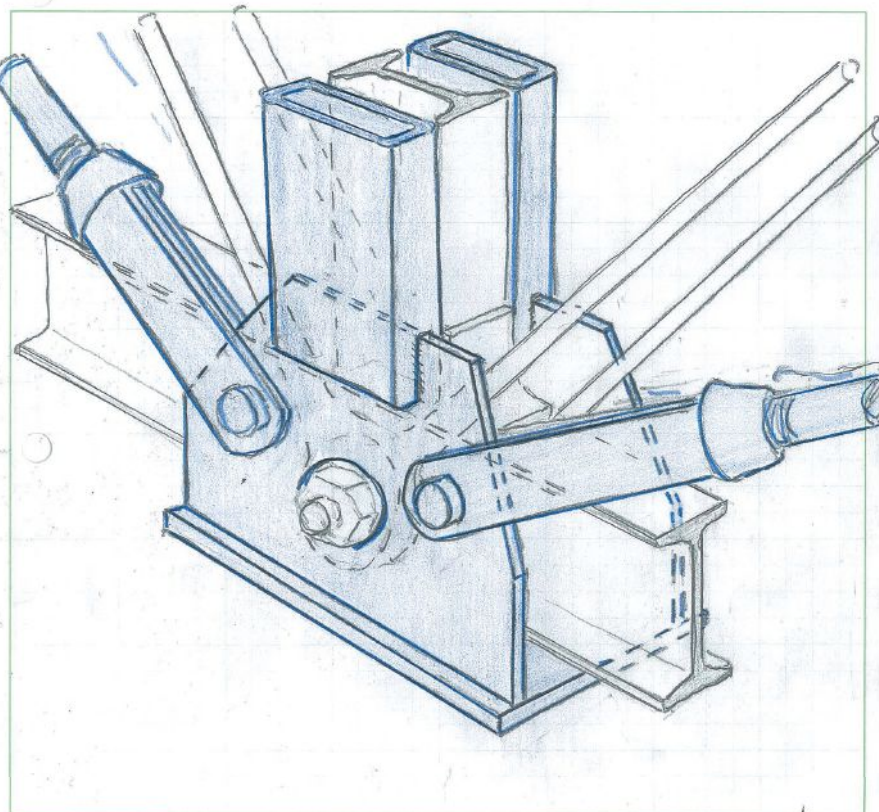

Photo by 1200AE

**LEFT** Compare this construction drawing of the steel “saddle” to the photo to understand the reversibility of this design.

**BELOW** Steel now cradles the historic iron truss providing the capacity to support insulated glass and meet codes for wind, snow, and uneven snow loads.



Photo by 1200AE

strengthening the truss system, protecting its historic fabric, and maintaining the distinctive ambience created by the skylight and laylight—all while keeping the library open to patrons during the construction process.

### ENGINEERING A REVERSIBLE SOLUTION

Key to the discussions and analysis

among client, architect, engineer, and contractor was the principle of reversibility. Conservators and preservationists seek to intervene in ways that allow the construction history of the building to remain interpretable for future generations. John Matteo reiterated that, “whenever possible, repairs should be done in such a way that they can be altered at a later date, assuming that

future changes and associated interventions will be possible while leaving the original historic fabric intact.”

Nevertheless, the building finds itself in the 21st century where, in addition to needing to support increased loads from a heavier, insulated glass skylight and the introduction of new catwalks, our understanding of the environmental demands from wind,

snow, and unbalanced snow loads has increased well beyond that from the time of original construction. John Matteo explains that they used a combination of traditional hand calculations and finite element computer analysis to both evaluate the changing impact on the historic trusses and to design the new reinforcement system. Steve Ziger explains the historic truss system has its



**BELOW** Installation of the construction debris netting was the first step in the construction sequence.

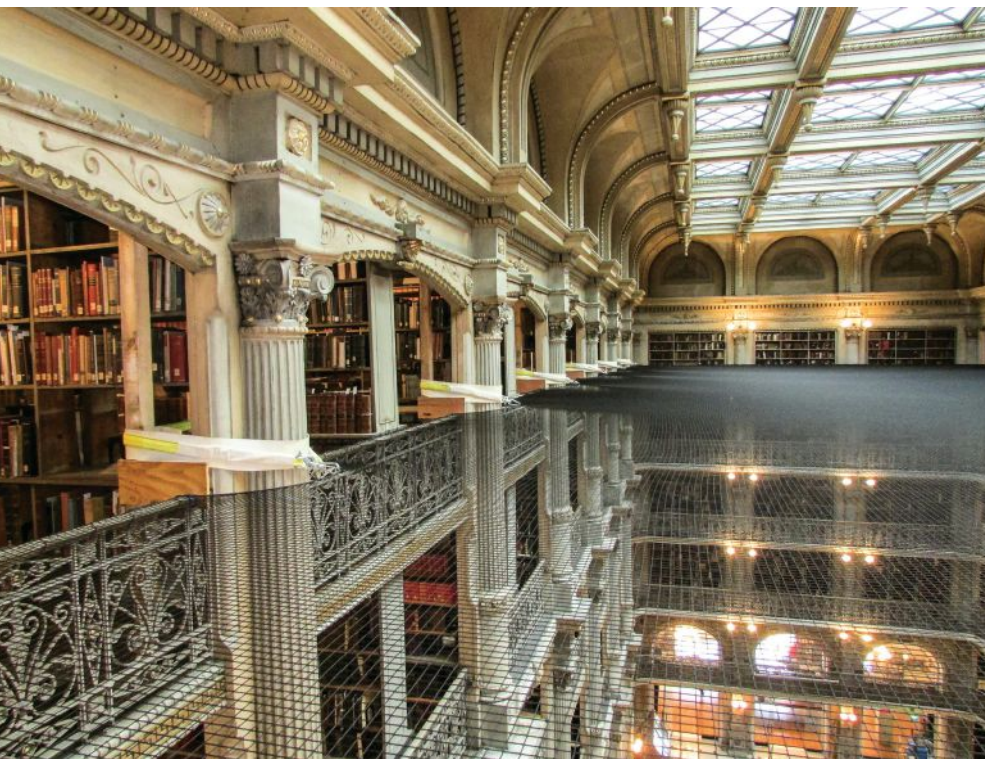

Photo by 1200AE

To see the atrium, check the hours of the George Peabody Library at [peabodyevents.library.jhu.edu/about-the-library/](http://peabodyevents.library.jhu.edu/about-the-library/)

And if you are in Baltimore, the rooftop bar at the nearby Hotel Revival has a great view of the exterior skylight.

own beauty as well as function; as the analysis and consideration of solutions progressed, “they felt like they were reaching across history” from the 21st to the 19th centuries to arrive at the right solution. There was a lot of back and forth discussions in a process that played out over two years from inception to project completion. Ultimately, Matteo says, “the team designed a pair of inverted triangular trusses, set alongside the existing framework, with diagonal tie rods or stays to a new steel saddle that cradles the historic iron truss at mid-span. The tension in the stays would be resisted by the horizontal compression strut at the top of the new truss. Ultimately, the new and existing loads continue to be supported by the original cast iron columns.” The work sandwiched the historic iron trusses with compression-fit, steel bolts and plates. The reinforcement is completely reversible.

### THE CONSTRUCTION SEQUENCE

Establishing a viable construction sequence was critical to the safety of the library and its occupants because of the weight of the steel and glass, the protection of the historic books, and

**RIGHT** It is easy to understand why The George Peabody Library has earned its title, “The Cathedral of Books.”

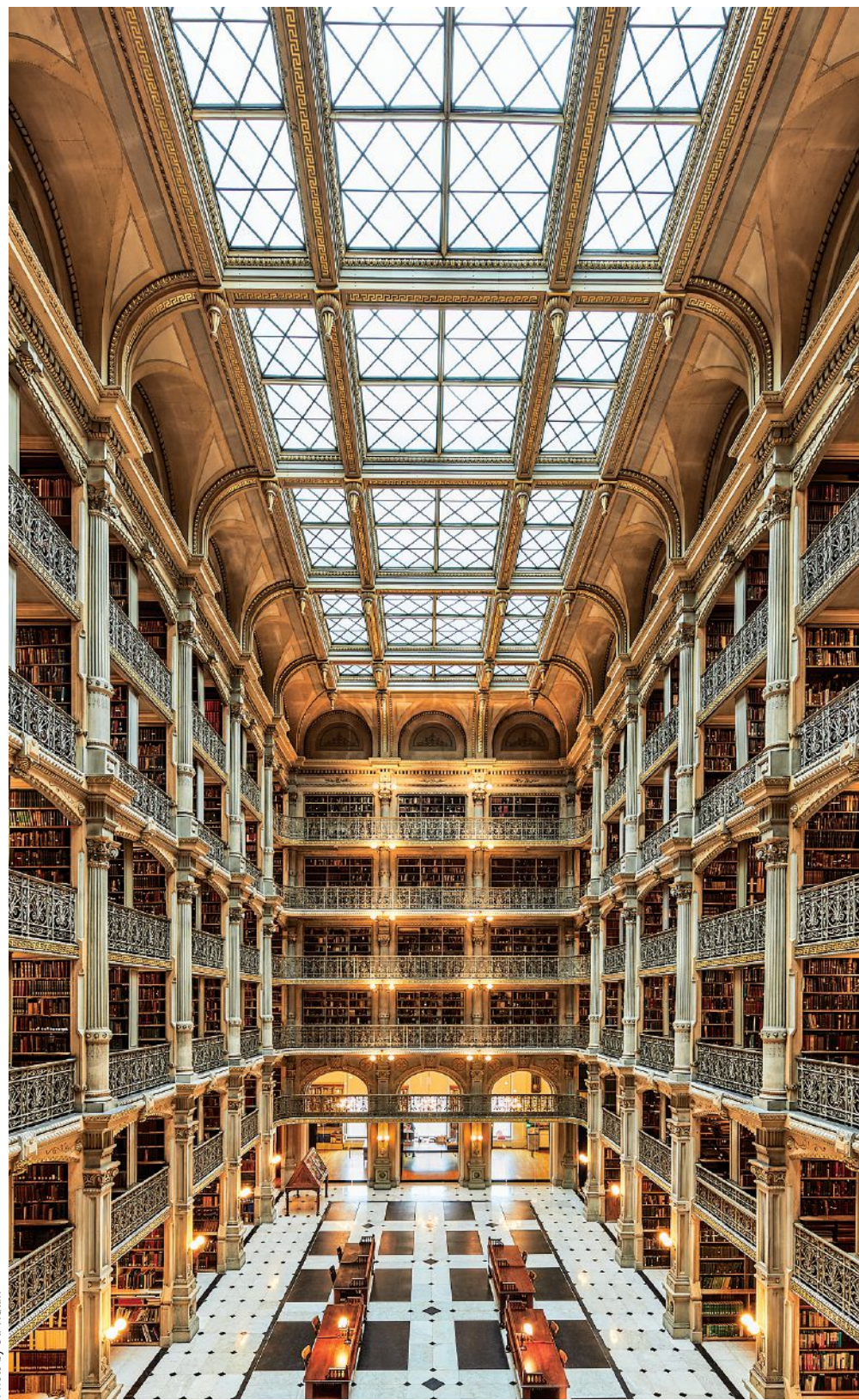

Photo by Ulf Wallin

the limited space available for access and storage of building materials during the process. Matteo noted, “To accommodate the need to deliver materials through an occupied building and the challenge of installation within the geometric constraints of the attic space, strengthening components were limited in size to no more than 8 feet in length.”

First in the construction sequence was the installation of debris netting. The next step involved building catwalks for the truss reinforcement, infrastructure that would stay in place for later mechanical and skylight maintenance. Work platforms were installed sequentially, to limit construction phase loadings on the historic structure, while the reinforcement work is installed one truss at a time. The project finished with the installation of the new insulated glass panels.

Both Matteo and Ziger credit the contractor, Rockville, Maryland-based Grunley, with helping strategize the construction sequencing and planning for the demands of the project’s means and methods.

### RECOGNITION OF THE PROJECT

Baltimore Heritage took notice of

this project’s important preservation work; on June 13, 2019, the project will receive a Preservation Project Award. Johns W. Hopkins, executive director of Baltimore Heritage, said of the award-winning project, “The Peabody Library is one of the most extraordinary historic interior spaces in the country, and the restoration of the central skylight does the library justice. No simple pop-on transparent dome here. Behind the gorgeous refurbished skylight lies a structural steel framework that is engineered with precision and is as meticulous and well executed as the glass itself.”

**JUDY L. HAYWARD** is executive director of Historic Windsor, Inc. and the Preservation Education Institute. She serves as education director for the Traditional Building Conferences Series and Online Education Program. She blogs and writes this **Techniques** column regularly for **Traditional Building**. She specializes in the development of educational programs for builders, architects and tradespeople. She can be reached at [jhayward@aim-media.com](mailto:jhayward@aim-media.com) or 802.674.6752.



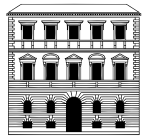

# TRADITIONAL BUILDING CONFERENCE

ONLINE EDUCATION

FOR CLASS DESCRIPTIONS,  
MORE INFORMATION  
OR TO REGISTER, VISIT  
**TRADITIONAL  
BUILDING  
SHOW.COM**

@TradBldgShow

**9+ AIA CREDITS  
FREE FOR  
THE TAKING** AIA  
Continuing  
Education  
Provider

## TRADITIONAL TECHNIQUES, ADVANCED EDUCATION

**LIVE TUESDAY, JUNE 25, 2PM ET**  
**ON-DEMAND VERSION TO FOLLOW**

**WINDOWS AND HISTORIC HOMES:  
REPAIR, REPLACE AND NEW ADDITIONS**  
*1 AIA HSW Learning Unit*

**Speaker:**

Charles "Chick" McBrien,  
Marvin Windows and Doors



**SAVE THE DATES**  
**FUTURE LIVE WEBINARS**

**FINISHING METAL**  
TUESDAY, SEP. 10, 2019, 2PM ET

**GLASS & SAFETY**  
WEDNESDAY, NOV. 13, 2019, 2PM ET  
**ON-DEMAND VERSIONS TO FOLLOW**

Visit [traditionalbuildingshow.com](http://traditionalbuildingshow.com)  
for more webinar topics  
to be announced

**ON DEMAND**

**DESIGNING SECURITY AND SWING:  
LOCKS, HINGES AND THEIR APPLICATIONS**  
*1 AIA HSW Learning Unit; .1 IDCEC CEU*

**Speaker:** Betsy O'Day,  
Business Development Manager,  
Nostalgic Warehouse



**ON DEMAND**

**AN INTRODUCTION TO ORNAMENTAL  
METALS, DISTANCE EDUCATION VERSION**  
*1 AIA HSW Learning Unit*

**Speaker:** Douglas Bracken,  
Wiemann Metalcraft



**ON DEMAND**

**THE PRESERVATION-MINDED  
HOMEOWNER IN THE 21ST CENTURY**  
*1 AIA Learning Unit*

**Speaker:** Scott Intagliata, Chief  
Marketing Officer, The Unico System



**ON DEMAND**

**STORM WINDOWS 2.0: FORM,  
FUNCTION AND FIT**  
*1 AIA HSW Learning Unit*

**Speaker:**  
David Martin, President, Allied Window



**ON DEMAND**

**PAST, PRESENT AND FUTURE USES  
OF EXTERIOR SHUTTERS**  
*1 AIA HSW Learning Unit*

**Speaker:** Harry Rembert, Vice President,  
New Horizon Shutters



**ON DEMAND**

**TERRA COTTA TILE:  
COLOR SELECTION AND MATCHING**  
*1 AIA HSW Learning Unit*

**Speaker:** Alicia Cordle,  
Ceramic Engineer, Ludowici



**ON DEMAND**

**TRADITIONAL DOORS: A MASTER CLASS  
ON CRAFT, FORM, AND FUNCTION**  
*1.25 AIA HSW Learning Unit*

**Speaker:** Brent Hull, Hull Historical, Inc.

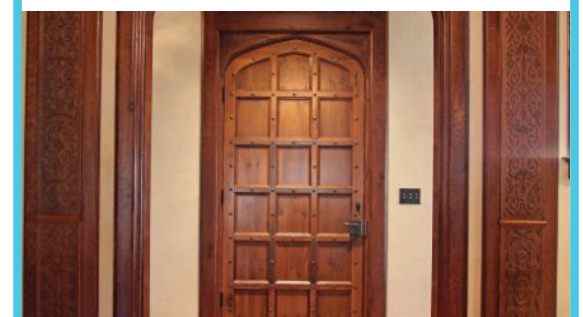



# Treasure Hunt

Architectural salvage continues to provide patina in new projects.



**ABOVE LEFT** Eron Johnson of Eron Johnson Antiques in Denver sells pieces from the 17th century to Mid-Century Modern.

**ABOVE RIGHT** Pieces range from ornate 19th-century doors to antique lanterns.

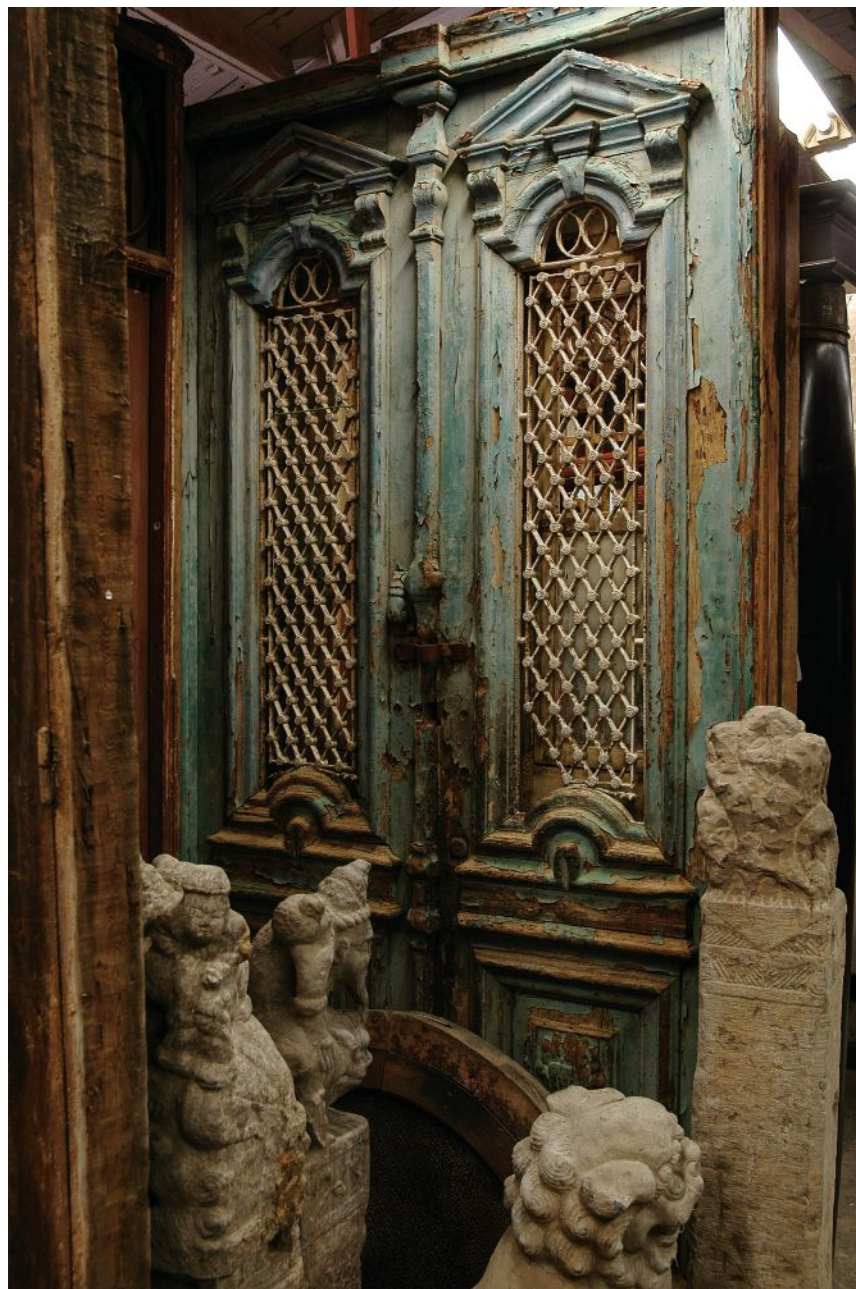

Photos by Eron Johnson Antiques unless otherwise noted; OPPOSITE: Photo by Pete Eklund of Eklund Photography

**W**e tend to think of architectural salvage as dismembered building parts—from simple wood beams to highly carved mantels—being recycled out of worn-out, inner-city buildings, often on the East Coast, but that ain't necessarily so. For a surprisingly different perspective, we talked with Eron Johnson of Eron Johnson Antiques in Denver who, over five decades has built a thriving business in antiques and architectural

salvage from the 17th century to Mid-Century Modern that reaches far west of the Mississippi to many parts the globe.

“I’ve always found that items from around the world sold better than local stuff,” explains Johnson. Historically, Denver had a lot of fairly simple structures, he says, and in the 1980s and ’90s, when people were restoring the nicer Victorian houses, he realized they would buy some local items, but also

a few imported things. “In the 1970s, I used to do local demolition and pull out pieces, but there got to be so little of interest, I started to go across the country in my van and buy—especially St. Louis, Chicago, Milwaukee, and even Pennsylvania.”

All that changed when Johnson discovered European architectural salvage sales, first in the Midwest, then salvage auctions right in Denver. “These were basically lots of what are called



consumer goods—which is the low-end stuff—just loaded in a container and shipped over here. The sellers took what they could get, but they made a lot of money.” Johnson was impressed. He recalls thinking, I want to go over and see what’s really there for myself. When he did get a first-hand look at the “actual history and amazing buildings” across the pond, he says, “Boy, what an eye-opener!” So, he started importing, mainly out of England and France, with a little bit from Spain. “That really gave us a boost because it was more decorative, and it just didn’t look like the normal, run-of-the-mill stock from Denver.”

Johnson says that Denver, being basically a small city, was not that big of a market, so he had to create his own. “I went out and did shows with designers and writers, had stories in *Architectural Digest* and local magazines, and generated a lot of word-of-mouth. Today that’s kind of dried up—except for the internet which, with all the recommendations, has really replaced word-of-mouth.”

Johnson has long had a keen finger on the pulse of the salvage industry. “I was one of the very first antiques businesses on the internet, and while we also did antiques shows, we sold a lot online.” When the internet first started pulling, he recalls, people would look online and then come into the store. “Now we sell all over the world on the internet, and I’ve never met half of my best customers (yet).”

Recently, he says, he sold an important chair by the architect Le Corbusier to someone in Germany. “In the old days, people would come into the store and you would kind of know what interested them. Today, you never know who’s looking; you just get paid for something—and that’s cool too.”

Johnson says his clients’ projects are primarily new buildings or construction. “They buy the object, then build the room around it. We’ve sold an awful lot of parts to people building in Aspen, Vail, all over the mountain range.” In



Johnson ships all over the world, including this chair designed by Le Corbusier to someone in Germany.





**LEFT** Artifacts come from all different time periods and artistic styles.

**BELOW** Every major city has a good source of salvage. Restoration Resources in Boston is one such shop, selling everything from statuary to mantels.



FAR LEFT & LEFT: Eric Roth photos

fact, he says, he's sent trucks regularly to Texas and Canada. "I've sold a few items to Europe, but mostly the West and Southwest—like Santa Fe."

As Johnson puts it, he can ship anything, anywhere. "I've shipped crazy stuff, and overnight. When a movie studio in California wants something, they want it fast." He tells of sending two, nearly one-ton cast-iron French garden statues to Saudi Arabia last year. "The buyers never saw them. They just looked at a lot of photos, checked the dimen-

sions, said 'fine,' and sent the money."

In Johnson's view, interest in Victorian salvage is ebbing. "In Denver at least, people are removing it and going more modern." He says he's actually been buying building antiques from younger people who've acquired nicely restored old houses and are ripping half the stuff out. "One of the best French fireplaces I've ever owned I bought out of a fancy house here in Denver. So architecturally, there's stuff coming out for the second and third time."

Johnson illustrates the cyclical appeal of architectural antiques with an interesting story. "In the 1950s, Le Corbusier worked on the design of an entire city, Chandigarh, for the Indian government, along with his cousin Pierre Jeanneret, who designed much of the modernist furniture." By the 2000s, though, the furniture was considered outdated, even worthless. "At that time, you could buy it by the ton, but now almost all the pieces have gone to collectors in Europe and Japan."

Reflects Johnson, "I've been at architectural antiques for 50 years, and I still like the same things I liked in high school—stained glass, interesting objects from around the world—but that's just me."

**GORDON BOCK** is an architectural historian, instructor with the National Preservation Institute ([www.npi.org](http://www.npi.org)), and speaker through [www.gordonbock.com](http://www.gordonbock.com).



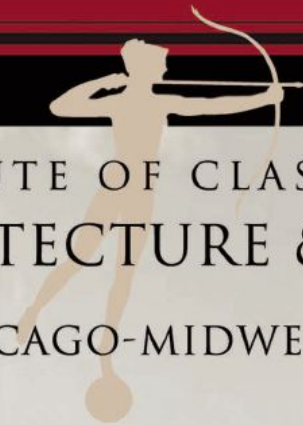

INSTITUTE OF CLASSICAL  
ARCHITECTURE & ART

CHICAGO-MIDWEST

## ACANTHUS AWARDS

CALL FOR ENTRIES

INTENT TO ENTER DEADLINE JULY 12, 2019

The Acanthus Awards are open to all design professionals, students and artisans practicing within the boundaries of the Chicago-Midwest region of the Institute of Classical Architecture & Art which includes: Illinois, Indiana, Iowa, Missouri, Wisconsin and the upper peninsula of Michigan, Projects submitted for consideration may be from anywhere in the world. Any project completed after January 1, 2010 is eligible. Categories include:

*Residential Architecture*

*Institutional or Commercial Architecture*

*Interior Design*

*Preservation & Restoration*

*Renovation & Adaptive Reuse*

*Landscape Design*

*Allied Arts & Craftsmanship*

*Unbuilt Work*

*Student Work*

### THANK YOU TO ALL OUR GENEROUS EVENT SPONSORS

Assured Corporation

Bulley & Andrews Residential

Casci Plaster / Decorators Supply

Craig Bergmann Landscape Design

Derrick Architecture

DMG Architectural Specialists

Elks Veterans National Memorial

Foster Reeve & Associates, Inc.

Gibbons, Fortman & Associates

HBRA Architects

Luxury Division of Pella

Kane Brothers , Inc.

Mariani Landscape

MGLM Architects

Pierre-Yves Rochon

Power Construction

Richard H. Driehaus Foundation

Sierra Pacific Windows

Sylvester Construction

The Nanz Company

Traditional Building Conference Series

For detailed information on the Acanthus Awards, Intent to Enter Submission Form, Submission Guidelines, and Invitation for Sponsorship, please visit our website at:

**[WWW.CLASSICISTCHICAGO.ORG](http://WWW.CLASSICISTCHICAGO.ORG)**



# QUIET &



PROJECT 2019 BULFINCH AWARD WINNER "CHARLES RIVER ESTATE"  
DESIGNER DAN GORDON LANDSCAPE ARCHITECTS



# GRACE

With woodlands to the east and an open meadow to the west, this landscape is classically designed to be in harmony with its history and surroundings

BY COURTNEY GOODRICH | PHOTOS BY NEIL LANDINO





“This elegantly planned and masterfully executed garden struck a chord with each of the jurors.”

— GIL SCHAFFER OF G.P. SCHAFFER ARCHITECTS,  
BULFINCH AWARD JUROR









“This design sets the perfect tone  
as a companion to the locale  
and the architecture.”

— ERIK EVENS OF EVENS ARCHITECTS, BULFINCH AWARD JUROR





The renovated circa-1900 house by the Charles River in Dover, Massachusetts, was charming, with its stucco exterior and slate-tile roof, but it wasn't until Dan Gordon Landscape Architects of Wellesley, Massachusetts, revitalized the landscape in 2015 that the entire property truly shined.

The four acres, which feature a woodland border and the river to the east and a broad, open meadow to the west, inevitably changed over the hundred-plus years since the house was built. A pool was added, rock walls were constructed, and the trees and shrubs near the house kept growing until they pretty much cut off the sightlines between the house, pool, and meadow, making

them feel disjointed from each other. "It's a well-built, turn-of-the-century house with a sun porch on the side opening to the gardens," says Gordon, "but the original design of the gardens had been added to over time with a series of additions of a lesser quality, which had been neglected and had become overgrown."

Gordon and his team renovated the outdoor living spaces and redeveloped the gardens for clients who wanted their property to feel in tune with the historical nature of the house as well as fit their needs for dining, pool, and entertaining spaces. To make the landscape fit cohesively with the architecture of the house and the context of its surroundings, Gordon used classic design elements such as symmetry, balanced proportion, designing along the axis, and an emphasis on greenery. The project earned Dan Gordon Landscape Architects a Bulfinch Award for excellence in landscape architecture this year from the Institute of Classical Architecture & Art (ICAA), a nonprofit organization that promotes the

importance and preservation of classical design.

"Landscape always starts with grading," says Gordon of how he began this project by simplifying the terraces near the house. The old bow-front rock wall that hugged the back-lawn terrace was handsome and consistent with the style of the architecture, but Gordon and his team, which included landscape contractor The Picot Company of Needham, New England Woodworkers of Kingston, and Custom Quality Pools of Billerica, took out "the labyrinth of walls that weren't really up to speed or well done," he says. Then, they moved the pool closer to the house, rotating it 90 degrees and centering it with the lawn terrace off of the southern-facing sun porch. Now, the pool stretches out from the house perpendicularly toward the woods. With the grade changes established—one step down from the house to the dining terrace, another step to the lawn terrace with the bow-front wall, then four steps down to the pool garden—they added walls and stairs to match

**OPPOSITE** Grading, hardscape, and planting work together to provide subtle definition of garden spaces.

**ABOVE** View of the pool centered on the lawn terrace from the south-facing sun porch.



**BELOW** The geometry of the design is an important element, reflected in clean lines, symmetry, and balanced proportions.

**RIGHT** Restrained color palette of greens and whites provide an accent to the organizing geometry.



existing ones and installed a red cedar fence with a cross-buck motif around the pool.

For plantings, clearing out what was overgrown between the house, pool, and meadow opened up the views and made the property feel unified. Staying true to traditional New England landscapes, stretches of lawn are bordered by trimmed boxwood and perennials such as Japanese pachysandra, lady fern, and peach blossom astilbe. Pathways are made of bluestone pavers and, for illumination, the team selected Teka path lights and Hunza step lights. An expanse of Annabelle hydrangea fills the area between the two sets of stairs leading to the pool garden, while eye-catching trees such as flowering dogwood and Merrill magnolia help define focal points throughout the landscape.

The color palette was purposely

kept minimal, using mostly greens and whites, so the geometry of the design is what you notice first, an important element to classical landscapes. But within the clean lines, symmetry, and balanced proportions, plants are encouraged to grow naturally and abundantly, especially around the perimeter of the property. The effect is that the planted material acts as a bridge between the architecture of the estate and the more organic pastoral setting of the landscape.

As one of the ICAA judges for this year's Bulfinch Awards, Erik Evens of Evens Architects of Los Angeles says, "This design sets the perfect tone as a companion to the locale and the architecture. Key here is the designer's sense of restraint. The materials and details are so well aligned with the woodland setting that the resulting spaces seem like perfect mediators between the natural

and the manmade. This is one of the great promises of landscape architecture, and one that this beautiful project achieves with quiet and grace."

Gil Schafer of G. P. Schafer Architect of New York, another judge for this year's Bulfinch Awards, agrees with Gordon's landscape achievements. "This elegantly planned and masterfully executed garden struck a chord with each of the jurors," he says. "We were unanimous in our enthusiasm for Dan Gordon's beautiful garden for this estate on the Charles River. We all loved the tailored yet understated approach to updating an old property without making it lose the soul of the original landscape—through careful detailing to match existing features and a restrained plant palette. A total delight."

The main success and what ultimately earned the award, Gordon believes, is that the design preserved the site

and harkened back to the intent of the original gardens. "You could do something that contrasted, something more contemporary," says Gordon. "You could remove more or remove less of what was already there, but we chose to look at the context closely and work with the best parts of what we had in a way that was not only sympathetic to the original architecture but enhanced it."

When all is said and done, the landscape is sure to grow and change over the next 100 years, just like before. But the touchstones of this design—grading, terraces, lawns, walls, and overall import of plant choices—will be the compass for how it was originally, how it's meant to be. And that's what is most important. The house opens to the gardens, the gardens open to the meadow, and the meadow opens to the natural world, calm and inviting in all its splendor.





TOP Materials and details align to define space and balance natural and man-made elements.

ABOVE Red cedar fence with cross-buck motif reflects a tailored yet understated approach to updating an old property.

LEFT Preserving the soul of the original landscape through careful detailing to match existing features struck a chord with the jurors.

## KEY SUPPLIERS

### LANDSCAPE SUPPLIERS

Bourque Bros. Irrigation  
Millican Nurseries  
Select Horticulture, Inc.  
Landscape Depot Supply



# staying in character

A prominent Los Angeles architecture firm breathes new life into a storied estate formerly owned by Hollywood icon Orson Welles for a couple and their daughter.

BY JENNIE NUNN

PHOTOGRAPHY BY SAM FROST

It's not every day that the 1920s Neoclassical Revival home of a Hollywood legend is listed on the market. Especially when that legend is late actor, screenwriter, and director Orson Welles, the mastermind behind films including *Citizen Kane*, *Touch of Evil*, and *The Trial*. But, the beloved Hollywood Hills home, badly deteriorated and suffering a series of unsympathetic renovations by subsequent owners (think an unsightly, problematic steel spiral staircase; aluminum windows; a neglected and overgrown yard; and a family room that had settled and sloped more than six inches), was hardly move-in ready.

Homeowners Dan Harries and Andrew Fayé welcomed the task and purchased the estate for themselves and their daughter. They also enlisted the help and expertise of notable architecture firm Tim Barber, Ltd. "We were initially referred to the client by Alison Sweeney [an actress and a client that we really enjoyed working with], and they had just renovated a 1912 Craftsman home. They had an appetite for a bigger project," explains Barber, principal of the 25-year-old firm known for numerous restoration projects by the likes of John Lautner, Greene and Greene, and Sumner Hunt. "They were really into the process and ready for the challenge of doing something pretty difficult, so that was exciting to us."

The initial concept for the home, now totaling 5,582-square feet, was to restore the property while preserving the integrity of the original architecture,









Reminiscent of a glamorous bygone era, the sparkling foyer was completely restored with black-and-white tile from Mission Tile West in Santa Monica.







"The kitchen's original layout lacked logic," says Barber of the refreshed design with a Miele 36" refrigerator with a custom panel finish, and a Whitehaus Duet Reversible Double Bowl Fireclay sink with apron. "We added a central farmhouse style prep table and reorganized the locations of the major appliances to make the kitchen more useful to a modern family. We also added new period-appropriate cabinetry."





**ABOVE** One of two his-and-his vanities flank the entrance to the master bath and shower.

**CENTER** Using tile from B&W Tile Co. in Gardena and fixtures from Vintage Tub & Bath in Mountain Top, Pennsylvania, the master bath was designed as a nod to the 1920s.

**OPPOSITE, FROM TOP** “I’ve been to several parties at the house and had dinners on the terrace,” says Barber. “It’s a great entertaining house.” The accessory structure is split into three functions: a two-car garage facing the street, a second story guest suite with an external stair, and a first floor pool house with a changing room, lounge, and kitchenette. Although Orson Welles lived and died in the main house, the guest house gained its own fame as the studio where Welles edited his final film, *The Other Side of the Wind*.

with modern updates for the couple and their then-preteen daughter. “The house was a disaster,” recalls Barber. “When he [Welles] was living out the last of his days there, he had added some really idiosyncratic pieces to it and interior arrangements so that he could move the bedroom to the first floor and created a bathroom of some sort. It was pretty decrepit and the maintenance was really deferred.”

For the major \$1.7-million overhaul, the intent was to pay homage to Welles’s past and create a warm and inviting space for the family with ample zones for entertaining. “We follow one school of thought [of The Secretary of the Interior’s Standards] pretty ardently, which is when you’re working with an older home of any sort, it’s really our obligation to return

it to be as respectful and original as possible. However in new work, the standards are often interpreted that it must be completely recognizably different from the original work, and in our case, we strove not to do that,” explains Barber. “Anyone can tell that the back of the house, which I would say is more Charlestonian in its language where the front is very plantation in its language, I find it respectful. And, even the guesthouse is really more farm vernacular than the front of the main house, but we wouldn’t want to make it all plantation-style because it’s 2019. However, we also don’t want to introduce a glass box. When we’re doing historic work we strive to make it both recognizably different, but really sympathetic.”

The property highlights include

a new attic staircase; a restored foyer and front porch; refurbished fireplaces and chimneys; a black-and-white tiled master bath designed as a nod to the 1920s and 1930s with tile from Gardena, California-based tile purveyor B&W Tile Co.; a master closet with vestibule; wraparound covered porches; a renovated basement, guest suite, rec room, and gym; a reconceived guesthouse; and a kidney-shaped outdoor pool with new coping. “One of the most standout features of the home is the rear, wrapping-covered porches on the first and second floors,” adds Kirk Snyder, director of design, AIA, LEED AP. “The addition of these [two] porches affords the neighboring rooms to be opened to the covered spaces, allowing for a true connection to the outdoors and incredible views of the





surrounding hillside. They also play on the plantation style of the home, adding to the authenticity of their addition and cementing the merging of the old with the new.”

Barber and his team also added subtle and deliberate winks to Welles’s legacy, including a wine room with a small display of memorabilia like movie posters and correspondence procured by Harries and Fayé, and an asymmetric east façade. “One of my favorite devices in this house is what we did to identify the front door,” adds Barber. “The original façade had no symmetry and the columns were symmetric, so the front door didn’t line up with anything. It was sliding slightly behind one of the columns, so we surveyed a precise angle out the front door between the two columns, and where it hit the front fence is where we placed the opening gate for visitors.” With the reinvented design, the home appears to be entirely symmetrical to visitors waiting to be buzzed in at the main gate. “It’s trompe l’oeil in landscape design,” adds Barber. “But I think it was our way of trying to at least give you the first impression of a grander, more clas-

sic house because the front door appears to be centered between the columns even though it’s not.”

After completing the main house, phase two began on the guesthouse, once the chauffeur’s living quarters. “The ‘story’ or narrative, which the owners more eloquently describe, is to imagine that the guesthouse was built in the 1930s, after the 1920s main house,” says Ari Engelman, senior project manager, AIA, of the new one-and-a-half-story structure outfitted with a guest suite and a rec room. “The exterior complements the style of the main house, but it has more of a 1930s vibe, which is perhaps best seen in its Art Déco/1930s-style bathrooms and wet bar.”

Now, the fully renovated estate, used for frequent family gatherings and dinner parties, is a perfect blend of past and present. “In this case, we don’t know how Welles would have lived and we didn’t know what the original architect’s intent was for the back of the house, so we made our own narrative,” says Barber. “That it was Welles’s home and it has this really impressive façade was worth the effort to make it right.







# LANDMARK RESTORATION

A French Renaissance-style building in New York is carefully restored.

BY NANCY A. RUHLING

PHOTOS BY FRANCIS DZIKOWSKI (EXCEPT WHERE OTHERWISE NOTED)

PROJECT SoHo Cast Iron Building Restoration  
ARCHITECT PBDW Architects





In the SoHo Cast Iron Historic District of New York City, 462-468 Broadway reigns supreme. The massive white wedding cake of a building—it rises six stories, fronts three streets and has a façade that measures 40,000 square feet—lays claim to being the district’s largest structure that is fully clad in cast iron.

Designed by John Correja as the home for the dry-goods purveyor Mills & Gibbs, it was erected in 1880, shortly before cast-iron facades fell out of fashion in the city. Today, its main tenant is the International Culinary Center, a private school.

The landmark French Renaissance-style building remained largely untouched until its columned façade was restored by PBDW Architects, the half-century-old New York City firm that has brought a variety

of houses and institutions, including the Central Park boathouses, the Park Avenue Armory, the Palace Theatre, and the Louis Armstrong House Museum, back to their past lives.

The idea for the restoration began over 35 years ago when real estate developers Stephen Meringoff and Jay Shidler bought the building in 1981.

A restaurant on the ground floor that had a long-term lease stalled the work until 2015, when PBDW partner in charge Sam White, FAIA, and his team, which included project architect Brigitte Cook, AIA, and job captain Adelaide Palum, were commissioned to restore the exterior.

“The building was in pretty good shape and well maintained and preserved,” Cook says. “But the paint was peeling. Once we

started analyzing it, we found that there were a few more problems, including one section that was punched in—it looked like it had been hit by a car.”

In addition to repainting the building in its historic color scheme, the PBDW team, which worked closely with New York City’s Landmarks Preservation Commission, repaired the galvanized sheet-metal cornice, removed non-historic roof alterations, restored the ground-level storefront, replaced two floors of 11-foot-high double-hung wood windows, restored fire shutters and reconstructed a variety of original ornamental cast-iron elements.

“Our priority was to maintain the elegance of the original design while preserving as much original material as possible,” White says, adding that he took particular

**OPPOSITE** The Corinthian capitals, one of the building’s defining features, were taken apart piece by piece. Their bell housings were remade. *Photo by Adelaide Palum (PBDW Architects)*

**CENTER** A detail of a Corinthian column; the leaves were designed to project.

**ABOVE** The building, which faces three streets, has two styles of capitals—Corinthian and Modified Doric.





**Broadway is the largest structure fully clad in cast iron in the SoHo Cast Iron Historic District of New York City.**

pleasure in watching the removal of a section of red granite that had been added to the street-level facade in the 1960s.

“I had been waiting for 35 years to get it off,” he says. “The original cast iron was still there.”

A detailed paint analysis revealed that the cast-iron elements originally had been faux painted to look like colored marble, and the team decided on using the original base color, punctuating it with windows that have dark green frames.

“We saw evidence that perhaps more than one color of paint was used on the original cast-iron elements,” White says, “but we feel the single color is quite handsome. The green for the windows was an architectural

choice that visually separates them from the columns and gives a muscularity to the building”

Stripping the paint was a painstaking process. “It took a long time,” Cook says. “There were areas that had 10 to 20 coats.”

She adds that even with the new paint, “the texture of the cast-iron still reads. It doesn’t look brand new.”

The columned façade’s alternating window bays have a robust rhythm—AA on Broadway, ABCBA on Grand Street, and DD on Crosby Street—that is accented by Corinthian capitals on the As and Cs and Modified Doric capitals on the Cs and Ds.

It was the 108 Corinthian capitals that created the greatest challenge. When the

team removed their 135 years of layers upon layers of paint, the 20 individually cast acanthus leaves that defined each capital became unstable.

The defect lay with the design. The leaves were mechanically attached to the surrounding shaft with a bell housing or cuff that flared at the top, allowing them to project. Packs of rust, built up through the years, caused the cuffs to crack and also compromised the mechanical attachments.

“The bell housings had another design function,” White says. “They allowed a more robust capital to fit on a more slender column shaft, which adds to the delicate detail and hierarchies of the elevations.”

Although the team explored the use of





“It engages you at street level.”

— SAM WHITE, FAIA, PBDW ARCHITECTS





**ABOVE** The building looks like a wedding cake.

**CENTER** A corner view of 462-468 Broadway—a study in white. *Photo by Michael Neglia (PBDW Architects)*

**FAR RIGHT** The building, which faces three streets, has two styles of capitals—Corinthian and Modified Doric.



LEFT: Photo by Adelaide Palum. (PBDW Architects)



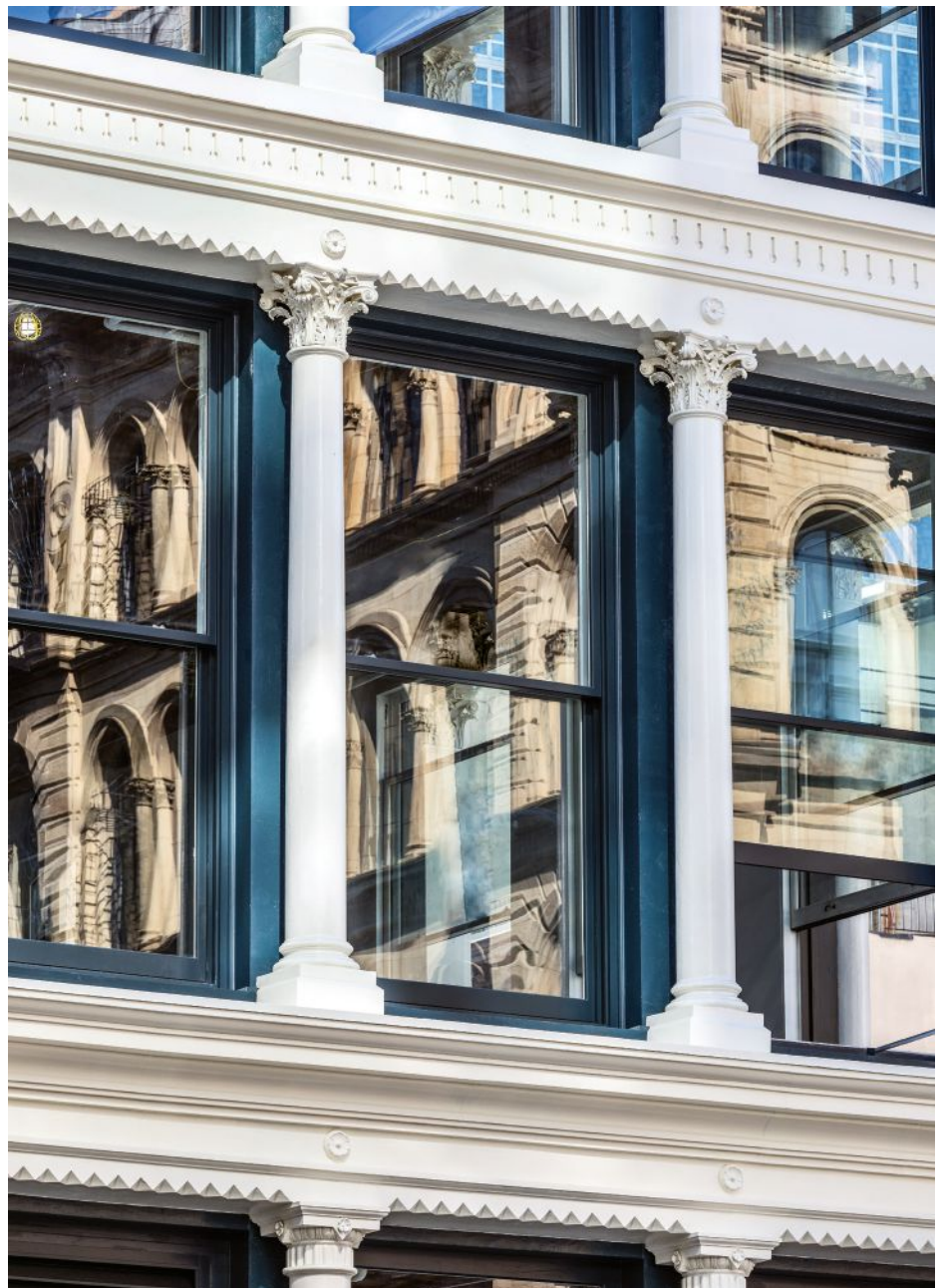

resin capitals, it chose to work with cast iron because it allowed them to maintain the building's integrity. The team kept the majority of intact decorative elements and only replaced the inner bell housings and the most severely damaged pieces.

"The resin was very beautiful, but the cost of the casting itself wasn't that different," White says.

The team restored more than 1,549 of the original 1,976 cast-iron elements on the 108 Corinthian capitals. The cuffs were replaced with newly designed attachments that replicate the intricacy and depth of rhythm of the originals, and the original intact acanthus leaves were restored and reinstalled.

"It was special to see how the original capitals and leaves were put together, which allowed us to improve the details of assembly," Cook says.

She added that this also allowed the

team to give all sides of the capitals three layers of protective paint coatings.

The team erected scaffolding over the whole building, which houses offices on top and retail stores on its lower levels, and worked section by section, using a 50-foot by 200-foot space on one of the building's lower floors as a workshop.

As the scope of the project widened, so did the time frame—it took over a year to complete everything.

"It's really a tribute to the owner," says White, "because you need a cast-iron stomach to allow an architect to do what we did and keep the lower floors of the building out of commission for so long."

The project has received numerous accolades. It won a Stanford White Award, a MASTERworks Award from the Municipal Art Society for Best Restoration, and a Lucy G. Moses Preservation Award from The New York

## KEY SUPPLIERS

ARCHITECT PBDW Architects

GENERAL CONTRACTOR Archstone Builders

RESTORATION CONTRACTOR MRS

METAL FABRICATION Allen Architectural Metals

WINDOW AND DOOR FABRICATORS Artistic Windows

COATINGS Righter Group Tnemec Paint and Elastometal

Landmarks Conservancy.

The restoration was part of a master plan made by PBDW that includes multiple configurations for windows and doors on the lower floors that will be modified as new tenants move in.

"In the future, we may put awnings on the second-floor windows as they originally did," White says. "We have

permission from the landmarks commission to do this."

White calls working on 462-468 Broadway "the chance of a lifetime."

Unlike some of the firm's other high-profile restorations, this one is on view all the time. "It dominates the public realm," White says. "It engages you at street level."





The Dolphin Fountain was rebuilt, topped with new balustrades and now flows with water. The lively water adds movement, light reflections, and music to the garden. The evergreen hedges beyond create a private pool area.

PROTECTING AN  
*American  
Classic*

Janice Parker's thoughtful revival of an Ellen Biddle Shipman landscape in Connecticut.

BY MAGGIE MEAHL | PHOTOS BY NEIL LANDINO





Janice Parker took the formidable challenge of restoring a 1920s Ellen Biddle Shipman-designed landscape and conquered it.

She was fortunate to connect with owners who were as passionate as she about preserving the timeworn garden architectural features at the formerly named “Altna Craig” estate in Ridgefield, Connecticut. “It takes a mature client to preserve and not knock down old buildings and architectural elements,” she points out.

A Palladio Award winner, Parker is a principal at Greenwich, Connecticut-based Janice Parker Landscape Architects. In addition, she is the author of the stunning *Janice Parker Landscape Architects: Designing a Vision* (2017). She is awed by Shipman and considers her a muse. “It was an honor to try and preserve her work and led me to study groundbreaking early women landscape

designers,” she reflects. With no original plans or photos to work with, she relied on Shipman expert Judith Tankard for advice.

The homeowners used Connecticut-based architect Sean O’Kane not only to restore the existing vintage Shingle-style home (for planned use as a guesthouse) but also to build a new, complementary main home. Parker says O’Kane “paved the way and made it possible for me to do the project.” The architect also helped with the restoration of the many crumbling balustrades about the property and fabricated new ones to match.

The overarching goal was to bring back a cohesive look to the 1.5-acre estate. Sounds easy, but Parker had to deal with a steep gradient, among other factors.

A starting point for Parker’s site design included re-joining the awkward 20th-century subdivision of the land that now had

two homes on it. She aimed for a feeling of symmetry and movement and used the clients’ favorite plants to lend a romantic feel to the place—one that harkens back to the Gilded Age-era when it was built. Parker achieved this harmony by linking the disparate parts with her signature grass-jointed strolling paths and box hedge walls. She also inserted new stone steps into the lawn panel that slopes downward toward the west. Finally, to add color and texture in the upper reaches, she mixed trees with shrubs such as Japanese maples, hornbeams, beech, and clipped evergreens.

Another priority of the Ridgefield, Connecticut, project was to repair existing architectural features. For example, there was the “dolphin fountain,” centered into the curved wall of the main stucco upper terrace that needed to be restored. Parker believes it was the original center of the Shipman design.









**ABOVE** The original garden pavilion by Ellen Biddle Shipman is framed by red fastigiata beeches, rose filled boxwood gardens, and tree form lilacs. The mature trees were preserved to provide shade, historical context, and a sense of refuge.

**FAR LEFT** A patterned grass jointed path runs across the lower lawn to the restored classic circular bench. This gesture is the designer's earnest channeling of the gardens of Ellen Biddle Shipman.

**LEFT** A restored flowering rose and lavender garden tops the natural stone retaining wall that creates the lawn panel in front of the historic pool pavilion.





To bring the dolphin fountain terrace area back as the center axial point of the property was perhaps the most challenging part of the design process.

Moreover, the team had to get it working again and add a new tiered “top fountain” (with new pump room) to the upper terrace that would be in a sight line from the new main house. Many were involved in the fountain work, including the general contractor and an expert plumber. “To get it up and running, when it probably hadn’t run in 80 years, as well as to add a new one to the top area above the existing one was a feat of plumbing engineering,” Parker praises. The dolphin fountain had to be re-chambered, re-plumbed, and re-waterproofed. The final step was to find an expert craftsman to restore the original pebble stucco finish on the wall.

Below the fountain terraces, to the

left, is the square Pavilion Garden. The classically designed original pool house was in surprisingly good condition and only needed a new skim coat of stucco and concrete. In place of the former swimming pool is a turf area that begs for a game of badminton or croquet. A final Parker touch is an ornamental stone bench that looks like it has been there forever. “One of the main things that makes a garden is the bench,” says Parker. “Even if you don’t sit on them, they create an intimate domesticity to the scene.”

Moving downward from the Pavilion Garden is a series of three old-fashioned-style rose arches designed by Parker. A handsome, bespoke stag sculpture made of stone, iron, and limestone by New England Garden Ornaments sits at the end of the axial line.

Grass-jointed paths, designed in a clever Union Jack pattern, lead to a large

semi-circular original stone bench. Parker enjoyed reinvigorating this romantic destination spot located at the west end of the property, saying, “It reminds me so much of the beautiful garden details that have been protected at Dumbarton Oaks.” She replaced existing ho-hum pavers in front of the classic bench with a “simple” pebble compass rose. Behind is a cozy screen of pruned European hornbeams.

Pink and white roses play a key role in the garden rooms. A favorite flower of the homeowners, they are used as climbers on the arches and also in a series of small beds framed with lavender and boxwood that dot the landscape.

Mature and new trees ring the property. A Parker favorite is the red fastigiata beech. “We have them laid out in corners of the lawn panel. They add a lot of green architecture as well as create an enormous amount of value for

the homeowners in the long term,” she notes. Fastigiata trees tend to grow nicely without casting too much shade. Reliable underplantings include ribbon grass, Hakone grass, and “Limelight” hydrangeas “that tumble about the bases,” says Parker.

The restoration of the Ridgefield, Connecticut, estate landscape took over four years to complete at a cost of approximately \$500,000. The multifaceted project posed a myriad of challenges. Parker continues to convey gratitude for her clients, Shipman, and all of the professionals who helped make her vision a reality. The goal was always to preserve existing elements where possible. It was also to integrate new landscape features in a manner that did not look forced. All told, it is a historic American garden created by the groundbreaking Shipman and lovingly restored by Parker.





**CLOCKWISE FROM FAR LEFT** The grade change and staircases are planted with rounded structural boxwoods to add rhythm and create the effect of rolling down the hill.

The Wild Stag was created for the garden and sits on a limestone pedestal, complete with iron antlers.

The Wild Stag guards the new necklace of European Hornbeams, pruned to become a curved green wall, underplanted with chartreuse leaved Deutzia 'Chardonnay Pearls'.

The historical circular bench is restored and paved with a custom designed and fabricated pebble mosaic compass rose made of natural cleft bluestone with a tumbled blue-stone banding.

Hydrangea softens a formal planting bed along the walkway.



# FREE INFORMATION GUIDE

Visit [traditionalbuilding.hotims.com](http://traditionalbuilding.hotims.com) for FREE information on traditional buildings and products provided by the companies below.

## Historical Products Showcase

Allied Window, Inc. ....	9, 64
800-445-5411 www.alliedwindow.com	
Architectural Components, Inc. ....	67
413-367-9441 www.architecturalcomponentsinc.com	
Architectural Grille.....	67
800-387-6267 www.archgrille.com	
Artistic Doors & Windows .....	3, 67
800-278-3667 www.artisticdoorsandwindows.com	
Custom Service Hardware, Inc.....	13, 64
262-243-3081 www.cshardware.com	
E.R. Butler & Co. ....	67, Inside Back Cover
212-925-3565 www.erbutler.com	
EverGreene Architectural Arts, Inc.....	8
212-244-2800 www.evergreene.com	
Gaby's Shoppe .....	19
800-299-4229 www.gabys.com	
HeartWood Fine Windows & Doors.....	15, 64
585-340-9085 www.heartwoodwindowsanddoors.com	
Heritage Metalworks .....	19
610-518-3999 www.hmwp.com	
Hochstetler Timbers.....	65
419-368-0008 www.hochstetlertimbers.com	
Hope's Windows, Inc.....	5, 66
716-665-5124 www.hopeswindows.com	
Innerglass Window Systems .....	65
800-743-6207 www.stormwindows.com	
NIKO Contracting Co., Inc. ....	10
412-687-1517 www.nikocontracting.com	
Pacific Register Company .....	21
805-487-7500 www.pacificregisterco.com	
Phelps Company.....	21
603-336-6213 www.phelpscompany.com	
Timberlane, Inc.....	Inside Front Cover, 64
215-616-0600 www.timberlane.com	
Vintage Doors.....	66, Back Cover
800-787-2001 www.vintagedoors.com	
Vintage Hardware & Lighting.....	21
360-379-9030 www.vintagehardware.com	

## Greenhouses, Gazebos & Outbuildings

Hartley Botanic Inc. ....	69
781-933-1993 www.hartleybotanic.com	

## Window Restoration & Repair

Green Mountain Insulated Glass, Inc.....	74
802-772-4394 www.greenmtinsulatedglass.com	

## Epoxies & Finishes

Abatron, Inc.....	71
800-445-1754 www.abatron.com	

Preservation Products, Inc.....	71
800-553-0523 www.preservationproducts.com	

## Landscape & Garden Specialties

Aztec Stone Empire .....	7, 72
770-368-9337 www.aztecstoneempire.com	
Chadsworth Columns .....	1, 72
910-763-7600 www.columns.com	
Historical Arts & Casting, Inc.....	19
800-225-1414 www.historicalarts.com	
King Architectural Metals .....	2, 72
800-542-2379 www.kingmetals.com	
Robinson Iron Corp.....	11, 72
800-824-2157 www.robinsoniron.com	
Wiemann Metalcraft .....	73
918-592-1700 www.wmcraft.com	

## Exterior Lighting & Gas Lighting

Ball & Ball Lighting .....	75
610-363-7330 www.ballandball.com	
Deep Landing Workshop .....	75
877-778-4042 www.deeplandingworkshop.com	
Grand Light .....	76
800-922-1469 www.grandlight.com	
House of Antique Hardware .....	10
888-223-2545 www.houseofantiquehardware.com	
Lantern Masters, Inc. ....	77
818-706-1990 www.lanternmasters.com	
St. Louis Antique Lighting Co.....	4, 75
314-863-1414 www.slalco.com	
Steven Handelman Studios .....	76
805-962-5119 www.stevenhandelmanstudios.com	

## Masonry Restoration, Cleaning & Waterproofing

Old World Stone Ltd. ....	79
800-281-9615; 905-332-5547 www.oldworldstone.com	
Trow & Holden .....	78
800-451-4349 www.trowandholden.com	
Weathercap, Inc. ....	78
985-649-4000 www.weathercap.net	

## Architectural Antiques & Salvaged Material

Architectural Accents.....	60
404-266-8700 www.architecturalaccents.com	
Architectural Antiques of Indianapolis .....	60
317-873-2727 www.antiquearchitectural.com	
Architectural Parts Warehouse .....	60
518-465-2987 www.historic-albany.org/warehouse	
Aurora Mills Architectural Salvage.....	60
503-678-6083 www.auroramills.com	

B & P Lamp Supply, Inc.....	60
800-822-3450 www.bplampsupply.com	
C. Neri Antiques.....	60
215-923-6669 www.neriantiquelighting.com	
Carlson's Barnwood Co.....	60
309-522-5550 www.carlsonsbarnwood.com	
Ecorad .....	60
418-598-3273 www.ecorad.ca	
Eron Johnson Antiques .....	61
303-777-8700 www.eronjohnsonantiques.com	
Goodwin Company .....	61
800-336-3118 www.heartpine.com	
Materials Unlimited.....	61
800-299-9462 www.materialsunlimited.com	
Pinch of the Past.....	61
912-656-4290 www.pinchofthepast.com	
Sylvan Brandt .....	61
717-626-4520 www.sylvanbrandt.com	
United House Wrecking, Inc.....	61
203-348-5371 www.united-antiques.com	
Wooden Nickel Antiques .....	61
513-241-2985 www.woodennickelantiques.net	



OLD HOUSE JOURNAL  
ARTS & CRAFTS HOMES  
NEW OLD HOUSE  
DESIGN CENTER SOURCEBOOK  
OLDHOUSEONLINE.COM  
**TRADITIONAL BUILDING**  
**PERIOD-HOMES.COM**  
**TRADITIONALBUILDING.COM**

LOG HOME LIVING  
TIMBER HOME LIVING  
COZY CABINS & COTTAGES  
DREAM HOME SHOWCASE  
BEST LOG & TIMBER HOME OF THE YEAR  
BEST LOG & TIMBER FLOOR PLANS  
LOG & TIMBER HOME PLANNER  
CABINLIFE.COM  
LOGHOME.COM

## ADVERTISING INQUIRIES

ASSOCIATE PUBLISHER  
**Jennifer Baldwin**  
jenbaldwin1@msn.com  
718-619-7645





Register today for the  
architecture & design  
event of the year!

[conferenceonarchitecture.com](http://conferenceonarchitecture.com)

Image: Sam Morris/Las Vegas News Bureau



AIA Conference on Architecture 2019  
June 6-8, Las Vegas  
[conferenceonarchitecture.com](http://conferenceonarchitecture.com)



# RESOURCE GUIDE ARCHITECTURAL ANTIQUES & SALVAGED MATERIALS



A French paneled room circa 1750 refitted for a newly constructed dining room, together with a Louis XV reproduction mantel carved in white statuary marble.

**ARCHITECTURAL ACCENTS**  
404-266-8700; [architecturalaccents.com](http://architecturalaccents.com)  
Atlanta, GA

Specializing in 17th, 18th, and 19th century architectural antiques and reproductions. In their 30,000 sq. ft. showroom, you will find the most comprehensive selection of European and American designs plus a team of experts to assist you with remodeling, restoration and installation.



Massive cast bronze chandelier circa 1910

**ARCHITECTURAL ANTIQUES OF INDIANAPOLIS**  
317-873-2727; [antiquearchitectural.com](http://antiquearchitectural.com)  
Indianapolis, IN

Our 40th year! Architectural Antiques of Indianapolis has a large inventory of American building salvage including lighting, fireplace surrounds, doors, leaded windows & unique furnishings & accents for restoration or new construction.



Selection of architectural antiques and building elements rescued from historic homes and available for sale at our warehouse.

**ARCHITECTURAL PARTS WAREHOUSE**  
518-465-0876  
[historic-albany.org/warehouse](http://historic-albany.org/warehouse)  
Albany, NY

Historic Albany Foundation's Architectural Parts Warehouse was established in 1978 to prevent historic building elements from being lost forever. Our volunteer "salvage commandos" rescue and resell parts removed from historic homes so they can find a new use in yours.



Our showroom is a 19th century grain mill complex filled with thousands of vintage and antique items for the ultimate shopping experience.

**AURORA MILLS ARCHITECTURAL SALVAGE**  
503-678-6083; [auroramills.com](http://auroramills.com)  
Aurora, OR

For 20 years, Aurora Mills has sourced only the finest in architectural antiques, industrial objects, vintage curiosities, Oregon salvaged lumber, antique barn wood, and reclaimed beams. Our inventory encompasses all historical architectural styles. It is our mission to provide furnishings and decor that are one of a kind.



B&P Lamp Supply's architecturally articulate, custom made glass lamp shades are in stock and made to order.

**B&P LAMP SUPPLY, INC.**  
800-822-3450; [bplampsupply.com](http://bplampsupply.com)  
McMinnville, TN

For over 60 years, B&P Lamp Supply has helped clients create and maintain their ideal decor with beautiful lamps, chandeliers, sconces and other fixtures. Whether you are reviving your rare finds, turning generic pieces into vintage gems, replacing a worn-out part or building an entire lamp, we are the leaders in lamp parts.

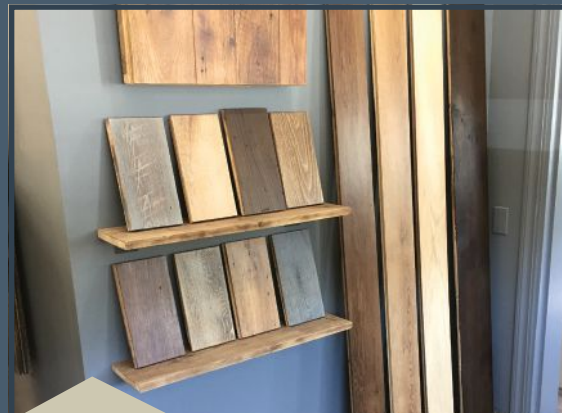

Fumed Antique Oak, many choices.

**BABA ANTIQUE WOODEN FLOORING CO.**  
800-542-4812; [baba.com](http://baba.com); Pittsboro, NC

The BABA Mill provides the highest quality reclaimed antique wooden flooring throughout the country. Best known for our original surface fumed antique oak, fumed antique chestnut, and wide board antique heart pine. We provide matching stair treads, risers, and casework. Will do installation and finishing, or work directly with your craftspeople. Samples available upon request.



This antique transitional chandelier is one of many original antique lights we have for sale.

**C. NERI ANTIQUES**  
215-923-6669  
[neriantiquelighting.com](http://neriantiquelighting.com)  
Philadelphia, PA

RETIREMENT SALE after 43 years in business as a Supplier of American Victorian antiques; we offer sconces, table & floor lamps, newel post lights & chandeliers as well as a large selection of antique clocks and much more. We have two floors of antiques to meet your needs.



Carlson's reclaimed timbers were used to build this island/bar.

**CARLSON'S BARNWOOD CO.**  
309-522-5550  
[carlsonsbarnwood.com](http://carlsonsbarnwood.com)  
Cambridge, IL

We specialize in selling reclaimed building products and manufacturing reclaimed-remilled flooring. We sell barnwood, beams, tin, wood flooring, custom-made reclaimed furniture and barn doors.

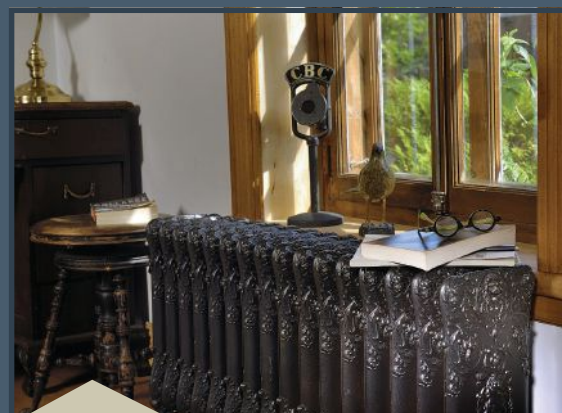

Experts in restoration of cast Iron radiators

**ECORAD**  
855-632-6723  
[ecoradusa.com](http://ecoradusa.com)  
Rocky Hill, CT

Restoration, conversion and sales of antiques cast iron radiators



# ARCHITECTURAL ANTIQUES & SALVAGED MATERIALS RESOURCE GUIDE



Antique 19th-century carved and painted solid teak door

## ERON JOHNSON ANTIQUES

303-777-8700  
[eronjohnsonantiques.com](http://eronjohnsonantiques.com)  
 Denver, CO 80223

Shop online over 3,000 pieces of period antique and vintage architectural salvage, doors, columns, stained glass, ironwork, garden ornament, furniture and lighting dating from the 17th century to mid-century modern.



Antique wood from America's first forests... Our Precision-Engineered Antique Wood Flooring is made entirely at our mill here in the USA.

## GOODWIN COMPANY

800-336-3118  
[heartpine.com](http://heartpine.com)  
 Micanopy, FL

River-recovered heart pine and heart cypress. Goodwin recovers these antique logs and mills them into flooring, stair parts and millwork offering 100% heart... the richest, most beautiful wood in the world... in limited supply. Only Goodwin



Relaxation, comfort & therapy can be yours!

## MAC THE ANTIQUE PLUMBER

800-916-BATH (2284)  
[antiqueplumber.com](http://antiqueplumber.com)  
 Mount Aukum, CA

Plumbing, lighting, hardware & more for the entire home! Hundreds of unique high-quality items priced with special discounted prices. Get expert advice. Please check us out on the web!



Just a few of the stunning original items that can be found at our location.

## MATERIALS UNLIMITED

734-483-6980  
[materialsunlimited.com](http://materialsunlimited.com)  
 Ypsilanti MI 48197

We are a restoration facility housed in a 15,000 sq.ft store showcasing a wide variety of antiques. Explore instore or online for lighting, leaded glass, doors, furniture, home decor, hardware, and so much more!



Anything that comes from a building is available at Pinch of the Past!

## PINCH OF THE PAST

912-656-4290  
[pinchofthepast.com](http://pinchofthepast.com)  
 Greensboro, GA

Specializing in Salvaging and Restoring Architectural Building Components. Our large Greensboro, Georgia location has doors, windows, fencing, mantels, building, door, & Cabinet hardware, lighting, gates, tile, statuary, and garden pieces, sinks, tubs, shutters, and trims and lumber.



Restored, vintage steel window from the collection of Seekircher Steel Window.

## SEEKIRCHER STEEL WINDOW REPAIR

914-734-8004; [seekirchersteelwindow.com](http://seekirchersteelwindow.com)  
 Peekskill, NY

Repair and restoration of historic steel casement windows and doors, performed both on and off site for residential and commercial properties. Work successfully completed in over 30 states. Large inventory of vintage steel casement windows and French doors for sale. Family owned and operated since 1977.



Reworked, original surface pine floors complement this beautiful, fully restored home

## SYLVAN BRANDT

717-626-4520; [sylvanbrandt.com](http://sylvanbrandt.com); Lititz, PA  
 Sylvan Brandt Reclaimed Flooring is a third generation family owned and operated business located in Lititz, PA. Shipping nationwide, Sylvan Brandt remills the finest reclaimed lumber sourced from homes, barns and warehouses slated for demolition. The company also sells reclaimed barn wood including beams, barn siding, threshing floor planks and salvage materials. Call for more information or visit our website.



This mantel and stained glass are some of many architectural antiques and unique home furnishings available at our showroom.

## UNITED HOUSEWRECKING

203-348-5371  
[unitedhousewrecking.com](http://unitedhousewrecking.com)  
 Stamford, CT

United House Wrecking started as a demolition business in 1954 salvaging doors, mantels, stained glass and other architectural remnants of value. It has evolved into a unique home furnishings store.



So much to see and to discover in Wooden Nickel Antiques's lovely, historic building in Cincinnati, OH.

## WOODEN NICKEL ANTIQUES

513-241-2985  
[woodennickelantiques.net](http://woodennickelantiques.net)  
 Cincinnati, OH

We specialize in architectural antiques, saloon front and back bars, stained glass, chandeliers, Victorian furniture, and decorative items.



# HISTORICAL PRODUCTS SHOWCASE

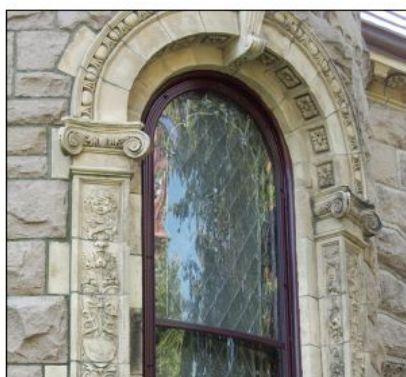

**ALLIED WINDOW, INC.**  
800-445-5411; Fax: 513-559-1883  
[www.alliedwindow.com](http://www.alliedwindow.com)  
Cincinnati, OH 45241

Manufacturer & installer of Invisible Storm Windows  
®: custom colors, shapes & glazing materials; aluminum; sound-reduction protection from UV & vandalism; interior & exterior; commercial & residential applications.

SEE OUR AD ON PAGE 9, 64.



**ARCHITECTURAL COMPONENTS, INC.**  
413-367-9441; Fax: 413-367-9461  
[www.architecturalcomponentsinc.com](http://www.architecturalcomponentsinc.com)  
Montague, MA 01351

Manufacturer of reproduction & custom wood windows & doors: true-divided lites with insulated glass; wood-framed storm sash & screens; renovation & restoration projects & new construction; paneled walls & storefronts; catalog \$5.

SEE OUR AD ON PAGE 67.

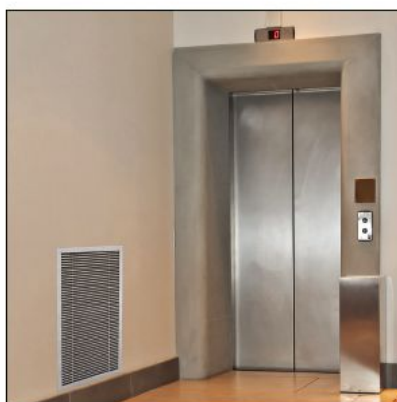

**ARCHITECTURAL GRILLE**  
800-387-6267; Fax: 718-832-1390  
[www.archgrille.com](http://www.archgrille.com)  
Brooklyn, NY 11215

Manufacturer of custom grilles: perforated & linear bar grilles; radiator covers; aluminum, brass, steel & stainless steel; variety of finishes; stock sizes; water-jet & laser cutting.

SEE OUR AD ON PAGE 67.

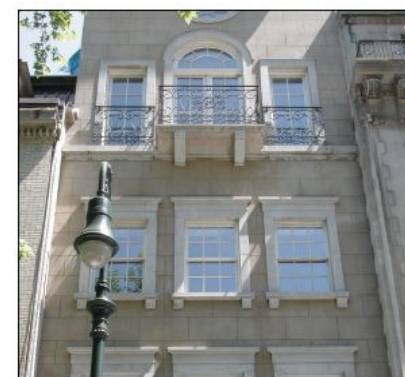

**ARTISTIC DOORS & WINDOWS**  
800-278-3667; Fax: 732-726-9494  
[www.artisticdoorsandwindows.com](http://www.artisticdoorsandwindows.com)  
Avenel, NJ 07001

Manufacturer of fully custom hardwood windows and doors, exact Landmark matching details, modern and traditional profiles, all glazing types available, rated for coastal properties, high level OITC, air and water proof, professional installation available.

SEE OUR AD ON PAGE 3, 67.



**CUSTOM SERVICE HARDWARE**  
262-243-3081; Fax: 262-375-7970  
[www.cshardware.com](http://www.cshardware.com)  
Cedarburg, WI 53012

Wholesale supplier to the building, remodeling, woodworking and DIY industry since 1977. Products include: Rolling Library Ladders, Barn Door Hardware, Decorative Wood Products, Cabinets, Drawer Slides, Hinges, lighting, kitchen storage accessories.

SEE OUR AD ON PAGE 13, 64.



**E.R. BUTLER & CO.**  
212-925-3565; Fax: 212-925-3305  
[www.erbutler.com](http://www.erbutler.com)  
New York, NY 10012

Manufacturer of historically accurate, premium-quality hardware for doors, windows & furniture: brass, bronze, nickel, silver & wrought iron; complete design selections of Early American period hardware; many finishes.

SEE OUR AD ON PAGE 67, INSIDE BACK COVER.

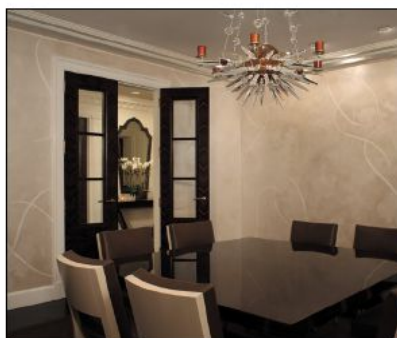

**EVERGREENE ARCHITECTURAL ARTS**  
212-244-2800; Fax: 212-244-6204  
[www.evergreene.com](http://www.evergreene.com)  
Brooklyn, NY 11232

Decorative-arts studio: murals, decorative painting, gilding, plaster, wood, metal, stone & mosaics; new design, conservation & restoration; ecclesiastical, institutional, public & commercial projects; offices in NYC & Chicago.

SEE OUR AD ON PAGE 8.



**GABY'S SHOPPE**  
800-299-4229; Fax: 214-748-7701  
[www.gabys.com](http://www.gabys.com)  
Dallas, TX 75207

Manufacturer of handcrafted decorative iron drapery hardware: for curved & angled bay windows & arches; 30 standard finishes; more than 100 finial options.

SEE OUR AD ON PAGE 19.

**Allied Window, Inc**  
MANUFACTURER OF CUSTOM  
*"Invisible" Storm Windows®*  
SEE OUR AD ON PAGE 9

LEARN MORE ABOUT  
**SUSTAIN KRETE** on page 13  
SUSTAIN KRETE™  
CSH

CONTINUING TRADITION WITH HANDCRAFTED SHUTTERS  
**TIMBERLANE**  
See Our Ad on the Inside Front Cover

**HEARTWOOD**  
FINE WINDOWS AND DOORS™  
See our ad on Page 15





**HEARTWOOD FINE WINDOWS & DOORS**  
585-340-9085; Fax: 585-254-1760  
www.heartwoodwindowsanddoors.com  
Rochester, NY 14606

Manufacturer of custom architectural wood windows & doors: Honduras mahogany & other species; traditional mortise-&-tenon construction; standard & decorative glazing; related window & door hardware; 68-year-old company.

SEE OUR AD ON PAGE 15, 64.



**HERITAGE METALWORKS**  
610-518-3999; Fax: 610-518-7264  
www.hmwpa.com  
Downingtown, PA 19335

Foundry, blacksmith shop and custom metal fabricator offering historically accurate and custom-designed lighting, architectural hardware, and designer-envisioned metalwork including interior and exterior gates & railings.

SEE OUR AD ON PAGE 19.

**Infrared Proof: Our Storm Windows Save Energy!**

**Innerglass**  
Window Systems, LLC  
The Compression-Fit Advantage

Innerglass Interior Storm Windows keep the building **warm** in the winter and cooler in the summer without sacrificing the charm and beauty of *existing* historic windows.

Noise reduction better than replacement windows.

Compression-fits to ANY window, no matter how crooked!

Innerglass (left)  
Existing window (right)

Lyman Estate

**Innerglass Window Systems, LLC**  
15 Herman Drive • Simsbury, CT  
1-800-743-6207 • www.stormwindows.com



**HOCHSTETLER TIMBERS**  
419-368-0008; Fax: 419-368-6080  
www.hochstetlertimbers.com  
Loudonville, OH 44842

Supplier of new timbers in oak up to 40 ft. long; planed & rough sawn; 2x6 & 1x6 tongue-in-groove knotty pine.

SEE OUR AD ON PAGE 65.



**HOPE'S WINDOWS, INC.**  
716-665-5124; Fax: 716-665-3365  
www.hopeswindows.com  
Jamestown, NY 14702

Manufacturer of custom-designed windows & doors: handcrafted, hot-rolled, solid-steel & solid-bronze window & door systems.

SEE OUR AD ON PAGE 5, 66.

Visit  
**TraditionalBuilding.com**  
today for web exclusives  
like blogs by industry  
leaders & experts.



**INNERGLASS WINDOW SYSTEMS**  
800-743-6207; Fax: 860-651-4789  
www.stormwindows.com  
Simsbury, CT 06070

Manufacturer of custom glass interior storm windows for energy conservation & soundproofing: out performs almost any replacement; automatically conforms to the opening, compensating for out-of-square conditions; no sub-frame needed; all glazing options available; easy do-it-yourself installation.

SEE OUR AD ON PAGE 65.

To see larger photos and informational captions, visit [traditionalbuilding.com/page/the-magazine](http://traditionalbuilding.com/page/the-magazine)

Scroll down and click on the **Buying Guides link**

Precision-Milled Oak & Douglas Fir **TIMBERS**



**ALL TIMBERS GRADE-CERTIFIED**

- White Oak up to 40'
- Douglas Fir up to 50'  
*Dense & Free of Heart Center*

CALL FOR FREE TIMBER PRICE LIST: 419-368-0008  
FAX TIMBER LIST FOR FREE QUOTES: 419-368-6080



552 SR 95, LOUDONVILLE, OH 44842



# HISTORICAL PRODUCTS SHOWCASE



**NIKO CONTRACTING CO., INC.**  
412-687-1517; Fax: 412-687-7969  
www.nikocontracting.com  
Pittsburgh, PA 15213

Custom fabricator & contractor of sheet metal & roofing: slate, tile & other roofing; storefronts, cornices, cupolas, domes, steeples, snow guards & leader heads; copper, lead-coated copper, zinc & stainless steel; metal ceilings.

SEE OUR AD ON PAGE 10.

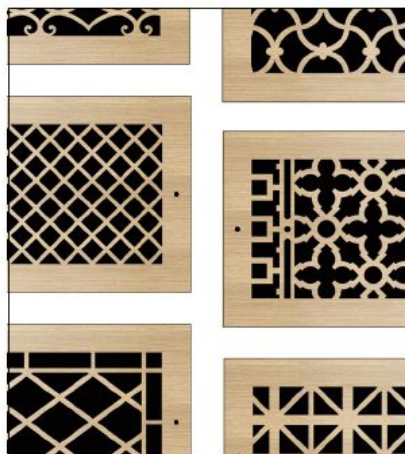

**PACIFIC REGISTER COMPANY**  
805-487-7500  
www.pacificregisterco.com  
Oxnard, CA 93033

Manufacturer of registers: metal, wood & stone; many historic styles; accessories.

SEE OUR AD ON PAGE 21.

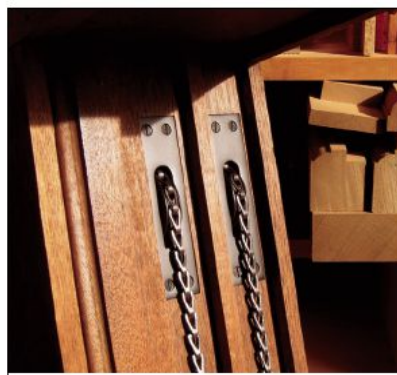

**PHELPS COMPANY**  
603-336-6213; Fax: 603-336-6085  
www.phelpscompany.com  
Hinsdale, NH 03451

Manufacturer of traditional hot-forged solid-brass window hardware: sash pulleys, weights, chains, lifts & locks; stop-bead adjusters, spring bolts, window ventilation locks, push-out casement hardware, storm/screen-door latch sets & more.

SEE OUR AD ON PAGE 21.

To see larger photos and informational captions, visit [traditionalbuilding.com/page/the-magazine](http://traditionalbuilding.com/page/the-magazine)

Scroll down and click on the **Buying Guides** link

## YALE UNIVERSITY - NEW HAVEN, CT

Rohlf's Studio is proud to have been entrusted with the restoration and replication of over 40,000 stained and leaded glass windows at Yale, as depicted in the various buildings shown. Our expertise and longevity for nearly 100 years are your assurance of our professional ability to service your every need.



OSBORN MEMORIAL LABORATORIES

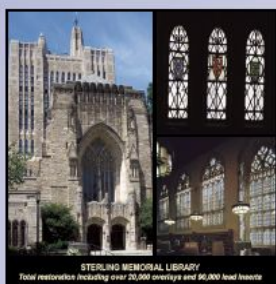

STERLING MEMORIAL LIBRARY  
Total restoration including over 20,000 overlays and 40,000 lead beads



TRUMBULL COLLEGE



BRANFORD / BAYBROOK  
Over 7,000 windows



NEW RESIDENTIAL COLLEGES AT YALE  
Approximately 4,300 new leaded glass windows using Polish restoration glass and heavy custom muntins

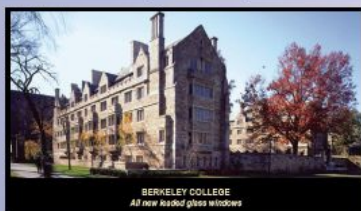

BERKELEY COLLEGE  
All new leaded glass windows

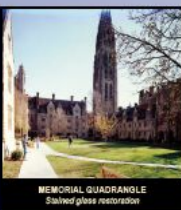

MEMORIAL QUADRANGLE  
Stained glass restoration

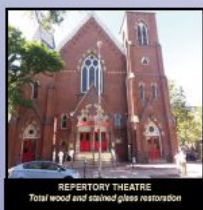

REPERTORY THEATRE  
Total wood and stained glass restoration

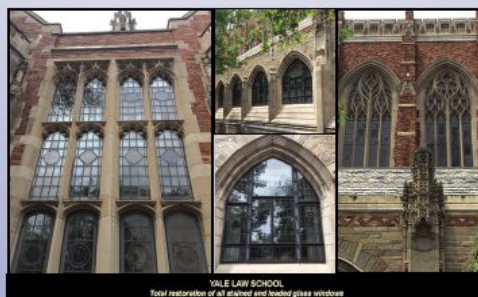

YALE LAW SCHOOL  
Total restoration of all stained and leaded glass windows

"Rohlf's - A stained glass tradition like no other since 1920."  
We are dedicated to the principles and traditions of Old-World Craftsmanship.

Rohlf's Stained & Leaded Glass Studio, Inc. • 783 South Third Ave., Mount Vernon, NY 10550 • 914-699-4848  
Email: [rsg@rohlfstudio.com](mailto:rsg@rohlfstudio.com) • Kindly visit our website at [rohlfstudio.com](http://rohlfstudio.com) for our full range of services.



Fresh Air Photo

**HOPE'S**  
Windows, Inc.

THE WORLD'S FINEST  
WINDOWS AND DOORS  
SINCE 1912

See our full page  
ad on page 5.



[www.VintageDoors.com](http://www.VintageDoors.com) — See Ad on Back Cover »





If you'd like to order a **GIFT** subscription for a colleague, just call 800-548-0148

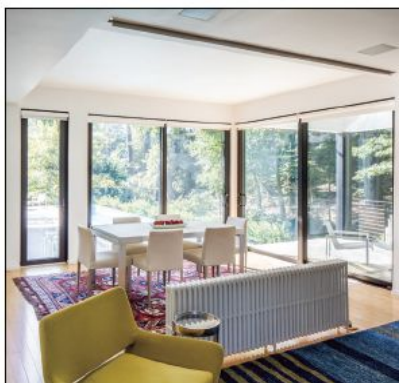

**ST. CLOUD WINDOW, INC.**  
800-383-9311; Fax: 320-255-1513  
[www.stcloudwindow.com](http://www.stcloudwindow.com)  
Sauk Rapids, MN 56379  
Manufacturer of aluminum windows for heavy commercial & architectural replacement: dual windows for acoustical abatement; screens, metal windows & doors.



**TIMBERLANE, INC.**  
215-616-0600; Fax: 215-616-0749  
[www.timbertlane.com](http://www.timbertlane.com)  
Montgomeryville, PA 18936  
Manufacturer of custom exterior shutters: more than 40 historically accurate, customizable styles; available in premium woods & our own maintenance-free Endurian, along with the large selection of period shutter hardware.  
**SEE OUR AD ON INSIDE FRONT COVER, 64.**



## ARCHITECTURAL COMPONENTS

*Finely Crafted Reproduction and Custom Windows, Doors & Architectural Millwork*  
413-367-9441  
[architecturalcomponentsinc.com](http://architecturalcomponentsinc.com)



**VINTAGE DOORS**  
800-787-2001; Fax: 315-324-6531  
[www.vintagedoors.com](http://www.vintagedoors.com)  
Hammond, NY 13646  
Manufacturer of custom exterior & interior wood doors: door hardware, screen doors & storm doors; traditional, Craftsman & Victorian Styles; solid wood & glass panels available.  
**SEE OUR AD ON PAGE 66, BACK COVER.**



**VINTAGE HARDWARE & LIGHTING**  
360-379-9030; Fax: 360-379-9029  
[www.vintagehardware.com](http://www.vintagehardware.com)  
Port Townsend, WA 98368  
Supplier of door hardware, window hardware: window locks & sash lifts; drapery hardware; bathroom accessories; reproduction lighting; weather vanes.  
**SEE OUR AD ON PAGE 21.**

**WHEN CONTACTING COMPANIES YOU'VE SEEN IN THIS ISSUE, PLEASE TELL THEM YOU SAW THEM IN TRADITIONAL BUILDING MAGAZINE.**



See our ad on page 3

(800) 278-3667

[ArtisticDoorsAndWindows.com](http://ArtisticDoorsAndWindows.com)

**E. R. BUTLER & Co.**

MANUFACTURERS

*See Our Ad  
On the Inside Back Cover*

[WWW.ERBUTLER.COM](http://WWW.ERBUTLER.COM)

**ARCHITECTURAL GRILLE**  
CUSTOM DESIGNED, FABRICATED AND FINISHED

**SPACKLE IN J-FRAME BAR GRILLE**

**TO ORDER:**  
1.800.387.6267  
P: 718.832.1200  
F: 718.832.1390  
[ARCHGRILLE.COM](http://ARCHGRILLE.COM)

**INDUSTRY LEADER IN ARCHITECTURAL GRILLES**



# GREENHOUSES, GAZEBOS & OUTBUILDINGS

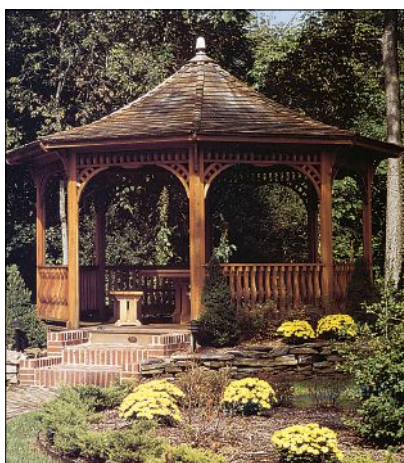

**DALTON PAVILIONS, INC.**  
800-532-5866; Fax: 215-721-1501  
[www.daltonpavilions.com](http://www.daltonpavilions.com)  
Telford, PA 18969

Manufacturer of pavilions & gazebos: western red cedar; prefabricated for ease of installation; ships internationally.



**HARTLEY BOTANIC INC.**  
781-933-1993; Fax: 781-933-1992  
[www.hartleybotanic.com](http://www.hartleybotanic.com)  
Woburn, MA 01801

Hartley Botanic is one of England's oldest greenhouse manufacturers. Every greenhouse is handmade to order for delivery worldwide. They offer a 30 Year 'Lifetime' Guarantee on their greenhouses. They are the Royal Horticultural Society's recommended aluminum Greenhouse supplier.

SEE OUR AD ON PAGE 69.



**HISTORIC SHED**  
813-333-2249; Fax: 813-333-1420  
[www.historicshed.com](http://www.historicshed.com)  
Brooksville, FL 34601

Manufacturer of outbuildings: garden & pool houses, storage sheds, garages; screen doors; lattice & more.



**HISTORICAL ARTS & CASTING**  
800-225-1414; Fax: 801-280-2493  
[www.historicalarts.com](http://www.historicalarts.com)  
West Jordan, UT 84081

Designer & custom fabricator of ornamental metalwork: doors, windows, hardware, stairs, balustrades, registers, fences, lighting, gutters, columns, weathervanes, snow guards, cupolas, planters, fireplace tools & more; iron, bronze, aluminum & steel; restoration services.

SEE OUR AD ON PAGE 19.



**OAK LEAF CONSERVATORIES**  
800-360-6283; Fax: 404-250-6283  
[www.oakleafconservatories.com](http://www.oakleafconservatories.com)  
Atlanta, GA 30327

Designer, custom fabricator & installer of authentic British conservatories, orangeries, garden rooms, pool/spa enclosures & glass domes: handcrafted in England; mortise-&-tenon construction; premium-grade mahogany & double glazing.

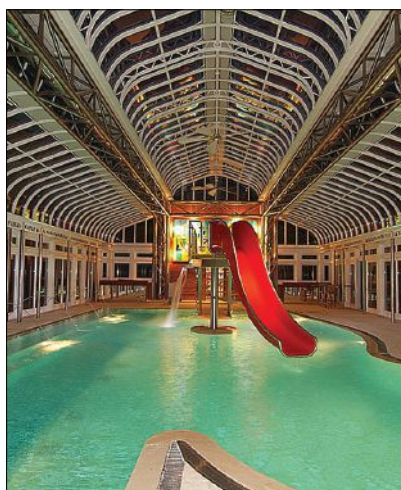

**PARISH CONSERVATORIES**  
800-761-9183  
[www.parishconservatories.com](http://www.parishconservatories.com)  
Bridgeport, CT 06608

Importer of English conservatories, skylights, orangeries & pool houses; custom design.



**POLIGON BY PORTERCORP.**  
616-888-3500; Fax: 616-399-9123  
[www.portercorp.com](http://www.portercorp.com)  
Holland, MI 49424

Manufacturer of pre-engineered, bolted tubular-steel gazebos, shelters, pavilions & enclosed structures: for parks, gardens, streetscapes, benches, courtyards & recreational facilities



**ROBINSON IRON CORP.**  
800-824-2157; Fax: 256-329-8960  
[www.robinsoniron.com](http://www.robinsoniron.com)  
Alexander City, AL 35010

Designer & installer of custom metalwork: fountains, columns, fences, doors, railings, sculpture, benches, grilles, cresting, street lighting & gazebos; wrought iron/steel, aluminum, bronze & cast iron; historical restoration.

SEE OUR AD ON PAGE 11, 72.



**TOWN & COUNTRY CONSERVATORIES**  
773-281-1212; Fax: 773-281-2234  
[www.townandcountryus.com](http://www.townandcountryus.com)  
Chicago, IL 60659

Designer & builder of high quality custom English conservatories, orangeries, garden houses, greenhouses, roof lanterns (skylights) & swimming pool enclosures: in premium hardwood or extruded aluminum.

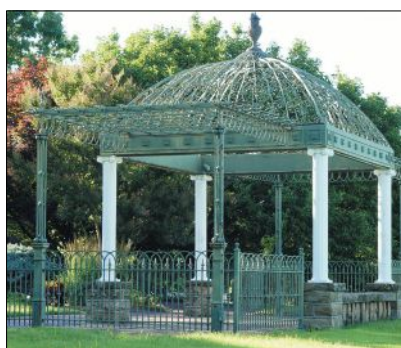

**WIEMANN METALCRAFT**  
918-592-1700; Fax: 918-592-2385  
[www.wmcraft.com](http://www.wmcraft.com)  
Tulsa, OK 74107

Designer, fabricator, finisher & installer of fine quality custom ornamental metalwork: railings, fences, gates, custom, hot-rolled steel doors & windows, lighting, grilles, bronze & aluminum entry doors; all cast- & wrought-metal alloys, finishes & architectural styles; since 1940.

SEE OUR AD ON PAGE 73.

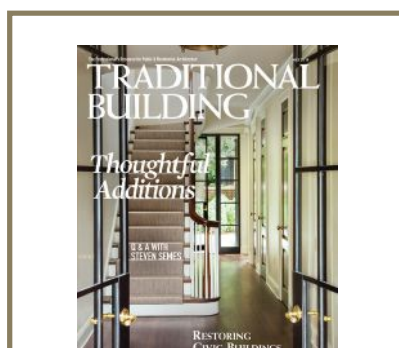

If you'd like to order a

**GIFT**  
subscription  
for a colleague,  
just call  
800-548-0148

To see larger photos and informational captions, visit [traditionalbuilding.com/page/the-magazine](http://traditionalbuilding.com/page/the-magazine)

Scroll down and click on the **Buying Guides link**



HARTLEY  BOTANIC

HANDMADE WITH PRIDE SINCE 1938

# THE FINEST GREENHOUSES MONEY CAN BUY



Bespoke Victorian Glasshouse, Wyoming, USA

For seasonal offers please call 781 933 1993 or visit [www.hartley-botanic.com](http://www.hartley-botanic.com)



## NOTHING ELSE IS A HARTLEY

The only aluminium Glasshouses and Greenhouses endorsed by the RHS



© The Royal Horticultural Society 2018 Endorsed by the Royal Horticultural Society. Registered Charity No 222879/SC038262 rhs.org.uk



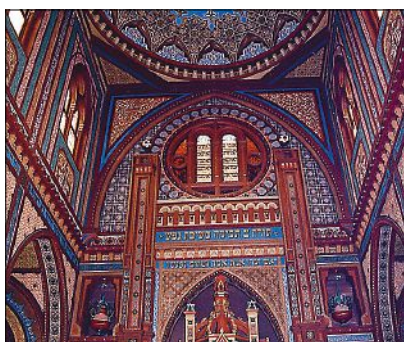

**EVERGREENE ARCHITECTURAL ARTS**  
212-244-2800; Fax: 212-244-6204  
[www.evergreene.com](http://www.evergreene.com)  
Brooklyn, NY 11232

Decorative-arts studio: murals, decorative painting, gilding, plaster, wood, metal, stone & mosaics; new design, conservation & restoration; ecclesiastical, institutional, public & commercial projects; offices in NYC & Chicago.

SEE OUR AD ON PAGE 8.



**HISTORICAL ARTS & CASTING**  
800-225-1414; Fax: 801-280-2493  
[www.historicalarts.com](http://www.historicalarts.com)  
West Jordan, UT 84081

Designer & custom fabricator of ornamental metalwork: doors, windows, hardware, stairs, balustrades, registers, fences, lighting, gutters, columns, weather-vanes, snow guards, cupolas, planters, fireplace tools & more; iron, bronze, aluminum & steel; restoration services.

SEE OUR AD ON PAGE 19.



**JOHN CANNING CONSERVATION & PAINTING STUDIOS**  
203-272-9868; Fax: 203-272-9879  
[www.JohnCanningCo.com](http://www.JohnCanningCo.com)  
Cheshire, CT 06410

Restorer, conservator & designer of decorative finishes, ornamental plaster & wood; historic paint analysis; plaster consolidation & stabilization; decorative paint, murals, interior & exterior gilding, wood graining, metal & stone cleaning.

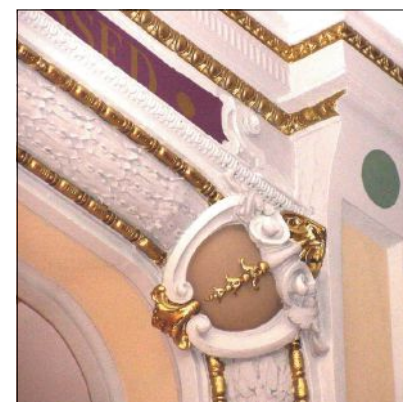

**JOHN TIEDEMANN, INC.**  
877-600-2666; Fax: 201-991-3419  
[www.johntiedemann.com](http://www.johntiedemann.com)  
North Arlington, NJ 07031

Restorer of interior elements: interior painting & design, liturgical renderings, decorative granite flooring, faux finishes, murals & frescoes, gilding, art glass, fine art, paint & plaster analysis, historic analysis & testing.



**KREILICK CONSERVATION LLC**  
215-572-6616  
[www.kreilickconservation.com](http://www.kreilickconservation.com)  
Oreland, PA 19075

Founded in 1996, provides laboratory and field analysis of materials, condition assessments, emergency response and stabilization, treatment, documentation, and maintenance of metallic and masonry architectural elements, monuments, sculpture, and objects.



**KRONENBERGER & SONS RESTORATION**  
860-347-4600; Fax: 860-343-0309  
[www.kronenbergersons.com](http://www.kronenbergersons.com)  
Middletown, CT 06457

Contractor for interior & exterior restoration: all types of finishes; post-&-beam construction; windows, molding & roofing; masonry & wood; museums, churches, town halls, libraries, barns, period homes & outbuildings.



**R. ALDEN MARSHALL & ASSOCIATES LLC**  
717-805-3114  
[www.raldenmarshall.com](http://www.raldenmarshall.com)  
Galveston, TX 77551

A material science laboratory & preservation studio for the conservation of art & architecture including monuments, sculptures, paintings & murals; much more, Projects include national historic sites as well as ecclesiastical commissions.



**ROBINSON IRON CORP.**  
800-824-2157; Fax: 256-329-8960  
[www.robinsoniron.com](http://www.robinsoniron.com)  
Alexander City, AL 35010

Designer & installer of custom metalwork: fountains, columns, fences, doors, railings, sculpture, benches, grilles, cresting, street lighting & gazebos; wrought iron/steel, aluminum, bronze & cast iron; historical restoration.

SEE OUR AD ON PAGE 11, 72.

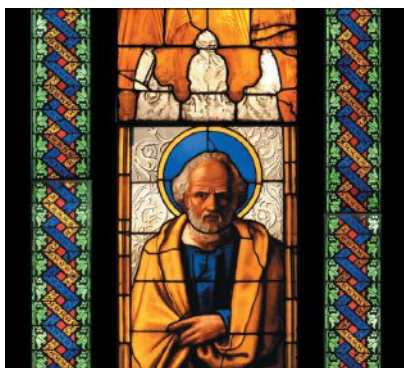

**ROHLF'S STAINED & LEADED GLASS STUDIO**  
914-699-4848; Fax: 914-699-7091  
[www.rohlfstudio.com](http://www.rohlfstudio.com)  
Mount Vernon, NY 10550

Designer, fabricator & installer of new stained & leaded glass: restoration & replication; protective glazing; beveled, carved & fused/slumped glass; steel casement retrofitting; mosaics; established in 1920.

SEE OUR AD ON PAGE 66.



**VINTAGE MILLWORK AND RESTORATION**  
717-687-0292; Fax: 717-687-3510  
[www.vintagemillworkrestoration.com](http://www.vintagemillworkrestoration.com)  
Paradise, PA 17562

Offers custom-milled front doors, interior doors, garage doors, barn doors, and custom hardware. Specialties include custom trim work, custom grid doors, true or simulated divide light doors, and engineered doors. Made in the USA in Lancaster, PA.

**LIVE TUESDAY, JUNE 25, 2PM ET**  
**ON-DEMAND VERSION TO FOLLOW**

**WINDOWS AND HISTORIC HOMES:  
REPAIR, REPLACE AND NEW ADDITIONS**  
*1 AIA HSW Learning Unit*

**Speaker:**  
Charles "Chick" McBrien, Marvin Windows and Doors

**TRADITIONALBUILDINGSHOW.COM**

See p. 29 for more





**ABATRON, INC.**  
800-445-1754; Fax: 262-653-2019  
[www.abatron.com](http://www.abatron.com)  
Kenosha, WI 53144

Manufacturer of products for restoration & repair: wood consolidation & repair, window & door restoration, concrete patching & resurfacing, metal restoration, moldmaking & casting, structural adhesives, protective coatings, strippers & related products.

SEE OUR AD ON PAGE 71.



**POLYMERIC SYSTEMS — WOOD RESTORATION**  
610-286-2500; Fax: 610-286-2510  
[www.polymericystems.com](http://www.polymericystems.com)  
Elverson, PA 19520

Manufacturer of Quikwood: a hand-mixable epoxy putty for wood repairs in minutes; can also be used for bonding wood to wood & other materials; epoxies to repair metal & masonry.



**PRESERVATION PRODUCTS**  
800-553-0523; Fax: 610-891-0834  
[www.preservationproducts.com](http://www.preservationproducts.com)  
Media, PA 19063

Manufacturer & distributor of Acrymax restoration & preservation systems for historic metal roofs: durable weatherproof membrane can be used as complete roof system or for repair; Acrymax is an energy star partner.

SEE OUR AD ON PAGE 71.

**PRESERVATION PRODUCTS, INC.**  
*Protecting America's heritage, one landmark at a time.*



**Acrymax®**  
High Performance  
Coating Systems

Weatherproof Protection



**Proven Solutions**

800-553-0523  
[preservationproducts.com](http://preservationproducts.com)



**PROTECTIVE COATING COMPANY**  
800-220-2103; Fax: 610-432-5043  
[www.pcepoxy.com](http://www.pcepoxy.com)  
Allentown, PA 18102

Manufacturer of solvent-free wood-restoration products: to repair & rebuild superficial to severe wood rot; paste epoxies & putty epoxies for repair of wood, concrete, metal, ceramic & more.



# Restoration & Maintenance Products

## Solutions for your toughest projects

- Wood
- Concrete
- Metal
- Plaster
- Stone
- Porcelain



**Free Catalog**  
1-800-445-1754  
[www.abatron.com](http://www.abatron.com)

**VISIT US AT THE AIA SHOW — BOOTH #5216**



# LANDSCAPE & GARDEN SPECIALTIES



**AZTEC STONE EMPIRE**  
770-368-9337; Fax: 770-368-9336  
[www.aztecstoneempire.com](http://www.aztecstoneempire.com)  
Norcross, GA 30071

Large inventory including Tennessee fieldstone; Pennsylvania bluestone; boulders; river stone; a wide variety of stack stone; granite; rubble (cut to size); cast stone; concrete pavers; slabs; cobblestones; stone veneer; artificial stone; masonry supplies and more.

SEE OUR AD ON PAGE 7, 72.



**BOARDS AND BEAMS**  
973-299-6100  
[www.woodboardsandbeams.com](http://www.woodboardsandbeams.com)  
Fairfield, NJ 07004

Manufacturer & supplier of wood flooring: wide board, random width, antique, hardwood strip; arbors; pergolas; mantels; timber, timber frames & trusses.



**BRATTLEWORKS**  
978-410-5078; Fax: 978-730-8026  
[www.brattleworks.com](http://www.brattleworks.com)  
Gardner, MA 01440

Manufacturer of arbors, pergolas, fences, gates, planters & trellage.



**CHADSWORTH COLUMNS**  
910-763-7600; Fax: 910-763-3191  
[www.columns.com](http://www.columns.com)  
Wilmington, NC 28401

Manufacturer of authentically correct architectural columns: complete line of columns, piers, pilasters & posts for interior & exterior use; variety of sizes, styles & materials, including wood; more than 20 years.

SEE OUR AD ON PAGE 1, 72.



**HERITAGE METALWORKS**  
610-518-3999; Fax: 610-518-7264  
[www.hmwp.com](http://www.hmwp.com)  
Downingtown, PA 19335

Foundry, blacksmith shop and custom metal fabricator offering historically accurate and custom-designed lighting, architectural hardware, and designer-envisioned metalwork including interior and exterior gates & railings.

SEE OUR AD ON PAGE 19.



**HISTORICAL ARTS & CASTING**  
800-225-1414; Fax: 801-280-2493  
[www.historicalarts.com](http://www.historicalarts.com)  
West Jordan, UT 84081

Designer & custom fabricator of ornamental metalwork: doors, windows, hardware, stairs, balustrades, registers, fences, lighting, gutters, columns, weathervanes, snow guards, cupolas, planters, fireplace tools & more; iron, bronze, aluminum & steel; restoration services.

SEE OUR AD ON PAGE 19.



**KING ARCHITECTURAL METALS**  
800-542-2379; Fax: 800-948-5558  
[www.kingmetals.com](http://www.kingmetals.com)  
Dallas, TX 75228

Wholesale supplier of ornamental & architectural metal components: staircases, handrails, gates, fences, furniture, mailboxes, lampposts, finials & fireplace screens; wrought iron & aluminum.

SEE OUR AD ON PAGE 2, 72.



**OLD WORLD STONE LTD.**  
800-281-9615; 905-332-5547;  
Fax: 905-332-6068  
[www.oldworldstone.com](http://www.oldworldstone.com)  
Burlington, ON L7L 4Y1 Canada

Supplier of dimensional-cut limestone & sandstone: columns, sculpture, mantels, architectural ornament, signage & garden ornament for new & restoration projects.

SEE OUR AD ON PAGE 79.



SEE OUR AD ON PAGE 7

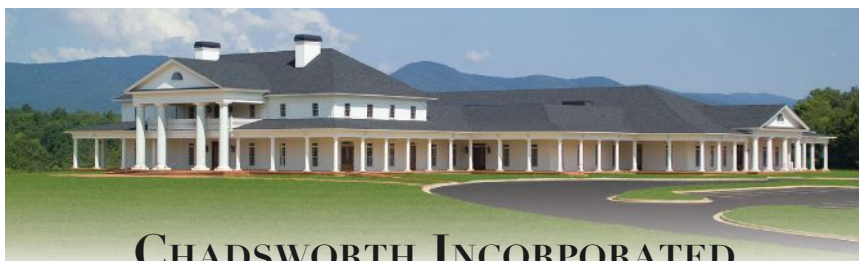

**CHADSWORTH INCORPORATED**

See our Ad on Page 1

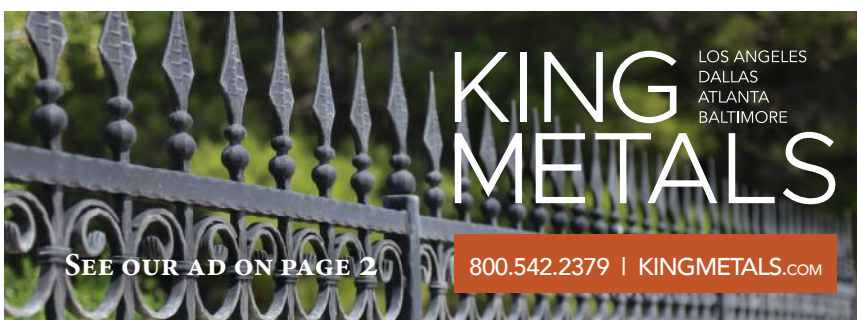

SEE OUR AD ON PAGE 2

800.542.2379 | [KINGMETALS.COM](http://KINGMETALS.COM)



[robinsoniron.com](http://robinsoniron.com) • PLEASE SEE OUR AD ON PAGE 11





**ROBINSON IRON CORP.**  
800-824-2157; Fax: 256-329-8960  
[www.robsoniron.com](http://www.robsoniron.com)  
Alexander City, AL 35010

Designer & installer of custom metalwork: fountains, columns, fences, doors, railings, sculpture, benches, grilles, cresting, street lighting & gazebos; wrought iron/steel, aluminum, bronze & cast iron; historical restoration.

SEE OUR AD ON PAGE 11, 72.



**TRELLIS STRUCTURES, INC.**  
888-285-4624; Fax: 978-630-8725  
[www.trellisstructures.com](http://www.trellisstructures.com)  
E. Templeton, MA 01438

Manufacturer of pergolas, arbors, trellises, gates & garden structures: traditional to contemporary designs; western red cedar with stainless steel fastenings; stock & custom.



**WAYSIDE FENCE CO.**  
800-847-7789; Fax: 631-968-6928  
[www.waysidefence.com](http://www.waysidefence.com)  
Bay Shore, NY 11706

Manufacturer & supplier of fencing products: custom wood & PVC fencing, arbors, pergolas, gates, deck rails, stair rails, posts, caps, finials, post sleeves, Delgard aluminum ornamental estate fence, pool fence, deer fencing & more.

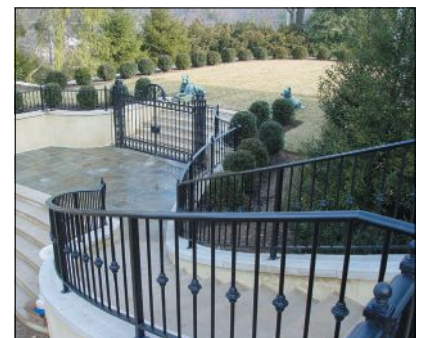

**WIEMANN METALCRAFT**  
918-592-1700; Fax: 918-592-2385  
[www.wmcraft.com](http://www.wmcraft.com)  
Tulsa, OK 74107

Designer, fabricator, finisher & installer of fine quality custom ornamental metalwork: railings, fences, gates, custom, hot-rolled steel doors & windows, lighting, grilles, bronze & aluminum entry doors; all cast- & wrought-metal alloys, finishes & architectural styles; since 1940.

SEE OUR AD ON PAGE 73.

To see larger photos and informational captions, visit [traditionalbuilding.com/page/the-magazine](http://traditionalbuilding.com/page/the-magazine)

Scroll down and click on the Buying Guides link

WHEN CONTACTING COMPANIES YOU'VE SEEN IN THIS ISSUE, PLEASE TELL THEM YOU SAW THEM IN TRADITIONAL BUILDING MAGAZINE.



## JUMP IN THE CONVERSATION

@PeriodHomes

@TradBuilding

@TradBldgShow

Join us on Twitter for news and views about the world of traditional building and design.

At Wiemann Metalcraft, we've stood by our word for over 79 years. So when we tell you we can handle a seemingly impossible job, you can believe it. Simply put, when others can't,

**WIEMANN CAN.**



WIEMANN  
METALCRAFT

639 West 41st Street, Tulsa, Oklahoma 74107 Phone (918)592-1700 Fax (918)592-2385 Email [sales@wmcraft.com](mailto:sales@wmcraft.com)

The Forged Iron Equivalent of

A  
Firm  
Handshake.



# WINDOW RESTORATION & REPAIR

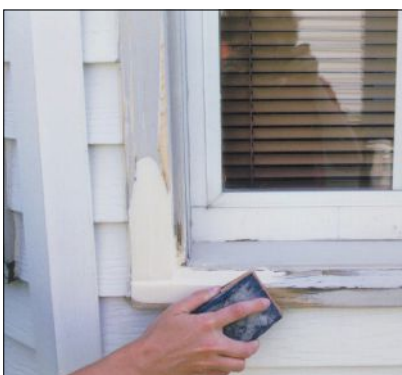

**ABATRON, INC.**  
800-445-1754; Fax: 262-653-2019  
[www.abatron.com](http://www.abatron.com)  
Kenosha, WI 53144

Manufacturer of products for restoration & repair: wood consolidation & repair, window & door restoration, concrete patching & resurfacing, metal restoration, moldmaking & casting, structural adhesives, protective coatings, strippers & related products.

SEE OUR AD ON PAGE 71.

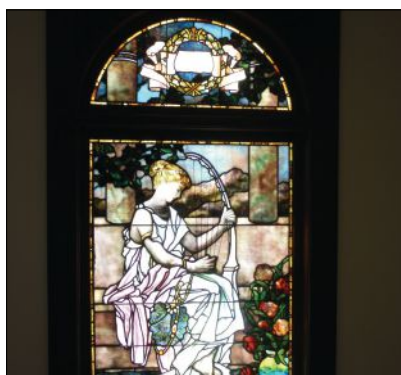

**ALLEGHENY RESTORATION & BUILDERS**  
304-381-4820; Fax: 304-381-4825  
[www.alleghenyrestoration.com](http://www.alleghenyrestoration.com)  
Morgantown, WV 26508

Manufacturer of reproduction & custom wood doors & windows: window replication, restoration & repair; art glass; hardware replacement; storefronts & ecclesiastical projects; 15 years of experience; nationwide.



**AMERICAN HERITAGE WINDOW REBUILDERS**  
801-359-6639

[www.vintagewindows.com](http://www.vintagewindows.com)  
Salt Lake City, UT 84111

Historically correct wood-window restoration and thermal upgrading for a true, traditional look, feel, and life span.

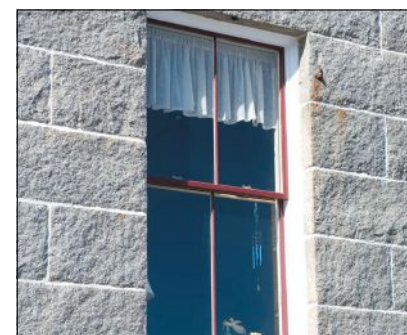

**ARCHITECTURAL COMPONENTS, INC.**

413-367-9441; Fax: 413-367-9461  
[www.architecturalcomponentsinc.com](http://www.architecturalcomponentsinc.com)  
Montague, MA 01351

Manufacturer of reproduction & custom wood windows & doors: true-divided lites with insulated glass; wood-framed storm sash & screens; renovation & restoration projects & new construction; paneled walls & storefronts; catalog \$5.

SEE OUR AD ON PAGE 67.

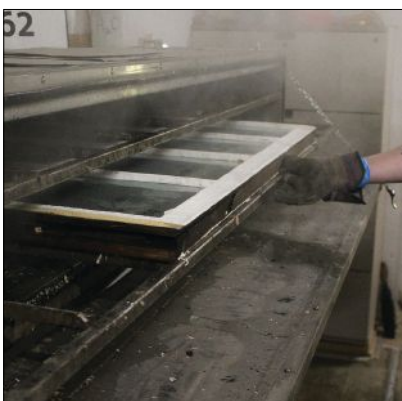

**BAGALA WINDOW WORKS**  
207-887-9231

[www.bagalawindowworks.com](http://www.bagalawindowworks.com)  
Westbrook, ME 04092

Restorer of wood windows & doors: any shape; antique glass; improved energy efficiency with metal interlocking weatherstrip systems; historically sensitive storm windows; innovators of steam stripping for window restoration.



**CRAFTSMEN GROUP, THE**  
301-277-3700; Fax: 301-277-4700  
[www.thecraftsmengroup.com](http://www.thecraftsmengroup.com)  
Brentwood, MD 20722

Fabricator & restorer of architectural millwork: doors, windows, glazing, furniture, hardware restoration; domestic hardwoods, imported mahogany & teak.



**GREEN MOUNTAIN INSULATED GLASS**

802-772-4394; Fax: 802-776-4153  
[www.greenmtinsulatedglass.com](http://www.greenmtinsulatedglass.com)  
Rutland, VT 05701

Handcrafted small lite, narrow sightline insulated glass units, with either warm edge or aluminum spacer; specializing in: restoration/historical wavy glass, custom laminated glass, most regular & specialty glasses, shapes/patterns, Low-e IG units & monolithic glass cut-to-size.

SEE OUR AD ON PAGE 74.

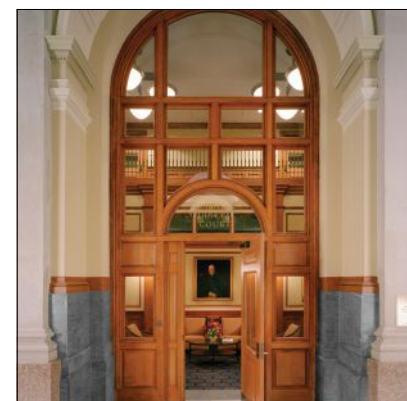

**M&A ARCHITECTURAL PRESERVATION**

978-683-0880; Fax: 978-683-8370  
[www.archpres.com](http://www.archpres.com)  
Lawrence, MA 01843

Restorer of wood windows and doors: reglazing with antique restoration glass; monumental & tower windows; new custom wood windows and doors; building condition surveys.

**GREEN MOUNTAIN INSULATED GLASS**  
Incorporated

We produce the highest quality custom small lite, narrow sightline insulated glass units in the industry. We back our products with a full 10 year seal failure warranty.

**(802) 772-4394**  
10 Ripley Rd. Rutland, VT 05701 | [www.greenmtinsulatedglass.com](http://www.greenmtinsulatedglass.com)



**ROHLF'S STAINED & LEADED GLASS STUDIO**

914-699-4848; Fax: 914-699-7091  
[www.rohlfstudio.com](http://www.rohlfstudio.com)  
Mount Vernon, NY 10550

Designer, fabricator & installer of new stained & leaded glass: restoration & replication; protective glazing; beveled, carved & fused/slumped glass; steel casement retrofitting; mosaics; established in 1920.

SEE OUR AD ON PAGE 66.



**SEEKIRCHER STEEL WINDOW CORP.**

914-734-8004; Fax: 914-734-8009  
[www.seekirchersteelwindow.com](http://www.seekirchersteelwindow.com)  
Peekskill, NY 10566

Repair & restoration of steel casement windows & doors: work done in place and off site; large selection of vintage steel windows & doors for sale; restored windows & doors at Fallingwater & countless other landmarks.





**AMERICAN GAS LAMP WORKS**  
724-274-7131  
[www.americangaslamp.com](http://www.americangaslamp.com)  
Springdale, PA 15144

Manufacturers of foundry-cast natural gas & faux gas lighting; specializing in commercial-grade, foundry-cast lamps that provide Old World charm & enduring quality for buildings, homes & outdoor spaces; handcrafted in the US from sand-cast aluminum & heavy-gauge copper components.



**BALL & BALL LIGHTING**  
610-363-7330; Fax: 610-363-7639  
[www.ballandball.com](http://www.ballandball.com)  
Exton, PA 19341

Fabricator of historical lighting: chandeliers, sconces, pendants, lanterns & table lamps; Early American & Turn of the Century styles; antique & salvaged originals, new designs, custom work & reproductions; stair handrails; restoration services.

SEE OUR AD ON PAGE 75.



Open flame burning is an optional light source available in most of our fixture designs or custom made to match your own design. We offer an electronic ignition option for gas burning lanterns, which can be configured to run dusk to dawn. These igniters also have a feature that will relight the flame if it gets blown out by high winds. Ignition systems are proudly US made.

Ball and Ball continues to create authentic reproductions of period designs using period fabrication techniques and superior craftsmanship. We have over 65 years of experience fabricating reproductions of lighting fixtures.



EXTON, PENNSYLVANIA

1.800.257.3711

[WWW.BALLANDBALL.COM](http://WWW.BALLANDBALL.COM)



**CHARLESTON LIGHTING & MFG., INC.**  
800-661-9224; Fax: 251-471-5945  
[www.charlestonlighting.com](http://www.charlestonlighting.com)  
Mobile, AL 36607

Manufacturer of handmade copper lanterns: natural gas, propane & electric models; automatic gas-ignition systems; unique cast-aluminum lampposts for residential & street lighting applications; mailboxes.



**DEEP LANDING WORKSHOP**  
877-778-4042; Fax: 410-778-4070  
[www.deeplandingworkshop.com](http://www.deeplandingworkshop.com)  
Chestertown, MD 21620

Manufacturer of custom lighting fixtures: chandeliers, sconces, pendants & lanterns; new designs, historic reproductions & custom work; handcrafted in wood, tin, brass or copper; glass, mica or alabaster shades.

SEE OUR AD ON PAGE 75.

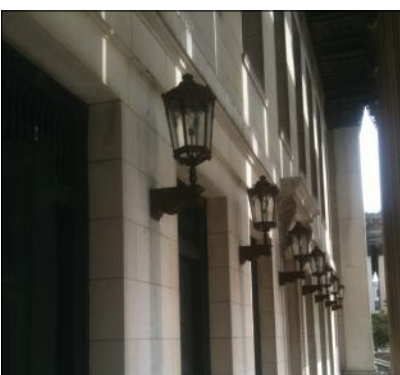

**GRAND LIGHT**  
800-922-1469; Fax: 203-828-6307  
[www.grandlight.com](http://www.grandlight.com)  
Seymour, CT 06483

Restorer of historic lighting fixtures & manufacturer of custom lighting fixtures: metal fabrication, glass fabrication, metal finishing, polishing, painting, welding, abrasive blasting; historical replication & reproduction.

SEE OUR AD ON PAGE 76.



**HERITAGE METALWORKS**  
610-518-3999; Fax: 610-518-7264  
[www.hmwp.com](http://www.hmwp.com)  
Downingtown, PA 19335

Foundry, blacksmith shop and custom metal fabricator offering historically accurate and custom-designed lighting, architectural hardware, and designer-envisioned metalwork including interior and exterior gates & railings.

SEE OUR AD ON PAGE 19.



*ELEGANCE IN CUSTOM LIGHTING*

**DEEP LANDING WORKSHOP**

115 Deep Landing Rd  
Chestertown, MD 21620  
877-778-4042  
410-778-4042  
410-778-4070 fax  
[www.deeplandingworkshop.com](http://www.deeplandingworkshop.com)  
[deeplandingworkshop@gmail.com](mailto:deeplandingworkshop@gmail.com)







**St. Louis  
Antique  
Lighting Co.**

SEE OUR AD ON PAGE 4



# EXTERIOR LIGHTING & GAS LIGHTING



**HOUSE OF ANTIQUE  
HARDWARE**

888-223-2545; Fax: 503-233-1312  
www.houseofantiquehardware.com  
Portland, OR 97232

Manufacturer & supplier of vintage reproduction door, window, shutter, cabinet & furniture hardware & accessories: Federal, Victorian, Colonial Revival, Craftsman & Deco styles; lighting fixtures, push-button switches & plates; bathroom accessories; registers & grilles.

SEE OUR AD ON PAGE 10.



**LANTERN MASTERS, INC.**

818-706-1990; Fax: 818-706-1988  
www.lanternmasters.com  
Westlake Village, CA 91362

Custom designer & manufacturer of lighting: interior chandeliers, pendants, ceiling flushes & sconces & exterior lanterns including wall, flush wall, pendant, post & pilaster; many architectural periods; historical reproductions.

SEE OUR AD ON PAGE 77.



**PENNSYLVANIA GLOBE  
GASLIGHT CO.**

203-484-7749; Fax: 203-484-7758  
www.pennnglobe.com

North Branford, CT 06471

Manufactures 'Replica Gaslights' in natural gas and HID; catalog available to the trade. Offers controlled lighting with gaslight charm.



**ROBINSON IRON CORP.**

800-824-2157; Fax: 256-329-8960  
www.robinsoniron.com  
Alexander City, AL 35010

Designer & installer of custom metalwork: fountains, columns, fences, doors, railings, sculpture, benches, grilles, cresting, street lighting & gazebos; wrought iron/steel, aluminum, bronze & cast iron; historical restoration.

SEE OUR AD ON PAGE 11, 72.

*Unsurpassed  
Quality &  
Attention to  
Detail.*



805-962-5119  
stevenhandelmanstudios.com

**Historic Lighting  
Restoration &  
Custom Lighting**



**GRAND LIGHT**

*American Artisans at Work  
Preserving History*

www.Grandlight.com

1-800-922-1469  
Seymour, CT



**ST. LOUIS ANTIQUE  
LIGHTING CO.**

314-863-1414; Fax: 314-863-6702  
www.slalco.com  
Saint Louis, MO 63130

Manufacturer & supplier of architectural lighting: all styles; historical reproductions & custom lighting; restoration services; commercial & ecclesiastical projects.

SEE OUR AD ON PAGE 4, 75.

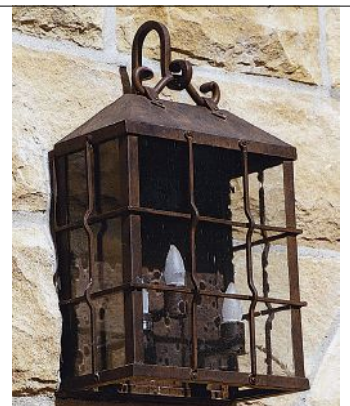

**STEVEN HANDELMAN STUDIOS**

805-962-5119; Fax: 805-966-9529  
www.stevenhandelmanstudios.com  
Santa Barbara, CA 93103

Manufacturer of hand-forged traditional lighting, grilles & fireplace accessories: many types & styles of lighting & grilles; fireplace screens, grates & inserts; historic reproduction & restoration services.

SEE OUR AD ON PAGE 76.



**VINTAGE HARDWARE  
& LIGHTING**

360-379-9030; Fax: 360-379-9029  
www.vintagehardware.com  
Port Townsend, WA 98368

Supplier of door hardware, window hardware: window locks & sash lifts; drapery hardware; bathroom accessories; reproduction lighting; weathervanes.

SEE OUR AD ON PAGE 21.



**WIEMANN METALCRAFT**

918-592-1700; Fax: 918-592-2385  
www.wmcraft.com  
Tulsa, OK 74107

Designer, fabricator, finisher & installer of fine quality custom ornamental metalwork: railings, fences, gates, custom, hot-rolled steel doors & windows, lighting, grilles, bronze & aluminum entry doors; all cast- & wrought-metal alloys, finishes & architectural styles; since 1940.

SEE OUR AD ON PAGE 73.





Manufacturer of Fine Interior, Exterior & Custom Lighting

# LANTERN MASTERS, INC.

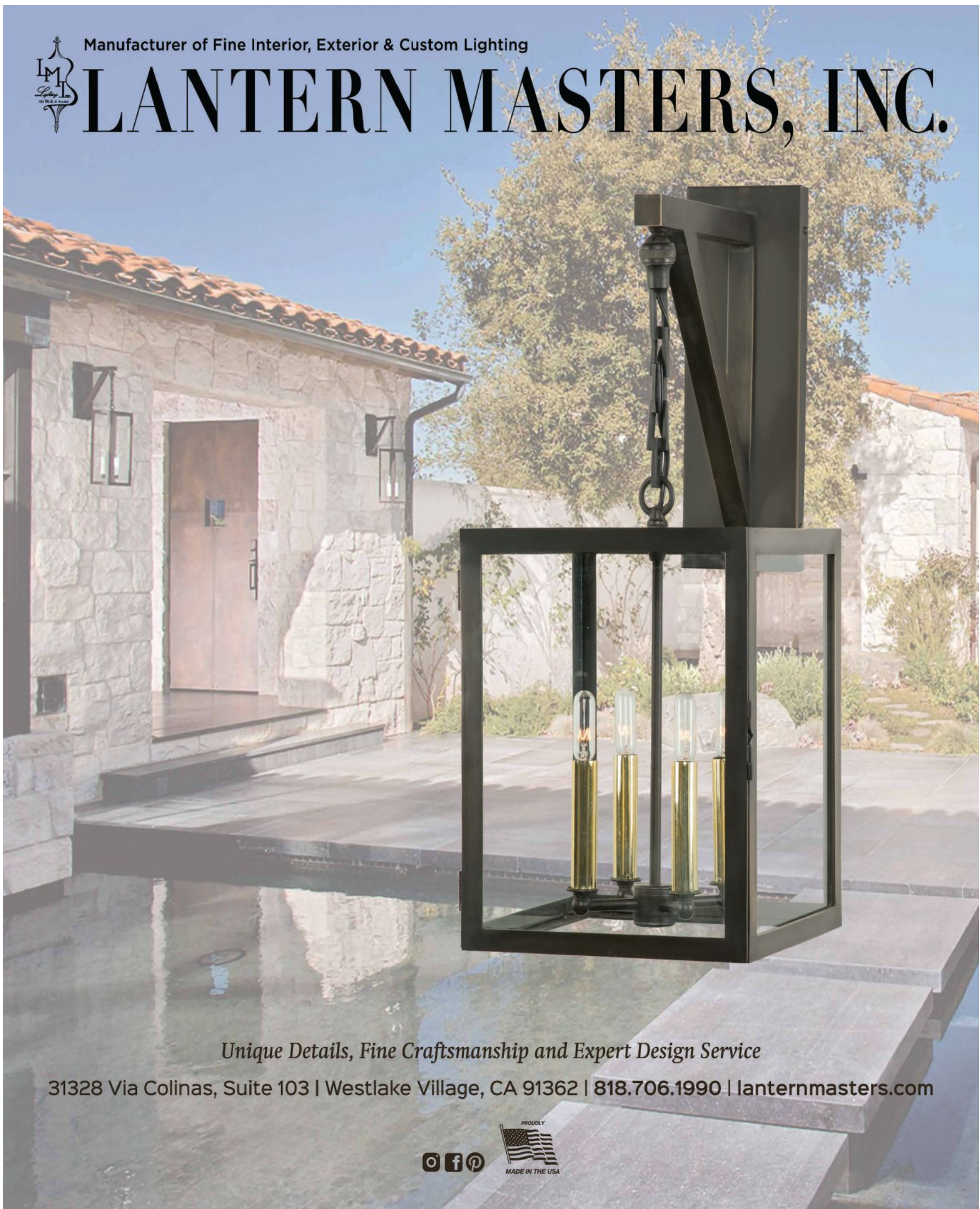

*Unique Details, Fine Craftsmanship and Expert Design Service*

31328 Via Colinas, Suite 103 | Westlake Village, CA 91362 | 818.706.1990 | [lanternmasters.com](http://lanternmasters.com)





# MASONRY RESTORATION, CLEANING & WATERPROOFING



**ABRASIVE SYSTEMS**  
800-288-7800; Fax: 717-540-6871  
[www.restorationdirect.com](http://www.restorationdirect.com)  
Harrisburg, PA 17112

Manufacturer of Cobra & Sidewinder sprayers to apply acid, cleaners, waterproofing & strippers; distributors of Diedrich, ABR & Dumond restoration & waterproofing chemicals.



**CONPROCO CORP.**  
800-258-3500; 603-743-5800;  
Fax: 603-743-5744  
[www.conproco.com](http://www.conproco.com)  
Dover, NH 03820

Manufacturer of MIMIC repair mortar for natural stone, terra cotta & cast stone; MIMIC Matrix all-natural stone-repair mortar for on-site color matching of stone; products to repair & restore concrete, masonry & stone.

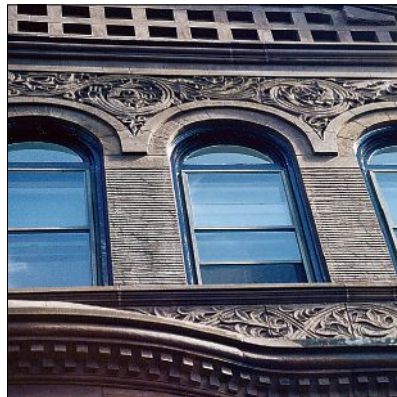

**EDISON COATINGS, INC.**  
860-747-2220; Fax: 860-747-2280  
[www.edisoncoatings.com](http://www.edisoncoatings.com)  
Plainville, CT 06062

Manufacturer of customized repair & repointing mortars, adhesives, breathable coatings & surface treatments: for stone, masonry & concrete; terra-cotta repair & glaze-replacement materials; custom matching; training services.



**FREEDOM CEMENT**  
(508) 867-6100  
[www.freedomcement.com](http://www.freedomcement.com)  
North Brookfield, MA 01535

Masonry products for historic preservation and new construction. Color matching; Match any texture. Microcotta™ is a non-structural replacement for traditional building materials.

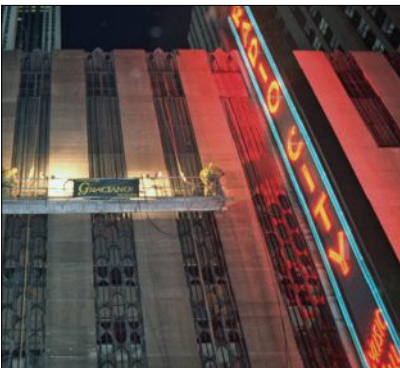

**GRACIANO CORP.**  
800-523-5076; 412-963-8400;  
Fax: 412-963-6662  
[www.graciano.com](http://www.graciano.com)  
Pittsburgh, PA 15238

Specialist in masonry concrete restoration & historic preservation: has restored Rockefeller Center, Queensboro Bridge, Shea Stadium. Services include: terra cotta, stone, tuck pointing, waterproofing, caulking & pressure grouting.



**OLD WORLD STONE LTD.**  
800-281-9615; 905-332-5547;  
Fax: 905-332-6068  
[www.oldworldstone.com](http://www.oldworldstone.com)  
Burlington, ON L7L 4Y1 Canada

Supplier of dimensional-cut limestone & sandstone: columns, sculpture, mantels, architectural ornament, signage & garden ornament for new & restoration projects.

SEE OUR AD ON PAGE 79.



**OLDE MOHAWK HISTORIC PRESERVATION**  
877-622-8973  
[www.OldeMohawk.com](http://www.OldeMohawk.com)  
Melrose, MA 02176

Provides historic preservation consulting and contracting services. Devises strategies for the adaptive re-use of historic structures. Does Brick and Stone Masonry Preservation and Cleaning, Slate, Clay Tile and Wood Shingle Roofing. Structural Repair of Foundations, Steel and Timber Framework, Much more.



**PRESERVATION PRODUCTS**  
800-553-0523; Fax: 610-891-0834  
[www.preservationproducts.com](http://www.preservationproducts.com)  
Media, PA 19063

Manufacturer & distributor of Acrymax restoration & preservation systems for historic metal roofs: durable weatherproof membrane can be used as complete roof system or for repair; Acrymax is an energy star partner.

SEE OUR AD ON PAGE 71.

**TROW & HOLDEN COMPANY**  
FINE STONEMAKING TOOLS

**Dry Stone Walling Set**

Split 'em, shape 'em and stack 'em with our new Dry Stone Walling Set — no mortar required!

Enhance your property for decades to come with a dry-stack stone wall built with quality Trow & Holden tools.

Set includes:

- a carbide-tipped Hammer Point, Hand Tracer and Rock Pick
- set of four walling pins and twine for a true line
- a guide, *Building and Repairing Dry Stone Fences*
- safety glasses and canvas tool bag

A great value at **\$339**

1-800-451-4349 • [www.trowandholden.com](http://www.trowandholden.com)

MADE TO LAST SINCE 1890 IN BARRE, VERMONT USA

**Weathercap®**  
Joint Protective System  
A permanent elastic seal for any masonry joint, horizontal or vertical.

We are honored to assist in the protection of our Supreme Court Building & National Cemetery

**WEATHERCAP**  
Weathercap®, Inc.  
[www.weathercap.net](http://www.weathercap.net)  
985-649-4000  
f: 985-847-1237

U.S. PATENT 6,991-400



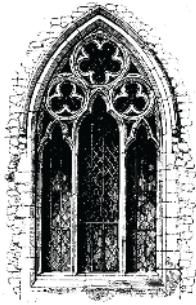

## OLD WORLD STONE LIMITED

*Fabricators of Dimensional Cut Stone*

[www.oldworldstone.com](http://www.oldworldstone.com)

Tel: 905-332-5547



*Tracery Windows for Packer Memorial Church, Lehigh University, Bethlehem, PA.*

Old World Stone is a custom fabricator of dimensional cut stone for new and restoration work. For over 30 years, we have supplied property owners, masonry contractors and design professionals. Our work with limestone, sandstone and marble is unparalleled. We utilize leading edge 3-D scanning and robotic milling to complement our skills as Old World craftsmen.

## Old World Craftsmanship ... New World Technology

WHEN CONTACTING COMPANIES  
YOU'VE SEEN IN THIS ISSUE,  
PLEASE TELL THEM YOU SAW THEM IN  
TRADITIONAL BUILDING  
MAGAZINE.

To see larger photos and  
informational captions, visit  
[traditionalbuilding.com/page/the-magazine](http://traditionalbuilding.com/page/the-magazine)  
Scroll down and click on the  
Buying Guides link



**PROTECTO WRAP COMPANY**  
303-777-3001; Fax: 303-777-9273  
[www.protectowrap.com](http://www.protectowrap.com)  
Denver, CO 80223  
Manufacturer of waterproofing systems: waterproofing membrane.



**RAINGUARD PRODUCTS**  
949-515-8800; Fax: 949-675-3450  
[www.rainguard.com](http://www.rainguard.com)  
Huntington Beach, CA 92646  
Manufacturer of clear water repellants, transparent masonry stain colors, graffiti remover & anti-graffiti coating; expert color matching; waterproofing consultations; since 1969.



**TROW & HOLDEN**  
800-451-4349; Fax: 802-476-7025  
[www.trowandholden.com](http://www.trowandholden.com)  
Barre, VT 05641  
Manufacturer of stone-carving tools: air & hand hammers; steel & carbide chisels for soft & hard stone; pneumatic mortar-removal kits for fine repointing work; stone-masonry & -splitting tools.  
**SEE OUR AD ON PAGE 78.**

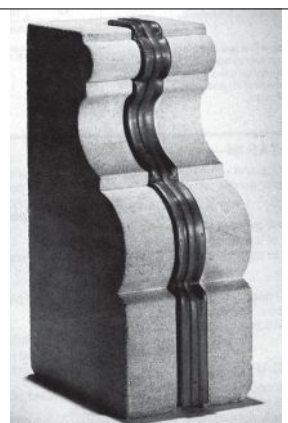

**WEATHERCAP, INC.**  
985-649-4000; Fax: 985-847-1237  
[www.weathercap.net](http://www.weathercap.net)  
Stidell, LA 70459  
Manufacturer of soft-lead strips: set & bedded in caulking compound/sealant; forms a cap to create a permanent elastic seal for any masonry joint.  
**SEE OUR AD ON PAGE 78.**





# What's the Rush?

**Resurrecting this iconic building should not be done in haste.**

**RIGHT OUT OF THE BOX,** France announced an international competition to determine whether and how to rebuild the roof and spire of Notre Dame, destroyed by fire on April 15. French President Emmanuel Macron wants the job done by 2024, in time for that year's Summer Olympic Games in Paris.

And why not? Athletes arriving to compete at the 850-year-old historic venue in the roof-jumping, spire-climbing, bell-ringing, tower-mounting, boulder-throwing, and pitch-pouring events must familiarize themselves with the dimensions of the rebuilt cathedral before competition in their respective events actually begins.

Seriously, why must repairs to a cathedral that took centuries to build during the Middle Ages be rushed to completion in just a handful of years?

According to 1,170 international architects, conservationists, and historians who signed a petition that ran in *Le Figero* on April 29, five years drastically underestimates the time required to do the job responsibly. Among other things, experts cited a need to train hundreds of additional stonecutters, carpenters, ironmongers, and roofers. Nevertheless, the Associated Press reported that "France's government presented a bill aimed at speeding up the reconstruction of Notre Dame that would allow workers to skip some ordinary renovation procedures."

Indeed, the language of the officials who announced the competition suggests ominous explanations for the rush job that seems to be in the works. The competition could be framed so as to seek, in the words of Macron's premier, "a spire suited to the techniques and challenges of our time." The president's promise to rebuild the cathedral "even more beautifully" could suggest a bias at the Élysée Palace for a modernist reconceptualization of the roof and spire, and against a historical replication of the work done in the mid-1800s by master restorer Eugene Viollet-le-Duc.

Leaving aside Macron's silly Olympic deadline, the chief rationale for such a short period might in fact be to grease the skids for a proposal that could shorten the timeline by substituting a quickie modernist clip-on, paint-by-numbers renovation

scheme for a time-consuming adult restoration.

British architect Norman Foster stepped quickly into the breach with a glass-and-steel proposal quite modest compared with other proposals. Foster told *The Guardian* that "the decision to hold a competition for the rebuilding of Notre Dame is to be applauded because it is an acknowledgment of that tradition of new interventions."

Hardly. Restoring an icon damaged by fire or natural disaster calls for an approach that leans toward retaining its historical character. A more liberal approach might, on the other hand, arise from the management of its safety systems, climate controls, code requirements, technological upgrades, or even design enhancements. Notre Dame epitomizes the former approach, which naturally invites, though it may not demand, the use of improved techniques in construction and safety, and even innovative approaches to replicating historical character, as Viollet-le-Duc recognized.

As described so far by the French authorities, the international competition is entirely consonant with this historical approach. Yes, their language can be interpreted, as shown above, to suggest a modernist approach. But the bulk of public opinion in France seems to support a traditional rebuild—perhaps because modernist architects have long demonstrated, in the additions they design for traditional buildings, that they are incapable of subverting their egos to the modesty required by respect for historical character.

Duncan Stroik, celebrated for his ecclesiastical designs, including work in the Gothic tradition, offers two reasons, in "Why Rebuild a Gothic 'Addition' to Notre Dame?" for *The American Conservative*, why modernists today should not be trusted to restore Notre Dame: "First, because Viollet's spire is a great work of architecture on a world heritage site, and secondly because most contemporary architects couldn't design Gothic to save their life."

That may be the understatement of the week. No need to rush. Do it right.



E. R. BUTLER & CO.



*Thumb Turn & Rose*



*Emergency Trim Ring  
with Swinging Cover*



*Shutter Knob*

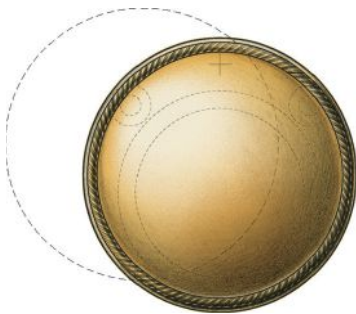

*Cylinder Ring  
with Swinging Cover*



*Cylindrical Floor Stop  
with Trim Ring*



•  
B  
•

E. R. BUTLER & CO.

*“NK” Design Series  
W.C. Vaughan Co. Collection*

Door Knobs Available in 2 3/4, 2 1/2, 2 1/4, 2, and 1 3/4 inch Diameters (2 3/4 in. Shown).  
Available in 3 inch Diameters for Use as Center Knobs.  
Also Available in 1 1/2, 1 1/4, 1, and 3/4 inch Diameters for Cabinets and Fine Furniture.  
Solid Turned Brass Knob and Rose.  
Standard, Custom Plated and Patinated Finishes Available.

WWW.ERBUTLER.COM

CATALOGUES AVAILABLE TO THE TRADE · SHOWROOMS BY APPOINTMENT ONLY

3/4 Scale

FINE ARCHITECTURAL, BUILDERS' AND CABINETMAKERS' HARDWARE

© E. R. BUTLER & CO. ALL RIGHTS RESERVED. TECHNICAL DRAWING: JOHN SYKES FETTERMAN RENDERING: MARGITTA ZACHERT TYPOGRAPHY: JOHN PACKER





— CHOOSE VINTAGE DOORS —

Author Bryant H. McGill once said, "The loss of craftsmanship has turned America into a sweeping, franchised wasteland of disposable goods." At Vintage Doors, we couldn't agree more. That's why our craftsmen take great pride in hand-crafting **real wood doors of heirloom quality**, just like the olden days. The kind people actually notice and respect—to be valued *for generations*. With an industry history celebrating three decades, discerning homeowners and trade professionals across the country rely on *Vintage Doors* to provide the best, time-honored door solutions available. Whether you're an architect, designer, contractor, historian or homeowner, we believe buying quality doors should be an enjoyable experience. That's why your project receives individual attention to detail and is specialty made to meet exact specifications. To see *and feel* the difference a custom door can make for your next project, contact us today.

"Extra-Ordinary" designs, craftsmanship, size capabilities, lead times and personal service—Guaranteed!

SHOP NOW

GO ONLINE NOW | Request a Quote » CONTACT US | Call for a Catalog »

www.VintageDoors.com 1 (800) 787-2001

